

# ARCHITECTURAL RECORD

AIA Gold Medalist 2009  
GLENN MURCUTT

Touching the  
Earth Lightly

**SPECIAL REPORT**  
African-Americans  
in Architecture:  
Breakthroughs  
and Obstacles

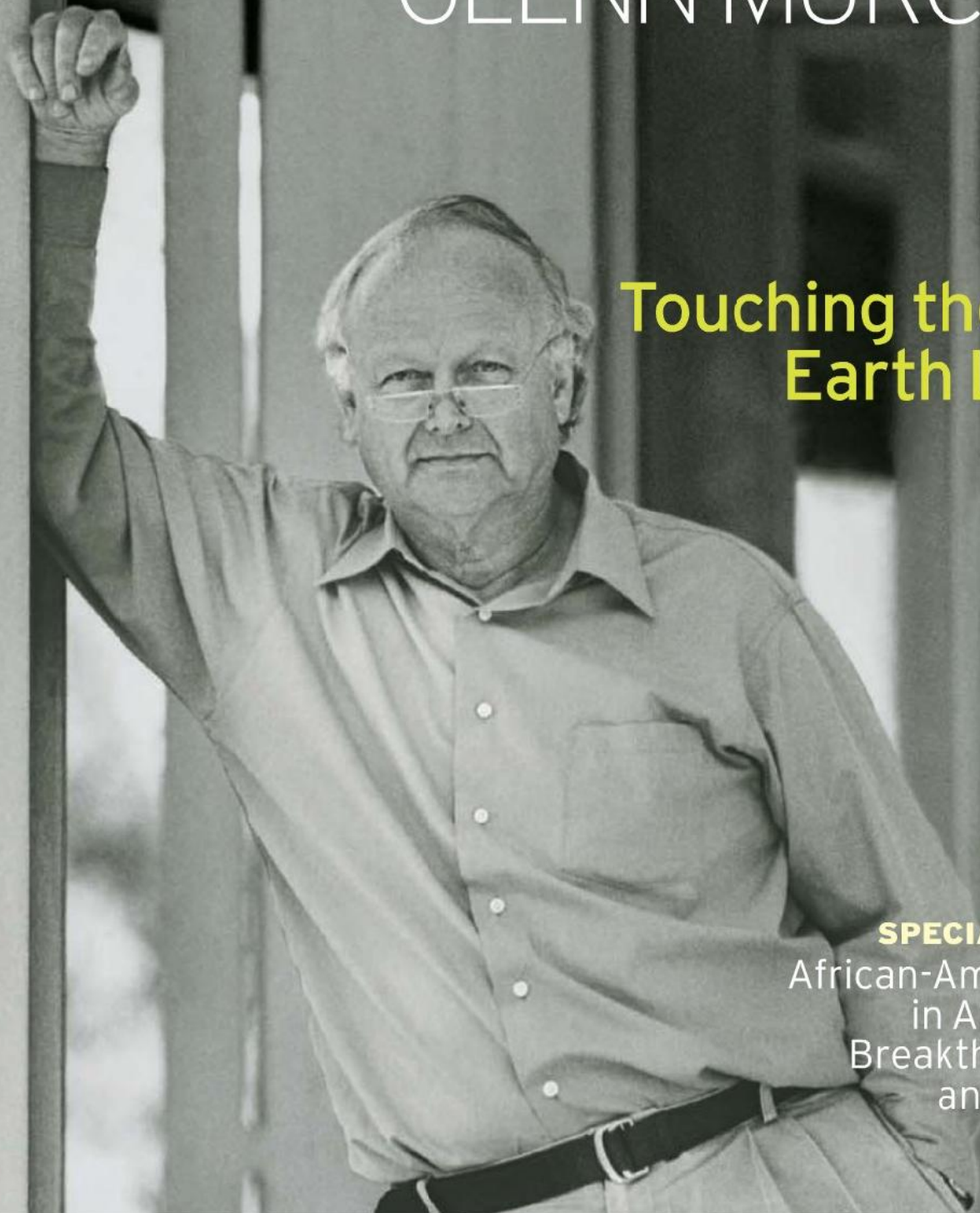

McGraw Hill  
CONSTRUCTION

05  
2009

\$9.95 A PUBLICATION OF THE MCGRAW-HILL COMPANIES  
www.architecturalrecord.com



# CEILING&WALL SYSTEMS

Between us, ideas become reality®

**Recycled Content: 92%**

## LEED® Credits

- Energy
- Waste Management
- ✓ Recycled Content
- ✓ Local Materials
- ✓ Renewable Materials
- ✓ Certified Wood

## LEED for Schools

- Acoustics
- ✓ Low-Emitting or CHPS

# a very green production.

No other wood ceiling delivers environmental performance like FSC-certified WoodWorks® Ceiling Systems. Our no-added formaldehyde, Class A fire rating and 92% pre-consumer recycled content are masterfully balanced with an elegant wood veneer. The result is sure to win over any audience. Visit our site to learn more – and look forward to rave reviews.

[armstrong.com/woodworks](http://armstrong.com/woodworks) 1-877-ARMSTRONG

CIRCLE 01

Architectural Firm: Clarke Caton Hintz, Trenton, NJ



**Armstrong®**

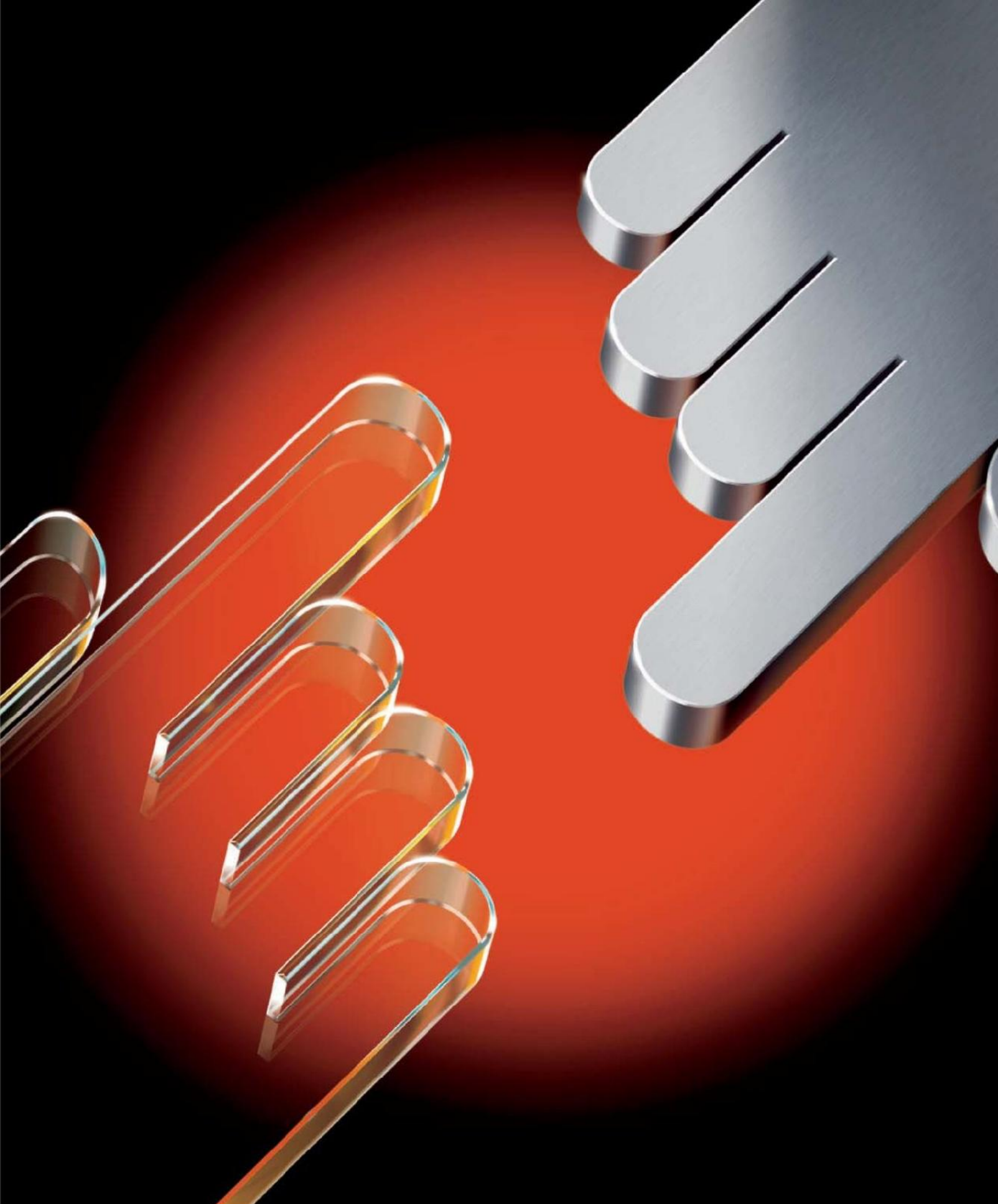

# announcing the end of finger-pointing

**Tired of being caught between the Glass fabricator and the Skylight supplier or the Window and Curtain Wall manufacturer? Who's in charge? Now we are.** We've assembled the most comprehensive collection of best-in-class curtain wall, architectural windows, entrances and storefronts, skylights and architectural glass manufacturers and engineering minds in North America—all with one goal. Close the building envelope better and faster. If managing disputes between building envelope suppliers is something you could do without—give us a call. **Simplify your life with Oldcastle Glass.** To learn more, call us at 1-866-OLDCASTLE (653-2278) or visit us at [oldcastleglass.com](http://oldcastleglass.com). **See us at the AIA Convention, booth #727.**



U.S. Federal Courthouse, Miami  
Architect: Arquitectonica  
Custom-engineered Curtain Wall  
by Oldcastle Glass®



**Oldcastle Glass®**

*Pushing the building envelope™*

 curtain wall  entrances/storefronts  windows  skylights  glass

Achieve a sterling reputation with stainless steel.



Precision railing systems and contemporary door pull designs, coordinated to complement your next project.

# ARCHITECTURAL RECORD

**VP, EDITORIAL DIRECTOR, EDITOR IN CHIEF**  
**MANAGING EDITOR**  
**SENIOR GROUP ART DIRECTOR**

Robert Ivy, FAIA, [rivy@mcgraw-hill.com](mailto:rivy@mcgraw-hill.com)  
Beth Broome, [elizabeth\\_broome@mcgraw-hill.com](mailto:elizabeth_broome@mcgraw-hill.com)  
Francesca Messina, [francesca\\_messina@mcgraw-hill.com](mailto:francesca_messina@mcgraw-hill.com)

**DEPUTY EDITORS**

Clifford A. Pearson, [pearsonc@mcgraw-hill.com](mailto:pearsonc@mcgraw-hill.com)  
Suzanne Stephens, [suzanne\\_stephens@mcgraw-hill.com](mailto:suzanne_stephens@mcgraw-hill.com)  
Charles Linn, FAIA, Profession and Industry, [linnc@mcgraw-hill.com](mailto:linnc@mcgraw-hill.com)

**SENIOR EDITORS**

Jane F. Kolleeny, [jane\\_kolleeny@mcgraw-hill.com](mailto:jane_kolleeny@mcgraw-hill.com)  
Joann Gonchar, AIA, [joann\\_gonchar@mcgraw-hill.com](mailto:joann_gonchar@mcgraw-hill.com)  
Josephine Minutillo, [josephine\\_minutillo@mcgraw-hill.com](mailto:josephine_minutillo@mcgraw-hill.com)

**PRODUCTS EDITOR**

Rita Catinella Orrell, [rita\\_catinella@mcgraw-hill.com](mailto:rita_catinella@mcgraw-hill.com)

**NEWS EDITOR**

Jenna M. McKnight, [jenna\\_mcknight@mcgraw-hill.com](mailto:jenna_mcknight@mcgraw-hill.com)

**SPECIAL SECTIONS EDITOR**

Linda C. Lentz, [linda\\_lentz@mcgraw-hill.com](mailto:linda_lentz@mcgraw-hill.com)

**PRODUCTION MANAGER**

Juan Ramos, [juan\\_ramos@mcgraw-hill.com](mailto:juan_ramos@mcgraw-hill.com)

**COPY EDITOR**

Leslie Yudell, [leslie\\_yudell@mcgraw-hill.com](mailto:leslie_yudell@mcgraw-hill.com)

**ART DIRECTOR**

Kristofer E. Rabasca, [kris\\_rabasca@mcgraw-hill.com](mailto:kris_rabasca@mcgraw-hill.com)

**ASSOCIATE ART DIRECTOR**

Encarnita Rivera, [encarnita\\_rivera@mcgraw-hill.com](mailto:encarnita_rivera@mcgraw-hill.com)

**EDITORIAL SUPPORT**

Linda Ransey, [linda\\_ransey@mcgraw-hill.com](mailto:linda_ransey@mcgraw-hill.com)  
Monique Francis, [monique\\_francis@mcgraw-hill.com](mailto:monique_francis@mcgraw-hill.com)

**EDITORIAL ASSISTANTS**

Sebastian Howard, [sebastian\\_howard@mcgraw-hill.com](mailto:sebastian_howard@mcgraw-hill.com)  
Aleksandr Bierig, [aleksandr\\_bierig@mcgraw-hill.com](mailto:aleksandr_bierig@mcgraw-hill.com)

**CONTRIBUTING EDITORS**

Sarah Amelar, Robert Campbell, FAIA, Andrea Oppenheimer Dean, David Dillon, Lisa Findley, Sara Hart, Blair Kamin, Nancy Levinson, Jayne Merkel, Robert Murray, B.J. Novitski, Andrew Pressman, FAIA, David Sokol, Michael Sorkin, Michael Speaks, Ingrid Spencer

**SPECIAL INTERNATIONAL CORRESPONDENT**  
**INTERNATIONAL CORRESPONDENTS**

Naomi R. Pollock, AIA  
David Cohn, Claire Downey, Tracy Metz

**EDITORIAL DIRECTOR, DIGITAL MEDIA**

Bryant Rousseau, [bryant\\_rousseau@mcgraw-hill.com](mailto:bryant_rousseau@mcgraw-hill.com)

**WEB EDITOR**

William Hanley, [william\\_hanley@mcgraw-hill.com](mailto:william_hanley@mcgraw-hill.com)

**WEB DESIGN DIRECTOR**

Susannah Shepherd, [susannah\\_shepherd@mcgraw-hill.com](mailto:susannah_shepherd@mcgraw-hill.com)

**WEB PRODUCTION**

Laurie Meisel, [laurie\\_meisel@mcgraw-hill.com](mailto:laurie_meisel@mcgraw-hill.com)

**ARCHITECTURAL RECORD:** (ISSN 0003-858X) May 2009, Vol. 197, No. 5. Published monthly by The McGraw-Hill Companies, 1221 Avenue of the Americas, New York, N.Y. 10020. **FOUNDER:** James H. McGraw (1860-1948). Periodicals postage paid at New York, N.Y. and additional mailing offices. Canada Post International Publications Mail Product Sales Agreement No. 40012501. Return undeliverable Canadian addresses to: DPGM Ltd., 2-7496 Bath Road, Mississauga, ON L4T 1L2. Email: [arbcustserv@cdsfulfillment.com](mailto:arbcustserv@cdsfulfillment.com). Registered for GST as The McGraw-Hill Companies. GST No. R123075673. **POSTMASTER:** Please send address changes to ARCHITECTURAL RECORD, Fulfillment Manager, P.O. Box 5732, Harlan, IA 51593. **SUBSCRIPTION:** Rates are as follows: U.S. and Possessions \$70.30; Canada and Mexico \$79 (payment in U.S. currency, GST included); outside North America \$199 (air freight delivery). Single copy price \$9.95; for foreign \$11. Subscriber Services: 877/876-8093 (U.S. only); 515/237-3681 (outside the U.S.); fax: 712/755-7423. **SUBMISSIONS:** Every effort will be made to return material submitted for possible publication (if accompanied by stamped, self-addressed envelope), but the editors and the corporation will not be responsible for loss or damage. **SUBSCRIPTION LIST USAGE:** Advertisers may use our list to mail information to readers. To be excluded from such mailings, send a request to architectural record, Mailing List Manager, P.O. Box 555, Hightstown, N.J. 08520. **OFFICERS OF THE MCGRAW-HILL COMPANIES, INC.:** Harold W. McGraw III, Chairman, President and Chief Executive Officer; Kenneth M. Vittor, Executive Vice President and General Counsel; Robert J. Bahash, Executive Vice President and Chief Financial Officer; Elizabeth O'Melia, Senior Vice President, Treasury Operations. **COPYRIGHT AND REPRINTING:** Title ® reg. in U.S. Patent Office. Copyright © 2009 by The McGraw-Hill Companies. All rights reserved. Where necessary, permission is granted by the copyright owner for libraries and others registered with the Copyright Clearance Center (CCC), 222 Rosewood Drive, Danvers, Mass. 01923. To photocopy any article herein for personal or internal reference use only for the base fee of \$1.80 per copy of the article plus ten cents per page, send payment to CCC, ISSN 0003-858X. Copying for other than personal use or internal reference is prohibited without prior written permission. Write or fax requests (no telephone requests) to Copyright Permission Desk, architectural record, Two Penn Plaza, New York, N.Y. 10121-2298; fax 212/904-4256. For reprints call 800/360-5549 X 129 or e-mail [architecturalrecord@theygsgroup.com](mailto:architecturalrecord@theygsgroup.com). Information has been obtained by The McGraw-Hill Companies from sources believed to be reliable. However, because of the possibility of human or mechanical error by our sources, The McGraw-Hill Companies or architectural record does not guarantee the accuracy, adequacy, or completeness of any information and is not responsible for any errors or omissions therein or for the results to be obtained from the use of such information or for any damages resulting there from.

**EDITORIAL OFFICES:** 212/904-2594. Editorial fax: 212/904-4256. Email: [rivy@mcgraw-hill.com](mailto:rivy@mcgraw-hill.com). Two Penn Plaza, New York, N.Y. 10121-2298. **WEB SITE:** [ArchitecturalRecord.com](http://ArchitecturalRecord.com).



The McGraw-Hill Companies

# HELPING YOU SEE THE LIGHT.

## Pilkington Profilit™

By leveraging the idea of daylighting - using natural light to illuminate a space and reducing dependence on artificial lighting - you can build green without sacrificing beauty or creativity. Pilkington Profilit™, a translucent channel glass system from Technical Glass Products, helps create stunning structures while enabling architects to embrace the advantages of daylighting. Pilkington Profilit is available with insulating options that result in heating and cooling efficiencies. So when you're thinking green, think about how we can help you bring those ideas to light.

BIM 3D Modeling now available at [tgpamerica.com](http://tgpamerica.com)

[[tgpamerica.com](http://tgpamerica.com)]

800.426.0279

© 2009 Technical Glass Products. Pilkington Profilit is a trademark of Pilkington plc. Technical Glass Products, One Source, Many Solutions and TGP America are registered trademarks of Technical Glass Products.



Visit [tgpamerica.com](http://tgpamerica.com) to take our AIA registered Daylighting course online.

CIRCLE 04

**TGP** ARCHITECTURAL  
one source. many solutions.®



Introducing

Paladin™

designed by Hick Reeder, AIA



landscapeforms®  
800.430.6208 • landscapeforms.com

# ARCHITECTURAL RECORD

## PRESIDENT, MCGRAW-HILL CONSTRUCTION

Norbert W. Young, Jr., FAIA

## VICE PRESIDENT, GROUP PUBLISHER

James H. McGraw, IV, [jay\\_mcgraw@mcgraw-hill.com](mailto:jay_mcgraw@mcgraw-hill.com)

## VICE PRESIDENT, PUBLISHER

Laura Viscusi, [laura\\_viscusi@mcgraw-hill.com](mailto:laura_viscusi@mcgraw-hill.com)

## VICE PRESIDENT, MEDIA SALES

Paul Bonington, [paul\\_bonington@mcgraw-hill.com](mailto:paul_bonington@mcgraw-hill.com)

## VICE PRESIDENT, INDUSTRY ANALYTICS & ALLIANCES

Harvey M. Bernstein, F.ASCE, [harvey\\_bernstein@mcgraw-hill.com](mailto:harvey_bernstein@mcgraw-hill.com)

## VICE PRESIDENT, MARKETING & PRODUCT DEVELOPMENT

Potoula Chresomales, [potoula\\_chresomales@mcgraw-hill.com](mailto:potoula_chresomales@mcgraw-hill.com)

## SENIOR DIRECTOR, MARKETING COMMUNICATIONS

Katherine Malangone, [kathy\\_malangone@mcgraw-hill.com](mailto:kathy_malangone@mcgraw-hill.com)

## DIRECTOR, MARKETING COMMUNICATIONS

Deborah Smikle-Davis, [deborah\\_smikle-davis@mcgraw-hill.com](mailto:deborah_smikle-davis@mcgraw-hill.com)

## VICE PRESIDENT, BUSINESS SERVICES

Maurice Persiani, [maurice\\_persiani@mcgraw-hill.com](mailto:maurice_persiani@mcgraw-hill.com)

## DIRECTOR, CIRCULATION

Brian McGann, [brian\\_mcgann@mcgraw-hill.com](mailto:brian_mcgann@mcgraw-hill.com)

## VICE PRESIDENT, BUSINESS OPERATIONS

Timothy J. Ryan, [tim\\_ryan@mcgraw-hill.com](mailto:tim_ryan@mcgraw-hill.com)

## PRODUCTION MANAGER

Stephen R. Weiss, [stephen\\_weiss@mcgraw-hill.com](mailto:stephen_weiss@mcgraw-hill.com)

## SENIOR DIRECTOR, FINANCE

John Murphy, [john\\_murphy@mcgraw-hill.com](mailto:john_murphy@mcgraw-hill.com)

## FINANCE DIRECTOR

Ike Chong, [ike\\_chong@mcgraw-hill.com](mailto:ike_chong@mcgraw-hill.com)

## ADVERTISING SALES

### BUILDING PRODUCTS

**NORTHEAST:** Joseph Sosnowski (610) 278-7829 Fax%(610) 278-0936, [joseph\\_sosnowski@mcgraw-hill.com](mailto:joseph_sosnowski@mcgraw-hill.com)

**SOUTHEAST:** Susan Shepherd (859) 987-9913 Fax%(404) 252-4056, [susan\\_shepherd@mcgraw-hill.com](mailto:susan_shepherd@mcgraw-hill.com)

**MIDWEST:** Martin McClellan (312) 233-7402 Fax%(312) 233-7430, [martin\\_mcclellan@mcgraw-hill.com](mailto:martin_mcclellan@mcgraw-hill.com)

**SOUTHWEST/CENTRAL:** Bret Ronk (972) 437-7877 Fax%(972) 437-7876, [bret\\_ronk@mcgraw-hill.com](mailto:bret_ronk@mcgraw-hill.com)

**NORTHWEST:** Bill Madden (503) 557-9000 Fax%(503) 557-9002, [bill\\_madden@mcgraw-hill.com](mailto:bill_madden@mcgraw-hill.com)

**PACIFIC:** Sherylen Yoak (760) 568-0465 Fax%(720) 559-9818, [sherylen\\_yoak@mcgraw-hill.com](mailto:sherylen_yoak@mcgraw-hill.com)

**ASSOCIATIONS:** Charles Fagan (212) 904-2547 Fax%(312) 233-7488, [charles\\_fagan@mcgraw-hill.com](mailto:charles_fagan@mcgraw-hill.com)

**TECHNOLOGY:** Roy Kops (415) 357-8191 Fax%(415) 357-8005, [roy\\_kops@mcgraw-hill.com](mailto:roy_kops@mcgraw-hill.com)

**WORKFORCE/ RECRUITMENT:** Brian Monteleone (609) 426-5283 Fax%(212) 904-2074, [brian\\_monteleone@mcgraw-hill.com](mailto:brian_monteleone@mcgraw-hill.com),  
Diane Soister (212) 904-2021 Fax%(212) 904-2074, [diane\\_soister@mcgraw-hill.com](mailto:diane_soister@mcgraw-hill.com)

**PRODUCT NEWS SPOTLIGHT:** Elise Rutkowsky (609) 426-7738 Fax%(609) 426-7136, [elsie\\_rutkowsky@mcgraw-hill.com](mailto:elsie_rutkowsky@mcgraw-hill.com),  
Kameesha Saunders (609) 426-7703 Fax%(609) 426-7136, [kameesha\\_saunders@mcgraw-hill.com](mailto:kameesha_saunders@mcgraw-hill.com),  
Evan Lauro (609) 426-7024 Fax%(609) 426-7738, [evan\\_lauro@mcgraw-hill.com](mailto:evan_lauro@mcgraw-hill.com)

### INTERNATIONAL

**GERMANY:** Martin Druke (49) 202-27169-12 Fax%(49) 202-27169-20, [druke@intermediapartners.com](mailto:druke@intermediapartners.com)

**ITALY:** Ferruccio Silvera (39) 022-846716 Fax%(39) 022-893849, [ferruccio@silvera.it](mailto:ferruccio@silvera.it)

**JAPAN:** Katsuhiro Ishii (03) 5691-3335 Fax%(03) 5691-3336, [amkatsu@dream.com](mailto:amkatsu@dream.com)

**KOREA:** Young-Seoh Chin (822) 481-3411/3 Fax%(822) 481-3414

**WEB SITE:** ArchitecturalRecord.com. **ADVERTISING:** Pina Del Genio%212/904-6791, [AR.advertising@mcgraw-hill.com](mailto:AR.advertising@mcgraw-hill.com). **SUBSCRIBER SERVICE:** 877/876-8093 (U.S. only) 515/237-3681 (outside the U.S.). Subscriber fax%12/755-7423. E-mail%[arhcustserv@cdsfulfillment.com](mailto:arhcustserv@cdsfulfillment.com). If the Post Office alerts us that your magazine is undeliverable, we have no further obligation unless we receive a corrected address within one year. AIA members must contact the AIA for address changes on their subscriptions. 800/242-3837. E-mail%[memberservices@aia.org](mailto:memberservices@aia.org). **INQUIRIES AND SUBMISSIONS:** Letters, Robert Ivy; Practice, Charles Linn; Books, Clifford Pearson; Products, Rita Catinella Orrell; Lighting and Interiors, Linda C. Lentz; Residential, Jane F. Kolleeny; Architectural Technology, Joann Gonchar, Josephine Minutillo; Web Editorial, Bryant Rousseau. **REPRINT:** [architecturalrecord@theygsgroup.com](http://architecturalrecord@theygsgroup.com). **BACK ISSUES:** Call 877/876-8093, or go to [archrecord.com/backissues/](http://archrecord.com/backissues/)

**THE AMERICAN INSTITUTE OF ARCHITECTS 2009 BOARD OF DIRECTORS • OFFICERS:** Marvin J. Malcha, FAIA, President; George H. Miller, FAIA, First Vice President; Peter Arsenaull, AIA, LEED AP, Vice President; Walter J. Hainsfurther, AIA, Vice President; Pamela J. Loeffelman, FAIA, Vice President; Clark Manus, FAIA, Vice President; Stephen K. Loos, AIA, Secretary; Hal P. Mungler, FAIA, Treasurer; Ana Guerra, Assoc. AIA, Associate Representative to the Executive Committee; Frederic M. Bell, FAIA, CACE Representative to the Executive Committee; Christine McIntee, Executive Vice President/CEO. • **DIRECTORS:** Dennis A. Andrejko, AIA; William Babcock, Hon. AIA; Donald Barsness AIA; Douglas A. Benson, AIA; JW Blanchard, Assoc. AIA; Stacy Bourne, AIA; Thomas B. Braham, AIA; Donald C. Brown, AIA; Frederick F. Butters, Esq., FAIA; Kevin J. Connolly, AIA; D. Graham Davidson, FAIA; Russell Davidson, AIA; David Del Vecchio, AIA; James Determan Jr., AIA; Richard DeYoung, AIA; Gabriel Durand-Hollis, FAIA; Erica Rioux Gees, AIA; Jeffrey T. Gill, AIA; Mickey Jacob, AIA; Leonard E. Koroski, AIA; Debra Kunce, AIA, LEED AP; Peter G. Kattner, FAIA; Anne Leird-Blanton, AIA; Ralph Lerner, FAIA; Richard D. Licata, AIA; Meggan Lux, AIA; Paul Mankins, FAIA; R. Kent Mather, AIA; Terrence E. O'Neal, AIA; Patrick T. Onishi, AIA; John A. Padilla, AIA; Jeffery Potter, AIA; Trula Remson, AIA; John W. Rogers, AIA, ACHA; John W. Rogers, AIA, ACHA; Dru Schmidt-Perkins; William J. Stanley III, FAIA; David A. Thurm, Esq.; Pamela M. Tuschner, FAIA; Edward W. Tucker, AIA; Edward J. Vidlak, AIA; Edward T. Zeigler Jr., AIA. • **AIA EXECUTIVE TEAM:** Christine W. McEntee, Executive Vice President/CEO; Beth Bush, Vice President, Member Value and Communications; Tracy Harris, Vice President, Administration and Chief Financial Officer; Michael P. Hoagland, SPHR, CAE, Vice President, Human Resources; Paul T. Mendelsohn, Vice President, Government and Community Relations; Kevin Novak, Vice President, Integrated Web Strategy and Technology; Barbara J. Sido, CAE, Vice President, Knowledge & Professional Practice; Jay A. Stephens, Esq., General Counsel & Vice President; Elizabeth Stewart, Esq., Vice President, Strategy & Business Development. • **AIA MANAGEMENT COUNCIL:** Karen Davis, Senior Director, Strategic Planning; David Downey, CAL, IOM, Assoc. AIA, Managing Director, Corporate Relations and Development; Helene Combs Dreifling, FAIA, Hon. SDA, Managing Director, Component Relations; James Gatsch, FAIA, Managing Director, 21st Century Workplace; Andrew Goldberg, Assoc. AIA, Senior Director, Federal Relations; Lisa Green, Managing Director, Finance and Accounting; Christopher Gribbs, Assoc. AIA, Managing Director, Convention; Maan Hashem, PMP, CAE, Managing Director, Software Products and Services; Christine M. Klein, CMP, Managing Director, Meetings; Molly Lindblom, Managing Director, Contract Documents; Philip O'Neal, Managing Director, Information Technology; Jeffrey Raymond, Managing Director, Web & Technology Governance & Partnerships; Cedric Rush, Managing Director, Membership Strategy and Services; Phil Simon, Managing Director, Communications and Marketing; Brian Skapura, Managing Director, Web Management; Terri Stewart, CAE, Managing Director, Member Communities; Suzanna J. Wight, AIA, Managing Director, Organizational Strategy & Alliances.

McGraw Hill  
CONSTRUCTION



M P A



The McGraw-Hill Companies

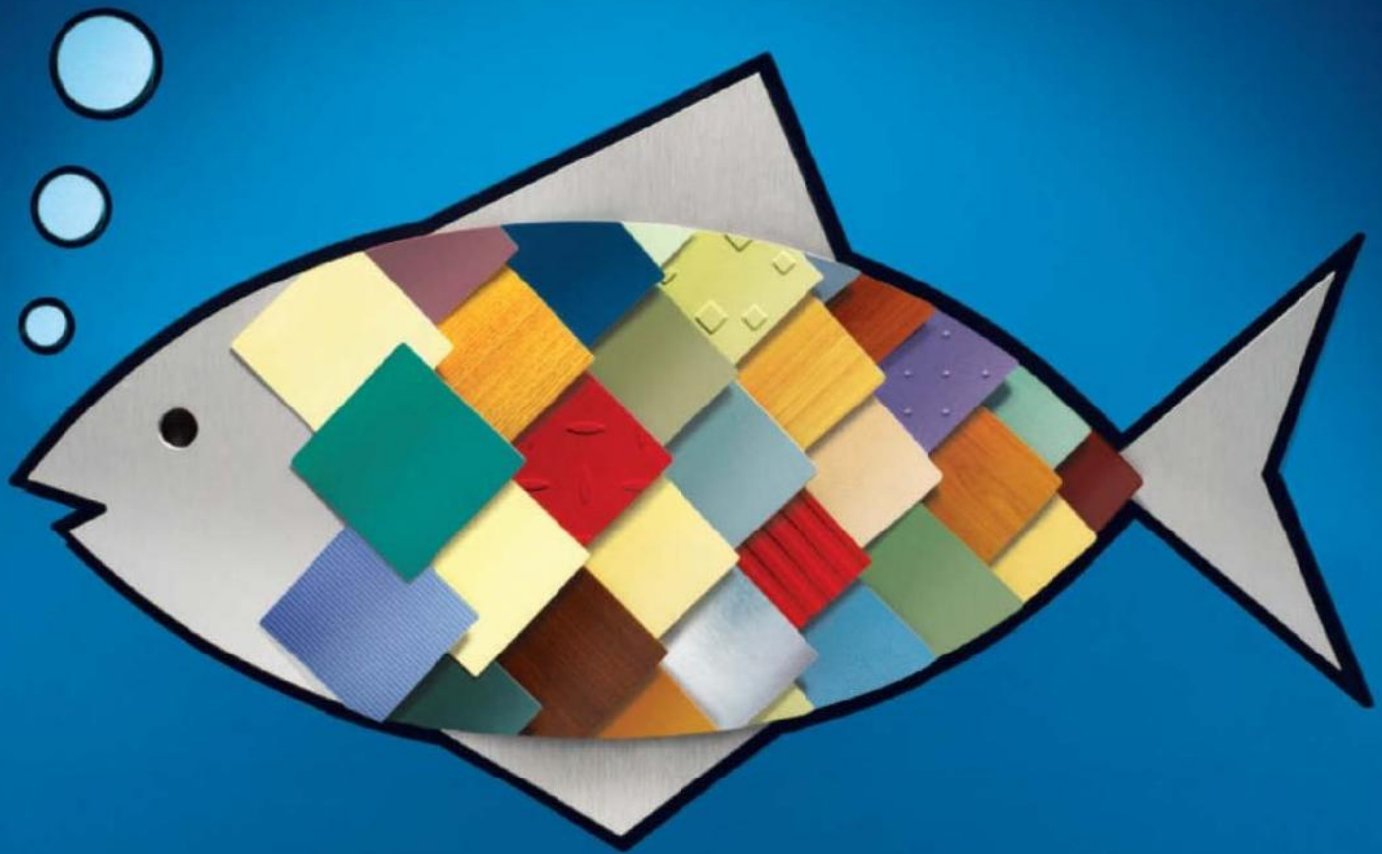

## Explore oceans of possibilities with Acrovyn® Wall Covering and Panels.



Acrovyn® is designed to protect walls. It has a 40-year track record of standing up to abuse all over the world. But if you think that's all Acrovyn is about, think again. Architects and designers are specifying Acrovyn Wall Covering and Panels because they are practical—and beautiful. Wall protection is no longer only being used in high-abuse areas and institutional settings. Rediscover Acrovyn. For a free brochure, call 1-888-621-3344 or visit [www.c-sgroup.com](http://www.c-sgroup.com).

 **Construction Specialties™**

**SEE US AT AIA**  
Booth 1117

# APA

6710 Winkler Rd, Ste 8 ♣ Ft. Myers, FL 33919

Tel: 239.454.6989 ♣ Fax: 239.454.6787

Email: info@archprecast.org ♣ www.archprecast.org

## Architectural Precast Association

The 2009 APA Awards For Design And Manufacturing Excellence is a national awards program that is sponsored by the Architectural Precast Association. Each year a jury of your peers selects the best designs utilizing architectural precast concrete. Finished structures must display a highly animated use of precast, which gives life and vitality to the building surface. Other considerations include a good control of medium, consistent color and texture control, and a design that exploits the potential of an architectural precast system.

### **JURY MEMBERS**

VOA Associates, Inc.  
Orlando, FL

### **JURY CHAIRMAN**

Ted G. Fery, AIA, CSI

### **JUROR**

Carl Shea, AIA

### **JUROR**

John W. Page, AIA, LEED AP

CIRCLE 07



## *Awards for Design*



## **MEDICAL/GOVERNMENT**

---

**FDIC HEADQUARTERS**  
Arlington, VA

**DESIGN**  
Perkin & Will  
Washington, DC

**MANUFACTURING**  
Arban & Carosi, Inc.  
Woodbridge, VA

**LOYOLA RESIDENCE PROJECT**  
Chicago, IL

**DESIGN**  
Temple Architects  
St. Charles, IL

**MANUFACTURING**  
Architectural Cast Stone, Inc.  
West Chicago, IL

## **EDUCATIONAL**

---



## **GFRC**

---

**THE RITZ-CARLTON**  
San Francisco, CA

**DESIGN**  
Charles Bloszies Architects  
San Francisco, CA

**MANUFACTURING**  
Architectural Facades Unlimited  
Gilroy, CA

**RIVERWAY HIGH-RISE**  
Houston, TX

**DESIGN**  
Gromatzky Dupree  
Dallas, TX

**MANUFACTURING**  
Redondo Manufacturing  
San Antonio, TX

## **MULTI-FAMILY RESIDENTIAL**

---



# *& Manufacturing Excellence*

## **SINGLE-FAMILY RESIDENTIAL**

---

**14500 GAILLARDIA LANE**  
Oklahoma City, OK

**DESIGN**  
Covert & Associates  
Dallas, TX

**MANUFACTURING**  
Structural Stone  
Oklahoma City, OK

**REPUBLIC SQUARE**  
Washington, DC

**DESIGN**  
Leo A Daly  
Washington, DC

**MANUFACTURING**  
Arban & Carosi, Inc.  
Woodbridge, VA

## **COMMERCIAL**

---



The right glass can do wonders for indoor environments.



Project credits at [ppgideasces.com/SB70XL](http://ppgideasces.com/SB70XL)



Cut cooling costs, equipment costs, and carbon emissions with Solarban Low-E glass.



And the outdoor one.

With over a billion square feet of Solarban sold, impossible-sounding LSG ratios may no longer impress you. But the results you'll find with our online energy analysis tool certainly will. For instance, with our leading Solarban glass, your next project could save \$400,000 in up-front equipment costs and reduce carbon emissions by 21,000 tons annually. Find out more at [ppgideascpes.com/SB70XL](http://ppgideascpes.com/SB70XL).



  
*Ideascpes*<sup>™</sup>  
Glass • Coatings • Paint

*With CITY MULTI® systems an atmosphere of creativity flows freely.*

Now there are building comfort solutions that will inspire your imagination instead of limiting it.

CITY MULTI gives you ultimate design flexibility so you can push the building envelope, with options for maximizing interior space and ceiling heights without concerns of concealing bulky ductwork.

Get unparalleled comfort, control and cost effective use of energy. All with great sustainability.

CITY MULTI will transform the way you think about HVAC. Energize yourself at [transforminghvac.com](http://transforminghvac.com)

 **MITSUBISHI ELECTRIC**  
HVAC for HUMANS





**CITY MULTI®**

The transformation has begun.™ 



# The True Leader



© 1996 Forest Stewardship Council A.C.

Manufacturing the finest suspended wood ceilings, acoustical wood wall systems, suspended upvc ceiling and canopy systems

1-800-227-8566

**Yale School of Forestry  
and Environmental Studies/Kroon Hall**  
**LEED Certified Platinum**  
**Best of Category Winner**  
**2008 CISCA Construction Excellence Award**  
**Rulon Product: Aluratone acoustical wood wall  
and ceiling systems.**

Project Statistics:

- FSC certified wood
- No-added urea formaldehyde content
- Class A fire rated
- Custom sized panels
- Virtually VOC free finish and glue
- Sawdust byproduct reclaimed and donated as biofuel

Rulon's Aluratone acoustical wood wall and ceiling system is truly the leader in our industry. What makes our Aluratone so special? In the wood ceiling and walls industry, few actually make what they sell. At Rulon's state of the art manufacturing facility, we provide cutting edge processes. Order from Rulon and you have a choice of FSC-Certified, no-added urea formaldehyde, Class-A fire rated, 92% pre-consumer recycled content. All this and throw in a custom stain or clear finish, standard with every order. Do you need an even more custom product? No problem! Our in-house engineers and staff architects will work hand-in-hand with the designer to achieve that one-of-a-kind ceiling or wall. At Rulon, we don't claim to be the only manufacturer of wood ceilings and walls... *just the best!*

[www.rulonco.com](http://www.rulonco.com)



**RULON COMPANY**

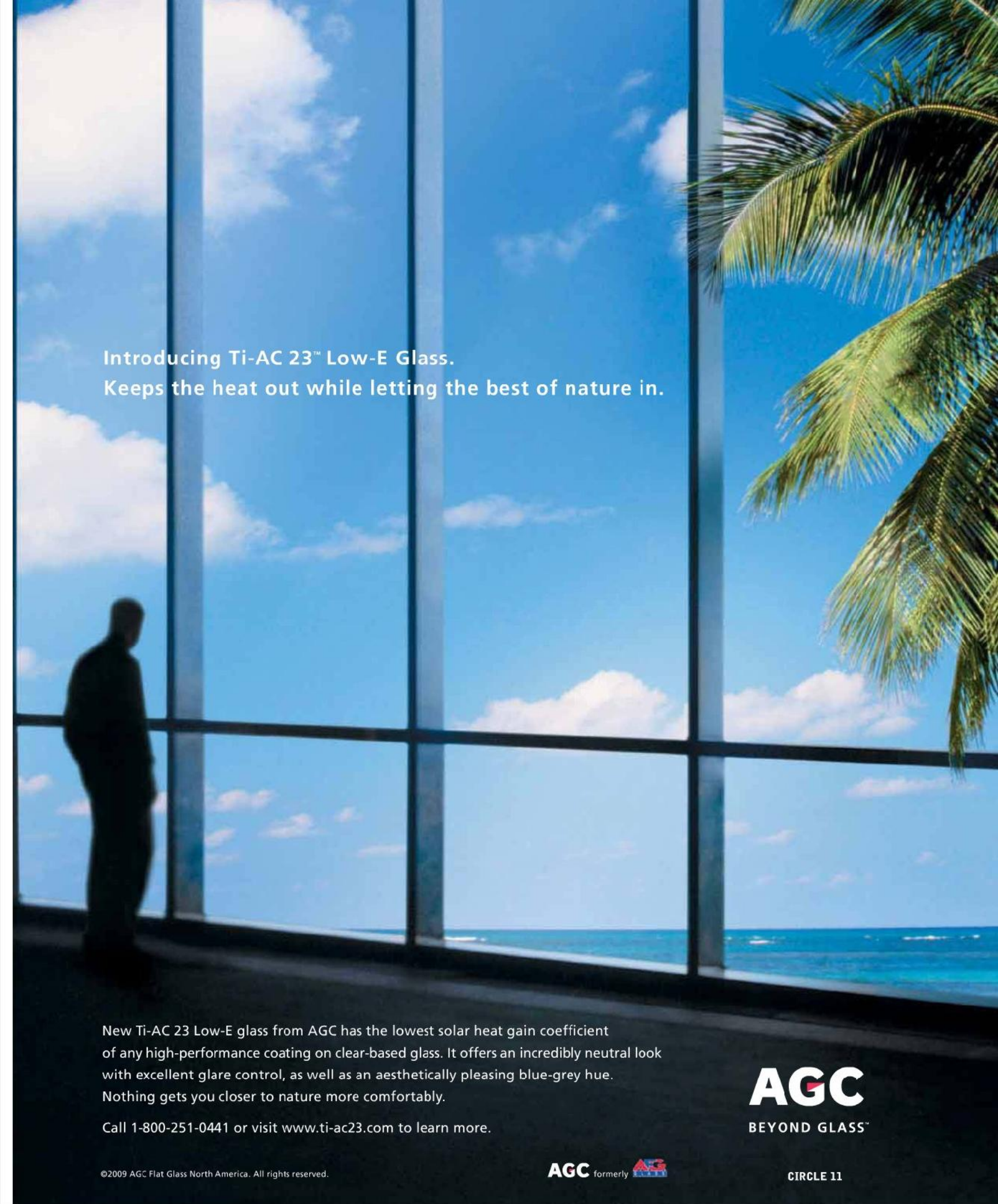

Introducing Ti-AC 23™ Low-E Glass.  
Keeps the heat out while letting the best of nature in.

New Ti-AC 23 Low-E glass from AGC has the lowest solar heat gain coefficient of any high-performance coating on clear-based glass. It offers an incredibly neutral look with excellent glare control, as well as an aesthetically pleasing blue-grey hue. Nothing gets you closer to nature more comfortably.

Call 1-800-251-0441 or visit [www.ti-ac23.com](http://www.ti-ac23.com) to learn more.

**AGC**  
BEYOND GLASS™





## ELEVATORS FOR EVERY IMAGINATION.

Freedom. That's what synergy MRL elevator technology from ThyssenKrupp Elevator gives you. It's the result of a three-year, global collaboration aimed at giving you the greatest design flexibility possible. So go for it and draw your heart out. We won't stand in your way. Learn more at [www.seewhatwebuilt.com](http://www.seewhatwebuilt.com)

synergy

ONE WORLD. ONE COMPANY. ONE SOLUTION.

# ARCHITECTURAL RECORD

## 05.2009

**On the Cover:** Glenn Murcutt. Photo by Anthony Browell.  
**Right:** Clockwise from top left: Chanelle Gilbert of CHAD, photo by Ryan Donnell; Comcast Center, by Robert A.M. Stern, photo by Peter Aaron/Esto; OMI.MGX pendant by Assa Ashuach.



88



168



226

## News

- 29 **Peter Zumthor wins 2009 Pritzker Prize**
- 34 **Freelon designs civil rights center**
- 36 **Recession report**

## Departments

- 25 **Editorial: Reflecting the Facts**
- 26 **Letters**
- 51 **Archrecord2: For the emerging architect**
- 55 **Critique: Openings in the city fabric** by Michael Sorkin
- 59 **Books: Celebrating the profession, past and present**
- 63 **Practice Matters: Sustainability assessments** by B.J. Novitski
- 67 **Snapshot: Ladybird Lake public restroom** by Stephen Sharpe
- 239 **Dates & Events**
- 260 **Backpage: Reader's Gallery**

## Features

- 77 **Minority Report: Minding the Gap** by David Sokol  
What are the hurdles that continue to impede diversity in architecture?
- 78 **Breakthroughs and Obstacles** by G. Chaise Nunnally and Ted Landsmark  
Two writers survey the dearth of African-Americans in the profession.
- 82 **Marrying Content to Container** by David Sokol   
National Museum of African American History and Culture finalists.
- 88 **The Diversity Pipeline** by James Murdock   
Design-centered high schools help bring minorities to the field.
- 103 **AIA 2009 Honor Awards** by Ingrid Spencer
- 104 **Gold Medal Award** by Andrea Oppenheimer Dean
- 114 **Architecture Awards**
- 122 **Interiors Awards**
- 134 **Urban Design Awards**
- 142 **25 Year Award** by Beth Broome
- 144 **Firm of the Year Award** by Jane F. Kolleeny

## Projects

- 159 **Office Buildings** by Josephine Minutillo
- 160 **Gas Natural Headquarters, Spain** by Josephine Minutillo  
Enric Miralles Benedetta Tagliabue  
Rather than act as a beacon, a building pays tribute to the city around it.

- 168 **Comcast Center, Pennsylvania** by Suzanne Stephens  
Robert A.M. Stern Architects  
Philadelphia's tallest building brings a trim and tailored presence to the city.
- 176 **Merck Serono Headquarters, Switzerland** by Joann Gonchar, AIA  
Murphy/Jahn  
Knitting an ode to transparency into Geneva's urban fabric.
- 184 **Shanghai World Financial Center, China** by Aric Chen  
Kohn Pedersen Fox  
A tower cuts through the skyline like a glittering knife.

## Architectural Technology

- 199 **LEED Looks Ahead With an Ambitious Overhaul**   
by Joann Gonchar, AIA  
A rating system revamp is grounded in science and environmental benefit.

## Lighting

- 214 **Ofita, Spain** by David Cohn  
King & Miranda Design
- 219 **Cofra Group, New York City** by Linda C. Lentz  
Perkins+Will
- 223 **Dallas Center for Architecture, Texas** by Stephen Sharpe  
Peter Doncaster, AIA, Booziotis & Co.; Nicholas Marshall, AIA, nodesign;  
Gabriel Smith, AIA, Thomas Phifer & Partners
- 226 **Lighting Products** by Rita Catinella Orrell

## Products

- 233 **Windows** by Rita Catinella Orrell and Aleksandr Bierig
- 236 **Product Briefs** by Aleksandr Bierig
- 252 **Reader Service**

 Expanded coverage of Projects, Building Types Studies, and Web-only features can be found at [architecturalrecord.com](http://architecturalrecord.com).

## 05.2009

On the Web 

The **focus on diversity** in this month's issue extends to our **Web site**, where RECORD has **launched** a new permanent section dedicated to coverage of **architects** from backgrounds **historically underrepresented** in the profession.



Reader Photo: This image of the LEED Gold-certified Kettle Foods Manufacturing Facility in Beloit, Wisconsin, is one of more than 2,000 reader-submitted images in ARCHITECTURAL RECORD's online galleries.

## Online Only

PHOTO GALLERIES

BLOGS

FORUMS

VIDEOS

COMMENTS



### Record TV

New in our video library: Students take us on a tour of the Charter High School for Architecture and Design in Philadelphia.



### AIA 2009: San Francisco

In our guide to the Bay Area, members of the local design community recommend favorite architecture, restaurants, and more.



### House of the Month

Randy Bens transformed a 1950s bungalow with gestures that update the original structure without diminishing its history.

### Your Comments

*"I think the real take-home here is that architecture starts with a conversation, not sitting in your office waiting for rich people to call you."*

— Anonymous on an interview with John Morefield, who set up an "Architecture 5c" booth in a Seattle farmers' market.

## Expanded Coverage



### 2009 AIA Awards

View dozens of images of award-winning projects, read an interview with Firm of the Year founder Jim Olson, and more.



### Diversity Special Section

Tour projects, watch videos, read news, and browse all of our coverage of diversity in the profession in a new special section of our site.



### AR2

Meet Seattle's Pb Elemental, a young firm that got into real estate development to build work, and the craft-focused firm studiomake.

**"LEED 2009 emphasizes the critical issues of energy, transportation, and water."**

### CEU

We take a comprehensive look at LEED 2009. Read about it, and take an online test to earn health, safety, and welfare/sustainable design credits.

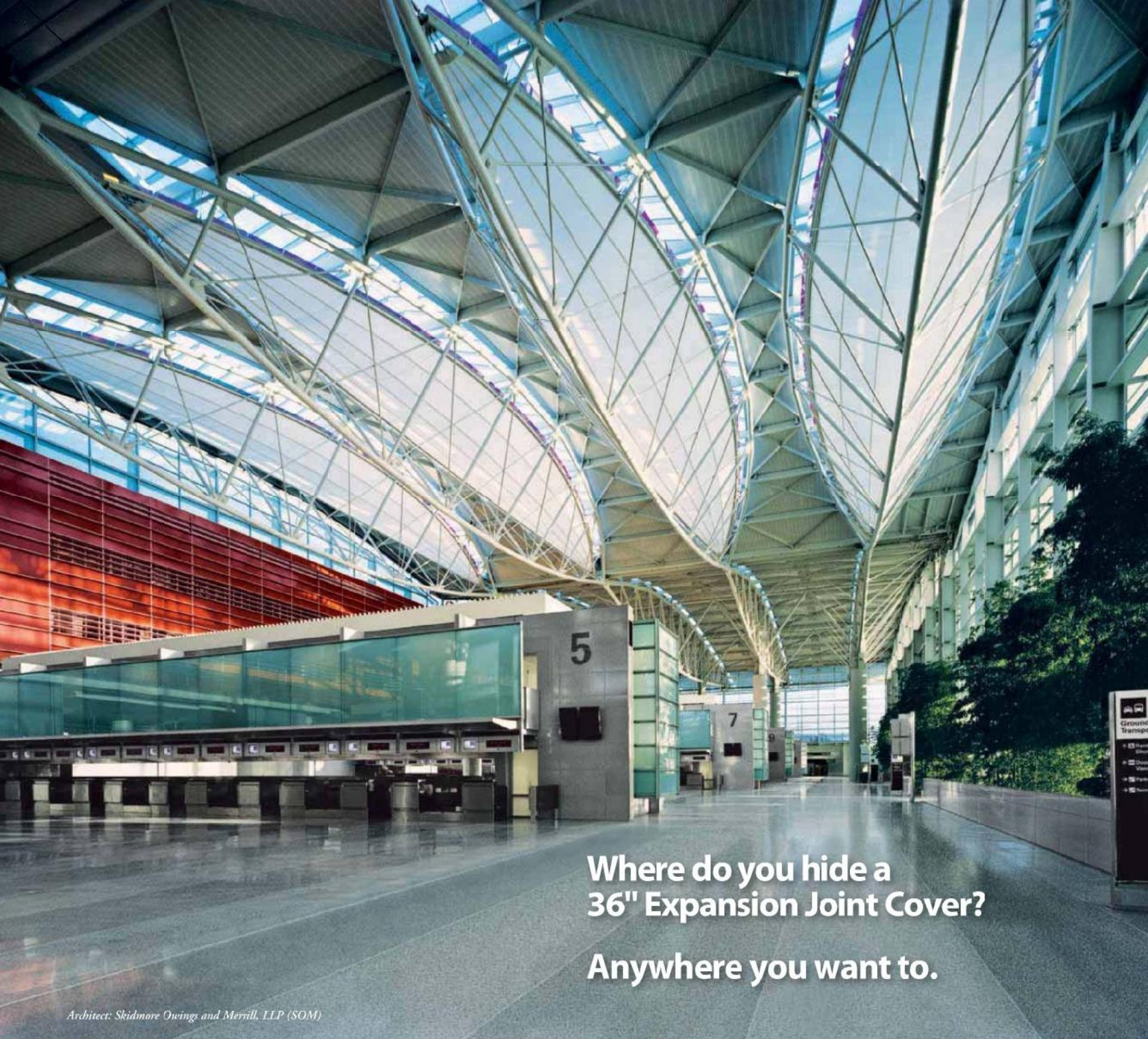

**Where do you hide a  
36" Expansion Joint Cover?  
Anywhere you want to.**

*Architect: Skidmore Owings and Merrill, LLP (SOM)*



At San Francisco International Airport, they are hidden in the floors, interior and exterior walls. How? Our state-of-the-art seismic covers allow you to inset the surrounding finishes. Our joint covers can accept stone, metal, drywall and virtually any other material you can think of. So if you don't want to see the joint, call us at 1-888-621-3344 or visit [www.c-sgroup.com](http://www.c-sgroup.com).



**SEE US AT AIA**  
Booth 1117



# Learn & Earn

Architectural Record Continuing Education



Earn FREE Health Safety Welfare (HSW) and Sustainable Design (SD) credits with Architectural Record!

You can now earn continuing education credits free online at Architectural Record's Online Continuing Education Center!

All exams are available at no charge and are instantly processed. You will know immediately if you have earned credits and you will be able to print out your certificate of completion instantly. You can access this and many other continuing education courses online at [ce.ArchitecturalRecord.com](http://ce.ArchitecturalRecord.com)

Check out our online Continuing Education Center at [ce.ArchitecturalRecord.com](http://ce.ArchitecturalRecord.com)

On [ce.ArchitecturalRecord.com](http://ce.ArchitecturalRecord.com)

## The Greening of Government Buildings

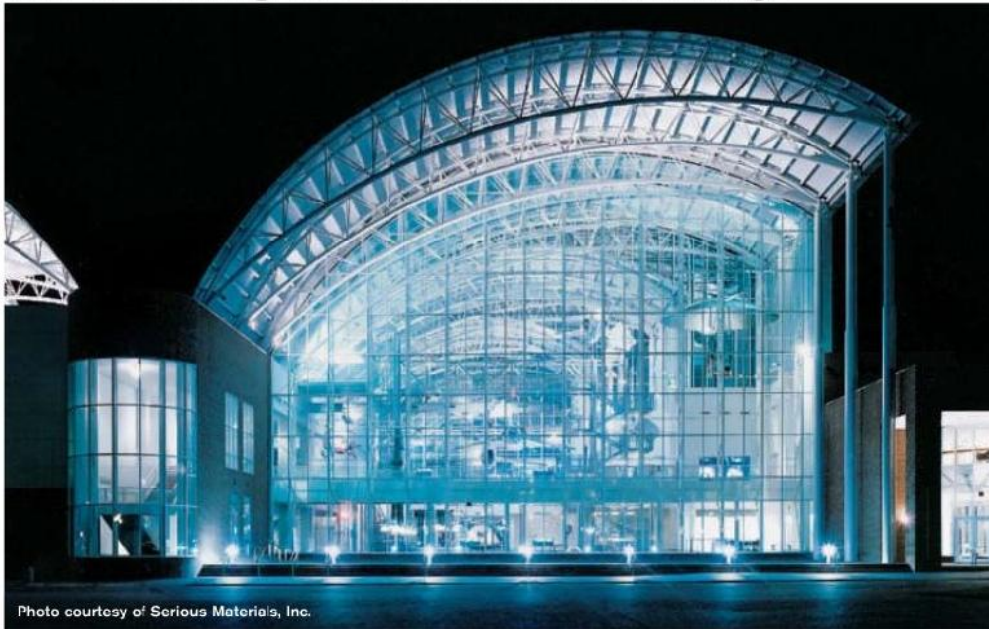

Photo courtesy of Serious Materials, Inc.

Credit: 1.00 HSW/SD

### Learning Objectives:

At the end of this course, you will be able to:

- Understand the scope and nature of federal stimulus spending as it relates to building improvements
- Describe Federal Government green-building and integrated design policies
- Explain the dynamic relationship among building envelope elements and building heating, cooling, ventilation, and lighting systems
- Explain the architect's role in the integrated design process for a government building or renovation project

Sponsored by:



connecting people\_projects\_products

**McGraw Hill CONSTRUCTION** Architectural Record

[ce.ArchitecturalRecord.com](http://ce.ArchitecturalRecord.com)

The McGraw-Hill Companies

## Daylight

Nysan daylighting blinds harvest natural light to increase indoor comfort and reduce energy costs. Automated with Solarware™ controllers, the concave louvered blinds direct light further across a room while keeping workplaces glare free. With energy saving products and unmatched expertise, Nysan Solar Control solutions make harvesting daylight easy.



For more ideas on daylighting and solar control,  
go to [www.nysan.com/daylight](http://www.nysan.com/daylight)

*Architects:* Wright Heerema Architects

*Product:* Custom Nysan Solar Control solution  
3" solid daylight louvered blind, with high gloss linen finish,  
managed with Solarware™ sun tracking system

Call 403-204-8675 or 800-727-8953

©2009 Hunter Douglas Inc. ® Trademark of Hunter Douglas Inc.

**HunterDouglasContract**

SOLAR CONTROL

CIRCLE 145



*A green iguana  
Quiet on the forest floor  
Is one with the earth*



Introducing Natura<sup>®</sup> by Benjamin Moore, our new standard in paint safety and performance. It has zero VOC's, virtually no odor and the lowest emissions of any national zero VOC paint brand on the market. And because it's from Benjamin Moore, Natura comes in over 3,300 vibrant colors.



For a listing of Green Promise products please visit us online.

[naturapaint.com](http://naturapaint.com)

©2009 Benjamin Moore & Co. Benjamin Moore, Natura and the triangle "M" symbol are registered trademarks licensed to Benjamin Moore & Co.

CIRCLE 13





# Reflecting the Facts

## Editorial

By Robert Ivy, FAIA

One year ago, ARCHITECTURAL RECORD's editorial addressed the issue of diversity in a column entitled, "Room for All Our Talents" [May 2008, page 39]. In the intervening months, despite the election of a new president of the United States and the economic free fall in our construction and design markets, little has changed to balance the national employee profile of the architectural office. African-Americans in particular still form only from 1.5 to 1.7 percent of the total number of registered architects.

In turning again to the topic of diversity in architecture, this month's editorial will not preach, but will present statistics reflecting contemporary reality, all drawn from the United States Census Bureau. The most recent data show how our racial and ethnic makeup as a country has changed, a factor that should influence architects.

How does your office align with the new realities? Unless your workplace has broadened to include individuals from a variety of backgrounds, you may find the client sitting across the table from you five years from now may have a different cultural background and set of expectations from yours. Will you be able to understand his or her needs?

While minorities now constitute about one third of the total U.S. population, by the year 2042, today's minorities will become the majority. By that time, persons we classify as "minority" are projected to tip 54 percent, and even by 2023, the number of children now classified as minority becomes the majority. Things change.

By 2050, the number of whites in the U.S. population will have increased only slightly from today's figures, while other groups should see large gains: Hispanics are expected to nearly triple in number, while African-Americans will grow from approximately 14 percent to 15 percent of the total. Asians should reach 9 percent of the population, increasing from a current level of 5 percent. The result of these shifts in ethnicity and racial makeup mean that, by the year 2042, persons classifying themselves as white will no longer constitute a majority of the United States, according to U.S. Census projections. More detailed statistics, excerpted from the report, flesh out the above points:

- The non-Hispanic, single-race white population is projected to be only slightly larger in 2050 (203.3 million) than in 2008 (199.8 million). In fact, this group is projected to lose population in the 2030s

and 2040s and compose 46 percent of the total population in 2050, down from 66 percent in 2008.

- Hispanic population is projected to nearly triple, from 46.7 million to 132.8 million during the 2008–2050 period. Its share of the nation's total population is projected to double, going from 15 percent to 30 percent. Thus, nearly one in three U.S. residents would be Hispanic.
- The black population is projected to increase from 41.1 million, or 14 percent of the population, in 2008 to 65.7 million, or 15 percent of the nation's population, in 2050.
- The Asian population is projected to climb from 15.5 million to 40.6 million. Its share of the nation's population is expected to rise from 5.1 percent to 9.2 percent.
- American Indians and Alaska Natives are projected to rise from 4.9 million to 8.6 million (or from 1.6 to 2 percent of the total population). The Native Hawaiian and Other Pacific Islander population is expected to more than double, from 1.1 million to 2.6 million. The number of people who identify themselves as being of two or more races is projected to more than triple, from 5.2 million to 16.2 million.

Clearly, these statistics indicate that our former hiring practices, not to mention ways of speaking that emphasize dichotomy and oppositional language, such as "we/they," fail to address how the United States and the world has changed. In today's world, "they" have become "us." The architectural practice that continues to support a monoculture fails to reflect the facts; attracting a new generation of talent to address the design demands of the 21st century remains a primary challenge for the future.

What can we do together? As a partial answer, in this issue, RECORD looks at how one ethnic group, African-Americans, is faring today. A cluster of features, guest-edited by contributing editor David Sokol, explores the thinking of current leadership, as well as programs that can make a difference for the future. More work remains, on all our parts.

For more information on U.S. Census data, go to [www.census.gov/Press-Release/www/releases/archives/population/012496.html](http://www.census.gov/Press-Release/www/releases/archives/population/012496.html).

# Letters

## Keep the icon alive

Thank you for Robert Ivy's editorial, "Death of the Icon" [April 2009, page 17]. I too began my architecture career in the late 1960s and '70s, but I don't think ARCHITECTURAL RECORD should succumb and apologize for publishing beautiful heroic "icons." It is your duty to publish and encourage an architecture of "passion and poetic depth," even risking an "eager young" student's question of "why?" Without icons, expressed in "artistic passion," there is no magic for the human mind and nothing to sustain architecture – there is only engineering. Soon, architects will ask, along with Pete Seeger, "Where have all the flowers gone?"

*Will Miller*

*New Smyrna Beach, Fla.*

The criterion proposed in Robert Ivy's editorial for the houses presented in the April issue is that they be "iconic." While he doesn't provide his definition of the term, some come to mind: "an important or enduring symbol" and "a symbol whose form suggests its meaning or the object it represents." There was little or no connection between these meanings and the featured houses, in particular the incomprehensible object on the cover whose form suggests anything but a house. Perhaps a re-reading of the cover line "Blurring the Boundaries" (i.e., anything goes) is more instructive. Next time see if you can deliver up some clarity and skip the blur.

*James Bruck*

*Jackson, N.J.*

## Responsible living?

To be sure, many of the Record Houses 2009 are quite beautiful, even stunning. All are very much of the Modernist tradition so in vogue at the moment, yet none reflects the broader goals established by your

magazine and by the AIA: Notably, how do we create regional architecture that responds effectively to the specifics of site and climate and how do we make architecture accessible to the general public? Your recent selections reflect a rigid bias toward high-end Modernist projects that do not relate to their particular sites. What does it say to our students and young practitioners when we celebrate such expensive homes?

*Steve Thompson, AIA*

*Scottsdale, Ariz.*

The April issue of Houses was wonderful to see: beautiful photography of dynamic homes, finely written articles and critiques. I have been so disappointed by the quality of photography in many of the past Houses issues.

This year's issue was super, with wonderful photos by Roland Halbe, Scott Frances, and others.

*Dan Reaume*

*Windsor, Ontario*

Are you sure the YTL Residence in Malaysia [page 106] isn't a set for an upcoming Bond movie? Your spread is missing 007, his female nemesis, and the evil megalomaniac plotting world destruction. Oh, it's also missing the control room. Or is that in the basement somewhere?

*Thomas H. Mudrovich, AIA*

*Wausau, Wis.*

This year's Record Houses conveniently disassociated themselves with environmental (and fiscal) responsibility. Good thing, because they represent close to a complete disregard for even a shred of the housing realities we face in the 21st century. Yes, this fact was alluded to in Suzanne Stephens's intro. Ironically, she noted that issues of sustainability were subjugated in order to diversify the range of houses,

but only two of the eight aren't set in a stereotypical rural context that would make even an abandoned station wagon look good! I really question the purpose of Record Houses. Each year they seem more and more removed from forward-thinking ideas and issues about the home.

*Ron van der Veen*

*Seattle*

## The editors reply:

We are well aware of the economic and environmental issues involved in housing – this is the reason we devoted so many pages in March to the recession and why our sister magazine *GreenSource* recently published its first issue devoted to sustainable housing. Many of the Record Houses were chosen as a farewell gesture to a time when it was possible to live out our fantasies. We know next year's choices will reflect a very different moment.

## Strong words

RECORD without architectural images on the cover?! As a soon-to-be architectural professional, the cover of the March 2009 issue drew my attention more than any photo. News about the recession, including pink-slipped seniors and the depressed academic atmosphere, actually motivated me to keep working on design. As I read the issue, I could sense the seriousness of the current economic recession and, at first, it made me depressed. Paradoxically, however, I felt somewhat relieved after I finished reading. This recession is not just my concern – it's everyone's. I've come to appreciate that since architecture is eventually for the people, RECORD is right to talk about real human issues. For architecture to be good, it must incorporate the realities of the human condition in society.

*Wonshok Lee*

*New York City*

## Unwanted advice

I found Brian James Barr's report on John Morefield's advice booth [April 2009, Record News, page 21] both sad and infuriating. While I applaud Morefield for his tenacity during tough times, I am saddened to see my fellow professional sink to such levels. What other professionals would do something like this, and what other profession would allow it? Wouldn't a doctor lose his license? Wouldn't an attorney be disbarred? This is just another example of the mind-set that has led architects to being some of the lowest-paid professionals around. We need to figure out how we can catch up to the other members of the construction industry, not find ways to give discounts for our valuable services.

*Joseph Auld*

*New York City*

## Corrections:

In the article on the Vienna Way Residence [April 2009, page 74], the second-floor plan and the north arrow were turned the wrong way by 180 degrees. March's Commentary on Medellín, Colombia [page 37], should have credited Ana E. Velez for her work on the botanic garden's entry pavilion and also have noted that she and Giovanna Spera were on the team behind Parque de los Pies Descalzos. Due to a transcription error, a story in the March issue [page 58] indicated that construction on SOM's Pearl River Tower in Guangzhou, China, had temporarily ceased. In fact, that project was never suspended. A separate, large commercial-and-residential project in Guangzhou had been put on hold, but construction has since resumed.

*Send letters to rivy@mcgraw-hill.com.*

“Oldcastle Glass® Skywall® partnered with us from the beginning to engineer and manufacture 150,000 square feet of curtain wall.”

—Donald Powell, AIA, Principal—BOKA Powell, LLC



**Granite Park III by BOKA Powell, LLC—  
Custom-engineered Curtain Wall  
by Oldcastle Glass® Skywall®**

“We designed Granite Park with a unique, sweeping, dramatic curved glass curtain wall,” said Donald Powell, Architect/Principal, BOKA Powell. “And as designers, we believe that the best design solutions come from a thorough understanding of the problem. Oldcastle Glass® Skywall® understood that from the very beginning. They engineered and manufactured a custom, unitized curtain wall, which visually complements the surrounding sky and landscape.” Call 1-866-OLDCASTLE (653-2278) or visit us online at [oldcastleglass.com](http://oldcastleglass.com). **See us at the AIA Convention, booth #727.**



**Oldcastle Glass®  
Skywall®**

*Pushing the building envelope™*

SAVING ENERGY  
OUTWEIGHS ALL  
OTHER MEASURES  
OF GREEN BUILDING.  
EIFS SAVE MORE  
ENERGY THAN  
BRICK, STUCCO,  
CONCRETE BLOCK &  
FIBER CEMENT SIDING.



The results of a new landmark study conducted by **Oak Ridge National Laboratory** provide for the first time, real-world data demonstrating that **Exterior Insulation and Finish Systems** perform better than other typical claddings in tests measuring energy efficiency, moisture intrusion and temperature control. Research shows EIFS to be an excellent choice in mixed, coastal, hot and humid climates. Superior energy efficiency, the benchmark of sustainable building, along with moisture control, make EIFS the superior green cladding. **Download research data released by Oak Ridge National Laboratory at [www.EIMA.com](http://www.EIMA.com) or call 770-968-7945.**

# EIFS

ENGINEERED FOR PERFORMANCE  
DESIGNED FOR ENERGY EFFICIENCY

**EIMA** EIFS INDUSTRY  
MEMBERS  
ASSOCIATION

## Peter Zumthor wins 2009 Pritzker Prize

By Layla Dawson

Peter Zumthor, the reclusive Swiss architect widely revered for a small yet powerful body of work, is the 2009 laureate of the Pritzker Architecture Prize. The Hyatt Foundation, which administers the award, announced his selection on April 12.

"Peter Zumthor is a master architect admired by his colleagues around the world for work that is focused, uncompromising, and exceptionally determined," the jury said in its citation. "He has a rare talent of combining clear and rigorous thought with a truly poetic dimension, resulting in works that never cease to inspire."

The Pritzker, established in 1979, is bestowed annually on a living architect who has made a consistent and significant contribution to the built environment. The 65-year-old Zumthor, in keeping with his reputation, spoke modestly of receiving the profession's top honor. "It's a beautiful recognition of what we've been doing here for the past 20 to 30 years, and without me having to do a lot of 'networking,'" he said. "It shows that the buildings speak for themselves."

Zumthor has painstakingly, and sometimes with his own hands, completed projects within a limited geographical radius, mainly for religious, residential, or cultural uses.

His best-known projects are the Bregenz Art Museum (1997), a shimmering glass-and-concrete cube that overlooks Lake Constance in Austria; the cavelike thermal baths in Vals, Switzerland (1999); the Swiss Pavilion

*Layla Dawson is an architect and writer based in Hamburg, Germany. RECORD's news editor, Jenna M. McKnight, contributed to the story.*

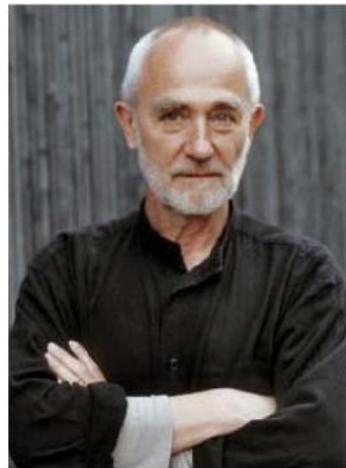

1) Among Zumthor's best-known projects are the Thermal Baths in Vals, Switzerland (top), and the Bregenz Art Museum in Austria (bottom).

for Expo 2000 in Hanover, Germany – an all-timber structure intended to be recycled after the event; and most recently, the Kolumba Diocesan Museum (2007), in Cologne, Germany [RECORD, January 2008, page 78]. In a world of short attention spans, Zumthor is known for the time he takes to listen to his clients, and also for demanding from his clients the time he needs to develop his designs.

Born in 1943, in Basel, Switzerland, on the border with Germany and France, Zumthor studied first in his home city, and then at the Pratt Institute, in New York. On returning to Switzerland he was a conservation-

ist architect for historic monuments before opening his own atelier in 1979 in Haldenstein, near Chur, where he employed both architects and carpenters. His staff totals around 15 people.

Zumthor's reputation as an architect's architect brought him guest professorships at the Southern California Institute of Architecture, Munich's Technical University, and his present post at the Architecture Academy of Switzerland's Italian University. But despite his international teaching, Zumthor's own work is rooted in a philosophy of locality and regional culture, in which time and continuity are important aspects.

His design philosophy can perhaps be explained by the fact that he only decided on architecture after an apprenticeship as a cabinetmaker, under his father. Like Renzo Piano, the Genoa-based 1998 Pritzker winner, who also started out in his father's building workshop, Zumthor sees architecture as handwork. He refers to his design office as an atelier and, in comparison to other internationally known architects, he has resisted becoming a company director or opening global branch offices. By concentrating on only one or two projects at a time, Zumthor has acquired the aura of a hands-on spiritual environmentalist, rather than that of a star architect.

The architect's devotion to each project, along with his meticulous craftsmanship, earned him praise from the eight-member Pritzker jury, which this year included Lord Palumbo, Alejandro Aravena, Shigeru Ban, Rolf Fehlbaum, Carlos Jimenez, Juhani Pallasmaa, Renzo Piano, and Karen Stein. Stein, the New York-based writer and consultant who has served as a juror since 2004, said of the selection of Zumthor: "I think, overall, we admire the fact that he shows architecture is both an art and a craft."

This is the second time the Pritzker laureate has hailed from Switzerland (Swiss architects Jacques Herzog and Pierre de Meuron were the 2001 winners). The \$100,000 prize includes a Louis Sullivan-designed bronze medallion. Zumthor will be honored on May 29 at a ceremony in Buenos Aires, Argentina. It will be a late birthday present for Zumthor, who celebrated his 66th birthday on April 26.

 View images on-line of projects by Zumthor completed in the past three decades.



### AIA honors winners of 2009 Young Architects Award

The eight recipients of the 2009 Young Architects Award will be recognized this month at the AIA's convention in San Francisco. The prize honors individuals who have demonstrated exceptional leadership and made significant contributions to the profession early in their careers. Architects who have been licensed for 10 years or less, regardless of their age, are eligible. The winners were announced on January 29.

#### Matthew Kreilich | 1

Kreilich is noted for his pro bono work on Minneapolis's Theatre de la Jeune Lune, where he renovated the lobby on a shoestring budget. He attended the University of Minnesota and works at Julie Snow Architects.

#### Angela Brooks | 2

Brooks is a principal with Pugh + Scarpa and cofounder of the non-profit Livable Places. She has been involved in projects that have received seven national AIA awards, including the Colorado Court affordable apartments and the Solar Umbrella home.

#### Michael W. Schellin | 3

In addition to his committee work with AIA Minnesota, Schellin is his region's liaison with the national Young Architects Forum. He is a principal at the Minneapolis-based firm Williams/O'Brien Associates.

#### Jinhee Park | 4

Park and the studio she cofounded, Single Speed Design, are widely published, and were awarded *Metropolis* magazine's first "Next Generation" prize. Her firm has offices in Boston and New York.

#### Haril Pandya | 5

Pandya, a project manager at CBT,

designed an affordable, sustainable prototype for Habitat for Humanity and managed its construction. He was also a driving force behind the creation of the Boston Society of Architect's first Young Professionals Advisory Council.

#### Tania Salgado | 6

In addition to volunteer work with numerous Denver nonprofits, Salgado is an active leader in the AIA at the local and state levels. Currently, she serves as AIA Denver president-elect and is a design principal at RNL.

#### Camilo Parra | 7

Widely recognized as a designer and builder of upscale and affordable town-house developments, Parra also conducts a studio at a design school and volunteers in his community. He is a member of the Houston Minority Business Council.



#### Matthew Bremer | 8

Bremer started and co-chairs AIA New York's New Practices Committee and sits on the chapter's Oculus Committee. He founded the firm Architecture in Formation.

### City College's architecture school snares \$25 million gift

A public architecture school that for decades struggled with a chronic lack of funding has procured a historically large gift.

On April 2, the School of Architecture, Urban Design and Landscape at the City College of New York received a \$25 million donation from Bernard Spitzer, a well-known city real estate developer. Spitzer, who graduated from City College in 1943 with an engineering degree, is also the father of former New York governor Eliot Spitzer, who resigned last year in the wake of a prostitution scandal.

Bernard Spitzer's gift is the second largest ever given to an architecture school. In 1999, developer A. Alfred Taubman gave \$30 million to the University of Michigan's College of Architecture and Urban Planning.

The donation is not earmarked for a specific purpose. Rather, it will fund scholarships, pay new faculty members' salaries, and support travel expenses for student competi-



Currently, the school is housed in Shepard Hall (above) at City College.

tions, among other uses, all of which will go toward helping City College compete against local rivals like Parsons, the Pratt Institute, and even Columbia University, says Gregory H. Williams, City College's president.

"It's a tremendous mark of distinction that will allow us to be even better recognized," says Williams, adding that the school

has been renamed the Bernard and Anne Spitzer School of Architecture, effective immediately.

Constantly at the mercy of budget-cutting politicians since its founding in 1968, the architecture school did not even have a dean for a nine-year period in the 1990s before the arrival of George Ranalli, AIA. He took over in 1999 and is still at the helm.

Today, the school, which has 63 professors and 400 students, appears to be on much better footing.

Its new \$58 million, 118,000-square-foot home, designed by Rafael Viñoly, opens this summer on the university's upper-Manhattan campus. Currently, the school is squeezed into a 65,000-square-foot space inside Shepard Hall (1905), a Gothic Revival building by George Post.

The school is also expanding its academic offerings. Last year, it added a three-year master's degree, and in 2010, it will start offering a master's degree in sustainability, and later, a Ph.D. program in urbanism, both of which could be partly funded by Spitzer's gift, according to Ranalli.

For his part, Spitzer hopes the money encourages designing with more formal inventiveness. "Students who are coming out of school today are showing unusual imagination," he says, "but this could bring even more fantasy to the process." *C.J. Hughes*



**N**obody ever said, “Hey, there goes that architect who made that tiny little plexiglass model of a really cool building.”

To get the recognition you deserve, your idea has to make that leap from concept to reality. Travelers knows architecture and can provide coverage for every part of your business. Our specialists are with you every step of the way, from start to finish, and everything in between. For more information on Travelers insurance for architects, contact your independent agent or call 877.237.6588, ext. 32253. And then nothing can come between you and your well-earned kudos.

**TRAVELERS**   
Insurance. In-synch.™

### Gehry chosen to design Eisenhower memorial in D.C.

In the firmament of U.S. presidents, Dwight D. Eisenhower may not be known for his star power. But the Washington, D.C., memorial planned for the 34th commander in chief will enjoy the talents of a marquee-name architect: Frank Gehry.

On March 31, after six months of sifting through 44 entries, the commission assigned to the job of creating the memorial announced it picked Gehry, a Pritzker winner, to design the 4-acre site, which is located a block south of the National Mall. [Disclosure: RECORD's editor in chief, Robert Ivy, was involved in the initial stages of judging.] The \$110 million project, which is part of the General Service Administration's Design Excellence Program, is set for completion in 2014.

Gehry beat out three other finalists in the competition's



While the design isn't finalized, the project is set for completion in 2014.

third and final stage: Krueck + Sexton Architects, from Chicago; PWP Landscape Architecture of Berkeley, California; and Rogers Marvel Architects of New York City. Because Gehry's plan is preliminary and still requires input from the Eisenhower family and key D.C. agencies, details won't be made public until the design is completed, according to the Dwight D.

Eisenhower Memorial Commission, which is overseeing the project.

Proposals had to spell out how the site could be transformed into a public square and needed to include a canopy and 2,500 square feet of enclosed space for ranger stations, restrooms, and possibly a bookstore, according to Daniel Feil, FAIA, who is the commission's executive architect. Unlike other tributes to presi-

dents in Washington, the memorial could not include any statuary.

Gehry's plan stood apart, according to Feil, because it emphasizes a significant amount of greenery for the mostly concrete and asphalt site, which is bisected diagonally by 11-lane-wide Maryland Avenue. In recent years, the site has served as a de facto parking lot. "He understands that a civic space must have certain duality," Feil says. "You want to appreciate it from the outside looking in, but when you're inside, you want to focus on the message."

Eisenhower was the Allied forces' commanding general in Europe during World War II, and later headed both NATO and Columbia University. Also, as president, Eisenhower created federal agencies focused on education, health, and air-travel safety that endure to this day.

Despite numerous accomplishments, Eisenhower was unusually humble, a personality trait that attracted Gehry to the project. "He wasn't blustery and didn't make big pronouncements," Gehry says. "I feel a sense of kinship with how he did what he did." *C.J. Hughes*

### Green-building movement loses two pioneers

Members of the green-building community are mourning the deaths of two influential and trailblazing architects.

Gail Lindsey, FAIA, founder of the Wake Forest, North Carolina, environmental consulting firm Design Harmony, died February 2 of complications from liver cancer. She was 54.

Greg Franta, FAIA, principal architect and senior vice president of the Rocky Mountain Institute's Built Environment Team, based in Boulder, Colorado, died in a single-car accident on a highway south of Boulder. Franta, 58, had been missing since February 9. His car and body were discovered at the bottom of a ravine on March 10.

Although they lived in different parts of the country, Lindsey and Franta often worked together on sustainability projects, and they sometimes collaborated at workshops and conferences. Both helped



Greg Franta (left) and Gail Lindsey (right) both helped develop the USGBC's LEED rating system.

develop the U.S. Green Building Council's Leadership in Energy and Environmental Design (LEED) rating system, and both were founding members of the American Institute of Architect's Committee on the Environment. Lindsey and Franta also participated in the Greening of the White House energy-efficiency project in 1993.

Lindsey made her mark as a passionate advocate for sustainable

design. She was among the first LEED trainers, and she helped create the AIA's Top Ten Green Projects program. In addition to the White House greening project, she had done similar consulting work with the Pentagon, the National Park Service, and the General Services Administration. Last year, she won the AIA North Carolina's Gold Medal Award.

"She taught a lot of people about doing the right thing," says AIA president Marvin Malecha, FAIA, dean of the College of Design at North Carolina State University. "Her message was basically that we need to be

an integral part of the environment, not apart from it."

Franta was considered a pioneer in the world of environmentally sustainable architecture. From 1981 to 2005, he was the principal of Boulder-based ENSAR Group, an architectural and sustainable design firm. ENSAR merged with the nonprofit Rocky Mountain Institute, cofounded by energy guru Amory Lovins, and became RMI's Built Environment Team. In 1998, Franta was named AIA's Colorado Architect of the Year.

Consultant Cara Taverna Carmichael, who worked closely with Franta, says he was an inspirational leader with a magnetic personality. "Greg's death leaves a big void at RMI," she says, "but we're all trying to encompass a little bit of what he stood for, and perhaps collectively we can help maintain his vision."

*David Hill*



GLARE, NO. BRILLIANT, YES.

LED Site Lighting Perfection. This is Kim Lighting.

[www.kimlighting.com/warp9\\_led/](http://www.kimlighting.com/warp9_led/)

## Record News

### Freelon Group tapped for civil rights center

Atlanta has long been an epicenter of the civil rights movement, and the hometown of many of its most influential figures. The Southern Christian Leadership Conference was founded here in 1957; the Student Nonviolent Coordinating Committee staged sit-ins at Atlanta department stores in 1960; and the city is the birthplace of Martin Luther King, Jr.

When it opens in 2012, the Center of Civil & Human Rights (CCHR) will commemorate Atlantans' and Georgians' role in securing equality for African-Americans, and serve as a venue for contemporary efforts in the field of human rights.

On March 26, CCHR announced that it selected the Durham, North Carolina-based The Freelon Group as the designer of the forthcoming



\$125 million facility. HOK will be the architect of record. A 12-person jury selected the winner from a shortlist of five teams.

The 100,000-square-foot building will be located in Pemberton Place, a 20-acre public space currently anchored by the World of Coca-Cola and the Georgia Aquarium, just north of Centennial Olympic Park. The center includes gallery, administration, storage, and retailing functions, as well as an auditorium and outdoor

amphitheater for public events. Philip Freelon, FAIA, says the venue will serve as a "crossroads of conversation about civil and human rights."

Freelon's design features two cantilevering arms "derived from an image of people of varying cultures and backgrounds uniting in solidarity." The building's textured skin is composed of terra-cotta panels that attach to the structure in a manner similar to a rain screen. Large windows in both arms provide glimpses into the

The design for the 100,000-square-foot center (left and below) in Atlanta features two linked arms, meant to symbolize people "uniting in solidarity."



CCHR's multifaceted program. Visitors to Pemberton Place will look through one such opening in the southwest corner, where rotating video displays will be projected onto an interior-mounted scrim. Catty-cornered from it, another expanse of glass frames the King Papers – an exhibition of Martin Luther King, Jr.'s, manuscripts, correspondence, and other written works – and overlooks the historically African-American neighborhood of Sweet Auburn. *David Sokol*

### Despite popularity, New Orleans architecture high school still challenged

The residents of the Carrollton district of New Orleans must be prescient.

Prior to Hurricane Katrina, the Carrollton United Neighborhood Organization (CUNO) decided that reopening Alfred C. Priestley Junior High, which had been closed since 1993, would spark local revitalization, and a survey of residents indicated widespread support for a school that offered architecture and construction curricula. In spring 2005, the community group began negotiating with the Orleans Parish School Board to secure the vacant building

for its reuse as the Priestley School of Architecture & Construction.

After the storm, Orleans Parish fast-tracked CUNO's charter-school application, granting one that October. "Prior to the storm, it was extremely hard to get a charter school approved by the state," explains Michelle Biagas, Priestley's principal and C.E.O. But Katrina forced a change of attitude among the education establishment, and Orleans Parish "felt that having this school would be a feather in its cap."

Although the original Priestley building was not yet suitable for

occupation, the school opened inside a temporary facility in September 2006 with 35 ninth-grade students. Enrollment has since swelled: Today, the school has 322 students and 37 staff members, and according to administrators' plan, Priestley will have 400 students encompassing all four high school grades by fall 2009. These teenagers represent a cross section of the area – 99 percent of them are African-American, and 311 qualify for free lunches – and a demographic that is underrepresented in the design professions.

Enrollment is not contingent upon qualifying exams or even a pre-existing interest in design, says Jared Hueter, the school's architecture curriculum specialist. So far, learning highlights include redesigning the landscape surrounding the entrance of the McNair Building, one of the school's previous temporary homes; a trip to Washington, D.C., to study historic sites; and cooperating with 100 architects from Perkins+Will to

prepare designs for the renovation of the namesake Priestley building.

Hueter, who was hired in 2008, plans to "intensify rigor and raise expectations." Project-based learning is being incorporated into all subject areas, and each grade is examining a specific building type. Hueter and his colleagues are also working with nonprofits to involve students in rebuilding projects nearby.

For all its successes, the school still needs a homecoming: it has changed locations every year, while the landmark that inspired the experiment still stands empty. "It is hard to recruit students when we are a moving target," Biagas says, adding, "if we do not have students, we do not get public funding." Although Perkins+Will has designed the renovation pro bono, refurbishing the original Priestley building – a three-story brick structure by E.A. Christy – will cost upward of \$10 million. "Many funders are willing and ready to fund educational reform," Biagas says, "but not bricks and mortar." *David Sokol*



Perkins+Will is designing a new home for the school (above).

See us at AIA  
at Booth #4847!

## Wait 'til you get a look at this puppy.

**Our new PYRAN® Platinum glass-ceramic is the best looking fire-rated glass you've ever seen.**

Meet the latest addition to our fire-rated glass family. PYRAN Platinum glass-ceramic offers stunning optical quality and clarity with virtually no distortion. And, of course, safety is a given. PYRAN Platinum fire-rated glass-ceramic meets UL requirements and, when laminated or with surface-applied safety films, it also meets ANSI and CPSC standards for impact resistance. SCHOTT is dedicated to our environment, so PYRAN Platinum glass-ceramic is environmentally friendly. In fact, it's the first glass-ceramic produced without toxins. It comes in large sizes and is easy to get your paws on through our distributors, local fabricators and glaziers. To bone up on PYRAN fire-rated glass-ceramics, call us at 502-657-4417 or visit us at [www.us.schott.com/pyran](http://www.us.schott.com/pyran).



**SCHOTT North America, Inc.**  
5530 Shepherdsville Road  
Louisville, KY 40228  
Phone: 502-657-4417  
Fax: 502-966-4976  
[pyran@us.schott.com](mailto:pyran@us.schott.com)

[www.us.schott.com/pyran](http://www.us.schott.com/pyran)

©2009 SCHOTT North America, Inc.  
© PYRAN Platinum is a registered trademark of SCHOTT AG, Mainz, Germany

**SCHOTT**  
glass made of ideas



CIRCLE 18

### AR RECESSION REPORT

## As the economy sinks, skyscrapers soared ever higher

Although 2008 brought a financial crisis that stretched unemployment rolls and slowed production lines across the globe, it was a superlative year for skyscrapers. According to a recent study by the Council on Tall Buildings and Urban Habitat (CTBUH), more tall buildings – and taller ones – were completed in 2008 than ever before. The council expects 2009 to be another record year.

The CTBUH study, released in January, reports that the concurrence of failing financial markets and skyscraper grand openings is not unusual; rather, it results from what Philip Oldfield, a coauthor of the report, calls “a lag effect.” Because buildings take years to move from conception to construction to completion, those begun at the apex of the market are often finished at its nadir.

The study also found that, beyond rising heights, current and future trends in tall building include a



The Shanghai World Financial Center (left) is one of the world's tallest towers.

material shift from steel to concrete, a programmatic shift from office to mixed-use and residential, and a geographic shift from North America to Asia and the Middle East.

The study predicts that we will start to see a dip in the completion of supertall towers in 2011, with the average height of the 10 tallest skyscrapers completed in the following few years dropping by as much as 300 feet. “But as the world comes out of the recession,” says Oldfield, “figures suggest that height will again start to break records.”

What accounts for the supertall trend? Oldfield partly attributes it to a growing interest in sustainability. Noting that denser cities are becoming

widely accepted as essential to the prevention of climate change, he says, “high tall buildings are an integral part of creating that density.” He adds that other drivers include rising land prices, which make height an economic necessity, and public perception. “Tall buildings are global icons,” he says, and can catapult cities and whole countries into the global arena.

Terence Riley, curator of the 2004 *Tall Buildings* exhibition at the Museum of Modern Art in New York, agrees and suggests that Americans in particular “can look to the skyscraper as a truly American invention.” The world’s first skyscraper is considered by most to be William Le Baron Jenney’s 1885

Home Insurance Building in Chicago. “I think there’s a kind of pride and awe in the technology that is not totally misplaced,” adds Riley.

From the 1,250-foot Empire State Building completed in 1931 to the 1,614-foot Shanghai World Financial Center completed just last year, examples of such iconic skyscrapers abound. Soon to join the list are two buildings by Skidmore, Owings & Merrill: the 1,776-foot World Trade Center One in New York, expected to be finished in 2012, and the Burj Dubai, expected to top out in the fall of 2009 (the firm is not revealing a specific date) at more than 2,600 feet.

Of course, these days there are plenty of reports of halted projects. Among them: Santiago Calatrava’s Chicago Spire, two Norman Foster projects – the Russia Tower in Moscow and the U2 Tower in Dublin, which would have been Ireland’s tallest – and several projects in Dubai, including the Burj al Alam by Nikken Sekkei. The Torre Gran Costanera by Pelli Clarke Pelli in Chile is the latest building to fall victim to the global economic crisis: The BBC reported at the end of January that construction has stopped on what was to be, at 985 feet, the tallest office tower in South America. *Anya Kaplan-Seem*

### AR RECESSION REPORT

## Competition fierce for public school projects

In January, Minneapolis-based Cunningham Group Architecture submitted a proposal for a public elementary school in Austin, Texas. It expected to be one of 10 competing firms, says firm principal Tim Dufault, AIA; instead, it was one of two dozen. Similarly, it anticipated little competition for an elementary school in suburban Albuquerque – a project that ultimately drew 32 proposals.

Traditionally, public schools are not the most sought-after commissions, due to low budgets and little room for unique designs. That so many firms are now pursuing these types of projects reflects a hard real-

ity: The public realm is one of the only sectors with a pulse right now.

The Architectural Billings Index, a leading economic indicator, has fallen below 50 for 14 straight months, hitting 33.3 in January, a record low. According to Kermit Baker, the AIA’s chief economist, the inability to get financing for construction projects has led to poor business conditions for architects nationwide. “Obviously, more firms are looking to diversify their offerings,” Baker says, “and it’s resulting in more firms competing for the same projects.”

Jeanne Jackson, AIA, of Salt Lake City–based VCBO Architects – one of Utah’s largest firms specializing in public schools – says her work has traditionally been unaffected by the economy. “But it appears that firms who have done few school-construction

projects are now starting to throw their hats in the ring, presumably because the market is tighter,” she says. And though these commissions usually go to local architects, Jackson says she has seen many firms trying to get a “leg up” on the competition by teaming up with out-of-state “experts” on a particular building type.

Some architects say they aren’t concerned about the increased competition because they already have strong relationships with school districts. “Really, it all depends on the firm’s relationship with the client,” says John Weekes, AIA, of Portland, Oregon’s Dull Olson Weekes, a design firm that is actually hiring right now.

While demand for schools is strong, there is plenty of uncertainty about funding. Dufault and Jackson have both seen new public projects

getting delayed, especially schools, which typically are paid for through a bond process. Jackson says many districts aren’t even entertaining the idea of new construction because they fear their constituents won’t pass bond measures. Federal stimulus dollars could provide a shot in the arm for these districts: More than half of the \$53.6 billion State Fiscal Stabilization Fund was earmarked for education, part of which could be used for school renovations or construction.

Even if the economy picks up, many expect competition for public schools to remain high. Dufault sees this as a good thing, as it will put architecture front and center at school board meetings. “Great architecture,” Dufault says, “only happens when the community values design and commits to invest in it.” *Brian James Barr*

Visit us at the  
AIA 2009 National  
Convention: Booth #4165

# METALwrap

Distinctively  
INNOVATIVE.

Distinctively  
CENTRIA.

Introducing MetalWrap™ an innovative building product that can shorten construction time, reduce the number of construction steps, improve a building's thermal performance, and provide superior moisture resistance. Created specifically for CENTRIA's non-insulated metal wall systems, MetalWrap's unique design brings superior energy efficiency and high performance to metal wall backup systems. With more than a century of knowledge and experience, CENTRIA is where building teams turn for solutions, support and a distinct advantage.

**We are... Distinctively CENTRIA.**



**CENTRIA**

Architectural Metal Wall  
and Roof Systems

Call us or visit our Website for more information.

800.250.7897 | [MetalWrap.CENTRIA.com](http://MetalWrap.CENTRIA.com)

CIRCLE 19





If you could design your dream window,  
what would it be?



myMarvin by

*P. Allen Smith*

P. Allen Smith  
Garden Home Designer

Create something uniquely yours. With windows and doors built around you.  
And your clients. For inspiration from the myMarvin Project artists, the latest  
home design trends, or all the new products, go to **myMarvin.com**



**MARVIN**   
Windows and Doors

Built around you.®

## Record News

AR RECESSION REPORT

### With jobs scarce, will young architects flee the profession?

In 2006, after Ben Straus earned an architecture degree from Carnegie Mellon University, he foresaw a long career of designing offices, hospitals, and university buildings. Instead, after being laid off in January from Zimmer Gunsul Frasca Architects in Portland, Oregon, Straus finds himself selling \$6 pints of homemade ice cream out of his kitchen for Presidential Sweets, his new business. (Sample flavor: Vanillard Fillmore.)

Still, even though Straus, 25, doesn't expect to land a comparable architecture job for many months, he also isn't opening up an ice cream parlor just yet. "I really love the profession. I chose it for a reason, and it's become part of my life," he says. "I don't think I could ever give it up."

In the first quarter of this year, the architecture and engineering sector in the U.S. shed 88,000 jobs, according to the Bureau of Labor Statistics. Though the ages of the unemployed aren't officially known – the agency doesn't release them – anecdotal evidence suggests many are like Straus: under 40. And these early to mid-level architects, frustrated by job searches that can yield just one interview for every 100 e-mailed resumes, are often taking jobs in other fields, design-related or otherwise.

While there's some worry among older architects that their younger counterparts could strike out in entirely new directions and exit the field permanently, which happened during recessions in the 1970s and early 1990s, young architects today don't seem to be fleeing architecture for good – at least not yet.

"Our graduates aren't running off, though they are redefining what they can do," says Amy Crossette, a spokeswoman for the University of Texas at Austin School of Architecture, which will graduate 110 students this spring, up from 85 last year.

To help that reinvention, her school's career center recently shifted its focus from job placement to counseling about recession-survival tips, largely in response to phone calls from worried parents. The office now promotes jobs that might be only loosely connected to architecture, such as working

as a sustainability consultant; to improve hiring chances, it also encourages students to stay current with new versions of AutoCAD, AutoCAD Revit, and Google SketchUp after they graduate.

But AutoCAD skills don't guarantee full-time employment. Despite being familiar with the software, plus having a master's degree in architecture from the Savannah College of Art and Design, Sameer Panchal, 28, of Jersey City, New Jersey, has found work only three days a week at a Brooklyn firm, he says, and it's for an hourly wage.

That said, Panchal won't be charging careers anytime soon. As he explains, "When somebody selects architecture" – which he did in ninth grade – "they have a passion for it, and they understand there are bad times and downturns you have to go through."

Even those who have no steady income other than unemployment checks seem upbeat about the profession's fortunes – such as Joe Stroming, 36, of Seattle, who was laid off last June from the Seattle office of Sienna Architecture. (The entire firm was shuttered in January.)

After sending out 175 resumes, only three of which netted interviews, Stroming applied for a job as a ski instructor this

winter. He was offered the position, but it paid less than his unemployment checks, so he decided to pass and keep hunting.

Stroming believes that in the near future there will be opportunities for architects designing light-rail transportation stations and retirement homes; as local governments increasingly work to make existing built environments more energy efficient, they might add architects to their payrolls, too, he believes. "I think if you can make it through this, you won't ever experience anything quite as bad," Stroming says.

In many ways, Gen X and Y's tenacity echoes that of some baby boomers, who graduated when architecture jobs were also scarce, which made backup plans necessary, says Bruce McMillan, AIA, a 63-year-old architect in Manhattan, Kansas. Soon after getting out of school in 1973, McMillan was laid off twice by the same Atlanta firm, which prompted him to take up a teaching career to make ends meet; today, McMillan is an adjunct professor at Kansas State University but also runs his own five-employee firm.

"You need an insurance policy, something you can do to maintain yourself and your family during downturns," says McMillan, who encourages his current students, many of whom are flirting with sidetracks in other occupations, to consider teaching. "I would advise anybody to build in whatever that may be." *C.J. Hughes*



**Ben Straus sells homemade ice cream to help pay the bills.**

## The new Ultimate Casement Collection. Inspired by you.



**C** Countless Design Options.



**L** Large Sizes - Ultimate Performance.



**E** Ease of Installation.



**A** Any Application.



**R** Revolutionary Wash Mode.

The difference is C.L.E.A.R. Thanks to the new innovations that came from our research with architects. See it in action at [marvincasement.com](http://marvincasement.com)

**MARVIN**  
Windows and Doors  
Built around you.®

©2009 Marvin Windows and Doors. All rights reserved.  
®Registered trademark of Marvin Windows and Doors.  
1-800-236-9690

# INCOMPARABLE WOOD BALANCED DOORS



Wood doors that use the renowned Ellison Balanced Door hardware and frames are now available. For information on wood selection and door design contact our factory.

**ellison**  
Ellison Bronze, Inc.

800-665-6445  
www.ellisonbronze.com

CIRCLE 22

## Record News Online

Below is a roundup of stories recently posted to our online news section. Read the full stories, along with daily headlines and breaking news, at [architecturalrecord.com/news](http://architecturalrecord.com/news).

I.M. Pei and Henry N. Cobb's **John Hancock Tower** (1976), in Boston, is a ready symbol of the vertiginous commercial real estate market: The building recently sold at a foreclosure auction for half-price.  
*Ted Smalley Bowen*



The architecture program of **Tuskegee University**, the historically black university founded by Booker T. Washington in 1881, has regained accreditation after having it revoked in 2006.  
*David Sokol*

**The Glasgow School of Art**, one of Britain's oldest and most distinguished design schools, launched an international competition to select a team for a new studio and classroom building opposite **Charles Rennie Mackintosh's** 1898 masterpiece.  
*David Dillon*

On April 7, a boutique for fashion designer Derek Lam, designed by the Tokyo-based firm **SANAA**, opened its doors. Located in Manhattan's SoHo neighborhood, the store is near the firm's other **New York City** project, the New Museum of Contemporary Art.  
*Karen Bookatz*



**Jean Nouvel**, the **2008 Pritzker Prize winner**, was selected by Dolce & Gabbana to design the exhibition, **Extreme Beauty in Vogue**, a photographic survey of various manifestations of beauty. The show is housed inside the 800-year-old **Palazzo della Ragione**, in Milan. View a slide show.  
*David Sokol*

The official exhibition from the **U.S. pavilion at the 2008 Venice Architecture Biennale** has arrived in the States, and it is proving to be more relevant than ever. View a slide show.  
*Tim McKeough*

The Cuban-born architect **Max Borges, Jr.** passed away on January 18, after an extended illness. View a slide show of his work.  
*John Loomis, FAIA*

The Cuban-born architect **Max Borges, Jr.** passed away on January 18, after an extended illness. View a slide show of his work.  
*John Loomis, FAIA*

The **U.S. General Services Administration** announced the recipients of its **2008 Design Awards**, a biennial program intended to showcase the best examples of federal government architecture. View a slide show.  
*Tim McKeough*

Think you've been overlooked in the \$787 billion economic stimulus package? Architecture firms may find more opportunities than they would expect, says the editor of the recently released **Guide to the American Recovery and Reinvestment Act of 2009**, produced by ZweigWhite. *Bruce Buckley*

The Nevada AIA chapter recently launched an initiative to convince state lawmakers to substitute shovel-ready projects with **"pencil-ready"** ones.  
*Bruce Buckley*

The winners of **A New Infrastructure: Innovative Transit Solutions** for Los Angeles were recently announced. The ideas competition, organized by SCI-Arc and *The Architect's Newspaper*, asked designers to "rethink the relationship between transit systems, public space, and urban redevelopment." View a slide show.  
*Aleksandr Bierig*



The **AIA and the Green Building Initiative**, which administers the Green Globes building-rating system, have signed a document that expresses their intent to work in concert to promote green building.  
*Michael Wilmeth*

The U.S. Green Building Council, U.K.-based **Building Research Establishment Trust**, and Green Building Council of Australia have agreed to establish consistent methods for measuring and reporting carbon dioxide emissions.  
*Terri Peters*

The Architectural Billings Index **jumped to 43.7 in March**, up from 35.3 in February. It's the first time the score has climbed above 40 since September 2008.  
*Jenna M. McKnight*





## Balanced Doors with a Split Personality

Just Hit The Button



**Power operation only when you need it. Balanced door operation when you don't.** Our revolutionary design eliminates complicated, unsightly surface mounted hardware. A concealed low energy operator and actuating arm provide opening force on demand. Our standard hardware provides the closing force. When used manually PowerNow is pure Ellison.



by  
**ellison**  
Ellison Bronze, Inc.



See us at AIA, Booth #4457, San Francisco, CA

[www.ellisonbronze.com](http://www.ellisonbronze.com)

# Design with light.™

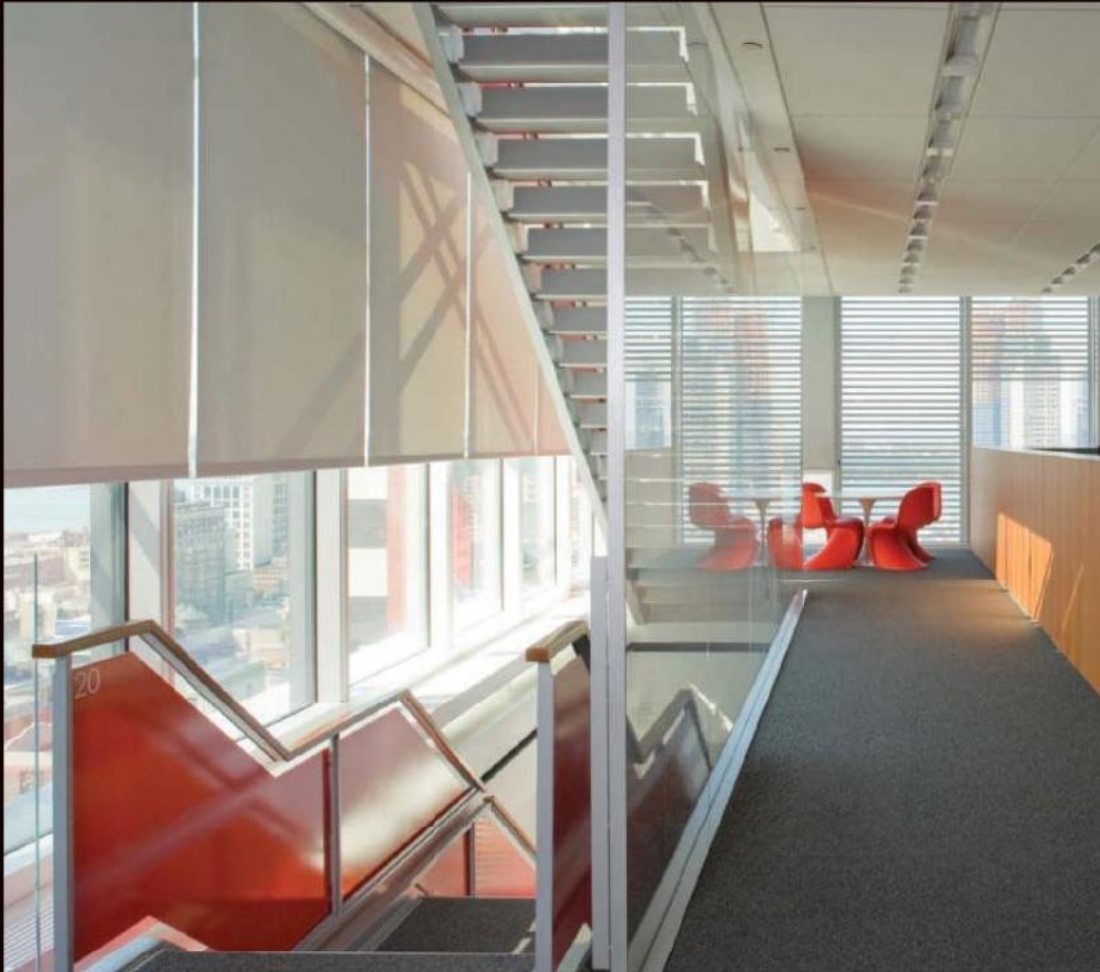

WindowManagement® solutions:

SolarTrac® computer-automated window-shading system

EcoVeil® sustainable PVC-free solar shadecloth

Mecho®/5 solar-shading system with EcoVeil®, Cradle to Cradle Certified<sup>CM</sup> Silver by MBDC

And a full range of other innovative solutions

Visit us at AIA National Convention  
San Francisco, CA, booth no. 547  
April 30 - May 2, 2009

 **MechoShade Systems**  
The Architect's Choice™

Tel: +1 (800) 437-6360, Fax: +1 (718) 729-2941  
marketing@mechoshade.com  
MechoShadeSystems.com

The New York Times Building, N.Y.  
Architecture: Renzo Piano Building Workshop  
with FXFowle Partners; Architectural interiors:  
Gensler. © 2009 MechoShade Systems, Inc.  
All rights reserved. Photography: Bernstein  
Associates Photographers. Cradle to Cradle  
Certified<sup>CM</sup> is a certification mark of MBDC.





INSPIRING

WIDECK®

CREATIVITY

Roof And Floor Deck Ceiling Systems

WP450A



EPIC Metals' structural roof and floor deck ceiling systems are designed to maximize architectural possibilities and creative potential. Long span capabilities of 10–55 feet are intended to define a building's envelope with unique appearance options and a high degree of interior acoustical control.

**EPIC**<sup>®</sup>  
METALS CORPORATION

877-696-3742 Toll-Free  
[www.epicmetals.com](http://www.epicmetals.com)

CIRCLE 25

Shyenne 9th Grade Center, West Fargo, ND Architect: YHR Partners, Ltd., Moorhead, MN

# GREENGLASS®

a TempleInland product

## Liner Panels



Elevated mold, moisture and fire protection *plus* the highest level of recycled content in the industry.



Tough as expected. Green as it gets.

### GreenGlass®: All the performance of Glass, a whole new standard for Green

GreenGlass® is different from every other glass-mat liner panel out there. Not only does it provide maximum protection against mold, moisture, fire and unwanted noise – its unmatched 90+% recycled content can also make more significant contributions toward credits in the top green-building rating systems. Featuring a core enhanced with the TemShield® Mold Protection System sandwiched between naturally mold- and moisture-resistant fiberglass facers, GreenGlass is designed for elevator and mechanical/electrical shaft, stairwell and area separation wall assemblies where a U.L.-approved two-or-more-hour fire resistance rating is required. We're talkin' undeniable performance and unrivaled green building credits in one glass-faced gypsum liner panel – now that's what we call elevated product benefits.

To learn more, visit [www.GreenGlassInfo.com](http://www.GreenGlassInfo.com)



ISO 14021

**TempleInland®**

[www.templeinland.com](http://www.templeinland.com) | 800-231-6060

©2009 TIN, Inc. Temple-Inland, GreenGlass and TemShield are registered trademarks of TIN, Inc.

innovation • design • quality • ecology • value



# WHY TOTO?

## INNOVATION

With unrivaled vision and innovation expertise, TOTO leads and never follows in designing, engineering, refining and delivering innovative technology that enhances your daily life. TOTO's innovations translate into the best performance and ecology in the plumbing world, from our "best-in-class" flushing technologies to EcoPower faucets and flush valves that harness the energy of moving water. Call 800-350-8686 or visit [totousa.com](http://totousa.com) for more information or to find a TOTO dealer near you.

**TOTO®**

[totousa.com](http://totousa.com)





WE GOT THE IDEA FROM NATURE.  
BUT WE CHANGED IT ENOUGH THAT  
SHE COULDN'T SUE US.



Tempest Solid Surfaces are like no other: semi-translucent, reminiscent of polished quartz, and in colors that make a unique design statement. See more high-performance surfaces at [staron.com](http://staron.com).

**tempest**

by Staron® Surfaces

# COMPARING GLASS SOLUTIONS?

It pays to see the big picture.



LOW-E GLASS  
SHADES / BLINDS  
EXTERIOR SUNSHADES  
LARGER HVAC  
HIGHER ENERGY COSTS  
- LIGHTING & COOLING  
- PEAK DEMAND CHARGES

SAGEGLASS GLAZING \$\$\$

When you add it up,  
the cost is closer than you think.

If you've ever considered specifying SageGlass® electronically tintable glass for your building but thought the cost of such an innovative product was too high, take a closer look. Traditional methods of controlling sunlight and heat quickly add up and can be comparable to if not more costly than SageGlass glazing. And dollars are only part of the equation: SageGlass glazing conserves energy while preserving the view and connection to the outdoors – which is the reason we put glass in buildings in the first place.

For a clearer view of the value picture, go to [www.sageglass.com](http://www.sageglass.com) or call 1-877-724-3321. Please visit us at booth #844 at the 2008 Greenbuild show.



Not only do traditional methods add up to increased costs, they cost the environment too.

The extra products to control light and heat require additional manufacturing, transportation and installation. Using SageGlass glazing eliminates the need for these add-ons.



**Able to protect tall buildings in a single bound.**

*Start Smart.  
Be a Hero.  
Visit [typar.com](http://typar.com).*

**Finally, a building wrap with super powers.**

Typar® MetroWrap™ is a commercial building wrap that can withstand the pressures above four stories. And when you consider the exceptional bulk water holdout, Type I air resistance, 12 month UV protection and other incredible benefits\*, using MetroWrap just might make you the hero.

\*(Kryptonite resistance test pending.)

**TYPAR**®   
**MetroWrap**™

*A Fiberweb Brand*

**Building Wraps • Flashings • Construction Tape • Roof Wrap • Landscape Products • Geotextiles**

© 2009 Fiberweb, Inc. Typar® is a registered trademark of Fiberweb, Inc. MetroWrap™ is a trademark of Fiberweb, Inc.

# Parking Outside the Lines.

Parkade lightweight and textured metal fabric systems add much more to parking structures than just aesthetics, providing sustainability, improved ventilation, high visibility, headlight attenuation, and lasting safety and security.

Parkade intrigues the senses, captures the imagination and veils structures with character.



Project: Santa Monica Civic Center

Distinction: First LEED® Certified Parking Garage in the US

Location: Santa Monica, CA

Architect: Moore Ruble Yudell Architects & Planners, Santa Monica, CA

PARKADE™ Architectural Mesh System



CAMBRIDGEARCHITECTURAL.COM

**Factory  
Prefinished  
Steel Kerf  
Frame**

**Factory  
Installed  
Mitered  
Door  
Seal**



## **Our Factory Just Saved You Up To 30% Per Opening.**

**Timely's installed prefinished steel frame cost is about 30% below primed hollow metal frames.**

It's simple math. Our steel, fixed throat, kerf entry door frame is prefinished to the color of your choice. Then we install a Schlegel Systems Q-Lon® seal onto the frame, and there you've got it. Up to 30% savings per opening by eliminating onsite painting and seal installation.

**As a result, call-backs are virtually things of the past.**

Timely kerf frames deliver these and many other advantages to offices, hotels, light commercial construction, garage-to-home, multi-housing—wherever door seal protection is needed.

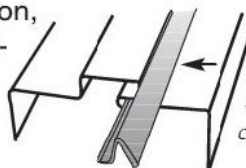

Factory installed non-adhesive door seal slips into kerf. Seal can easily be replaced.

**Plus Timely Quality, Efficiency, Wide Selection.**

- Seals available in beige, black, white, bronze, grey
- Prefinished-no jobsite painting
- 4 stocking, 32 custom frame colors, or we'll match any color you desire
- 5 casing profiles or select your own wood casing
- 90-minute positive pressure fire rating
- 18-gauge steel construction
- Electro-galvanized
- 5/8 stop and wall size 4 - 8 inch
- Full perimeter anchoring for greater strength

**TIMELY**  
PREFINISHED STEEL DOOR FRAMES  
A DIVISION OF S.D.S. INDUSTRIES, INC.

[www.timelyframes.com/ar](http://www.timelyframes.com/ar)

See us at our AIA Booth No. 6647

Timely Corporate Offices: 10241 Norris Ave., Pacoima, CA 91331-2292 / 818-492-3500 / 800-247-6242 / Fax 818-492-3530  
Eastern Distribution Center: 9782 InterOcean Drive, Cincinnati, OH 45246 / 513-682-9600 / 800-346-4395 / Fax 513-682-4102  
Georgia: 4713 Hammermill Road, Tucker, Georgia 30084 / 770-493-8811 / 800-445-8899 / Fax 770-491-1653

# The emerging architect

## archrecord2



### design

#### Pb Elemental

A portfolio full of built work and no boundaries

For most emerging architectural practices, it takes a hard drive full of competition entries, a trail of proposed designs, and, for the lucky ones, a small-scale installation or two before realizing a building proper.

Pb Elemental, a five-year-old firm based in Seattle, skipped those typical rites of passage, immediately generating an extensive portfolio of built work. At 32 and 30 years old, respectively, the firm's founders – Chris Pardo and Dave Biddle – now have dozens of projects built in the Seattle area, and several under construction around the world.

The initial partnership began in the familiar way: Biddle and Pardo met at graduate school at the University of Washington, where they pursued M.Arch. degrees. They quickly veered from typical trajectories, however. “We were ramping up our work at school, and talking about a potential thesis,” explains Biddle. The two did not want to finish school with only drawings and models to show for it. “We wanted to get our hands dirty with something real.”

With a thesis project in mind, in 2004 they set out into the city, and as Biddle puts it, “We found a property, bought it, designed it, and built it.”

While not accidental, their beginning was somewhat ad hoc. “We never had a ready-made plan,” says Biddle. They came up with a name – P: Pardo, B: Biddle, “architecture is elemental,” they say – and oversaw the construction of the house.

With its boxy California Modern appeal, the project, called Central District Town Homes, generated buzz in Seattle, and the very recent graduates quickly picked up commissions for clients wanting a similar design. “Our first office was the dashboard of a brown Ford F-250,” remembers Pardo. “We spent most of our time at the construction site working from there.” Having traded the truck for plumbing services a few years ago, the firm is now based in a former food-storage warehouse.

They did not stop at architecture, spinning off a construction company (LEAD Construction), an engineering practice (LEAD Consulting), and a real estate firm (Modern Dwelling). “We developed these practices as the need arose,” explains Pardo. “We are architects with an integrated practice.”

With housing projects and condo developments in South America and a hotel in China, the firm continues to expand. “Most of the work is referred to us,” says Biddle. “We’ve never advertised.”

#### **Sterling Residence, Seattle, 2007**

*This 3,200-square-foot home in Seattle’s Queen Anne neighborhood uses volumes and voids that create unique, diagonal relationships between spaces.*



**Crockett Residence, Seattle, 2008** *Designed for a young family, this 1,633-square-foot home features a roof deck and a 480-square-foot apartment on its lot. Clerestory windows and glass walls upstairs make for bright, sunny living spaces.*



Brian Cavanaugh joined the firm as principal in 2008 and is involved not only in expanding the range of building types Pb takes on, but also in positioning the practice within a critical framework. "We are in the middle of formulating what we think of the office," says Cavanaugh. "Design offices should take a critical position in the city, so we plan to take on research initiatives, probably involving materiality, sustainability, or urbanism."

To that end, Pb is eyeing Seattle's public transportation. "One of the things the city has to deal with is mass transportation," says Cavanaugh. "Seattle is beginning to take it on, but it is lacking in vision. It's something that the design community needs to think about more aggressively."

"Pb was appealing, since in only four years, the office had inverted the model of a young firm," explains Cavanaugh. "With Pb, you have an office that established itself on a lot of built work." *John Gendall*

 [View additional images online.](#)



**151 Lofts, Seattle, 2010** The design for this 18-loft-unit building includes 5,600 square feet of commercial space and features solar shading, green roofs, and natural ventilation.



The craft-inspired firm *studiomake* bases its work on the premise that everything it creates should be a poetic gesture. Cases in point: kiln-made, slip-cast porcelain cups (above), are produced by omitting registration keys from the mold-making process, and the sit of faith chair (below) is only really a chair when someone is sitting on it.

## work

### studiomake

Careful craft, from objects to architecture



crowded, subtropical Bangkok. The curriculum's focus on drawing, Im says, also introduced her to architecture as a handmade discipline.

When Im met up with David in San Diego in 2003, the two, who have been married since 2005, got crafty together. That year, they realized onospace, an intervention in their 426-square-foot apartment in which steel armatures compartmentalize kitchen, storage, and workshop spaces, which David fabricated. Afterward, while learning ceramics at a local Japanese pottery studio, Im noted further parallels between architecture and craft. "It seemed like it could start to raise questions about architecture, and vice versa," she says of her ceramic vessels' surfaces, negative spaces, and interaction with light. When the couple began considering pursuing master's degrees, those commonalities forced a revelation. Schafer says, "We thought we could use graduate school to explore a totally different aspect of making," to which Im adds, "We didn't want to make models of buildings but make the thing itself."

In 2007, David and Im were accepted into Cranbrook's metalsmithing and ceramics programs. David's work can be classified neatly as architectural: His final project there conceives a universal clamp with which a user may assemble any materials into furniture or small-scale volumes. Im has gone in a slightly different direction. Using slip casting as her primary method, she is producing ceramics such as *kiln-made* (top left), whose appearance of deconstructed fragility belie their mass-production potential.

The Schafers produce their work under the moniker *studiomake*. This summer, the new graduates will pack their equipment into a shipping container bound for Bangkok, where they plan to build a house on a family plot while looking for residential and interiors commissions. Both say their crafts education will influence output. "Before you can have a great cast-concrete wall, your formwork has to be as beautiful as the form itself," David says of Im's slip casting. As for himself, he notes, "I hope my architecture expresses itself through the joinery. It's that magic point where materials come together."

Crafts expertise will also diversify *studiomake's* business model, as the Schafers plan to manufacture or license designs like those universal clamps. Product royalties should provide the couple with an extra, faster stream of revenue than a new architecture firm alone could generate. "Im and I always assumed we would practice together," David says, "and we saw this as an opportunity to transition into that studio." *David Sokol*

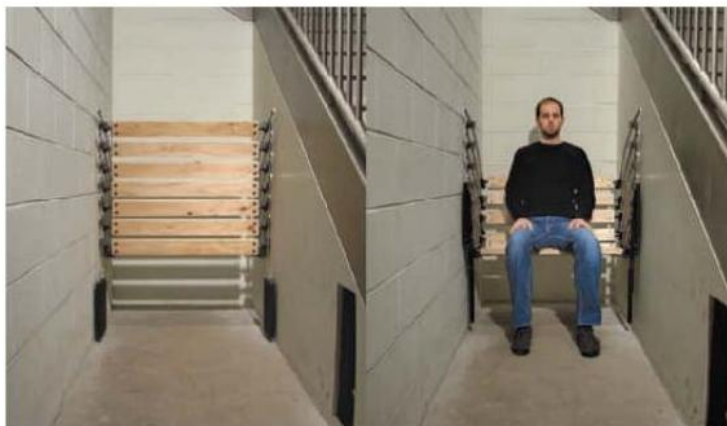



BUILDING VALUE SINCE 1906

**Green, prudent... and beautiful.**

ConturaSeries® Restroom Accessories: Seamless curvilinear monoform design with 27° arcs and complementary radiuses. 50%+ recycled stainless steel. Hygienic, universal recycled paper towel dispensing. Freedom from proprietary purchasing agreements. Lifecycle economies.

© 2008 Bobrick Washroom Equipment, Inc., 800.553.1600, [bobrick.com](http://bobrick.com)

CIRCLE 33



See us at AIA  
at Booth #4847!

## Amiran® anti-reflective glass. It actually helps retailers make bread.

With less than 1% reflection and true color rendition, there's no sweeter way to attract shoppers.

For years, SCHOTT Amiran® anti-reflective glass has been chosen by architects for the striking effect it brings to a building's design. But there's also a business side to Amiran® glass. More and more national retail chains are benefiting from its anti-reflective qualities. Amiran® glass transforms average neighborhood windows into showcases where shoppers get a scrumptious, crystal-clear view of the goods inside instead of reflections of themselves. And that means more sales. Amiran® is the best anti-reflective glass on the market, and since it's a low-iron glass, it has far less color distortion than other glasses. Amiran® anti-reflective glass is readily available and can be tempered or laminated, and is offered in insulated glass units as well. To find out more, or for a free demonstration sample, call 914-831-2243 or visit [www.us.schott.com/architecture](http://www.us.schott.com/architecture). Amiran® anti-reflective glass — it truly takes the cake.



Advanced Materials  
SCHOTT North America, Inc.  
Phone: 914-831-2200  
Fax: 914-831-2346  
E-mail: [amiran@us.schott.com](mailto:amiran@us.schott.com)

**SCHOTT**  
glass made of ideas

# Temporary openings in the city fabric tempt a critic to imagine **Critique**

By Michael Sorkin

Not long ago, a small midblock building was demolished not far from my office in SoHo. The excision was a revelation. Because of a sequence of low buildings in succeeding blocks, it was suddenly possible to look through a remarkable cut in the city that reconfigured the backs of buildings with their principal facades on the avenues into a long series of fronts. The space is like none other in New York in its proportions and architectonic character, the elegant austerity of the backs of buildings with ornamented facades making a place both lyrical and tough. Looking at it, it's easy to imagine further transformations, an accessible swath of public space stretching five blocks through the heart of town.

The uneven development of the city – its cycles of boom and bust – drive the production of innumerable morphological accidents, yielding spaces of unexpected character. Behind the building where I had my office several years ago was a parking lot, flanked by an old cobbled street. My building, 14 stories high, was on the eastern side of the space. The other sides were flanked by much lower structures – two-to-six stories – and the accidental plaza that resulted was of a rare proportion. It would have made a superb public space, easily captured and configured.

Unfortunately, nature and real estate abhor a vacuum: This space was eventually occupied by another

*Contributing editor Michael Sorkin directs the urban design program at City College of New York.*



**A midblock cut in SoHo offers a chance to rethink urban open space.**

14-story building designed to look like the twin of the first, and the plaza was lost forever. It will also be the fate of the demolished site that launched the view of the blocks-long cut here in SoHo to be refilled by a rising tower. These evanescent states are both part of the genius of the development system, poignant short-lived urban phenomena, and tragic exemplars of its limits. Caught in a situation that both produces and destroys its own greatness, we are too often unable to value this kind of revelatory anomaly until it is too late. Who can save it?

Part of the problem is that our planning is done with instruments too blunt and sluggish to properly accommodate unexpected or serendipitous circumstances, events we simply do not see. Landmarking can't save these spaces because, even though they may occur in historic districts, they are new, not part of an already legible pattern.

Nor can zoning, which is a system for managing the upper limits of use and density help. In economically robust times, everything presses this envelope.

## **An opportunity in D.C.**

The conundrum was made especially clear to me at a recent conference at Cornell organized to discuss the "NoMa" (North of Massachusetts Avenue) development in Washington, D.C. This is a concerted effort to build out a series of largely derelict blocks just north of Union Station and a stone's throw from the U.S. Capitol. The project has been in various stages of deal-making and development for 17 years and was propelled forward by an eminently sensible move: the creation of a new station in the district along the existing Metro line. This, coupled with a bike route of suburban reach and location next to the city's expanding downtown,

has created the nexus for a classic transit-oriented development.

Unfortunately, because of a lack of resources and municipal planning chops that are part of the disenfranchising legacy of the District's lack of home rule, the opportunity to plan creatively has been largely lost. The morphological possibilities of the site remain hemmed by the demands of the block pattern of the L'Enfant plan, the early-20th-century imposition of a citywide 130-foot height limit, a uniform FAR of 10, and the giant infrastructure of the railway as it fans out in approach to the station. The result is a plan that treats the literal blank slate of the site as an infill problem, with each developer taking its parcel to the physical limits and letting function be dictated by market forces. Thus, what was heading toward a reasonably harmonized mix of housing and offices was first skewed dramatically to offices and will now fall into a state of arrested development as the result of the national economic collapse.

The end state of this project will be seriously constrained by its failure to "capitalize" on the spatial possibilities opened up by its strong relationship to transportation and its rare anything-possible beginning state. And although all the actors involved diligently tithe the idea of a mixed-use, green, and design-intensive neighborhood, they all claim to be powerless to achieve anything beyond the alleged market constraints and planning default. Nevertheless, the D.C. planning department – which now has unusually enlightened leadership – continues

## Critique

to struggle to retrofit the unbuilt project with decent streetscapes and a set of secondary uses beyond mere retail. Stay tuned.

The irony of the accidental plaza suppressed in New York and the impossibility of producing any plaza, legible center, or sense of hierarchy and variety in Washington lies in the fact that while the founding physical conditions are opposites, the conceptual cage in which both sets of circumstances are locked is identical. Most of us can recognize decent urbanity when we see it, but we are constrained by the inefficiencies and limits of paradigms that are too narrow, too limited, too unimaginative.

Whether it's the treacherous reproduction of historic forms devolved from any meaningful context, the brutalizing celebration of capital's "creative" destruction as unassailable spirit guide, the slavish fetters of current fashion, or the devil-made-me-do-it obedience to the "as-of-right" city, the results too consistently fail to satisfy the basic tenets of good city life.

### Relying on the collective

Like many others, I am both wonderfully impressed by the energy of the new Obama administration and increasingly skeptical of the flow of



Developers have drawn up plans to build a mixed-use neighborhood in the NoMa area in Washington, D.C.

stimulus funds to the big banks and corporations whose ineptitude and greed got us into this mess. After years of seething at the Republican and "new" Democrat mantra of government incompetence and irrelevance, it is stunning to see how quickly the fat cats and indifferent libertarians have turned to the collectivity to pull the singed chestnuts of flaming capital out of the fire. And yet, the application of stimulus structurally repeats the old Republican fantasy of wealth's distribution: By making life agreeable for the rich, benefit will trickle down to those less empowered.

Our cities need a stimulus

package that works from the bottom up and – from us – a mighty stimulus package for the imagination. At NoMa, it is only the disenfranchised government, left without powerful enough administrative tools, without funds, and with influence too diminished, that can and should act to secure the genuinely highest and best use of the site. While build-out (when it eventually occurs) will certainly result in a greatly enhanced revenue stream, and while many argue that this money should return to the site in the form of improvements, this is both too late and contravenes the larger fiduciary obligations of the

public sector, which must always balance the competing claims of the citizenry as a whole. The tax-increment-financing model, and the Business Improvement District overlay, masquerade as a kind of community empowerment

**The network of tracks and rail yards (left, in red) north of Union Station constrain design possibilities but also offer great access to mass transit.**

but actually function to sustain the disproportionate enabling of the already empowered.

While I have deep skepticism about top-down approaches to planning and the too-frequent privileging of the formal over the social in dealing with questions of the city, there are many occasions in which government must decisively step in and set the agenda, the standard, and the solution. To invariably associate such intervention with the dystopian stylings of Robert Moses, Albert Speer, or Walt Disney, is to be stupid about the real obligations and possibilities of the collectivity. How tired I am of hearing endlessly about the so-called "public-private" model (as if there were any other in a democracy) when all it amounts to is a cover for the public's giving away the store, acting on the same grasping profit model as those corporations whose only idea of public interest is sucker rates on adjustable mortgages and credit cards.

Now that the government has moved so swiftly and insistently to plan the economy, has embraced its role in providing medical care for all, is ponying up untold billions to save Afghanistan, perhaps the same kind of bold responsibility might be taken for the mess at home. Bailing out General Motors is not exactly transit-oriented development. ■



**BEGA** sets the standard

## Fully Shielded Bollards

Wide Spread Light Distribution  
Halogen and Metal Halide Light Sources  
Two Sizes

[www.bega-us.com](http://www.bega-us.com)

805.684.0533

No. 149



# DURANAR

# DURANAR

**LIQUID OR POWDER, IT ALWAYS MAKES A LASTING IMPRESSION.**



SPECIFY AND TRUST PPG CERTIFIED APPLICATORS



When you want a project to make a statement or simply stand the test of time, turn to the unequalled performance of Durandar® Coatings. And you can rely on the members of the Certified Applicator Program to gain access to the best people, practices and products – including exclusive access to environmentally-friendly Durandar Powder Coatings. To learn more, call 1-888-PPG-IDEA. Or visit [www.ppgdurandar.com](http://www.ppgdurandar.com).



*IdeaScapes*<sup>TM</sup>  
Glass • Coatings • Paint

Durandar and PPG are registered trademarks and IdeaScapes is a trademark owned by PPG Industries, Inc.

PPG Industries, Inc., 151 Colfax Street, Springdale, PA 15144 1-888-PPG-IDEA [www.ppgideasces.com](http://www.ppgideasces.com)

CIRCLE 35

# Celebrating the profession, past and present

## Books



**Glenn Murcutt Architect,**  
by Kenneth Frampton, et al.  
Sydney, Australia: OI Editions, 2006,  
184 pages plus 8 folios, \$1,180.

This year's AIA gold medalist, 72-year-old Glenn Murcutt, has been securing his legacy as he reaches the twilight of his career. This stunning volume is a massive contribution to that effort. It is filled with artful photography and a suite of essays by Australian author David Malcu, architects Juhani Pallasmaa and Phil Harris, and critic Kenneth Frampton. Weighing in at more than 15 pounds and priced at over \$1,100 (only 1,000 numbered editions were printed), the folio – a main book and eight folders documenting seminal projects – is not intended for mass consumption and, in the present economic climate, feels suddenly anachronistic.

Murcutt's idiosyncrasies are well known: He refuses to build outside Australia, works as a sole practitioner and without a computer, and his architecture expresses a poetic approach to sustainability. Frampton's long-standing interests in tectonics

and regionalism make him a natural match for Murcutt, whom he calls "a builder's architect," in an extended essay that takes up the majority of the book. Drawing heavily on previous books by Philip Drew (1985, 1999) and Françoise Fromonot (2002), Frampton calmly and thoroughly explicates Murcutt's oeuvre, and the architect comes out looking like the exacting perfectionist he is famed to be.

But there is no friction here. There is no suggestion, as there is in Fromonot's more even-handed account, of a critique. Murcutt designs for an almost uniformly prosperous clientele in lush, remote locales, "away" from the bustling city where most of his clients live and, usually, have made their fortune. Though his recent work, sometimes with his wife, Wendy Lewin, and her firm, includes more public projects, a refusal to engage more endemic questions of urban planning or large-scale energy use is, in part, embedded in his practice. Pallasmaa writes in his woozily laudatory introduction, "Murcutt's determined principle to refuse commissions outside Australia and to operate largely on his own without computers, e-mail and mobile phones, sets a rare and welcome example. His world is the opposite of fictitiousness, simulation and virtual reality."

Is Murcutt resisting "fictitious-

ness," or creating his own fiction by shutting out the contemporary world? The inherent contradiction in this atavistic position is mirrored in the book itself. On its own terms, it is faultless, but when challenged, it appears as a confused statement: A spare-no-expense monument to austerity, it is, perhaps, a beautiful dead end. *Aleksandr Bierig*

**Architecture: Celebrating the Past, Designing the Future,** edited by Nancy Solomon. Washington, D.C.: Visual Reference Publications, 2008, 424 pages, \$95.

*Architecture: Celebrating the Past, Designing the Future* is a gigantic slap on the back of the profession, from the profession – a slap big enough to knock the wind out of an institution as big as the American Institute of Architects. The book catalogs by type, region, architect, and date of award, the work of the AIA's membership in every corner of the field, through every decade



of its more than 150-year history. This is the architectural coffee table book to end all coffee table books.

But is it any good? It just so happens, it is terrific, a great credit to its editor, Nancy Solomon. Perhaps her greatest accomplishment is the table of contents: It is like a chatty clubhouse packed with familiar critics and practitioners, from Thom Mayne to RECORD contributing editors Michael Sorkin to Robert Campbell to Sara Hart. Solomon gives each of the book's contributors the ball and lets him or her run with it. Even when the subject matter is marginal or obtuse (performance-based criteria, building information modeling, transformative management trends), the authors manage to put on a show. It's worth poking through the pages now and again just to see what everyone is up to.

Best of all was the decision to put Yale University's Karsten Harries, the polymath author of the book *The Ethical Function of Architecture* (MIT Press, 1998), in the leadoff position. His opening essay, "The Need for Architecture," furnishes a philosophical platform on which to set the whole hefty project, and it's a perfect example of Harries's neo-Existential logic: For all that's wrong with architecture, if we didn't have it, we would have nothing; and as we must have architecture, we must have good architecture. Ipso facto, we must have the AIA, and big books must be written about it and the work of its members. *Ian Volner*

## Books

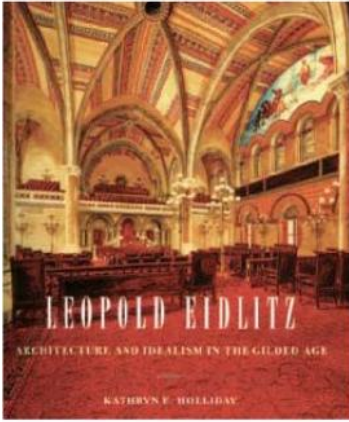

**Leopold Eidlitz: Architecture and Idealism in the Gilded Age**, by Kathryn E. Holliday. New York: W.W. Norton, 2008, 200 pages, \$55.

The extent of the contribution of Leopold Eidlitz, the 19th-century architect and theorist, to the architectural profession has not been generally recognized. In this new book, Kathryn Holliday brings

Eidlitz's work back into focus and, in the process, fills in certain gaps about his past. For example, her research shows that Eidlitz, born in Prague, studied building science at the Realschule there, then business for a short while at the Vienna Technical School, before arriving in New York in 1843 at the age of 20.

In his early days, Eidlitz worked in the office of Richard Upjohn, architect of Trinity Church (1846), before going on to design a number of churches, synagogues, and other buildings on his own. Eidlitz was also active in the American Institute of Architects after its founding in New York City in 1857. He took part in spirited debates, (e.g., with Henry van Brunt over the use of cast iron) but, as Holliday maintains, Eidlitz could be condescending to others. This may have been the reason for his quitting the AIA in 1868, during a time

when he was hoping to get the organization to back an architectural training program derived from the German polytechnic model, rather than the university-based one then being promulgated.

In 1868, Eidlitz finished the Gothic-Moorish style Temple Emanu-El at 43rd Street and Fifth Avenue, probably his most notable work (since razed). Yet the young critic Montgomery Schuyler thought the building wrong-headed owing to its Christian plan, and assumed the problem was that Eidlitz was not Jewish. As it turns out, not only was Eidlitz's partner, Henry Fernbach, Jewish, but so was Eidlitz, a fact that has eluded scholars for years. The confusion might have arisen due to Eidlitz's marriage by an Episcopalian minister to architect Cyrus L. Warner's daughter, who was descended from John Adams on her mother's side. At any rate, his dispute with Schuyler, unlike some of his other wranglings, was the beginning of a strong friendship

between the architect and critic.

Eidlitz wrote a series of architectural essays for various publications, including *RECORD*. When he was working on his book, *Nature and Function of Art, More Especially of Architecture*, published in 1881, he enlisted Schuyler as an editorial adviser. While the book was unusual for its exploration of philosophical aesthetics, including Hegelian thought, and his substantive argument for an organic architecture, even Schuyler could not straighten out Eidlitz's long-winded, convoluted sentences. Holliday seems to imply the book did not have the impact of later writings by Wright or Sullivan (both of whom were influenced by Eidlitz) because of the senior architect's contentious personality. Yet Wright and Sullivan wrote in a hortatory, passionate style, much easier to follow than Eidlitz's more Germanic construction.

Holliday's discussion of the New York State Capitol in Albany (1867–99) suggests that Eidlitz



To project  
world-class  
innovation,  
Alpolic is just  
what the doctor  
ordered.

may not have made many friends in the New York establishment because he, H.H. Richardson, and Frederick Law Olmsted took over the Albany job after Thomas Fuller's Classical pile, only two stories high, got mired in cost overruns and construction delays. Richard Morris Hunt and the AIA adamantly protested that it was improper for the team to go from being advisers to architects and that the new design, a Romanesque/Renaissance interpretation, was inappropriate. After Eidlitz's Gothic-style vault for the assembly chamber of the completed building developed a crack, a lower ceiling was installed that destroyed the room's expansive sense of space, Holliday argues that the incident permanently affected Eidlitz's reputation.

It is hard to keep your reputation or better yet, fame, if your buildings are torn down – a fate met by much of Eidlitz's work. Yet the architect's legacy may have been more extensive than we

might think. It came through his influence on a younger generation of critics and architects, such as Schuyler, John Root in Chicago, as well as Sullivan and Wright. While Eidlitz wasn't their sole influence or mentor, he helped cultivate the soil in which their own organic principles would flourish. *Suzanne Stephens*

**Architecture Between Spectacle and Use**, edited by Anthony Vidler. *Williamstown, Mass.: Sterling and Francine Clark Art Institute, 2008, 240 pages, \$25.*

This book offers about as succinct an exposition of recent architectural thought as one is likely to read anytime soon. It assembles essays presented at a conference convened at the Sterling and Francine Clark Art Institute in Massachusetts in the spring of 2005, under the direction of Anthony Vidler. Most every contributor is an architectural heavyweight, from Columbia University's Mark Wigley to

Mark Jarzombek of MIT and *The New Republic's* Sarah Williams Goldhagen. Each one delivers with sharp, readable articles on everything from the Sydney Opera House to the Renaissance iconography of fame. Better still, the individual pieces are agreeably brief, clear, and quick, yet rich in historical detail, with the result that the reader can take in at a glance a remarkably broad swath of the architectural landscape.

The clincher is that the book finds its theme at the central site of contemporary discourse: spectacle and architecture's complicity with it. As practice has moved away from oppositional naysay-ism on the one hand and historicist nostalgia on the other, architecture finds itself drawn further and further into an accelerating process of obedience and sensationalism, in which it loses its critical agency and its very capacity for meaning. Whether you call this the ascendancy of the image, as Hal Foster does in his essay, or



the triumph of media, as Beatriz Colomina does in hers, it means that architects are less and less masters of their own discipline.

Of course, there aren't too many surprises in the book – these are the people one constantly sees at a stream of symposia and panel discussions, and they say precisely the same things here that they do there. But if these are our oracles, we could do a lot worse, and we could hardly do better than to listen to them. *Ian Volner*

Why should healthcare facilities have to look bland, boring or clinical? Alpolic -- with its lightness, flexibility and vast selection of colors and finishes -- helps architects achieve a look on the outside to reflect the level of quality care provided within. And its affordability keeps the bottom line healthy, too. Alpolic. The perfect prescription for any healthcare building project. FOR MORE INFORMATION, CALL 1-800-422-7270 OR VISIT WWW.ALPOLIC-NORTHAMERICA.COM

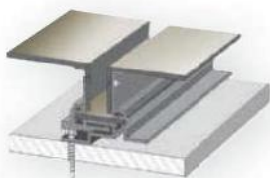

**PROJECT:** WINNIE PALMER HOSPITAL FOR WOMEN & BABIES, ORLANDO, FLORIDA  
**ARCHITECT:** JONATHAN BAILEY ASSOCIATES, DALLAS, TEXAS  
**FABRICATOR/INSTALLER:** KISTLER MCDUGAL CORPORATION, WOODSTOCK, GEORGIA  
**PRODUCT:** ALPOLIC MICA PLATINUM, & MEDIUM BRONZE METALLIC



ALPOLIC™ & ALPOLIC®/fr

MATERIALS

MITSUBISHI PLASTICS COMPOSITES AMERICA, INC.



"LUMIFLON" and "Alpolic" are trademarks owned by the U.S. Green Building Council and is used by permission. Mitsubishi Plastics Composites America, Inc. is a member of the U.S. Green Building Council and actively supports environmental responsibility.

CIRCLE 36

innovation • style • performance





## ACCESSORIZE YOUR DESIGNS.

**Alucobond®** can dress up even the most ambitious projects with elegant metal finishes and the ability to form almost any curve or texture.

To learn more about the world's favorite ACM for over 40 years, visit [AlucobondUSA.com](http://AlucobondUSA.com) or call 800.626.3365.

### **ALUCOBOND®**

Alucobond® is a registered trademark of Alcan Composites USA, Inc.  
©Alcan Composites 2009. All rights reserved.

**ALCAN COMPOSITES**

800.626.3365 | [AlucobondUSA.com](http://AlucobondUSA.com)

**CIRCLE 37**

# Sustainability assessments: an opportunity for new work

## Practice Matters

By B.J. Novitski

If the new federal stimulus package fulfills one of its promises – greening the built infrastructure in the United States – it will generate a huge amount of work for architects. Even while the depressed economy means fewer new construction projects, there will be meaningful work in building assessment and subsequent renovation, especially in the public sector.

Much of the energy analysis of existing buildings will relate to HVAC systems and therefore be more in the domain of engineers than architects. But owners may still see architects as their first point of contact for any work related to their facilities. And architects can deploy their skills in orchestrating complex projects by offering a comprehensive assessment, and hiring technical consultants when needed. In many cases, architectural renovations will be the logical outcome.

Though not as well known as LEED for New Construction, LEED for Existing Buildings: Operation & Maintenance (LEED-EBOM) is an apt framework for this kind of work. LEED-EBOM guides the evaluation of buildings that are at least two years old; certification demonstrates that they are at – or have been upgraded to – LEED levels of sustainability. Even though a building owner could go to an energy service company for mechanical and electrical upgrades, architects are better equipped to coordinate a multifaceted review of overall building performance. So says Muscoe Martin, AIA, principal of the

Philadelphia firm m2 Architecture. Martin serves on the U.S. Green Building Council's LEED Steering Committee and wrote a monograph on sustainable design published by the NCARB. He says, "All architects benefit from understanding what their clients need to do to maintain their buildings in an environmentally friendly manner. Considering ongoing operational practices during design can lead to better-performing green buildings."

Like other LEED programs, LEED-EBOM is divided into six major categories, each containing potential work for architects. These include designing green roofs and low-maintenance landscapes (Sustainable Sites); upgrading plumbing fixtures and developing water reuse schemes (Water Efficiency); increasing daylight and envelope insulation (Energy & Atmosphere); improving interior acoustics and specifying nontoxic furnishings (Materials & Resources); establishing nontoxic cleaning programs (Indoor Environmental Quality); and developing 3D models for facilities management (Innovation & Design). To be certified, existing buildings must first satisfy a few prerequisites, such as asbestos abatement and real-data evaluation, based on the U.S. Environmental Protection Agency's Energy Star rating system. Then LEED points are assigned for additional achievements to earn certification or Silver, Gold, or Platinum ratings. The program has been used by owners interested in improving the sustainability and healthy indoor environments of older buildings. It has also been applied to buildings that were designed green,



and deserve LEED recognition, but which predated the LEED program. Although minor renovations may be needed to upgrade the building sufficiently, LEED-EBOM is not intended for major renovation projects.

A few firms have already established sustainability assessments as a major portion of their work. One of these is the young, 14-person Re:Vision Architecture, also based in Philadelphia. About half its work is traditional – though sustainable – architectural design, and half is green building consulting. One of its projects, the Armstrong World Industries' corporate headquarters building 701, in Lancaster, Pennsylvania, earned a Platinum rating under LEED for Existing Buildings (LEED-EB, an earlier version of LEED-EBOM). Project manager William Craig says the firm nearly always uses LEED for its assessments. They also use Energy Star's free online portfolio manager

tool. It accepts as input actual performance data, such as utility bills, number of occupants, and so on. Then it compares the building to others of its type around the country and gives it a rating adjusted for climate.

For technical HVAC analysis, Re:Vision works with engineers, but Craig notes there is still a good deal architects can do regarding energy-consumption assessments. "We can

go through a building and, based on experience, understand where the thermal liabilities are, in a nonquantitative way. Also, we've begun to invest in diagnostic tools, such as a thermal camera and plug-in energy meters, which help us figure out how different appliances are performing. But we're still architects, generalists, and we know who to go to for specialized work." The firm also looks at a building's envelope and makes recommendations that could range from window replacement to passive solar design. He observes: "Sometimes the charge that comes from the owner at the beginning grows or changes as the result of our evaluation."

The Armstrong headquarters had a good head start when it underwent its LEED-EB evaluation. It was designed by Gensler to be green, with a narrow floor plate and light shelves contributing to ample daylighting, for instance, but it was completed

## Practice Matters

in 1998 before LEED had taken off, and it lacked the USGBC's seal of approval. When Re:Vision took a close look, they discovered a malfunction in the dehumidification system that was wasting 28,000 gallons of water a year. Even though its remediation did not count toward LEED-EB credits, it was a valuable discovery for resource conservation and for the owner's budget. The architects replaced existing plumbing fixtures for waterless urinals and dual-flush toilets, for which the project did receive LEED-EB credit. They also acquired wind power, established programs for green cleaning, carpooling, recycling, and education, and they fully recommissioned the building.

Craig believes LEED-EB ratings are somewhat less stringent than those for new construction. This may be to encourage wider participation. "With the enormous legacy of poorly performing buildings," he says, "even

modest improvements, if applied many, many times via an appealing green building rating system, will have a substantially larger impact than a few new Platinum buildings."

Another way architects can help owners improve their buildings is to advise about "right-sizing" facilities as companies grow, shrink, or otherwise change. This is the approach taken by RSP i-Space, a division of Minneapolis-based RSP Architects. Principal Mike Lyner, AIA, says that when their assessments include sustainability aspects, they often use LEED-EBOM as a framework. They evaluate a building's current condition and tell owners what to change for LEED certification. They compute costs, explain benefits, and help the owner plan any renovations.

"For our clients doing any improvements right now," Lyner observes, "this would be a good time to consider LEED. Even if they don't follow through with certification,

they can at least adopt some LEED-EB ideas." He notes that the Green Building Initiative's Green Globes software tool has an Environmental Assessment for Existing Commercial Buildings module.

Lyner's firm teams with engineers for HVAC assessments but still finds a good deal of architectural work, such as in replacing toxic materials and improving indoor-air quality. Some improvements require architectural renovations. Lyner suggests, for instance, "putting functions like photocopying and printing in a central location on each floor, and enclosing them in a room, so their fumes don't circulate."

Access to daylight also plays prominently in LEED-EBOM, and Lyner says a lot of his office-building clients are opting for "inboarding." This kind of renovation places hard-walled offices around the center of a building, leaving the windows visually accessible to more workers. He says: "People who have offices are less likely to be in them than those who don't, so with inboarding, they really

aren't as daylight deprived as those sitting at their desks all day." He cautions, though, that worker access to daylight has to be substantial to qualify for LEED credit. "Just because there's a sliver of light doesn't mean it's considered a window. The view through a window is as important as the light; it relates to mental and physical health as well as energy savings."

As a final service to clients, Lyner's firm sets up computer-aided facilities management (CAFM) files so the owner can continuously track data for future LEED recertification. Recently, RSP i-Space has begun delivering such data as 3D building information models (BIM) for better space visualizations and linking of data to model elements.

Both Re:Vision Architecture and RSP i-Space are already finding substantial work opportunities in assessing and improving the existing building stock. Other firms looking for recession-proof opportunities might do well to consider this kind of service to clients and tap into a mother lode of architectural work. ■



Mini DriveStar™ Flush Mount



Mini DriveStar™ Surface Mount



iLUME™ Surface Mount



Bali High Light Series



Arcade Louver Series

Enduring Metals =  
**FOREVER.**

Indoor + Outdoor =  
**ANYWHERE.**

BKSSL + Technology =  
**SUSTAINABLE.**

**B-K LIGHTING**  **TEKA ILLUMINATION**

www.bklighting.com • www.tekaillumination.com  
559.438.5800



## There's a lot to learn at the NC State College of Textiles.

With sail-like awnings bringing dramatic dimension to its facade, the internationally renowned College of Textiles is a fitting showcase for Firesist® HUV (High UV resistance). The brainchild of DAC Awnings, Inc., the graceful fabric structures perform beautifully in every way, offering excellent fire retardancy and protection from the elements. Firesist HUV, with its state-of-the-



art fiber, coloration and finishing technology creates a low-luster woven look and meets the most stringent codes. In a wide array of colors and with a five-year limited warranty, Firesist HUV is the fabric you can recommend with the highest degree of confidence.

For more information, contact Glen Raven customer service at 336.221.2211 or visit [www.glenraven.com/firesisthuv.com](http://www.glenraven.com/firesisthuv.com).



FIRE RETARDANT



RETAINS COLOR & STRENGTH



WATER RESISTANT



BOLD COLORS

**MEETS CALIFORNIA STATE FIRE MARSHAL TITLE 19  
REGISTRATION #F-36805**

Awning installation by DAC Awnings, Inc. in Raleigh, NC. Firesist® HUV and Glen Raven® are registered trademarks of Glen Raven, Inc.

# 銳

Refinement



G2508-01-180

Fusing the refinement of Japanese traditional arts with the sophistication of contemporary materials and technologies, ELMES architectural hardware displays an unwavering commitment to timeless beauty and impeccable function. Whether a subtle accent on a door, or the focal point of a room, ELMES architectural hardware always serves its purpose with unmatched refinement.

**ELMES**  
www.elmesworld.com

CIRCLE 40

**elmes**

# Snapshot



Miró Rivera Architects' public restroom appears as a work of sculpture set along Austin's lakeside trail.

## By Stephen Sharpe

Who really wants to visit a public restroom? Most flinch at the thought and squinch at the necessity. In Austin, Texas, however, along the city's much-loved and much-used Lady Bird Lake Hike and Bike Trail, people are drawn to the park's latest enhancement – a sculptural assemblage of upright, weathering steel panels that encircles essential comfort facilities.

More than merely a prosaic convenience, the restroom elicits curiosity even from those who don't have to go.

Miró Rivera Architects designed the project for the Trail Foundation, a nonprofit dedicated to protecting and improving the 10-mile path that loops a narrow stretch of Lady Bird Lake at the southern edge of downtown. Hundreds of runners, walkers, and bicyclists enjoy the trail daily. "How can you get as low-maintenance as possible?" asks Juan Miró, AIA, recalling the client's primary concern. He and partner Miguel Rivera, AIA, responded by specifying a single material –  $\frac{3}{4}$ -inch-thick steel panels – that will stand up to abuse and clean up with a water hose. Electricity is not required; natural light shines in at the perimeter of the roof, a steel disk held by brackets welded to the wall panels. Additional daylight and fresh air enter through slender gaps between the overlapping vertical panels. The architects' attention to detailing affords a welcome privacy, with no possibility of prying eyes or hands from the outside.

Pushing beyond the basic program of a 70-square-foot, enclosed and ADA-compliant restroom, Miró Rivera also wanted to create a piece of sculpture in the park. The 49 steel panels are anchored below grade in a rhythmic sequence of varying heights, coiling around the privy and providing its structural support. Entry is through an 840-pound plate of weathering steel that swings open and shut with surprising ease.

The local firm donated architectural services for the project, which, due to its unusual design, required many meetings with municipal officials over a two-year period. Built for just under \$130,000 (in hard construction costs), the restroom was completed in March 2008. ■

## An artful answer for the call to nature



# The only hand dryer that literally scrapes water from hands

The Dyson Airblade™ hand dryer works in just 12 seconds – scraping water from hands like a windshield wiper.

It's the fastest hand dryer and it cleans the air before blowing it onto hands, so it's hygienic, too. It also uses up to 80% less energy than warm air hand dryers.

To try the Dyson Airblade™ hand dryer  
visit **booth 2351** at the AIA show

Or for more information:

**1-888-DYSON-AB**

[www.dysonairblade.com](http://www.dysonairblade.com)

**dyson airblade**

The fastest, most hygienic hand dryer.





paint on surprise.

SW 6572 | RUBY SHADE  
from the colormix™ '09 forecast

Want to give your space a startling new twist? Want to evoke a feeling that's now and wow? With our colormix™ '09 forecast colors, you can achieve your vision. To order large size color samples and forecast color cards, go to [swcolorsamples.com](http://swcolorsamples.com) or contact your local Architectural or Designer Account Executive.



**SHERWIN  
WILLIAMS.**



# Roof Products, Inc. for Unique Roof Accessories.



## EQUIPMENT ACCESS CURB

Allows full access through the roof for easy removal or change-out of interior equipment. Ideal for water treatment plants, supermarkets and other facilities where cumbersome equipment is housed. After roofed in, the special structural curb is installed with reinforced, removable covers with attached lifting lugs.



## INTERIOR SKYLIGHT SAFETY SCREEN



OSHA approved! Interior Safety Screen mounting, instead of exterior mounting, eliminates additional jobsite labor because the screen is built into the RPI structural curb. Saves cost, provides clean exterior look, and offers maximum security against entry. Curb can be manufactured to any bar joist spacing, which eliminates reinforcing. RPI can also supply the skylights, or, just the screens to be mounted inside existing curbs.



... and, of course, your source for  
**Structural Curbs**  
for proper support



**ROOF PRODUCTS, INC.**

Chattanooga, TN • Phoenix, AZ

CALL TOLL FREE 1-800-262-6669

www.rpicurbs.com e-mail: rpicurbs@comcast.net

25 years

# FIRST in Innovation

SAFTI *FIRST* was the first to introduce advanced fire resistive glazing technology to the US market, and has been delivering innovative fire rated glazing and framing solutions for over 25 years. From fire rated windows and doors to custom-engineered wall systems, count on SAFTI *FIRST* to deliver quality products manufactured here in the USA.

Visit us at [www.safti.com](http://www.safti.com) to view our comprehensive line of fire rated glazing and framing systems.

**SuperLite** SAFTI*fire*  
FRAMING



USA MFG.



Visit us at  
Booth #4152  
at the AIA  
National  
Convention

Register online for  
"Designing with  
Fire Rated Glass"  
and receive 1 AIA  
LU/HSW credit

 **SAFTI***FIRST*  
FIRE RATED GLAZING SOLUTIONS

[www.safti.com](http://www.safti.com) 888.653.3333

Project: Sapphire Towers, San Diego, CA  
Architect: AVRP Studios  
General Contractor: Swinerton Builders  
Contract Glaziers: Starline Windows  
Product: SuperLite II-XL 45 IGU in SAFTI*fire* GPX Framing

CIRCLE 44



# we started with the elevator

Now Smoke Guard® offers  
smoke containment solutions  
for your entire project.

Our uniquely engineered  
products continue to address  
life safety challenges while  
minimizing structural impact  
on both renovation and new  
construction.



**SMOKE GUARD®** – we've got you covered



HUNTSMAN CANCER INSTITUTE • SALT LAKE CITY, UT • ARCHITECTURAL NEXUS



[www.smokeguard.com](http://www.smokeguard.com)

CIRCLE 45

smoke containment systems



# TERRAZZO FLOORING

Big Impact.  
Little Environmental Footprint.

Nonporous and mold-resistant, environmentally responsible, cost effective, beautiful, and healthy—the finish does not support microbes and moisture won't accumulate—Terrazzo is the perfect solution for a discerning public's buildings.

*Terrazzo—a floor that truly performs!*

Contact us at: **1.800.323.9736**

or visit us at: **WWW.NTMA.COM**

Please visit us at the AIA Expo - Booth #4876



**Terrazzo**  
A PERFORMING ART



Discriminating tastes demand only the best. Robinson Rock is natural stone cut thin, available in a breathtaking selection of natural colors and textures. Why settle when you can have the real thing?

IF YOU SETTLE FOR ANYTHING LESS THAN THE REAL THING YOU ARE JUST SETTLING.

## ROBINSON BRICK



A Division of General Shale Brick

800.477.9002 ■ [RobinsonBrick.com](http://RobinsonBrick.com)

See Us At AIA Booth #5446



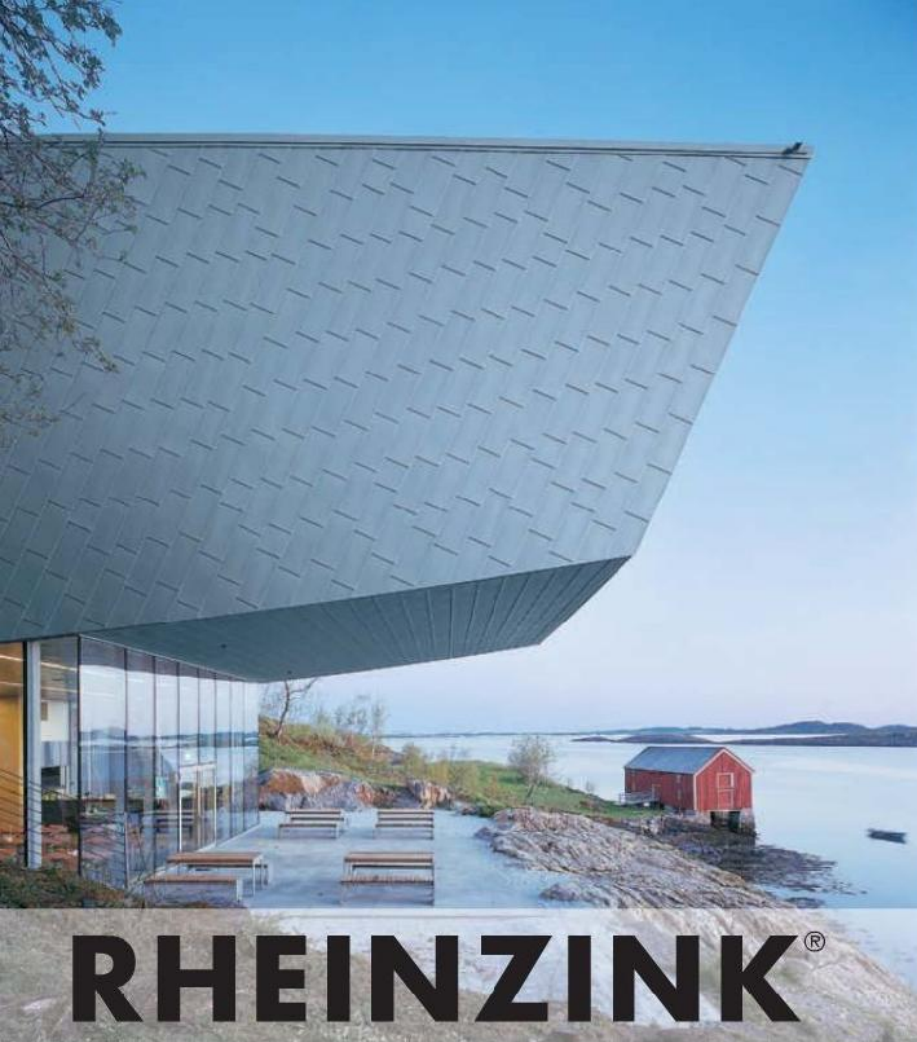

# RHEINZINK®

Dorothy House Hospice, Bradford on Avon, United Kingdom; RHEINZINK Pre-weathered<sup>PM</sup> Blue-Gray Double Lock Standing Seam

## RHEINZINK® - The Material with a Future

RHEINZINK® is an architectural-grade zinc with unmatched longevity and elegant appearance, making it an ideal building material. It complies with the strictest environmental standards and is 100% recyclable. For over 40 years, RHEINZINK® has been able to claim the

title 'sustainable' from 'cradle to grave'. Our material can be recycled infinitely without the loss of its chemical or physical properties. RHEINZINK® is available in Bright Rolled, Pre-weathered Blue-Gray and Pre-weathered Graphite-Gray.



Please visit us at  
**A. I. A.**  
San Francisco, CA  
April 30 - May 2  
Booth 1817

TE 210 3D : max 88 lbs.



TE 310 3D : max 132 lbs.



TE 510 3D : max 220 lbs.  
w/square cover plates



TE 510 3D MK : max 220 lbs.  
w/cable fittings for power



TE 525 3D : max 220 lbs.  
all-stainless steel hinge



TE 630 3D : max 440 lbs.



# TECTUS®

*concealed hinges  
you don't need to hide.*

## 3 Dimensions

easily adjustable in  
so your flush doors can be  
installed and maintained

**absolutely  
perfectly  
evenly  
flush**

The TECTUS® system provides  
solutions with load capacities  
**from 88 lbs to 440 lbs**  
with only two hinges installed

available in a wide selection of  
architectural-quality finishes that  
won't clash with the clean design  
you set out to achieve.

precision-engineered and  
made in Germany.



 **SIMONSWERK**  
TECTUS®

available in the US through

**index-d™**

[ comprehensive hardware solutions ]

# GAP

## MINDING THE

FOR ALL OF ARCHITECTURE'S PROMISE OF INNOVATION AND EMPATHY, THE PROFESSION SUFFERS A LACK OF DIVERSITY THAT COULD NULLIFY THOSE CLAIMS. THE GAP BETWEEN THE PERCENTAGE OF LICENSED AFRICAN-AMERICAN ARCHITECTS AND THE PROPORTION OF BLACKS IN AMERICA'S OVERALL POPULATION HAS BEEN ESPECIALLY PERSISTENT. This historic underrepresentation predates the inclusion of Asian-Americans and Latinos in the national discussion of ethnic diversity, yet talented individuals from these two groups have had more success in infiltrating architecture, overall or regionally, than African-Americans.

The election of Barack Obama to the presidency makes this a timely moment to consider architecture's diversity barrier – which appears to be more stubbornly resistant to change than even America's highest office. The comparison is all the more compelling given Obama's childhood ambition: On the campaign trail in Salem, Oregon, last year, he told voters that he had wanted to become an architect; in the first days of his presidency, he reiterated that past aspiration to a group of seven-year-olds attending the Capital

City Public Charter School in Washington, D.C.

Obama may have felt compelled to serve the public in a broader way than architecture seemed to allow, or perhaps other interests guided his professional trajectory in a different direction. In the following stories, RECORD contemplates the overarching obstacles that continue to impede African-American representation in architecture. We also highlight efforts to strike them down, in particular Philadelphia's Charter High School of Architecture and Design, as well as sister schools and mentorship programs that expose younger students to the profession. Also featured are the design proposals for the forthcoming National Museum of African American History and Culture building, which energizes a long-standing dialogue that considers whether African-American culture can reinvent architecture as it has music, the fine arts, and literature. These are but snapshots into the whole breadth of diversity in architecture, and we anticipate future coverage enthusiastically. *David Sokol*

 This month, RECORD launches a new section of our Web site covering diversity in the architecture profession at [architecturalrecord.com/diversity](http://architecturalrecord.com/diversity).



# BREAKTHROUGHS

Two writers survey the ongoing dearth of African-American architects in the profession

## Architecture's Evolving Complexion

BY G. CHAISE NUNNALLY

Architecture still suffers from a paucity of African-American practitioners. The statistic that civil rights activist Whitney Young famously cited at the 1968 American Institute of Architects convention – that only 1 percent of registered architects were African-American – has ticked upward only slightly in the four decades since. Today's percentage is fewer than half the number of blacks in medicine (3.7 percent) and law (3.9 percent).

Black architects who have prospered in the field don't attribute this enduring gap to any single factor. "There are many reasons," says Phil Freelon, FAIA, principal of Durham, North Carolina-based The Freelon Group. "They have to do with visibility, access to quality primary- and secondary-school education, the rigor of architecture school curricula, the attrition that occurs as a result of this, and other barriers related to internship and licensure that make it difficult for anyone to advance in our profession."

For architects such as Keith Marrero, AIA, who owns a small, successful, minority firm in downtown Greenville, South Carolina, but doesn't enjoy the same wide renown as Freelon, dialogue about the scarcity of blacks in the profession takes on a more dire tone. "In architecture, there's not enough opportunity for job growth, responsibility, or promotion in white firms," he says.

Yet even while the number of black architects remains largely unchanged, other aspects of the profession have evolved to the benefit of many black practitioners, especially increasing opportunities in the private sector.

For Moody Nolan, the largest black-owned architecture firm in the U.S., with 162 employees, winning the Ohio Environmental Protection Agency headquarters, completed in 1990, marked its transition to private-sector work. When the state opted to use a private developer for the project, Moody was selected to team with the developer because of his firm's experience with public facilities and his status as a minority owner. The fortuitous teaming led to a 20-year working relationship with the private developer. And principal Curtis Moody, FAIA, credits the partnership to the developer's

recognizing that the capabilities of Moody Nolan were comparable or superior to nonminority firms. From there, Moody says, "We could start making a case in the private sector that we were trusted by this group. You get work not because you meet a certain diversity percentage, but because you're qualified."

Donald Stull, FAIA, who founded Boston-based Stull and Lee in 1966, says he has noticed the shift more recently – only in the past 10 years or so. And even then, "It came through a slow adjustment of mind-sets in corporate America." As with Moody Nolan, Stull says success depends on "champions." Among these patrons, he cites the late Edward Logue as the advocate behind significant public projects, as well as Robert Weinberg, as a private-sector supporter. Weinberg reintroduced Stull to The Beacon Companies, which then hired Stull and Lee for the interior fit-out of Boston's historic South Station Headhouse in 1986, and Weinberg continued engaging the firm in airport retail master planning after he founded his own company, MarketPlace Development, in 1992.

The word-of-mouth marketing and networking that characterize architecture in general still present a barrier to minority firms operating in the private arena. "It's who you know," Moody says, "and the majority of people building are not minority." Stull concurs: "It's related to the social circles one moves in, and if that's limited, then capability is limited."

Even so, progress has been great enough that some younger African-American architects may take a postracial view of patronage. "After going to graduate school and being in those circles, it seemed natural to submit to competitions and to get jobs with private clients," says Yolande Daniels, AIA, cofounder of Studio SUMO, a RECORD 2006 Design Vanguard firm. Two Studio SUMO projects, the museum interior of Mocada, in Brooklyn, New York, and an affordable housing development in Miami, Florida, both involved public funding and actively sought out African-American architects. Yet Daniels and partner Sunil Bald's recent commissions, such as a renovation of a duplex apartment in New York City completed in 2008, have

# AND OBSTACLES



## PORTRAITS OF OUR PROFESSION

A representative sampling of African-American architectural leadership (from top row, left to right)

**TOP ROW:** Isham Baker, FAIA; Max Bond, FAIA; Gary Bowden, FAIA; Leon Bridges, FAIA; Stanford Britt, FAIA; Charles Cassell, FAIA

**SECOND ROW:** Robert Coles, FAIA; Peter Cook, AIA; Yolande Daniels, AIA; Paul Devroux, FAIA; Kathy Dixon, AIA; Richard Dozier, AIA;

Darrell Fitzgerald, FAIA

**THIRD ROW:** Phillip Freelon, FAIA; Harvey Gantt, FAIA; Mario Gooden, AIA; Bradford Grant, AIA; Maxine Griffith; Rainy Hamilton, Jr., AIA; Henry Hardnett, FAIA

**FOURTH ROW:** Wesley Henderson, AIA; Ricardo Herring, FAIA;

Major Holland, FAIA; Diane Hoskins, FAIA; Ralph Jackson, FAIA; Phil Craig Johnson, FAIA; Donald King, FAIA

**FIFTH ROW:** Ted Landsmark, Assoc. AIA; David Lee, FAIA; Frank Christopher Lee, FAIA; Kermit Lee, Jr., FAIA; Steven Lewis, AIA;

Keith Marrero, AIA; Mortimer Marshall, FAIA

**SIXTH ROW:** Charles McAfee, FAIA; Cheryl McAfee-Duncan, AIA; Cheryl McAfee-Mitchell, FAIA; Melvin Mitchell, FAIA; Kevin Montgomery, FAIA; Curtis Moody, FAIA; G. Chaise Nunnally



## PORTRAITS OF OUR PROFESSION

A representative sampling of African-American architectural leadership (from top row, left to right)

**TOP ROW:** Michaele Pride, AIA; Marshall Purnell, FAIA; Harry Robinson III, FAIA

**SECOND ROW:** Howard Sims, FAIA; Norma Sklarek, FAIA; William Stanley III, FAIA

**THIRD ROW:** Donald Stull, FAIA; Sharon Sutton, FAIA;

Jack Travis, FAIA

**FOURTH ROW:** Roberta Washington, FAIA; Darrell Williams, FAIA; Allison Williams, FAIA

**FIFTH ROW:** Michael Willis, FAIA; Professor Mabel Wilson; Rodner Wright, AIA

come from the publications and referrals that fuel all young design firms.

As adept design problem-solvers, architects must dedicate the same intellectual and creative energy to solving the profession's enduring diversity problem. Indeed, individuals and institutional bodies are trying to do so at every stage in the career cycle. Earlier this year, Gensler established its African-American Internship & Scholarship. Columbia University supports professor Mabel Wilson's HBCU Design Leadership Program, which was launched in fall 2008 by sending Mario Gooden, AIA, then on Yale's faculty, to teach Tuskegee

University architecture students. Firms such as Detroit-based Hamilton Andersen, participate in any number of career fairs and fellowship endowments to expose black youths to architecture. And then there's the AIA itself, which has adopted a multiyear action plan for diversifying the profession.

Even so, the challenge remains for the profession to move toward broader inclusion of black practitioners in its ranks. And to fully appreciate why such a move is imperative, it's worth understanding that without a confluence of diverse points of view, both architects and clients suffer from a lack of valuable insight. ■

## Prescriptions for Change

BY TED LANDSMARK

**M**ax Bond, FAIA, the dean of African-American architects, passed away in February. Yet over the span of his distinguished 51-year-long career, the architectural profession has changed little for architects of color. We must do better. We are losing ground in preparing to serve the more diverse clients who will be seeking design services in the future.

Licensed African-American architects have risen from 1 percent 35 years ago, when Bond entered the profession, to about 1.7 percent today, with all architects of color amounting to fewer than 7 percent of those currently in practice. And as the late Steve Klimt, FAIA, stated in *AIArchitect*, "The number of black students at accredited schools declined between 1991 and 2003, and the number of graduates over that period actually dropped from 214 to 156, or 27 percent." Klimt also showed that the black faculty in architecture schools dropped from 6.2 percent in 1997 to 5.2 percent in 2003. These are not good portents.

The publication of reports and studies, including the AIA's own 2005 investigation, have only now produced a major national institutional initiative to diversify the architectural profession. It has taken a half-dozen years for the AIA, NCARB, NAAB, and related organizations to agree on methods of data tracking that will enable us to know who enters and graduates from our schools, and who persists to professional licensure. Lawyers and doctors put such tracking systems in place decades ago. Apparently, neither the abstract rationales nor

*Ted Landsmark is president of Boston Architectural College.*

“Neither the abstract rationales nor the specific methods for increasing diversity are compelling enough to have produced significant progress in the design professions.” *Ted Landsmark*

the specific methods for increasing diversity are compelling enough to have produced significant progress in the design professions.

There are steps forward. In 2008, Marshall Purnell, FAIA, completed a path-breaking year as AIA president, and Phil Freelon, FAIA, was selected as *Contract* magazine's designer of the year. This year, six design teams competed for the \$500 million National Museum of African American History and Culture in Washington, D.C., and half included outstanding African-American firms. Thirty-four percent of new African-American architects are women, boosting the total to about 230. But at this pace, we would need to triple design school graduates of color within the next five years to achieve another 1 percent increase in licensed professionals by 2020.

Indeed, major challenges persist. Diminished university commitments have weakened about half of the programs at historically black colleges and universities, which have educated 40 percent of all black architects and designers. Nationally, minority design students too often don't graduate, and don't become licensed. There is little collaboration with better-integrated disciplines such as engineering, business, law, and construction, where other aspiring professionals could be engaged in design.

Architecture's business model amplifies homogeneity. Unlike medicine and law, our firms too often don't hire interns with an intention of employing them for the long term, thus discouraging African-American career aspirants from staying in design.

So what should we do when our national leadership and worldwide client base have shifted more than we have? Will we become a boutique

profession out of touch with client needs and the contributions made by a wider range of designers? And will the weak economy re-create early-1990s conditions, which drove talent out of that homogeneous labor pool, creating significant management problems in many firms today?

Kliment's insightful *AIArchitect* essay made 25 recommendations for increasing diversity, from publicizing black architects and improving educational outcomes and career planning to confronting residual racism, building patronage, and expanding students' knowledge of alternate design-related careers.

Schools, publications, and awards also can broadcast the pragmatic functions of architecture to diverse communities. Here, one notes the outstanding community-based work of Architects for Humanity, Public Architecture, Habitat for Humanity, AIAS Freedom by Design, and the Detroit/Mercy, Auburn, Tulane, and University of Arkansas community design centers. Expanding this emphasis would nurture new designers to be as proficient in public service as in the use of technical innovations. Community-based activities also expose impressionable young people to architecture and design as attractive and rewarding professions.

This list goes on. In diversity meetings, we can call less attention

**For Edward Logue, Stull and Lee designed the Brooklyn mixed-use development Rutland Road with Perkins+Will (top). Moody Nolan designed Ohio EPA headquarters (middle). Studio SUMO's duplex for Briton Matthew Leaney is in New York City (bottom).**

to negative narratives and place a greater emphasis on sharing information on successful practices for broadening ethnic representation; we can collaborate across disciplines to develop diversity interventions that work; we can collaborate with schools in urban areas where students and faculty might share resources; we can support the design offerings at charter schools and community colleges serving minority populations.

Perhaps most important, we need to provide sufficient resources for AIA staff to coordinate and publicize best practices in recruitment,

promotion, retention, and human-resources management, and we need for our organizations to rigorously support and assess the outcomes of national and local initiatives.

Jazz and hip-hop emerged from communities of color. Expanding these expressive inclinations toward education and practice in spatial design ought not to be a leap, as long as the entire profession is committed to being more inclusive. We need to engage actively with the polyglot society we will be serving in the years to come. If not now, when? ■



# MARRYING CONTENT

The National Museum of African American History and Culture finalists present competing expressions of the black experience through architecture

BY DAVID SOKOL

**A** culminating chapter in a century-long push to create a black-history museum on the National Mall in Washington, D.C., began April 14, when National Museum of African American History and Culture (AAHC) director Lonnie Bunch announced that the team Freelon Adjaye Bond and SmithGroup had been selected to design the museum's new building at the base of the Washington Monument. The \$500 million project will be completed in 2015.

Largely conceived by Tanzanian-born, London-based architect David Adjaye, Freelon Adjaye Bond's winning proposal (right) features a plinth with broad overhangs topped by a volume whose patterned bronze skin tapers inward twice. Fastidiously placed windows will offer museumgoers curated views of the National Mall, and incisions in this upper volume's roof will shower the interior with daylight. Yet this design does not represent a literal architectural expression of black identity, and the five other finalists' proposals similarly avoid such symbolism. Interestingly, the designs for the most important building commission for the African-American community intimates that Modernism is the architectural vocabulary of African-Americans.

Indeed, this sextet of architectural designs is more evocative than explicit. In plan, the entry plaza and building volume of the entry by Foster + Partners and URS Group (page 83) suggest an infinity sign, symbolizing the continual writing of African-American history and the immutability of the Smithsonian as a repository of national treasures. In section, the design becomes more complex: The plaza, which visitors would enter from 15th Street, is submerged; what seemed to be an elliptical building volume in fact winds upward, terminating in an expansive glass plane facing the Mall's obelisk. This vertical articulation smartly separates museumgoers from perimeter car traffic. It also handily represents the ascent from darkness – in other words, slavery – into light, and the exhibition content would follow suit closely.

Foster's scheme is reminiscent of the tightly controlled circulation and signature feature of Elizabeth Diller and Ricardo Scofidio's 1989–90 concept for Slow House, if at the scale of a national icon. Today, Diller Scofidio + Renfro's museum entry (page 84) recalls Boston's Institute of Contemporary Art and the Blur Building. The proposed building is cloaked

in a multistory glass sheath sliced open in its southwestern corner, with two grandly curving glass arches punctuating the large entryway. Most museum galleries are located in the limestone structure enveloped in the transparent skin, with an additional wood-clad interior gallery nestled within the core.

The museum proposed by

Freelon Adjaye Bond – comprising The Freelon Group, Adjaye Associates, and Davis Brody Bond – may be the most contextual of the six finalists' designs; the rhythm of the Freelon Adjaye Bond design

**FREELON ADJAYE BOND / SMITHGROUP**



# TO CONTAINER



## FOSTER + PARTNERS / URS GROUP

aligns it with the more opaque National Museum of American History and other Classical-style buildings lining the northern edge of the National Mall. The joint venture between Devroux + Purnell and Pei Cobb Freed & Partners (page 84) also strives for harmony with the other institutions along Constitution Avenue by proposing a rectilinear frame that represents the maximum building envelope permitted by the museum's programming document. Their scheme provides a counterpoint to that straightforward move, however, by filling the armature with a sinuous, glazed volume clad in wood louvers.

The collaboration of Moody Nolan and Antoine Predock

Architect (page 86) shows the sculptural imprint of Predock, winner of the 2006 AIA Gold Medal. In this case, a series of shardlike masses stack upward in a variety of gentle angles, as if emerging from the earth. Planted surfaces, as well as the proposed construction of adjacent wetlands, underscore the geological quality of the composition. Yet the Moody Nolan/Predock entry also seeks inspiration from African history, including the legacy of slavery. The patterns on rain screens refer to Yoruban art, for example, and an amphitheater carved into one side of the pile evokes the outdoor gathering spaces common to African villages. Carbon-fiber walkways crisscrossing an upper-story "improvisation space" take their shape from ships' hulls (a replica slave ship was intended to form the centerpiece of the winning

building's permanent exhibition).

Moshe Safdie, FAIA, whose studio created its AAHC proposal with Washington, D.C.-based Sulton Campbell Britt (page 86), also stresses two points. Standing four stories above grade, and sliced diagonally on one side, this design promises a smaller footprint. "I felt a lot of people would say it's better not to build there," Safdie says of the 5-acre building site, one of only three excepted from the building moratorium imposed on the National Mall. In addition to its small scale, the contest entry envisions links between Africa and the museum experience through the nomenclature employed throughout. The design team has named the entryway of the museum for that continent, for example, and visitors would then descend a ramp to the so-called "Door of No Return" – a direct reference to coastal launch points in the Atlantic slave trade.

Yet even these attempts are tentative. "I don't feel that architects should speak too much about the messages intended – I don't like making it too overt," Safdie says. "I think the more you leave to interpretation and subjective readings, the richer the experience." He adds, though, "I don't mind naming the 'Door of No Return' or saying Freedom Bridge or using Memorial, because that's what they are."

Safdie isn't alone in his preference for suppressing narrative. Like the Devroux + Purnell and Pei Cobb Freed design, the wood lattice-work that would be installed in the entrance of the Moshe Safdie and Sulton Campbell Britt proposal could be compared to a basket or bamboo thatching, or a jungle ecosystem. Meanwhile, the circulation, similar

to the Foster design, lends itself to a reading of African-American history as an emergence from abjectness to equality and achievement. Similar interpretations are suggested in all six finalist designs, but they are mainly apparent: to viewers looking for them.

Mabel Wilson, the Columbia professor who acted as a cultural consultant to Diller Scofidio + Renfro, says that that design team preferred abstraction over literal references; indeed, the buoyant, seemingly levitating limestone structure they envisioned suits Bunch's hope for a museum that expresses "resilience and optimism, [that] gives you a sense of a historic struggle but also is about joy." Freelon Adjaye Bond's zigzagging bronze sheath inverts the geometry of the Washington Monument, to be sure, but that submission's explanatory text attributes the shape to the crowns topping Yoruban sculptural figures. "African-American artistic expression often has been very figurative for a number of reasons, historically," says Bradford Grant, AIA, director of Howard University's School of Architecture and Design, "but at the same time, we've always embedded codes in our art, such as hiding double meanings in music." Examining the group shortly after their unveiling, he sums up the designs as Modernist concepts "refined to relate to our experience."

The client would have allowed a more literal representation of African heritage than the finalists' intimations of it. In October 2007, the Smithsonian selected The Freelon Group and Davis Brody Bond to execute the programming for the AAHC. Speaking about the programming, Philip Freelon, FAIA, says, "The building ought to be part

of the story, it ought to support and go hand in hand with the exhibition design, as opposed to just being an envelope for exhibitions." The 1,300-page programming document that the two firms completed in January asserts a link between architecture and the AAHC mission. To those ends, it also includes a small portion of unprogrammed space because, Freelon notes, "improvisation and creativity are part of African-American culture, whether it's in music or elsewhere – we wanted to allow a certain spirit that is free." But he also notes, "We were very careful to stay out of the design realm."

When Freelon Adjaye Bond

**DEVROUAX + PURNELL ARCHITECTS AND PEI COBB FREED & PARTNERS ARCHITECTS**



starts to design this summer, the product of that undertaking may more strongly underscore an African aesthetic. That the six finalist designs do not do so, though, is in itself highly suggestive.

The recurrence of abstraction in the six designs is a counterpoint to the last addition to the National Mall, the National Museum of the American Indian, which opened in September 2004. That building serves as a reminder of a contentious process that culminated in the dismissal of its lead conceptual designer, Canadian architect Douglas Cardinal, in 1998. Myriad consultants, most notably Jones & Jones and Polshek Partnership, shouldered the execution of the design, and multiple sources have said that the AAHC jury will determine a winner partly according to the visible demonstration of teamwork.



Perhaps more important, Cardinal has been quoted as calling the ultimate version of the National Museum of the American Indian a "forgery." The building relates poorly to the National Mall, putting a blank face to America's front lawn, and in a similar vein, the excessive entry rotunda goes largely unused. Its organic curves and textures, too, have little to do with surrounding buildings. The result is an aesthetic curiosity that feels both foreign and tenaciously institutional.

The AAHC designs ostensibly reject the figurative architecture of the National Museum of the American Indian as a feasible expression for the African-American experience. They also tap into a perennial concern about black architecture. That conversation is wide-ranging, engaging historical research by Richard Dozier, AIA, head of Tuskegee University's Department of Architecture and Construction Science, and of Melvin Mitchell, FAIA, and the practice of contemporary architect Jack Travis, FAIA. Despite this breadth of investigation, the underlying question is the same:

**DILLER SCOFIDIO + RENFRO IN ASSOCIATION WITH KLING STUBBINS**

whether there is or can be an architecture that, as Mitchell states in the preface of his book, *The Crisis of the African-American Architect*, "reflects the spiritualism, dynamism, improvisational complexity, rich uses of color, strong sensuous rhythm, and the West African roots of African-American culture."

"An African-American aesthetic has been debated for quite some time," says Moody Nolan's Curt Moody, FAIA. "The problem is, nowhere is there a building that we would all point to as an iconic African-American building. But we all have principles we believe ought to be captured in that building."

Architects like Freelon have tried realizing these principles. In March, The Freelon Group was selected to design Atlanta's Center for Civil and Human Rights. Speaking about that commission, Freelon refers to related projects, which include the Reginald F. Lewis Museum

IMAGES: COURTESY DILLER SCOFIDIO + RENFRO IN ASSOCIATION WITH KLING STUBBINS (TOP TWO); DEVROUAX + PURNELL ARCHITECTS AND PEI COBB FREED & PARTNERS ARCHITECTS (BOTTOM TWO)

# IMAGINE THE POSSIBILITIES

with E. Dillon's Reflective Series Architectural Concrete Masonry

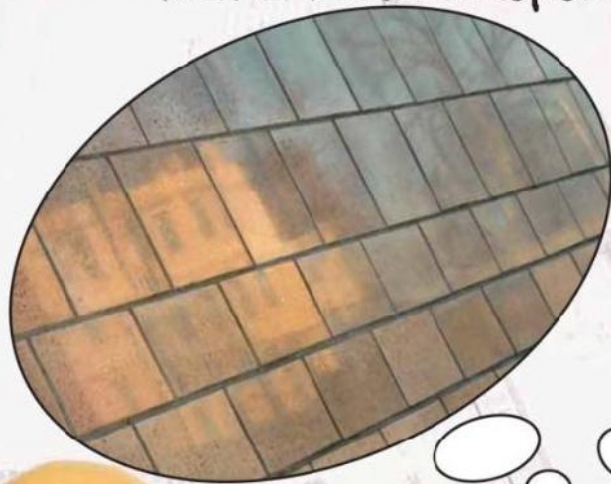

**DILLON**  
& COMPANY™

For more information on our complete line of Architectural Concrete Masonry or to locate a dealer near you please call (800) 234-8970

AN AMERICAN OWNED COMPANY SINCE 1868



of Maryland African American History and Culture in Baltimore and the Harvey B. Gantt Center for African American Arts and Culture forthcoming in Charlotte, which feature multiple rhythms or a vibrant color palette. "There are going to be elements that relate to the African-American experience," Freelon says of these designs, noting that the work is both the result of clients' wishes and his personal artistic proclivities as an African-American.

If any architect has the potential to do for American architecture what Buddy Bolden or Louis Armstrong did for American music, James Baldwin for literature, or

Willi Smith for fashion, it would be Travis. His contributions to African-American architecture include consultation on projects like the Kalahari Condominiums in New York City, identifying 10 points of black cultural design, and assisting Grant in institutionalizing those principles as part of Howard University's architecture curriculum. Travis also served as a cultural adviser to the Moody Nolan/Predock team. "There's so much rich black cultural expression in so many other facets of our lives that something has to happen in the design of the environment," he says. Yet Travis also concedes, "To make something that tries to be African-American is almost doomed to failure from the beginning. I think an African-American museum has to have roots in an African aesthetic. You have to go back before you go forward."

**MOSHE SAFDIE AND ASSOCIATES AND SULTON CAMPBELL BRITT**



This may explain why most finalists referred to African precedent in abstracted ways, and subsumed those allusions within Modernist approaches. The universal lack of an African-American expression, though, could lend credence to Mitchell's thesis – that is, Modernism itself, from Pablo Picasso's African Period to the sculptural, late-career compositions of Le Corbusier, has roots in African art, even though the few African-American architects working during Modernism's birth deferred to the more dominant Beaux-Arts mode.

Mitchell's understanding of Modernism as ethnically all-encompassing recalls Bunch's own opinion of what the AAHC is supposed to accomplish as a museum. "In some ways, the African-American story is the quintessential American story: It is a story that tells us what liberty means in stark juxtaposition to slavery, it tells us about the role of public education," he says. "It is another way into the American experience."

The inextricable link between America and African-Americans is strongly analogous to Mitchell's idea of Modernism as a crucible of cultural influences, and of Modernist

**MOODY NOLAN / ANTOINE PREDOCK ARCHITECT**

architectural vocabulary as being as black as it is white. That may be why other impassioned observers of the museum competition have been less focused on the symbolic import of the finalist designs and more intent on the color of the winner's skin. In early April, for example, National Organization of Minority Architects president Steven Lewis, AIA, submitted an op-ed piece to *The Washington Post* that admits, "I would be less than honest if I were to say that there is not a sense of nervousness over the prospect of someone other than a black architect landing this commission." Lewis's wish for black architects, so often unheralded even today, to grab a larger piece of the pie was granted. But the AAHC decision does not mean that Freelon Adjaye Bond will invent an all-new African-American architecture. Evidently, the Modernist approach is fundamental to it already. ■

Read further analysis of the winner selection at our Web site, [architecturalrecord.com/diversity](http://architecturalrecord.com/diversity).

IMAGES: COURTESY MOODY NOLAN/ANTOINE PREDOCK ARCHITECT (TOP TWO); MOSHE SAFDIE AND ASSOCIATES (BOTTOM TWO)

# The Leader in Opening Glass Walls



Srygley Office Building Fayetteville, Arkansas  
Marlon Blackwell Architects

"NanaWall allows for a dynamic and elegant transition between inside and out."

Marlon Blackwell, Architect



## Open the door to exhilaration

Enjoy the best of both worlds: a room with a view that opens to the outdoors yet gives you the peace of mind only a weather resistant NanaWall provides.



NanaWall  
Green Design

800.873.5673

[nanawall.com](http://nanawall.com)

NanaWall®  
Grand Transformations

## CHAD CROSS SECTION

CHAD sophomore, junior, and senior students (from left to right): Lauren Pinkney, William Bond, Edward Portley III, Yunas Hassani, Annie Wong, Malcolm Gary, Matthew Liggeons-Jones, Janelle Johnson.



# THE DIVERSITY PIPELINE



Across the country, design-centered high schools are helping increase the number of African-Americans and Latinos in the field

BY JAMES MURDOCK

PHOTOGRAPHY BY RYAN DONNELL

Shortly after the 9:30 a.m. bell sounds, the 24 students in Michael Reingold's Drawing Foundations class begin sketching a classmate who has gamely agreed to model for them, an off-white sheet draped over her blue top and khaki pants. The week's lesson is on gesture, so Reingold encourages pupils to make as few pencil lines as possible before using charcoal to block out shape and shadow. It's a commonplace assignment in an introductory college art studio — except that these students are 14 and 15 years old, freshmen at the Charter High School of Architecture and Design (CHAD) in Philadelphia.

It was in Reingold's class that Ryan Brown had an epiphany about conveying motion with lines. "The opening of a line has to be toward the direction of the motion," Brown remembers. "I got mad at myself when I realized it was that easy." On this morning in late February, Brown, now a senior, is taking several visitors around CHAD. He points with pride at a wall of college acceptance letters. "This is my Penn State letter. There's Hampton University. And there's California College of the Arts," he says, pausing to exchange high-fives with classmate Chanelle Gilbert, who also has a letter from CCA.

This moment almost didn't happen. Brown nearly dropped out at the end of his junior year, when his mother was laid off and he contemplated getting a full-time job. Some advice from Marshall Purnell, FAIA, who met Brown that summer during Purnell's term as president of the American Institute of Architects, helped keep him in school. "You have to work hard, be persistent, and fight for what you want," says Brown, who, like Purnell, is African-American. "It takes a lot of work to get where these people are. I'm ready to be there."

Brown represents the face of architecture in about a decade — a future that could be more diverse thanks to CHAD and a half-dozen other design-focused high schools nationwide, which serve mainly African-American and Latino populations. Many observers praise them for fueling a "pipeline" of underrepresented groups that will eventually improve the profession's chronic lack of diversity. Studies also suggest that these schools, along with design-oriented mentorship programs, boost students' proficiency in math and science and reduce dropout rates. Yet despite such successes, it's too early to judge their long-term effectiveness at broadening architecture's reach.

Indeed, at less than 1.7 percent, the proportion of licensed African-American architects has barely budged since National Urban League presi-

*James Murdock, a former RECORD news editor, is an architecture writer and filmmaker based in New York.*

# “The way a kid processes and applies knowledge is much more real if they look at something that exists in the world.” *Krisann Rehbein*

dent Whitney Young famously called attention to the problem at the AIA's National Convention in 1968. Despite some gains, Latinos, Asians, and Native Americans are also scarce. Architecture was hardly remarkable four decades ago, but other professions have since tackled the problem with better success.

Many observers think that architecture's problem is one of visibility. CHAD, which marks its 10th anniversary this fall, has built a reputation for opening young people's eyes to new career possibilities. “I always liked to draw,” Ryan Brown says, “but before I came to CHAD, I had no idea about architecture.” Chanelle Gilbert has a similar story. “When I was little, I used to change my room around a lot and thought I wanted to be an interior decorator,” she recalls. “Here, I was told I could design the entire house.”

Eighty-five percent of CHAD's student body are African-American. The school offers open enrollment based on a lottery system, and as a result, the demographics of its students resemble the entire city. More than 90 percent qualify for free lunches. Students at the three-year-old Priestley School of Architecture and Construction, in New Orleans, fit a similar socioeconomic profile – as do those at the Phelps Architecture Construction Engineering High School in Washington, D.C., although this new charter school requires admissions testing.

These schools represent the diversity pipeline's intake valve. CHAD's founders explicitly sought to “develop more African-American architects,” says head of school Peter Kountz. They also aspired to a broader goal of using education to lift kids out of economic and academic poverty. “We're not interested

in becoming a middle-class high school, and that's important for anyone who seeks to understand us,” Kountz explains. “Our kids are very parochial, just as a lot of suburban kids are. We help them to see a larger, more meaningful and complicated world.”

In that vein, many of these schools draw a distinction between design and the core academic curriculum. “Students can't go from here to a school like NYU, Carnegie Mellon, or Pratt unless they're academically sound,” says Stacey Mancuso, principal of the Design and Architecture Senior High School (DASH), in Miami, Florida. Celebrating its 19th anniversary this year, DASH – where 53 percent of

“If I had been anywhere else, nobody would have fought to keep me in school.”

**RYAN BROWN**  
CLASS OF 2009

the student body is Hispanic and 12 percent black – ranks as one of the oldest design-oriented high schools nationwide. It also boasts some of the highest test scores. In 2007, 96 percent of DASH students scored proficient or above on math exams, compared to just 57 percent for the Miami-Dade District and 65 percent statewide. Moreover, 100 percent of DASH's class of 2008 graduated, and 99 percent went on to study in college.

CHAD's administrators point to some equally impressive numbers: Ninety-five percent of students who start CHAD in freshman year will graduate four years later, compared to approximately 50 percent in



Philadelphia's wider public school system. Overall, the city dropout rate averages 10 percent a year, yet at CHAD it is only 1 percent. And more than two thirds of the school's 2007 and 2008 graduates are enrolled in four-year colleges. “The question students used to ask each other was, ‘Are you going to college?’ Now, it's, ‘Where?’ ” says Miguel Vazquez, CHAD's director of college placement.

When it comes to CHAD students' scores on standardized tests, though, the success story grows murkier. The school has yet to achieve Adequate Yearly Progress, a key assessment created by the No Child Left Behind Act. “That means

we're not fully doing our job,” Kountz admits. But he adds that proficiency tests are a flawed gauge of true progress. “We get kids coming into ninth grade who read at a fourth- or fifth-grade level. We can raise students to an 11th-grade level by the time they leave, but in the eyes of the test, we're still failing.” Faculty go to great lengths to effect further improvement. At Priestley, which has a similar standing to CHAD, for example, teachers put in extra hours of tutoring and often serve as surrogate family members. “If I had been anywhere else, nobody would have fought to keep me in school,” says CHAD student Brown, recalling how Courtney Tyus, the school's develop-

ment director, helped him.

Administrators at both schools are searching for ways to boost students' test scores by integrating design into core curricular subjects. One tool they're using is *The Architecture Handbook*, by Jennifer Masengarb and Krisann Rehbein, published by the Chicago Architecture Foundation. Taught in more than 130 schools nationwide, this comprehensive design textbook incorporates math and science concepts into everything from CAD to sustainability. "The way a kid processes and applies knowledge is much more real if they look at something that exists in the world," observes Rehbein.

Mentorship programs pursue a

similar curriculum-based approach. The Salvadori Center, in New York City, pairs architects and engineers with school teachers to work on project-based learning modules. A bridge-building unit reinforces math and geometry concepts, for instance, while a lesson on monument design supplements social studies. As Salvadori's executive director Leonisa Ardizzone explains, "We help teachers see that you don't have to be an architect or an engineer to use the built environment around you." Each year, Salvadori reaches an average of 2,400 students, 51 percent of whom are Latino and 30 percent African-American, and its testing track record is good.

Before a Salvadori "math lab" was offered at schools in Port Chester, New York, for instance, only 60 percent of students passed state math tests; afterward, 93 percent passed.

In San Francisco, the Build SF Institute saw similar results among students who participated in its mentorship program, a majority of them Asian and Hispanic. It is one reason why the local education district actively encouraged administrators to expand the program from an after-school activity into a full-fledged school, which opened last fall. "We run it like a design studio," says Alan Sandler, executive director of the Architectural Foundation of San Francisco, which

black or Hispanic. One third of past students now have jobs in a design-related field, and 53 percent of last year's senior cohort are now majoring in architecture.

The success of charter high schools at producing architecture majors is less certain. At CHAD, the number of students applying to design-centered colleges has been steadily increasing – from 50 percent in initial cohorts to 63 percent among this year's seniors. Yet among the 138 students in the class of 2009, just 15 percent say they intend to major in architecture. Kountz faults the school for failing to emphasize architecture strongly enough in its curriculum. Many observers believe the blame lies elsewhere.

"We keep talking about making kids aware of architecture as a profession," says Marshall Purnell. "But here's the interesting thing: If you look at how many African-American architects of my generation have children who also chose the profession, you'd be surprised at how low the percentage is. It's because they almost know too much about the profession."

Statistics suggest that even the diversity pipeline cannot resolve the profession's overarching shortcomings. Dennis Mann, a professor of architecture at the University of Cincinnati, codirects the Directory of African American Architects. "We're adding about 50 people to our list each year, totaling just under 1,700," he says. "But when you account for people who pass away, the overall number of licensees is not increasing." There are some nuances. The number of licensed female black architects, for instance, is growing at a rate "far exceeding" other increases: from just 48 in 1990, when the directory began, to nearly 230 today.



"I thought I wanted to be an interior decorator. Here, I was told I could design the entire house."

**CHANELLE GILBERT**  
CLASS OF 2009

runs Build SF. "There aren't any class periods, but instead the students are given design problems they work on throughout the day. Each problem has aspects of math, science, and social studies integrated into them. That's how we cover our standards, but it doesn't look anything like a regular school."

Mentorship programs provide the best piece of evidence that reaching minorities in high school can inspire them to pursue architecture. Of the 47,000 high school students who participated in the ACE Mentorship Program of America since it began in 1994, says president Pamela Mullender, 82 percent are

“Kids get hit hard by the very cold and competitive studio culture. That’s true for all kids. But when you layer the race issue on top of that, it complicates matters.” *Steven Lewis, AIA*

One leak in the pipeline is the college experience. It’s telling that nearly three quarters of licensed black architects come from historically black colleges and universities, such as Howard University. Historically white institutions are making efforts to recruit more minorities, but many observers feel they haven’t gone far enough to ensure that a supportive environment exists once these students arrive on campus – particularly when it comes to kids from schools such as CHAD. “Our kids are street smart, but they don’t know how to behave academically,” Kountz says. “It’s very difficult for our kids in college.”

Steven Lewis, AIA, president of the National Organization of Minority Architects (NOMA), is so concerned about what happens to black students in college that he’s made it one of three priorities during his NOMA presidency. “Kids get hit hard by the very cold and competitive studio culture. That’s true for all kids. But when you layer the race issue on top of that, it complicates matters,” he explains. This spring, Lewis plans to unveil a tool kit to help colleges “feather the nest” a little better. One recommendation is that faculties hire more people of color.

The fundamental truth is that race still matters. “It’s something that faculties at architecture schools around the country are really struggling with,” admits Mark Robbins, dean of the Syracuse University School of Architecture. “One doesn’t have to be Latino or African-American to be sensitive to issues of diversity and race. But if we’re going to be meaningful as institutions, students of all stripes who come here should be able to find themselves within the faculty.”

There is also a lack of role



**DRAWING FOUNDATIONS**  
Michael Reingold teaches Drawing Foundations to CHAD freshmen.

models in senior management positions out in the field. High-profile African-Americans, such as Diane Hoskins, FAIA, an executive director of Gensler, and Ralph Jackson, FAIA, a principal of Shepley Bullfinch, are the exception at white-owned firms. Many observers believe lingering racism is keeping minorities down. “The important factor in successfully building a client base and getting ahead is not so much what firm principals say about a person of color when they’re in the room, but what’s said when they’re not in the room,” observes Ted Landmark, president of Boston Architectural College. “Firms have to provide access to clients. That will enable more people of color to demonstrate the talents they have.”

Landmark has faulted the AIA for failing to take a leadership role sooner. “Institutionally, there needs to be a person with the authority to affect policy, budget, and outcomes,” he has contended. “In the absence of that, we will continue to

initiate programs that enable us to feel good at the front end but that don’t produce tangible results.”

For his part, Purnell praises the AIA for strides made within the past few years. But he doesn’t mince words when it comes to describing institutionalized racism – and he lays most of the blame on corporate and government clients. “The GSA has never selected a black architect to design a new, freestanding structure of any size anywhere in this country since the agency was created in 1949. If I can make that statement today, in 2009, it should bring crystal clarity to this problem we have in the profession,” he says. (For its part, GSA is reaching out to minority firms.) “We can put as many kids in the pipeline as we want, but unless we solve what happens at the end of the pipeline, it’s going to be a funnel.”

The recession could further complicate matters. Some observers speculate that layoffs and hiring freezes will give young architects time to finish their IDP requirements – making them more attractive candidates when the hiring market eventually recovers. Layoffs also might prompt black and Latino architects to enter teaching, thereby

becoming role models for younger generations. But others fear that the recession might deter children of color from studying architecture in the first place. Vasquez, CHAD’s college counselor, is already seeing a slight increase in the number of students who are heading to college this fall to study nursing.

One thing is certain, most analysts agree: The economic crisis heightens the urgency that all architects should feel about making headway on diversity. “Our client base has become more diverse, and that requires a more diverse range of designers to serve populations with different language and cultural expectations.” Landmark says, pointing to states such as California, Florida, and Texas, where Latinos are almost a majority. If architects fail to satisfy clients’ needs, business will instead go to engineers and other disciplines that have already diversified. “We risk irrelevance as a profession,” Purnell concurs. “This problem is killing job opportunities for all architects.”

But Purnell avoids such dire talk when he meets with teens such as Ryan Brown. Indeed, he still believes that fueling the diversity pipeline with fresh faces is architecture’s best hope – and he’s acutely aware of his own importance as a role model. “It wasn’t until college that I met my first black architect,” Purnell says. “I said, ‘If he can do this, I can do this.’ I hope that’s what Ryan thought when he met me – someone who’s black, owns a firm, and was president of the AIA. I can only imagine Ryan felt like there were no limits. That’s what you’ve got to feel at his age.” ■

Watch video profiles of students at CHAD in Philadelphia and take a tour of the school on our Web site, [architecturalrecord.com/diversity](http://architecturalrecord.com/diversity).

Italian Furniture  
A Sound Investment

The  
Event.



**WorldWide**

Furnishing Ideas Made in Italy







The Salone Internazionale del Mobile of Milan, which finished last April with resounding success, is gearing up into 'export mode' with the Saloni WorldWide – Furnishing Ideas Made in Italy, reconfirming its North American presence for the fifth straight year with a selection of the best Italian design manufacturers, under the patronage of the trade organization Federlegno-Arredo.

In the current climate of economic crisis, when any kind of investment seems risky, buying quality

Italian furniture is instead a truly sound investment. Yesterday's classics are today more valuable and desirable than ever – indeed, they are a cutting-edge trend unto themselves (as demonstrated by several pieces illustrated here). A fine piece of Italian furniture purchased today, with its quality design and craftsmanly perfection, will be tomorrow's classic. The Saloni WorldWide New York, which runs from May 16 to 19 at the Jacob K. Javits Convention Center, concurrently and under the same roof as the ICFF / International Contemporary Furniture Fair,



Atoallo 233  
Vico Magistretti  
1977



Nathalie  
Vico Magistretti  
1978



Graphis  
Giuseppe Bavuso  
2004

Louis Ghost  
Philippe Starck  
2002



provides an excellent overview of high-quality contemporary Italian design – from the living room to the dining room, from sanitary fixtures to lighting to tiles, presented by the leading Italian companies in the Home Furnishing sector.

This initiative is also supported by the ICE (Italian Trade Commission), a division of the Ministry of Economic Development.



Flap  
Francesco Binfaré  
2000

Less  
Jean Nouvel  
1994



Bambo Stool  
Stefano Giovannoni  
1997



LaVasca Mini  
Matteo Thun  
2000





## Italian Trade Commission

Trade Promotion Section of the  
Consulate General of Italy

The Italian Trade Commission is the government agency entrusted with promoting trade, business opportunities, and industrial cooperation between Italian and foreign companies. It operates through 100 branch offices in over 80 countries throughout the world. In the United States, the ITC has six offices: Atlanta, Chicago, Houston, Los Angeles, Miami and New York. Each office has specific territorial jurisdiction, as well as product specialization. The Atlanta office is focused on promoting industrial cooperation between American and Italian companies in the furniture and lighting industries. Among other initiatives, we organize trade missions for American manufacturers to attend tradeshows and workshops in Italy and, in conjunction with specific events we organize visits to Italian manufacturers and suppliers.

233 Peachtree Street N.E. - Suite 2301,  
Harris Tower - Atlanta, Georgia 30303  
ph. (404) 525-0660 - atlanta@atlanta.ice.it  
www.italtrade.com - www.decoritaly.com



FEDERLEGNOARREDO

Founded in 1945, Federlegno-Arredo is the Italian Federation of wood, cork, furniture and furnishing manufacturers. It is part of Confindustria, the main confederation of Italian Industry. The federation offers services of interest to companies; supports technical and economic development through researches, studies, debates, workshops; promotes and carries out professional training and technical education; processes data and gives reports on the production and economic situation; promotes the industry through exhibitions, professional trade fairs and consortiums. It contributes to the protection of the environment by promoting the use of wood: a simple way to reduce CO2 emissions through the carbon sink and carbon stock effects. Federlegno-Arredo plans many initiatives of international relevance: thanks to its company network it is one of the main protagonists in the world of international trade fairs, with the Salone Internazionale del Mobile (the International Furniture Exhibition) and I Saloni di Milano, organized by Cosmit Spa – a member of Federlegno-Arredo srl –

since 1961; MADEexpo - Milano Architettura Design Edilizia, the international event for projects, architecture and building promoted by Federlegno-Arredo, hosted 1,739 exhibitors and 200,126 visitors coming from 118 different countries, during its second edition (February 2009). Federlegno-Arredo has offices in Milan, Venice, Rome and Brussels, and representative offices in Beijing, Moscow and Mumbai.

Foro Buonaparte 65 - 20121 Milan, Italy  
ph. +39 02806041 - fax +39 0280604392  
fla@federlegno.it - www.federlegno.it

## COSMIT

Cosmit is the company that organises the Salone Internazionale del Mobile di Milano, launched in 1961 by a small coalition of furniture manufacturers from within the Federlegno-Arredo trade association, and which soon became the most prestigious international event in the world of furniture design and production. In addition to the Salone Internazionale del Mobile, which is held every April in Milan, Cosmit is the organisational force behind the biennial events EuroLuce/ International Lighting Exhibition (odd years), Eurocucina/International Kitchen Furniture Exhibition, SaloneUfficio/International Biennial Workspace Exhibition, the International Bathroom Exhibition (even years), and the annual International Furnishing Accessories Exhibition and the SaloneSatellite.

Taken together, these events occupy an area of nearly 230,000 square metres at the Milan Fairgrounds in Rho, and represent the production of more than 2,500 of the most dynamic and creative companies on the international market, not to mention that of the more than 600 young designers of the SaloneSatellite.

The Saloni have been visited in 2008 by 348,000 industry professionals, more than 50% of whom come from 140 countries around the world. Responding to the request of a significant number of veteran Milanese exhibitors, in 2005 Cosmit launched "i Saloni WorldWide. Furnishing Ideas Made in Italy", held annually in New York in May and Moscow in October.

Cosmit is a member of the ICSID (International Council of Societies of Industrial Design) and ADI (Association for Industrial Design).

Foro Buonaparte 65 - 20121 Milan, Italy  
ph. +39 02725941 - fax +39 0289011563  
info@cosmit.it - www.cosmit.it



## Exhibitors' Temporary List as at 02/28/2009

Alessanderx spa  
Antidiva srl  
Arper spa  
Barausse spa  
Calligaris Usa Inc.  
Casa Dolce Casa  
Casamood  
Ceramic Tiles of Italy\*  
Cerim  
Clei srl  
Dada spa  
Edra spa  
Florim Ceramiche spa  
Floor Gres  
Flou spa  
Glas Italia  
Kartell US Inc.  
Le Porte di Barausse  
Magis spa  
Matteograssi spa  
Molteni & C. spa  
Oluce srl  
Rapsel spa  
Ridea srl  
Rex  
Rimadesio spa  
Zonta Luciano srl

\*  
Impronta Ceramiche spa  
Settecento  
Ceramiche Refin spa  
Lea Ceramiche North America  
Etruria Design  
Tagina  
Ceramica Sant'Agostino  
Ceramica Lord spa  
Marazzi  
Casalgrande Padana  
Fap  
Caesar  
Del Conca

# SAVE NOW – SAVE LATER

## FINANCIAL INCENTIVES

FOR ENERGY EFFICIENCY

**Retrofits**

**New Construction**

**Equipment Replacement**

Your clients are asking for green buildings with energy-efficient equipment and innovative design practices. Set yourself apart from the competition with the New Jersey SmartStart Buildings Program.

Get technical assistance, design support and financial incentives that will drive down the installed cost.

And the steps you take now will earn operating savings for your clients for years to come.

[www.NJCleanEnergy.com/ssb](http://www.NJCleanEnergy.com/ssb)

Maplewood Police and Court Building  
Retrofit: Cooling System  
SmartStart Incentive: \$45,000  
Annual Energy Savings: \$9,665

New Jersey  
**SmartStart**  
BUILDINGS



NJ SmartStart Buildings® is a registered trademark.  
Use of the trademark without permission of the NJ Board of Public Utilities is prohibited.

# Add new dimensions to your facade, think Trespa



## Panels to create an exceptional facade

Trespa Meteor panels are used by architects around the world to create highly individual facades and decorative skins. Taking their inspiration from eye-catching patterns and surfaces, they enhance buildings to make them stand out in today's urban landscape.

It is all part of Trespa Perspectives, the inspirational source of new ideas for architects, designers and specifiers, comprising different architectural elements based on the themes of Rhythm, Depth and Character. For more information: [www.trespa.com](http://www.trespa.com)

**Trespa**  
North America Ltd.  
12267 Crosthwaite Circle  
Poway, CA 92064  
Tel.: 1-800-4-TRESPA  
Fax: 1-858-579-9568  
[info@trespanorthamerica.com](mailto:info@trespanorthamerica.com)



CIRCLE 56

TRESPA®



888.552.9497

[rockymountainhardware.com](http://rockymountainhardware.com)

ROCKY MOUNTAIN®  
H A R D W A R E  
HANDCRAFTED BRONZE HARDWARE

CIRCLE 57

DECIDEDLY LARGE DESIGN?

# BIGGER BRICK.



Carolina Ceramics Brick Company's 16-inch veneer brick makes big projects as beautiful as they are economical. When it comes to decidedly large-scale designs, the 16-inch line-up's scale is much more appealing— and, of course, so is its cost, because the labor savings can dramatically decrease your bottom line!

Carolina Ceramics offers two sizes— 4x4x16 and 4x8x16.

**Big on looks. Big on cost savings.**



**CAROLINACERAMICS.COM**  
803.788.1916 | 866.788.1916



OPENING FALL 2009  
ENGINEERING A MOVABLE NFL EXPERIENCE

WALTER P MOORE

800.364.7300

[WWW.WALTERPMOORE.COM](http://WWW.WALTERPMOORE.COM)

ENGINEERING FOR AIRPORTS, COMMERCIAL BUILDINGS, EDUCATION, ENTERTAINMENT, EXISTING STRUCTURES,  
GOVERNMENT BUILDINGS, HEALTHCARE, HOSPITALITY, MIXED-USE AND RETAIL, MOVABLE STRUCTURES, PARKING STRUCTURES,  
PUBLIC ASSEMBLY, PUBLIC WORKS, ROADWAYS, SCIENCE AND TECHNOLOGY, SPORTS, TALL BUILDINGS AND TRANSPORTATION

DALLAS COWBOYS NEW STADIUM

CIRCLE 59

© Daryl Shroyer/2009



**ProRoc**<sup>®</sup> WITH **M2TECH**<sup>™</sup>  
MOISTURE & MOLD RESISTANT GYPSUM BOARD

## Sustainable design from the ground .

Start with CertainTeed Gypsum's unique M2Tech<sup>™</sup> technology which is specially engineered to combine moisture and mold resistance for enhanced protection against mold growth.



### SHAFTWALL SYSTEMS

ProRoc<sup>®</sup> Moisture and Mold Resistant Shaftliner Type X with M2Tech<sup>™</sup> for Shaftwall Systems.



### AREA SEPARATION FIREWALL

ProRoc<sup>®</sup> Moisture and Mold Resistant Shaftliner Type X with M2Tech<sup>™</sup> for Area Separation Firewall Systems.



### INTERIOR GYPSUM BOARD

ProRoc<sup>®</sup> Moisture and Mold Resistant Gypsum Board Type X with M2Tech<sup>™</sup> for interior walls and ceilings.

# NEW

## MOISTURE & MOLD RESISTANT SHAFTLINER



800-233-8990 • [www.certainteed.com](http://www.certainteed.com)

**CertainTeed**   
*Quality made certain. Satisfaction guaranteed.<sup>™</sup>*

EXTERIOR: ROOFING • SIDING • WINDOWS • FENCE • RAILING • TRIM • DECKING • FOUNDATIONS • PIPE  
INTERIOR: INSULATION • **GYPSUM** • CEILINGS

CIRCLE 60

# Honor Awards

**104** Gold Medal

**114** Architecture

**122** Interiors

**134** Urban Design

**142** 25 Year Award

**144** Firm of the Year

## AMERICAN INSTITUTE OF ARCHITECTS 2009 HONOR AWARDS

When looking at the 2009 AIA Honor Awards as a whole, it is easy to comprehend why this year's winners were chosen. The group – which includes nine projects in the category of Architecture, 10 projects in Interiors, and six in Urban Design, along with Gold Medalist Glenn Murcutt, Hon. FAIA, Firm of the Year Olson Sundberg Kundig Allen (OSKA), and 25 Year Award recipient Boston's Faneuil Hall – all reveal what could be called a con-

nection to connections. Murcutt is a sole practitioner with a long career creating architecture that bonds with its geography; OSKA is a firm that has spent 35 years linking architecture, art, and craft to the earth and community; Faneuil Hall is an adaptive-reuse project that turned a beloved historic landmark, originally built in 1825, into an architectural anchor and urban gathering place, which helped revive the downtown. And as for the projects, the jury summed up the winners by stating that they were “back to architecture – projects that appeal to our emotional connections.” That says

it all. From iconic new buildings in the Architecture category, including cathedrals and community centers, to projects in the Interiors category, such as a ballet school and offices, to a group of Urban Design winners, each of which creates a unique site for people to gather and ties place and person with environment, these projects strip away opulence and get us back to basics. There's light, there's sustainability, there's a sense that we belong to this region, this world. The projects and people honored this year bring with them a new restraint. There's no eccentricity here; instead,

there are designs that favor clear circulation, orientation, technology, materials, and above all, connection. While most of the projects have some sort of social impact on the urban context, even the single-family homes honored here celebrate connection – the union of outside and in, progression and flow. Most were achieved within firm budget constraints, and many reuse old buildings or integrate the old with the new. These are cautious times. This year's Honor Award winners reflect that, in the most canny and inspirational ways. *Ingrid Spencer*

## JURORS 2009

### Interiors

JURY CHAIR **Mark P. Sexton, FAIA**, Krueck & Sexton Architects

**Joan Blumenfeld, FAIA**, Perkins+Will

**Elisabeth Knibbe, AIA**, Quinn Evans Architects

**Arvind Manocha**, Los Angeles Philharmonic Association

**Kevin Sneed, AIA**, OTJ Architects

### Architecture

JURY CHAIR **David Lake, FAIA**, Lake Flato Architects

**Carlton Brown**, Full Spectrum

**Michael B. Lehrer, FAIA**, Lehrer Architects

**James J. Malanaphy III, AIA**, The 160 Group

**Paul Mankins, FAIA**, Substance Architecture Interiors Design

**Anna McCorvey**, AIAS director, Northeast Quad

**Anne Schopf, FAIA**, Mahlum Architects

**Suman Sorg, FAIA**, Sorg and Associates

**Denise Thompson, Assoc. AIA**, Francis Cauffman Architects

### Urban Design

JURY CHAIR **Jonathan J. Marvel, AIA**, Rogers Marvel Architects

**Samuel Assefa, Assoc. AIA**, City of Chicago Department of Planning and Development

**Tim Love, AIA**, Utile

**Ivenue Love-Stanley, FAIA**, Stanley Love-Stanley

**Stephanie Reich, AIA**, City of Glendale, Planning Division





Glenn Murcutt developed his approach to architecture after studying Henry David Thoreau and Australia's aboriginal builders.

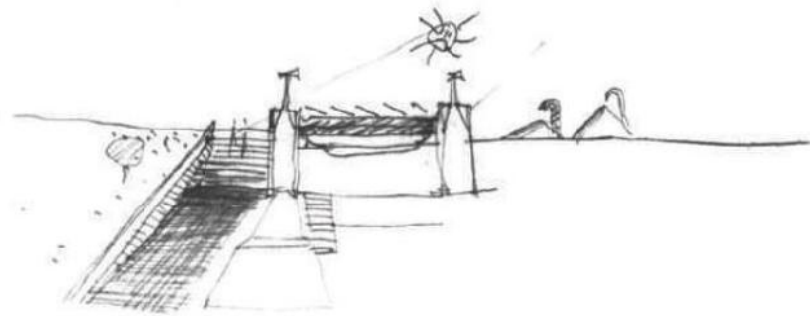

## GLENN MURCUTT

has designed no tall buildings, no sleek museums, no flamboyant performance venues. His one-person practice has specialized almost exclusively in modest, single-story houses, all in Australia. Why, then, did the AIA honor him with its 65th Gold Medal?

Writing in support of Murcutt's nomination, Tadao Ando noted that the ecosystem is a new concern for most of us, but "Glenn Murcutt: has always been focusing on the geographical and regional conditions, from the very beginning of his career."

Since opening his Sydney office in 1969, Murcutt has designed the kind of buildings the world needs most: economical, energy-efficient, graceful, small structures. While his work is local, its influence – propagated in part by his worldwide lectures and design classes – is global. In 2002, he was awarded the Pritzker Prize.

Murcutt's 1975 Marie Short House, located on a floodplain in subtropical Kempsey, New South Wales, initiated a series of lightweight houses that adhere to the Aboriginal notion of "touching the earth lightly." Murcutt often floats his buildings a few feet from the ground on posts, to protect against storm water and insects and maximize ventilation. He favors narrow linear plans, oriented east-west, to amplify summer breezes and winter sun, and wraps his houses in movable louvers, screens, and glass doors, making them comfortable in all seasons, without air-conditioning.

A decade ago, Murcutt started to expand his range. He completed the Boyd Education Center in Riversdale, New South Wales, in 1999, with his architect-wife, Wendy Lewin. He is now working with Hakan Elevli on a mosque outside of Melbourne and with Lewin on an underground mineral museum in Lightning Reach, an arid area west of Brisbane. *Andrea Oppenheimer Dean*

PHOTOGRAPHY: © ANTHONY BROWELL

An interview with

# GLENN MURCUTT

**AR Why do you consider drawing so important?**

**GLENN MURCUTT** We are taught that creativity is the most important thing in architecture. Well, I don't believe that. I think that the creative process leads to discovery, and discovery is the most important thing. I'm suggesting that any work of architecture – as opposed to merchandise – has the potential to be discovered, and drawing is the key.

The verb *to draw* means “to bring out,” and to bring out is to reveal, and to reveal is to understand. With the computer, you arrive at the end before you comprehend the meaning of that end.

One of the great problems of our period is that we've developed tools that allow rapidity, but rapidity and repetitiveness do not lead to right solutions. Perception gives us right solutions. I know that one can use a computer to discover, but what it produces is form; it can be sculpture, but not necessarily architecture. There's so much work today that's different for the sake of difference. It creates loud architecture that screams at you.

**Your buildings are quiet but also have a kind of difference. In fact, you've been credited with creating a modern Australian architecture. How did your approach evolve?**

The difference in my architecture grew out of circumstance. For the first 10 years, my practice did almost nothing but alterations and additions, but I learned that there were many ways to solve a problem. Those small projects built up a way of thinking and doing things that applies to all scales of work. I see myself as trying to create an architecture of its place, of its time, of its technology, of its culture.

The principles of architecture are questions. Before starting any project I ask: What's the geology, what's the geomorphology, what's the history, where does the wind come from, where does the sun come from, what are the shadow patterns, what's the drainage system, what's the flora? I'm just working in my own milieu in a way that's appropriate. It's an attitude, and I take it as a total responsibility.

**Why have you chosen to remain a one-man operation?**

I love silence and time to think. Being alone means I can survive very well with little overhead; I can weather recessions. It also allows me to travel and experiment with wind patterns, materials, light, climate, spaces. I like the freedom.

I was raised on the notion of the individual. My father used to give us a dose of Henry David Thoreau three times a day, seven days a week. He often told us, “Don't rush after success, and if it comes, make sure the people at the beach still don't recognize you.” I've always worked under the radar.

**You've said you'll never stop designing houses. What is their appeal?**

They're among the most difficult tasks. As with larger buildings, you have to make something that's appropriate to the site and to available materials and technology, and it must meet budgetary

constraints. But designing a house is also a most intimate task, which makes it most difficult.

**You have said that technological solutions to environmental issues tend to be the wrong solutions.**

Usually there are more economical ways of doing things. If the shape of your building creates positive and negative pressure systems, you will get air flowing without fans. If you have open windows, you are acting more responsibly toward the planet than if you have air-conditioning. You can cool roofs most economically by having very good insulation on the roof itself. Such thinking is innate with me.

Take the LEED program; it fosters architecture by numbers, and that's wrong. Architecture by logic is not wrong. In my country, you get no credit if the building is not air-conditioned. How stupid is that? LEED disregards the connection between humans and nature.

**You are a meticulous craftsman. What, for you, is the role of craft in architecture?**

I worked in my father's joinery shop from the age of 11, and he drilled into me the idea of doing even the smallest thing extraordinarily well. But crafting is only the means by which architecture is made; it's not architecture. Architecture is space, light, function, walls that open and close, vents that open. In my country, it's about handling heavy rainfalls. Architecture is not merchandise, and it's not just an object in itself. Like a violin, it's an instrument that's part of an orchestra or quartet. Like a yacht, you should be able to modify and manipulate its form and skin according to seasonal conditions.

**What about your choice of materials?**

Again, you have to ask the right questions: How much energy is required to produce the material? How much will the material reduce energy use in the building? One of the few sustainable materials is timber. Steel and aluminum require much more energy to produce. They should be used sparingly.

One of the most sustainable ideas has to do with building in a way that allows you to reclaim and reuse materials. So you don't use nails; you use screws and bolts. When I expanded the Laurie Short House that I built in Sydney in 1974, I was able to unbolt, totally dismember, and move the verandah.

More labor, less materials. That's what our countries need.

**You teach design studios at many universities around the world. What are the most important ideas you want your students to take away?**

They must think that every project they do is worthy of being. Their work has to speak about place, technology, climate, structure, materials. They must work honestly, with heart and mind, rather than structuring what is a visual delight alone. Their work has to have roots. I think what we admire most about architecture of all periods is rootedness, authenticity. We recognize authenticity, and we recognize the five-minute flash. The authentic lives on; the flash quickly dies.

*Interview conducted by Andrea Oppenheimer Dean, contributing editor.  
Project texts by Aleksandr Bierig.*

**LAURIE SHORT HOUSE**  
Terry Hills, Sydney  
1974

This house for a young couple with a child shows the strong influence of Mies van der Rohe or Murrutt's early work. Built on land vulnerable to bushfires, timber construction

was ruled out, resulting in the clean, steel-and-glass material palette. The harsh Australian landscape influenced Murrutt's decision-making, convincing him to incorporate

louvers and other shading systems, a large verandah, and an 8-inch-deep rooftop pool of water for insulation and fireproofing.



**MARIE SHORT HOUSE**  
Kempsey  
1975

Murrutt engages both climatically sensitive strategies and vernacular Australian precedents in this seminal work. Set above the floodplain of this large farmland site, the house is positioned in the landscape to take advantage of ocean breezes while

employing strategies that insulate it from direct sunlight in the summer and from winter winds. This is his first use of a strategy of exterior layering, employing a set of glass or metal louvers, a mediating insect screen, and an exterior sunscreen of aluminum

slatted blinds. These components are all adjustable, with the idea that houses should be like clothing – one can wear more or less, depending on the season and the weather. Murrutt bought the house in 1980 and has since expanded it.



PHOTOGRAPHY: © MAX DUPAIN (TOP TWO); JOHN COLLINGS (BOTTOM)



## **BALL EASTWAY HOUSE**

Glenorie, Sydney  
1983

Commissioned by two painters who wanted to leave Sydney for more peaceful, rustic climes, this light-weight, compact dwelling became a model for much of Murcutt's ensuing work. A steel structure with timber joists, the house features long north and south faces that, along with the roof, are clad in corrugated-iron sheets. The house is raised on steel columns set on a wooded hillside, literally fulfilling Murcutt's dictum to "touch the earth lightly."

## **MAGNEY HOUSE**

Bingie Point  
1984

Sited on a vast coastal plain 155 miles from Sydney, this house elaborates on schemes Murcutt had developed in previous projects – such as triple-layered exterior walls and rainwater

collecting systems – while adding a distinctive butterfly roof that improves ventilation and daylight inside the residence. Where Murcutt's earlier houses often use cores to house

bathroom and plumbing, here he organizes the building in an unrelenting line, with all bathrooms and kitchens arranged along the rear wall.

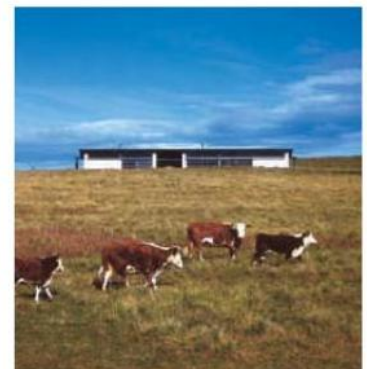

## MARIKA ALDERTON HOUSE

Yirrkala Community,  
Eastern Arnhem Land  
1994

This unusual house is Murcutt's clearest discussion with Australian vernacular architecture, in particular native Aboriginal dwellings. There is no glazing anywhere on the house, which instead opts for a series of

panels that can open and close, transforming the ventilation and appearance of the entire house. Built for the Aboriginal artist Banduk Marika and her family, the house was an attempt at connecting the

colonial and Aboriginal cultures of Australia, prompting Marika to call it her "Bridge House."



## BOWALI VISITOR INFORMATION CENTER

Kakadu National Park  
1994

Darwin-based Troppo Architects collaborated with Murcutt to develop the design of this public project in Australia's Northern Territory. The team consulted members of the lo-

cal Aboriginal population, leading to the use of regional materials, such as rammed earth, as well as larger curatorial strategies such as designing the museum to reflect the Aboriginal

idea of "a journey without beginning or end." The structure consists of a long butterfly roof and a large wooden brise-soleil that form a continuous verandah over a series of pavilions.





**ARTHUR & YVONNE  
BOYD ART CENTER**

Riversdale, West  
Cambewarra  
(with Wendy Lewin  
Architect)  
1999

A dormitory for resident artists and up to 32 students built on a bucolic site three hours from Sydney, this project marks one of Murcutt's most prominent attempts at large-scale work. Because of the nature of the project, the architect was able to

create a natural extension of his domestic longhouse forms – a long line of bedrooms extending on the south with communal and eating areas on the north edge of the structure. The project also employs and multiplies the strategies of environmental co-

existence that Murcutt has explored throughout his career. The building's dialogue with its surrounding topography transports this project from an expression of Murcutt's overriding themes to a unique masterwork in its own right.



**BOWRAL HOUSE**  
Southern Highlands  
2001

This residence, 125 miles southwest of Sydney, allowed Murcutt to articulate consistent themes in his work on a grand scale. It looks and feels like a typical rural Murcutt project: a long, linear plan; sensitivity to sun

exposures; attention to rainwater collection. But unlike his more modest projects, this one revels in its size. For instance, a 230-foot-long arcade that runs the length of the structure channels indirect sunlight

that moves across the wall throughout the day. Author Françoise Fromonot calls this, "doubtless the most metaphysical space Murcutt has built to date."



# Slimline Rails

## New in Glass Door Design

**DORALCO**

### ADVANTAGES:

- Smallest dry glaze door rail in the market
- Glass is more visible
- Multiple size options
- Any finish desired
- Ships within a week

**RTKL ARCHITECTS**  
Chicago Office —  
Front Entrance



**OHIO DEPARTMENT  
OF FIRE**  
Display Case



**BLUE CROSS BLUE SHIELD**  
Corporate Office



**DORALCO**  
ARCHITECTURAL METAL SOLUTIONS

INTERTEC | Sunshades and Grilles  
COMPOSITEcore | Architectural Panel Systems  
MACHINE WORKS | Custom Metal Fabrication

doralco.com  
708.388.9324

**OPAL AND FOSSIL CENTRE**

Lightning Ridge, NSW  
(with Wendy Lewin  
Architect)

In process

Murcutt and his wife, Wendy Lewin, are designing this mineral museum in a hot and arid region west of Brisbane, near the border of

Queensland. To deal with the rugged climate, they are pushing the building into the side of a hill, using the land to protect interior spaces. The museum

will display prime examples of fossils found nearby and highlight the area's rich history of opal mining.

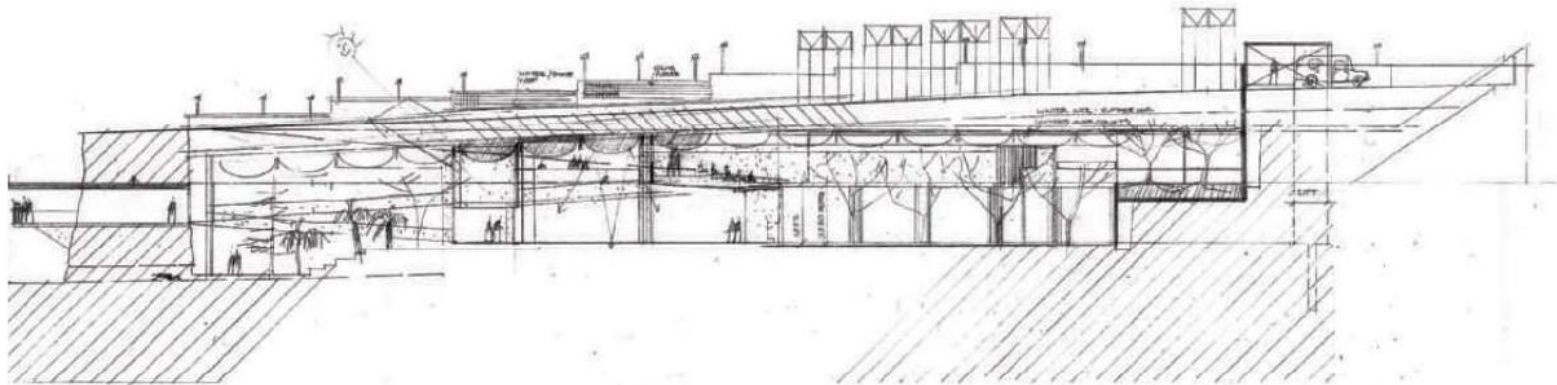

**MOSQUE**

Newport, Victoria  
(with Elevli Cameron  
Architects)

In process

Working in association with Hakan Elevli, Murcutt is using a Modernist vocabulary to create a timeless place for worship that speaks to Islamic architecture's traditional reliance on geometry and repetition, rather than figurative representation.

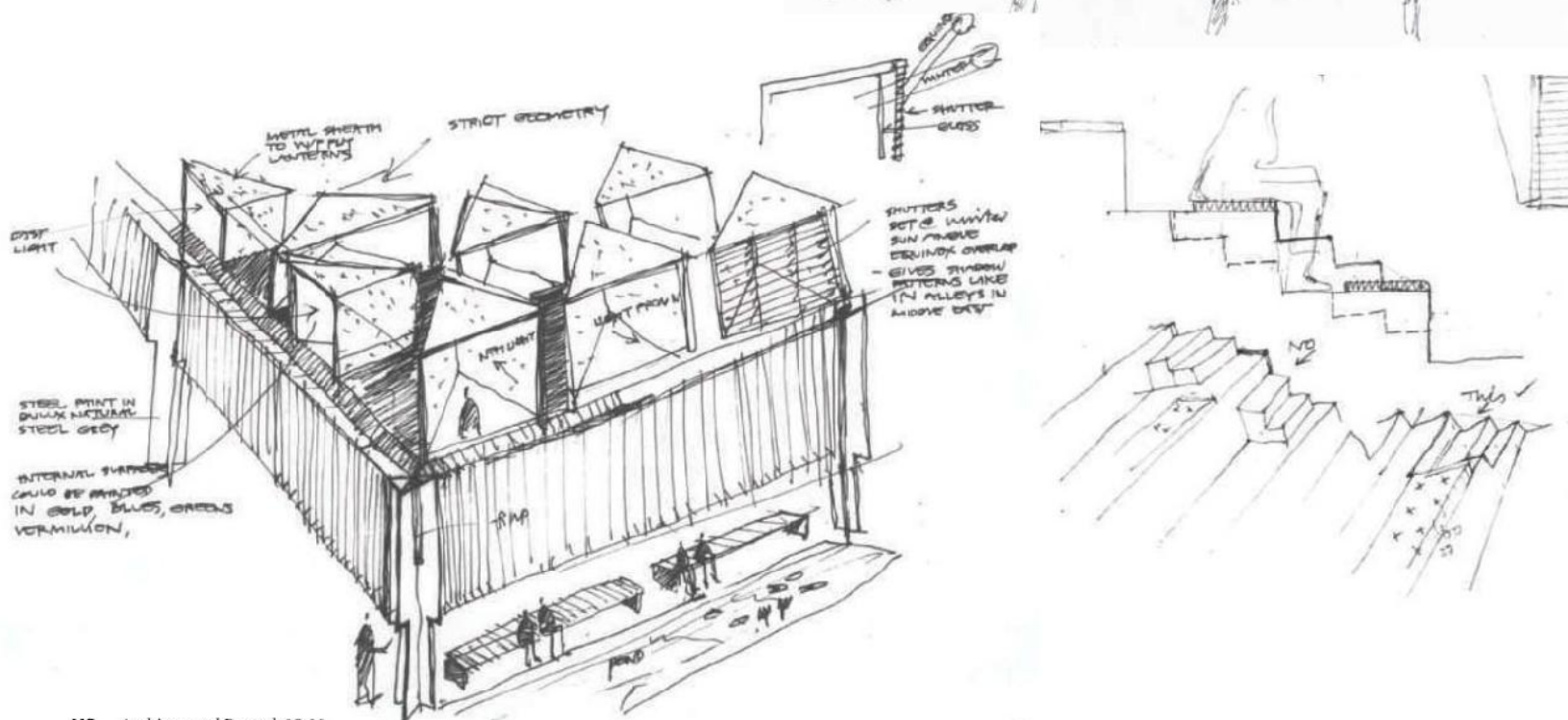

# Sunshades | Composite Panels

Innovation Design Style

**DORALCO**

## ADVANTAGES:

- Product made to your specifications
- Pre-engineered to meet your design criteria
- Design-Build assistance
- Independently tested

**OFFICE BUILDING**  
Boca Raton, FL  
Sunshade canopy & curtain wall sunshades



**EASTERN ARIZONA COLLEGE**  
8" & 17" airfoils inside perforated vertical fins



**STAFFORD HOSPITAL**  
STAFFORD, VIRGINIA  
Composite panel entrance canopy



**DORALCO**  
ARCHITECTURAL METAL SOLUTIONS

INTERTEC | Sunshades and Grilles  
COMPOSITEcore | Architectural Panel Systems  
MACHINE WORKS | Custom Metal Fabrication

doralco.com  
708.388.9324

**CATHEDRAL OF CHRIST  
THE LIGHT**

Oakland

Skidmore, Owings & Merrill  
*Associate Architect: Kendall/  
Heaton Associates*

[RECORD, January 2009, page 86]

Designed by Craig Hartman of Skidmore, Owings & Merrill, with associate architect Kendall/Heaton Associates, this 226,000-square-foot cathedral complex on a 2.5-acre site replaces a building destroyed during the 1989 Loma Prieta earthquake. The new structure, including an abstracted, curvilinear sanctuary 118 feet high that seats 1,350, is an artful composition of concrete, wood, and glass, which lends a thoroughly Modern accent to its representation of Catholic devotion. Jury members noted the project for its creation of connections: to the city, to a nearby park, and to each visitor's own spirituality.

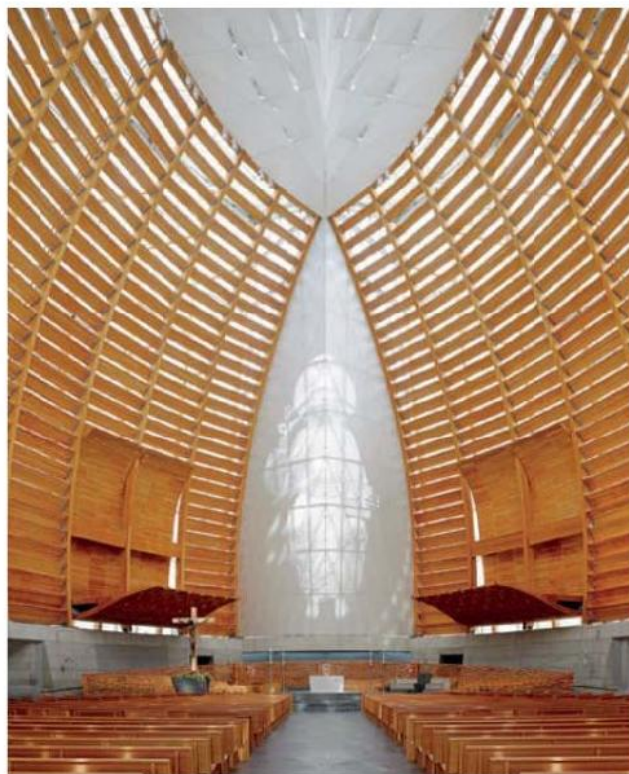

PHOTOGRAPHY: © TIM GRIFFITH (TOP); CÉSAR RUBIO (BOTTOM)



## HORNO<sup>3</sup>: MUSEO DEL ACERO

Monterrey, Mexico

Grimshaw Architects

Associate Architect: *Oficina de Arquitectura*

[RECORD, January 2008, page 96]

A decaying 1960s blast furnace was reimagined as a museum to celebrate the industrial tradition of steel in Monterrey, Mexico. Grimshaw Architects, in association with Oficina de Arquitectura, renovated the existing, 230-foot-high furnace, and added 34,000 square feet of interior and exterior museum space for additional exhibitions, workshops, archives, and educational programs. Often using cutting-edge techniques, and highlighting the program of the museum, the architects have transformed an abandoned industrial complex into a vibrant destination that honors the cultural heritage of the region. The jury lauded the building as, "An ingenious project that made the most with the least, it was designed with restraint and artfully done, and has become a powerful iconic symbol of industrial archaeology."



**CHARLES HOSTLER  
STUDENT CENTER**

Beirut, Lebanon

Vincent James Associates  
Associate Architect: Samir  
Khairallah & Partners Architects

Designed by Minneapolis-based Vincent James Associates Architects (VJAA), in association with Samir Khairallah & Partners, this large student-center complex in Beirut, Lebanon, was created for the American University of Beirut. Rather than consolidating the

project into a single building, as was originally suggested, the architects used the disparate programs of social gathering spaces, sports facilities, a theater, and underground parking to create a network of structures connected to each other and to the nearby ocean with a tissue of gar-

dens and green roofs. This synthesis of architecture and landscape was highly praised by the jury for "smart use of its surfaces and resources in keeping with the local conditions" to create a "rich urban place."

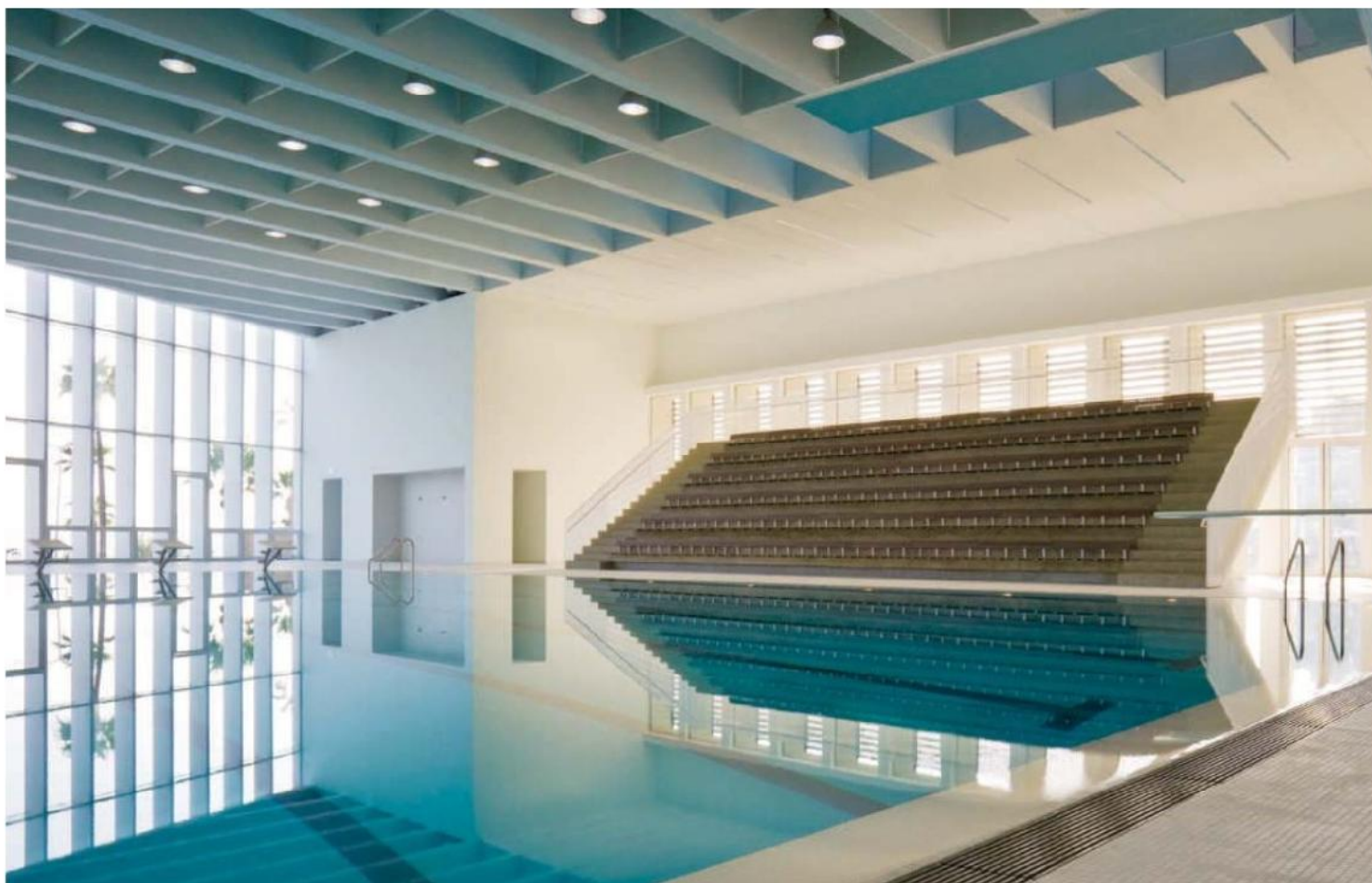

PHOTOGRAPHY: © PAUL CROSSBY

## THE LAVIN-BERNICK CENTER FOR UNIVERSITY LIFE

New Orleans  
VJAA

Associate Architect: Wayne Troyer

Just 14 months after Hurricane Katrina, VJAA, with associate architect Wayne Troyer, completed this 150,000-square-foot student center at Tulane University with a small budget and many sustainable features. Salvaging an old, inefficient concrete structure, the center

uses vernacular New Orleans elements, such as canopies, shutters, balconies, and fans, in combination with a mixed air-conditioning system to control temperature in the building in an ecologically sensitive fashion. Noting that the student body pushed many of the building's

green features, the jury said, "This project offers an opportunity to retrain ourselves to rethink what to expect from buildings and how to transform space to accommodate those expectations. It is training the youth/students about what to expect from buildings."



## BASILICA OF THE ASSUMPTION

(Baltimore Cathedral)  
Baltimore

John G. Waite Associates

This restoration by John G. Waite Associates removed more than 150 years of modifications that had obscured the original vision of Benjamin Latrobe. Completed in 1821, this masterpiece of the Federal Style, which Latrobe helped establish, had suffered years of neglect that turned

this historic structure into an "introspective and dark" place. Restorative efforts included finishing previously unbuilt parts of Latrobe's plan and making the building code- and ADA-compliant, with sustainable HVAC and fire-safety systems that cleverly use the thermally isolating qualities of the cathedral's massive walls. The jury cited this project for rejuvenating a forgotten piece of Baltimore history, "mending our ways to restore, respect, and give new life to buildings by significant architects that are so important to the profession."

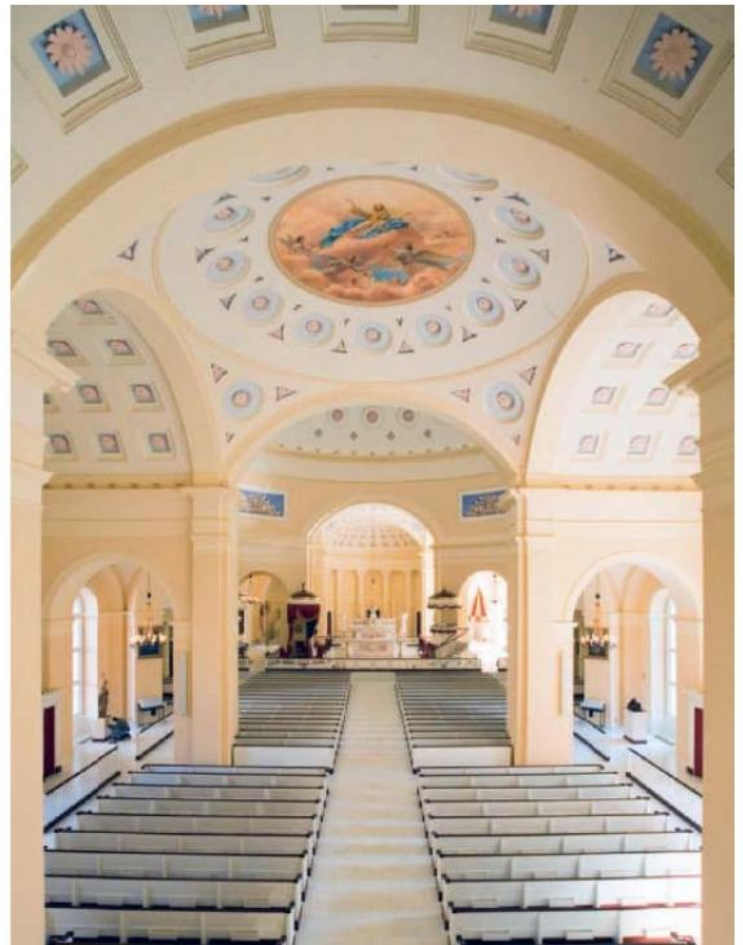





**THE GARY COMER YOUTH CENTER**

Chicago

John Ronan Architects

[RECORD, February 2008, page 114]



This project on Chicago's southwest side is, as *Chicago Tribune* critic Blair Kamin says, "a beacon of hope for an area that needs it." Though it was initially designed for a 300-member drill team, the building's overlapping volumes provide space for a vibrant center that supports a variety

of community-based programs. Skylights and generous interior glazing keep interior spaces light filled, and there is even a green roof above the center's gym – a feature that reflects the environmental sensibilities of the building's late benefactor, Lands End founder



Gary Comer. The jury celebrated the buildings social values, saying, "In a community where most buildings have been leveled, this building ... is bold and aspirational and says that this city and its people are valued and valuable."



**SALT POINT HOUSE**

Dutchess County, New York

Thomas Phifer and Partners

[RECORD, January 2008, page 144]

Nestled into woods in New York's Hudson Valley, this ingenious house was praised by the jury for "mesh[ing] with the environment in a way that is completely unexpected." Though its form is spare – a simple rectangular volume – the modest, 2,200-square-foot structure uses an unorthodox stainless-steel screen to dematerialize its presence in the landscape and provide shade. The result is a building that achieves a profound connection with its surroundings through simple materials and structural economy.

# The medium is light. The canvas is SunGuard.

Building with light. That's what SunGuard Advanced Architectural Glass from Guardian is all about. Our comprehensive range of products, colors and design solutions allows you to explore fully the aesthetic and functional possibilities of light – both interior and exterior – while meeting demanding energy and performance requirements. For complete product information, a searchable project database and more, visit [SunGuardGlass.com](http://SunGuardGlass.com) or call us at 1-866-GuardSG (482-7374).

And learn about the many ways Guardian helps architects build some of the world's most innovative buildings. With light.

**Visit us at the AIA Convention, Booth #427.**

**GUARDIAN  
SUNGUARD®**  
ADVANCED ARCHITECTURAL GLASS

BUILD WITH LIGHT®

SunGuard® and Build With Light® are registered trademarks of Guardian Industries Corp.  
©2009 Guardian Industries Corp.

CIRCLE 129



## THE NEW YORK TIMES BUILDING

New York City

Renzo Piano Building Workshop  
and FXFOWLE

[RECORD, February 2008, page 94]

This iconic, 52-story addition to the New York City skyline was welcomed by the jury for the “amazing serenity that emanates from the building in contrast to the chaos of its surroundings.” Using a double curtain wall that increases energy efficiency, the

building is notable for its extensive use and control of natural daylight, coupling the glass walls with an exterior sunscreen of white ceramic rods. The architects’ abundant research of dynamic lighting and new HVAC technologies resulted in office

spaces with shading that responds automatically to shifts in sunlight patterns, and underfloor air – the largest installation of such HVAC technology in Manhattan.



## PLAZA APARTMENTS

San Francisco

Leddy Maytum Stacy Architects

Associate Architect: Paulett

Taggart Architects

Part of San Francisco mayor Gavin Newsom’s “Housing First” program, this nine-story building holds 106 highly efficient studio units for chronically homeless individuals. The building includes a number of on-site amenities, including health- and mental-service clinics, retail, and a black box theater for the Filipino performing arts group that previously occupied the site. Colored infill composite panels, made of wood veneer, resin, and recycled craft paper, give the building a bright presence on the street, and its environmental strategies – rooftop photovoltaic cells, operable windows, recycled and local materials, and natural light and ventilation – earned the project a LEED silver rating.

# When you add it all up, there's prime value in **ZERO**

## **ZERO INTERNATIONAL, Inc.**

Known industry-wide for quality gasketing, hinges and thresholds for doors and windows—and the advanced technology in our sealing systems for sound control, fire and smoke protection, and other specialized applications.

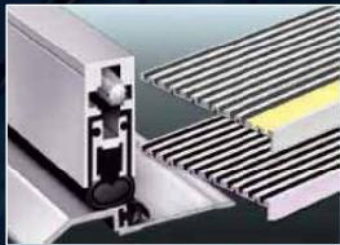

## **ADVANTAGE LITES & LOUVERS, Inc.**

Door louvers and vision lites manufactured by our newest subsidiary, available with ZERO specialized systems or separately.



## **IND-EX, Inc.**

One-stop shopping for top-quality custom extrusions in the shapes, colors and lengths required, delivered on time. Specializing in all types of rubber—including hard to satisfy silicone—and plastics.



## **INTUMET™, Inc.**

Proprietary INTUMET intumescent materials and systems manufactured at our New York facility, ensuring convenient domestic sourcing and stable pricing.



## **ZERO WESTERN DISTRIBUTION CENTER (Las Vegas)**

Stocking high-demand products for the western states for shipment within 24 hours of receiving orders for in-stock items.



## **ZERO SEAL SYSTEMS, Ltd. (UK)**

Distributing USA products and services to the European market.



*ZERO is more than great door and window gasketing designed and manufactured with legendary quality. The sum of our parts equals unique flexibility in satisfying special requirements. We listen. We deliver exactly what you specify. And we make sure it lasts.*

*Building on 85 years of strategic growth and expansion, our family of companies offers an unequalled spectrum of essential technologies and expertise. All from a single source...all in-house.*

*Need something special? Specifying precision products for demanding applications? Looking for a partner to help you break away from the pack? Here's where ZERO adds total value you won't find elsewhere.*

Wherever you are and whatever your needs, ZERO knows how to make things work right. And we know how to make relationships that last. Call 1-800-635-5335 or 1-718-585-3230 to begin building on the true value of ZERO.

*All products manufactured in U.S.A.*

**Our new ZERO and ADVANTAGE product catalogs are available — printed or online.**



[www.zerointernational.com](http://www.zerointernational.com)  
[www.a-ll.com](http://www.a-ll.com)

**TOWN HOUSE**

Washington, D.C.

Robert M. Gurney, FAIA



In this residential conversion of a previously commercial space, the architect "reinvets the town house" by boldly rethinking the allocation of space and unlocking the inherent potential of daylighting. Previously murky, the space was opened up considerably by sacrificing floor



space in favor of a progressive design that allowed for an open stairwell system that connects all three floors and allows light to seep into all areas. This effect was heightened by removing a different part of the third floor in favor of skylights, and by completely reworking the back

facade of the house to admit as much light as possible into every area of the building. Exposed brick walls, painted white, add to the lightness of the residence, and an adventurous blue epoxy floor provides a sense of energy and fun.





**SCHOOL OF  
AMERICAN BALLET**  
New York City  
Diller Scofidio + Renfro

The School of American Ballet in Manhattan's Lincoln Center impressed judges with an urban approach – densification – to the need for two additional dance studios. Rather than build entirely new facilities, the existing headroom of two older studios was co-opted

by two new studios that appear to float above the lower floor. The new spaces are supported by steel beams and recede from the peripheral walls. Floor-to-ceiling glass allows for views, daylight, and a sense of shared application with the studios below. Additionally, a mezzanine

lounge between the new studios is walled in by liquid crystal walls that change from clear to opaque at the flip of a switch, according to the needs of students and teachers.



PHOTOGRAPHY: © PAUL WARCHOL

**IFAW HQ**

Yarmouth Port, Mass.  
designLAB Architects



The International Fund for Animal Welfare (IFAW) moved to Cape Cod, Massachusetts, more than 30 years ago after facing increasing threats at its previous, Canadian location. In the meantime, the organization has grown rapidly. The IFAW needed to consolidate five offices

spread across three towns, and after keeping a low profile for decades, it decided to build an open, sustainable facility that celebrated the organization's long-time relationship to the Cape. Transparency was paramount for the IFAW's mission, and the office is bathed in direct, filtered,

and diffused light. This design, along with a general sustainable mind-set, has put the IFAW on track for LEED Gold certification. The Cape's influence is apparent in the warm wood and nautical accents throughout the building – a nod to the area's tradition of shipbuilding.



**THE HECKSCHER FOUNDATION FOR CHILDREN**

New York City  
Christoff:Finio architecture

[RECORD, June 2008, page 162]

The Heckscher Foundation for Children faced a unique challenge when it set out to convert a narrow New York City town house, built in 1902, into a modern office. The

somewhat stuffy residence was utterly transformed by a bold solution that involved separating the floor planes from one of the long supporting walls, creating a striking, light-filled void. The floors and glass offices now appear to be floating in the air, suspended by steel rods connected from a single point in the roof. As the jury put it, "The observer never has the feeling of being between the two long and dark party walls."



PHOTOGRAPHY: © PETER VANDERWALKER 2008 (TOP TWO); ELIZABETH FELICELLA (BOTTOM TWO)



## JIGSAW

Washington, D.C.  
David Jameson Architect



The Jigsaw house ambitiously recycles a traditional single-story home located on a busy corner. Radically transformed, the structure is oriented around an open courtyard carved out of the old foundation, providing natural light to every room of the house from both

sides. The new design began with the interior, taking into account the occupants' experience moving from one space to another, and visually blurring the boundaries between inside and out. Puzzlelike volumes comprise an ever-changing matrix of spaces, providing a rich variety of

airy and stimulating areas. Glazing and window constructs are placed artfully to allow optimal privacy to the homeowners, when desired, without sacrificing views or light penetration. Reflectivity is key for the Jigsaw, with a lively interplay of solid and void.

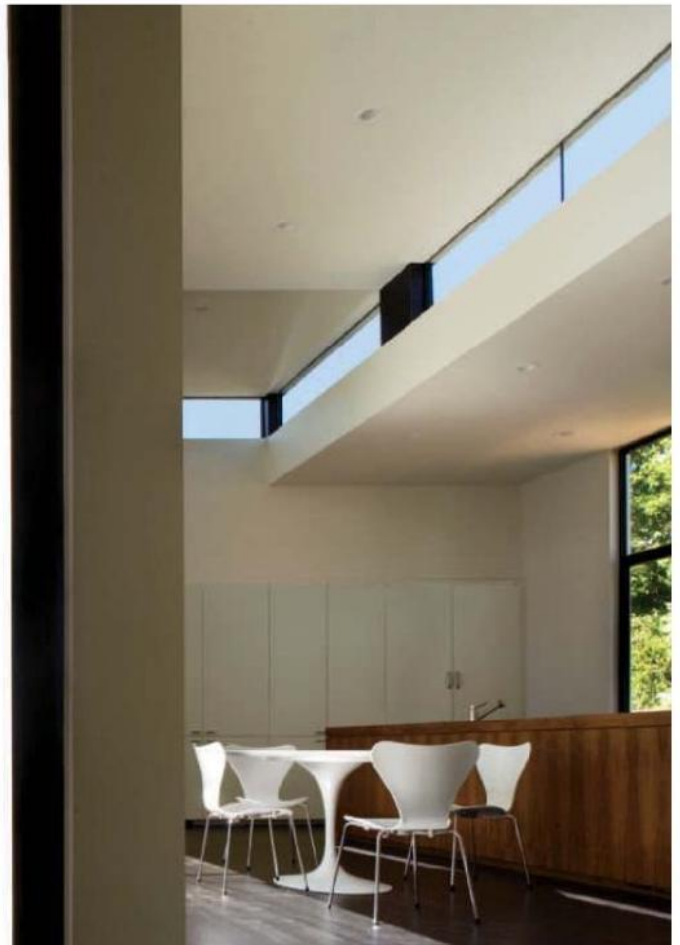



**CHRONICLE BOOKS**

San Francisco

Mark Cavagnero Associates

This popular San Francisco-based publishing company, dissatisfied with its office space in a historic downtown building, opted for a drastic renovation of its existing work space to better meet its needs. The result, integrating a previously problematic four-plate concrete floor, provides greater light penetration to the interior and highlights the existing brick walls and heavy timber structure. Chronicle Books emphasizes a strong communal work style, and the new renovation rearranged the flow around varied work patterns. Meeting rooms, a library, a café, podcast rooms, and other collaborative work spaces help create a charged social atmosphere while still preserving necessary private space. The top floor of the building provides the best views and is democratically reserved as a central gathering point for all employees.

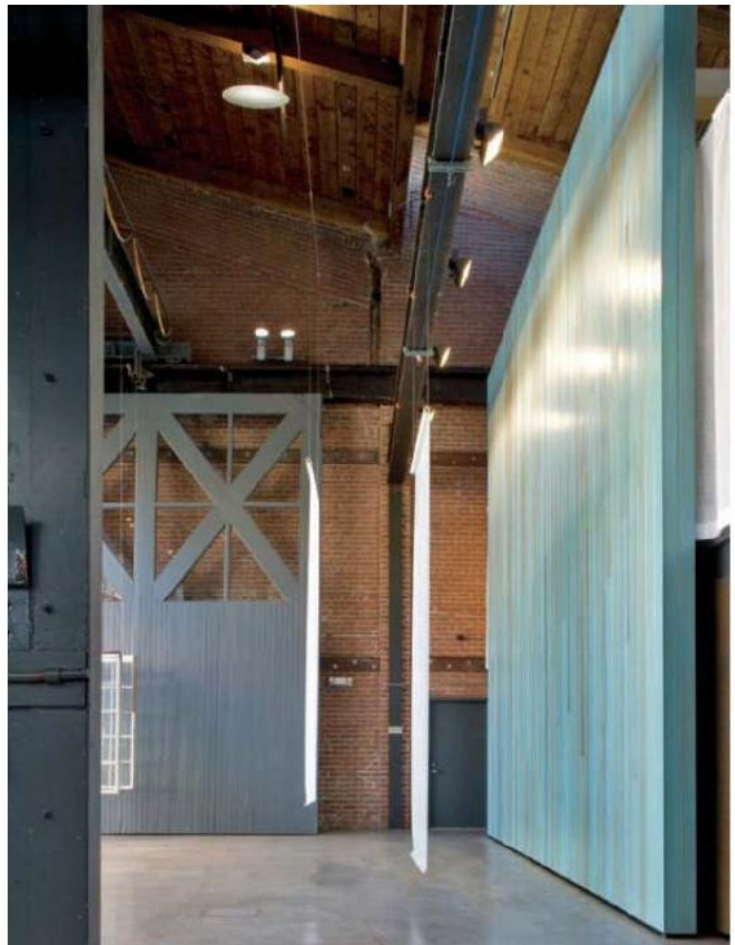
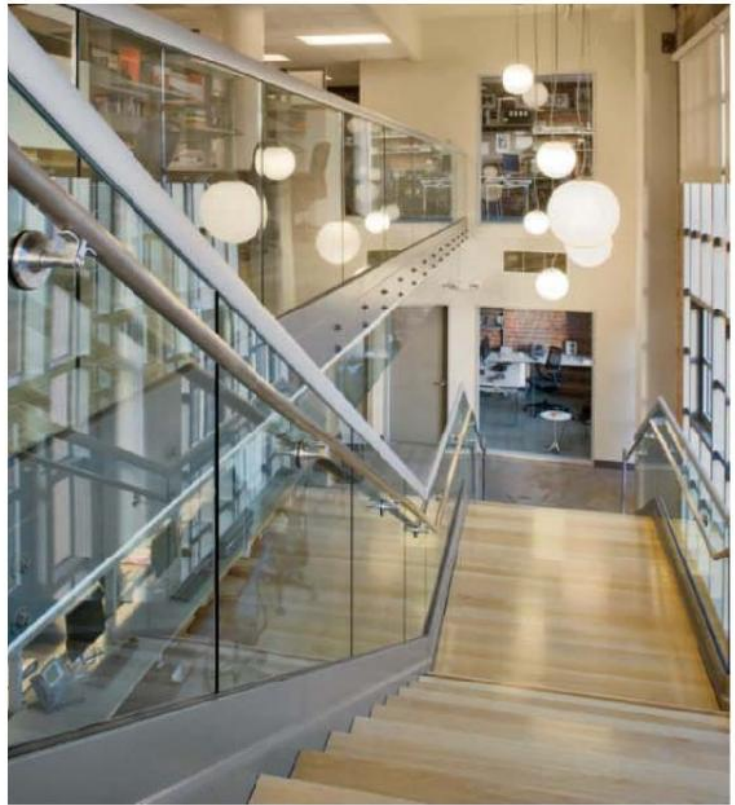

PHOTOGRAPHY: © DAVID WAKELY PHOTOGRAPHY



Lightwise® Architectural Systems Energy Efficient Glass Block Panels.

**Lets in what you want in. Keeps out what you want out.**

Learn more: 800-871-9918 or [POSSIBILITIESBEGIN.COM/ENERGY](http://POSSIBILITIESBEGIN.COM/ENERGY).



PITTSBURGH CORNING™

MADE IN AMERICA 

CIRCLE 62

## BARCLAYS GLOBAL INVESTORS HEADQUARTERS

San Francisco  
STUDIOS Architecture



Celebrating San Francisco's historic tradition as both a cultural and banking capital, Barclays Global Investors headquarters expresses a level of playfulness and ingenuity rarely seen in large office projects. The spaces are remarkably open, providing an abundance of light, with splashes of color from tasteful

laminated glass and accent lights. Low partitions, high ceilings, and glass-fronted offices and conference rooms imbue the space with a sense of transparency, particularly emphasized by the top-floor executive conference center, an all-glass volume with a full view of the city's financial sector. Employees are

encouraged to interact in a variety of ways with a range of interspersed meeting and break spaces, including a landscaped roof deck on the eighth floor. Judges note that the interior's relationship to the base building "makes the whole better than the sum of its parts."





# Option

#537

Far From Ordinary

Every project is different, so using the same window or door for each project won't do. You need options. Who better to provide you with those options than Kolbe? With virtually endless options, like custom shapes that incorporate dramatic curves and unique divided lite patterns, Kolbe windows will take you far from the ordinary to design something extraordinary. For more information visit [www.kolbe-kolbe.com](http://www.kolbe-kolbe.com) or call 1.800.955.8177.

**KOLBE**  
■ WINDOWS & DOORS ■

*See the Difference Quality Makes®*

**R.C. HEDREEN**

Seattle  
NBBJ



R.C. Hedreen sought a major transformation of its traditional office on the second floor of Seattle's Art Deco Olympic Tower Building, built in 1927. The company decided to move forward by going back, restoring and emphasizing several original elements of the historic building.

The office now features a bright, open-air arrangement based around 15-foot-wide "thoroughfares" that act as meeting places, work spaces, and art galleries. R.C. Hedreen owns a serious collection of contemporary art, and the new display arrangements interact in a "restrained but

beautiful" fashion with the cabinet work and detailing. Concrete columns run along the floor, some of them clad in leather. Light now penetrates deep into the space, filtered by window screens and partitions, adding to a refined, almost ethereal atmosphere.

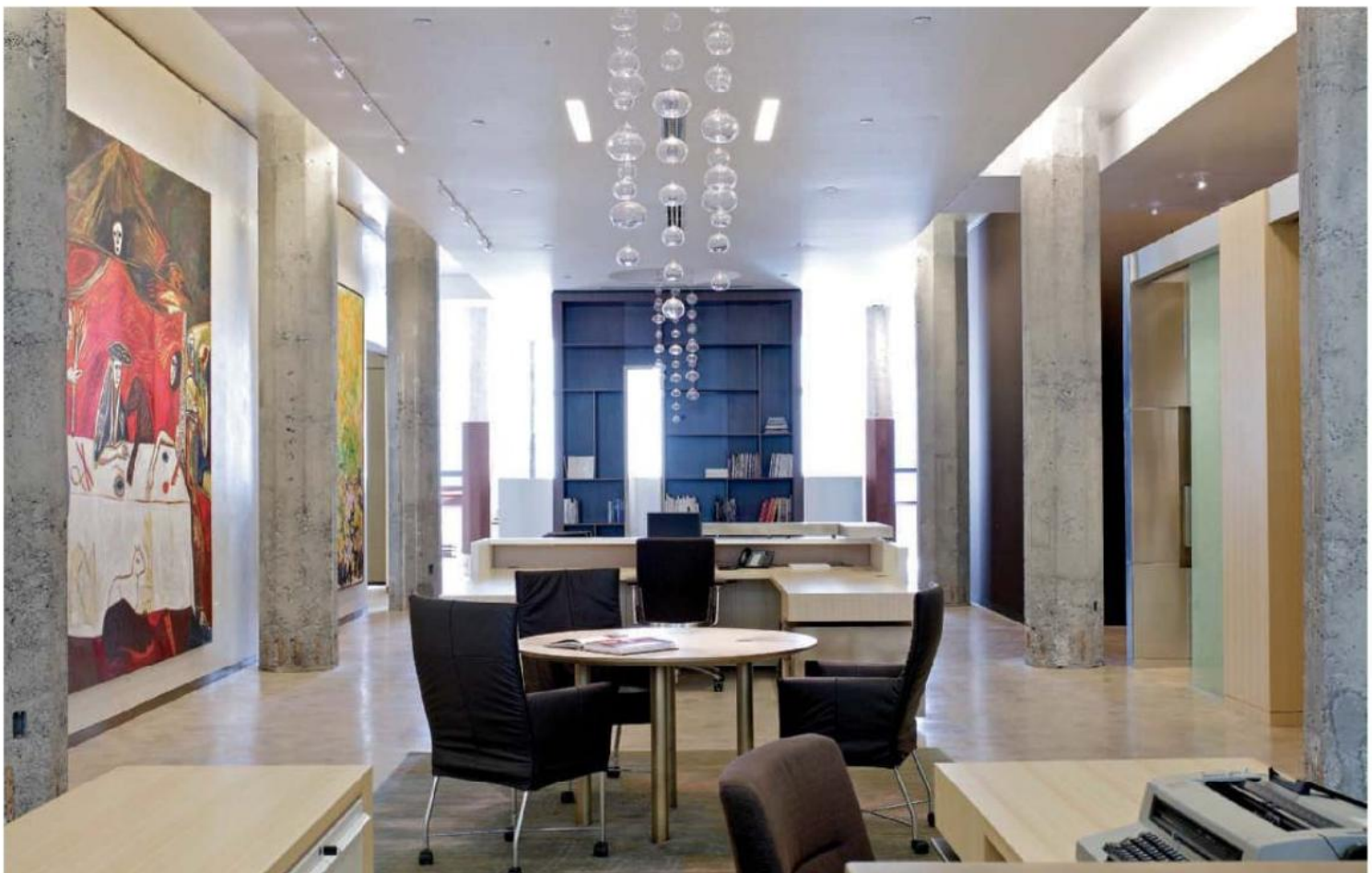

PHOTOGRAPHY: © TIM SOAR



# ARCHITECT



# GUARDIAN

© 2005 Kawneer Company, Inc.

**It's our goal to make sure you can be both.** Our sustainable solutions and products allow you to realize your vision while living up to your responsibilities to the planet.

**EVERY DAY YOU MAKE A CHOICE. MAKE A CHOICE THAT COUNTS.**

Architectural Aluminum Systems  
Entrances + Framing  
Curtain Walls  
Windows

[kawneergreen.com](http://kawneergreen.com)

See us at booth #1845.



**TISHMAN SPEYER HEADQUARTERS**

New York City  
Lehman Smith McLeish

Tishman Speyer's corporate headquarters, consolidated into newly renovated offices in historic Rockefeller Center, can at first glance pass for an art gallery. Primarily a property holding company, Tishman Speyer maintains a massive collection of contemporary

art, and a primary goal when carving out new volumes in the almost 80-year-old space was properly integrating this art portfolio with the company's business portfolio as a selling point for prospective clients. The interior ranges from an ultra-Modern office area cut by strong,

clear lines to large, several-story, light-filled volumes that serve primarily as gallery spaces. The artwork suffuses most of the white spaces throughout the complex, and judges noted that the architecture "doesn't compete" with the art, but instead "respects it without being a white box."



**SHEILA C. JOHNSON DESIGN CENTER**

New York City  
Lyn Rice Architects

[RECORD, September 2008, page 126]

Seeking to reorganize its ad hoc collection of campus facilities in Greenwich Village, Parsons The New School for Design reestablished a cutting-edge identity with the Sheila C. Johnson Design Center. The concept centers around forming an "urban quad" that connects the campus and provides multiuse spaces for

the student body. Drawing the urban environment into the glass-covered indoor quad was key in establishing the center's authentically "gritty aesthetic." New entrances and a streamlined central space connect fluidly to galleries, an auditorium, lounge spaces, an orientation center, and seminar rooms. Visually, the existing frameworks were stripped to steel and concrete foundations, creating a spare industrial context for the abutting educational facilities while letting student design work stand out in various exhibition spaces.



PHOTOGRAPHY: © PETER AARON/ESTO (TOP TWO); MICHAEL MORAN (BOTTOM TWO)



## Pilkington Pyrostop®

Fire Resistance Glass

### Product Features

- Optical clarity of clear glass
- High visible light transmission
- Human impact safety rated to Cat II
- Classified by Underwriters Laboratories
- 45, 60, 90, 120 minute products available

Find out more. Contact Technical Glass Products (TGP)  
at 800-426-0279 or visit [www.fireglass.com](http://www.fireglass.com)  
Pilkington Fire Protection Glass North America  
[www.pilkington.com/fire](http://www.pilkington.com/fire)



**PILKINGTON**  
NSG Group Flat Glass Business



**ORANGE COUNTY  
GREAT PARK**

Irvine, California  
TEN Arquitectos

Upon completion, the Orange County Great Park will cover some 1,400 acres of land on a site that once housed the El Toro Air Force base in Irvine, California. A man-made canyon will bisect the park, which will connect existing residential communities in

the area. The park, situated along a freeway and a rail line connecting Los Angeles to San Diego, should draw travelers. AIA's jurors lauded "the use of the former runway as an inspiration and opportunity" to form the canyon, "a supergraphic that creates

an urban poetic gesture at a large scale." The program includes several cultural and arts centers to house community activities, an arboretum, a sports park, an amphitheater, and an aviation museum with information about the site's military history.



See what's new at **KOHLER**.com/pro



**Saile™ One-Piece High-Efficiency Toilet.**  
Featuring Dual Flush technology and a skirted trapway,  
Saile is the essence of modern sophistication.

**CIRCLE 66**

THE BOLD LOOK  
OF **KOHLER**®

## FOSHAN DONGHUALI MASTER PLAN

Guangdong, China  
Skidmore, Owings & Merrill

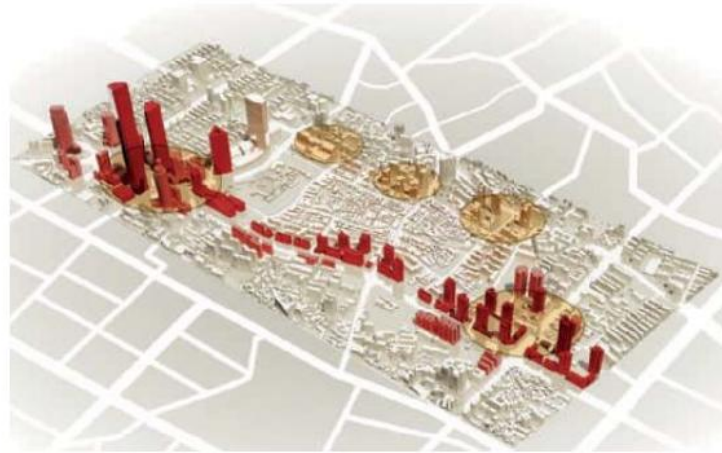

The Foshan Donghuali Master Plan, which began last year – with a full build-out expected in 2018 – tries to achieve two seemingly opposing goals: conserving historic architecture while developing new, sustainable buildings. The Zumiao Temple in Donghuali Old Town is some 900 years old, and like much of the

historic architecture in rapidly developing China, was at risk of falling into disrepair or being demolished; the new master plan will restore and protect it. After a detailed survey of the town's historic buildings, the planners decided which other neighborhood buildings to save and which to replace with context-sensitive infill.

Jurors noted that the conscientious mix of old and new “appears to be an approach not often used in city planning for China, and can perhaps become a model for the effective balance of historic conservation with high-density development in such a fast-growing urban environment.”



PHOTOGRAPHY: COURTESY SOM (MIDDLE TWO AND TOP RIGHT);  
DRAWINGS: SOM/© CHRISTOPHER GRUBBS (BOTTOM TWO)

# Energy Efficiency is a Concrete Difference

Compare an eight-inch thick concrete wall to a four-inch thick Kingspan insulated metal panel. Our wall is 2,300% more thermally efficient. Kingspan panels require less structural support, contain recycled content, and provide a weather-resistant barrier that does not absorb water or promote mold growth.

Plus, Kingspan panels are feather light compared to concrete - roughly 1/18 the weight. This means significant energy savings can be achieved by reducing structural support requirements, in addition to the energy saved in transportation and installation.

Learn how Kingspan insulated metal wall panels can contribute to LEED® credits.



The Global Leader in Cladding Solutions



LEED is a registered trademark of USGBC.



[www.kingspanpanels.us](http://www.kingspanpanels.us)

USA: 1-877-638-3266

Canada: 1-866-442-3594

**TREASURE ISLAND  
MASTER PLAN**

San Francisco

Skidmore, Owings & Merrill  
Associate Architects: SMWM,  
CMG, BCV Architects, Arup,  
Hornberger + Worstell

Applying an urban design strategy that is sustainable by its very nature, this project employs an inventive use of solar and wind patterns generating an urban plan with a diagonal grid meant to protect public spaces from inhospitable winds. Other sustainable design strategies include an organic

farm, wind turbines, and the carefully chosen location of open spaces as reconstructed wetlands.

The plan takes advantage of limited access to the island to allow a balance between open space and dense urban fabric – an urban fabric that has the necessary height and

footprint for a vital community.

The orientation of the tall buildings at the end of open spaces and streets provides visual terminus and concentrated development at the ferry stop. Rather than cluster the towers, this separation allows light and air to flow between them.



**PORCHSCAPES:  
BETWEEN  
NEIGHBORHOOD  
WATERSHED & HOME**

Fayetteville, Arkansas  
University of Arkansas  
Community Design Center

Porchscapes is a Habitat for Humanity development in Fayetteville, Arkansas, that aims to be both affordable – construction costs run about \$60 per square foot after infrastructure investment – and environmentally sustainable. The jury wrote that Porchscapes “demonstrates that architecture doesn’t have to cost more to achieve its urban design and architectural goals.” The project is a LEED Neighborhood Development (LEED-ND) pilot project, and uses Low Impact Development (LID) to naturally clean runoff water. With rainwater gardens, bioswales, and other natural filtering techniques, rainwater and runoff will be filtered in the neighborhood, a community whose motto is “parks, not pipes.” Jurors celebrated the project as a “paradigm shift from what is perceived as a typical Habitat project.”



RENDERINGS: SOM/© DBOX (TOP TWO)

CertainTeed's fiberglass ceilings are uniquely constructed to reduce noise in ways other materials simply can't match.

Their high NRC means sound energy is better absorbed, leaving just quiet comfort behind...

And our fiberglass ceilings offer great sustainability, with natural moisture resistance for a more durable, no-sag ceiling panel. But best of all, the manufacturing process for fiberglass produces 40% or less carbon emissions per square foot of ceiling tile than mineral fiber.

# WE KNOW QUIET.

*Discover CertainQuiet™ with  
CertainTeed Ceilings.*

Please  
visit us at  
AIA booth  
#1629!



800-233-8990 • [certainteed.com](http://certainteed.com)

**CertainTeed** 

*Quality made certain. Satisfaction guaranteed.™*

**EXTERIOR:** ROOFING • SIDING • WINDOWS • FENCE • RAILING • TRIM • DECKING • FOUNDATIONS • PIPE  
**INTERIOR:** INSULATION • GYPSUM • **CEILINGS**

**THE CENTRAL PARK OF THE NEW RADIANT CITY**

Guangming New Town, China

Lee + Mundwiler Architects

In the province of Shenzhen, China, lies a suburb called the New Radiant City. Formerly a farming town known as Guangming, the New Radiant City is meant to alleviate some of the strain put on Shenzhen's infrastructure as a result of the fact that it was China's first capitalist-friendly Special Economic Zone. While the state has flourished, the influx of immigrants and rapid industrialization have strained the city. The Central Park of the New Radiant City is planned to be a 680-acre park in the city's center that jurors call "beautiful and ingenious." Of particular note is the project's "attention to the existing landscape and topography." Pavilions punctuate the spaces, and paths weave through the hilly landscape. When it is complete, the park should provide visitors with a reprieve from the city's hyper-industrial character.

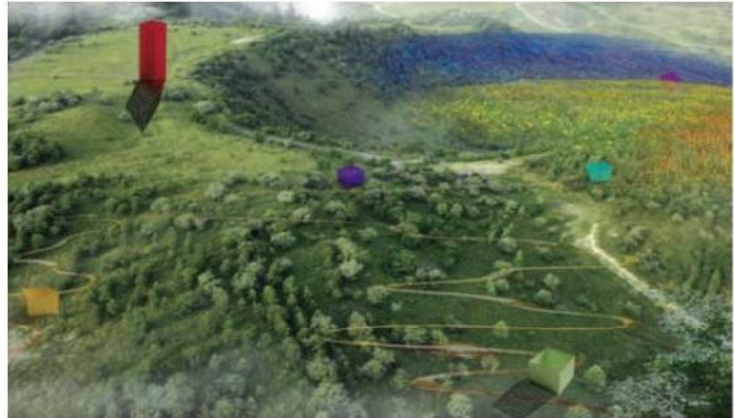
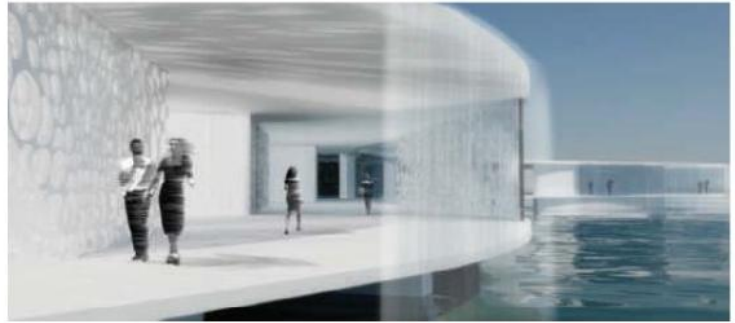

**SOUTHWORKS LAKESIDE CHICAGO DEVELOPMENT**

Chicago

Sasaki Associates

Associate Architects: Skidmore, Owings & Merrill

The Southworks Lakeside Chicago Development will reclaim the 600 acres of vacant land that once was home to a major steel works facility. The size of this blank slate, which borders Lake Michigan for some 1.5

miles, is unprecedented in the city, and it offers an opportunity to build a comprehensive sustainable community. The project will comprise a variety of distinct districts. The AIA jurors "welcome the irregularities in the plan resulting from well-considered view corridors and idiosyncrasies in the surrounding urban fabric. They create a wide variety of experiences and places." The LEED-ND pilot project is expected to take some 40 years to complete and includes plans for a 100-acre lakefront park.





NO ONE MAKES IT EASIER  
TO UPGRADE YOUR BUILDING.

Economy and cost savings are bigger factors than ever when deciding how to make the best use of an existing building. Which makes EFCO's broad line of retrofit solutions a smarter choice than ever. EFCO windows, curtain walls, entrances and storefronts can give your existing building a durable, attractive and energy-saving future. And our expert sales team will make the process cost-effective and collaborative. Find out more by calling 1-800-221-4169, or go to [efcocorp.com](http://efcocorp.com).

WHERE WINDOWS ARE JUST THE BEGINNING.





**FANEUIL HALL  
MARKETPLACE**

Boston

Benjamin Thompson  
& Associates

The August 1976 ribbon-cutting ceremony for the reinvented Faneuil Hall Marketplace was planned as a modest affair. But a crowd of 50,000 flooded the complex, kicking off an impromptu four-day party with street performers and revelers filling the historic site. The frisson in the air no doubt came from the wide realization that this was the beginning of something new.

After more than 10 years of struggle to secure permits and financial backing, from 1976 to 1978 the office of Benjamin Thompson & Associates, with developer James Rouse, transformed Boston's original public market: a derelict trio of block-long brick-and-granite buildings designed by Alexander Parris and built between 1824 and 1826 on 6 acres. Rather than restoring the complex back to one specific time, Thompson's approach was to celebrate the variety of styles – Greek Revival, Federal,

Victorian – that had contributed to the complex's evolution over the years, and to distinguish contemporary additions. Even in the '70s, the architects recognized the sustainable value of salvage and adaptive reuse on a large scale. Focusing on fresh and prepared foods and other goods provided by local vendors, the complex was envisioned as an urban gathering center, and has become known as the forebearer of the festival marketplace.

At a time when American cities were withering, Thompson's vision was to "reassert the values of urban life and to preserve urban quality, vitality, and beauty on a human scale." Faneuil Hall, or Quincy Market, was an immediate success. "It was the engine for the city for the next two decades," says Thompson's widow and professional partner, Jane. "Downtown development went off like fireworks after it opened. It brought people

off the highways, and pedestrians are the life of the city." The message resonated, and the project has been widely imitated, helping to spawn an American urban renaissance.

This project and the Design Research Headquarters Building in Cambridge, Massachusetts (winner of the 25 Year Award in 2003), represent the firm's commitment to urbanism, says Jane Thompson. "The activation of the street has finally been accepted into the vocabulary of what good architecture does," she notes.

As for the marketplace, physically and conceptually it endures. Though it has weathered the inevitable storms of chain commercialization and tourist merchandising, and though, like the city around it, it is now all grown up, Faneuil Hall Marketplace has maintained its vitality, and to this day emanates a youthful optimism. *Beth Broome*





Ben Thompson reinvented an ailing historic marketplace with the intent of creating a modern retail center to reenergize the city of Boston. The project reflects a strong commitment to urbanization and sustainability.



PHOTOGRAPHY: © MEDIUM IMAGES/PHOTODISC (OPPOSITE); STEVE ROSENTHAL (MID LEFT AND BOTTOM); BETH BROOME (TOP)

Pushcarts occupy the pedestrian streets (opposite) and the porches that flank the central building (top). An aerial view (above) shows Faneuil Hall in the foreground, the Quincy Market building with its great dome, and the North and South Market buildings. The Rotunda (right) provides a place to eat.

## Olson Sundberg Kundig Allen Architects

Seattle

Many readers may have come to know the work of AIA's 2009 Firm of the Year, Olson Sundberg Kundig Allen Architects (OSKA), through media coverage of such projects as Delta Shelter [RECORD, April 2006, page 92], Rolling Huts [RECORD, April 2008, page 134], and the much publicized Chicken Point Cabin. Sited in dramatic natural settings, the residences incorporate an abundance

of glazing, a raw materiality, and the use of kinetic metal gadgetry that operates apertures and/or propels movement. These projects are the work of partner Tom Kundig, FAIA, whose architecture is both understated and bold, sometimes unpredictable, and always fresh. Though Kundig's award-winning projects may have brought national awareness to the firm, his work rep-

resents only a portion of the office's overall output, developed since 1966, when Jim Olson, FAIA, founded a one-man operation in Seattle.

Rick Sundberg, FAIA, joined the office in 1974, when Olson was in partnership with Gordon Walker. After Walker left, Sundberg became a partner in 1985. Kundig and Scott Allen, AIA, joined Olson Sundberg in 1985 and 1986,



respectively, becoming partners in 2000, when the firm became Olson Sundberg Kundig Allen Architects, as it is known today.

Each partner's work varies in approach from Kundig's. Olson's widely published and award-winning projects focus primarily on residential work for major art collectors across the country. He is recognized for his ability to combine architec-

ture, art, landscape, and furnishings into a completely integrated whole. Sundberg is regarded as the urbanist and civic proponent among the partners, serving as the green strategist in a firm that has historically held to sustainable principles. Allen served as the managing partner of the group until this February, when he left the firm to begin a new career.



The staff of Olson Sundberg Kundig Allen Architects pose in their Seattle offices.



The Rolling Huts  
Mazama, Washington  
2005-07



1

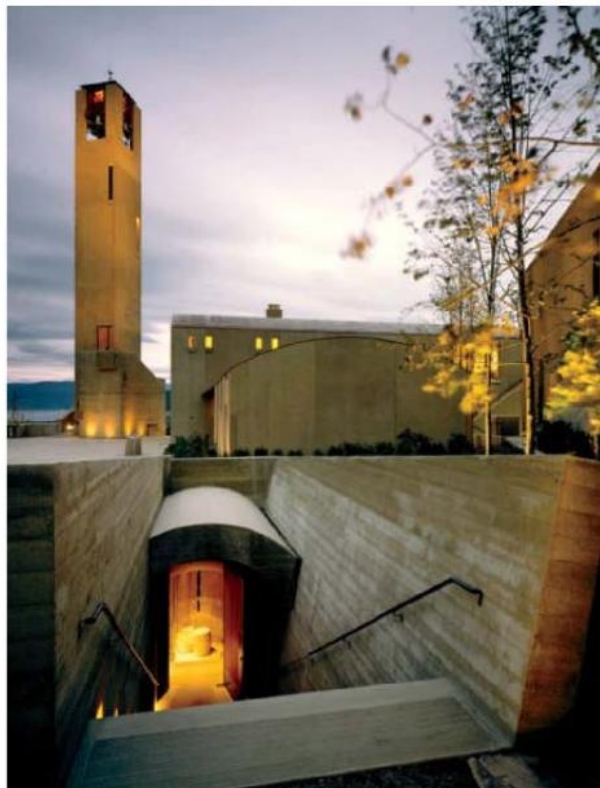

2

**Mission Hill Winery** | 1, 2  
Westbank, British Columbia, 2001

**Earth House** | 3, 4  
Longbranch, Washington, 1969

**Outpost** | 5  
Central Idaho, 2007



3



4

5





**Wing Luke Asian Museum** | 6  
Seattle, 2008

**1900 First Avenue** | 7  
Seattle, 2012 (estimated)

**Delta Shelter** | 8  
Mazama, Washington  
2005–07

**Pike + Virginia** | 9  
Seattle, 1978



6 7

Last year, Alan Maskin, AIA, and Kristen Murray, AIA, became partners, with Murray replacing Allen as managing partner. Maskin, who joined the firm in 1992, oversees the visual representations of the firm's portfolio and focuses on the design of museums, exhibitions, and stage sets. Murray, known as a generalist, has had 25 years of experience working at OSKA, often taking the role of the planner on

projects, investigating a problem, looking at options, and establishing a path for the design process.

A firm of such diverse talents is not prone to easy assessment. As architecture critic Paul Goldberger has noted, "In an age in which most architects actively seek to achieve the identity of a 'look,' Olson Sundberg Kundig Allen's work eschews simple similarities. Certain principles are evident from

one building to another, as is the absence of direct historical replication, but consistency is not the same as a packageable style." This lack of pattern results in part from the varied proclivities of the partners, the participatory voices of the team members, and the changeability of the team's composition. OSKA maintains a fluid structure in designing its buildings; in a profession that

typically operates on the studio system, organized either around building types or the partners themselves, this firm does neither. Assignments are based on project schedules and needs and staff skills and interests, with the intention of "cross-pollinating" capabilities and personalities. One gets the impression of an 85-member family that works in a true collaborative spirit in its Seattle offices, located



8



9



2

**Montecito Residence** | 1, 2  
Montecito, California, 2007

**Sun Valley Center  
for the Arts** | 3  
Ketchum, Idaho, 2010 (estimated)

**Noah's Ark at the Skirball** | 4  
Los Angeles, 2007

on the top two floors of a former warehouse in Pioneer Square.

On Thursday evenings at the weekly "crit," the collective genius of the firm is put to the test, challenging design decisions that might include strategies for site or design development, sustainability, or how to stay within the budget. Murray says, "The crit is intended to stimulate thought and

mirror the way the team learned to communicate in school. It also has social underpinnings and allows the staff to see what else is going on in the office."

The majority of the partners have spent their lives in the Pacific Northwest; indeed, the four original partners all attended the University of Washington in Seattle. Their design inspiration draws from the

region's old-growth forests, the mist and diffuse light, and the proximity to the sea. These natural conditions, combined with indigenous traditions of wood- and metalworking stemming from the area's lumber and industrial past, suggest the firm's style, one that focuses on the integration of indoor and outdoor spaces, buildings with broad overhangs, and the

use of heavy-timber construction.

OSKA has made the transition from a firm with a regional sensibility to one worthy of national and even international distinction. Says Kundig, "We are fortunate to be able to work with great clients in our remote, moist little corner up here. To be recognized on so many levels by our peers and colleagues is truly gratifying." *Jane F. Kolleeny*



3



4

PHOTOGRAPHY: © NIKOLAS KOENIG (TOP LEFT); TIM BIES/OLSON, SUNDBERG KUNDIG ALLEN ARCHITECTS (TOP RIGHT); GRANT MUDFORD (BOTTOM RIGHT)



The fire protection to fit your need. The beauty to fit your design. The price to fit your budget.

**VT** Architectural  
INDUSTRIES Wood Doors

[WWW.VTINDUSTRIES.COM](http://WWW.VTINDUSTRIES.COM)







# XYPEX PRODUCTS PROTECT CONCRETE AND THE ENVIRONMENT

**Beinggreen** [xypex.com](http://xypex.com)

In these ways and more, Xypex products pass the world's environmental tests:

- ✓ No VOCs (Volatile Organic Compounds)
- ✓ Concrete with Xypex can be recycled
- ✓ Enhances curability for longer building life
- ✓ Produced globally. Distributed locally
- ✓ Innovative 'green' technologies
- ✓ Energy efficient



We don't always wave our green, environment-friendly flag, but Xypex, and its family of crystalline concrete waterproofing products have always had a warm relationship with their surroundings. *Being There* in more than seventy countries for more than forty years has given us a global understanding of environmental standards and expectations. We continue to support programs like ISO and building-rating systems like LEED that reinforce product quality, corporate responsibility and today's environmental concerns. To Xypex, *Being There* and *Being Green* are ongoing commitments.

Energy efficiency, material selection, minimizing site impact, and VOC reduction – these are the 'green' benefits that non-toxic Xypex products provide the construction world and the pursuit of environmental sustainability.

**Beingthere** IN MORE THAN 70 COUNTRIES. FOR MORE THAN 40 YEARS.



# TEXT™

Virco's all-new TEXT™ Series includes dozens of table, seminar and desk models with more than 15 options and accessories for power/communications, wire management, mobility and storage.



For more information, call us today at **800-448-4726** or visit our website at [www.virco.com](http://www.virco.com).

See Us At AIA Booth #839

**VIRCO** – equipment for educators™



REF# 08202  
©2009 Virco Inc.

Smart, New, Affordable Bronze Hardware from Trimco.

# SAINT-GAUDENS



*the beauty of fine design, the eternity of solid bronze*



by **Trimco**

SOLID BRONZE HARDWARE

# BRONZECRAFT

HANDCRAFTED SOLID BRONZE  
HARDWARE



by  
**Trimco**  
trimcobbw.com

LOS ANGELES, CA 90023 | 323/262-4191 | trimcobbw.com

FOR PRIVATE & PUBLIC USE.

Visit TRIMCO at AIA booth 230

CIRCLE 73

# SO GREEN THEY PRACTICALLY GROW ON TREES

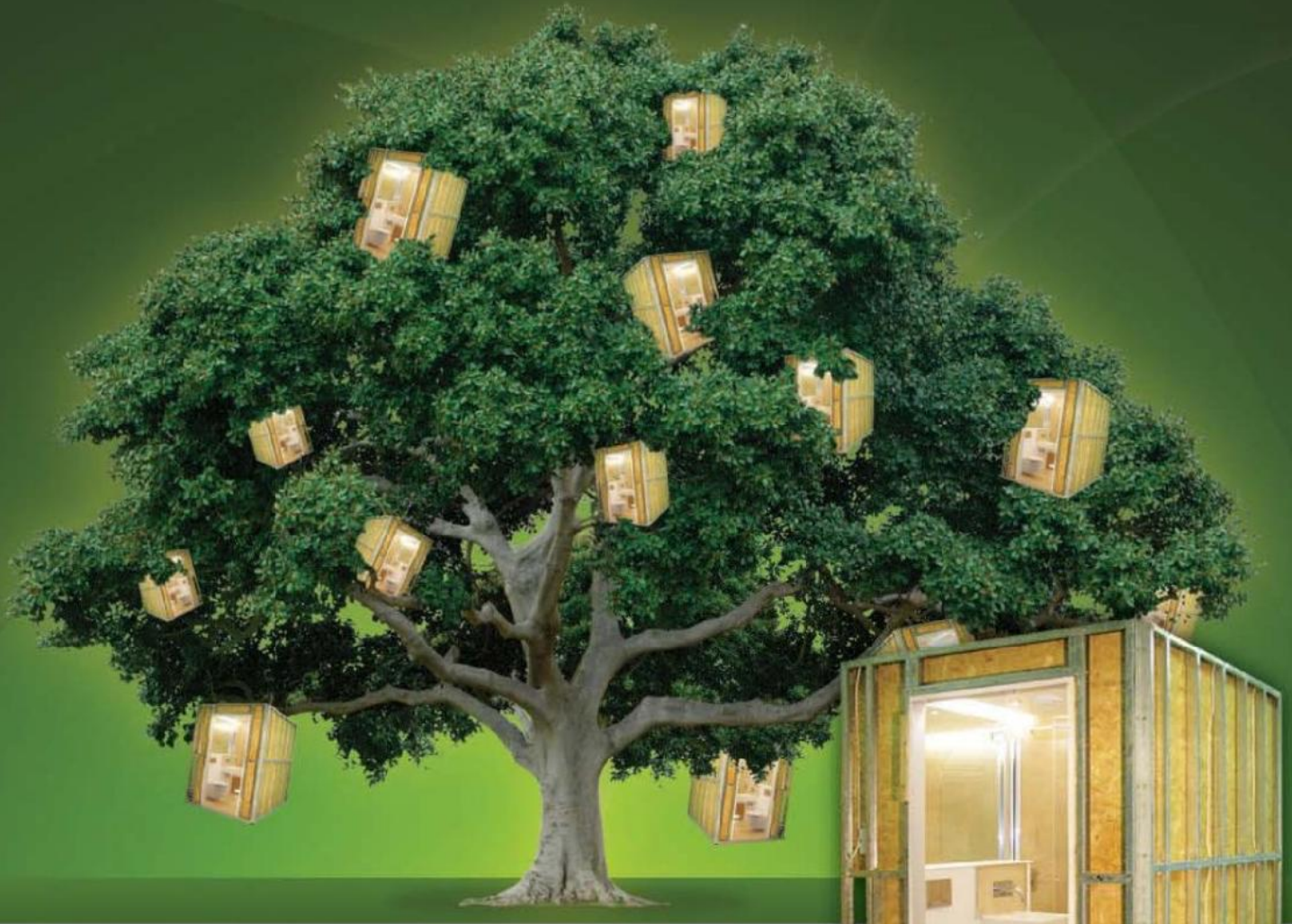

Kullman Bathroom PODS™ utilize the latest green technology, contribute to LEED® points and are even reusable. Complete with fixtures and finishes, Kullman Bathroom PODS are factory-built and installed Plug and Play at your site.

To simplify your next green construction project, visit us on the web at [www.kullman.com](http://www.kullman.com) or call for a **FREE CATALOG & TECHNICAL GUIDE** at 1-888-567-KPOD (5763). **Bathrooms. Simplified.™**



We build it.



We deliver it.



We install it.

**KULLMAN**  
BATHROOM PODS

# WHENEVER. WHEREVER.

On the beach. In the comfort of an overstuffed chair. During your commute to work. When you're stuck on a plane. With the NCARB monograph series you can earn your health, safety, and welfare PDUs whenever you want ... wherever you want.

Just log on to the NCARB web site and order one of the more than 20 titles written by leaders in their fields. When your monograph arrives, settle into your favorite lounge chair (or squish into your plane seat) and read about some of the latest developments in the profession.

When you are ready to take the quiz, simply log onto our secure site, and answer the questions. You'll receive your results immediately. Once you pass, you can even print your own certificate of completion.

Current NCARB Record holders can earn PDUs/CEUs for less than \$16 per unit—the lowest cost per PDU/CEU available. Your payment covers the monograph, quiz, scoring process, and one free retest if needed. NCARB also reports your passing score to the AIA at no extra cost.

Say goodbye to expensive out-of-town seminars, boring conferences, and late-night classes. Earn your HSW units on your schedule with NCARB's monograph series.

**Learn and earn with NCARB!**  
**[www.ncarb.org](http://www.ncarb.org)**

NCARB  
MONOGRAPH SERIES

NCARB

SERIES

National Council of Architectural Registration Boards  
1801 K Street, NW, Suite 700K Washington, DC 20006



# JuliusBlum&Co.Inc.

## The Strength of Design



Handrail brackets. Wall brackets. Vertical mounting brackets. Carlstadt® self-aligning brackets. Brackets for use with JB® Glass Railing. Fabricated in the USA, tested and in stock for immediate shipment.

Julius Blum & Co. Inc. is the nation's largest supplier of architectural metal products.

For complete information on all components, request a free Catalog or visit [www.juliusblum.com](http://www.juliusblum.com).

### JuliusBlum&Co.Inc.

P.O. Box 816 Carlstadt, NJ 07072 • 800 526 6293 • 201 438 4600 • Fax 201 438 6003 • [www.juliusblum.com](http://www.juliusblum.com)

# SNAP™



Need product info?  
Get it in a SNAP.

**SNAP™, the product tabloid from McGraw-Hill Construction Sweets – the absolute authority on architectural products.**

SNAP reaches over 65,000 architects – every active architectural firm operating nationally and locally. Twice as many architects as any other product tabloid in the field.

**Putting products first to drive action fast.**

SNAP is designed to find and select products in a snap!

**Visit us at Booth N4447 at A.A.**





INSPIRING TUSJING



## A REVOLUTION IN WOOD

Until recently, beautiful wood types were traditionally associated with rain forest wood. Kebony has changed all that. Now there is a new type of wood available. Choose Kebony - a revolutionary new type of wood. As aesthetic, strong and durable as rain forest wood, yet 100% environmentally friendly.

Call Kebony Inc on tel: +1 888 914 9995 or send an e-mail to: [revolution@kebonny.us.com](mailto:revolution@kebonny.us.com).

[www.kebonny.us.com](http://www.kebonny.us.com)

CIRCLE 77





Committed to cleaner, healthier air in schools.



Choose any of our products that are GREENGUARD Children & Schools<sup>SM</sup> Certified and you'll know they've met the highest standards in indoor air quality. Our family of certified products includes:

- Gold Bond<sup>®</sup> BRAND XP<sup>®</sup> Gypsum Board
- Gold Bond<sup>®</sup> BRAND SoundBreak<sup>®</sup> XP<sup>®</sup> Gypsum Board
- Gold Bond<sup>®</sup> BRAND Hi-Abuse<sup>®</sup> XP<sup>®</sup> Gypsum Board
- Gold Bond<sup>®</sup> BRAND Hi-Impact<sup>®</sup> XP<sup>®</sup> Gypsum Board

**National**   
**Gypsum**<sup>®</sup>

Technical Info: 1-800-NATIONAL  
or visit [nationalgypsum.com](http://nationalgypsum.com)



The GREENGUARD Children & Schools Mark is a registered certification mark used under license through the GREENGUARD Environmental Institute.

## A GOOD DAY AT THE OFFICE

We all dread it – that Monday morning schlep to the office and the start of yet another workweek. But what if the office were an exciting place to pass the day, or at the very least, a pleasant one? **Four new office buildings in cities in the United States, Asia, and across Europe offer inspiring alternatives to the dreary, cubicle-infested work environments to which so many of us have sadly become accustomed.**

In Shanghai, KPF's soaring **WORLD FINANCIAL CENTER** vies for the title of "world's tallest," while Robert A.M. Stern Architects' **COMCAST CENTER** settles for tallest in Philadelphia. In both cases, though, it's not the height of the buildings that makes them stand out, but the amenities they offer. Occupants plug in to state-of-the-art technology and kick back to breathtaking views. Both structures, immediate icons in their respective city's skylines, also provide grand civic spaces at their base.

The **GAS NATURAL** headquarters in Barcelona, by Enric Miralles Benedetta Tagliabue, and Murphy/Jahn's **MERCK SERONO** headquarters in Geneva (this page) make less of an impact on the cityscape, but instead respond to the smaller-scale structures and historic urban fabric of their European contexts. In each, bright, expansive atria or landscaped public plazas complement the daylight-filled offices. Josephine Minutillo



# EMBT Architects

creates a headquarters  
that explodes onto  
Barcelona's waterfront for  
**GAS NATURAL**

By Josephine Minutillo

**W**hen Jean Nouvel's colorful Agbar Tower was completed in 2005 [RECORD, January 2006, page 88], it became an instant icon of Barcelona—its singular image plastered on the sides of the city's *Bus Turístic*, and souvenirs in its suggestive shape peddled up and down the tourist-laden La Rambla alongside similar tchotchkes of Gaudí's Sagrada Família Cathedral and Norman Foster's Telecommunications Tower. The same fate did not await a newer tower that began to rise out of the harbor just as Agbar, farther inland, was topping off. Built as the headquarters for another utility—Agbar houses the local water company—the complex assembly and varied forms of the Gas Natural building resist a clear iconography.

Rather than being a beacon within the cityscape, the Gas Natural tower embraces the very elements that make up the Catalan capital's unique urban fabric, to emerge from the site as an almost natural outgrowth. It's no surprise, then, that the architects, Enric Miralles Benedetta Tagliabue (EMBT), were intimately familiar with this stretch of Barcelona's waterfront, their offices just a few blocks away.

The studio's proximity to the site was not necessarily an advantage, however. In 1999, Gas Natural invited eight local, but internationally recognized, firms to compete for the design, which would return the company headquarters to its original location by the sea. "We believed the building should be a friendly insertion in the district, and eliminated the submissions that introduced a barrier between the city and the sea," says Antoni Flos, Gas Natural's director of construction. "In the end, we selected EMBT's building because it was more innovative and more attractive for the city."

The bold, glass-covered building—which includes a curving tower and five stories of dramatically cantilevered offices—would be the first tall building by Miralles in his home city, where he is revered by fellow architects for his design of dynamic structures and public spaces throughout Catalonia, though less known outside of Spain, except for the controversial Scottish Parliament building in Edinburgh [RECORD, February 2005, page 98]. But the favorite son would not get to see this project realized, succumbing to a brain tumor only months after winning the design competition. "I never thought it would get built," Tagliabue recalls. "But the client believed in the project and was courageous enough to see it through."

Located along the Ronda del Litoral, the major



EMBT's design for the Gas Natural headquarters, a bold addition to Barcelona's waterfront, included the landscape around the building's curving forms.

PHOTOGRAPHY: © DUCCIO MALAGAMBA

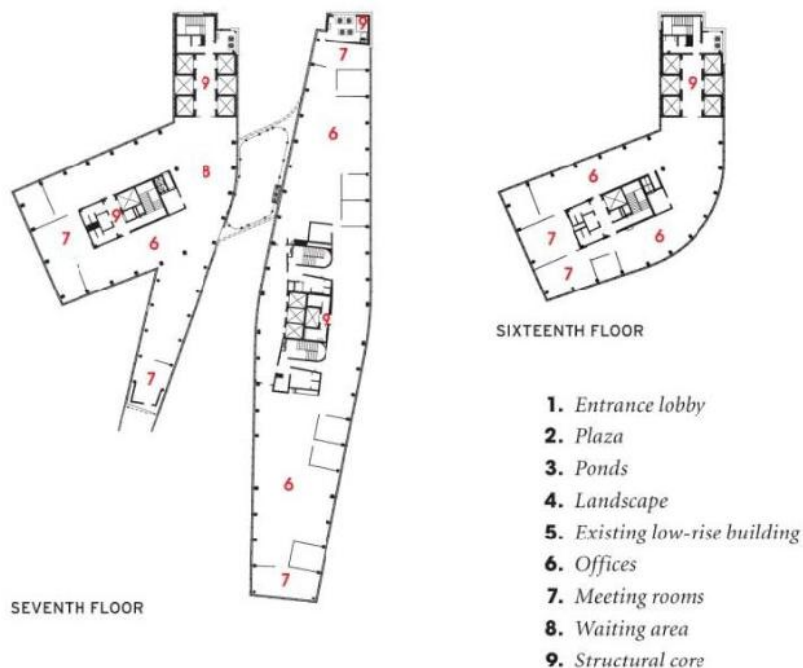

coastal bypass for motorists, the site represents a confluence of old and new, large scale and small scale, dense areas and open spaces. Just past the crowded medieval city where the beachside Barceloneta neighborhood begins, the building sits directly across the tracks of the busy Estació de França railway station. Spread out over an entire city block, the building's energetic composition reflects that jumbled backdrop. Though the tower reaches a height of only 262 feet, the overall arrangement is breathtaking—a result of the striking contrast between the verticality of the tower and the horizontal layout of the adjoining low-rise office blocks and, even more palpably, the five floors suspended from a separate structure midway up the length of the tower.

The “bridge,” as it is called, cantilevers 138 feet out from its central core, leaving the workers inside to float above the generous landscaped plaza EMBT designed for employees and the public at the building's base. The horizontal sway in high-rise buildings is imperceptible to most of us, but first-time visitors prone to motion sickness may feel some queasiness when walking through the bridge, even if employees quickly become accustomed to the slight up-and-down movement (see sidebar, page 165). Hovering 60 feet from the ground, the bottom of the bridge forms a symbolic arch with the tops of the adjacent apartment buildings, an evocative gesture on the architects' part, referring to Barcelona's Arc de Triomf, which lies in a direct axis with the Gas building. Perched as it is however, EMBT's structure has none of the monumentality of the historic arch, but instead looks as if it is about to take off alongside the passing trains that swoosh by beneath it.

EMBT, which continues to work on high-profile international projects, intended the Gas building's assembly—including another impressive, faceted cantilevered structure protruding from the tower—to be as dynamic as possible, likening it to a flickering flame (a product of gas). But a stocky, rectangular structure—an existing building the client wished to maintain on the site—stood in their way. “It was an ugly building and at a completely different scale,” says Tagliabue.

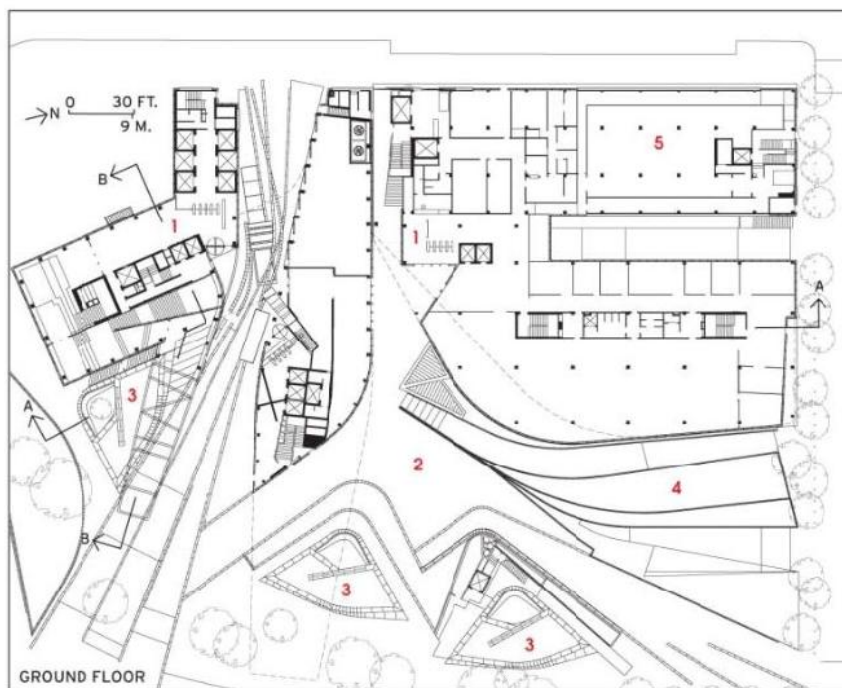

The building takes on a different shape from each direction. The cantilevered portion seems most dramatic on the approach from the medieval city (opposite), and from across the railway tracks, where it appears to be in motion with the passing trains (this page). Aerial views show it with Barcelona and its mountains in the background (inset, top) and sandwiched between the Ronda del Litoral and the sea (inset, bottom).



The playful, multidirectional seats EMBT custom-designed for the small auditorium were made by local furniture company, Alis (below). The daylight-filled interiors in

the tower, including the ground-floor lobby (right) and stairwells (bottom), feature a simple palette of oak in a variety of finishes on the walls and slate for the floors.

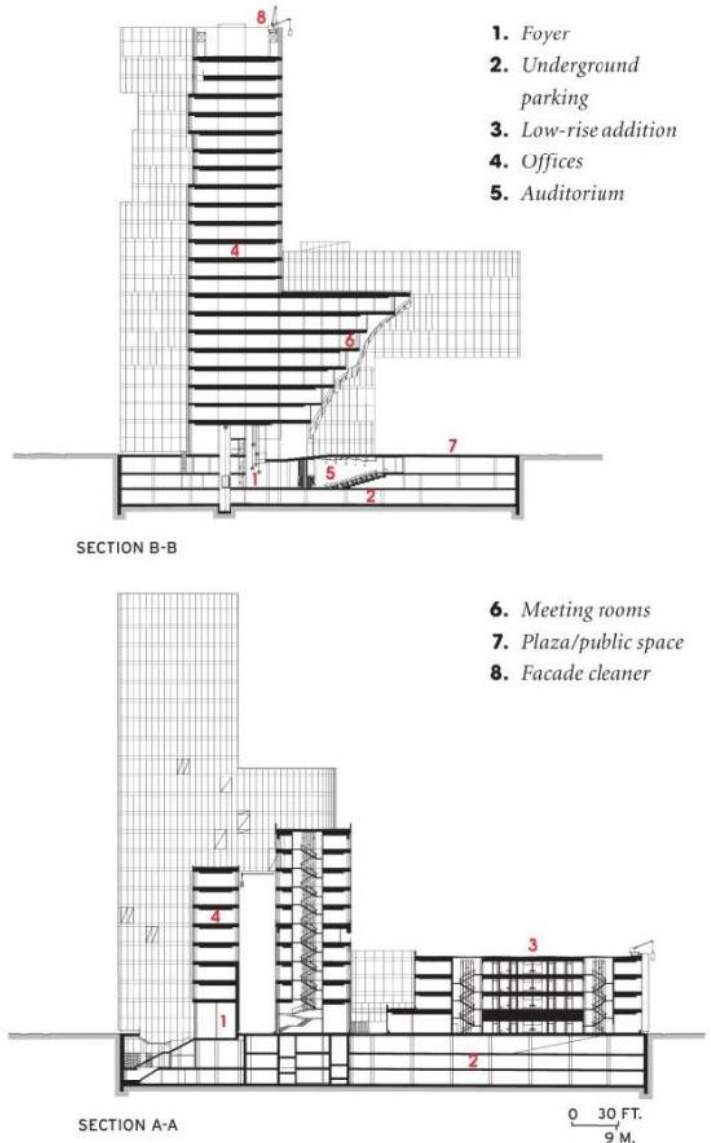

## ONE PART VERTICAL, ONE PART HORIZONTAL

There was no lack of skeptics when EMBT proposed cantilevering five floors of offices more than 100 feet without any support, but Madrid-based engineer Julio Martínez Calzón didn't blink at the challenge. His office, MC2 Estudio de Ingeniería, has worked with Santiago Calatrava and Tadao Ando, among others, on structurally innovative buildings and bridges in Spain and internationally.

Calzón offered the architects almost a dozen options for achieving the cantilever, including a lamellar skin, a rhomboidal system, and a radial arrangement in which each of the hanging elements would be suspended from one point atop a vertical spine. Miralles opted for the most straightforward approach, a simple Howe truss.

The steel megastructure, in fact, contains twin trusses. Each of the vertical, horizontal, and diagonal truss members is composed of hollow rectangular tubes, while I-beams make up the transversal elements that span the trusses.

In plan, the overall structure, which is 60 feet off the ground and 60 feet tall, is symmetrical on one axis around a poured-in-place concrete vertical core at the center. One half of that assembly, the visible overhang, is suspended from the central core. The other half is em-

bedded within the rest of the building and anchored at the opposite end by another vertical core. Two additional structural cores are located in the tower. The structure of the overall building assembly was considered when determining the calculations for the cantilever.

According to Calzón, the cantilever is extremely stiff, more so than most taller high-rises, which are essentially vertical cantilevers resisting lateral wind forces. The length (or height) of those "cantilevers" is usually 10 to 12 times greater than their depth, whereas the ratio in the Gas building's cantilever is slightly more than 2:1 at 138 feet long by 60 feet deep, causing less vertical deflection than the average horizontal sway we are accustomed to in tall buildings. Under the most extreme conditions, the maximum deflection in the Gas building's cantilever is just under an inch. In average conditions, it is imperceptible to most occupants.

"Even though at the time [1999] it was highly unusual to include such a large cantilever in an office building, figuring out its structure was easy for me, since I typically work on bridges," Calzón admits. "In the years since we started working on this, though, I've noticed that these types of structures are becoming the fashion in building design." *J.M.*

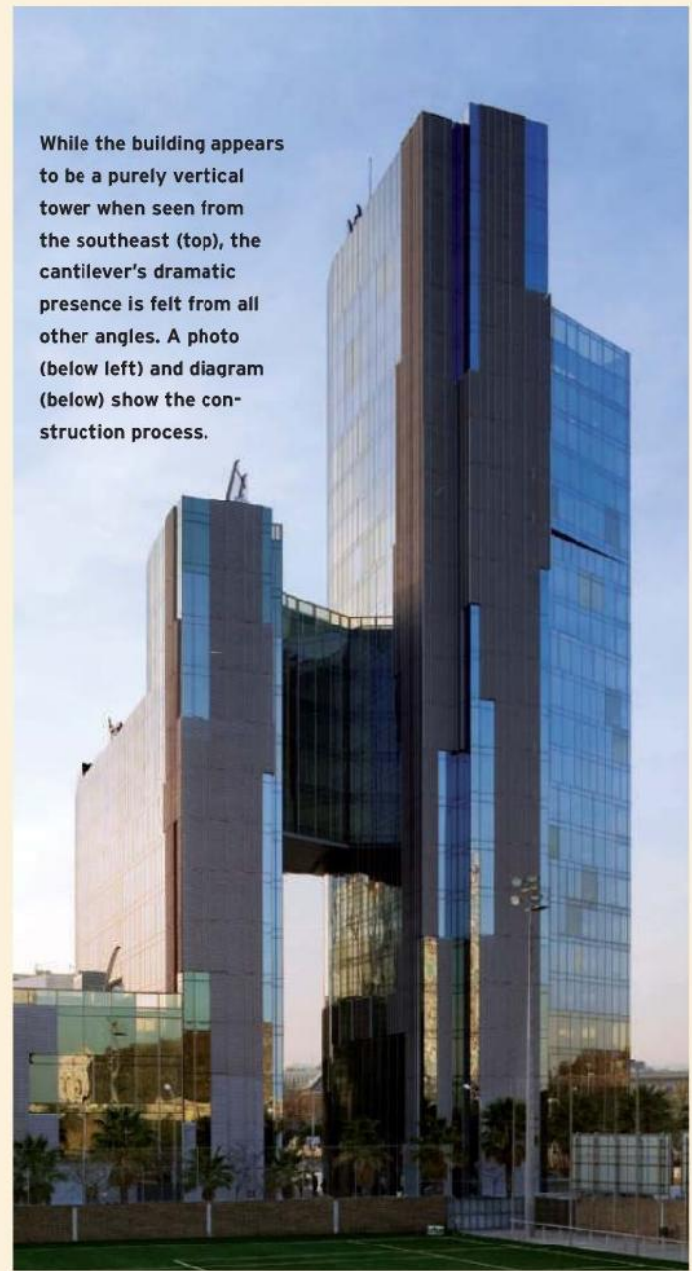

While the building appears to be a purely vertical tower when seen from the southeast (top), the cantilever's dramatic presence is felt from all other angles. A photo (below left) and diagram (below) show the construction process.

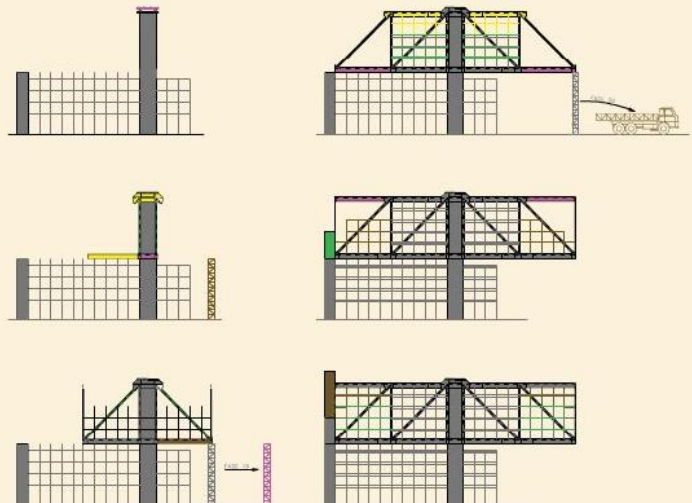





“To make it disappear, we doubled it.” They designed a second office block at similar dimensions to the original, cladding both of them in the same glass as the bridge and tower. “There is a lot of facade,” Tagliabue jokes. “We proposed something similar for an American building, but it didn’t go over as well.” The client here spared little expense for the \$80 million project: Besides the added cost for cladding so many perimeter walls, Gas Natural hired full-time security personnel rather than install unsightly bollards to control access to the building.

Though early schemes featured various cladding materials and large windows, the facade’s final incarnation was inspired by the glass office towers Tagliabue and Miralles had seen in Houston, where Miralles was receiving medical treatment during design development. Metal louvers conceal air-handling equipment over portions of the facade, especially at the main entrance between the tower and base of the bridge, and along the length of the back of those same structures.

The abundant glazed surfaces and narrow floor plates allow daylight to penetrate deep into the interiors. The bright, airy offices—finished with simple white walls, oak floors, and light carpet—provide an ideal work environment free from the maze of bulky cubicles that plague most offices. More enticing are the spectacular, 360-degree views, with the vast city unfolding before the building in one direction, its mountains in the not-too-distant background, and the endless, azure sea in the other. It is a fitting amenity for a building that so lovingly pays tribute to its incomparable surroundings. ■

**Project:** Gas Natural

Headquarters, Barcelona

**Architect:** Enric Miralles

Benedetta Tagliabue (EMBT)—

Benedetta Tagliabue, principal;

Josep Ustrell, project director

**Lighting:** BM; Birgit Walter

**SOURCES**

**Curtain wall:** Permasteelisa

**Glass:** AGC Flat Glass Europe

**Elevators:** Kone

**Interior ambient lighting:**

Philips; Louis Poulsen

**Office furniture:** Ahrend



To comment on this project and rate it, go to [architecturalrecord.com/projects](http://architecturalrecord.com/projects).

The light, open interiors provide spectacular views of Barcelona (opposite). The Agbar Tower is the lone tall building visible in the distance (opposite, top right). The smaller cantilevered structure, whose profile resembles a column capital and whose interiors contain small terraces, greets visitors as they make their way through the building gap to the entrance (this page).

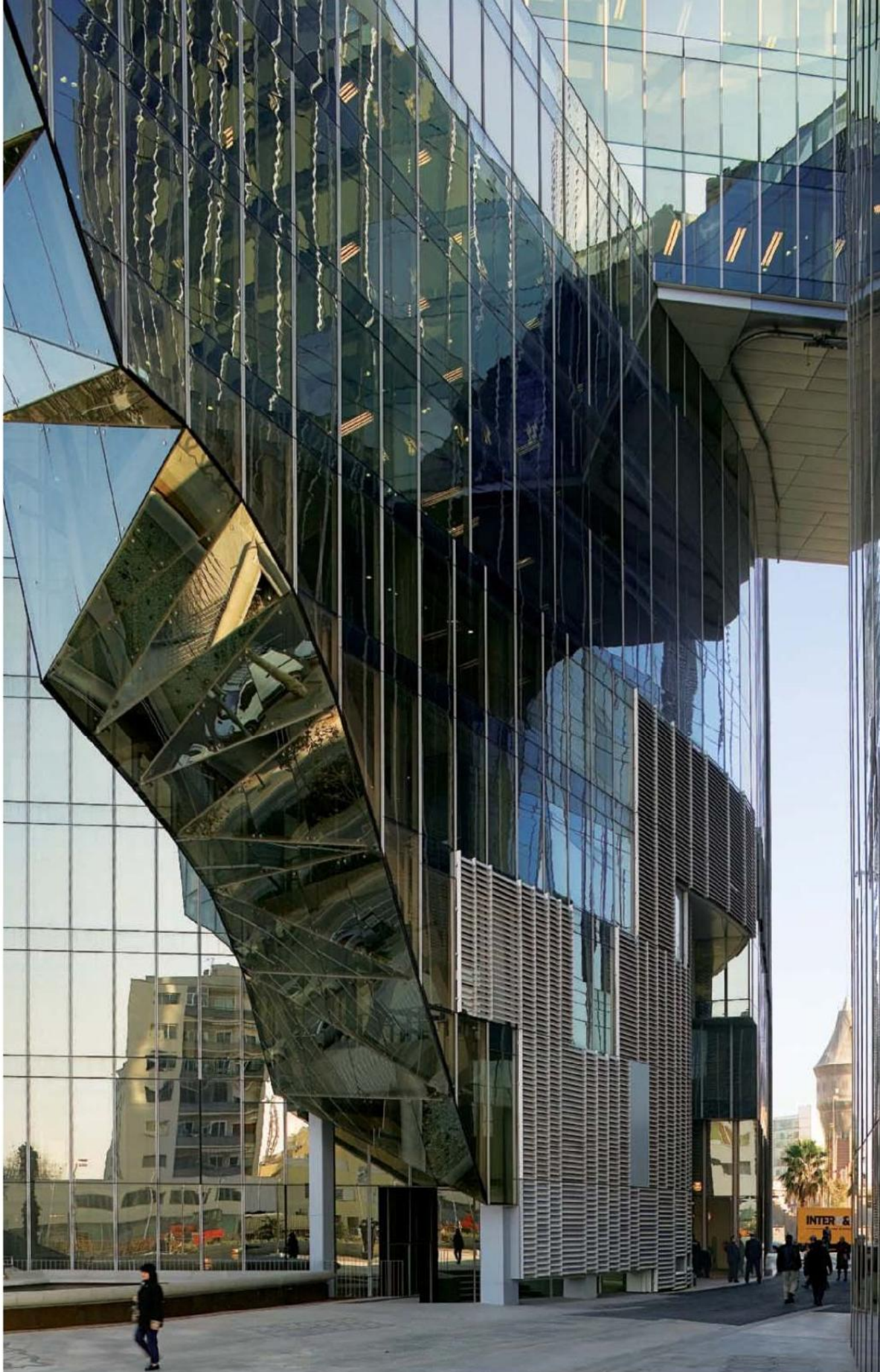



The Comcast Center towers (this spread, left two) rise above City Hall (1901), with its statue of William Penn on top (below). The long-standing gentlemen's agreement not to build beyond its

548-foot height was breached in 1987 by One Liberty Place, a 945-foot tower designed by Murphy/Jahn. The 975-foot-high Comcast opened in 2008 fronting a spacious plaza (right).



## Robert A.M. Stern Architects raises the bar with Philadelphia's **COMCAST CENTER**

By Suzanne Stephens

**A**t a 975-foot height, Comcast Center is Philadelphia's tallest building—a distinction that should last at least as long as the recession. The tower, designed by Robert A.M. Stern Architects of New York (with Kendall/Heaton Associates of Houston as architect of record), brings a trim and tailored presence to a skyline pumped up with spires and tops vying for public attention for 20-odd years.

As a skyscraper, Comcast's top—a squared off obelisk—doesn't announce any new directions in design, nor suggest that it will be as noticeable once taller buildings (such as the projected 1,500-foot-high American Commerce Center by Kohn Pedersen Fox) crowd around it. But like Raymond Hood's RCA Tower (1933) at Rockefeller Center in New York, what it lacks in jazz at the top, it delivers at the bottom in a multilevel mix of public spaces, rail connections and concourses, shops, and cafés.

Comcast's abstracted glass-curtain-walled shaft does come as something of a surprise from a firm strongly typecast as a proponent of a historicist approach to architecture. While the Stern office has executed several glass-covered, streamlined buildings in the past decade (notably, in Mexico City and Rio), the Classical Trad look remains entrenched in clients' minds. The sleek form tapering to a squared-off top is probably Robert A.M. Stern, FAIA, and project partner Graham S. Wyatt, AIA's most blatantly Modernist design to come

PHOTOGRAPHY: © PETER AARON/FSTO. EXCEPT AS NOTED



to the American public's attention.

Like the towers of other top-of-the-line corporate-design firms, Comcast's silhouette harks back to the Late Modern days of the 1960s, only with a more smoothly joined, clearer, and lighter glass curtain wall, and a shaft more articulated with projections and recesses than the shoe-box-on-end of yesteryear.

Liberty Property originally sought out Stern in 2000 to design a mid-rise spec building for which it wanted a "boutique architect," says John Gattuso, the company's senior vice president and regional director of urban and national development. "I proposed glass in the beginning," says Stern, but as Gattuso explains, glass would have been more expensive—especially for what was turning out to be a taller and taller spec tower. After Liberty Properties acquired the 1.8-acre site at 17th and John F. Kennedy Boulevard in 2001 on a still frowsy edge of Center City, the developers announced a scheme for One Pennsylvania Plaza at a 750-foot height. In those days, kasota stone and horizontal bands of glass gave the tower more of an affinity to the shaft—only the shaft—of Howe and Lescaze's landmark PSFS Building (1932) nearby. Granite cladding next made a brief appearance as a skin concept before glass reentered as the dominant material. By then, a new prime tenant emerged—Comcast, the cable company founded by Philadelphia native Ralph Roberts in 1963, and currently the largest cable operator in the U.S., with Ralph's son, Brian, at the helm. And with Comcast as the prime tenant, the building grew taller and sleeker, to its height of 58 stories (1,250,000 square feet), accommodating 2,900 employees.

The architects sheathed the winter garden, plus a series of three, three-story atria above it, as well as the corners and crown of the tower, in a clear, low-E, low-iron glass, while using lightly tinted, slightly reflective glass for the rest. As the obelisklike tower rises, the reflective skin does seem to peel away, so that the clear glass emerges in counterpoint.

In spite of the abstractly faceted sheathing, a Classical drift can be detected in the tower's axial symmetry and its centered elevator and stair core (with its slight asymmetrical displacement on the upper levels). Since the structure is based on a poured-concrete elevator and stair core, steel-and-concrete decks, and steel beams and columns, expansive views can prevail on all sides. And due to typical floor plates of 25,000 square feet, daylight penetrates well into the interior.

Daroff Design and Gensler collaborated on the interiors, which include executive offices and conference rooms at the top, a two-level restaurant on the 43rd and 44th floors, a training center known as Comcast University just below, and the open office floors. Throughout the tower, not only daylight but views of the city are striking, since the ceilings are 11 feet high up to the 43rd floor, and 13 feet high from floors 44 to 56. To emphasize these features, the designers placed circulation at the perimeter walls, and created open workstations with 49-inch-high partitions. On the executive floors, recessed planes of glass, and a four-story atrium linked by a stair with open risers and fritted-glass treads, dramatically enhance the sense of light and space.

Regardless of its record-breaking height and the spa-

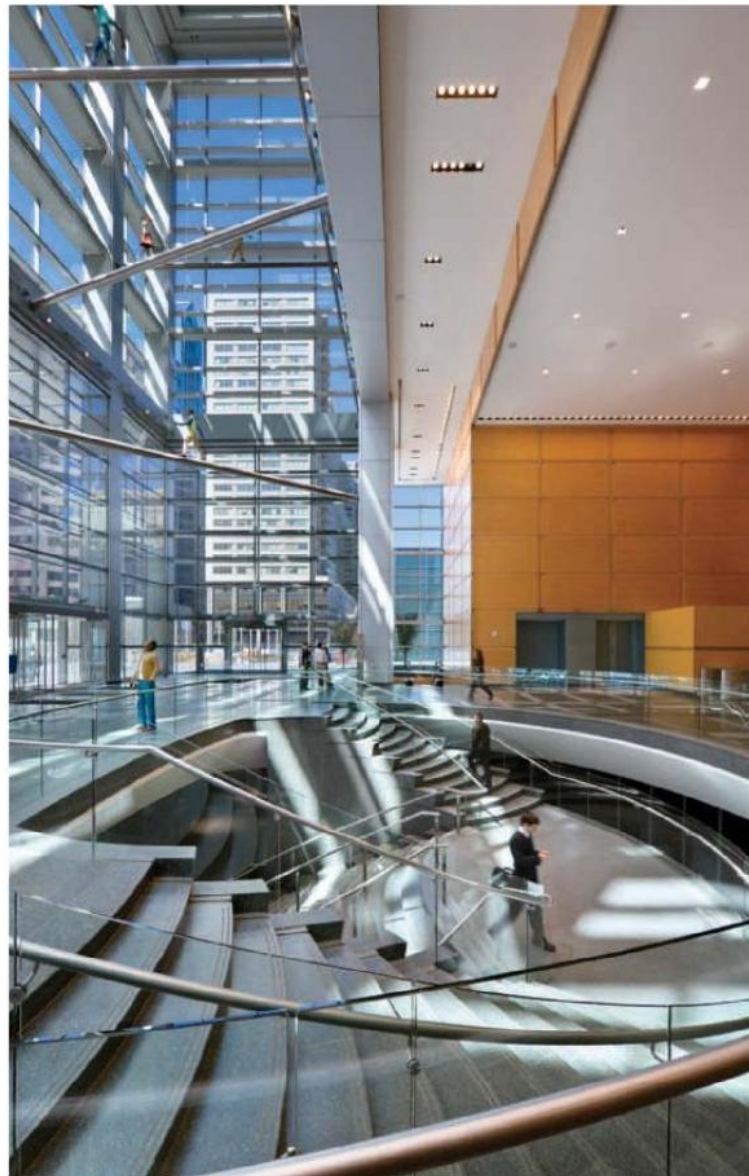

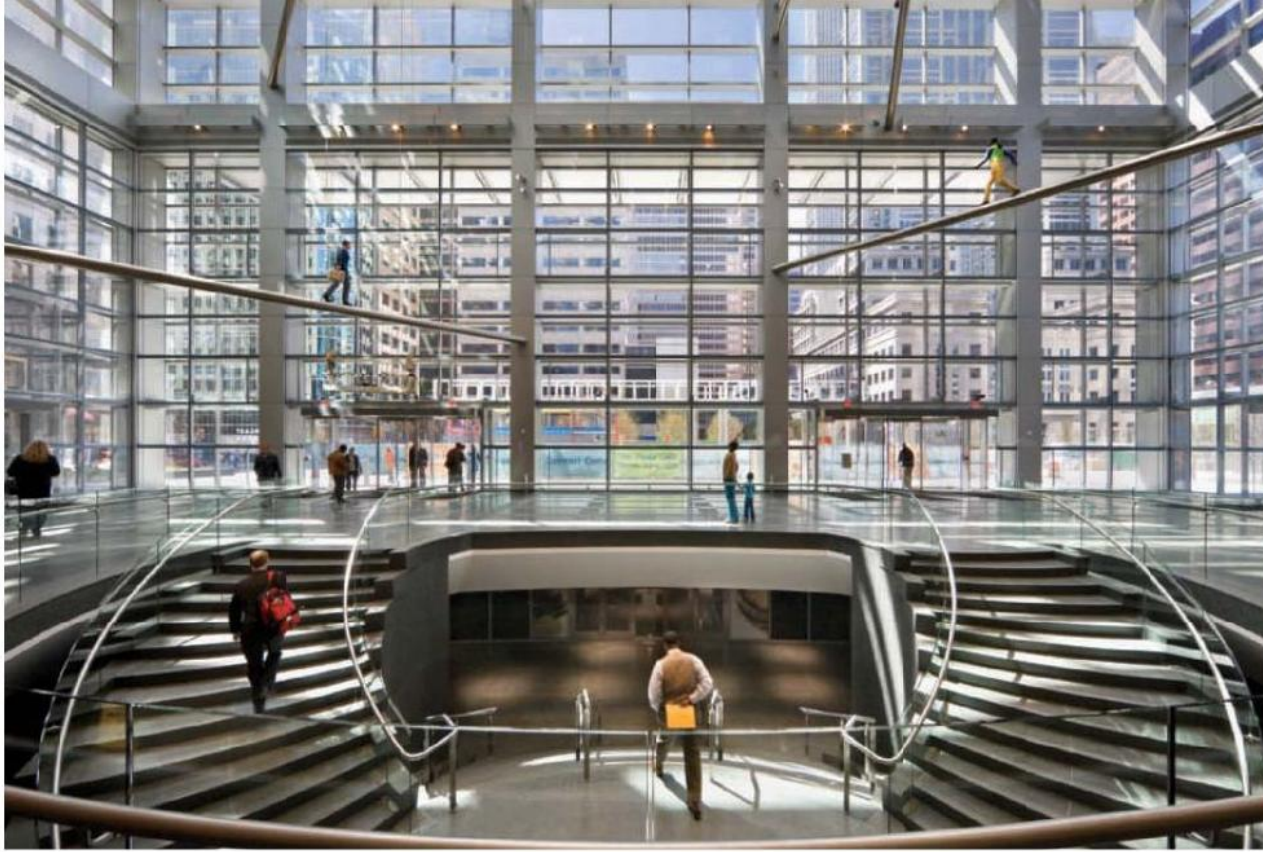

The winter garden and lobby face south (left) to a raised plaza (opposite, top right) designed by Olin, and edged with pleached hornbeam shade trees. From the winter garden, a grand stair takes commuters to the retail concourse and suburban trains below (left and opposite, bottom). The lobby, paneled in burled maple (below), has become a tourist attraction owing to its Jonathan Borofsky sculptures and its multimedia wall by Niles Creative Group.

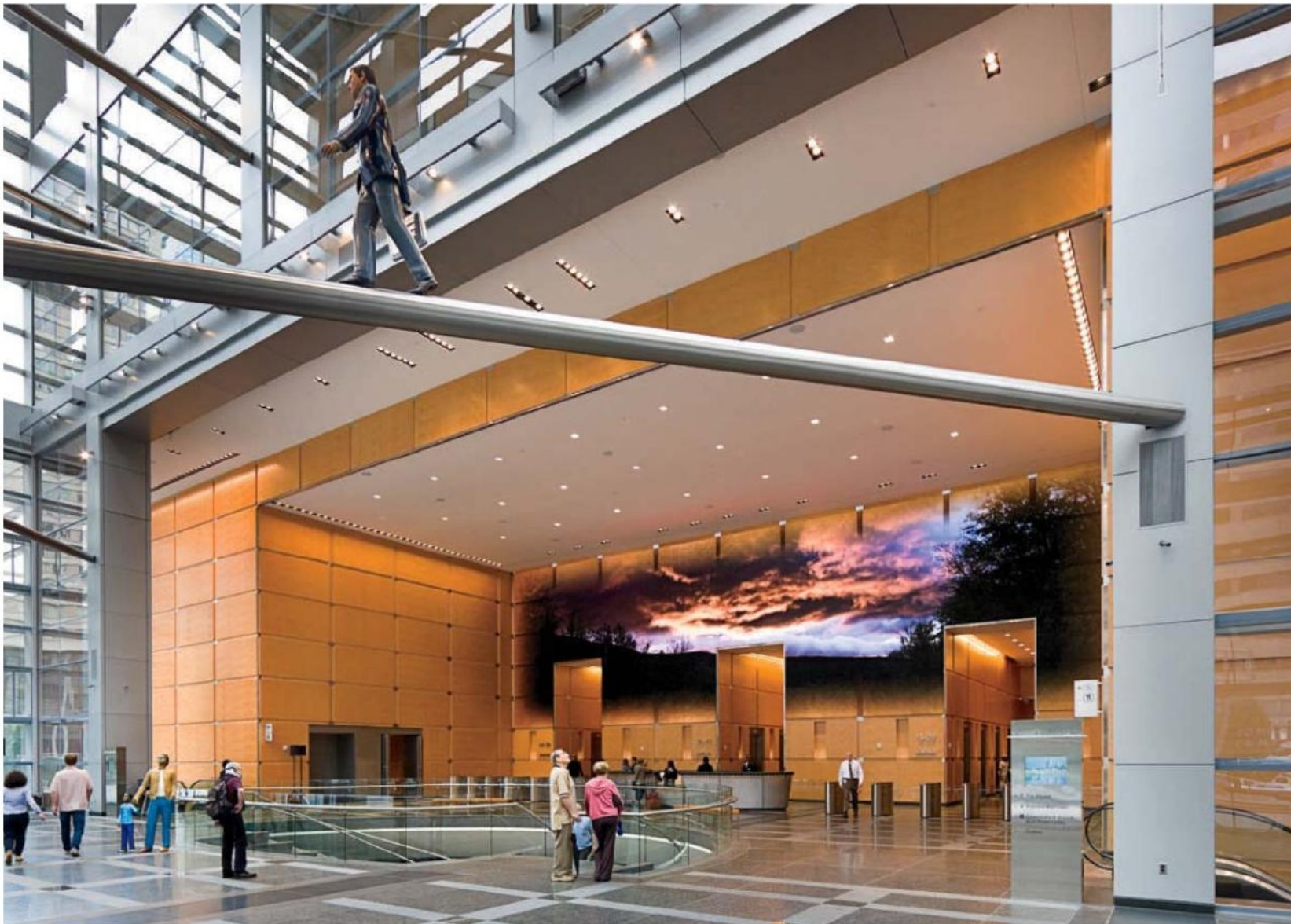

Because of its reflectivity, on certain days Comcast fades into the ether as it tapers upward – for example, when looking north from Market Street (right). At the base of the shaft at the main entrance on Kennedy Boulevard, glazed projections in a double setback formation break up the mass of the first 15 floors (section, left). The first setback encompasses the 120-foot-high winter garden and lobby, and the second setback, of nine floors, includes three banks of three-story atria stacked on top of each other and partially embedded in the shaft itself.

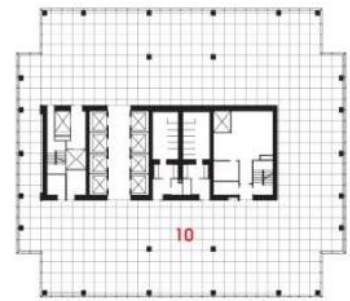

FIFTY-FIFTH FLOOR

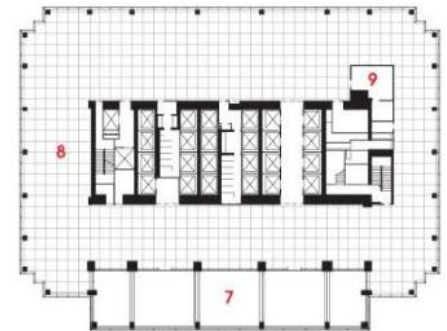

FIFTEENTH FLOOR

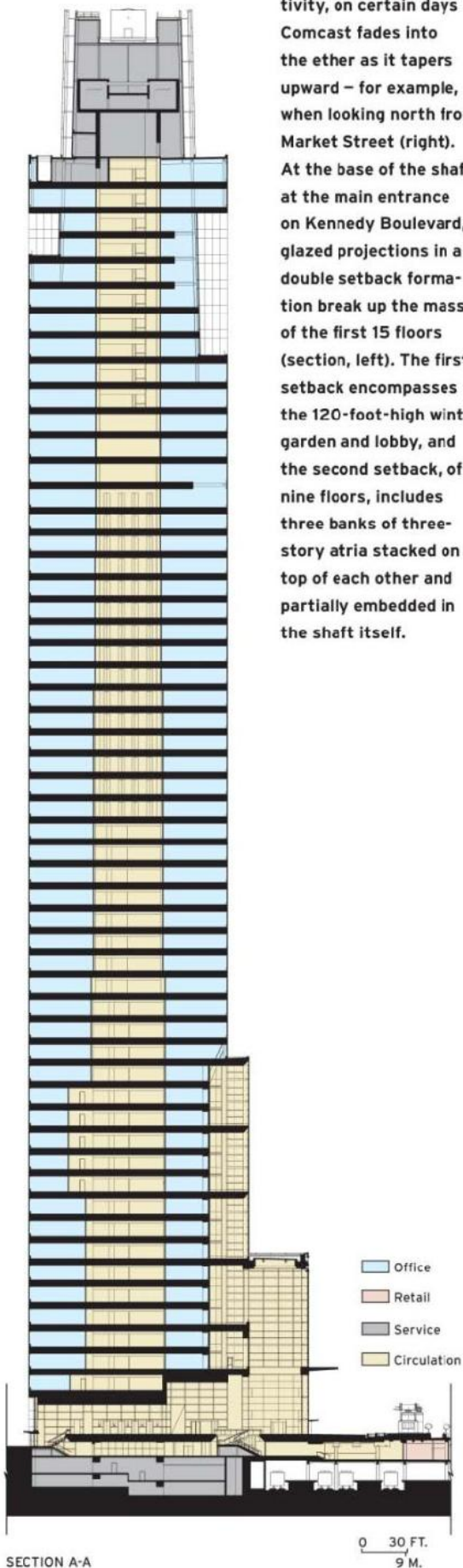

- Office
- Retail
- Service
- Circulation

0 30 FT.  
9 M.

SECTION A-A

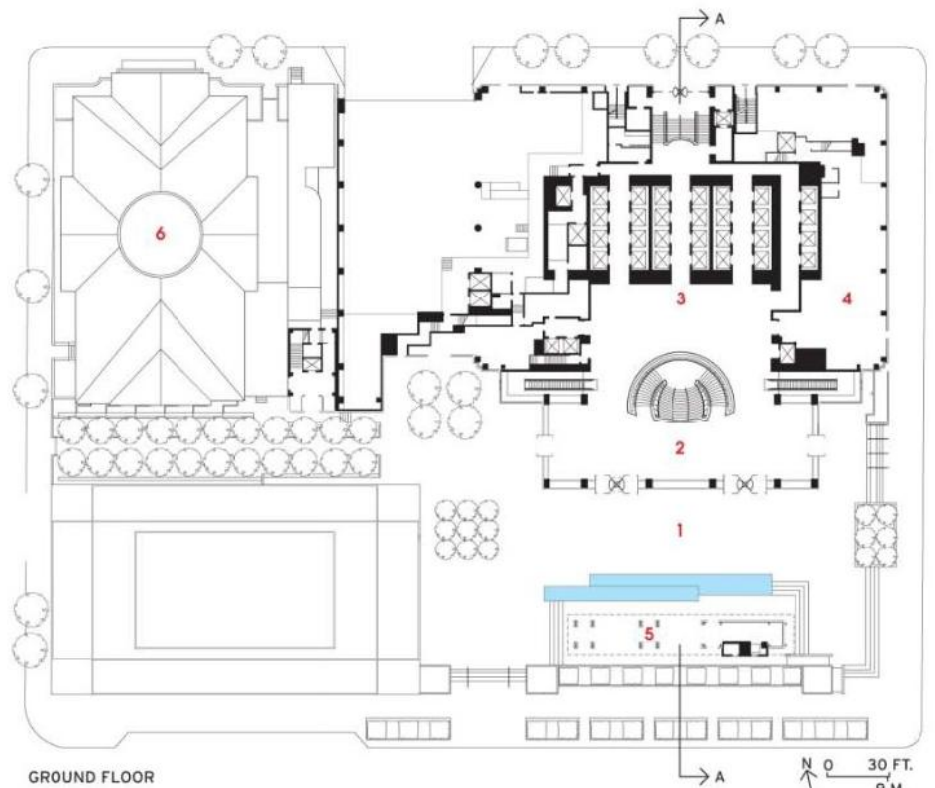

GROUND FLOOR

N 0 30 FT.  
9 M.

- 1. Plaza
- 2. Winter garden
- 3. Lobby
- 4. Restaurant
- 5. Café
- 6. Arch Street Presbyterian Church
- 7. Atria
- 8. Typical office floor
- 9. Enclosed offices
- 10. Executive office floor

## COMCAST: THE WORLD'S LARGEST TUNED LIQUID COLUMN DAMPER

Damping – the process of stabilizing a structure against severe motion caused by wind or seismic conditions – is a critical component in many building types, such as long-span and cable-stayed bridges, spires, monuments, and skyscrapers.

Many types of dampers dissipate oscillations by employing springs, fluids, or pendulums. Some, such as the 760-ton gold pendulum for the tuned mass damper (TMD) at Taipei 101 in Taiwan are part of the show. The 1,671-foot-tall tower, designed by C.Y. Lee & Partners (2004), swings in full view of patrons in the restaurants and observation decks.

Most damping devices, however, are part of the structure and not the architecture, so they're hidden. And yet as buildings get taller and thinner, today's dampers require and inspire innovation. While extreme oscillations can cause structural damage, more often the challenge is eliminating human discomfort or motion sickness caused by lateral drift, especially in tall

buildings with high aspect (slenderness) ratios. Such was the case with the Comcast Center in Philadelphia.

Acceleration is the most common cause of motion effects, and the greater the horizontal force, the more discomfort the human body experiences. An acceleration of one thousandth of gravity is called a milli-g. According to Aine Brazil, managing principal at New York-based Thornton Tomasetti, the structural engineers for Comcast, "The goal was to achieve a range from 20 to 24 milli-g. This is the maximum acceptable for a 10-year return period." However, with a height of almost a 1,000 feet, the oscillation would have been 30 milli-g.

Thornton Tomasetti worked with Canadian motion-control consultant Motioneering, the designer of Taipei 101's TMD, the largest of its kind in the world. They sought to find a supplementary damping system (SDS) that would optimize the lateral drift serviceability performance but would be less expensive

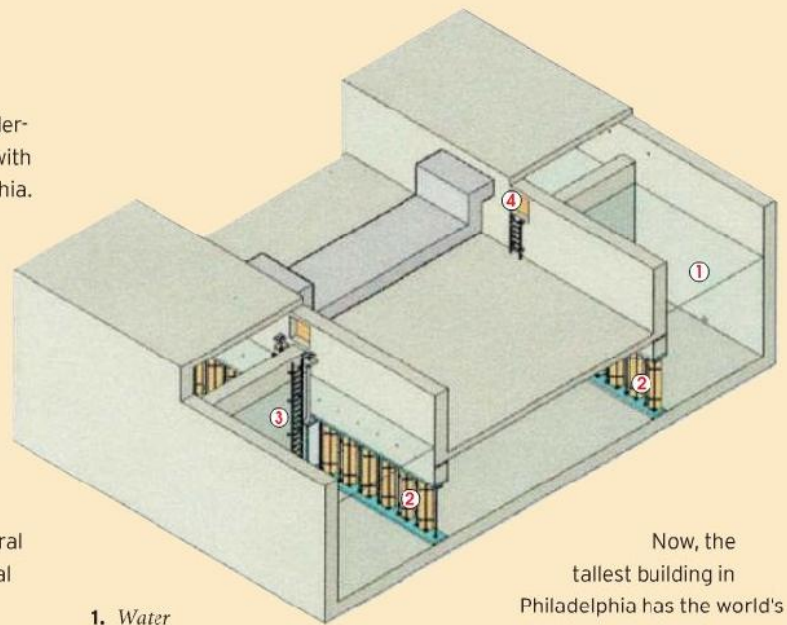

1. Water
2. Damping vanes
3. Guiding wall
4. Access hatch

than the TMD. Motioneering determined that a tuned liquid column damper (TLCD) would be the answer. Since an SDS was only needed along the most slender axis, the consultants decided that rather than installing two perpendicular TLCDs, which is a typical solution, the company would design a large one.

Now, the tallest building in Philadelphia has the world's largest uni-axial TLCD, with a water mass of 1,300 tons, or 300,000 gallons of water. Its U-shaped tank allows the water to oscillate freely at the frequency that matches a natural one of the structure. Damping is provided by tuning the turbulence levels in the moving water.

Motioneering's custom design, which included dividing the tank into two parts, maintains efficiency, optimizes the space, and saved the client millions of dollars in structural costs. *Sara Hart*

## GREEN STRATEGIES FOR A PUBLIC SPACE

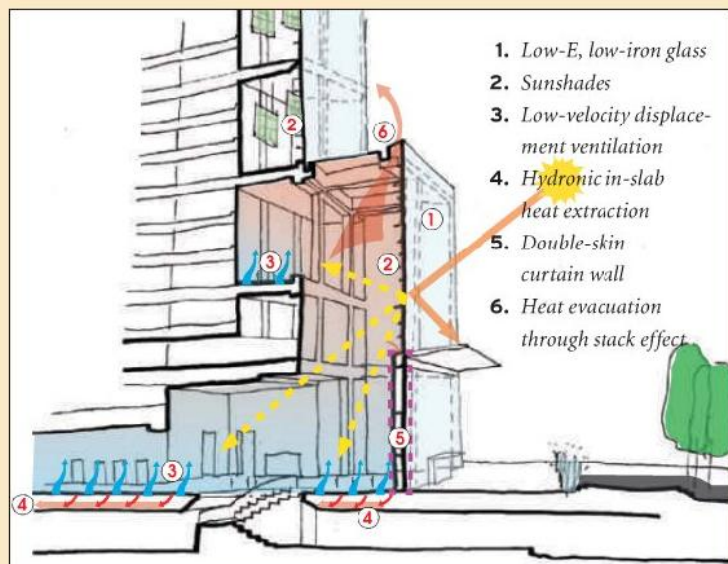

1. Low-E, low-iron glass
2. Sunshades
3. Low-velocity displacement ventilation
4. Hydronic in-slab heat extraction
5. Double-skin curtain wall
6. Heat evacuation through stack effect

Liberty Property Trust, proud of its sustainable office buildings, is also seeking LEED certification for Comcast. The architects worked with environmental consultants Atelier 10 on energy-saving strategies – for example, on heating and cooling methods for the six-story winter garden and the atria above. The team specified low-E, low-iron glass on the south facade to reduce solar gain in the warm months, and installed a low-velocity displacement ventilation system. In addition, hydronic tubes embedded in the granite floor of the winter garden extract heat, which is also siphoned out of the top of the atrium by the stack effect.

In the winter, thickened steel mullions serving as sunshades deter downdrafts, deflecting cold air into the 45-foot-high double wall of the winter garden so that it doesn't enter the indoor areas. Internal radiant fin tubes attached to the steel mullions modulate the temperature on the inside of the glass to prevent condensation. The granite floor stores heat and radiates it back at night, while a low-velocity air system under occupied floors supplements heating. Other measures to save energy include using recycled materials and waterless urinals, which has helped cut the use of all water in the building by 41 percent a year. *Suzanne Stephens*



**Daroff Design** collaborated with **Gensler** on the interiors, with views of the city providing a striking backdrop. The executive offices (right) have a neutral palette, while a more vibrant color scheme is found in the elevator banks (below right) and a three-story-high atrium lounge (bottom).

rious offices, Comcast's newly found magnetism comes from the winter garden at the base of the building, and the plaza outside, along with a concourse retail level connecting to the suburban train station. In keeping with its identity, Liberty Property and Comcast commissioned David Niles of Niles Creative Group to create a high-definition video installation, two stories high and 85 feet wide, behind the lobby's reception desk. Now the media wall and Jonathan Borofsky's sculptures of people walking, tightrope-style, on steel tubes in the winter garden attracts tour groups and other pedestrians much of the day.

Here, too, there is a Bernini-meets-Busby-Berkeley grand stair taking commuters to and from rail connections below. Stern designed the food-and-retail level there with slightly higher ceilings than are usually found in the subterranean concourses of Center City, by raising the level of the plaza a few steps above grade. Since the tower is in the Penn Center area conceived by planner Edmund Bacon in the 1950s, the design of the winter garden and its connection to the Suburban Station building to the east integrates Comcast extremely well into the urban life of this area. Its activation of this parcel makes it well worth the bonus zoning of a FAR (floor area ratio) of 8 on top of the standard 12 FAR.

In addition, Comcast's connection at the plaza to the Classical Revival Arch Street Presbyterian Church (1855) to the west adds to the vibrancy of this district. Already the glass tower's intrusion of high style and public amenities in this location between Rittenhouse Square, Logan Circle, and Benjamin Franklin Parkway has added spark to a moldering area.

Before the recession, Liberty Property sold 80 percent of its interest in the tower to a subsidiary of Commerzbank of Düsseldorf. And with Comcast occupying about 90 percent of the space, the developers appear to be in a good place. It might be one of those few occasions when the developer, client, and even the city benefit. The top of the tower, however, remains a skyscraper conundrum: How do you crown an abstractly Modern high-rise? Spires and pyramids are too old hat, sawed-off tops too blunt, and off-center needles willful. We await the resolution. ■

**Project:** Comcast Center, Philadelphia  
**Architect:** Robert A.M. Stern Architects Robert A.M. Stern FAIA, principal; Graham S. Wyatt, AIA, project partner; Meghan L. McDermott, AIA, project architect  
**Architect of record:** Kendall/

Heaton Associates  
**Interior design:** Daroff Design and Gensler (also interior architect of record)

**SOURCES**

**Glass:** PPG (Starphire); Viracon  
**Concrete:** Lafarge (NewCem slag)



To comment on this project and rate it, go to [architecturalrecord.com/projects](http://architecturalrecord.com/projects).

A glass stair links the executive offices. It affords a panoramic view of the city, especially "Helmut's Helmets," the tops of Liberty Place One and Two, designed in the late 1980s by Helmut Jahn of Murphy/Jahn.



Employees and visitors enter the highly transparent Merck Serono Headquarters from a spacious plaza partially sheltered by an arc-shaped, glazed awning that cantilevers from the roof.



**MURPHY/JAHN** knits research and office space  
into Geneva's urban fabric to create  
a striking headquarters for **MERCK SERONO**





By Joann Gonchar, AIA

Architect Helmut Jahn, FAIA, describes his recently completed Geneva headquarters for biotech and pharmaceutical company Merck Serono, as “not a one-liner like a high-rise building.” But it isn’t clear if he is excluding his own high-rises, such as the 42-story Deutsche Post, in Bonn [ARCHITECTURAL RECORD, May 2004, page 96], or the twin skyscrapers known as the Highlight Business Towers, in Munich [ARCHITECTURAL RECORD, March 2006, page 154]. Like Merck Serono, the German projects demonstrate a preoccupation with transparency, energy efficiency, user comfort, and pared-down but highly detailed structure.

However, Jahn’s somewhat off-the-cuff remark points to an important difference between the low-rise Merck Serono and the earlier towers. Although the Swiss building has its moments of expressive structural bravura, it was not conceived as an iconic statement on the skyline. Instead, the 725,000-square-foot facility is almost unselfconsciously slipped into its former industrial site in the city’s international district. Within the building, or more accurately, within the complex of interconnected buildings, Jahn and his team have created not only

top-notch labs and offices, but also a network of community spaces—some enclosed, some outdoors, and others somewhere in between—shared by 1,200 scientists, managers, and administrative staff. These shared spaces were created in response to a directive from the client to provide an environment that would foster interaction and collaboration among previously disparate segments of the company’s workforce.

The scheme developed by Chicago-based Murphy/Jahn, with long-time collaborators Werner Sobek Ingenieure and Transsolar Energietechnik, both of Stuttgart, also needed to comply with a Canton of Geneva requirement to incorporate within the new development at least some of roughly a dozen late-19th- and early-20th-century engine manufacturing facilities on the oddly shaped 6.5-acre plot overlooking Lake Geneva. The team chose a masonry load-bearing building and two steel-truss-supported shed structures, renovating them to house such parts of the program as a day-care center, a conference center, and offices, while preserving their most historically relevant elements. “In some cases, it was the facade, and in other cases, it was the structure,” explains Jahn.



At Merck Serono, new construction and historic structures interweave to define courtyards and atria (opposite). One of these glass-enclosed, multistory spaces features an LED installation and serves as the entry lobby (below). The view from the base of a grand stair provides a hint of another atrium, known as the "forum," beyond. It has an operable roof (far left) controlled by a finlike counterweight (near left).

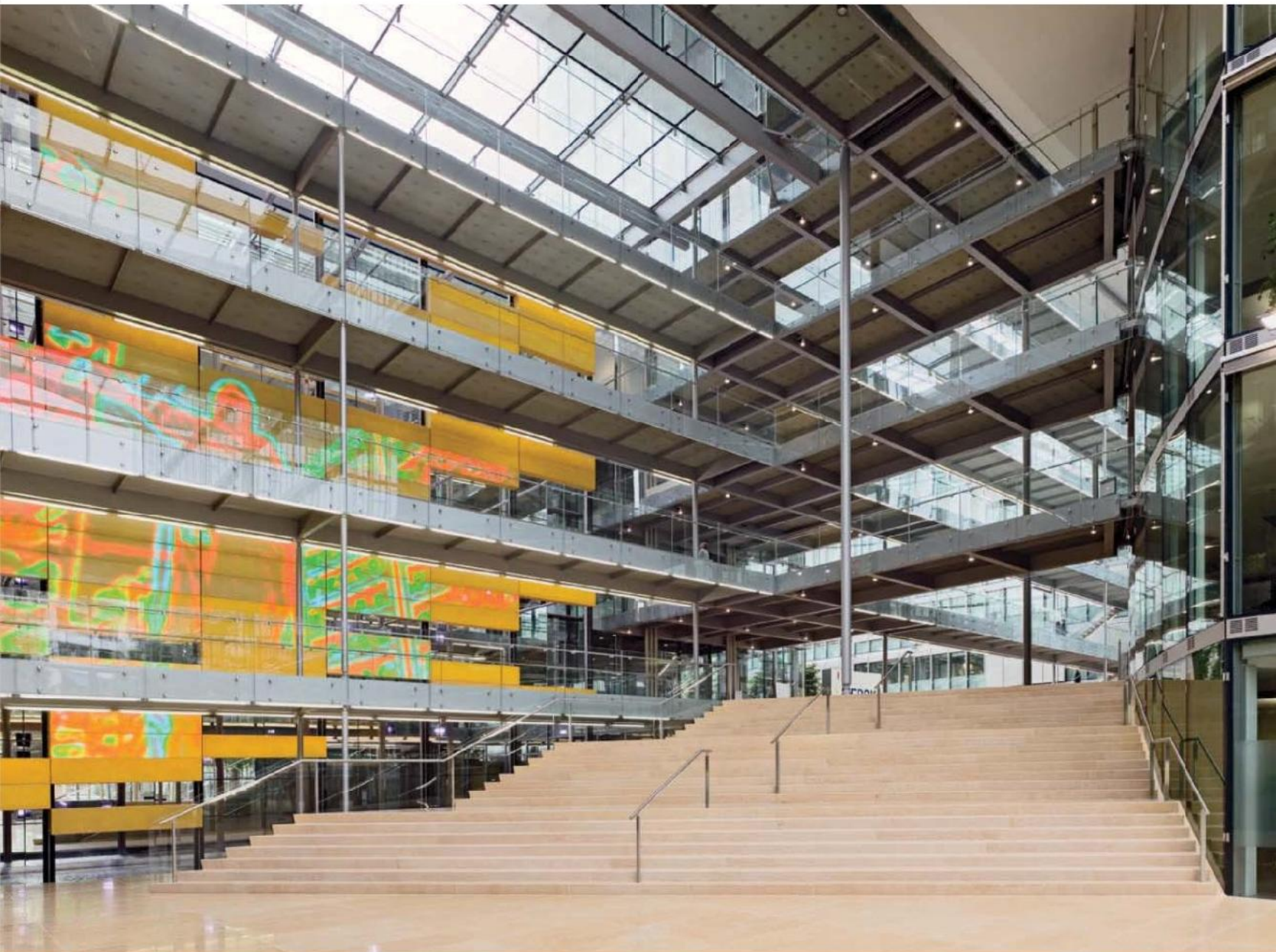

## SOPHISTICATED SKIN ADAPTS TO CLIMATIC CONDITIONS AND OCCUPANT NEEDS

At the Merck Serono headquarters in Geneva, the predominance of glass is intended, at least in part, as a metaphor for a progressive corporate culture. "For many people, biotech is black magic," says Mark Underhill, the owner's project manager, by way of explaining the allure of a glass building skin. But management also hoped that a transparent building envelope would provide benefits to occupants, such as access to daylight and views, in addition to conveying a certain image. The challenge for the project team was maintaining transparency while controlling cooling loads and glare.

In order to create a mostly glass but energy-efficient complex,

the Merck Serono design team developed a facade system it calls a "shingle wall." The fish-scalelike curtain wall is deployed on most of the east- and west-facing elevations of the new lab and office buildings. It is made up of sloped pieces of high-performance, low-iron glazing, 5 feet wide and 12 feet tall. The bottom edge of each cantilevers beyond the slab edge 3 feet, overlapping with the unit below.

This overlap protects a floor-level ventilation flap from wind and rain and shelters a mechanism controlling an operable exterior shade composed of thin, L-shaped, stainless-steel bars. The partially transparent shade mitigates heat gain, but

reflects light into the interior.

The envelope design works in tandem with the interior climate-control strategy. Although the research areas have more conventional systems, the largely open-plan offices rely on raised-floor ventilation on top of "active" structural-concrete slabs left exposed to the spaces below. The combination of radiant ceilings, which use chilled or warm water, and low-velocity displacement ventilation, requires minimal distribution energy when compared to a standard forced-air system. Fan coils at the perimeter of each floor plate control the temperature of the air coming in directly from the outside.

The operation of many of the

envelope and interior systems are automated. For example, orientation and daylight conditions determine the position of the exterior shades. Occupants can directly control or override building-management-system settings for some of the components, including the ventilation flaps, the fan coils, and internal roller blinds for reducing glare.

For architect Helmut Jahn, the benefits of such climate- and user-responsive envelopes extend beyond their potential for maximizing energy efficiency and occupant comfort. They also add dynamism to facades, he says. At Merck Serono, "the building transforms from one that is all glass to a stainless-steel box." J.G.

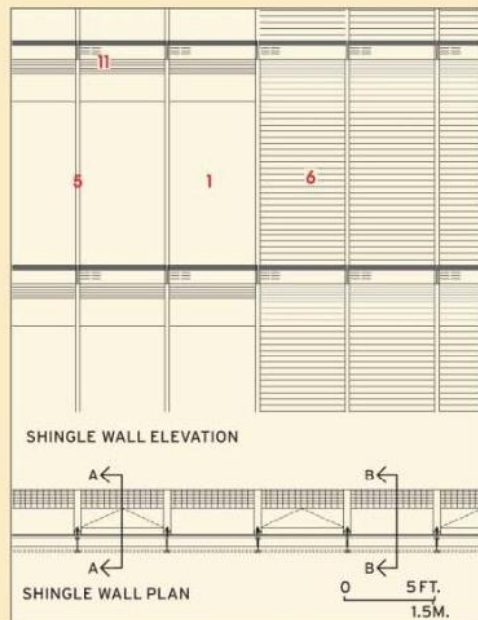

**Overlapping and canted glazing units compose the shingle wall (left). Its exterior shades mitigate heat gain but preserve views (above left).**

1. Argon-filled, low-E glazing
2. Ventilation unit
3. Chilled/hot water supply and return
4. Active slab
5. External shade track
6. External shade
7. Interior glare control
8. Raised floor
9. Ventilation flap
10. Concrete column
11. Ventilation grille

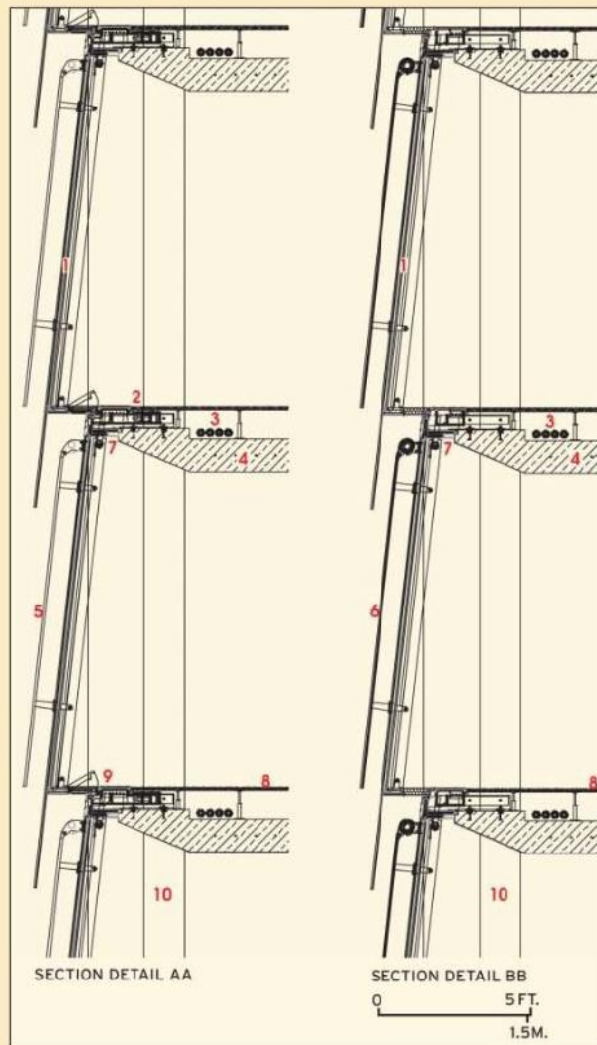



SECTION A-A

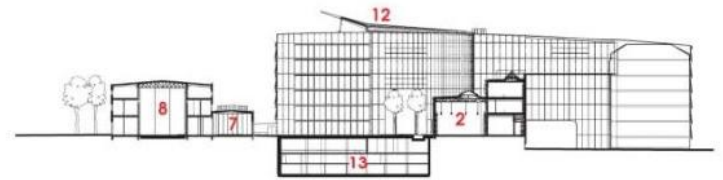

SECTION B-B

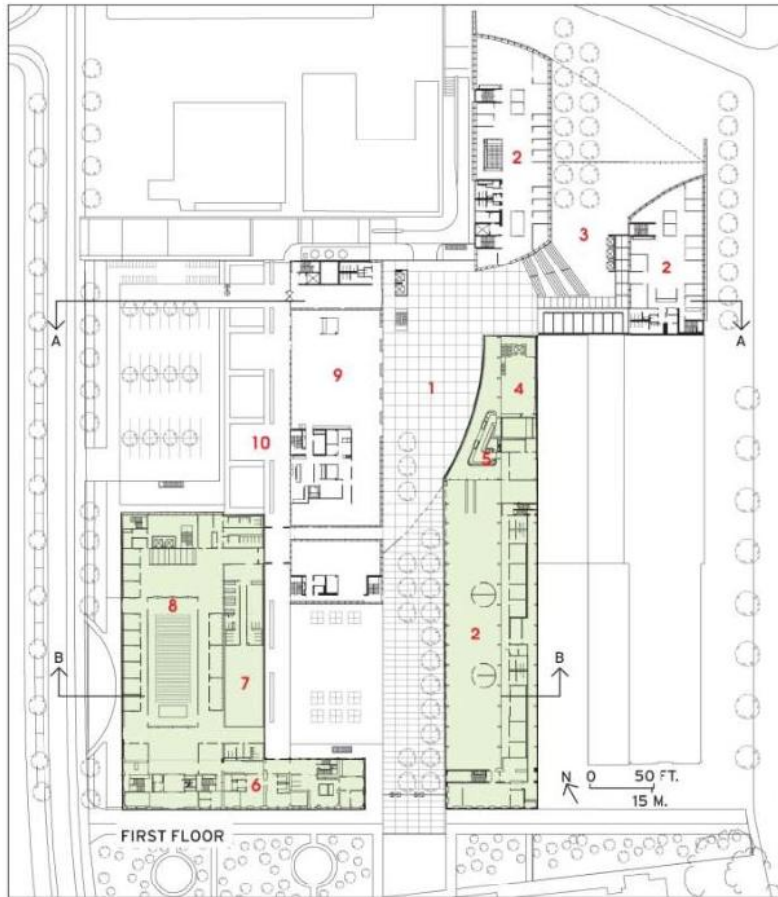

FIRST FLOOR

1. Forum
2. Offices
3. Lobby
4. Library
5. Café
6. Day care
7. Fitness center
8. Conference center
9. Restaurant/cafeteria
10. Outdoor dining
11. Laboratory
12. Roof counterweight
13. Parking/mechanical

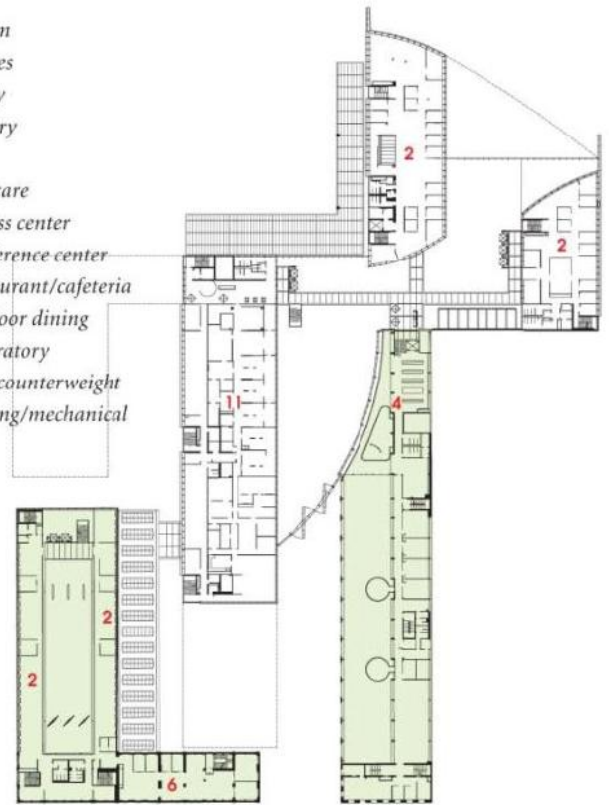

SECOND FLOOR

Historic structures

The older buildings' linear configuration informed the new construction, providing a starting point for the layout of the complex. For the rest of the site, the team designed six- and seven-story, glass-clad, bar-shaped concrete structures for labs and offices, and used them, along with the historic buildings, to define a series of exterior courtyards and a pair of atria. The first of these glass-enclosed, multistory spaces is on the north side of the site and serves as the lobby. Visitors and employees enter between two new office structures from a spacious plaza, partially sheltered by an arclike extension of the atrium roof.

Once inside, a network of elegant glass-and-steel bridges connecting the upper levels of the complex's individual buildings dominates. A multimedia installation of aluminum, beeswax, and LEDs occupies one elevation. It incorporates a water wall, introducing a soft ambient sound to the space.

A second atrium, or "forum," is visible through the connecting bridges and from the base of a lobby grand stair. Conceived as the hub of the complex, a café, cafeteria, and restaurant surround the daylight-filled space intended to support informal meetings and socializing. Instead of mechanically

cooling the forum in warm weather, facility managers can create a semi-outdoor environment by pivoting a series of vents and a set of 36-foot-tall doors to open up the curved glazed facade to an adjacent courtyard. They can also tilt up the fan-shaped, 10,800-square-foot, glass-and-steel roof, controlling its operation through hydraulic jacks and a 110-ton, 180-foot-long, finlike counterweight. According to the design team, it is one of the largest movable glass-and-steel structures in the world.

Despite the obvious difference in size, Jahn likes to compare the forum roof to the sun roof on a car. In both cases, opening the roof creates a completely different interior environment, he points out.

The forum's movable roof is not the only component in Merck Serono's building envelope that can adapt to climatic conditions. The "shingled" glass facades on the east- and west-facing elevations of the new offices and labs incorporate operable exterior shading devices and floor-level ventilations flaps (see sidebar, page 180). These elements are closely coordinated with other features aimed at maximizing occupant comfort and minimizing reliance on limited natural resources, includ-





The hub of the headquarters is an atrium known as the “forum” (bottom left and opposite), which is surrounded by a café, cafeteria, and restaurant. Offices are primarily open plan (far left) to take advantage of abundant daylight provided by the highly transparent building envelope. Former industrial buildings house various programmatic elements, such as a conference center (above near left), where original roof trusses are intact.

ing a displacement ventilation system and “active” slabs.

Some building features play less obvious roles in the Merck Serono climate-control strategy. For example, the lobby water wall acts as a humidification device in the winter and allows for evaporative cooling in the summer. And completely hidden from view is a thermal exchange system that relies on water pumped from Lake Geneva. It provides nearly 70 percent of the energy that Merck Serono requires for heating and cooling, preventing about 4,800 tons of carbon emissions from being released into the atmosphere each year, say company officials.

Jahn calls Merck Serono “a building of high technology but low energy consumption.” And while it is true that the project is technologically sophisticated and that its elements are refined with Swiss-watch precision, it is also humane. The design team has developed a complex at a scale that seems appropriate for its setting, skillfully integrating the old with the new. In so doing, it has defined a series of dynamic courtyards and atria. It is nearly impossible to know, of course, what kind of effect such amenities will have on Merck Serono’s bottom line or on the satisfaction of its employees. But on the basis of

a recent visit in early spring, the social spaces seem well used at all times of the work day. And one never knows—researchers just might develop the concept for the next blockbuster drug on the back of a napkin while sipping espresso under the forum’s glazed canopy. ■

**Project:** Merck Serono Headquarters, Geneva

**Architect:** Murphy/Jahn—Helmut Jahn, FAIA, Sam Scaccia, FAIA, Gordon Beckman, AIA, Scott Pratt, AIA, Stephen Kern, AIA, Oliver Henninger, project team

**Associate architect:** Burckhardt + Partner

**Consultants:** Werner Sobek Ingenieure (special structures/

facades); Transsolar Energietechnik (energy/comfort); Thomas Jundt Ingénieurs (structural); Bonnard & Gardel Ingénieurs (mechanical/electrical)

#### SOURCES

**Curtain wall:** Permasteelisa, Hevron

**Forum doors:** Gartner

**Glazing:** Interpane; Glass Trösch; Pilkington Flachglas

To comment on this project and rate it, go to [architecturalrecord.com/projects](http://architecturalrecord.com/projects).





## KPF crowns an ever-expanding skyline with the **SHANGHAI WORLD FINANCIAL CENTER**

By **Aric Chen**

**A**ny plan to build the world's tallest building requires dodging a minefield of technical, economic, and political issues. But throw in a regional financial crisis, a global race skyward, and major, midconstruction design revisions—complicated by a symbolic motif that flared simmering national tensions—and the task seems that much harder. Upon its completion last year, the Shanghai World Financial Center, designed by Kohn Pedersen Fox (KPF), became the world's tallest building—sort of. Though it currently claims the world's topmost roof, at 1,614 feet, and highest occupied floor, it was surpassed in total height by the 1,680-foot-high spire of Taipei 101 during construction and will be dwarfed by the 2,680-foot-tall Burj Dubai when that structure is finished later this year. But at 101 stories, the Shanghai World Financial Center still cuts through the skyline of China's financial capital like a glittering knife, a spectacular, supertall achievement that beat the odds nonetheless.

Hemmed in by the broad thoroughfares of Shanghai's ultra-modern Pudong district, across the Huangpu River

from the old city center, the building rises high above its glitzy neighbors, which include the landmark Oriental Pearl television tower (1994) and the 88-story Jin Mao skyscraper (1999). The latter, a Postmodern, SOM-designed take on the pagoda, “offers one interpretation relating to Chinese culture,” says KPF design principal William Pedersen, FAIA. “But we took a different point of view. Our objective was to create the simplest form that would have the strongest presence possible.”

The result is a soaring, silvery square prism, sliced at opposite corners by gently curving arcs that nearly converge at the top—an abstract confluence of the ancient Chinese representations of heaven (a circle) and earth (a square). Crowning the building, a large, trapezoidal opening has become its signature feature, while the numbers are equally striking: The project's 91 elevators serve 4.1 million square feet, including 2.4 million of office space from the seventh to 77th floor, and from the 79th to 93rd floor, a 174-room Park Hyatt hotel, designed by Tony Chi & Associates. Five retail levels and a conference center occupy the base, while visitors are shuttled toward the dramatic 97th- and 100th-level observatories at an ear-clogging 26 feet per second.

Toward its base, the tower's tapering form provides

*Aric Chen is a freelance writer based in New York and Beijing.*

PHOTOGRAPHY: © MORI BUILDING LTD, EXCEPT AS NOTED



KPF's design approach for the World Financial Center (far left and opposite, center) was markedly different from the one taken by architects of the adjacent Jin Mao skyscraper (near left). The WFC is a towering presence on Pudong's eclectic skyline.

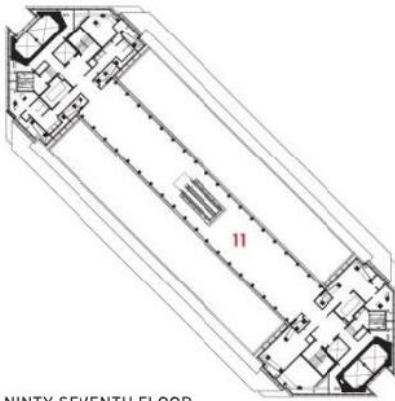

NINETY-SEVENTH FLOOR



ONE HUNDREDDTH FLOOR

- |                         |                  |
|-------------------------|------------------|
| 1. Office entrance      | 7. Offices       |
| 2. Retail entrance      | 8. Restrooms     |
| 3. Hotel entrance       | 9. Elevator core |
| 4. Observatory entrance | 10. Hotel room   |
| 5. Sunken plaza         | 11. Sky Walk 97  |
| 6. Office entrance hall | 12. Sky Walk 100 |

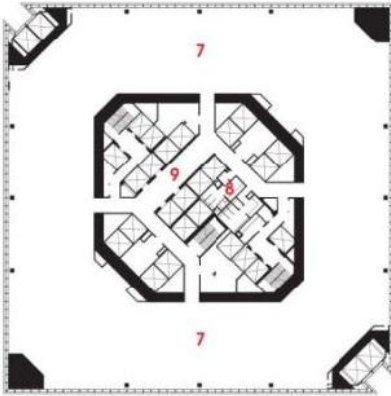

SEVENTH FLOOR

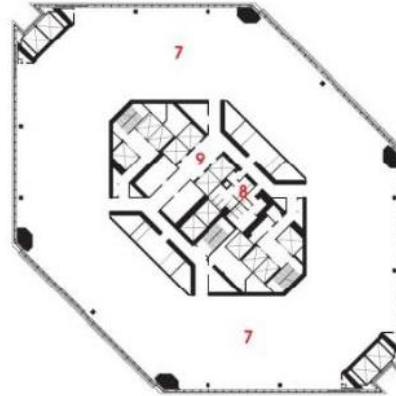

SEVENTY-SEVENTH FLOOR



EIGHTY-THIRD FLOOR

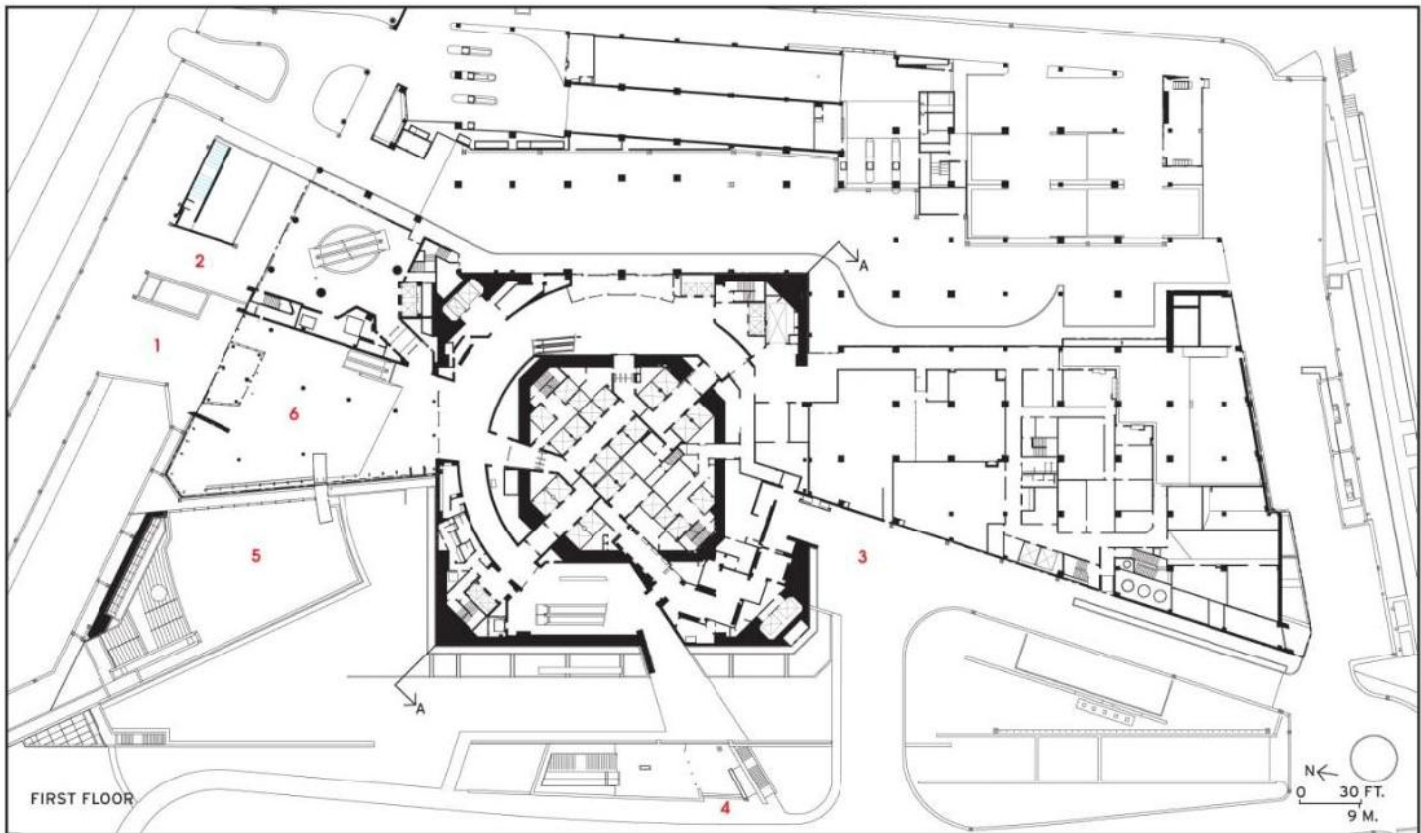

FIRST FLOOR

The building rises 101 stories from a granite-clad base (bottom). The tapering addition to the skyline is equally impressive when seen from the ground (right).

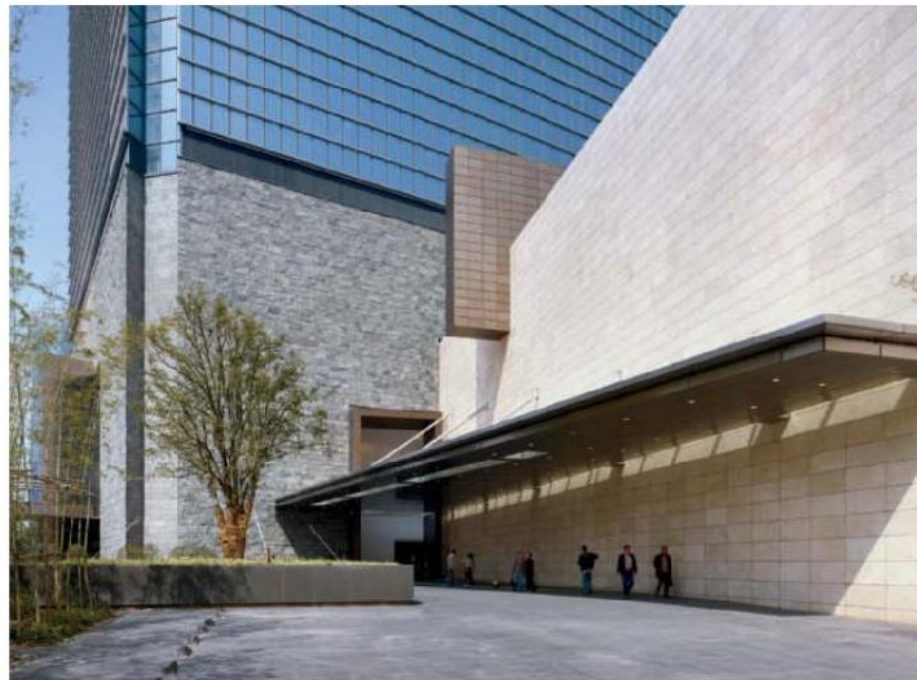
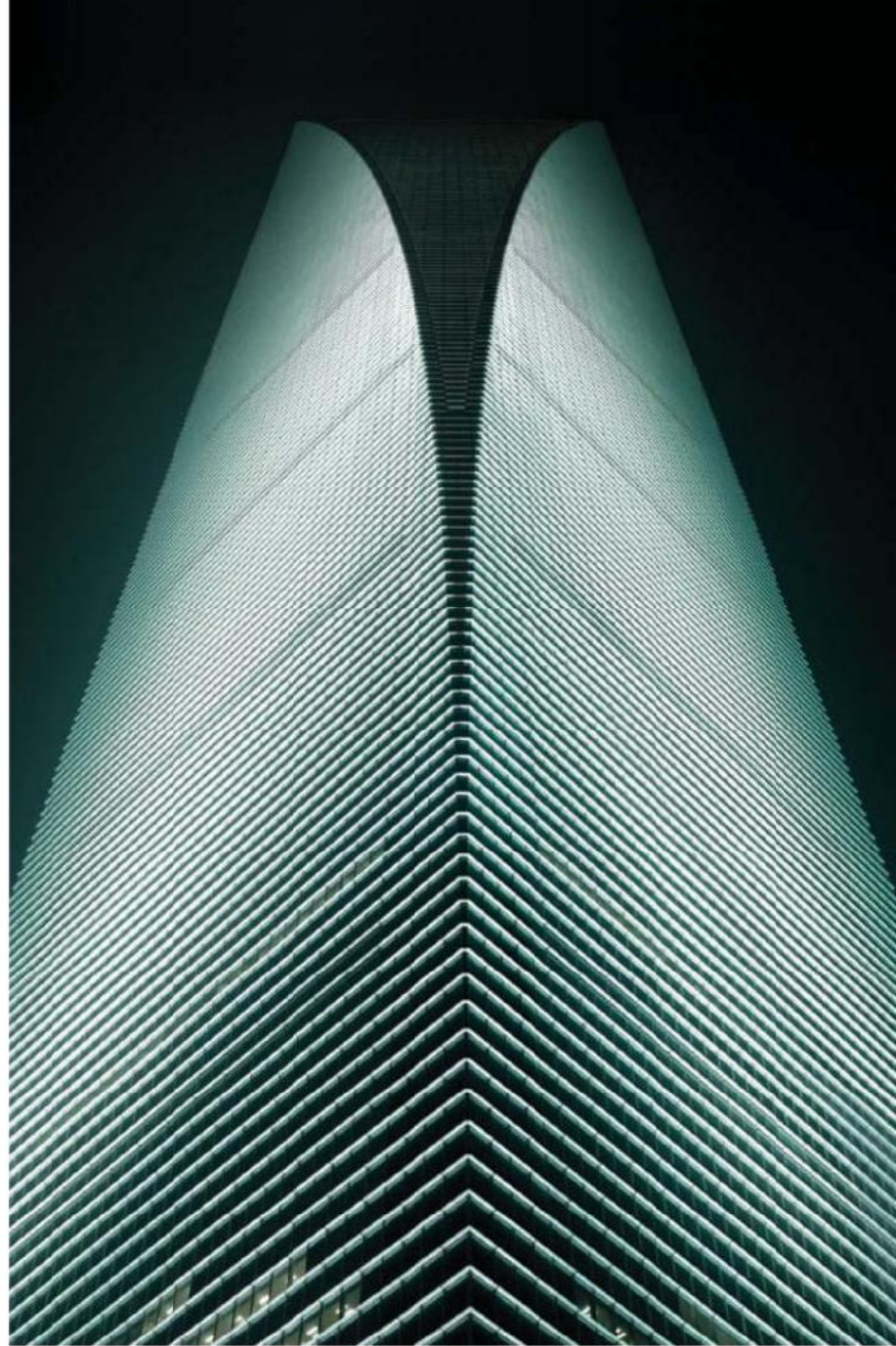

PHOTOGRAPHY: © TIM GRIFFITH (BOTTOM)

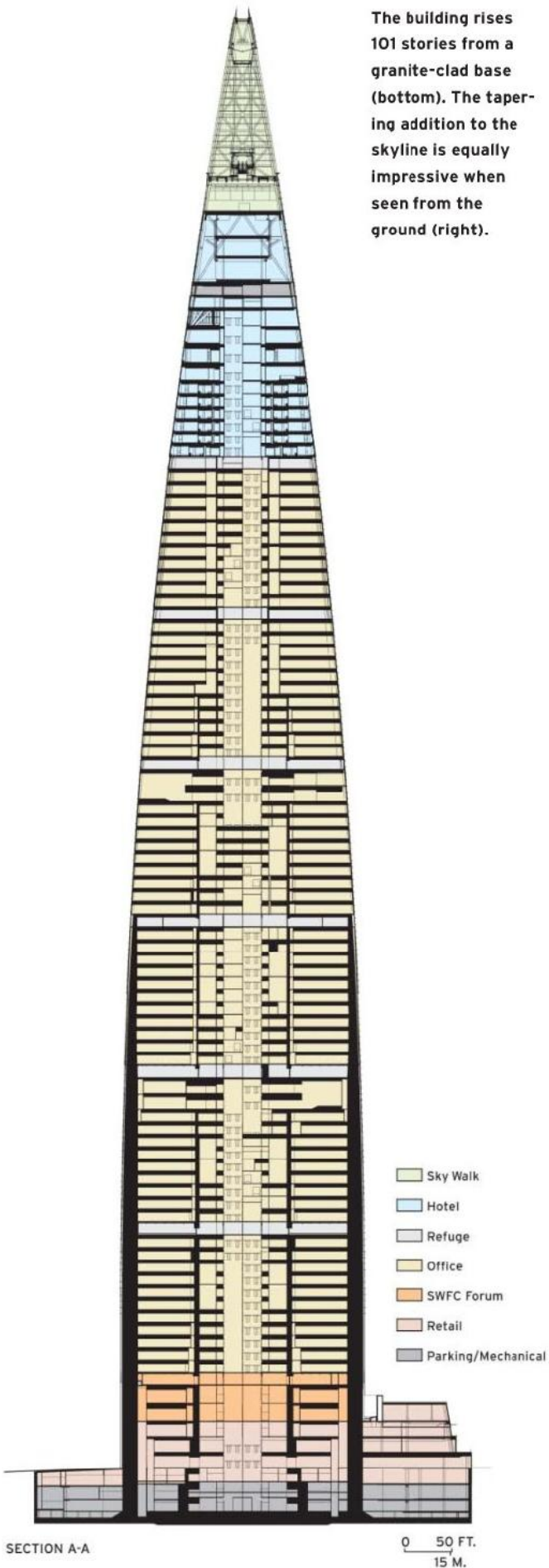

A pyramidal glass structure at the base of the building marks the office entrance.



## KEEPING UP WITH A GROWING, CHANGING BUILDING

The Mori Building Company's decision to increase the height and girth of the Shanghai WFC after the foundation piles had already been installed left Leslie E. Robertson Associates (LERA), engineers of New York's World Trade Center (WTC) and Hong Kong's Bank of China tower, with a daunting design task.

"People said it couldn't be done," LERA founding partner Les Robertson recalls. "But to build a bigger building on the same foundation, you needed to make it lighter." LERA's solution was to reduce the size of the concrete shear walls of the service core. In order to do that, it had to increase the stiffness of the lateral force-resisting system of the perimeter wall.

LERA introduced a series of outrigger trusses, which it had previously used in New York's WTC. At three stories high, each set of outrigger trusses connects the core with the megacolumns at the building corners. "The outrigger truss counteracts overturning moment in the same way that poles

stabilize a skier," Robertson says.

Composed of structural steel and reinforced concrete, the massive section of the megacolumns also support the diagonals that span the 12 stories between refuge floors. The steel boxes of the diagonals are filled with concrete to increase stiffness. Though the Chinese building authorities wanted to add cross bracing, LERA convinced them otherwise, arguing that it didn't add to the structure's integrity, while it cluttered the facade's appearance. Instead, a belt truss around the perimeter of the refuge floors, and slender columns between refuge floors on each face of the tower (including the tapering upper portion), provide additional support.

As for the other major change in the building's design, namely the aperture at the top, the engineers were given a break. According to LERA managing partner SawTeen See, "A trapezoid is much easier to build than a circle." *Josephine Minutillo*



A circular cofferdam, which is inherently self-bracing, sped up construction of the tower (below left). The steel and concrete megacolumns at the building's corners reach close to 18 feet in length (above left).



1. Foundation piles
2. Core wall
3. Basement wall

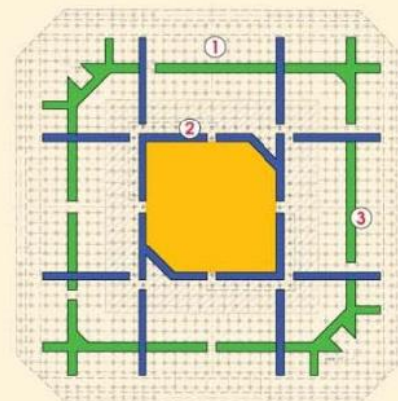

EXISTING PILING PLAN N ←

larger floor plates for the banking and finance tenants that the Japanese developer, the Mori Building Company, sought to attract; toward the top, the narrower, more rectangular plans are ideally suited for the hotel. But from the start, Pedersen and his team saw the Shanghai World Financial Center as serving a civic role, as well. “We wanted to make it part of the civic fabric of the city,” says KPF managing principal Paul Katz, FAIA, explaining why particular emphasis was placed on the building’s public functions.

Clustered around the rough, granite-clad base, separate pavilions and entrances for the main office tower, lobby, hotel, observation decks, and retail and conference complex are meant to “create an experience like a small village gathered at the base of a cathedral,” says Pedersen. In truth, the effect is more like an assemblage of standard-issue, corporate gestures gathered at the base of a 101-story skyscraper. But KPF’s compositions of intersecting, curving, and angled planes of glass, steel, limestone, green granite, and bronze do a decent job of breaking up, and thus orienting, the podium’s otherwise monolithic, square geometry.

The building, which is essentially a stack of 12-story modules divided by refuge floors—temporary places of safety

during a building evacuation—presented a number of daunting structural challenges. For one, the site’s soft soil required 2,200 piles to be driven up to 250 feet into the ground. To offset swaying, two 150-ton mass dampers were installed at the 90th floor. And that was just the tip of the iceberg.

Indeed, plagued by fits and starts, the Shanghai World Financial Center was in many ways an exercise in creative adaptation. When Mori, for which KPF previously designed Tokyo’s Roppongi Hills complex, first contracted the firm to design the building in 1992, it was set to be 1,500 feet tall. But with increasing demand for IT amenities such as data centers and raised access floors, the building’s footprint was enlarged and its height increased by 100 feet. These changes were requested, however, after the foundation had already been laid—and after the Asian financial crisis of 1997 had put a halt to construction (see sidebar, page 188).

By the time KPF resumed work in February 2001, the building’s structural engineer, Leslie E. Robertson Associates, had devised a system of diagonal braces to help make the tower not only bigger and higher, but lighter as well. But later that year, September 11 brought renewed attention to safety in supertall buildings. So the designers added a third fire stair,

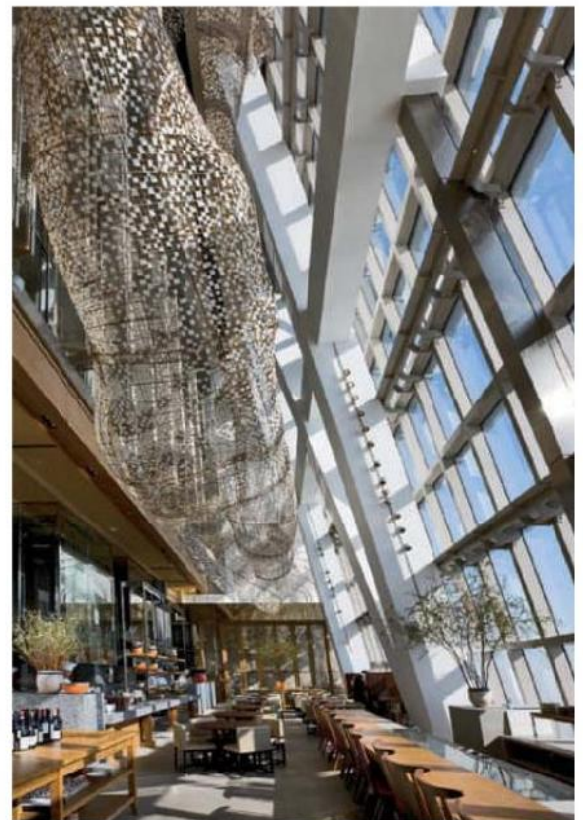
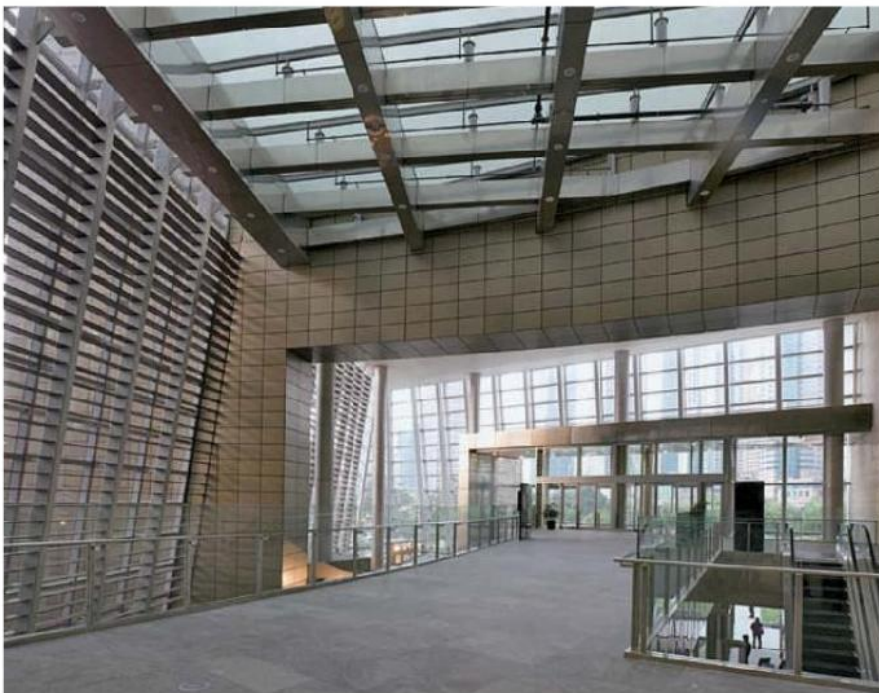

The office lobby features an upper mezzanine that connects to the retail levels and a future pedestrian bridge network linking to nearby subway and bus terminals (above left and left). The hotel

culminates in 100 Century, a multilevel restaurant featuring open kitchens, bars, and private dining set within an atrium overlooking the city from the 91st to the 93rd floor (above).





The transparent glass floor of the Sky Walk 100 offers dramatic, if hair-raising, views to the world below.

and reconfigured the observatory elevators to service the tower's refuge floors in case of emergency evacuation.

And yet the biggest curve ball came from something seemingly innocuous: the aperture cut out from the building's summit. Serving as the project's iconic centerpiece, it was originally a circle intended to evoke a traditional Chinese moon gate and would have doubled as a gondola ride—an inside-out Ferris wheel a hundred stories in the sky. But aware of the project's Japanese developer, many Chinese saw in it Japan's rising sun, an interpretation that proved intolerable given the countries' deep, historic strains. "It was presented by me as a moon gate with complete confidence," recalls Pedersen, unaware of the controversy he was about to ignite.

With KPF sent back to the drawing board once more, the circle became a trapezoid, making the building look something like a slick bottle opener (a fact not lost on the gift shop's merchandisers). The architects recast the vast space housing the gondola ride and the planned spiraling ramp leading up to it as a new three-story restaurant and bar complex for the Park Hyatt, alongside an exhibition and event space. And they redesigned two new observation decks that, if not quite

as showy as the gondola ride, exhibit all the bravado. At the bottom of the trapezoid, one deck features an operable glass roof; at the top, the second has become known for the hair-raising experience of walking on glass floors a third of a mile from the ground. "It's really about lifting people up, not just making the world's tallest record," KPF senior designer David Malott says of the building.

Which is probably a healthy attitude. After all, currently rising next door is the Gensler-designed Shanghai Tower. And if all goes as planned, it will dwarf the Shanghai World Financial Center by 400 feet when it is completed in 2014. ■

**Project:** *Shanghai World Financial Center, Shanghai*  
**Architect:** *Kohn Pedersen Fox—A. Eugene Kohn, FAIA, William Pedersen, FAIA, Paul Katz, FAIA, principals; John Koga, AIA, project manager*

**SOURCES**  
**Glass:** *Shanghai Pilkington*  
**Elevators and escalators:** *Otis; Hitachi; Toshiba; ThyssenKrupp*  
**Building maintenance equipment:** *E.W. Cox*

 To comment on this project and rate it, go to [architecturalrecord.com/projects](http://architecturalrecord.com/projects).



# MADISON

ENGINEERED PRODUCTS FOR THE WORLD

*The Symbol of Quality*

## ARCHITECTURAL ACM



**Aluminum Composite Metal Cladding**  
Using CNC routing machines to meet exact specifications Madison Industries provides the most consistent product on the market

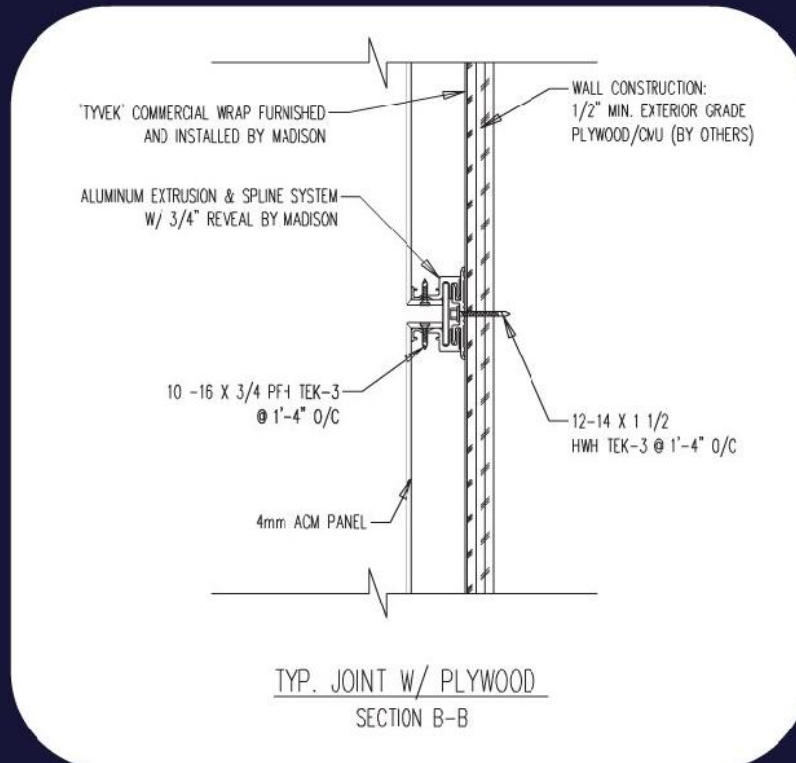

[www.madisonind.com](http://www.madisonind.com)

California  
(323) 583-4061

Arizona  
(602) 252-3083

Oklahoma  
(918) 224-6990

Georgia  
(770) 483-4401

CIRCLE 79



Complex projects?

# Simplify.

The economy is rough enough—don't waste resources endlessly editing contracts. Let us help you save time and money.

Our new software release offers easy-to-use features that let you manage documents, enter required information in a snap, and calculate with the power of Microsoft® Excel, all in one tool.

Simplify your projects with the most widely accepted contract documents available. The Industry Standard—that much better.

Find us at [www.aia.org/contractdocs](http://www.aia.org/contractdocs)

**NEW Documents Included**

**AIA Contract Documents®**  
THE INDUSTRY STANDARD



All products shown from **Wausau Tile**

- Custom Concrete
- Pavers
- Planters
- Wall Units

“Responding to the needs of our customers has been the guiding principle in all we do.”

Ed Creske, Founder

CIRCLE 80

**WAUSAU TILE**

800.388.8728  
[www.wausautile.com](http://www.wausautile.com)  
[wtile@ausautile.com](mailto:wtile@ausautile.com)



Great  
Designs  
Require  
Great  
Products  
Sweets Network<sup>®</sup>

Conceptualize



Develop



Select



Document

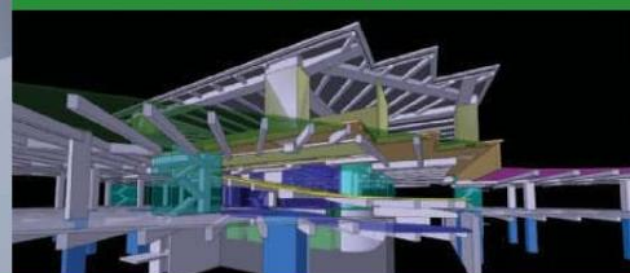

sweets.com

Green Products CAD 3-Part Specs Product Catalogs 3D Models BIM Project Galleries

Through every stage, McGraw-Hill Construction has the essential resources to bring your designs to life.

Architectural Record GreenSource Sweets Network<sup>®</sup> **SNAP**  
Dodge ENR Regional Publications



**REALIZE THE POTENTIAL**



**OF \$160 BILLION\*  
IN ENERGY SAVINGS.**

[USGBC.ORG/LEED](http://USGBC.ORG/LEED)



\* Potential energy efficiency savings of building sector by 2030. McKinsey & Company (2007). *Reducing U.S. Greenhouse Gas Emissions: How Much at What Cost?*

THE AMERICAN PLANNING ASSOCIATION & THE NATIONAL BUILDING MUSEUM PRESENT A HALF-DAY SYMPOSIUM:

# 1909 – 2109: SUSTAINING THE LASTING VALUE OF AMERICAN PLANNING

Federal officials, community activists, and other experts reflect on the first 100 years of the planning movement, the current state of planning, and where the movement is headed in the next 100 years.

## CONFIRMED SPEAKERS INCLUDE:

**Elinor Bacon**, President, E.R. Bacon Development (symposium moderator)

**Her Excellency Carolina Barco**, Colombia's Ambassador to the United States (keynote speaker)

**Eugenie Birch**, Co-Director for the Penn Institute for Urban Research and Professor and Chair of the Department of City and Regional Planning

**Robert Fishman**, Professor of Architecture and Urban Planning, University of Michigan

**Steven McCullough**, President and CEO, Bethel New Life, Inc.

**Chris Silver**, Dean, College of Design, Construction & Planning, University of Florida

above: © Terry Lumme at Aero Arts Aerial Photography/Courtesy of the Jonathan Rose Companies. right: Photo by Beau Wade.

Thursday, May 21, 2009 / 2:00–6:15 pm

## SESSION TOPICS

### Session 1: 1909–2009: A Legacy of Planning

What were the significant achievements of America's first 100 years of planning and designing sustainable communities?

### Session 2: 2009–2109: Sustainable Planning for Today and Tomorrow

What are today's planning challenges and the solutions for designing the next 100 years of green communities? How can citizen action effect social and environmental change in providing real world solutions and advocacy for their neighborhoods?



## EVENT PRICE, REGISTRATION, AND MORE INFORMATION

\$20 National Building Museum and American Planning Association Members

\$35 Non-members

FREE for Students

Visit [www.nbm.org](http://www.nbm.org) or call 202.272.2448.

*1909–2109: Sustaining the Lasting Value of American Planning* is co-presented by the National Building Museum and the American Planning Association as part of the *Green Community* exhibition.

a symposium at the

# NATIONAL BUILDING MUSEUM

401 F Street NW Washington, DC 20001 | 202.272.2448 | [www.NBM.org](http://www.NBM.org) | Red Line Metro, Judiciary Square



American Planning Association  
Making Great Communities Happen



DESIGNED, ENGINEERED AND MANUFACTURED BY C.R. LAURENCE CO.

# 'ALL-GLASS' ENTRANCE SYSTEMS

- DOOR AND SIDELITE RAILS | PATCH HARDWARE
- COMMERCIAL DOOR PULLS | HEADERS AND CHANNELS
- STACKING PARTITION SYSTEMS | SLIDING GLASS DOORS
- DOOR CLOSERS | AND MORE...

SEE IT ALL IN OUR ARCHITECTURAL  
HARDWARE SPECIALTY CATALOGS:

## AH10 'All Glass' Entrances AND LP10 Commercial Door Pulls

Over 250 color pages showing products for the construction of beautiful 'all-glass' storefronts and entrances. See many beautiful installations showing the products in use to help give you ideas and make the right selection for your next job. All CRL catalogs can be downloaded or viewed online at [crlaurence.com](http://crlaurence.com)



**NEW!** LP10  
ARCHITECTURAL  
HARDWARE  
Commercial  
Door Handles

**CRL**

**C.R. LAURENCE COMPANY**

[crlaurence.com](http://crlaurence.com) | Worldwide Supplier  
Contact us by phone at (800) 421-6144, and ask  
for the Architectural Hardware Division  
at ext. 7700. Fax (800) 587-7501

JAB243-3/09

ISO 9001:2000 Certified

CIRCLE 82







**PELLA ADVANTAGE NUMBER 84:**

**WE'VE ANSWERED THE CALL.**



Looking for the ideal windows and doors for your BIM projects? You've found the right match. Pella's Autodesk Revit families are now available for use with Revit Architecture. You can access the Pella product of your choice right from your Revit design application by using the Autodesk Seek web service — then simply drag-and-drop it into your BIM project. The perfect partner dedicated to making your models more accurate and easier to create. That's **The Power Of Yellow.**

Visit [pellacommercial.com/BIM](http://pellacommercial.com/BIM) for all your BIM window and door needs.

Pella Revit families also available at [seek.autodesk.com](http://seek.autodesk.com) and [caddetails.com](http://caddetails.com).

Visit us at **AIA booth #4247** in the North Hall.

© 2009 Pella Corporation



**COMMERCIAL**

# LEED Looks Ahead With an Ambitious Overhaul

RATING SYSTEM REVAMP PROVIDES MORE GROUNDING IN SCIENCE AND PROMOTES THOSE STRATEGIES WITH THE GREATEST ENVIRONMENTAL BENEFIT

By Joann Gonchar, AIA

Since its launch in 1998, the Leadership in Energy and Environmental Design (LEED) program has become widely accepted as the standard measure of sustainability for buildings. To date, almost 21,000 projects, representing more than 5 billion square feet, have registered their intent to seek certification under the system. Another sign of the program's success is the long list of municipalities, state governments, and federal agencies that have adopted LEED, incorporating it into construction guidelines, legislation, and requirements for incentive programs.

Along with this market acceptance have come the inevitable growing pains. Users complain about confusing documentation requirements and project review delays, while some critics say that the system, developed through a consensus process, is not backed by enough hard science. Although its creator, the U.S. Green Building Council (USGBC), has done much to respond to these criticisms as it developed and expanded LEED in recent years, it is now in the process of an extensive overhaul—one that it hopes will maintain the program's rate of market uptake while advancing its technical rigor. "We were cognizant that LEED works now, but that it could work better," says Brendan Owens, USGBC vice president of LEED technical development.

The revamp initiative, which the council refers to as LEED version 3.0, or LEED v3, has several components: revisions to the green building rating system, updates to the online tool that supports project certification, and changes to administration of the certification process. It also includes a new program for accrediting the professionals who work on LEED buildings.

At press time, LEED 2009 (the title given to the rating system component of the v3 effort) was set to go live on April 27. And when long-time users register new projects, they may notice adjustments intended to more closely align the many rating systems that fall under the LEED rubric, including a version targeted at operations and maintenance, called LEED for Existing Buildings; one tailored to the design and construction of speculative buildings, known as LEED for Core & Shell, and the oldest and most widely used system, LEED for New Construction. This "harmonization" process includes revising similar credits in the various systems so that they cite the same standards and use the same language. This change should make LEED more user-friendly, especially for people who work on multiple projects of diverse types simultaneously. "A personal frustration has been the subtle differences between credits with the same title and the same intent," says Joel McKellar, Assoc. AIA, a researcher at Charlotte, N.C.-based LS3P and author of the blog [reallifelleed.com](http://reallifelleed.com).

As part of the effort to provide consistency, LEED 2009 moves to a 100-point scale, with regional and innovation credits providing an opportunity for projects to earn up to 110 points. Previously, the individual rating products each had their own point totals. For example, LEED for New Construction, LEED for Schools, and LEED for

Commercial Interiors, were based on 69-point, 79-point, and 57-point scales, respectively. LEED 2009 also introduces uniform certification thresholds across all the rating systems. Projects that earn 40 points will qualify for certification at the lowest level. A minimum of 50 points is required for Silver certification, 60 points for Gold, and 80 for Platinum, the highest level of certification.

The alignment of the individual rating systems, along with the new thresholds and the introduction of the 100-point scale, should simplify the documentation and certification process. In addition, they also help establish a framework that can accommodate more building types and market-specific requirements over time. However, the goals

of the overhaul are more ambitious than streamlining and rationalizing the system. The larger aim was to provide incentives for project teams to deploy those strategies with the greatest potential for environmental or human-health-related benefit, with greenhouse-gas reduction at the top of the priority list. "LEED 2009 emphasizes the critical issues of energy, transportation, and water, and makes them the most important," says Rand Ekman, AIA, director of sustainability at OWP/P, Chicago.

This prioritization is achieved by redistributing points among the various LEED credits to emphasize some over others. To formulate this reallocation, USGBC staff, committees, and consultants started with an inventory of 13 aftereffects of human activity created by the U.S. Environmental Protection Agency (EPA) and known as "TRACI." Short for "Tool for the Reduction and Assessment of Chemical and Other Environmental

**"LEED 2009 emphasizes the critical issues of energy, transportation, and water."**



## CONTINUING EDUCATION

Use the following learning objectives to focus your study while reading this month's ARCHITECTURAL RECORD/AIA Continuing Education article. To earn one AIA learning unit, including one hour of health, safety, and welfare/sustainable design (HSW/SD) credit, turn to page 206 and follow the instructions.

## LEARNING OBJECTIVES

After reading this article, you should be able to:

1. Identify the main components of the LEED Version 3 initiative.
2. Explain the key differences between LEED 2009 and preceding versions of the rating system.
3. Understand the methodology used to derive the LEED 2009 credit weights.
4. Understand the changes to the LEED project certification process and the LEED professional accrediting program.

# Credit weighting categories

The LEED point redistribution (below) is based on an inventory of 13 aftereffects of human activity (right) weighted according to a tool developed by the National Institute for Standards and Technology. Because of the emphasis placed on controlling carbon emissions in this analysis, energy credits are the clear point winner in the reallocation effort.

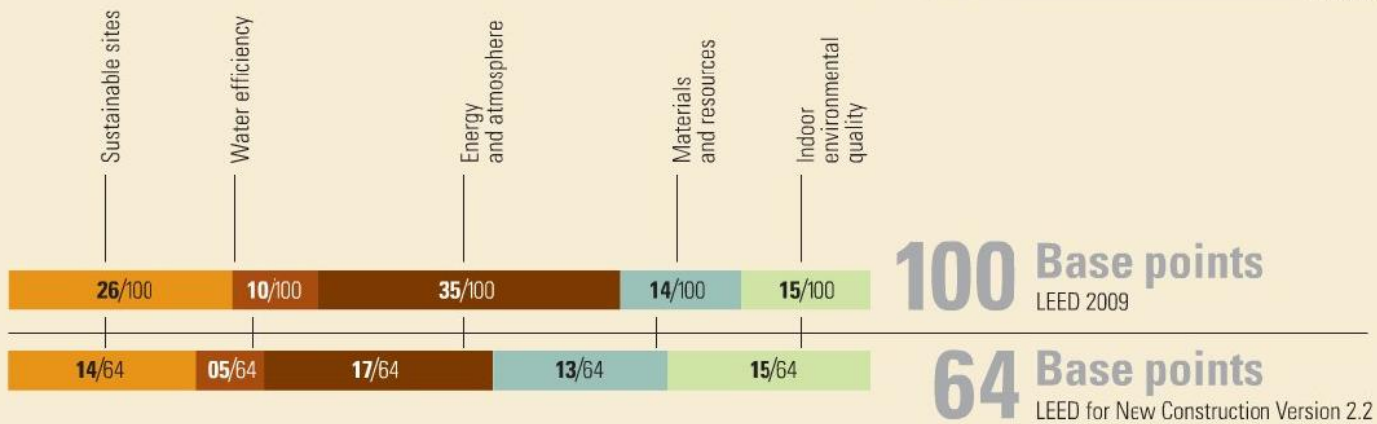
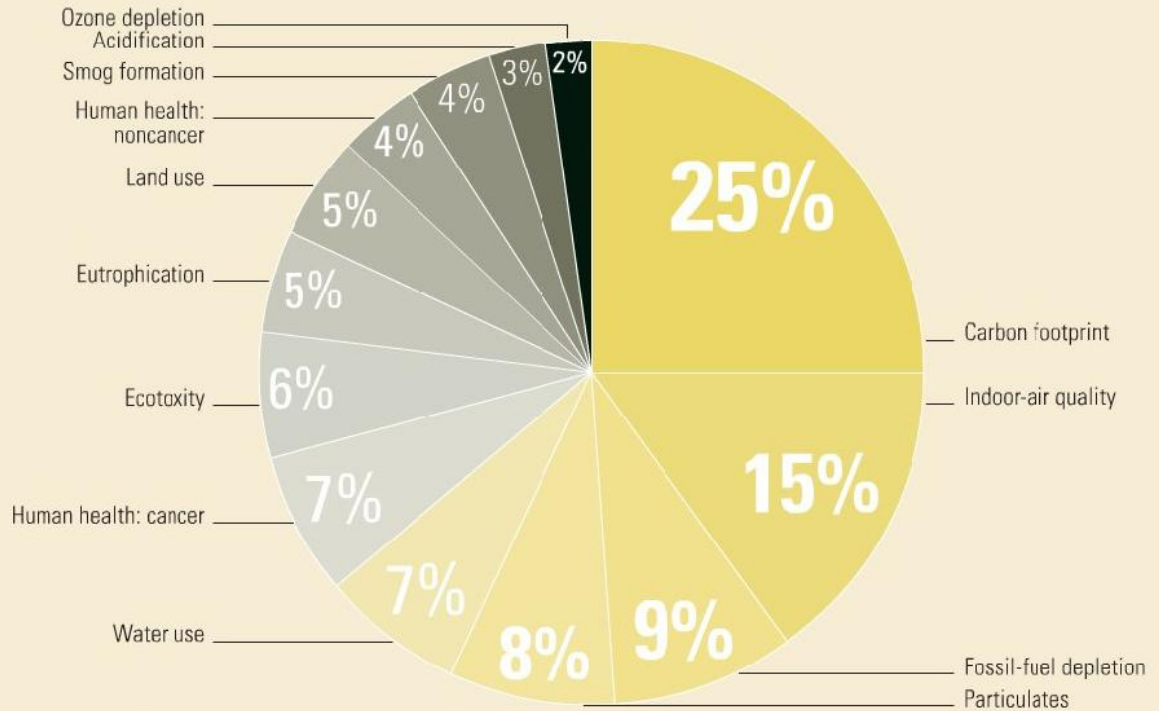

INFORMATION GRAPHICS: ENCARNITA RIVERA; DATA: USGBC, EXCEPT AS NOTED

Impacts,” TRACI includes categories such as fossil-fuel use, ozone depletion, and global warming.

Next in the reallocation process was prioritization of the TRACI categories. To assign a relative importance to each, the LEED 2009 team relied on a tool developed by the National Institute for Standards and Technology (NIST). Ultimately, the council created a matrix that established the relationship between existing LEED credits and the TRACI categories. The matrix served as the basis of a spreadsheet for calculating the number of points each credit is worth.

Energy and transportation credits came out as big point winners in this analysis, primarily because of the importance assigned to controlling carbon emissions. For example, strategies intended to increase energy efficiency and the reliance on renewable power generated on-site can earn projects up to 26 points, versus 13 when compared to the previous LEED for New Construction. A location close to public transportation, which also has the potential to reduce occupants’ energy use, counts for six points, up from only one in the old system.

Some credits with a less direct link to slowing global warming also have heavier emphasis in LEED 2009. For example, ambitious water conservation goals can help garner as many as 10 points, double the number previously available.

The reallocation process also involved some value judgments along with the weighting exercise. Partly because of gaps in the data, strict application of the TRACI-NIST tool would have made some credits worth almost nothing, especially for the categories of indoor air quality and human health. But it was important to the LEED 2009 development team to retain the existing credits, even those associated with relatively small environmental benefit. So all are assigned at least one point in the new system. The approach keeps the structure of the rating system intact and should make it seem familiar to users accustomed to the preceding versions of LEED. “It is an elegant solution,” says Scot Horst, the USGBC’s senior vice president of LEED. “The scorecard doesn’t look that different.”

However, review of the new rating system does reveal a few significant credit adjustments. For example, LEED previously awarded

# Certification thresholds

	40 CERTIFIED	50 SILVER	60 GOLD	80 PLATINUM	LEED 2009
26 CERTIFIED	33 SILVER	39 GOLD	52 PLATINUM	LEED for New Construction Version 2.2	

LEED 2009 introduces uniform certification thresholds, based on multiples of 10 points, across all its rating systems. They replace the older versions' seemingly arbitrary point requirements.

## Reference guides

\*In development

The revamping effort includes revising credits that resemble each other in the multiple LEED products so that they rely on the same language. A manifestation of this "harmonization" process are the reference guides, which provide supporting documentation to the rating systems. The new guides group similar LEED products, reducing nine systems to three volumes.

**Green Building Operations & Maintenance**  
2009 Edition

LEED for Existing Buildings  
LEED for Existing Schools \*

**Green Building Design & Construction**  
2009 Edition

LEED for New Construction  
LEED for Core & Shell  
LEED for Schools  
LEED for Healthcare \*  
LEED for Retail \*

**Green Interior Design & Construction**  
2009 Edition

LEED for Commercial Interiors  
LEED for Retail Interiors \*

points for indoor water-use reduction beyond 20 percent when compared to a "baseline," or code-compliant, building. But in the new system, this savings level becomes a prerequisite. Projects earn no points for satisfying this performance minimum, but those that do not comply will not be eligible for certification. To earn points for efficient indoor water use, projects must achieve at least a 30 percent reduction. These new water thresholds are achievable and appropriate, according to Anica Landreneau, Assoc. AIA. "It is possible to reach 40 to 50 percent savings with fixture selection alone," adds Landreneau, sustainable-design-practice leader in HOK's Washington, D.C. office.

Another notable change is the introduction of regional credits. For the first time, the rating system will take into account environmental issues important in projects' specific locations. Working with its local chapters and affiliates, the USGBC has identified credits that address the priorities of given environmental zones. Projects will be able to earn a maximum of four bonus points on top of the base 100 for achieving these preselected credits. For example, projects in rural areas of Michi-

gan can earn extra points for preserving agricultural land, reducing light pollution, and minimizing storm-water runoff into the Great Lakes.

The council considers this bonus-point approach as an interim step. It hopes to eventually incorporate the regional priorities into the body of the rating system. "But this is two or three versions down the road," according to Owens.

One aspect of LEED 2009 should help the USGBC with a long-term goal of better understanding the relationship between credits and building performance. As part of project registration, teams will need to agree to report postoccupancy energy and water use. There will be a number of ways to fulfill this provision, including participation in the existing buildings program, which has a performance measurement requirement, or signing a waiver that would allow the USGBC to obtain the information directly from the utility company. The council hopes to use the data to perform studies like the somewhat controversial one it commissioned from the New Buildings Institute (NBI). Completed in March 2008, the NBI analysis determined that energy use in LEED

# LEED Certifications to date

More than 2,300 projects, representing about 276 million square feet, have been certified under the four most popular LEED rating systems.

ARCHITECTURAL TECHNOLOGY

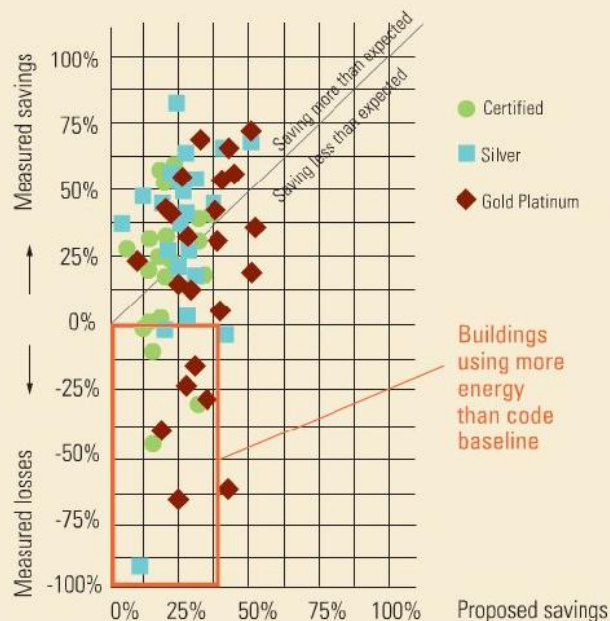
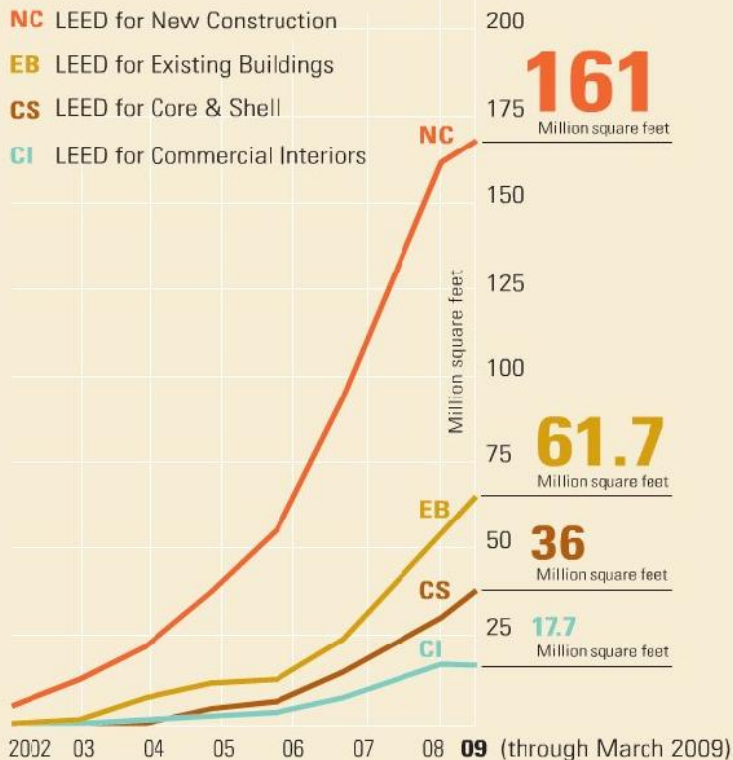

## LEED Building energy performance

LEED 2009 for New Construction introduces a requirement that project teams report postoccupancy energy- and water-use data. The USGBC hopes that the provision will help it better understand the

relationship between LEED and building performance, and will facilitate studies like the one it commissioned from the New Buildings Institute. Although the study found that LEED buildings perform 25 to 30 percent better

than average, the analysis also showed large variations among individual buildings. A comparison of measured versus proposed savings (above) showed that some projects used more energy than allowed by the code.

DATA: NBI (RIGHT)

buildings is 25 to 30 percent better than the national average. However, it also showed large variations among individual buildings. According to one of the study's analyses, 25 percent of the participating projects had better than expected performance, while 21 percent showed performance that was below the code baseline.

The study also highlights a problem that is just as important as its findings: the difficulty of collecting performance data. NBI's examination is based on 22 percent of the 552 buildings that had been certified under LEED for New Construction Version 2, through December 2006. Only these 121 projects were able to supply the full-year of postoccupancy energy numbers required for participation in the study. Collecting the data for even this small pool of projects required "an extraordinary level of effort," according to Owens. The hope for the new reporting requirement is that it will "automate the collection of data to inform the future development of the rating system," he says.

The LEED v3 launch also includes an improved tool for managing the project registration and certification process electronically.

The council, in collaboration with software companies Adobe and SAP, developed the application in response to complaints that the system's predecessor is slow, buggy, and prone to frequent crashes. "The USGBC staff uses it on a daily basis, so we are aware of its shortcomings," says Mike Opitz, USGBC vice president of LEED development. System designers also sought input from other frequent users, such as project administrators and reviewers, he says.

The new LEED Online, which will be available for use only in conjunction with LEED 2009 projects (those registered under previous versions of LEED will be required to continue to use the older online system), represents an investment of "several million dollars," says Opitz. In addition to providing improved speed and reliability, the application is designed to facilitate communication between the reviewer and the project team, according to the council.

Along with the revamp of the rating system and the online application, LEED v3 includes an overhaul of the project certification process and the program for qualifying LEED Accredited Professionals

# Now you see them.



# Now you don't.

Whether you want fire doors to stand out or blend in, nothing complements your vision like The RITE Door.<sup>®</sup>

The RITE Door opens possibilities previously closed to typical fire doors. Thanks to an extensive selection of colors, textures and finishes, this integrated door system can seamlessly blend with your design or accentuate it. Each door also features technically perfect, pre-installed hardware that is so low profile it's hardly noticeable . . . unless you want it to be. [RiteDoor.com](http://RiteDoor.com)

ASSA ABLOY, the global leader in door opening solutions

 Adams  
Rite  

---

ASSA ABLOY

# LEED timeline

ARCHITECTURAL TECHNOLOGY

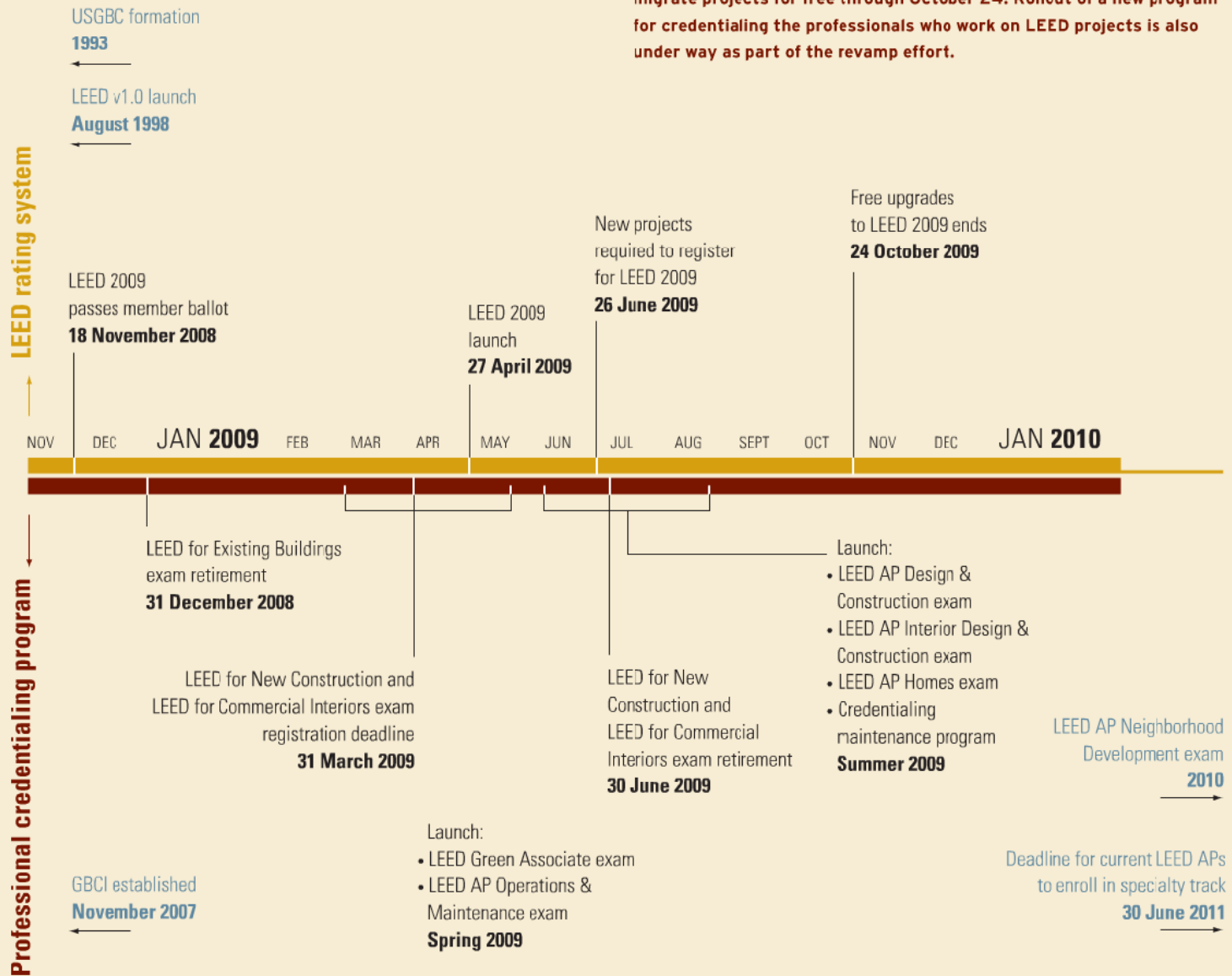

DATA: USGBC AND G3CI

(AP). In conjunction with the v3 launch, the USGBC officially moves administration of the certification and AP programs to the Green Building Certification Institute (GBCI), a nonprofit organization spun off from the USGBC in late 2007. The council will continue to manage the development of the rating system, the online tool, and related resources such as educational offerings.

For the certification piece, GBCI will manage 10 organizations, including Underwriters Laboratories and Lloyd's Register Quality Assurance, which will in turn oversee the project review process. Under the old system, all LEED project submissions were reviewed by the USGBC with the support of independently contracted reviewers. According to USGBC and GBCI, the administrative restructuring should eliminate the review and certification delays that have long plagued the LEED program. In addition, the two organizations say the changes will bring the program in line with the protocols of the International Organization for Standardization (ISO) and the American National Standards Institute (ANSI). Certification will "become a real third-party process," says Horst.

Although the new LEED officially launched in late April, project teams have the option of registering buildings under the old system through June 26. Teams already using previous versions of the rating system can migrate projects for free through October 24. Rollout of a new program for credentialing the professionals who work on LEED projects is also under way as part of the revamp effort.

Also being closely watched by the green building community are the coming modifications to the AP program. The changes, which will be phased in over the coming year, include introduction of a three-tiered system of credentials. The lowest tier will be LEED Green Associate. It is intended for people who want to demonstrate a commitment to green building practices but may not be directly involved in LEED projects. GBCI expects that this title will appeal to nontechnical professionals, such as marketing staff in design firms or lawyers involved in real estate development deals. The second tier will be roughly the equivalent of the current AP credential, but will include specialty tracks that correspond to the various LEED rating systems. Finally, LEED Fellow, will designate an "elite" level of expertise.

The new credentialing is a response to concerns that passage of the current multiple-choice qualifying exam requires rote memorization rather than a true understanding of green building practices and principles. "The goal is to make sure that the credentials are targeted and meaningful," says Peter Templeton, GBCI president.



## Beautiful, versatile, sustainable western red cedar

Western Red Cedar has unique, natural performance characteristics and exceptional beauty that bring warmth, character and longevity to homes and commercial buildings around the world. It is this bundle of properties that has made "Cedar" the choice of discerning architects, builders and homeowners alike.

Western Red Cedar is renowned for its naturally occurring resistance to moisture, decay and insect damage. Its natural durability, dimensional stability and exceptional beauty make it ideal for a wide variety of exterior and interior uses. Western Red Cedar offers enormous versatility in styles and applications. Equally important, it has a low environmental impact relative to other building materials. Western Red Cedar is harvested legally and sustainably from independently certified forests in British Columbia.

Enhance the beauty of your next project, build with Western Red Cedar. For more information and suppliers near you, please visit our website.

[www.wrcla.org](http://www.wrcla.org)

1.866.778.9096





Although GBCI is still developing the criteria for fellow status, it has already outlined the requirements for the first two tiers of accreditation. Earning the Green Associate credential will involve passing an exam that will cover core concepts and the key points of the LEED rating system. Qualification for the AP status will have two steps: Candidates will be required to take the first-tier exam as well as a test tailored to their chosen specialization. In addition, AP hopefuls will have to demonstrate LEED project experience. GBCI plans to institute continuing education requirements for both designations—15 hours for Associates and 30 hours for APs, biennially.

The more than 101,000 people who have passed the current exam, and the many more expected to successfully complete the test before GBCI discontinues it at the end of June, will be permitted to retain their AP designation. They will also have the option of enrolling in the new system. But in order to adopt one of the specialized credentials, they will need to complete the continuing education requirement.

GBCI hasn't yet provided the details of what kind of courses will count, except for noting that 6 of the 30 hours will need to be "LEED specific." However, many observers expect that satisfying the

requirement will be relatively painless, at least for professionals who participate in continuing education in order to maintain their licenses. "For architects and engineers, there will be overlap," predicts McKellar. "But from those [disciplines] that don't already have to complete continuing education, there will be resistance," he says.

With regard to changes to the LEED program as a whole, the reaction of seasoned LEED users has been mostly positive. Many design consultants say that the new system should not be a huge adjustment for project teams. "Obviously there will be a learning curve," says Rob Bolin, a senior vice president with mechanical engineering firm Syska Hennessy, in Chicago. "However, if people are completing LEED projects now, they will be able to continue to do so in the future," he says.

Even the recession, sources predict, should not be that much of a factor in market uptake. "The economy will hamper total construction volume," according to OWP/P's Ekman. "But it shouldn't change the percentage of projects that seek certification." ■

 For this story and more continuing education, as well as links to sources, white papers, and products, go to [architecturalrecord.com/tech](http://architecturalrecord.com/tech).



## AIA/ARCHITECTURAL RECORD CONTINUING EDUCATION

### INSTRUCTIONS

- Read the article "LEED Looks Ahead With an Ambitious Overhaul" using the learning objectives provided.
- Complete the questions below, then fill in your answers on the next page.
- Fill out and submit the AIA/CES education reporting form on the next page or take the test online at [continuingeducation.construction.com/](http://continuingeducation.construction.com/) to receive one AIA learning unit.

### QUESTIONS

1. A key component of LEED v3 is which?
  - a. the revised LEED rating system
  - b. updates to LEED Online
  - c. changes to the building certification process and the professional credentialing program
  - d. all of the above
2. The goal of the LEED 2009 effort is which?
  - a. advance technical rigor while maintaining market uptake
  - b. provide incentives for those strategies with the greatest potential for environmental benefit
  - c. align the multiple rating systems that fall under the LEED rubric
  - d. all of the above
3. How many points are required to earn a Platinum rating under LEED 2009?
  - a. 100
  - b. 80
  - c. 52
  - d. 69
4. As the starting point for weighting LEED credits, USGBC relied on a list of aftereffects of human activity created by which organization?
  - a. TRACI
  - b. NIST
  - c. EPA
  - d. none of the above
5. Existing credits determined to have almost no environmental benefit according to strict application of the USGBC's weighting matrix would be worth how many points in LEED 2009?
  - a. at least one point
  - b. a fraction of a point
  - c. no points
  - d. negative points
6. Designing a building that uses 20 percent less water than a baseline building will accomplish which under the LEED 2009 system?
  - a. earn 10 points for water efficiency
  - b. earn 5 points for water efficiency
  - c. earn 1 point for water efficiency
  - d. satisfy minimum water-efficiency requirements
7. All of the following are true regarding the regional priority credits except which?
  - a. projects can earn up to 4 bonus points for achieving such credits
  - b. projects can earn up to 10 bonus points for achieving such credits
  - c. the USGBC worked with its chapters to identify credits that address location-specific concerns
  - d. the USGBC hopes to eventually incorporate the regional credits into the body of the rating system
8. LEED 2009 requires that project teams report which?
  - a. postoccupancy energy and water use
  - b. postoccupancy energy use
  - c. postoccupancy water use
  - d. none of the above
9. The responsibilities of the Green Building Certification Institute include which?
  - a. administration of project certification
  - b. administration of project certification and professional credentialing programs
  - c. development of the LEED rating system
  - d. development of the LEED rating system and administration of project certification
10. All of the following statements regarding the new LEED Online application are true except which?
  - a. it is a tool for managing the registration and certification process electronically
  - b. it is designed to be faster and more reliable than its predecessor
  - c. it is designed to facilitate communication between project teams and reviewers
  - d. it will be available for use in conjunction with projects registered under versions of the rating system that precede LEED 2009

# I / ARCHITECTURAL RECORD CONTINUING EDUCATION



Program title: "LEED Looks Ahead With an Ambitious Overhaul," ARCHITECTURAL RECORD (05/09, page 199).

AIA/CES Credit: By reading this article and successfully completing the exam, you can earn one AIA/CES LU hour of health, safety, and welfare/sustainable design (HSW/SD) credit. (Valid for credit through May 2011.)

Directions: Select one answer for each question in the exam and circle appropriate letter, or take this test online at no charge at [continuingeducation.construction.com/](http://continuingeducation.construction.com/). A minimum score of 80 is required to earn credit.

- |            |             |
|------------|-------------|
| 1. a b c d | 6. a b c d  |
| 2. a b c d | 7. a b c d  |
| 3. a b c d | 8. a b c d  |
| 4. a b c d | 9. a b c d  |
| 5. a b c d | 10. a b c d |

LAST NAME	FIRST NAME	MIDDLE INITIAL OR NAME
FIRM NAME		
ADDRESS	CITY	STATE ZIP
TELEPHONE	FAX	E-MAIL
AIA ID NUMBER	COMPLETION DATE [MM/DD/YY]	

Check one:  \$10 payment enclosed. (Make check payable to Architectural Record and mail to: Continuing Education Certificate, P.O. Box 5753, Harlan IA 51593-1253.) For customer service, call 877/876-8093.

Charge my:  Visa  Mastercard  American Express Card# \_\_\_\_\_

Signature \_\_\_\_\_ Exp. Date \_\_\_\_\_

Check below:

- To register for AIA/CES credits: Send the completed form with questions answered to above address or fax to 888/385-1428.
- For certificate of completion: As required by certain states, answer test questions, fill out form above, and mail to above address or fax to 888/385-1428. Your test will be scored. Those who pass with a score of 80 or higher will receive a certificate of completion.

Material resources used: Article: This article addresses issues concerning health and safety.

I hereby certify that the above information is true and accurate to the best of my knowledge and that I have complied with the AIA Continuing Education Guidelines for the reported period.

Signature \_\_\_\_\_ Date \_\_\_\_\_

## Symetrics Architecture Modules Options



the SPIRIT of WATER

With Symetrics the room as a whole is the focal point, not the individual components. All Symetrics fittings and accessories are placed within a structured grid that confines the room. This facilitates the planning process and helps avoid random product placement. With modules and components for a multitude of applications in the bathroom. The Symetrics program was created by Sieger Design. Please order your copy of the Symetrics brochure from: Dornbracht Americas Inc., 1700 Executive Drive South, Suite 600, Duluth GA 30096, Phone 866-818-3199, E-Mail [literature@dornbracht.com](mailto:literature@dornbracht.com), [www.dornbracht.com](http://www.dornbracht.com)

Miami: DESIGNER'S PLUMBING + HARDWARE, Phone (305) 442-2550. WOOL PLUMBING SUPPLY, Phone (561) 863-7788.  
New York: AF New York, Phone (212) 243-5400, KRAFT HARDWARE, Phone (212) 838-2214. Santa Monica: SNYDER DIAMOND, Phone (800) 655-7634.  
Vancouver: CANTU BATHROOMS + HARDWARE, Phone (604) 688-1252.

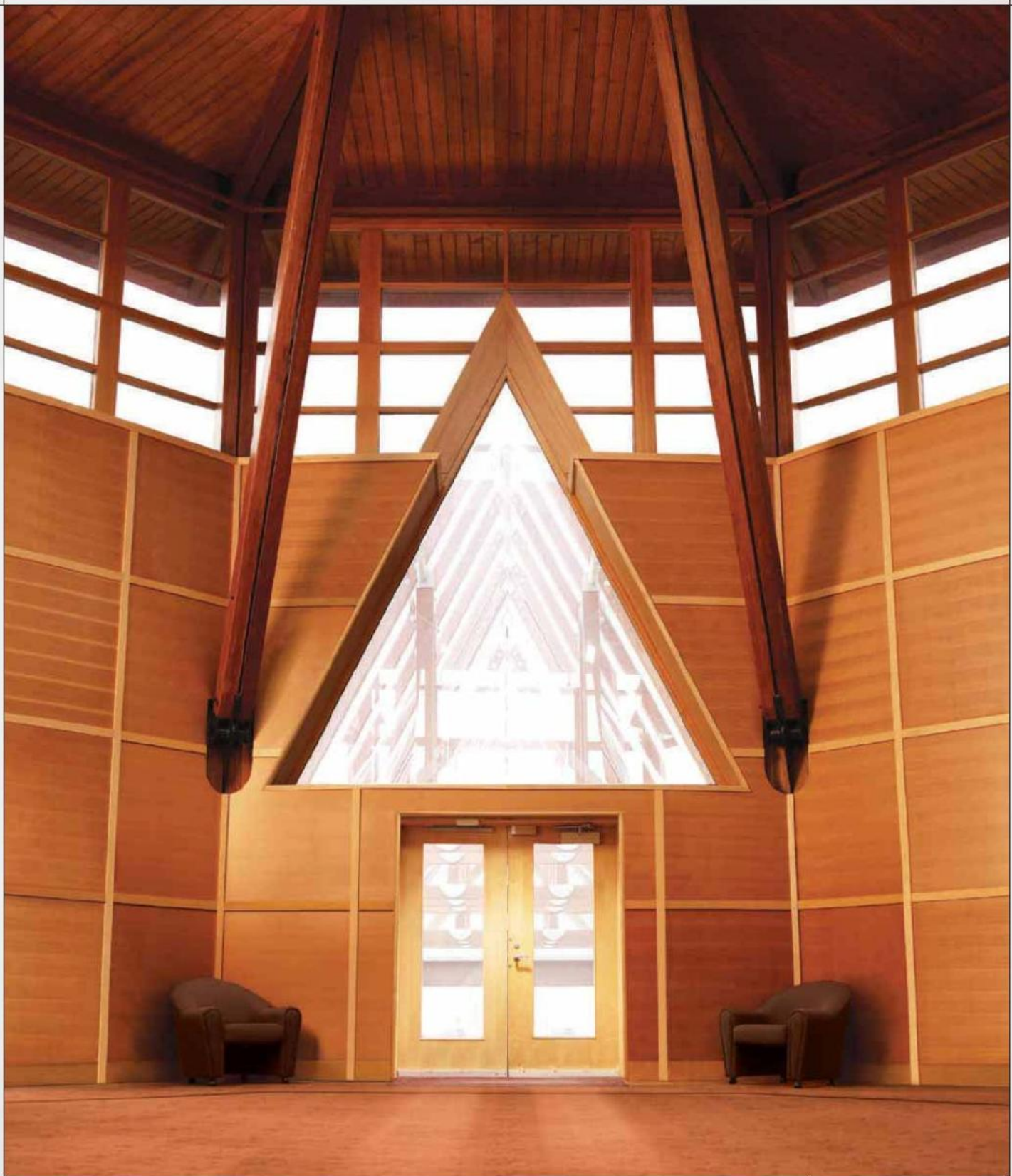

**We think about the forests behind our wood products so you don't have to.**

The demand for diverse products from sustainably managed forests is met each and every day by the capability and technology of British Columbia's forest sector. We pride ourselves on regenerating harvested areas, a commitment to legal logging and the enforcement of tough regulations, welcoming outside scrutiny of our practices, participating in recovery and recycling, and promoting carbon neutrality across the value chain. Our dedication lies in the promise that today's quality wood products won't come at the expense of tomorrow's forests.



[naturallywood.com](http://naturallywood.com)

# ENVIRONMENTAL SPECIES of NORTH AMERICA



fig. I.  
AQUA-ROC  
[running bond pattern]



fig. II.  
DRAINSTONE  
[herringbone pattern]



fig. III.  
TURFSTONE  
[stack bond pattern]

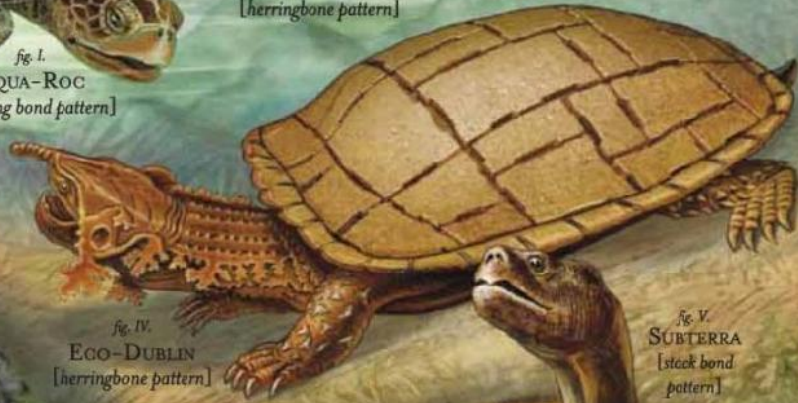

fig. IV.  
ECO-DUBLIN  
[herringbone pattern]

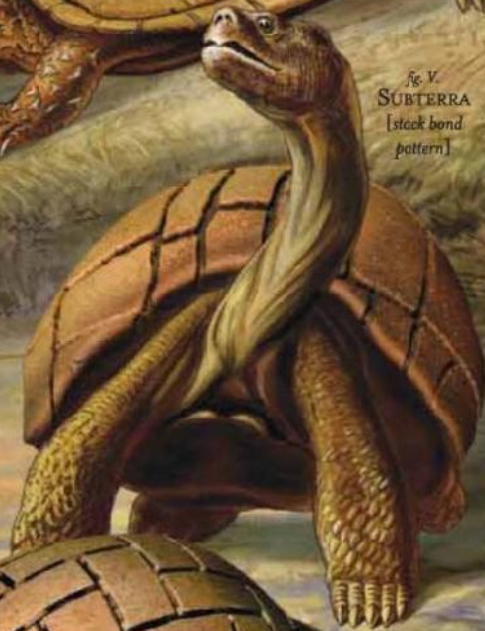

fig. V.  
SUBTERRA  
[stack bond pattern]

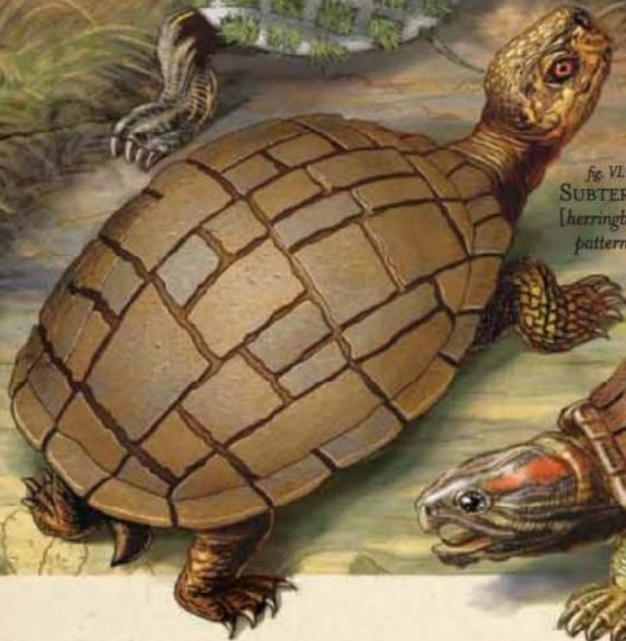

fig. VI.  
SUBTERRA  
[herringbone pattern]



fig. VII.  
AQUA-ROC  
[herringbone pattern]

Discover a new genus of paver, ideal for both residential and commercial hardscapes. Belgard's collection of environmental pavers are attractive, all-weather durable, and most important, eco-friendly. The perfectly natural way to protect one of Earth's most vital resources. Every paver allows water to permeate and directly enter the ground, thereby reducing the negative effects of runoff on local watersheds, and ultimately the lakes, rivers and seas downstream. Thoughtfully crafted to help you construct hardscapes both good-looking and green. Because it is what's beneath that truly matters.

CIRCLE 88



**BELGARD**  
— environmental —

TO LEARN MORE ABOUT NATURE'S HARDSCAPES, PLEASE CALL 1-877-BELGARD OR VISIT US AT BELGARDSPRING.COM

Ambulance stations Fire stations Cathedrals Cemeteries  
Consulates Embassies Churches Community centres Law  
courts Monasteries Retreats Mosques Parliamentary  
buildings Prisons Police stations Synagogues Temples Town  
halls Cinemas Concert halls Galleries Libraries Museums  
Performance Spaces Theatres Aquariums Exhibition centres  
Showrooms Visitor centres Zoos aviaries Community Health  
centres Doctors surgeries Dentists surgeries Hospitals  
Nursing homes Hotels Spas Theme parks Conversions  
Private houses Chateaux Castles Private housing Public  
housing Mixed complexes Nursery schools Primary schools  
Secondary schools Special needs facilities University college  
buildings Masterplans Gardens Private Gardens Public  
completed masterplans Parks Water-related buildings Wood  
forest buildings Creative re-use adaptation Public space  
Urban design Regenerated city quarters University college  
campuses Town centre revitalisation Call centres Offices  
Factories Power stations Pumping stations Recycling centres  
Refuse Sewage treatment centres Warehouse Distribution  
Agricultural Wineries Nurseries Masterplanning Landscape  
Infrastructure Competition Entries Residential Commercial  
Cultural Experimental Offices Casinos Health Bars  
Restaurants Culture Civic Retail Towers Metal Concrete  
Timber Glass Tensile Composites Synthetics Masonry



Which did you build this year?

Tell the world this November.

Enter the WAF awards - entries now open!

Visit [www.worldarchitecturefestival.com/ad1](http://www.worldarchitecturefestival.com/ad1)  
to find your global platform - quote ARECUS

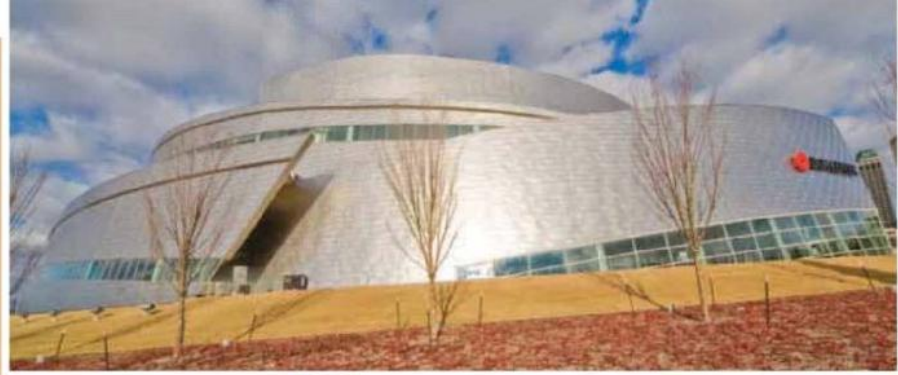

# Award Winning Acoustical Solutions For Every Environment

2008 CISCA Construction Excellence Award Winner:  
Best of Competition, Acoustical Solutions, South Region  
Project: BOK Center, Tulsa, OK  
Architect: MATRIX Architects Engineers Planners, Inc. / Pelli Clarke Pelli Architects / Odell Associates  
Application: ALPRO® Acoustical Wall System



**GORDON**  
INCORPORATED

[gordonceilings.com](http://gordonceilings.com)

800.747.8954



Inspiration.

Insight.

Visibility.

Knowledge.

# Architectural Record

Through every stage, McGraw-Hill Construction has the essential resources to bring your designs to life.

Architectural Record GreenSource Sweets Network<sup>®</sup> **PRODUCTNEWS**

Dodge ENR Regional Publications

[www.construction.com](http://www.construction.com)

'Best in Class' Editorial



Award-Winning Website



Engaging Social Media



Interactive Continuing Education

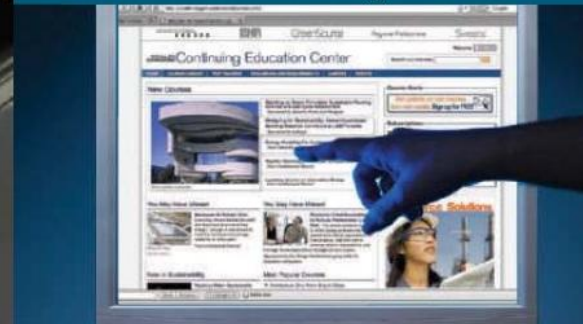

# The risks of not choosing AAA Arbitration in the new AIA and ConsensusDOCS contracts.

By now, you probably know that The American Institute of Architects and other national construction organizations are making changes to their standard-form contract documents. What you may not know is that these changes can have a significant impact on your clients' construction projects and businesses.

So what's changed? Now, you and your clients have choices when it comes to construction-dispute resolution. What hasn't changed is that the best choice after AAA mediation is still AAA arbitration.

Choice is good. But, by not choosing AAA arbitration, you could get litigation by default, or worse, another ADR provider—and both could put your clients' projects and businesses at risk.

- Risk #1** You could end up in litigation, where the average case gets bogged down for 2 years before even getting to *trial*, never mind resolution.
- Risk #2** Without AAA arbitration, your client's construction case won't be resolved in the AAA's median time frame of 10 months from filing to award.
- Risk #3** If you end up in litigation, or choose another ADR provider, you could get a judge or neutral who knows little—or nothing—about construction issues.
- Risk #4** With litigation or another ADR provider, you probably won't get the expertise of an AAA arbitrator who is also an architect, engineer or builder.
- Risk #5** You could pay through the nose for hidden administrative fees when you choose non-administered or non-AAA arbitration.
- Risk #6** You won't have access to AAA tools and resources that help you to customize all-important dispute resolution contract clauses.
- Risk #7** You run the risk of not getting an ADR provider that will offer you support, every step of the way, whether you file online or conventionally.

*If you do choose AAA Arbitration, disregard all of the above.*

1-800-311-3799 or [www.adr.org/check\\_the\\_box](http://www.adr.org/check_the_box)



American Arbitration Association

*Dispute Resolution Services Worldwide*



# Lighting

## OFFICE ENVIRONMENTS

- 214 Ofita, Madrid**  
*King & Miranda Design*
- 219 Cofra Group, New York City**  
*Perkins+Will*
- 223 Dallas Center for Architecture**  
*Peter Doncaster, Booziotis & Co.; Nicholas Marshall, nodesign; Gabriel Smith, Thomas Phifer & Partners*
- 226 Lighting products**

*Green and democratic by design, today's most successful office interiors comprise comfortable, open workstations filled with daylight – often borrowed from glass-enclosed perimeter cubicles. Electric illumination balances targeted functions, aesthetic effects, and energy efficiency. Architects are rising to the challenge of this new direction with creative solutions for a range of businesses, as illustrated by our featured projects: a corporate sales hub and showroom, the satellite base of an international venture capital company, and a center for architecture. Linda C. Lentz*



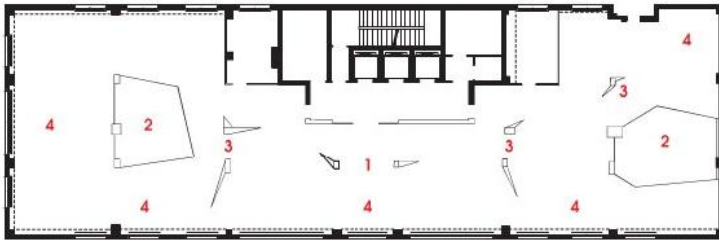

FLOOR PLAN / SHOWROOM



- 1. Reception
- 2. Conference rooms
- 3. Column/partition
- 4. Display area

Brass shavings on the ceiling of the glass-enclosed meeting room catch the glow of the pendants below (opposite). The columns are encased in back-painted glass partitions (right). Window screens filter the Madrid sun, while low-voltage halogen lighting illuminates the showroom displays (below).



## King & Miranda delivers layers of light and space to Ofita's Madrid outpost

By David Cohn

**W**hen asked to sharpen the corporate image of the Spanish furniture manufacturer Ofita for visiting designers, architects, and specifiers, the Milan-based design and architecture firm King & Miranda transformed the company's Madrid offices and showroom—located on two adjacent floors—into an integrated sales tool using a spare vocabulary of textural elements, colors, and lighting strategies.

To accomplish this, the design team—partners Perry King and Santiago Miranda, and project architect Caroline King—situated the principal meeting rooms on the showroom floor to increase traffic, and organized the work spaces on the floor above into a showplace for the client's contract furniture lines. "People who before only came to the offices, now also have their meetings in the showroom," Miranda explains. "It's become a much more useful instrument."

Minimalism and sustainability informed the design throughout. Existing walls and dropped ceilings were eliminated to maximize the sense of openness on each of the narrow, 6,500-square-foot floors. Structural columns, which march in two dense rows through the now open floors, are encased in vectorlike flanges. These dividers—made of gypsum board in the office space and luminous back-painted glass in the showroom—extend to organize circulation and establish zoned display and work areas. Dark gray carpeting and exposed ceilings painted a deep blue unite both floors and create a continuous neutral environment in which Ofita's products and activities take center stage.

*David Cohn is RECORD's Madrid-based international correspondent and the author of Young Spanish Architects, published by Birkhauser.*



PHOTOGRAPHY: © RAFAEL VARGAS



King & Miranda's T5 fixtures direct and diffuse light above the company's white office systems (above).

One of two whimsical meeting pods gets light from ceiling light openings and MR16 spots (top right).

1. Reception
2. Staff meeting pods
3. Column/partitions
4. Workstation

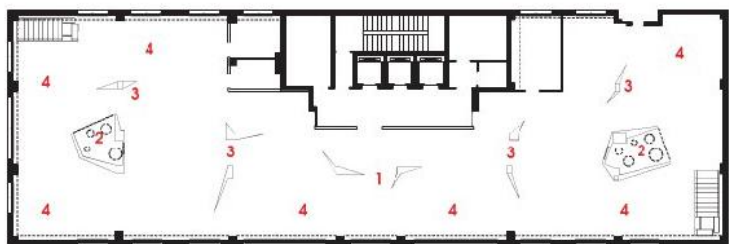

FLOOR PLAN / OFFICE



Madrid's powerful sunlight is tempered with permanently drawn screens on the windows, offering shadowy urban images through pinpoint perforations. However, while the two floors are similar in many ways, the designers employed distinct lighting solutions on each to create a dialogue of contrasts—both aesthetic and pragmatic.

The offices are illuminated with indirect light from an overhead fixture notable for its ability to prevent reflections, highlight depth and perspective, and define territorial boundaries. Named Smooth Light, the fixture is a King & Miranda design for the Italian manufacturer Luxit. Looking much like a lightweight glider, it has been meticulously distributed throughout the space, suspended below floating white panels (made of recycled wood chips) that diffuse light and absorb sound. A central fin, separating two T5 fluorescent tubes, aids in directing and further diffusing the light. According to Perry King, "Our idea was a [fixture], very light in appearance, with a presence that helps give a sense of location and perspective." Task lights, he says are unnecessary with a fixture like this. On a more whimsical note, two cubelike "pods" for informal employee meetings are located on the extreme ends of the floor. Recessed halogen spots on their ceilings add sparkle, highlighting the bright orange walls and Konstantin Grcic's playful Miura stools inside.



For the showroom, the designers selected their Star Strips fixture (also by Luxit) for the dramatic, directional glow its low-voltage halogen lamps give to the displays. Developed for the furniture galleries at the Castle Museum in Milan, this theatrical-like fixture, with its shallow, wide reflectors, was designed for maximum output and a wide beam, which keeps the light and heat from being too concentrated. "In the ducal chambers, the ceilings are something like 25 feet high, and the furniture was absolutely lost," King recalls. "The pieces were very precious, and we couldn't burn them with a lot of light, but we had to give them drama. And that's exactly what we wanted here—to illuminate the products well, give them drama, and give the client a flexible tool to work with."

As a focal point, two of the designers' decorative incandescent pendants for Estiluz serve to soften and accent the showroom's principal destinations: the stainless-steel Quepi Due at the reception desk and the stamped glass E-llum in the glass-walled meeting rooms at each end of the floor. In one of their most memorable innovations for the project, the design team used woolly curls of brass—intended for scrubbing kitchen pots—as an acoustical treatment for the ceilings of the meeting rooms in the showroom. "It cost very little but looks expensive," says Miranda. Additionally, notes Perry King, "the brass is a waste material, so it's ecologically sound." The material also transforms the ceilings into a luminous field of burnished gold. This final detail offers a good summary of the King & Miranda strategy as a whole: using modest means to create a cohesive, memorable space that puts the client's products in an entirely new light. ■

**Project:** Ofita, Madrid

**Architect:** King & Miranda Design—  
Caroline King, project architect

**Interior and lighting design:**

King & Miranda Design—  
Perry King, Santiago Miranda,  
design principals

**General contractor:** Ofita

**Ceiling realization:**  
Iniciativas y Exposiciones

#### SOURCES

**Lighting:** Luxit (ceiling fixtures);  
Estiluz (decorative stainless steel and  
glass pendants)

**Ceiling:** Heraklith (panels);  
Lunik Star (brass shavings)

**Furniture:** Ofita

**Carpets:** Interface FLOR

**Paint:** Sigma Coatings

**Hardware:** Olivari (door handles)

green office lighting

doesn't have to be

green

# TAMBIENT<sup>®</sup>

Furniture mounted task **AND** ambient lighting from a single T5 lamp.

0.6

watts per square foot.



© elliptipar/Tambient 2002

CIRCLE 92

  
**elliptipar**  
... there is no equal<sup>™</sup>

[www.elliptipar.com](http://www.elliptipar.com)

**TAMBIENT<sup>®</sup>**  
green in any color<sup>™</sup>

[www.Tambient.com](http://www.Tambient.com)

TURN LIGHTING ON ITS HEAD!

# THINK

INSTALLATIONS

# LED BULBS



> S14 DecorLED™ Lamps  
Palace Theatre, Albany, NY



> Round, Flexible RopeLED  
Tortilla Jo's, Anaheim, CA



> Custom-Built LED Lamps  
Vincent Thomas Bridge, San Pedro, CA



> S14-Styled DecorLED Lamps  
Bardavon Theater, Poughkeepsie, NY



> 4-LED, 9mm Miniature Wedge-Based  
Lamps Hillsboro Arch, Hillsboro, OR



> 7-LED, S6 Candelabra-Based Lamps  
Hyatt Regency, Long Beach, CA

**RELAMP WITH BRIGHT, LONG-LASTING ENERGY EFFICIENT DIRECT INCANDESCENT REPLACEMENT LED BULBS AND LAMPS FROM LEDTRONICS.**

**FEATURES**

- > NO HEAT - COOL TO THE TOUCH
- > USE 70% TO 90% LESS POWER
- > LEDS LAST UP TO 11 YEARS
- > SHOCK/VIBRATION RESISTANT
- > 12 VOLTS DC TO 240 VOLTS AC
- > IDEAL FOR SOLAR POWER
- > LED COLORS: WHITE, GREEN, BLUE, RED, YELLOW, AMBER AND TINTED/FROSTED LENSES



# LED®

**LEDTRONICS, INC.®**  
THE FUTURE OF LIGHT®

23105 Kashiwa Court, Torrance, CA 90505  
Phone: 310.534.1505 | Fax: 310.534.1424  
Email: webmaster@LEDtronics.com

1.800.579.4875

www.LEDtronics.com



Daylight penetrates a maple partition into the reception area and into the tiled elevator lobby through a glass partition.

## Perkins + Will devises an enlightened scheme for the Cofra Group/Good Energies New York City base

By Linda C. Lentz

Located on the 29th floor of a 1960s Park Avenue office tower, the New York City home of the Cofra Group and its Good Energies venture capital company—an investor in such renewable energy enterprises as Sage Electrochromics—is proof that this Switzerland-based corporation takes its business to heart.

The project, which has LEED-CI (Commercial Interiors) Gold certification, was spearheaded by architect Pat Sapinsley, AIA, a Good Energies senior associate with her finger on the pulse of energy-efficient and sustainable practices. Hoping to demonstrate the values suggested by the firm's motto, "People, Planet, Profit," Sapinsley worked with Perkins+Will director of interiors Joan Blumenfeld, FAIA, and project designer Steven South. The architects gutted the 22,500-square-foot space with the intent of using daylight as the primary means of illumination. Consistent with the green directive, they saved 75 percent of the construction debris for recycling, and replaced as many of the traditional building materials as possible with earth- and people-friendly alternatives: FSC-certified wood; linoleum; recycled polyester fabric panels; denim insulation; carpeting with low-VOC adhesive; low-flow toilets and faucets; and Energy Star-compliant electrical and mechani-

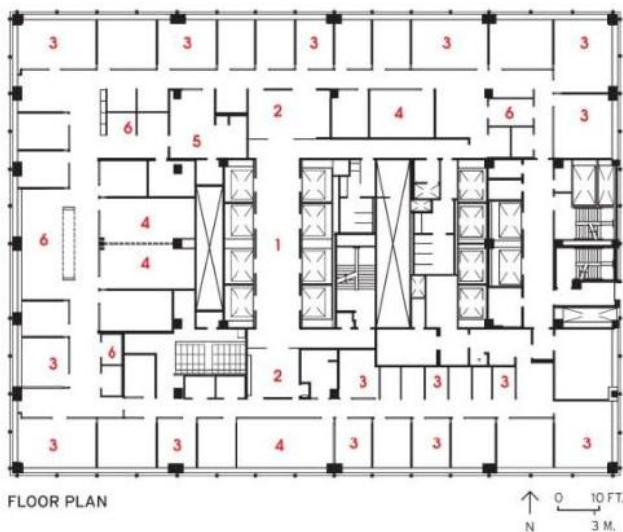

- 1. Elevator lobby
- 2. Reception area
- 3. Office
- 4. Conference room
- 5. Employee pantry
- 6. Workstations



Conference rooms feature ambient fluorescent pendants and halogen MR16s for dimming (left). Daylight fills the hall from all corners (below). Halogen fixtures add warmth to the pantry (bottom).



cal equipment, office gear, and kitchen appliances. Daylighting is the primary player in the daily reduction of energy consumption—which, at .76 watts per square foot, is 24 percent better than code.

Newly defined perimeter offices and conference rooms are enclosed with transparent and translucent glass, so that light penetrates through to the floor plate. Similarly, walls across the hall filter this light to inner cubicles and meeting areas. Bordering the reception areas on opposite sides of the building, louverlike partitions direct sunlight into the elevator lobby. Additionally, to maximize illumination and minimize the use of electric light, South specified light-hued reflective surface materials, including white furnishing systems, natural maple, textural limestone mosaics, and glare-free frosted resin.

As for devising the appropriate balance of shading, electric light, and controls, the architects tapped Horton Lees Brogden Lighting Design (HLB). A series of sensors in the perimeter offices monitor several factors: daylight, foot-candles reflected by the surfaces, and occupancy. The sensors activate mechanisms for raising and lowering the motorized, semisheer shades, as well as for operating and dimming the ambient overhead and indirect wall fixtures (both fluorescent) depending on the sun's brightness and glare or whether the room is occupied. Yet, according to HLB project manager Shoshanna Segal, "The [client] also wanted to have as much control as possible for individual occupants. So everybody was afforded override control over both the shades and the light." A stylish LED task lamp on each desk operates manually. Nevertheless, Segal notes, for the most part the electric lights are off in at least 85 percent of these offices. "They just don't use their lights, which is exactly what we wanted."

The remainder of the scheme has less to do with overt environmentalism than with good design, says Segal. Thus, the hall is lit by slender, 2-foot, 14-watt lamps spaced 10 feet on center—keeping the area slightly darker to define it as a separate space. Large circular T5 fixtures have concave diffusers that cast a pleasant glow over the workstations and into the upper areas of the walls. Halogen, metal-halide, and LED sources combine with fluorescent tubes in the lobby/reception areas, conference rooms, and pantry for flexibility, ambience, and human comfort.



Ultimately, Segal believes that sustainable lighting design is not only about what light bulb you use. "It's about using all the tools available to you in a way that functions for users and provides a visually comfortable environment for them to work and live in." When done well, she claims, it's a compromise. "We save in places where it's possible to save, so that we can spend in places where we need to." ■

**Project:** Cofra Group/Good Energies, New York City

**Architect:** Perkins+Will Joan Blumenfeld, FAIA, design principal; Steven South, project designer; Lulua Khambaty, strategic planning and sustainability

**Consultants:** Horton Lees Brogden (lighting); Design 360 (graphics); TM Technology (AV/IT)

#### SOURCES

**Lighting:** Peerless Lighting; Ledalite; Mark Architectural Lighting; Flos; Alcco Lighting; Litemakers; Lucifer Lighting; Optolum; Kurt Versen  
**Shades and controls:** Lutron  
**Glass:** Joel Berman; Vivid Products  
**Stone:** Architectural Systems  
**Ceiling:** Architectural Components Group (wood); Armstrong (acoustics)



Prudential Ltg.

# Beyond<sup>AND</sup> Back

*{classics \_ circles, squares}*

Can a fixture be both futuristic, and classic? It can if it's among the selection of Squares and Rounds offered by Prudential Ltg. For more than 25 years, our Sky Oculus P-3900 Round has fueled the imagination of architects and designers. That purity of shape is echoed in our P-3600 Square. So whether you require surface- or pendant-mount, large scale or small, let us take you beyond the expected, with shapes that go back to basics. See [prulite.com](http://prulite.com) for more ways we can help you create a timeless design solution.

**CIRCLE 94**



Light creates Life. Create with Prudential Ltg.



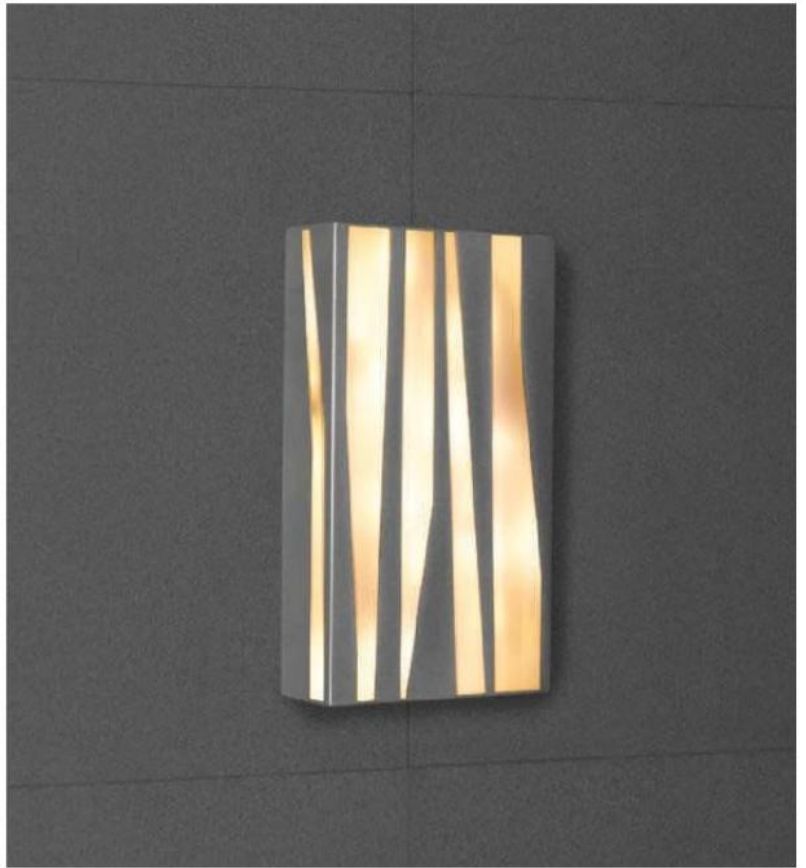

# Silvus Family

Interior/exterior lighting fixtures designed by Roger Duffy of SOM

The modularity of these luminous elements allows for a wide range of applications—single unit, column or field. Its LEDs and carved inner surface evoke the gentle motion of light across water, filtered by foliage.

Shown: **Silvus30** (30"x7.5"x6.5") and **Silvus24** (24"x13"x6.5")

Various options available for LEDs and finishes



IVALO  
LIGHTING

Ivalo Lighting Inc.

[www.ivaloighting.com](http://www.ivaloighting.com)  
tel 610.282.7472

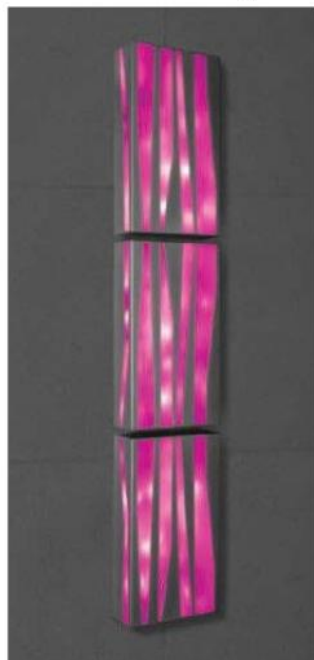
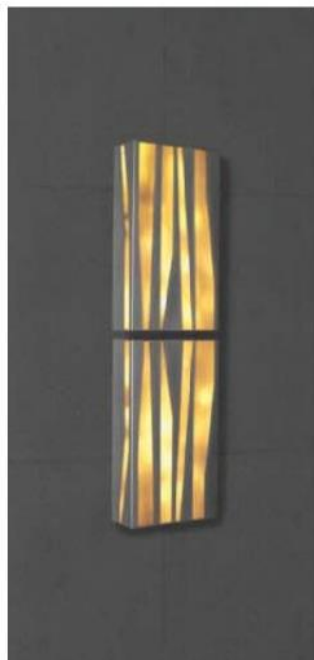
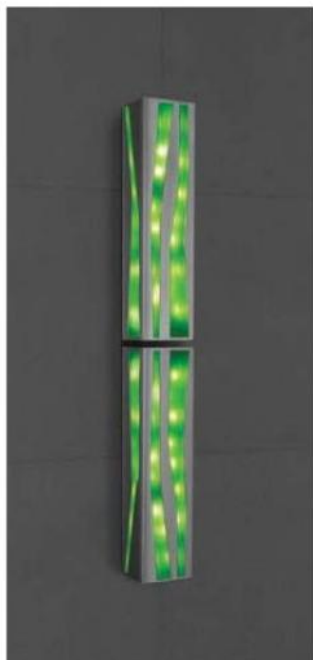



## A winning competition entry provides a highly visible buzz for the new **Dallas Center for Architecture**

By **Stephen Sharpe**

**H**ow do you grab the attention of motorists hurtling along on their evening commute in an auto-centric city like Dallas? How about creating an enigmatic sequence of intense colored light reflecting out toward the expressway from behind the window wall of an adjacent office building? This is the concept behind the new Dallas Center for Architecture (DCfA). A more difficult question to answer is: How to pull it off?

When their collaborative scheme was selected in a competition for the DCfA offices in February 2008, Peter Doncaster, AIA, of Booziotis & Co. in Dallas; Nicholas Marshall, AIA, of nodesign in New Orleans;

*Stephen Sharpe is the editor of Texas Architect.*

and Gabriel Smith, AIA, of Thomas Phifer & Partners in New York, wondered just that. “Our concept was that there was an object inside,” says Doncaster. “And we knew we wanted it to light up—but that was it.”

The 7,400-square-foot project for the DCfA, an alliance formed by AIA Dallas and a handful of allied organizations, encompasses the ground floor of an unremarkable 1980s low-rise building. In addition to spaces for staff and support services, some areas must accommodate the public for exhibitions, lectures, and gatherings. While the location might lack in aesthetic distinction, it fulfilled AIA Dallas’s desire to expand the chapter’s public outreach by providing an expansive window wall that looks out on the neighboring Dallas Arts District. That adjacency is now partially obstructed by Woodall Rogers Freeway, a below-grade thor-



PHOTOGRAPHY: © CRAIG BLACKMON, FAIA

1. Entrance
2. Glass light wall
3. Boardroom
4. Gallery
5. Open office

Transparent glass doors bring daylight into the DCfA boardroom, while an acid-etched-glass light wall wraps two meeting areas (above). The colorful, LED-lit wall is visible from the street (left).

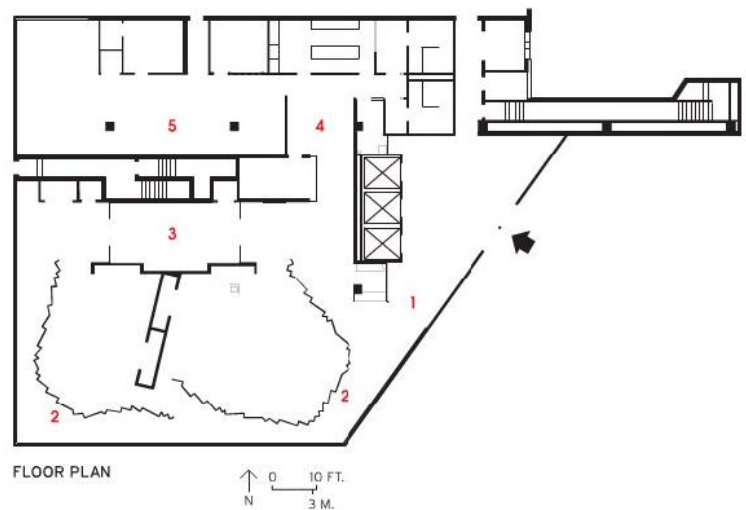



oughfare that skirts the northern perimeter of downtown. But plans are currently being developed for decking over the freeway to create a three-block-long urban park. This will encourage pedestrians to walk from the Arts District to the DCfA offices for public events.

The first step was to specify a light source, so the design team turned to Suzanne Branch of LUM Architectural Lighting Design Consulting in Dallas. Although the architects had T8 fluorescents in mind, Branch steered them toward color-changing LEDs, and then collaborated with Doncaster on mock-ups of materials for the luminous wall. They picked a translucent, acid-etched glass to wrap two meeting rooms. Eleven-foot-tall segments of the glass are installed in narrow-width facets to compose what the architects call the “crinkle wall.” Initially the team considered two parallel walls of glass, with LEDs installed between them, but that proved too costly. Instead, they sandwiched 40 custom-fabricated fixtures,



**Color-emitting LED modules wash the transparent wall from the top and reflect to the outdoors (above left and below). The gallery is lit by metal-halide lamps on a track system (above).**

be pulled back to maximize daylight, and closed in the evening when the intensity of the LEDs would make use of the room impractical.

Branch also specified the lighting for other areas in the office suite. “We were working to achieve LEED certification, so energy was a big issue. We did a number of things to help with that,” she notes, including the installation of automatic dimmers that adjust interior light levels according to the amount of available daylight. In the gallery space open to the public for periodic exhibitions, she used 20-watt ceramic metal-halide lamps on a track system.

All the consultants, including Branch, provided pro bono services. The three architects split \$5,000 for their first-place competition entry. And while the project was not built precisely as submitted, Gensler principal Ted Kollaja, AIA, who served as the owner’s representative, is pleased with the final result. “The ultimate success” he notes, “has been proven by the unsolicited demand for participation by the allied organizations and other groups to use the space for meetings and special events.” ■

**Project:** Dallas Center for Architecture, Texas

**Architects:** Peter Doncaster, AIA, Booziotis & Co.; Nicholas Marshall, AIA, nodesign; Gabriel Smith, AIA, Thomas Phifer & Partners

**Architect of record:** Booziotis & Co. Architects—Peter Doncaster, AIA, Aaron Farmer, AIA, Donald Roberts, AIA

**Project management:** Gensler—Ted Kollaja, AIA

**Lighting design:** Lum Architectural Lighting Design—Suzanne Branch, AIA

#### SOURCES

**Lighting:** Architectural Lighting Associates (supplier); Color Kinetics; Finelite; Zumtobel; LightControl; Edison Price; Lutron (controls)

**Glass:** Walker Textures (acid-etched glass) from Mammen Glass; Pilkington Profilit (channel glass)

**Flooring:** Enviroglass (recycled glass terrazzo)

**Ceiling:** Armstrong

# LIGHTING ENTIRE DOWNTOWN WATERFRONTS WITH LED



HARBORSIDE  
Bremerton, Washington



FAIRWEATHER*sf*.com

1-800-323-1798

FAIRWEATHER SITE FURNISHINGS, a Leader International company, 1540 Leader International Drive, Port Orchard, WA 98367-6437, 360-895-2626  
CIRCLE 96

# Lighting Products

▼ **Flexible illumination** The Flip Double Sconce, designed by Clodagh Signature, features a bronze housing with two frosted-glass shades (each measuring 4" x 4" x 5/4") that can be flipped up or down as needed. Depending on the position, the lamp ranges in height from 9" to 13" and in width from 13½" to 22". The sconces require two 60-watt lamps. Single-shade versions are also available. [www.clodagh.com](http://www.clodagh.com) **CIRCLE 200**



▲ **Neo-Grec style fixtures** Rejuvenation's new line of 1870s, gas-style fixtures are ideal for Victorian homes and historic commercial and government buildings. Featuring three chandeliers and one wall fixture, the NeoGrec line includes more than 20 custom parts, five of which are hand-cast in aluminum. Discreet compact fluorescent technology allows them to meet strict energy-efficiency standards without compromising historical accuracy. Rejuvenation, Portland, Ore. [www.rejuvenation.com](http://www.rejuvenation.com) **CIRCLE 203**



◀ **Modern lantern** A modern interpretation of a lantern, the Belvedere Series is the first indoor/outdoor collection from Barbara Barry for Boyd. Made of solid brass and glass, the series is UL-listed for wet locations and is available in two sizes of pendants and sconces, each with four finish options and two choices of ribbed glass. Incandescent (four T10 60-watt lamps) or fluorescent lighting is available. Shown here in blackened brass. Boyd Lighting, San Francisco. [www.boydlighting.com](http://www.boydlighting.com) **CIRCLE 201**



▲ **Limitless lighting design** The Leuven, Belgium-based company Materialise.MGX works with designers such as Arik Levy and Patrick Jouin to create surreal lamp designs through the use of 3D and animation software and rapid prototyping technologies, such as stereolithography. The OMI.MGX pendant (shown), designed by Assa Ashuach, is made of a white nylon shade and mounting cup created with selective laser-sintering technology. D Apostrophe, New York City. [www.dapostrophe.net](http://www.dapostrophe.net) **CIRCLE 202**



▲ **Archival reproductions** San Francisco-based lighting designer Jonathan Browning has partnered with the Viennese lighting firm J.T. Kalmar to adapt, produce, and market designs from the firm's early-20th-century archives. The initial collection will include 11 sconces, chandeliers, torchères, and pendants in rosewood, bronze, crystal, and other materials, and will be available at Holly Hunt, David Sutherland, and other showrooms. Jonathan Browning Studios, San Francisco. [www.jonathanbrowninginc.com](http://www.jonathanbrowninginc.com) **CIRCLE 204**

For more information, circle item numbers on Reader Service Card or go to [architecturalrecord.com/products](http://architecturalrecord.com/products).

# BOYD

E X T E R I O R

CIRCOLO EXTERIOR BOLLARD BY DOYLE CROSBY

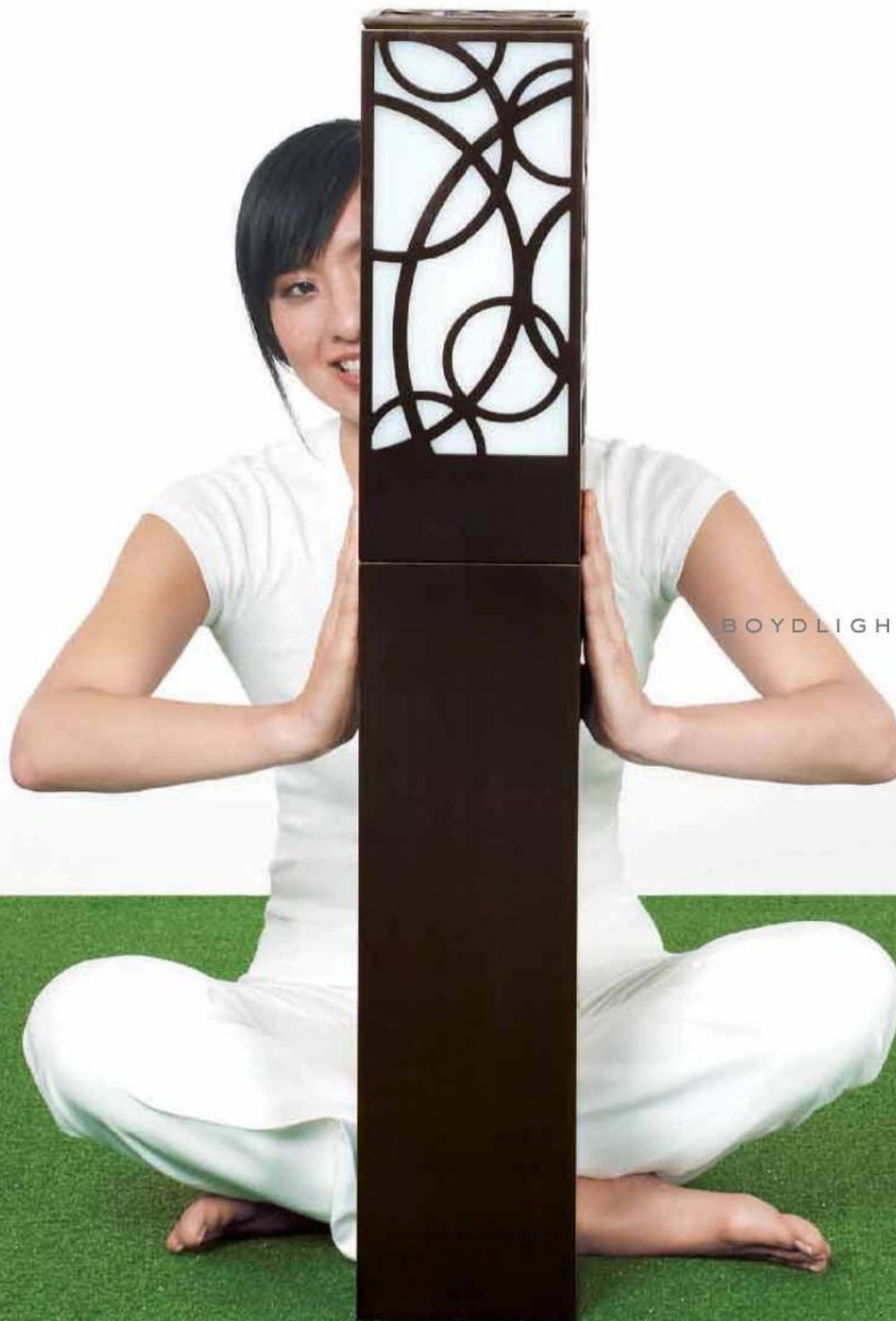

BOYDLIGHTING.COM



# “Architects In Action”

FOR BEST REPUTATION...  
JOIN THE AMERICAN INSTITUTE OF ARCHITECTS.

*Being a member of the AIA tells your clients that you belong to an association whose members uphold the highest standards of quality, ethics, and professional responsibility. As the voice of the architectural profession, the AIA works to build public awareness of the value of good design and the expertise of its architect members.*

*When you join the AIA, you immediately become part of a collective voice of more than 83,000 design professionals, working to influence policy making and enhance the importance of architecture in your community.*

WE ASKED A SIMPLE QUESTION, “WHY ARE YOU A MEMBER?”  
THERE ARE 83,000 POSSIBLE ANSWERS. HERE ARE TWO.



“I think that the day I was elevated from Associate member to Architect member was the equivalent in any other profession of when you have ‘made the grade.’ Although technically it was the state exam that got me to that level, the ability to put ‘AIA’ behind my name really did mean a lot. And I don’t think I’m alone in that respect.”

*Virgil Green, AIA — Member Since 1978*



“When I’m meeting a potential client, they want to know that I’m qualified. One of the things that gives them confidence is when they see my business card. At the end of my name, it says ‘AIA.’ And ‘AIA’ means to them, not only am I a registered professional, but I’m a highly qualified registered professional. And that I am interested in developing my skills and talents continuously.”

*Louis B. Smith, Jr., AIA — Member Since 1985*

Become the next Architect in Action. Become a member of the AIA.

[www.aia.org/join\\_today](http://www.aia.org/join_today)  
800-242-3837



THE AMERICAN INSTITUTE  
OF ARCHITECTS

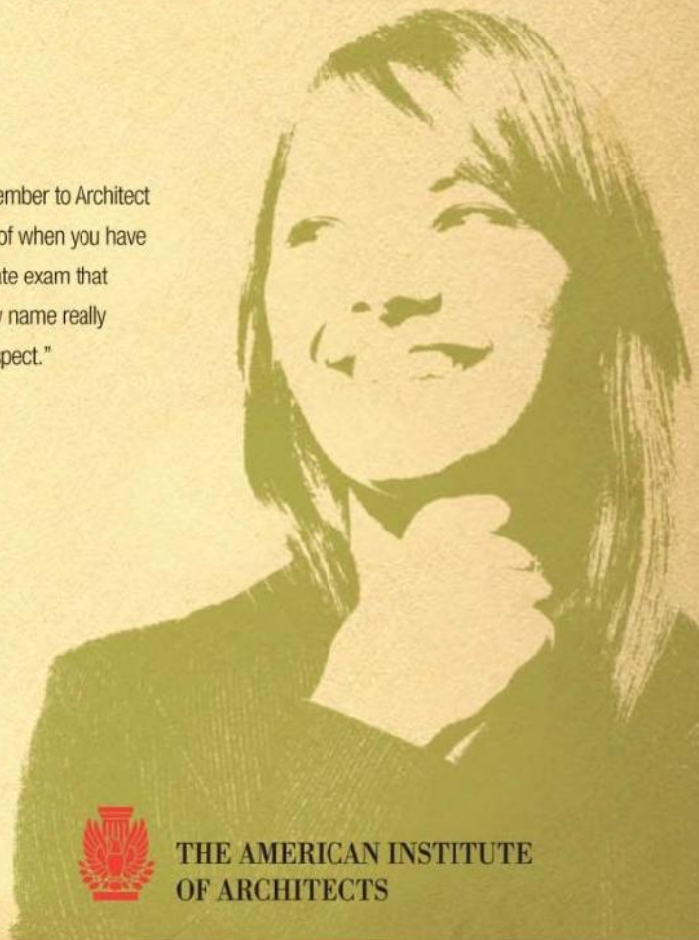

The  
Essentials  
Of  
Designing  
Green

Get Smarter with SmartMarket Reports



Be Inspired By GreenSource



Find Green Products at Sweets



Interact at greensourcemag.com



**McGraw-Hill Construction**

Through every stage, McGraw-Hill Construction has the essential resources to bring your designs to life.

Architectural Record   GreenSource   Sweets Network  
SNAP   Dodge   ENR   Regional Publications

www.construction.com

SGBBMHCG1008



**prism**  
SureColor Grout



- No color shading
- No efflorescence
- Stain resistant



**CustomLite** Lightweight - High Performance TECHNOLOGY

- One grout for joints 1/16" - 1/2"
- Made with recycled materials—contributing to LEED® certification
- Eligible for a Lifetime Systems Warranty



800-272-8786 • www.custombuildingproducts.com

CIRCLE 98

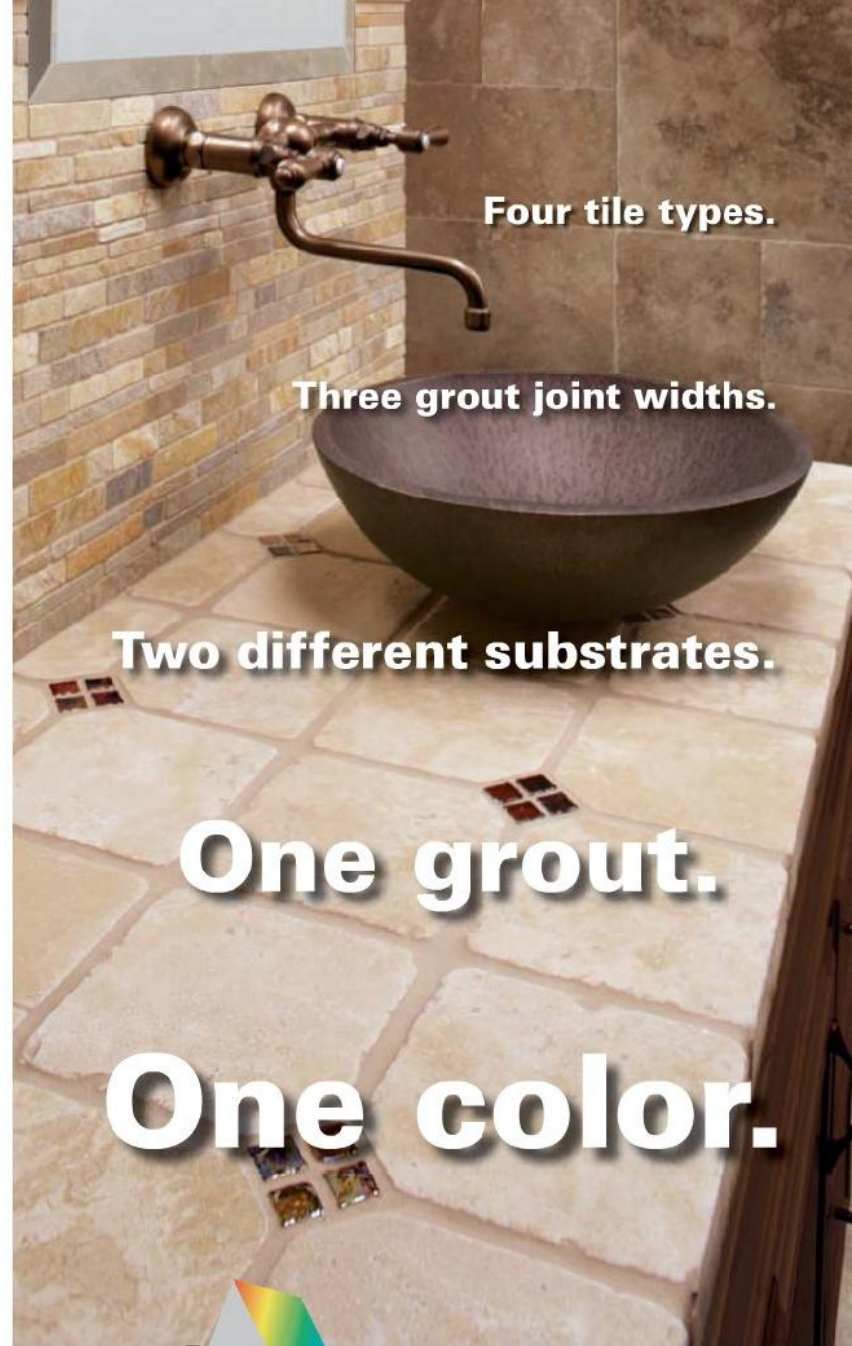

Four tile types.

Three grout joint widths.

Two different substrates.

One grout.

One color.



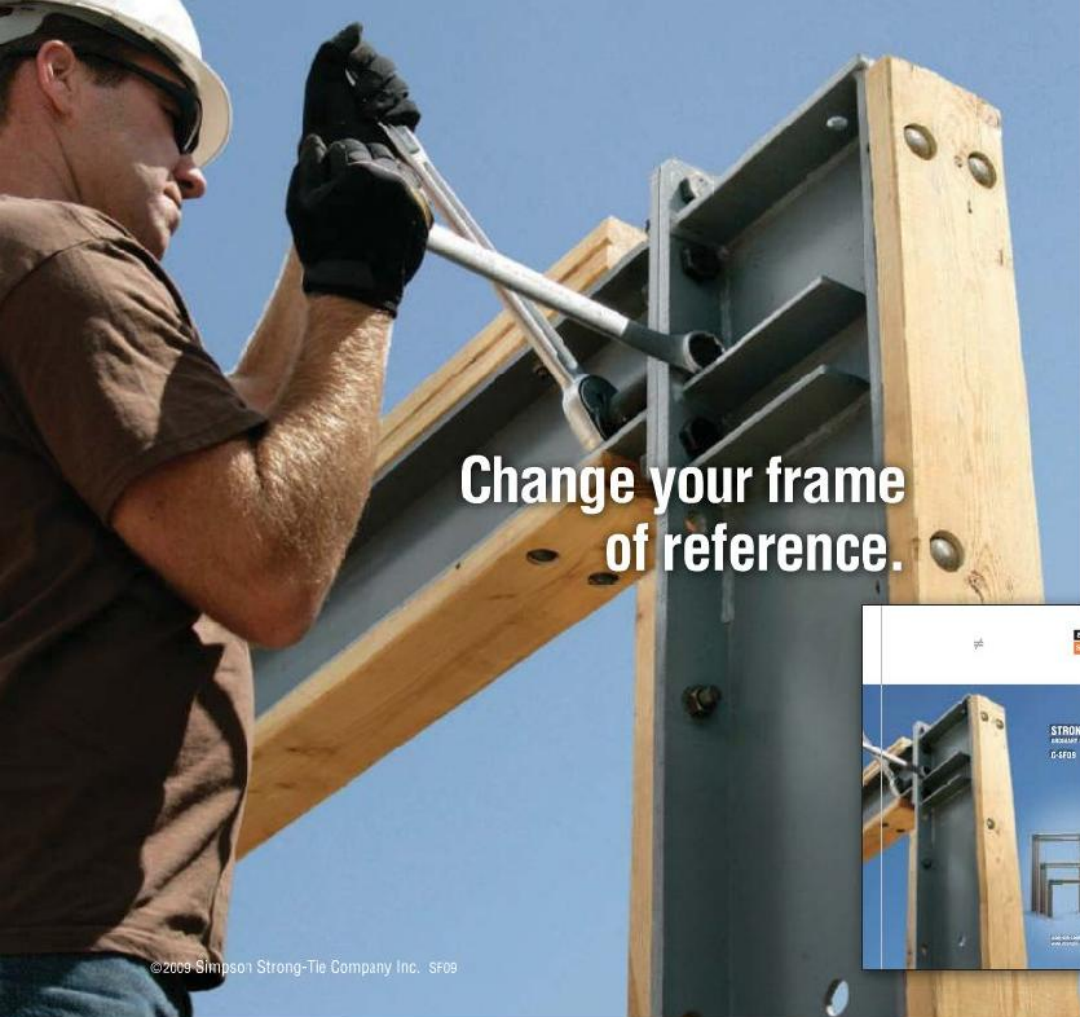

**Change your frame  
of reference.**



In the past moment frames were the expensive option when designers wanted small wall sections and open floor plans. The Simpson Strong-Tie® Strong Frame™ ordinary moment frame is changing that by offering engineered moment frame solutions complete with anchorage designs. Now designers can spend minutes choosing a pre-engineered moment frame rather than hours designing one. And since the Strong Frame moment frame installs with 100% bolted connections, it is easier for contractors to handle and install.

For more information, see our webinar at [www.strongtie.com/stwebinar](http://www.strongtie.com/stwebinar).

To view and request a copy of the *Strong Frame Ordinary Moment Frame* catalog, visit [www.strongtie.com](http://www.strongtie.com) or call (800) 999-5099.



©2009 Simpson Strong-Tie Company Inc. SF09

CIRCLE 99

ANNOUNCING  
The Mockett Stimulus Plan

We Are Here  
to  
Help You!



DP3 Series - Drawer Pulls





We have reduced prices on almost every product.  
Please visit [mockett.com/slimulus](http://mockett.com/slimulus) to see our new pricing!

"FINE ARCHITECTURAL HARDWARE FOR YOUR FINE FURNITURE"®

Doug Mockett & Company, Inc. • Manhattan Beach, CA • 800.523.1269

**MOCKETT**  
DOUG MOCKETT & COMPANY, INC.  
[www.mockett.com](http://www.mockett.com)

CIRCLE 100



CASCADE COIL DRAPERY



Tulip Casino  
Washington, USA

**Woven Wire Fabric**

Projects include multi-story wire mesh draperies for hotels, auditoriums, and casinos; curved dividers for visual merchandising; window treatments for private homes; safety screening for industrial settings; sculptural forms for urban gardens; decorative interior/exterior wall coverings for buildings and parking garages; aviary round weave screening for animal habitats, and see-through appealing barriers for commercial security. Whatever the application, let us help you realize your creative vision.

[www.cascadecoil.com](http://www.cascadecoil.com) | 800-999-2645

CIRCLE 101

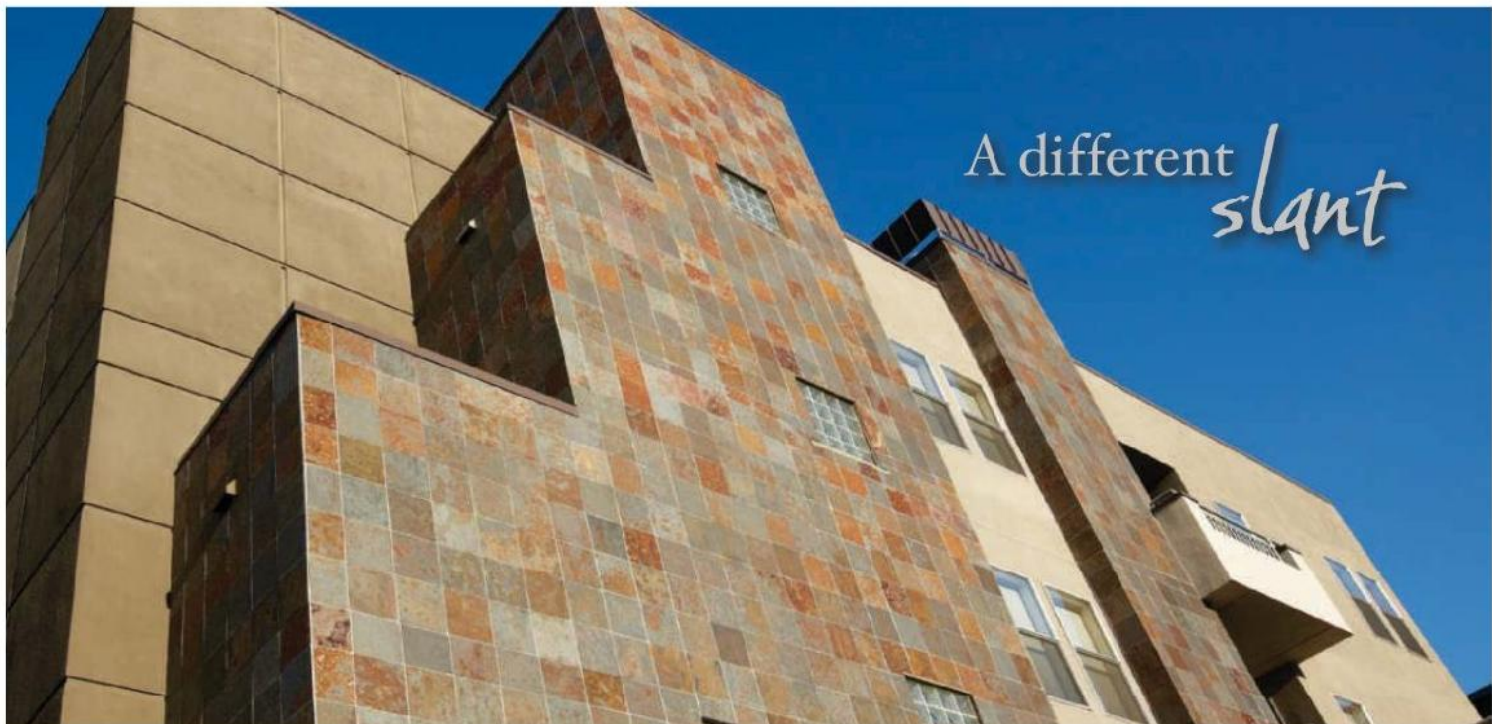

A different *slant*

Floors • Countertops • Veneers • Patios  
Landscaping • Driveways • Roofs



Adding Natural Beauty to Your World™

866.602.7033 • [www.americanslate.com/slant](http://www.americanslate.com/slant)

CIRCLE 102

When a hole in your ceiling or wall...  
*is a good thing!*



“Hole In The Ceiling”  
HITC Series Fixtures

“Hole In The Wall”  
HITW Series Fixtures



Our “HITC” & “HITW” fixtures are plaster/glass-fiber castings. When installed, they blend into the surface and appear to be a custom built drywall “light niche.” They efficiently illuminate your space without calling attention to themselves.

Call us now for more info:  
626 579-0943

Visit our website today:  
[www.elplighting.com](http://www.elplighting.com)

CIRCLE 103

# AVAILABLE NOW

## 2009 International Codes® A World of Difference



The new I-Codes are here—and the **2009 IBC®**, **IRC®**, **IECC®**, and **ICCPC®** are better than ever. These new codes are more user friendly and offer additional guidance, flexibility and options for the safe design and construction of buildings in your community.

Also New for the 2009 I-Codes:

- FREE I-Code Overview Webinars and a preview of more code changes available now on our website
- ICC's **CodesPlus** service provides FREE updates, excerpts of code references, technical articles and more—just register your code book!

Get your 2009 I-Codes and explore new ways to do your job better and more proficiently, and improve the design and safety of homes and buildings in your community.

**ORDER YOURS TODAY! 1-800-786-4452 | [www.iccsafe.org/2009icodes5](http://www.iccsafe.org/2009icodes5)**

09-01718

**Need the Code NOW?** Visit [www.ICCodes.biz](http://www.ICCodes.biz) to purchase an immediate download.

CIRCLE 104

A N N O U N C I N G

# The Mockett Stimulus Plan!

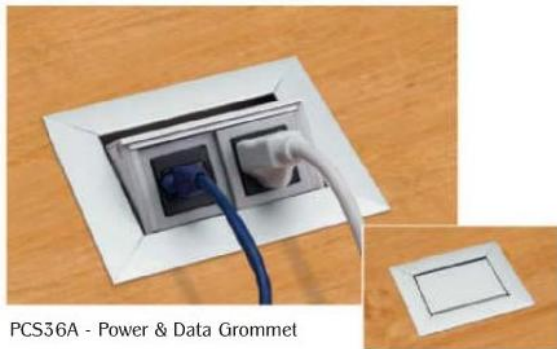

PCS36A - Power & Data Grommet

We have reduced prices on almost every product.  
Please visit [mockett.com/stimulus](http://mockett.com/stimulus) to see our new pricing!

"FINE ARCHITECTURAL HARDWARE FOR YOUR FINE FURNITURE"®

Doug Mockett & Company, Inc. • Manhattan Beach, CA • 800.523.1269

**MOCKETT**  
DOUG MOCKETT & COMPANY, INC.  
[www.mockett.com](http://www.mockett.com)

CIRCLE 105

## Compare These Buildings:



**Live 2 hr. Multimedia Presentation** by Richard Gage, AIA

Sat. May 2nd, 4 pm at Westin Market Street Hotel, 3rd St., S.F. - \$10  
See us at SF-AIA Booth #2609

**ARCHITECTS & ENGINEERS**  
for 9/11 TRUTH

Join hundreds of Architects & Engineers at [AE911Truth.org](http://AE911Truth.org) to petition for a new investigation

CIRCLE 106

# Product Focus **Windows**

Our roundup of commercial and residential window options includes **smarter shading systems**, technologies that allow for more expansive views, and **custom capabilities** that allow these openings to show off their own personalities. *Rita Catinella Orrell*



P. Allen Smith's window (sketch and final window design, above) was inspired by his love of natural materials and Gothic architecture.



Milton Glaser's window (right) is an ode to the seasons. Overlay panels transform the scene from Winter/Autumn into Spring/Summer.

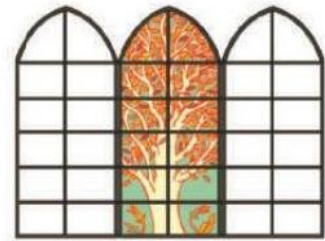
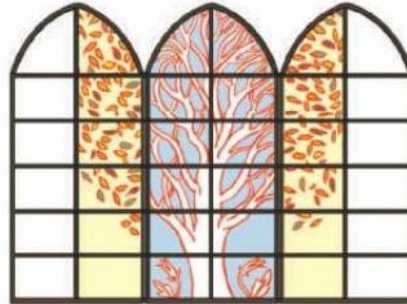

Karim Rashid's undulating window concept (above) is a reflection of his trademark style. Mark Laita's design (real window, left) features overlapping frames inspired by a photocollage.

## Bringing "dream windows" to life helps manufacturer promote custom capabilities

When Marvin Windows and Doors reached out to a select group of designers, architects, sculptors, and artists to participate in the myMarvin Project – a campaign to showcase the potential of custom window designs – the manufacturer posed a seemingly simple question: "If you could design your dream window, what would it be?"

The overwhelming response to this call for designs resulted in a collection of unique custom windows from a diverse group, including graphic designer Milton Glaser, architect and author Sarah Susanka, designer Karim Rashid, photographer Mark Laita, and TV host and garden design expert P. Allen Smith. "They each bring their own personal inter-

pretation to the myMarvin Project," says Marvin's director of marketing Brett Boyum, "which is exactly what we were hoping for."

Two of the concepts have already been hand-built by craftsmen at Marvin's manufacturing facility in Warroad, Minnesota: a window featuring overlapping rectangular frames inspired by a collage of sky images by Mark Laita, and P. Allen Smith's Gothic-inspired arched window. There are also plans to manufacture the three other designs: Karim Rashid's organic, undulating shape; Milton Glaser's ode to the seasons; and Sarah Susanka's geometric design featuring a simulated divided-lite pattern.

According to Boyum, projects that fit well with custom windows in-

clude historic replications that require unique castings, functionality, or features; projects designed to reflect the personality of the owner; or uses that require specific window and door energy performance. Hardware colors and styles, wood species, clad colors, grille patterns, and glass options are all selected by the customer.

While Marvin doesn't put restrictions on the initial concepts, there are some general limitations to actual production. "Performance, structural integrity, and installation are the keys," says Boyum. "If we question the performance or integrity of a design idea, we will work with our customers to find creative solutions to achieve the vision or intent. In the end, we will stand

behind any product we create."

Boyum says that there are preliminary plans to display the designs at various venues around the country, including exclusive museum exhibitions and charity auctions. Marvin doesn't plan to stop with these five designs, however. "There are also opportunities we're exploring as the campaign grows and evolves – possibly including design/architecture schools, industry professionals, or even simply customers with great style and ideas. The sky's the limit." Marvin Windows and Doors, St. Paul, Minnesota. [www.myMarvin.com](http://www.myMarvin.com)

**CIRCLE 205**

 For more information, circle item numbers on Reader Service Card or go to [architecturalrecord.com/products](http://architecturalrecord.com/products).

## Products Windows



◀ **Tempering light** Plexi-move panels offer a clean, distinctive alternative to curtains or other shading devices. Manufactured in Belgium by Inside, the Plexiglas panels are paired with an aluminum head rail system. Available in 50 colors and four finishes – matte, gloss, transparent, and florescent – the panels come in custom sizes and can be easily used as room dividers. They work to diffuse the intensity and glare of sunlight to create an even, warm ambience in the space. Window Modes, Ltd., New York City. [www.windowmodes.com](http://www.windowmodes.com) **CIRCLE 206**



▲ **Curtain call** The recently completed Meditech Southcoast building in southeastern Massachusetts, designed by Boston-based A&D firm Payette, utilizes the Kawneer 1600 Wall System with automatic solar-tracking sunshades. While saving energy and maximizing interior daylighting, the window wall is supported from the roof, providing enough wind-load resistance to avoid interior wind-load supports, which helps enhance views and aesthetics. Kawneer North America, Norcross, Ga. [www.kawneer.com](http://www.kawneer.com) **CIRCLE 207**

### ► Wood-framed efficiency

Weather Shield's new line of fiberglass-clad windows, when combined with effective glazing options, such as the company's Zo-e-shield collection, offer U-factors as low as 0.23. The windows combine the durability of exterior fiberglass cladding and the warmth of solid wood interior muntins. Tilt double-hungs, bows and bays, sliders, and triple sliders were introduced to the line earlier this year. Available in several colors and finishes. Weather Shield, Medford, Wis. [www.weathershield.com](http://www.weathershield.com)



◀ **Expanding options** Pella ProLine and Architect Series products now come with new color options for both exterior cladding and between-the-glass grilles, which provide a 43 percent reduction in solar heat gain compared to roomside blinds. The redesigned Architect Series HurricaneShield double-hung window (shown), provides impact-resistant durability without sacrificing interior aesthetics, by eliminating the need for brace clips and other visible reinforcement. Pella Windows & Doors, Pella, Iowa. [www.pella.com](http://www.pella.com) **CIRCLE 209**

**CIRCLE 208**



▲ **Automated shading** MechoShade's shading system uses three elements to regulate natural light in the USGBC's new headquarters in Washington D.C. SolarTrac software optimizes energy performance by analyzing sunlight conditions and adjusting shades and artificial lighting accordingly. The software works with EcoVeil shades and the IQ/485 Network, which provides an integrated mechanical and control system to operate all of the elements in concert. MechoShade Systems, Long Island City, N.Y. [www.mechoshadesystems.com](http://www.mechoshadesystems.com) **CIRCLE 210**

▼ **Steel profile** An alternative to aluminum or hollow-metal window frames, SteelBuilt window and door frames provide greater strength and a thinner metal profile, and can be used with different glass types and sizes. Compared to aluminum frames, SteelBuilt has a greater wind-load capacity and potential glass size, while reducing heat transfer, profile sweating, and thermal expansion. Technical Glass Products, Snoqualmie, Wash. [www.tgpamerica.com](http://www.tgpamerica.com) **CIRCLE 211**



For more information, circle item numbers on Reader Service Card or go to [architecturalrecord.com/products](http://architecturalrecord.com/products).



# DYNAMIC CEILING

See creative visions become reality at [www.eventscape.net](http://www.eventscape.net)

High gloss custom fabric ceiling panels fabricated by Eventscape create mirror-like reflections of color and excitement in this theatre lobby. One of several recent installations for this nationwide motion picture exhibitor.

Fabrication & Installation: Eventscape Inc. Design: Shikatani Lacroix  
Location: Cineplex, Fairview Mall, Toronto, ON

**Infinite flexibility.** We will build any structure at any scale, with no restriction on form or material. Our obsession with craftsmanship and detail guarantees that every structure is as beautiful as it is functional

T 416.231.8855 F 416.231.7225 E [info@eventscape.net](mailto:info@eventscape.net)

# Product Briefs



▲ **Double sink** Created by California-based designer Fu-Tung Cheng, the new Ripple Sink is imagined as a combined center for food preparation. Six feet from end to end, the left-hand bowl is a deep, 34" basin, while the right-hand, shallow sink is a 16" diameter circle for vegetable washing. Spanning the two is a drain board, providing a flat surface for cutting. Elkay Sinks & Faucets, Chicago. [www.elkayusa.com](http://www.elkayusa.com)

CIRCLE 212



▲ **Rammed earth** Tom Ward of Ward Blake Architects used his own home outside Jackson, Wyoming, to demonstrate his firm's innovative use of rammed earth. According to the firm, the process combines 20th-century post-tensioning steel technology with the ancient material of rammed earth – in this case, 10 percent on-site soil, 10 percent cement, and 80 percent locally sourced crusher fine (a by-product of gravel production). The result is a seismically stable version of an ancient building technology that is also aesthetically consistent with the surrounding landscape. Ward Blake Architects, Jackson, Wyo. [www.wardblakearchitects.com](http://www.wardblakearchitects.com) CIRCLE 214



◀ **Green, colored linoleum** One hundred years after the introduction of linoleum in North America, Armstrong continues to innovate and advance its wide range of products. One new feature is its Color Continuum, a tonal step system that organizes the collection into a range of hues in order to easily specify a color range for any project. Armstrong linoleum also supports LEED rating systems, earning credits in several areas, including resource use and indoor air quality. Armstrong World Industries, Lancaster, Pa. [www.armstrong.com](http://www.armstrong.com) CIRCLE 216

► **Liquid screen** Bluworld of Water's Rain Curtain is a distinctive water element that can add a mesmerizing focal point to any interior space. Water slides gently down clear mylar strands from the ceiling to a basin below. The Rain Curtain emulates both the sound and appearance of a light rain shower. As a freestanding element, there is no limit to the size the curtain can be, but ideally it should be placed in large, vertical spaces where not much structural support is needed. Bluworld of Water, Orlando. [www.bluworldusa.com](http://www.bluworldusa.com)

CIRCLE 213



◀ **Hybrid furniture** Dutch designer Edward van Vliet designed the new Sushi Collection with a mix of Japanese forms and Moroccan overtones. Van Vliet designed both the shapes and textile patterns for the series, which includes the Donut Bench (left) and Karmacoma Sofa (below). Textile patterns were inspired by a

variety of sources, from Japanese folklore to Spirograph drawings. The collection is constructed of flame-retardant polyurethane foam in various densities, with seating cushions in foam or goose down. Moroso USA, New York City. [www.morosousa.com](http://www.morosousa.com)

CIRCLE 215



► **Naturally insulated** BioPCM is an alternative insulation that uses a biobased material developed by Entropy Solutions to save energy by up to 30 percent. Made from fats and oil, these Phase Change Materials (PCMs) work by absorbing and releasing energy (heat) based on the outside temperature to regulate the inside temperature of a structure. Though PCMs aren't new, BioPCM achieves the same solutions without environmentally dangerous petroleum and chemicals. Phase Change Energy Solutions, Asheboro, N.C. [www.phasechangeenergy.com](http://www.phasechangeenergy.com) CIRCLE 217



For more information, circle item numbers on Reader Service Card or go to [architecturalrecord.com/products](http://architecturalrecord.com/products).



# BEAR CREEK LUMBER



High Quality Recycled ~ Reclaimed Products  
welovewood@bearcreeklumber.com ~ BearCreekLumber.com  
Quality Renewable Lumber ~ Premium Customer Service

CIRCLE 107

## Don't Do It Half-Grassed!



Graspave2 (right) has 100% grass coverage, 5721 psi compressive strength, 92% void space for the healthiest root zone, and is made from 100% recycled plastic. Gravelpave2 (not shown) is beautiful too!

800-233-1510  
invisiblestructures.com



CIRCLE 108



RED

ED17 CMH  
T6 CMH  
CFL

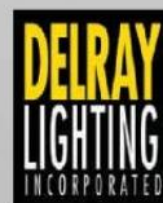

delraylighting.com

CIRCLE 109





**BOSTON  
ARCHITECTURAL  
COLLEGE**

# Distance M. Arch

## Practice in Kenai, Alaska... get your master's in Boston.

Earn a NAAB accredited degree while living and working anywhere in the U.S.

Complete your degree in two years of academics and practice.

[www.the-bac.edu](http://www.the-bac.edu) | 617.585.0202

CIRCLE 110



  
MANNING  
LIGHTING

See what's new, including the G2,  
part of our decorative outdoor collection,  
at AIA Booth #556.

[manningtg.com](http://manningtg.com)  
Manning Lighting Inc. Sheboygan, WI USA  
p 920.458.2184 f 920.458.2491

CIRCLE 111



"Organza Pendant"

[www.charlesloomis.com](http://www.charlesloomis.com)  
1.800.755.0471

*Loomis*

CIRCLE 112

## Dates & Events

### New and Upcoming Exhibitions

#### **A/cute Tokyo**

##### **Los Angeles;**

May 2 - June 3, 2009

This exhibition features explorations of the dynamics of Tokyo, highlighting ongoing urban and design research conducted by UCLA and Tokyo Institute of Technology faculty and students. At UCLA's Department of Architecture and Urban Design Perloff Gallery. For more information, please call 310/267-4704 or visit the Web site at [www.aud.ucla.edu](http://www.aud.ucla.edu).

#### **Richard Neutra, Architect: Sketches and Drawings**

##### **Los Angeles**

May 3, 2009 - September 6, 2009

This exhibition is an outstanding selection of Neutra's travel sketches, figure drawings, and building renderings. The works range from early drawings from Neutra's student wanderings in 1913 to later renderings of his Los Angeles houses from the 1950s. At the Central Library's Getty Gallery. For more information, call 213/228-7500 or visit [www.lfla.org](http://www.lfla.org).

#### **) hat ) as Good Design? MoMA's Message 1944-56**

##### **New York City**

Opens May 6, 2009

At midcentury, MoMA played a leading role in the definition and dissemination of so-called Good Design, a concept that took shape in the 1930s and emerged with new relevance in the decades following World War II. This installation presents selections from MoMA's design collection that illuminate the primary values of Good Design as promoted (and disputed) by museums, design councils, and department stores. At the Museum of Modern Art. Call 212/708-9400 or visit [www.moma.org](http://www.moma.org).

#### **Santiago Calatrava: ) orld Trade Center Transportation Hub**

##### **New York City**

May 9 - August 31, 2009

Santiago Calatrava will be the subject of a new exhibition showcasing architectural models along with a multimedia presentation. At the Queen Sofia Spanish Institute. For more information, call 212/623-0420 or visit [www.queensofiaspanishinstitute.org](http://www.queensofiaspanishinstitute.org).

### Ongoing Exhibitions

#### **Eric Owen Moss: The Sky Is Open**

##### **Los Angeles**

Through May 17, 2009

Eric Owen Moss is the director of SCI-Arc and principal and founder of Eric Owen Moss Architects, Culver City. At SCI-Arc Gallery. Visit [www.sciarc.edu](http://www.sciarc.edu).

#### **) inners of the 2009 Design Awards and Building Type Awards**

##### **New York City**

Through June 30, 2009

AIA New York's annual Design Awards Program recognizes excellence in architectural design by New York City architects and for work in New York City. The purpose of the awards program is to increase awareness of outstanding design and to honor the architects, clients, and consultants who work together to improve the built environment. The AIA New York's Building Type Awards is a collaborative program with the Boston Society of Architects (BSA) that honors excellence in architectural design for specific typologies. This year, achievement in Health Facilities and in Housing was recognized. At the Center for Architecture, 536 LaGuardia Place. For more information, visit [www.aia.org](http://www.aia.org).

#### **Chicago: You Are Here**

##### **Chicago**

Ongoing

An engaging permanent exhibition that includes a scale model of downtown Chicago, along with images, artifacts, and video presentations, encouraging visitors to explore the architecture, infrastructure, and environment of Chicago. At the Chicago Architecture Foundation. Call 312/922-3432 or visit [www.architecture.org](http://www.architecture.org).

### Lectures, Conferences, and Symposia

#### **47th International Making Cities Livable Conference on True Urbanism: Cities for Health and ) ell-Being**

##### **Portland**

May 10 - 14, 2009

Call for Papers Deadline: October 15, 2008

An international conference for city officials, practitioners, and scholars in architecture,

### Range 805 Simple. Sophisticated. Stainless Steel.

[hewi.com/range805](http://hewi.com/range805)

Thanks to sleek styling, the new stainless steel accessories of the sanitary Range 805 are a contemporary and sophisticated solution. Range 805 is made of brushed stainless steel with functional elements of polyamide, which makes them pleasant to touch.



#### **CIRCLE 113**

Häfele America Showrooms  
in New York, Chicago  
and San Francisco  
800.423.3531  
[www.hafele.com](http://www.hafele.com)



Any photo or image can be transferred to a master RECKLI form. Re-usable forms are then manufactured to help reduce formliner waste (from one-time applications). Because of the pliable material, release is easier, resulting in less concrete waste. An environmentally conscious and creative way to add imagery to all of your concrete projects!

The ART of Concrete



Find out more about  
photo-engraved forms.  
Visit our booth at the 2009  
AIA National Convention  
and Design Exposition  
South Hall, booth # 124

**Nawkaw**  
Changing the color of masonry

Official supplier of Reckli Formliners **RECKLI**

Photo-Engraved Formliners Custom Formliners  
Architectural Stains Historic Restoration and Main Street Projects  
Graffiti Removal and Resistance Water-Repellents  
Concrete and Masonry Repair and Cleaning

www.nawkaw.com 800.905.2692 info@nawkaw.com



## Dates & Events

urban design, planning, landscape architecture, transportation planning, health policy, and social sciences to share ideas and establish working relationships. Visit [www.LivableCities.org](http://www.LivableCities.org).

### Lecture: Benjamin Ball

#### Los Angeles

May 11, 2009

Benjamin Ball is principal of Ball-Nogues, based in Los Angeles, who presented its most recent installation, *Echoes Converge*, at the 11th International Architecture Exhibition at the Venice Biennale in fall 2008. At UCLA's Department of Architecture and Urban Design Perloff Gallery. Call 310/267-4704 or visit [www.aud.ucla.edu](http://www.aud.ucla.edu).

### Finnish Design & Sustainability

#### New York City

May 12, 2009

This is the final lecture in the series on Nordic Sustainability and Design. Esa Vesmanen is an award-winning interior architect and a partner in the design company Pure Design Ltd., as well as a researcher for the Future Home Institute of the University of Art and Design Helsinki. He will speak about experimentation in sustainable design by translating people's interaction with nature and the benefits of "flexible" design. At Scandinavia House. Call 212/879-9779 or visit [www.scandinaviahouse.org](http://www.scandinaviahouse.org).

### Central PA AIA Spring Lecture 2009

#### York, Pennsylvania

May 14, 2009

This year's featured lecture includes "Shigeru Ban: Works and Humanitarian Activities." In the Capitol Theatre at the Strand Capitol Performing Arts Center. Call 717/236-8969 or visit [www.aiacentralpa.org](http://www.aiacentralpa.org).

### National Green Builders Products Expo

#### Las Vegas

May 27 - 29, 2009

A trade-to-trade event bringing suppliers and providers together. Buyers include builders, developers, project managers, subcontractors, remodelers, architects, government planners, specifiers, engineers, and dealers from across the country. At the Las Vegas Convention Center. Call 800/859-9247 or visit [www.ngbp.com](http://www.ngbp.com).

### Vietnam Architecture Exhibition '09

#### Ho Chi Minh City, Vietnam

June 4 - 7, 2009

The first annual professional architecture exhibi-

tion in Vietnam, providing a forum for designers and architects planning to enter the Vietnam market. At the Saigon Exhibition and Convention Center. Call 84 8 351 26934/394 33665 or visit [www.vietnam-arc.com](http://www.vietnam-arc.com).

### China Eco Expo: The International Marketplace for the Environment

#### Beijing

June 18 - 20, 2009

Held in conjunction with the China Ministry of Construction's 14th Annual Trade, this expo is a high-level and highly promoted showcase for advanced green products, technologies, and services from around the world. At the Beijing International Exhibition Center. For more information, visit [www.ecoexpo.com](http://www.ecoexpo.com).

### DesignDC 2009

#### Washington, D.C.

July 14 - 16, 2009

Attendees have the ability to satisfy all 18 continuing education units required each year as an AIA member through seminars and tours while browsing through a trade show with more than 60 exhibitors and vendors. At the Walter Washington Convention Center. For more information, visit [www.aiadesigndc.org](http://www.aiadesigndc.org).

## Competitions

### 9th Annual Steel Design Student Competition

Submission Deadline: May 20, 2009

This program will offer architecture students the opportunity to compete in two separate categories and is intended to challenge the students, working individually or in teams, to explore a variety of design issues related to the use of steel in design and construction. Call 202/785-2324 or visit [www.acsa-arch.org](http://www.acsa-arch.org).

### 2008-09 Green Community, International Student Design Competition

Submission Deadline: May 20, 2009

The competition offers students the opportunity to think critically about their communities looking to a sustainable future. Locate a site in your local area, identify the barriers and strengths to living sustainably, and develop a proposal to create a flourishing and sustainable community using the tools of the environmental design disciplines: architecture, landscape architecture, and urban planning. Call 202/785-2324 or visit [www.acsa-arch.org](http://www.acsa-arch.org).

## THE SKYSCRAPER MUSEUM

39 Battery Place | New York, NY  
www.skyscraper.org

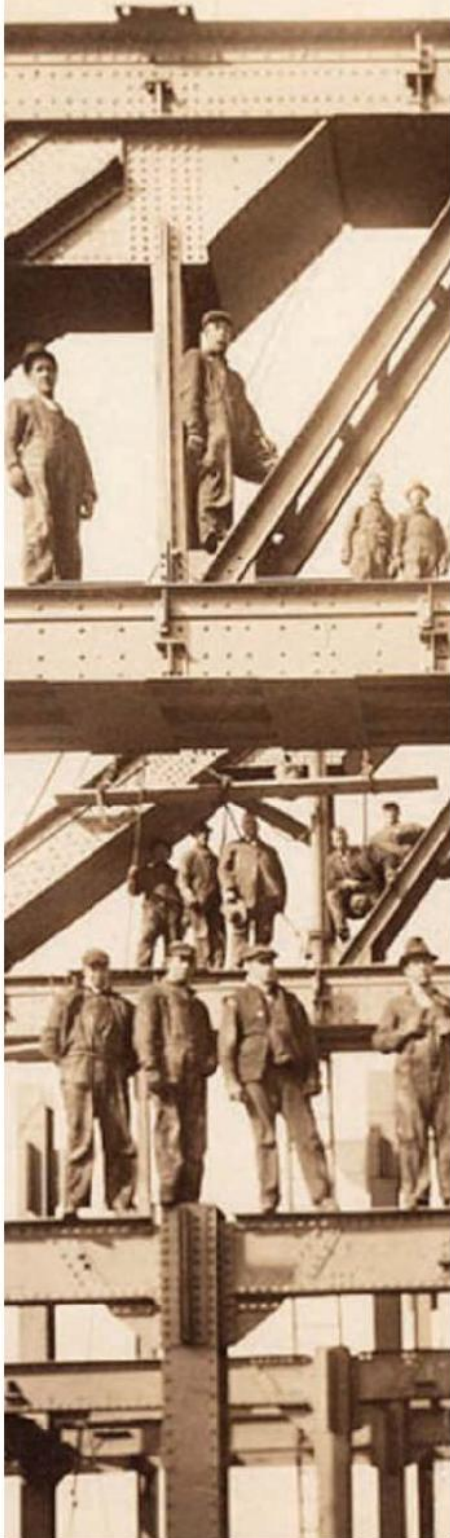

ONLINE ARCHIVES: BANKER'S TRUST  
CONSTRUCTION VIEWS, 1910-1931

BOOK TALK: ANDREW S. DOLKART  
BIOGRAPHY OF A TENEMENT HOUSE  
IN NEW YORK CITY | May 5

Upcoming Exhibition  
CHINA PROPHECY

## Dates & Events

### The ASLA 2009 Student Awards

*Entry Deadline: May 29, 2009*

The American Society of Landscape Architects (ASLA) awards program honors the best in landscape architecture from around the world, while the student-awards program provides a glimpse of the future of the profession. Visit [www.asla.org](http://www.asla.org).

### Women in Design Network (WID) Annual Exhibit and Awards Program

*Exhibition entries and award nominations details are available June 1.*

Built, unbuilt, and student work in all design disciplines are invited; the design team must include a woman designer, planner, engineer, project manager, researcher, artist, or student. Visit [www.architects.org/wid](http://www.architects.org/wid).

### Unbuilt Architecture

*Deadline: June 4, 2009*

Architects, architectural educators, and architecture students throughout the world are invited to submit real or theoretical projects. Visit [www.architects.org/awards](http://www.architects.org/awards)

### Going with the Grain: Design an Object Using Sustainable Wood

*Deadline: June 2, 2009*

The "Going with the Grain Challenge" is to design an original and compelling object that can be made from a single sheet of FSC-certified plywood measuring 4 feet by 8 feet by 1 inch. All are welcome to enter, including furniture designers and manufacturers, architects, and industrial designers. Visit [www.design21.cmail.com](http://www.design21.cmail.com).

### The 4th Nitōri One-House Total Coordination Competition 2009

*Entry Deadline: June 20, 2009*

*Submission Deadline: June 30, 2009*

In this competition, Nitōri invites the public to propose totally coordinated designs of fabrics, furniture, and interior accessories. The competition aims to commercialize excellent designs and sell them at Nitōri stores as well as identify up-and-coming designers. Visit [www.nitori.co.jp/english/contest2009/](http://www.nitori.co.jp/english/contest2009/).

### Honor Awards for Design Excellence

*Deadline: June 25, 2009*

Projects of any type anywhere in the world designed by Massachusetts architects and projects built in Massachusetts designed by architects throughout the world are invited. Visit [www.architects.org/awards](http://www.architects.org/awards).



## Two ways to show your commitment to green building.

If you're designing a green home, naturally you'd recommend ENERGY STAR® products. Today, there's another symbol to look for in green designs: the symbol of the Sustainable Forestry Initiative®, an internationally recognized, independent certification program. SFI-labeled building materials meet rigorous environmental standards to help you build green. Learn more at [www.sfiprogram.org](http://www.sfiprogram.org).



SUSTAINABLE  
FORESTRY  
INITIATIVE

*Good for you.  
Good for our forests.™*

**THE  
ODDS  
ARE NOW  
STACKED  
WITH  
YOU.**



Steel Joist Institute has 80 years of knowledge contained in publications, videos and software on Steel Joist design and construction. So, stack the odds in your favor on your next project. Go to [steeljoist.org/stack](http://steeljoist.org/stack)



*Steel Joists Give You More.*

## Dates & Events

### Rising Tides Idea Competition

*Deadline: June 29, 2009*

An international design idea competition aimed at generating innovative solutions that deal with adapting shoreline areas to sea level rise. The competition is a response to scientific estimates that global warming may raise water levels in the Bay over 4 feet by the end of the century. Visit [www.risingtidescompetition.com](http://www.risingtidescompetition.com).

### Pamphlet Architecture 30 Competition: Investigations in Infrastructure

*Deadline: July 1, 2009*

At a time of new government leadership committed to investing in the United States' infrastructure, architects, engineers, and artists should propose new directions for transportation, energy, and agriculture at a continental scale. In this spirit, no visionary dimension is too large, no inventive proposal too ambitious to consider. Visit [www.pamphletarchitecture.org](http://www.pamphletarchitecture.org).

### Juried Photo Exhibits at Build Boston and Residential Design and Construction

*Deadline: July 31, 2009*

All New England architects, landscape architects, and interior designers who are members of the AIA, ASID, ASLA or IIDA are eligible. Visit [www.architects.org/photoexhibit](http://www.architects.org/photoexhibit)

### The Deutsche Bank Urban Age Award

*Deadline: September 11, 2009.*

The Deutsche Bank Urban Age Award recognizes and celebrates creative solutions to the problems and opportunities that face more than half of the world's population that now lives in cities. Accordingly, the award focuses on projects that benefit communities and local residents by improving their urban environments. Visit [www.urban-age.net](http://www.urban-age.net).

### BSA Research Grants in Architecture

*Application deadline: September 18, 2009*

Designed to expand the architectural knowledge base, grants may be made to individuals, collaborative teams, students, or organizations and institutions. Visit [www.architects.org/grants](http://www.architects.org/grants)

*E-mail information two months in advance to [elisabeth\\_broome@mcgraw-hill.com](mailto:elisabeth_broome@mcgraw-hill.com).*

**Glass Wedge™**  
Patented

**WAGNER**

- Dry Glaze Options for Structural Glass Railing
- Meets Structural Code Requirements
- For 1/2" or 3/4" Tempered Glass

[www.glassrail.com](http://www.glassrail.com)

**PanelGrip™**  
Patent Pending

**GREEN**

**Wagner Exclusives**

**THE WAGNER COMPANIES**

[www.wagnercompanies.com](http://www.wagnercompanies.com)  
1-888-243-6914

*Beautiful Railings Begin With Wagner*

**Lumenrail®**  
Lighted Railing System

[www.lumenrail.com](http://www.lumenrail.com)

**WAGNER**

- Handrail or Guardrail
- Latest LED Technology
- Accent or Practical Lighting
- Improve Safety and Security

## DOORS, WINDOWS

## CUSTOMIZED SUNSHADE SYSTEMS

**Unicel Architectural Corp.**

▲ Unicel Architectural specializes in developing customized shading systems that allow optimal daylight and sunshade, reducing glare, heat gain and cooling energy consumption. Thanks to these energy-saving features, Unicel Architectural Louvers help architectural projects qualify for LEED credits. The sunscreens manufactured by Unicel Architectural are available with different types of louvers and are fixed horizontally or vertically, at any predetermined angle to suit the project's specific demands. Made of extruded aluminum with full rust-free components, the sunshades have elegant lines and curves.

800.668.1580  
www.unicelarchitectural.com



SNAP 150

## DOORS, WINDOWS

## EUROPEAN GLASS WALL PARTITIONS &amp; GLASS DOORS

**\$\$\$ | NEW****Avanti Systems USA**

▲ Innovative architectural Glass Wall and Glass Door Systems available for high-end applications

**Product Application:**

- USS Intrepid Sea-Air-Space Museum, New York, NY
- UFC Headquarters, Las Vegas, NV
- Brown University, Providence, RI

**Performance Data:**

- Relocatable, dry-jointed partitioning glass walls
- Freestanding Glass Walls, LCD Glass Walls & Doors

www.avantisystemsusa.com  
877.282.6843

**Contact:** Stephen Mordaunt  
on sweets.com



SNAP 151

## DOORS, WINDOWS

## DOORS FOR INTERIOR ARCHITECTURE

**NC****Woodfold Mfg., Inc.**

▲ Woodfold makes doors for use as sight, security and acoustic solutions; plus short production times.

**Product Application:**

- Hilton Hotels, various locations
- Candlewood Suites, various locations
- Walt Disney World, Orlando, FL

**Performance Data:**

- FSC hardwoods available

woodfold.com  
503.357.7181  
**Contact:** Randy Roedel  
on sweets.com



AIA Booth # 4177

SNAP 152

## DOORS, WINDOWS

## FIRE SMOKE PROTECTION FOR DOORS

**Zero International, Inc.**

▲ Zero International offers adhesive perimeter seals for superior protection in fire and smoke door assemblies.

**Product Application:**

- Sound ratings suitable for hospitality applications

**Performance Data:**

- #188FS made from intumescent rubber and silicone-based #188, are Category G & H edge-seals for use with Category B doors carrying ratings of 45 or 20 min.

www.zerointernational.com  
800.635.5335  
on sweets.com

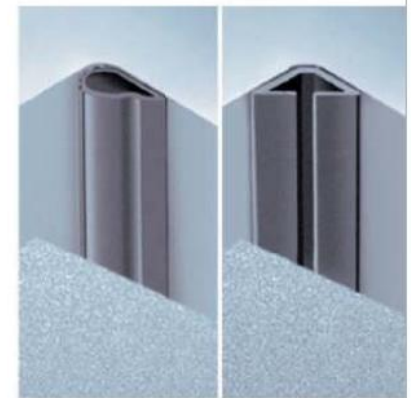

AIA Booth # 621

SNAP 153

## DOORS, WINDOWS

## FIRE-RATED ALUMINUM WINDOWS &amp; DOORS

**WR | G****Aluflam North America**

▲ Clean lines of true extruded aluminum frames and large panels of clear glass. Fire-rated to 60 min.

**Product Application:**

- 30 S. Wacker, BP Brightlights, Chicago, IL
- "O" Theatre, Bellagio Hotel, Las Vegas, NV
- Varsity Athletic Facility, Dartmouth University, Hanover, NH

**Performance Data:**

- Interior and exterior applications—windows and doors
- Many finishes available including clear/bronze anodize, Kynar/Duramar, powdercoating

www.aluflam-usa.com  
714.899.3990

**Contact:** Zac Monroe



AIA Booth # 2517

SNAP 154

## DOORS, WINDOWS

## EASY SWING DOORS

**\$\$\$ | NEW****Eliason Corporation**

▲ Custom manufactured, unlimited color selection, the new easy swing, no show hardware

**Product Application:**

- Restaurants
- Hotels and motels
- Casinos

www.eliasoncorp.com  
800.828.3655

**Contact:** Door Sales  
on sweets.com



AIA Booth # 632

SNAP 155

## DOORS, WINDOWS

## DAYLIGHTING

## Kalwall Corporation

▲ Skylights, curtainwalls and window replacement systems of every imaginable configuration from a world leader in translucent daylighting. Over 50 years of innovation and performance. Renowned for balanced, diffuse natural light, Kalwall fills any space with glare-free, shadow-free, pure museum-quality daylighting and the most advanced insulating performance. An inviting nighttime glow brings any building to life while preventing direct-beam illumination from escaping the building. Daylight modeling service. Green and LEED.



www.kalwall.com  
800.258.9777  
on sweets.com

SNAP 156

## DOORS, WINDOWS

## SPECIALTY DOOR HARDWARE

\$\$

## Richards-Wilcox, Inc.

▲ Heavy-duty specialty hardware for sliding, swinging and bi-fold doors

## Product Application:

- Hardware for sliding interior doors and room partitions
- Swinging and sliding door hardware for carriage houses and stables
- Decorative styles for traditional building
- Hardware for doors weighing 300 - 5,000 lb.

## Performance Data:

- Powder coat, stainless, or galvanized finishes available



www.rwhardware.com  
800.877.8456

Contact: Dan Lorden

AIA Booth # 5360

SNAP 157

## DOORS, WINDOWS

## SAVE ENERGY WITH TRANSLUCENT DAYLIGHTING

WR | G

## Major Industries, Inc.

▲ Guardian 275 translucent panel systems are lightweight, save energy, and eliminate glare.

## Product Application:

- Replace outdated systems with energy-efficient Guardian 275 panels
- Skylights and curtainwall systems available
- Blast and hurricane protection systems also available

## Performance Data:

- Approved for hurricane protection by Texas Dept. of Insurance
- Industry-leading warranties guarantee long-term performance



www.majorskylights.com  
888.759.2678

AIA Booth # 651

SNAP 158

## DOORS, WINDOWS

## TRANSLUCENT FACADE RENOVATION

NC | G | NEW

## CPI Daylighting Inc.

▲ CPI facades are an affordable, durable face lift introducing soft natural daylight into a building.

## Product Application:

- Third & Pine parking garage facade, Seattle, WA
- Design-build solution
- Proven system longevity

## Performance Data:

- Soft diffused light, no glare
- Maintenance-free



www.cpidaylighting.com  
800.759.6985

Contact: Brian Cain  
on sweets.com

AIA Booth # 2350

SNAP 159

## ELECTRICAL, LIGHTING

## BIG IMPACT, SMALL FOOTPRINT

\$\$ | G | NEW

## B-K Lighting

▲ Compact, powerful with BKSSL Technology, 2-in. dia., non-visible mounting hardware, 360° rotation

## Product Application:

- Architectural
- Interior design
- Landscape design

## Performance Data:

- Exclusive 360° side-emitting LED, 1.12 watts 70 lumens, 35,000 rated hour life
- Invisible mounting hardware, 360° faceplate rotation for unlimited aiming options



www.mini-ilume.com  
559.438.5800

Contact: Becky Carlson

AIA Booth # 1617

SNAP 160

## ELECTRICAL, LIGHTING

## LED SOURCE

\$\$ | G | NEW

## Teka Illumination

▲ Wall or path, BKSSL™ technology, long life, significant energy reduction, exceptional thermal management, LED source

## Product Application:

- Architectural lighting
- Interior design
- Landscape design

## Performance Data:

- Exclusive 360° side-emitting 1.12 watt LED with BKSSL technology
- Wall and path luminaires constructed from pure copper and brass
- Also available in LV G4 Xelogen 10 or 20 watts, 20,000 or 10,000 hour rated life, 100 or 250 lumens

www.highlightseries.com  
559.438.5800

Contact: Becky Carlson



AIA Booth # 1617

SNAP 161

## ELECTRICAL, LIGHTING

## ARCHITECTURAL CEILING FANS &amp; LIGHTING

G

## G Squared Art

▲ San Francisco ceiling fan, GOOD DESIGN Award winner. Quiet, powerful, reliable, an energy saver.

## Performance Data:

- Suitable for sloped ceilings up to 29 degrees, can be used on 8 ft. ceilings or on cathedral ceilings with optional downrods up to 6 ft. long
- Lifetime warranty



www.g2art.com

877.858.5333

Contact: info@g2art.com

SNAP 162

## ELECTRICAL, LIGHTING

## LED LIGHTING SYSTEMS

WR | G | NEW

## Sternberg Lighting

▲ UNRIVALED™ decorative outdoor LED lighting provides energy savings in excess of 50%.

## Product Application:

- University of Notre Dame, Notre Dame, Indiana

## Performance Data:

- Approximately 70,000 hours of system life (16 years)
- Energy consumption can be reduced by over 50% with comparable photometric performance.

www.sternberglighting.com

800.621.3376

Contact: Peter Schreiber

on sweets.com

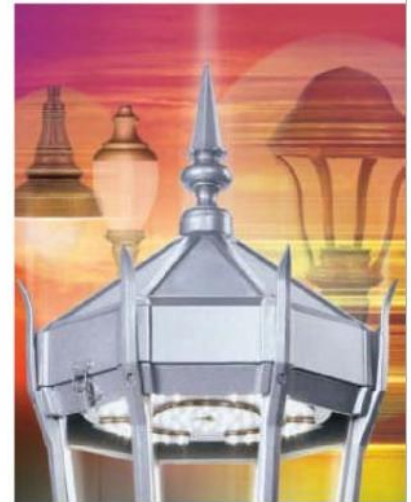

SNAP 163

## ELECTRICAL, LIGHTING

## OUTDOOR LIGHTING FIXTURES

## Hunza

▲ To ensure that an outdoor lighting fixture will last the distance, it is essential to use the best materials and pay careful attention to detail. Hunza combines simplicity in design with precision-machined components to produce low-voltage outdoor fixtures that will leave a lasting impression. Hunza offers the highest quality in path, deck, landscape, in-ground, underwater and wall mount fixtures.

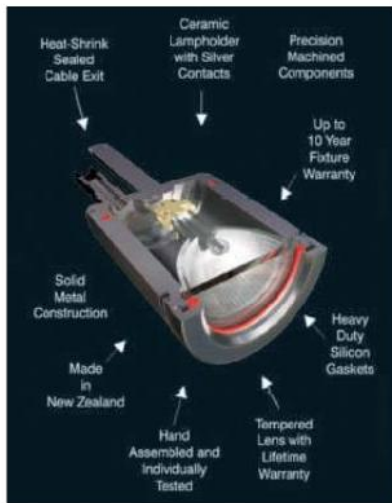

www.hunzausa.com

310.560.7310

SNAP 164

## INTERIOR FINISHES, FURNISHINGS

## NOT YOUR AVERAGE DOOR HANDLES

## MARTIN PIERCE

▲ They make exceedingly beautiful, tasteful, original, artistic door handles and cabinet pulls. Worth taking a look at.

## Performance Data:

- Many are ADA compliant.
- Made in Los Angeles

www.martinpierce.com

800.619.1521

Contact: Arne Pierce

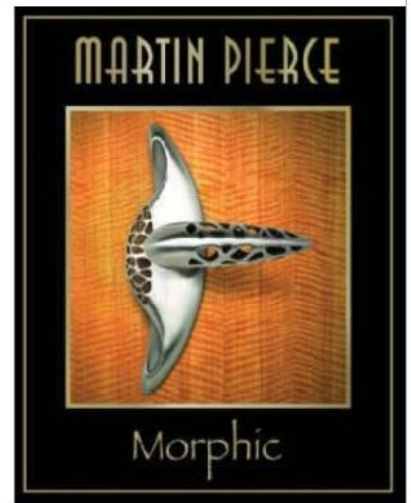

AIA Booth # 4256 North Hall

SNAP 165

## INTERIOR FINISHES, FURNISHINGS

## 100% RECYCLED LOCKERS &amp; PARTITIONS

WR | G | NEW

## Partition Systems Inc. of South Carolina

▲ PSISC Lockers & Toilet Partitions are 100% post consumer recycled HDPE with antimicrobial protection.

## Product Application:

- Hospitals
- Schools
- Athletic facilities

## Performance Data:

- 20 year warranty
- 100% post consumer recycled HDPE



www.psisc.com

866.202.1426

Contact: Tori Alford

AIA Booth # 2025

SNAP 166

## INTERIOR FINISHES, FURNISHINGS

## ACOUSTIC PLASTER SYSTEM

G

## Pyrok Inc.

▲ Acoustical wall and ceiling finish. Smooth, seamless sound absorbing ceiling and wall finish.

## Product Application:

- California Academy of Sciences, San Francisco, CA
- White House press briefing room, Washington, D.C.
- Burchfield Penney art center, Buffalo, NY



www.starsilent.com

914.777.7070

Contact: Howard Podolsky

AIA Booth # 6750

SNAP 167



## INTERIOR FINISHES, FURNISHINGS

## BAMBOO PLYWOOD &amp; FLOORING

\$\$ | G | NEW

## Smith &amp; Fong Co. Plyboo

▲ The world's first FSC-certified bamboo plywood and flooring. Also available urea formaldehyde-free.

## Performance Data:

- LEED Credit: MR 6: Rapidly Renewable Materials
- LEED Credit: EQ 4.4: Low-Emitting Materials



www.plyboo.com  
866.835.9859

AIA Booth # 2339

SNAP 168

## INTERIOR FINISHES, FURNISHINGS

## FRAMELESS BRACKETS SYSTEM

\$ | NEW

## Glass and Glass

▲ Flextech Brackets System for handrails and any other straight and curved frameless application. For commercial and residential use. Suitable to hold glass, wood and stainless steel. Dade County approved.

## Product Application:

- Certified green mansion, Palm Beach County, FL
- Commercial "Latitude on Brickell," Miami, FL
- Grimpa Steakhouse Restaurant, Miami, FL

## Performance Data:

- Concentrated load test ANSI Z97.1 CPSC 16 CFR 1201

www.glassandglass.com  
305.416.5001

Contact: Rolando Serra



SNAP 169

## INTERIOR FINISHES, FURNISHINGS

## ORNAMENTAL PLASTER CEILING TILES

G

## Above View Mfg., By Tiles, Inc.

▲ Ornamental plaster ceiling tiles fabricated from a non-toxic, non-combustible, proprietary composition

## Performance Data:

- The tiles drop into any standard 15/16-in. T-Bar grid system.
- The design line consists of more than 60 standard designs.
- Custom design work, custom colors and faux finishes are available.

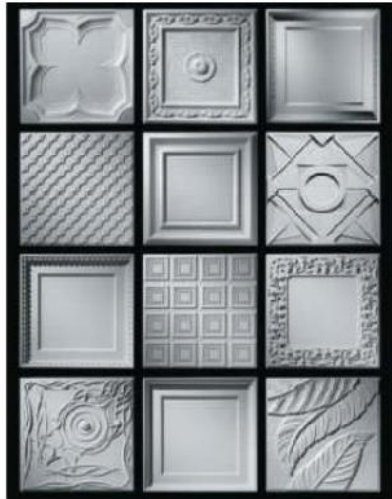

www.aboveview.com  
414.744.7118

SNAP 170

## INTERIOR FINISHES, FURNISHINGS

## SPORTS FLOORS

## Maple Flooring Manufacturers Association

▲ The Maple Flooring Manufacturers Association (MFMA) establishes quality and performance of sports floors, installation guidelines regarding safety, performance, maintenance and promotes the use of maple flooring worldwide.

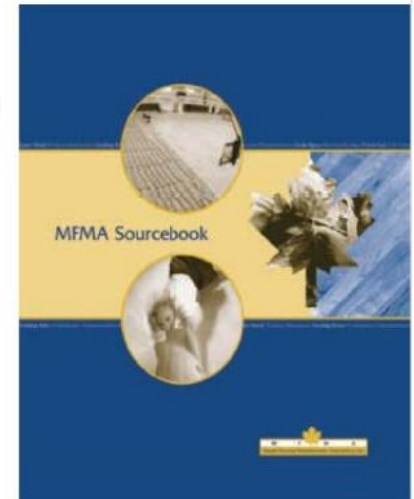

www.maplefloor.org  
888.480.9138

Contact: Daniel F. Heney, dheney@maplefloor.org

SNAP 171

## INTERIOR FINISHES, FURNISHINGS

## AUTOMATED SOLAR-SHADING SYSTEM

WR | NEW

## MechoShade Systems

▲ The automated SunDiater™ solar-shading system tracks the sun and sky conditions, adjusting the shades throughout the day.

- Optimizes daylight
- Maximizes occupants' view
- Reduces artificial lighting
- Saves money
- Assures highest levels of comfort



MechoShadeSystems.com  
718.729.2020

Contact: William L. Maiman  
on sweets.com

Lightfair Int. Booth # 221

SNAP 172

## LANDSCAPING, SITEWORK

## EXTERIOR &amp; INTERIOR GREEN WALL SYSTEMS

\$\$ | G | NEW

## Tournesol Siteworks LLC

▲ VGM modular greenwall panels make greening buildings simple. Rely on them to make buildings green.

## Product Application:

- Roof garden & roof equipment screening
- Softening parking structures & building facades
- Structuring space in public areas

## Performance Data:

- Attaches with a stainless frame & rail system
- 4-in. & 8-in. planting depth, installed by local contractors

www.tournesolsiteworks.com  
800.542.2282



AIA Booth # 228

SNAP 173

## LANDSCAPING, SITEWORK

## LANDSCAPE EDGING

\$\$\$ | G

## Sure-loc Aluminum Landscape Edging

▲ Sure-loc Edging manufactures professional grade aluminum landscaping edging, creating crisp lines.

## Product Application:

- IBM Computers Headquarters, USA
- Ritz-Carlton Hotel, Pasadena, CA
- Lincoln Park, Chicago, IL

## Performance Data:

- Dual Stake locking system provides seamless connections.
- End stake adapters allow for staking at any point.

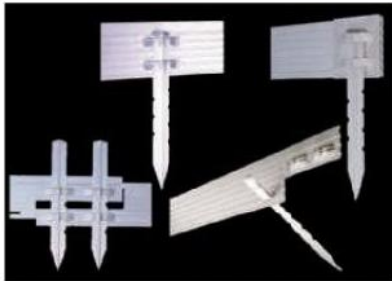

www.surelocedging.com  
800.SURE.LOC

Contact: Karl Nieboer

SNAP 174

## LANDSCAPING, SITEWORK

## THREE DIMENSIONAL MODULAR TRELLIS

G

## greenscreen

▲ Use for green walls, freestanding fences, enclosures, and landscape elements.

## Product Application:

- U.S. Census Bureau parking structures, Suitland, MD
- Valley Metro light rail, Phoenix, AZ
- Anthropologie, Corona, CA

## Performance Data:

- Recycled content steel
- Complete system of attachment hardware



www.greenscreen.com  
310.837.0526

Contact: sales@greenscreen.com

AIA Booth # 5159

SNAP 175

## MATERIALS

## ARCHITECTURAL NATURAL STONE

\$\$\$ | G

## Vermont Structural Slate Company

▲ Quarry and fabricator offering select slates, quartzites, sandstones, limestones, marbles, granites and basalts

## Product Application:

- Duffield Hall, Cornell University
- Architect: Zimmer Gunsul Frasca Architects
- Unfading Green Slate flooring, stairs and wall cladding; natural cleft finish



www.vermontstructuralslate.com  
802.265.4933

Contact: Craig Markcrow

SNAP 176

## MATERIALS

## FIBERGLASS-FACED GYPSUM SHAFTLINER

## Temple-Inland

▲ GreenGlass® Liner Panels from Temple-Inland® deliver the superior mold and moisture resistance of fiberglass facers plus an unmatched 90% recycled content that can contribute valuable credits in environmental rating systems such as LEED and the NAHB National Green Building Standard. Plus, GreenGlass liner panels are U.L. approved for use in multiple 2-hour shaft and area separation wall assemblies and are available in a 2-ft. width, 1-in. thickness and lengths of 8 ft., 10 ft. and 12 ft.



www.GreenGlassInfo.com  
800.231.6060

SNAP 177

## MATERIALS

## FIRE-RATED VERSION

G | NEW

## Technical Glass Products

▲ Technical Glass Products offers a valuable course for AIA HSW credit: "Burning Issues: Understanding Today's Fire-Rated Glass and Framing."

## Products featured:

- FireLite® family of fire-rated glass ceramics
- Pilkington Pyrostop™ safety-rated glass firewalls

## Also contains:

- New trends in fire-rated glazing materials
- Project assessment and liability issues
- Recent code changes and how they impact design

www.fireglass.com  
800.427.0279



SNAP 178

## MATERIALS

## STAINLESS SHEETS &amp; TILES

\$\$ | G

## Millennium Tiles LLC

▲ Stainless sheets or tiles from Millennium Tiles LLC in various colors ensure elegance that endures.

## Performance Data:

- Whether you cover walls or roofs, you can be sure that color will not fade for the life of the stainless.
- Design limits are set only by your imagination.



www.millenniumtiles.com  
262.723.7778

Contact: Walter Hauk

AIA Booth #6559

SNAP 179

## MATERIALS

## CAST GLASS

\$\$\$ | G | NEW

## Nathan Allan Glass Studios Inc.

▲ Named after the way each piece is stacked then fused together, Stax Series offers an ingenious way to create exterior feature walls over very large surfaces. The front face of the pattern ripples in varying thickness, to create a dazzling effect. Patterns: Beamz, Breez, and Flex. Options: Clear, Colored, and Mirrored.

## Product Application:

- Simon Restaurant & Lounge, Palms Hotel, Las Vegas, NV
- Cladding, fascia, feature walls

www.nathanallan.com  
604.277.8533, ext. 225

Contact: Barry Allan, Director  
on sweets.com



SNAP 180

## MATERIALS

## WIRE MESH SYSTEMS

\$\$\$ | G

## The Gage Corporation, Int.

▲ GageWoven is an innovative collection of 23 architectural wire mesh designs.

## Product Application:

- Rusnak BMW Dealership, Thousand Oaks, CA
- State Street Bank, North Quincy, MA
- 217 17th St., Atlantic Station, Atlanta, GA

## Performance Data:

- Class A ASTM E-84
- Durable, low-maintenance stainless steel

www.gagecorp.net  
800.786.4243, 608.269.7447

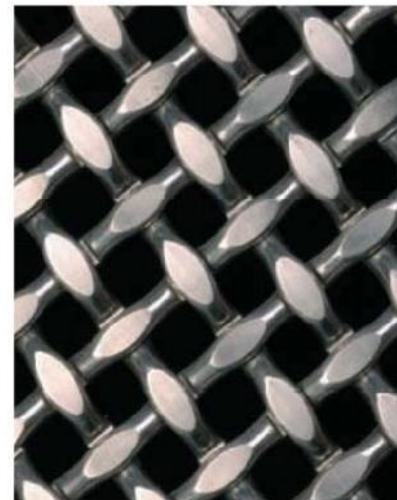

SNAP 181

## MECHANICAL SYSTEMS, HVAC, PLUMBING

## SOLAR HOT WATER

WR | G

## HELIODYNE Solar Hot Water

▲ Heliodyne, Solar Hot Water since 1976. Innovative design, superb product lines. Made in the USA.

## Product Application:

- Commercial: Fenway Park, Boston, MA
- Commercial: Stanford University, Palo Alto, CA
- Single family to residential developments

## Performance Data:

- Collectors with sleek design and outstanding durability
- Unique plug & play components for ease of installation

www.heliodyne.com  
888.878.8750

Contact: Alexandra Wexler



ASES Booth # 1007

SNAP 182

## ROOFING, SIDING, THERMAL &amp; MOISTURE PROTECTION

## METAL WALL &amp; ROOF SYSTEMS

G

## Fabral

▲ Fabral's product line is architecturally appealing and consistent with green building guidelines.

## Product Application:

- Kress Center, University of WI, Green Bay, WI (pictured)
- Lynx Regional Center, Orlando, FL
- Coleman Park, Nashville, TN

## Performance Data:

- Many panels can be tapered or curved and are available unpainted or finished with high performance Flurobond™ coating.
- Finish and weather tightness warranties available

www.fabral.com  
800.477.7796  
Contact: Donna Berryhill  
on sweets.com



AIA Booth # 3959

SNAP 183

## ROOFING, SIDING, THERMAL &amp; MOISTURE PROTECTION

## STRUCTURAL WALL PANEL

WR

## ATAS International, Inc.

▲ Rigid-Wall™ is a structural concealed fastened wall panel that offers dramatic shadow lines created by ribs.

## Product Application:

- Cream St. Condos, Charlottesville, VA
- Penn College of Technology, Williamsport, PA
- Tidewater Community College Chesapeake, VA

## Performance Data:

- 16 wide by 7/8 deep 1 5/8 wide rib
- Installed vertically or horizontally

www.atas.com  
800.468.1441  
Contact: info@atas.com  
on sweets.com



SNAP 184

## ROOFING, SIDING, THERMAL &amp; MOISTURE PROTECTION

## ARCHITECTURAL TERRA COTTA RAINSCREEN SYSTEMS

WR | G

## Boston Valley Terra Cotta

▲ TerraClad is a natural terra cotta product formed into a high-performance ceramic rainscreen panel.

## Product Application:

- Arizona Disability Service Campus, Phoenix, AZ
- Betchler Museum, Charlotte, NC
- Colburn School of Performing Arts, Los Angeles, CA

## Performance Data:

- LEED points for recycled content & regional material use
- Designed to withstand the freeze-thaw climates

www.bostonvalley.com  
888.214.3655  
Contact: Gretchen Krouse



AIA Booth # 5246

SNAP 185

## ROOFING, SIDING, THERMAL &amp; MOISTURE PROTECTION

## UP-TO-THE-MINUTE GREEN INFO

NC | G | NEW

## Petersen Aluminum Corporation

▲ For the most up-to-date information in green metal roofing design, bookmark [pacgreeninfo.com](http://pacgreeninfo.com).

## Product Application:

- Green incentives for metal roofing applications
- Commercial
- Residential

## Performance Data:

- LEED, EnergyStar, Cool Roof Rating Council
- Federal legislation and more



[www.pac-clad.com](http://www.pac-clad.com)  
800.PAC.CLAD

Contact: Blake Batkoff  
on [sweets.com](http://sweets.com)

AIA Booth # 6735

SNAP 186

## SPECIALTY PRODUCTS

## PERFECT FOR GATED COMMUNITIES

## FAAC International, Inc.

▲ FAAC is the world's largest specialized manufacturer of operators for swing, slide and barrier gate systems. The Model 400 heavy-duty hydraulic swing gate operator is UL 325 compliant and designed for applications needing maximum versatility, such as subdivisions and apartments. Its power and reliability also make it ideal for large, ornate gates.



800.221.8278  
[www.faacusa.com](http://www.faacusa.com)

SNAP 187

## SPECIALTY PRODUCTS

## COLUMNS, BALUSTRADES &amp; CORNICES

## Architectural Columns &amp; Balustrades by Melton Classics

▲ Melton Classics provides the design professional with an extensive palate of architectural columns, balustrades, cornices, and millwork. They invite you to call their experienced product specialists to assist you with the ideal products for your design, application and budget. Columns are available in fiberglass, synthetic stone, GFRC and wood. Their 80 plus durable maintenance free balustrades feel substantial yet have reduced weight. Also, ask about their low maintenance fiberglass and polyurethane cornices and millwork.



[www.MeltonClassics.com](http://www.MeltonClassics.com)  
800.963.3060

Contact: Mike Grimmert  
on [sweets.com](http://sweets.com)

SNAP 188

## SPECIALTY PRODUCTS

## COPPER CHIMNEY POTS

\$\$\$ | G

## European Copper

▲ UL-listed, 100% recyclable chimney pots fit all leading fireplace systems.

## Product Application:

- Utica Place, Tulsa, OK
- Cacia Hall Preparatory School, Tulsa, OK
- Private residence, Tulsa, OK

## Performance Data:

- UL-listed for both masonry and pre-engineered fireplaces
- Certified by OMNI Testing Laboratories



[europeancopperchimneypts.com](http://europeancopperchimneypts.com)  
800.391.0014

Contact: Pat Keegan

SNAP 189

## SPECIALTY PRODUCTS

## CREATIVE SIGNAGE

## Dale Travis Associates, Inc.

▲ Founded in 1969, Dale Travis Associates, Inc., a creative signage company, caters to architects, designers, and corporate facility managers nationwide.

## Product Application:

- The Folk Art Museum, New York, NY
- All 550 offices of UBS around the country
- Hayden Planetarium, New York, NY

## Performance Data:

- Installation available in all states and territories
- Pictured: Morgan Library, gold leaf and oxidized bronzed letters

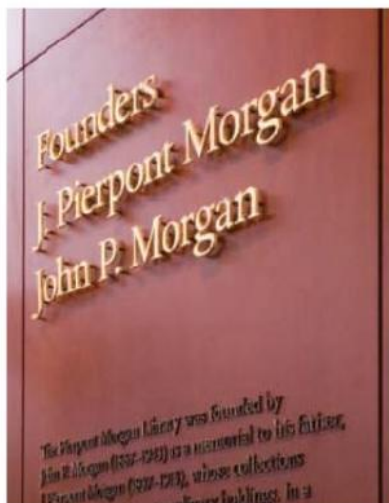

[www.daletravis.com](http://www.daletravis.com)  
212.243.8373

SNAP 190

## SPECIALTY PRODUCTS

## FULL COLOR LED TICKER

\$\$\$ | NEW

## Sunrise Systems, Inc.

▲ Custom LED displays that fit into any architectural setting or design

## Product Application:

- Rockefeller Plaza, New York, NY
- Lucas Oil Stadium, Huntington Bank, two round overhead tickers, Indianapolis, IN

## Performance Data:

- Multiple character heights, colors, configurations and extendable lengths
- Custom controllers and software applications



[www.sunrisesystems.com](http://www.sunrisesystems.com)  
781.826.9706

Contact: Henry Appleton  
on [sweets.com](http://sweets.com)

SEGD Booth # 407

SNAP 191

## SPECIALTY PRODUCTS

## INFECTION CONTROL DISPENSER

WR | G | NEW

## APCO Signs

▲ HealthView Dispenser is designed for infection control products including wipes, hand foam, tissues, and masks.

## Product Application:

- Chevron Corporate, Concord, CA
- Prentice Women's Hospital, Chicago, IL

## Performance Data:

- Pre-engineered aluminum components
- Wall, stanchion, or kiosk mounting



AIA Booth # 3933

SNAP 192

www.apcosigns.com  
404.688.9000  
on sweets.com

## SPECIALTY PRODUCTS

## SAUNAS

WR

## Finlandia Sauna Products, Inc.

▲ They manufacture authentic saunas, no infrareds. They offer precut packages, modular rooms and heaters.

## Product Application:

- Any available space
- Residential or commercial
- New construction or remodeling

## Performance Data:

- Uses 1-in. x 4-in. paneling
- Markets four all-clear western softwoods



SNAP 193

www.finlandiasauna.com  
800.354.3342

Contact: Tim Atkinson or Reino Tarkiainen  
on sweets.com

## SPECIALTY PRODUCTS

## STAINLESS STEEL CABLE SYSTEMS

\$

## Hayn Lines

▲ From the contemporary look of stainless steel, glass, or chrome, to the warm look of wood or brass, Hayn Lines will accent any decor. Marine tested and approved with a 45-year reputation for quality, delivery, pricing, and customer support, Hayn is now a top choice for architects.



AIA Booth # 5044

SNAP 194

www.haynlines.com  
800.346.4296  
Contact: Tom Branday

## SPECIALTY PRODUCTS

## STAIR TREAD SOLUTIONS

## Musson Rubber

▲ Take a few steps into Musson's new catalog and find out more about solid heavy-duty rubber or aluminum stair treads for interior and exterior use. They illustrate "designed for safety" stair coverings such as fire-safety, grit-strip, visually-impaired and glo-strip with matching floor systems that include raised design disco, low disc, square and diamond tiles. All are displayed in their expanded color line with related accessories.



SNAP 195

www.mussonrubber.com  
800.321.2381  
on sweets.com

## SPECIALTY PRODUCTS

## HIGH-SPEED HAND DRYERS

\$ | G

## Excel Dryer Inc.

▲ XLERATOR high-speed energy-efficient hand dryer

## Product Application:

- NFL headquarters, New York, NY
- USGBC LEED Platinum headquarters, Washington DC
- LA Dodgers Stadium, Los Angeles, CA

## Performance Data:

- 3 times faster—completely dries hands in 10 seconds
- Uses 80% less energy than conventional dryers



AIA Booth # 6427

SNAP 196

www.exceldryer.com  
800.255.9235  
Contact: William Gagnon  
on sweets.com

## SPECIALTY PRODUCTS

## HAND DRYER | CATALOG

G

## Dyson B2B, Inc.

▲ Dyson's technology makes the Dyson Airblade™ hand dryer faster and more hygienic than any other.

**Products featured:** The Dyson Airblade™ hand dryer uses up to 80% less energy than warm air hand dryers.

## Also contains:

- Qualifies for LEED credits
- CAD, Revit and Sketch-up drawings

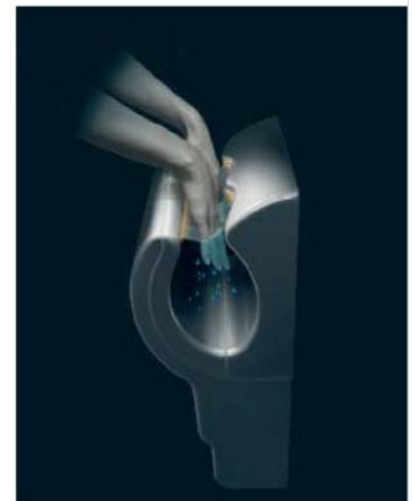

AIA Booth #2351

SNAP 197

www.dysonairblade.com  
888.DYSON.AB  
Contact: Anita David  
on sweets.com

## POSITIONS VACANT

VICE PRESIDENT  
ADMINISTRATION/OPERATIONS

Medium size architectural firm seeks aggressive individual to manage day to day operations, 10-15 years senior management experience, licensed architect, leadership and strategic planning skills, business mindset. Competitive salary & benefits with stock options. Send resume and references to: P.O. Box 52421, Knoxville, Tennessee 37950-2421

## MAGNET FOR TALENT

JR Walters Resources, premier A/E/C recruiting firm, can help you grow your company and your career. Review current opportunities at [www.jrwalters.com](http://www.jrwalters.com) or call 269-925-3940

## WWW.SMPSCAREERCENTER.ORG

Find marketing/BD professionals with A/E/C experience. Call 800-292-7677, ext. 231.

## BUSINESS OPPORTUNITIES

CONFIDENTIAL CLEARINGHOUSE FOR  
MERGERS & ACQUISITIONS

Strogoff Consulting offers confidential introductions between prospective buyers and sellers, develops valuations and guides firms through the acquisition/merger process. As a strategic advisor to firms throughout the U.S., Michael Strogoff, AIA, has an extensive network of contacts and an insider's knowledge of the architectural industry. Firms are introduced to each other only when there is a shared vision and a strong strategic and cultural fit. Contact Michael Strogoff, AIA, at 866.272.4364 or visit [www.StrogoffConsulting.com](http://www.StrogoffConsulting.com). All discussions held in strict confidence.

## PROFESSIONAL SERVICES

Want More Projects?  
Firm Owners Only  
Call 1-888-598-4874 Ext.193

Want More Projects?  
Firm Owners Only  
Call 1-888-598-4874 Ext.193

Connect with more than 310,000  
architectural professionals & potential candidates

Employers, recruiters, colleges and universities look to our Career Center for recruiting solutions

Promote your firm as a great place to work

Recruit top faculty for your college or university

Use our Classified Advertising section to promote your product or service

Promote to categories including official proposals, software, special services, seminars/training & business opportunities

Targeted coverage of owners, engineers, specialty consultants, design team members and international professionals

To obtain information or to reserve space contact:

## RECRUITMENT ADVERTISING

Diane Soister at Tel: 212-904-2021/Fax: 212-904-2074 Email: [diane\\_soister@mcgraw-hill.com](mailto:diane_soister@mcgraw-hill.com)

Brian Monteleone at Tel: 609-426-5283/Fax: 212-904-2074 Email: [brian\\_monteleone@mcgraw-hill.com](mailto:brian_monteleone@mcgraw-hill.com)

## CLASSIFIED ADVERTISING

Brian Sack at Tel: 609-426-7403/Fax: 609-371-4401 Email: [brian\\_sack@mcgraw-hill.com](mailto:brian_sack@mcgraw-hill.com)

Gilda Falso at Tel: 212-904-2422/Fax: 609-371-4401 Email: [gilda\\_falso@mcgraw-hill.com](mailto:gilda_falso@mcgraw-hill.com)

McGraw Hill  
CONSTRUCTION

Find us online at [www.construction.com](http://www.construction.com)

The McGraw-Hill Companies



BOSTON  
ARCHITECTURAL  
COLLEGE

Architecture  
Interior Design  
Landscape Architecture  
Design Studies

Continuing Education  
Online Education

9 AM 1 PM 4 PM 7 PM 10 PM

Day and Night. A learning laboratory for design education.



320 Newbury Street Boston MA 02115  
[www.the-bac.edu](http://www.the-bac.edu) (617) 585-0123









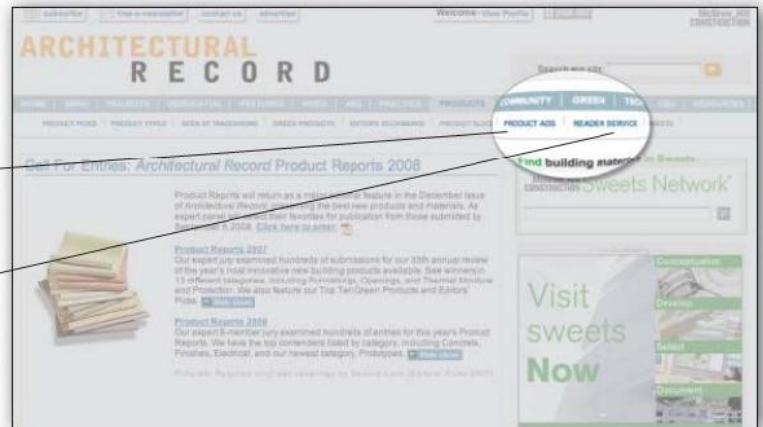











from our advertisers! Fill out this Reader Service Card and send back today or go to [ArchRecord.com](http://ArchRecord.com) > Products tab > Reader Service



## Check out these resources

- To access PDFs of all full-page or larger ads appearing in print magazine, Go to...  
**ArchRecord.com > Products tab > Product Ads**
- For information from advertisers, fill out the Reader Service Card or, Go to...  
**ArchRecord.com > Products tab > Reader Service**
-  For detailed product information, Go to **sweets.com**



Reader Service #	Advertiser	Page	Reader Service #	Advertiser	Page	Reader Service #	Advertiser	Page
84	Acams Rite Manufacturing Co <i>adamsrite.com</i>	203	97	Boyd Lighting <i>lightspacebyboyd.com</i>	227	69	 EFCO Corporation <i>efcocorp.com</i>	141
11	 AGC Flat Glass N.A. <i>na.agc-flatglass.com/matelux</i>	16-17	31	Building Green	259	15	EIMA Association <i>eima.com</i>	28
	AIA <i>aia.org</i>	192,228 258	58	 Carolina Ceramics Brick Company <i>carolinaceramics.com</i>	100	92	elliptipar <i>elliptipar.com</i>	217
37	 Alcan Composites USA Inc <i>alucobond.com</i>	62	101	Cascade Coil Drapery <i>cascapecoil.com</i>	230	22,23	 Ellison Bronze <i>ellisonbronz.com</i>	40,41
36	ALPOLIC/Mitsubishi Chemical FP America Inc <i>alpolic-usa.com</i>	60-61	19	 CENTRIA Architectural Systems <i>centria.com</i>	37	40	ELMES <i>elmesworld.com</i>	66
91	American Arbitration Association <i>adr.org</i>	213	68	 CertainTeed <i>certainteed.com</i>	139	103	Engineered Lighting Products <i>elplighting.com</i>	231
102	American Slate <i>americanslate.com/slant</i>	231	60	 CertainTeed Gypsum <i>certainteed.com</i>	102	25	 EPIC Metals Corporation <i>epicmetals.com</i>	43
106	Architects & Engineers for 9/11 Truth Inc.	232	112	Charles Loomis <i>charlesloomis.com</i>	238	144	Eventscape <i>eventscape.net</i>	235
7	Architectural Precast Association <i>archprecast.org</i>	8-9	6,131	 Construction Specialties <i>c-sgroup.com/3000</i>	7,21	96	 FairWeather <i>fairweatherfs.com</i>	225
1	 Armstrong <i>armstrong.com</i>	cov2-1	82	 CR Laurence Co Inc <i>crlaurence.com</i>	197	30	Fiberweb Inc <i>typar.com</i>	48
38	B-K Lighting <i>bklighting.com</i>	64	98	 Custom Building Products <i>custombuildingproducts.com</i>	229	87	Forestry Innovation Investment	208
107	Bear Creek Lumber <i>bearcreeklumber.com</i>	237	109	Delray Lighting Incorporated <i>delraylighting.com</i>	237	120	GDK Metal Fabrics <i>gkdmetalfabrics.com</i>	259
149	BEGA <i>bega-us.com</i>	57	127,128	 Doralco <i>doralco.com</i>	111,113	39	 Glen Raven <i>glenraven.com</i>	65
88	Belgard <i>belgard.biz</i>	209	86	Dornbracht <i>dornbracht.com</i>	207	89	Gordon Inc <i>gordonceilings.com</i>	211
13	Benjamin Moore <i>benjaminmoore.com</i>	24	100,105	Doug Mockett & Company Inc <i>mockett.com</i>	230,232	129	 Guardian SunGuard <i>sunguardglass.com</i>	119
33	 Bobrick <i>bobrick.com</i>	53	41	 Dyson Airblade <i>dysonairblade.com</i>	68	3	 HDI Railing Systems <i>hdirailings.com</i>	4
110,118	Boston Architectural College <i>the-bac.edu</i>	238,251	61	 E Dillon & Company <i>edillon.com</i>	85	119	Hendrick Manufacturing <i>hendrickmfg.com</i>	256

To access PDFs of all full-page or larger ads appearing in this issue, go to [ArchRecord.com](http://ArchRecord.com) > Products tab > Product Ads

 Get more info at [www.sweets.com](http://www.sweets.com)

# Get Free Information

from our advertisers! Fill out this Reader Service Card and send back today  
or go to [ArchRecord.com](http://ArchRecord.com) > Products tab > Reader Service

# Advertisers Index

Reader Service #	Advertiser	Page	Reader Service #	Advertiser	Page	Reader Service #	Advertiser	Page
113	HEWI <i>hafele.com</i>	239	124	Modern Fan Co, The <i>modernfan.com</i>	257	42	§ Sherwin-Williams <i>sherwin-williams.com</i>	69
90	HSBC	212	50	§ Nana Wall Systems Inc <i>nanawall.com</i>	87	99	Simpson Strong-Tie Company Inc <i>simpsonstrongwall.com</i>	230
145	Hunter Douglas Contract <i>nysan.com</i>	23		National Building Museum <i>nbm.org</i>	196		Skyscraper Museum, The <i>skyscraper.org</i>	241
49	Index-D <i>index-d.com</i>	76	78	§ National Gypsum Company <i>nationalgypsum.com</i>	158	45	§ Smoke Guard <i>smokeguard.com</i>	72
104	International Code Council <i>iccsafe.org</i>	232	46	§ National Terrazzo & Mosaic Assn <i>ntma.com</i>	73	116	Steel Joist Institute <i>steeljoist.org</i>	242
108	§ Invisible Structures Inc <i>invisiblestructures.com</i>	237	114	Nawkaw <i>nawkaw.com</i>	240	115	Sustainable Forestry Initiative <i>aboutsfi.org</i>	241
51-54	Italian Trade Commission <i>cosmit.it</i>	93-96	75	NCARB <i>ncarb.org</i>	154	4	Technical Glass Products <i>fireglass.com</i>	5
95	Ivalo Lighting Incorporated <i>ivalolighting.com</i>	222	55	NJ SmartStart Buildings <i>njsmartstartbuildings.com</i>	97	26	Temple-Inlard <i>greenglassinfo.com</i>	44
76	Julius Blum & Co Inc <i>juliusblum.com</i>	155	2	§ Oldcastle Glass® <i>oldcastleglass.com</i>	2-3	12	§ ThyssenKrupp Elevator Corporation <i>seewhatwebuilt.com</i>	18
64	§ Kawneer Company Inc <i>kawneer.com</i>	131	14	§ Oldcastle Glass® /Skywall® <i>oldcastleglass.com</i>	27	32	Timely <i>timelyframes/ar.com</i>	50
77	Kebony <i>kebony.us.com</i>	157	83	§ Pella Windows & Doors <i>pellacommercial.com</i>	198	27	TOTO <i>totousa.com</i>	45
	Kim Lighting <i>kimlighting.com</i>	33	65	§ Pilkington <i>pilkington.com</i>	133	16	Travelers Companies Inc, The <i>stpaultravlers.com</i>	31
67	§ Kingspan Insulated Panels <i>kingspan.com</i>	137	62	§ Pittsburgh Corning <i>pittsburghcorning.com</i>	127	56	Trespa <i>trespanorthamerica.com</i>	98
66	Kohler <i>kohler.com</i>	135	8,35	§ PPG <i>ppgideascaopes.com</i>	10-11, 58	73	§ Trimco <i>trimcobbw.com</i>	152
63	Kolbe & Kolbe Millwork Co Inc <i>kolbe-kolbe.com</i>	129	94	Prudential Lighting <i>prulite.com</i>	221	81	US Green Building Council <i>usgbc.org</i>	195
74	Kullman <i>kullman.com</i>	153	122	§ Rakks <i>rakks.com</i>	257	72	Virco <i>virco.com</i>	151
5	landscapeforms <i>landscapeforms.com</i>	6	123	Rejuvenation Inc <i>rejuvenation.com</i>	257	70	§ VT Industries <i>vtindustries.com</i>	149
93	LEDtronics Inc <i>ledtronics.com</i>	218	48	RHEINZINK <i>rheinzink.com</i>	75	125	WAC Lighting <i>waclighting.com</i>	cov3
126	Lutron <i>lutron.com</i>	cov4	47	Robinson Brick Company <i>robinsonbrick.com</i>	74	117	§ Wagner <i>wagnercompanies.com</i>	242
79	Madison Industries <i>madisonind.com</i>	191	57	Rocky Mountain Hardware <i>rockymountainhardware.com</i>	99	59	Walter P. Moore <i>walterpmoore.com</i>	101
111	Manning Lighting <i>manningltg.com</i>	238	43	Roof Products Inc <i>rpcurbs.com</i>	70	80	§ Wausau Tile <i>wausautie.com</i>	193
20,21	Marvin Windows & Doors <i>marvin.com</i>	38,39	10	Rulon Company <i>rulonco.com</i>	14-15	85	§ Western Red Cedar Lumber Association <i>realcedar.org</i>	205
	McGraw-Hill Construction <i>construction.com</i>	156,194 212,229 256,259	44	§ SAFTI/O'Kcoffes Inc <i>safti.com</i>	71		World Architecture Festival <i>worldarchitecturefestival.com</i>	210
121	§ McNichols Co <i>mcnichols.com</i>	256	29	SageGlass <i>sage-ec.com</i>	47	71	§ Xypex <i>xypex.com</i>	150
24	§ MechoShade Systems Inc <i>mechoshade.com</i>	42	28	§ Samsung Staron Surfaces <i>getstaron.com</i>	46	130	§ Zero International <i>zerointernational.com</i>	121
9	§ Mitsubishi Electric <i>transforminghvac.com</i>	12-13		School Building Expo <i>schoolbuildingexpo.com</i>	254			
			18,34	Schott Corporation <i>us.schott.com</i>	35,54			





## The Event for People Who Design and Build Great Schools and Colleges

### For people who design and build schools and colleges:

- Architects, designers and other design professionals who create educational facilities
- School district facilities planners and construction directors at K-12 public, private and charter schools
- College and university campus planners, directors of development, construction, facilities, and architecture

### Explore new techniques and trends in school design:

- Green Design and Sustainability
- The Business of Building Schools
- College and Higher Education Facilities
- Design for Education
- Technical Issues in School Construction

Register early and SAVE up to \$400

# SCHOOL BUILDING EXPO

June 2-4, 2009  
David L. Lawrence  
Convention Center  
Pittsburgh, PA

[www.schoolbuildingexpo.com](http://www.schoolbuildingexpo.com)

School Building Expo is the only event that truly brings together today's evolving Educational Institution marketplace. Learn about new trends, be inspired by exciting keynotes and discover the latest products and solutions. Come together with the decision makers and purchasers who plan, design, construct and maintain the public & private educational facilities of tomorrow. School Building Expo is host to the Spring meeting of AIA's Committee on Architecture for Education, a gathering of the most active thought leaders in educational facilities design.

In conjunction with



**AIA MEMBERS:** Earn up to 16 of your 18 annually required CEUs in just 3 days at School Building Expo!



### MEDIA & ASSOCIATION PARTNERS



For info on exhibits and sponsorships, please contact Nancy Jo Wiggin at 203.371.6322 or [nj@jdevents.com](mailto:nj@jdevents.com)

CALL FOR ENTRIES

ARCHITECTURAL  
RECORD

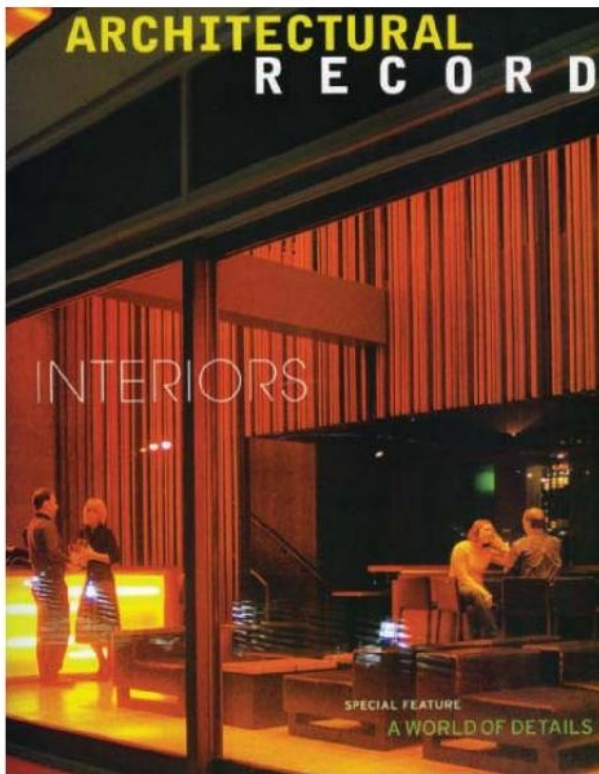

The editors of ARCHITECTURAL RECORD announce the **2009 Record Interiors** awards program. Entry is open to any architect registered in the U.S. or abroad. Projects must have been completed within the past 18 months, built, and interiors-only—not part of a new building by the firm submitting the entry. Of particular interest are interior projects that incorporate innovation in program, building technology, form, sustainability and/or materials. The fee is \$65 per submission.

# 2009 Record Interiors

For instructions and to download the entry form visit [architecturalrecord.com/call4entries](http://architecturalrecord.com/call4entries). Submissions must be postmarked no later than May 29, 2009.

## Good Design is Good Business

The editors of BusinessWeek and Architectural Record invite you to enter the **2009 BusinessWeek/Architectural Record Awards**

Good design is good for business. That's why this distinguished award recognizes and rewards exceptionally designed work that makes a significant contribution to the business aspirations of a company or institution – backed by measurable results.

2009 Award recipients will be featured in BusinessWeek and Architectural Record magazines, read by over 5 million business and design professionals.

For more information and an entry form, go to [archrecord.construction.com/features/bwarAwards/](http://archrecord.construction.com/features/bwarAwards/).

Entries must be postmarked no later than **May 15, 2009**.

ARCHITECTURAL  
RECORD

BusinessWeek

The McGraw-Hill Companies

# Dramatic Dual Solution

A dramatic mural of **McNICHOLS®** Perforated Metal catches eyes for the Mercy Medical Center's parking garage in Baltimore, Maryland.

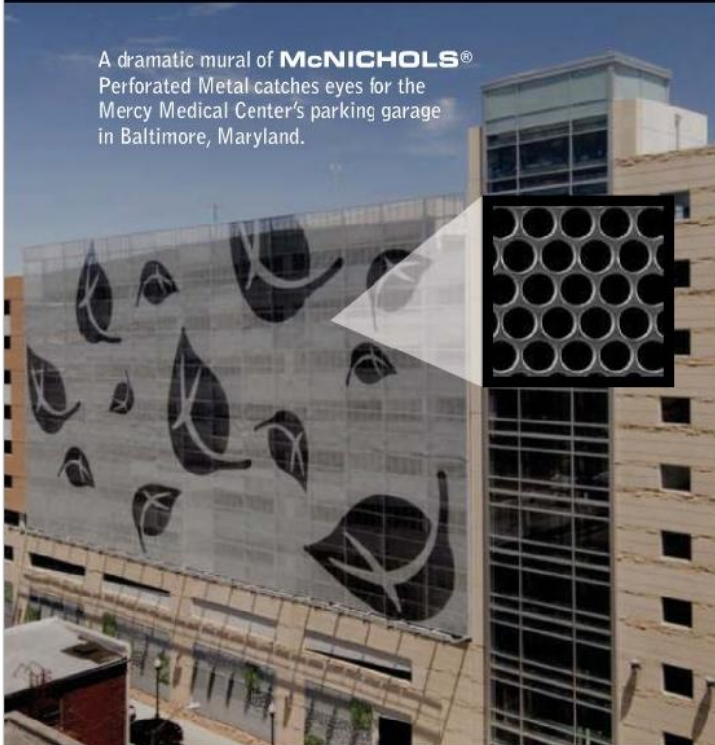

The street level of the garage also utilized the hospital leaf logo. Both Perforated and Wire Mesh panels provided security, visibility and ventilation.

**The  
Hole  
Story**

**McNICHOLS®**  
Designer Metals  
www.mcnichols.com • 1-800-237-3820

CIRCLE 121

**Custom & Standard Sunshade Systems**

**Hendrick**  
Solutions for Perforated & Fabricated Metal  
www.hendrickmfg.com sales@hendrickmfg.com p. 800-225-7373

CIRCLE 119

**McGraw Hill  
CONSTRUCTION**

Visit us at AIA at Booth N4447

## The Essentials Of Designing Green

**Get Smarter** with SmartMarket Reports

**Be Inspired** By GreenSource

**Find Green Products** at Sweets

**Interact** at greensourcemag.com

McGraw-Hill Construction

SGBBMHCG1008

www.construction.com

The McGraw-Hill Companies

© Al Teufen



*Rakks wall-mounted shelving at Sweet & Associates Modern Furnishings, Cleveland, OH  
Fixture Design: Christopher Hixson*

### SUPPORTING MODERN DESIGN



We play a supporting role in state-of-the-art interiors from coast to coast. With strong, innovative shelving systems that meet the demands of the world's top designers. Rakks. New and exciting solutions for shelving. Visit us at [www.rakks.com](http://www.rakks.com), or call for a catalog.

**Rakks®**

In supporting roles everywhere

Rangine Corporation | 330 Reservoir Street | Needham, MA 02494 | 800-826-6006 | [www.rakks.com](http://www.rakks.com)

CIRCLE 122

Consciously cool.  
[modernfan.com](http://modernfan.com)



### GO BACK IN TIME.

Experience the timeless craftsmanship of an earlier age with a modern twist. Rejuvenation offers a wide variety of early to mid-twentieth century light fixtures, many of which are now Compact Fluorescent compatible. Now you'll be able to meet environmental building standards without sacrificing period authenticity.



TAKE ENERGY EFFICIENT BULBS WITH YOU.

**REJUVENATION**

888-401-1900 Manufacturer of period-authentic lighting [rejuvenation.com](http://rejuvenation.com)

CIRCLE 123



**THE MODERN FAN CO**  
A Collection of Ceiling Fans  
Designed by Ron Rezek

CIRCLE 124



WHAT'S MISSING?

**Don't pass up a single opportunity.**

Is something missing from your AIA membership? In addition to a vast architect-oriented network of resources, AIA Advantage offers exclusive discounts on products and services to operate your business more effectively. From financial services and shipping, to travel and technology—use your membership to your best advantage.

[www.aia.org/advantage](http://www.aia.org/advantage)

Bank of America | Dell | FedEx | Hertz | MasterSpec | UPS



THE AMERICAN  
INSTITUTE  
OF ARCHITECTS



**AIA Advantage**  
What's your Advantage?



# SNAP™

Need product info?  
Get it in a SNAP.



**SNAP™, the product tabloid from McGraw-Hill Construction Sweets—the absolute authority on architectural products.**

SNAP reaches over 65,000 architects—every active architectural firm operating nationally and locally. Twice as many architects as any other product tabloid in the field.

**Putting products first to drive action fast.**

SNAP is designed to find and select products in a snap!

**Visit us at Booth N447 at AIA.**

McGraw-Hill  
CONSTRUCTION **SNAP**

[www.sweets.com](http://www.sweets.com)

The McGraw-Hill Companies

## Be Smart About Green.

*"As the sustainable design community grows both in ranks and sophistication, [BuildingGreen] stays out ahead showing the way. You are irreplaceable!"*

— Russell Perry, AIA  
Principal, SmithGroup



### Start With a Reliable Resource.

BuildingGreen has been providing honest, useful, essential green building information to design professionals since 1985.

**Environmental Building News™**  
**BuildingGreen Suite™**  
**GreenSpec® Directory**

Our publications will keep you informed and help you identify and understand the green building practices and strategies you need to succeed as an informed green building professional.

Learn more at  
[www.BuildingGreen.com](http://www.BuildingGreen.com)  
800-861-0954



Woven wire mesh in stainless steel, bronze, copper and aluminum for exterior and interior applications.

See us at the AIA Convention, Booth 4271.

**GKDMETALFABRICS**  
[www.gkdmetalfabrics.com](http://www.gkdmetalfabrics.com)



Mediamesh® at the Piazza Duomo, Milan, with programmable, embedded LEDs.

# Reader's Gallery

To share images in our galleries, visit [architecturalrecord.com](http://architecturalrecord.com) and click on Community.



**Lynn Wang** shot this photograph of Daniel Libeskind's Contemporary Jewish Museum in San Francisco and shared it in our online galleries. A Bay Area resident who studied architecture but now works in finance, Wang regularly walks past the museum. She paused to capture this image because she was struck by the ability of the figure in the foreground to recast a building that she has come to know well since its completion. "The sight of humans is what makes the design real," she says.



W2 ARCHITECTURAL  
LIGHTING

A DIVISION OF WAC

# INTRODUCING VAMP™ LED TRACK LUMINAIRES

The New VAMP™ LED track luminaires are crafted in our company owned, zero landfill manufacturing campus with inhouse UL certified labs.



## KEY FEATURES

- ▶ Strong light output
- ▶ Heavy duty die cast aluminum construction with no visible heat sink
- ▶ Lockable 350° horizontal rotation
- ▶ 90° vertical tilt for precision aiming
- ▶ Accommodates up to 3 filter mediums
- ▶ Single and two circuit track mounting
- ▶ Beam angles of 10° and 25° available
- ▶ Warm 3000k and Cool 4500k color options
- ▶ Painted Platinum, Black and White powder coat finishes
- ▶ Junction temperature below rating guidelines
- ▶ Potential 50,000 hour LED life
- ▶ Available in 9w, 18w and 30w models
- ▶ Compatible with our 120v track systems

Visit us at Lightfair, Booth 2046

Visit [www.W2lighting.com](http://www.W2lighting.com) or give us a call at 866.788.2100

CIRCLE 125



“We designed our building to use 1.28 watts per square foot of lighting power. With Quantum™, it’s using only 0.38 — that’s 70% less.”



Glenn Hughes  
Director of Construction for The New York Times Company during design, installation, and commissioning of The New York Times Building



© Photo by Nic Lehoux



© Photo by Brian Rose

**the problem:**

more electricity is used for lighting than any other building system\*

**the solution:**

manage light with Quantum

**the strategies:**

- light level tuning
- daylight harvesting
- occupancy sensing

**the details:**

[www.lutron.com/nyt](http://www.lutron.com/nyt)

**the results:**

- **70%** lighting energy saved
- **\$315,100** saved per year
- **1,250** metric tons of CO<sub>2</sub> emissions prevented each year

Introducing Quantum, the total light management system that The New York Times Building uses to save energy while improving the comfort and productivity of the people inside. Call **1.866.299.2073** to find out how Quantum can enhance your building.

save energy with Lutron™ 

 **LUTRON**®

© 2008 Lutron Electronics Co., Inc.

\* Source: U.S. Energy Information Administration