

ARCHITECTURAL RECORD

GREEN by DESIGN

Foster and Partners' luminous tower of glass and steel rises in New York

ALSO

LIGHTING SECTION

[Between us, ideas become reality.]®



Our ceiling recycling program is growing.

The Armstrong Ceiling Recycling Program was designed to protect our environment by providing a better way to dispose of old ceiling materials. We'll pick up old acoustical ceilings from renovation projects and take them to one of our manufacturing sites to be recycled into new Armstrong ceilings. This closed-loop, one-of-a-kind program can help save on landfill and transportation costs. And your efforts can even help you achieve LEED® construction waste credits. It's an idea that's growing in popularity.

1-877-ARMSTRONG

armstrong.com/environmental

LEED® is a registered trademark of the United States Green Building Council.



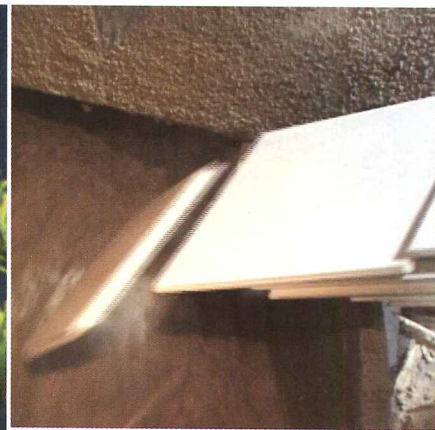
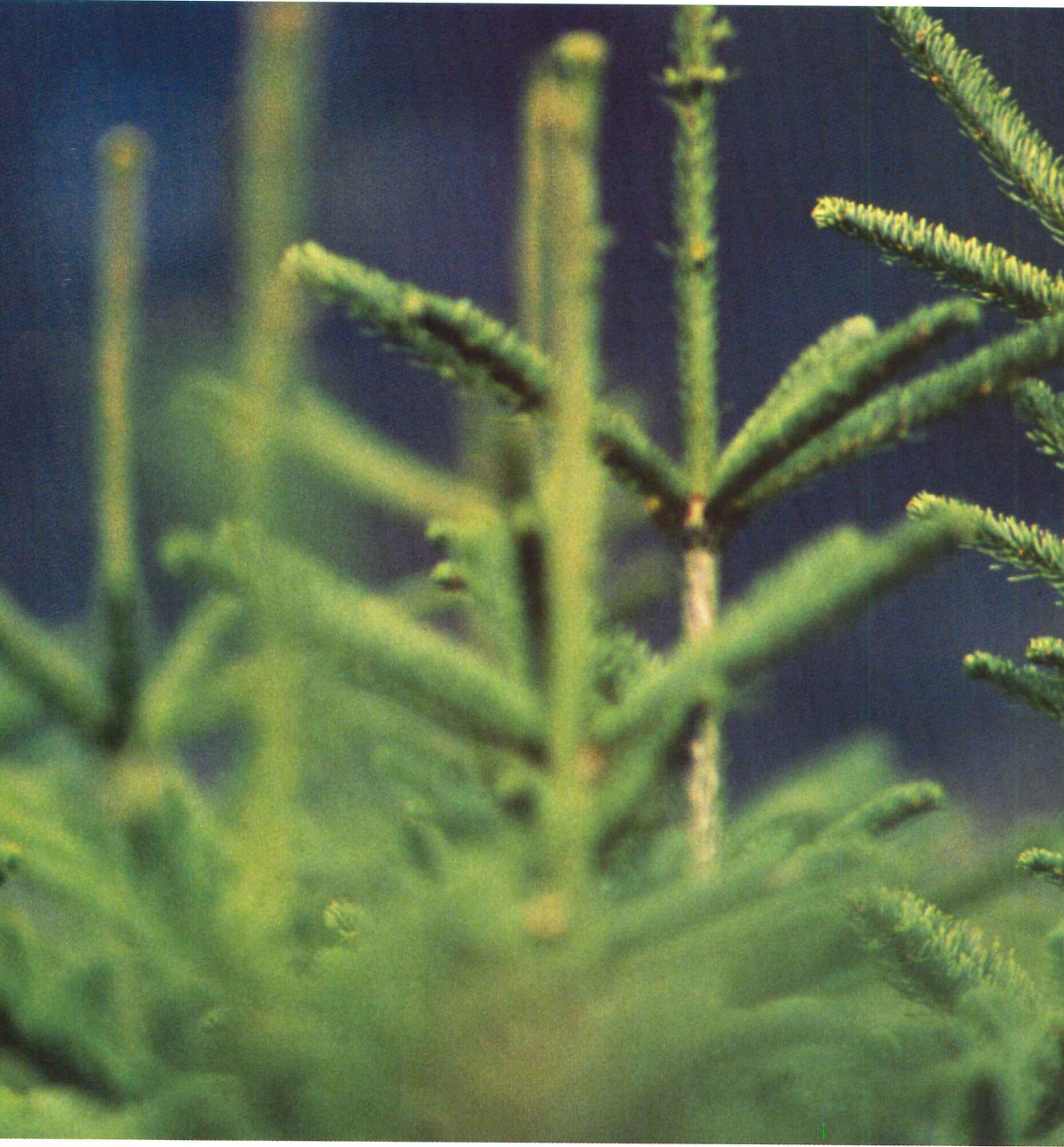

CIRCLE 1 ON READER SERVICE CARD OR GO
TO ARCHRECORD.CONSTRUCTION.COM/PRODUCTS/

Armstrong[®]

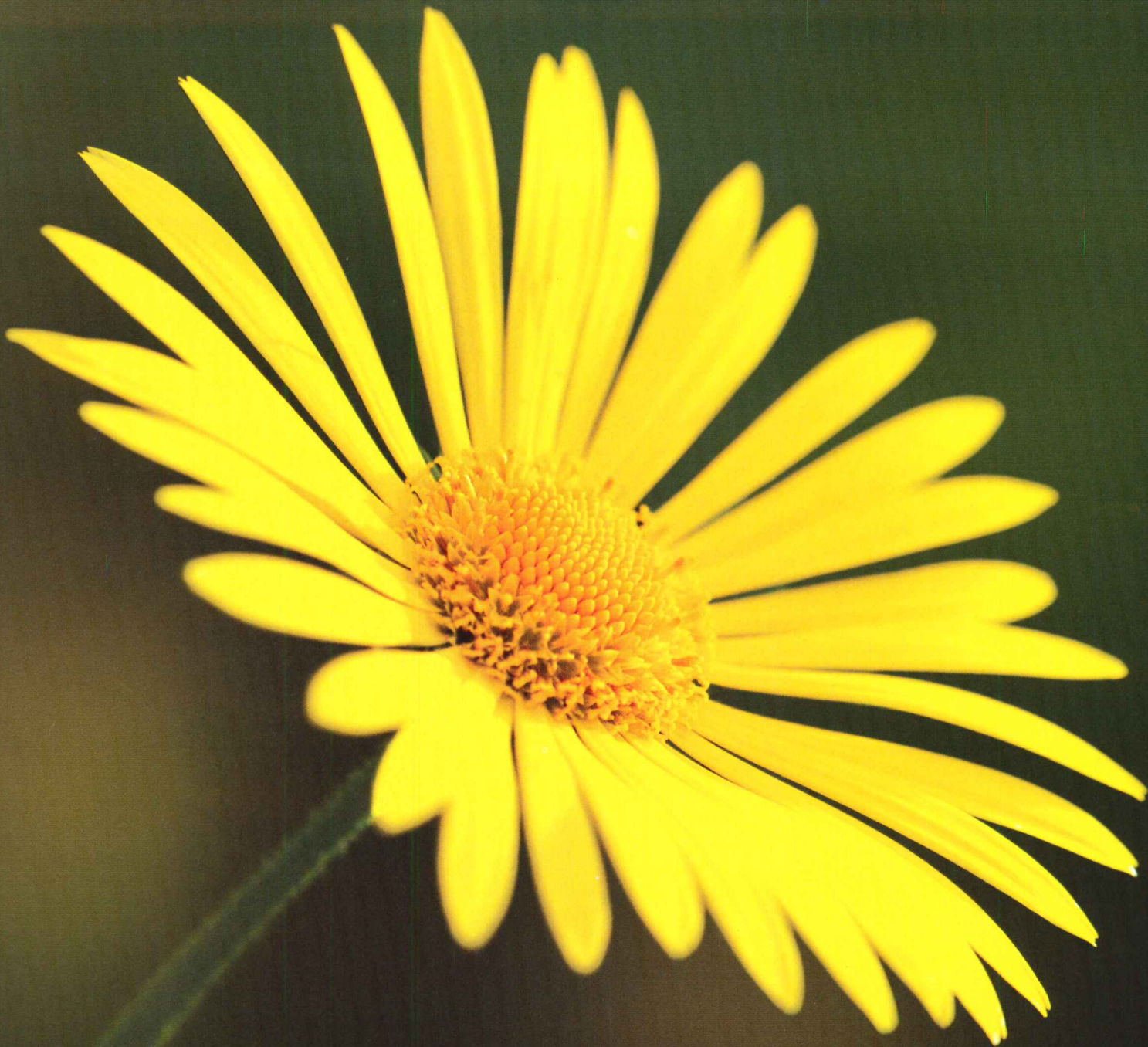

Imagine taking some of the most inspiring innovations in color across all fields of design, and cross-pollinating those concepts into your own creative vision.

That's what PPG *IdeaScapes* delivers.

In fact, PPG has more experience in creating and applying color on more materials and surfaces than any other company in the world. From architecture to automobiles and aircraft, from industrial design to consumer products, we offer the color expertise to unlock the full potential of your design vision by combining a true,

global understanding of color integration for almost any surface imaginable.

You can experience all of this personally at the next PPG *ColorShare* Forum, where you'll meet the brightest color professionals from a variety of fields.

For more information about this groundbreaking conference, and to learn more about PPG's color capabilities, give us a call or visit us online. And get the buzz on how color can boost your creativity. No matter what field you're in.



Bringing everything in the field of Color to your field of Design.

Experience one of our PPG *ColorShare* Forums.

New York City	May 19, 2006
Chicago	May 24, 2006
Dallas	June 2006
Pittsburgh (<i>Fallingwater</i>)	June 2006
Toronto	September 2006
San Francisco	October 2006
Los Angeles	January 2007



*IdeaScapes*TM
Glass • Coatings • Paint

CIRCLE 2 ON READER SERVICE CARD OR GO
TO ARCHRECORD.CONSTRUCTION.COM/PRODUCTS/

1-888-PPG-IDEA (774-4332) www.ppgideascales.com

Why Teragren bamboo?



Vertical Grain Natural
4' x 8' veneer

Beauty with substance.

Teragren® furniture-grade bamboo panels and veneer offer a beautiful alternative to hardwoods. They complement contemporary to classic designs, as well as Teragren fine bamboo flooring.

As product developer and manufacturer, U.S.-based Teragren strictly controls manufacturing for consistent quality and performance.



Vertical Grain Caramelized

Green building material.

Teragren uses only durable, renewable Optimum 5.5™ Moso bamboo and environmentally safe adhesives, contributing to two U.S. Green Building Council LEED® credits.

Sizes, inventory and on-time delivery.

Teragren panels and veneer come in custom and standard sizes to fit a variety of commercial and residential projects. Teragren products are stocked in available inventory with on-time delivery.



Vertical Grain
Caramelized

For samples, call
800.929.6333 or

visit teragren.com.

Click "Contact & Where to Buy" and use the Order Information form.



Teragren
FINE BAMBOO FLOORING, PANELS & VENEER

www.teragren.com

CIRCLE 3 ON READER SERVICE CARD OR GO
TO ARCHRECORD.CONSTRUCTION.COM/PRODUCTS/

ARCHITECTURAL RECORD

EDITOR IN CHIEF MANAGING EDITOR DESIGN DIRECTOR DEPUTY EDITORS

Robert Ivy, FAIA, rivy@mcgraw-hill.com
Beth Broome, elizabeth_broome@mcgraw-hill.com
Anna Egger-Schlesinger, schlesin@mcgraw-hill.com
Clifford A. Pearson, pearsonc@mcgraw-hill.com
Suzanne Stephens, suzanne_stephens@mcgraw-hill.com
Charles Linn, FAIA, Profession and Industry, linnc@mcgraw-hill.com
Sarah Amelar, sarah_amelar@mcgraw-hill.com

SENIOR EDITORS

William Weathersby, Jr., bill_weathersby@mcgraw-hill.com
Jane F. Kolleeny, jane_kolleeny@mcgraw-hill.com
Joann Gonchar, AIA, joann_gonchar@mcgraw-hill.com
Russell Fortmeyer, russell_fortmeyer@mcgraw-hill.com
Rita Catinella Orrell, rita_catinella@mcgraw-hill.com
David Sokol, ar_news_editor@mcgraw-hill.com
Juan Ramos, juan_ramos@mcgraw-hill.com
Kristofer E. Rabasca, kris_rabasca@mcgraw-hill.com
Susannah Shepherd, susannah_shepherd@mcgraw-hill.com
Laurie Meisel, laurie_meisel@mcgraw-hill.com
Linda Ransey, linda_ransey@mcgraw-hill.com
Monique Francis, monique_francis@mcgraw-hill.com

COPY EDITOR ILLUSTRATOR EDITORIAL ASSISTANT

Leslie Yudell
I-ni Chen
John Gendall, john_gendall@mcgraw-hill.com

EDITOR AT LARGE

James S. Russell, AIA, jamesrussell_editor@earthlink.net

CONTRIBUTING EDITORS

Raul Barreneche, Robert Campbell, FAIA, Andrea Oppenheimer Dean, David Dillon, Lisa Findley, Blair Kamin, Nancy Levinson, Thomas Mellins, Robert Murray, Sheri Olson, FAIA, Nancy B. Solomon, AIA, Michael Sorkin, Michael Speaks, Ingrid Spencer
Naomi R. Pollock, AIA
David Cohn, Claire Downey, Tracy Metz

SPECIAL INTERNATIONAL CORRESPONDENT INTERNATIONAL CORRESPONDENTS

GROUP PUBLISHER VP, ASSOCIATE PUBLISHER VP, GROUP EDITORIAL DIRECTOR GROUP DESIGN DIRECTOR DIRECTOR, CIRCULATION

James H. McGraw IV, jay_mcgraw@mcgraw-hill.com
Laura Viscusi, laura_viscusi@mcgraw-hill.com
Robert Ivy, FAIA, rivy@mcgraw-hill.com
Anna Egger-Schlesinger, schlesin@mcgraw-hill.com
Maurice Persiani, maurice_persiani@mcgraw-hill.com
Brian McGann, brian_mcgann@mcgraw-hill.com
Susan Valentini, susan_valentini@mcgraw-hill.com
Stephen R. Weiss, stephen_weiss@mcgraw-hill.com
Ike Chong, ike_chong@mcgraw-hill.com
Reprint Management Services, architecturalrecord@reprintbuyer.com

DIRECTOR, MULTIMEDIA DESIGN & PRODUCTION MANAGER, ADVERTISING PRODUCTION DIRECTOR, FINANCE REPRINTS

EDITORIAL OFFICES: 212/904-2594. Editorial fax: 212/904-4256. E-mail: rivy@mcgraw-hill.com. Two Penn Plaza, New York, N.Y. 10121-2298. **WEB SITE:** www.archrecord.com. **SUBSCRIBER SERVICE:** 877/876-8093 (U.S. only). 515/237-3681 (outside the U.S.). Subscriber fax: 712/755-7423. E-mail: arhcustserv@cdsfulfillment.com. If the Post Office alerts us that your magazine is undeliverable, we have no further obligation unless we receive a corrected address within one year. AIA members must contact the AIA for address changes on their subscriptions. 800/242-3837. E-mail: memberservices@aia.org. **INQUIRIES AND SUBMISSIONS:** Letters, Robert Ivy; Practice, Charles Linn; Books, Clifford Pearson; Record Houses and Interiors, Sarah Amelar; Products, Rita Catinella Orrell; Lighting and Interiors, William Weathersby, Jr.; Residential, Jane F. Kolleeny; Architectural Technology, Joann Gonchar and Russell Fortmeyer; Web Editorial, Ingrid Spencer.

ARCHITECTURAL RECORD: (ISSN 0003-858X) August 2006. Vol. 194, No. 08. Published monthly by The McGraw-Hill Companies, 1221 Avenue of the Americas, New York, N.Y. 10020. Periodicals postage paid at New York, N.Y. and additional mailing offices. Canada Post International Publications Mail Product Sales Agreement No. 40012501. Return undeliverable Canadian addresses to: DPGM Ltd., 2-7496 Bath Road, Mississauga, ON L4T 1L2. Email: arhcustserv@cdsfulfillment.com. Registered for GST as The McGraw-Hill Companies. GST No. R123075673. **Postmaster:** Please send address changes to ARCHITECTURAL RECORD, Fulfillment Manager, P.O. Box 5732, Harlan, IA 51593. **SUBSCRIPTION:** Rates are as follows: U.S. and Possessions \$70.30; Canada and Mexico \$79 (payment in U.S. currency, GST included); outside North America \$199 (air freight delivery). Single copy price \$9.95; for foreign \$11. Subscriber Services: 877/876-8093 (U.S. only); 515/237-3681 (outside the U.S.); fax: 712/755-7423. **SUBMISSIONS:** Every effort will be made to return material submitted for possible publication (if accompanied by stamped, self-addressed envelope), but the editors and the corporation will not be responsible for loss or damage. **SUBSCRIPTION LIST USASHEPCAGE:** Advertisers may use our list to mail information to readers. To be excluded from such mailings, send a request to ARCHITECTURAL RECORD, Mailing List Manager, P.O. Box 555, Hightstown, N.J. 08520. **OFFICERS OF THE MCGRAW-HILL COMPANIES:** Chairman, President and Chief Executive Officer: Harold McGraw III. Executive Vice President and Chief Financial Officer: Robert J. Bahash. Executive Vice President, Human Resources: David L. Murphy. Senior Vice President and General Counsel: Kenneth M. Vittor. Principal Operating Executives: Kathleen A. Corbet, President, Standard & Poors; Henry Hirschberg, President, McGraw-Hill Education; Glenn S. Goldberg, President, McGraw-Hill Information and Media Services. **MCGRAW-HILL CONSTRUCTION:** President: Norbert W. Young, Jr., FAIA. Senior Vice President: Howard M. Mager. **COPYRIGHT AND REPRINTING:** Title® reg. in U.S. Patent Office. Copyright © 2006 by The McGraw-Hill Companies. All rights reserved. Where necessary, permission is granted by the copyright owner for libraries and others registered with the Copyright Clearance Center (CCC), 222 Rosewood Drive, Danvers, Mass. 01923. To photocopy any article herein for personal or internal reference use only for the base fee of \$1.80 per copy of the article plus ten cents per page, send payment to CCC, ISSN 0003-858X. Copying for other than personal use or internal reference is prohibited without prior written permission. Write or fax requests (no telephone requests) to Copyright Permission Desk, ARCHITECTURAL RECORD, Two Penn Plaza, New York, N.Y. 10121-2298; fax 212/904-4256. For reprints call 800/360-5549 X 129 or e-mail architecturalrecord@reprintbuyer.com. Information has been obtained by The McGraw-Hill Companies or ARCHITECTURAL RECORD does not guarantee the accuracy, adequacy, or completeness of any information and is not responsible for any errors or omissions therein or for the results to be obtained from the use of such information of for any damages resulting therefrom.

**McGraw Hill
CONSTRUCTION**



The McGraw-Hill Companies

THE AMERICAN INSTITUTE OF ARCHITECTS 2006 BOARD OF DIRECTORS • OFFICERS: Kate Schwennsen, FAIA, President; RK Stewart, FAIA, First Vice President; Ronald J. Battaglia, FAIA, Vice President; Michael Broshar, FAIA, Vice President; Jerry K. Roller, AIA, Vice President; Norman Strong, FAIA, Vice President; John C. Senhauser, FAIA, Secretary; Tommy Neal Cowan, FAIA, Treasurer; Jeremy Edmunds, Associate AIA, Associate Representative to the AIA Executive Committee; Elizabeth Mitchell, CACE Representative to the AIA Executive Committee; Christine W. McEntee, Executive Vice President/CEO. • **REGIONAL DIRECTORS:** Peter J. Arsenault, AIA; Michel C. Ashe, AIA; William D. Beyer, FAIA; Jay Brand, PhD; David J. Brotman, FAIA; Stephan Castellanos, FAIA; Anthony J. Costello, FAIA; David Crawford; James H. Eley, FAIA; Glenn H. Fellows, AIA; Robert D. Fincham, AIA; Jonathan L. Fischel, AIA; Marion L. Fischel, AIA; Maureen A. Guttman, AIA; Walter J. Hainsfurthner, AIA; John J. Hoffmann, FAIA; Richard Jackson, MD, MPH; Leevi Kilil, FAIA; Michael Lischer, AIA; Clark Llewellyn, AIA; Stephen K. Loos, AIA; Marvin J. Malacha, FAIA; Clark D. Manus, FAIA; John M. Maudlin-Jeronimo, FAIA; Linda McCracken-Hunt, AIA; George H. Miller, FAIA; Hal P. Munger, FAIA; Robin L. Murray, AIA; Thompson Nelson, FAIA; Celeste A. Novak, AIA; Gordon N. Park, AIA; Marshall E. Purnell, FAIA; Miguel A. Rodriguez, AIA; Jeffrey Rosenblum, AIA; Ken Ross, FAIA; Greg Staskiewicz, Associate AIA; James M. Suehiro, AIA; Leslie J. Thomas, AIA; Bryce A. Weigand, FAIA; Enrique A. Woodroffe, FAIA; Erik Zaddock. • **AIA MANAGEMENT COUNCIL:** Christine W. McEntee, Executive Vice President/CEO; Richard J. James, CPA, Chief Financial Officer; Jay A. Stephens, Esq., General Counsel; Helene Combs Drelling, Hon. SDA, FAIA, Team Vice President, AIA Community; Barbara Sido, CAE, Team Vice President, AIA Knowledge; Elizabeth Stewart, Esq., Team Vice President, AIA Public Advocacy; David Downey, CAE, Assoc. AIA, Managing Director, AIA Communities by Design; James Gatsch, FAIA, General Manager, AIA Contract Documents; Suzanne Harness, Esq., AIA, Managing Director and Counsel, AIA Contract Documents; Maan Hashem, Managing Director, AIA Software Products and Services; Richard L. Hayes, PhD, RAIC, CAE, AIA, Managing Director, AIA Knowledge Resources; Brenda Henderson, Hon. AIA, Managing Director, AIA Component Relations; Christine M. Klein, Managing Director, AIA Meetings; Carol Madden, Managing Director, AIA Membership Services; Philip D. O'Neal, Managing Director, AIA Information Technology; C.D. Pangallo, EdD, Managing Director, AIA Continuing Education; Terence J. Poltrac, Managing Director, AIA Communications; Andrea S. Rutledge, SDA, Managing Director, AIA Alliances; Phil Simon, Managing Director, AIA Marketing and Promotion; Terri Stewart, Managing Director, AIA Professional Practice.



VERSATILE

FIRE-RATED GLASS CERAMIC

FireLite®

FAMILY OF PRODUCTS

- PERFECT ALTERNATIVE TO WIRED GLASS
- AVAILABLE WITH HIGH IMPACT SAFETY RATINGS
- FIRE-RATED FOR UP TO 3 HRS IN DOORS (90 MIN. IN OTHER APPLICATIONS)
- MAY BE STOCKED AND CUT BY LOCAL DISTRIBUTORS
- CLEAR AND WIRELESS
- PASSES REQUIRED HOSE STREAM TEST

CALL OR VISIT US ONLINE
FOR YOUR FREE BROCHURE

1-888-397-FIRE (3473)

FIREGLASS.COM

SALES@FIREGLASS.COM



TGP
Technical Glass Products®

© 2006 Technical Glass Products. All rights reserved. FireLite is a registered trademark of Nippon Electric Glass Co., Ltd. Technical Glass Products is a registered trademark of Technical Glass Products.

CIRCLE 4 ON READER SERVICE CARD OR GO
TO ARCHRECORD.CONSTRUCTION.COM/PRODUCTS/

Let your drafting pencil go where it will. Our windows can keep up.

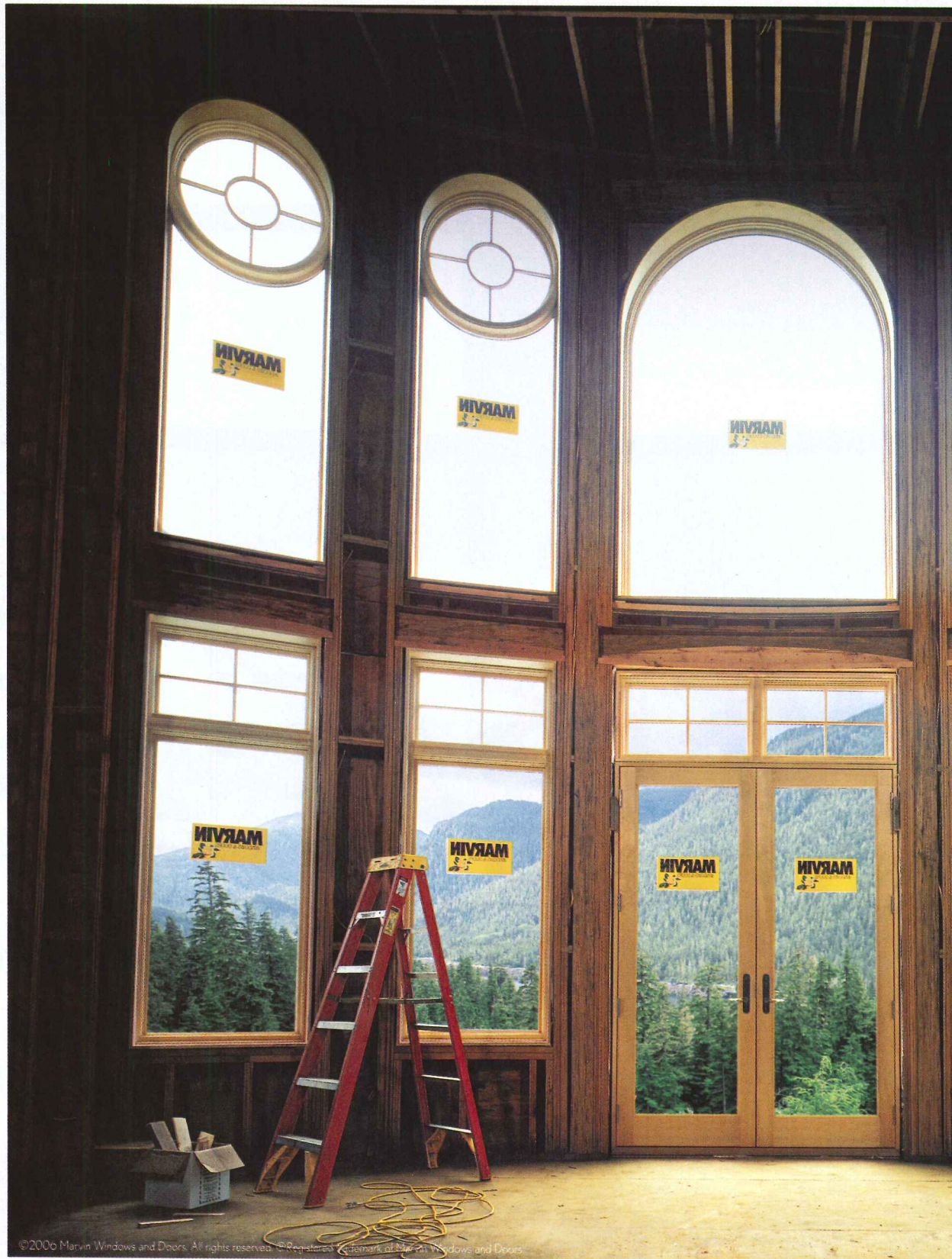

©2006 Marvin Windows and Doors. All rights reserved. Registered trademark of Marvin Windows and Doors.



Say good-bye to "can't be done." Marvin's Signature Products and Services provide unique solutions to the most challenging projects. That means the widest possible choices in color, hardware and design (including completely custom profiles and casings—in clad or wood). Plus a guarantee of our most personalized service and unerring attention to detail. Call 1-800-236-9690 (in Canada, 1-800-263-6161) or visit marvin.com

MARVIN 
Windows and Doors
Made for you.®

CIRCLE 5 ON READER SERVICE CARD OR GO
TO ARCHRECORD.CONSTRUCTION.COM/PRODUCTS/

Environmentally Sensitive, Economically Responsible, Architecturally Beautiful—Metal, a Reusable Resource.

Metal is one of the world's most recyclable materials, and it is a material ideally suited for architectural exterior and interior cladding systems. In fact, metal wall panels and roofing systems are the cladding materials of choice for "green" architectural design and "green" construction.

Fabral Architectural Systems utilizes primary metal substrates that are substantially recycled and completely recyclable. Our steel, aluminum and copper substrate content is closely managed to create environmentally sensitive products that save energy and reduce landfill costs. Fabral Architectural Systems has attained Energy Star approval for virtually every panel profile we manufacture. Plus, Fabral products have been used to help attain LEED (Leadership in Energy and Environmental Design) certification for innovative energy efficient structures.

For more information about using Fabral architectural panels or for technical specifications, call Fabral Architectural Systems at (800) 884-4484.



www.fabral.com

COPPERCRAFT
Architectural Specialty Sheet Metal BY **FABRAL** A EURAMAX COMPANY

www.coppercraft.com

CIRCLE 6 ON READER SERVICE CARD OR GO
TO ARCHRECORD.CONSTRUCTION.COM/PRODUCTS/



Where windows are just the beginning.

Building On A Great Beginning

For more than a half-century, EFCO Corporation has been building on our reputation for providing discriminating designers beautiful, functional, energy-efficient windows for projects large and small. On this basis, we've established our company as your comprehensive, single-source supplier of professional service and innovative products. That's a resource you can build on.

For a complete listing of EFCO products, please visit us online at efcocorp.com or call us at 800.221.4169

CIRCLE 13 ON READER SERVICE CARD OR GO
TO ARCHRECORD.CONSTRUCTION.COM/PRODUCTS/

Our stunning decorative synthetic
millwork products are backed by

**THE REAL BEAUTY IS IN OUR
DEDICATION TO THE BEHOLDER.**

a dedicated support team, an
ongoing CEU commitment,
immediate-access architectural
specifications and our exclusive
online configurator. At Fypon®,
beauty is far more than skin deep.



FYPON

www.specifypon.com • 800.446.3040

To schedule a consultation, call our toll free number or visit
our website for more information.

FYAR0806BH / FY347

**CIRCLE 7 ON READER SERVICE CARD OR GO
TO ARCHRECORD.CONSTRUCTION.COM/PRODUCTS/**

CELEBRATING
KAWNEER
100
years
SINCE 1906



The Kawneer Thermal Window.
Because style is always in season.

build for life
www.kawneer.com

architectural aluminum systems • entrances and framing • curtain walls • windows

Now there's an elegant way to weather any storm. The new Kawneer AA900 ISOWEB® Window features improved thermal performance thanks to a polyamide thermal break, contemporary Euro-Groove mounted hardware with multi-point locking, and unique mitered corners for clean sightlines. Plus, there are a variety of available design options, including 2-color finish. Whatever the season, now there's a thermal window that seamlessly unites style with function. You'll always be comfortable when the choice is Kawneer.

If you're an architect looking for product applications or technical assistance, contact our Architectural Services Team toll free at 877.767.9107 or visit our website at www.kawneer.com.

CIRCLE 8 ON READER SERVICE CARD OR GO TO ARCHRECORD.CONSTRUCTION.COM/PRODUCTS/

Kawneer
An Alcoa Company

MEET EXPECTATIONS WITHOUT COMPROMISE.



You can rely on Sherwin-Williams to help you meet your green coating specifications and satisfy all your quality expectations. We've developed the GreenSure™ symbol to help you identify environmentally preferable products that deliver maximum performance. Look for GreenSure on Harmony® and Duration Home™. Both of these innovative coatings meet our highest standards for air quality, VOC emissions, life cycle cost efficiency, durability, color, and coverage. To learn more, visit your nearest Sherwin-Williams store, see your Architectural Account Executive or call our Architect & Designer Answerline at 1-800-321-8194.



ARCHITECTURAL RECORD

08.2006



On the Cover: Hearst Tower, by Foster and Partners. Photograph by Chuck Choi.
Right: Federal Environmental Agency, by Sauerbruch Hutton. Photograph by Bitter Bredt.

News

- 25 Bergdoll offers glimpse of MoMA tenure**
- 26 Remembering Hugh Stubbins**

Departments

- 17 Editorial: Five Distinct Dramas**
- 20 Letters***
- 41 Archrecord2*: For the emerging architect**
- 45 Exhibitions: The Green House** by Andrea Oppenheimer Dean
- 49 Books: Green Design**
- 53 Product View: 180 Walls** by Rita Catinella Orrell
- 55 Snapshot: Bamboo Bridge** by Beth Broome
- 203 Dates & Events***
- 228 Backpage: 1949 MIT Solar Test House** by Russell Fortmeyer

Features

- 60 Big Ideas for a Little Planet** by Russell Fortmeyer
RECORD talks with leading voices about sustainability's future.

Projects

- 73 Introduction** by Russell Fortmeyer*
- 74 Hearst Tower, New York City** by Sarah Amelar*
Foster and Partners
A faceted glass-and-steel tower erupts from a landmarked low-rise.
- 82 Federal Environmental Agency, Germany** by Suzanne Stephens*
Sauerbruch Hutton Architects
Sustainability is achieved with unusual verve in Dessau.
- 90 The National Library, Singapore** by Clifford A. Pearson*
T.R. Hamzah & Yeang
Marking a new era for Singapore, a civic icon rises.
- 100 National Assembly for Wales, Wales** by Catherine Slessor*
Richard Rogers Partnership
A design synthesizes transparency and ecological responsibility.

Building Types Study 860

- 107 Introduction: Performing Arts** by James S. Russell, AIA
- 108 Guthrie Theater, Minneapolis** by James S. Russell, AIA*
Ateliers Jean Nouvel
- 118 Luxembourg Philharmonie, Luxembourg** by Joseph Giovannini*
Christian de Portzamparc Studio
- 124 Holland Performing Arts, Nebraska** by Russell Fortmeyer*
A collaboration between HDR and Polshek Partnership Architects

For additional Performing Arts projects, go to Building Types Study at www.archrecord.com.

Architectural Technology

- 135 Rooftops Slowly, but Steadily, Start To Sprout** 
by Joann Gonchar, AIA*
Technology takes root at new heights as research and policies encourage implementation.

Lighting

- 161 Introduction** by William Weathersby, Jr.
- 162 B&B Italia Showroom** by William Weathersby, Jr.*
Flos
- 170 Diva Lounge** by William Weathersby, Jr.
Studio Luz
- 174 Mixed Greens** by Leanne French
Tillotson Design Associates
- 179 Lighting Products** by Rita Catinella Orrell

Products

- 187 Green Options** by Rita Catinella Orrell
- 191 NeoCon Review** by Rita Catinella Orrell
- 199 Product Literature** by Amanda Webb
- 208 Reader Service***
- 211 AIA/CES Self-Report Form***

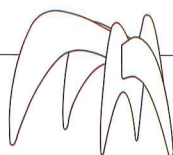

AR is the proud recipient of a
National Magazine Award for General Excellence

* You can find these stories at www.archrecord.com, including expanded coverage of Projects, Building Types Studies, and Web-only special features.



For its Manhattan debut, Foster and Partners creates the new HEARST TOWER with a glass-and-steel shaft hovering atop a vintage low-rise
Photography: © Chuck Choi

Projects

Architects worldwide are designing iconic buildings known not just for their feats of engineering and design, but for their sustainability. As the standard gets higher, the gospel of green is being heard and echoed, as these four projects prove.

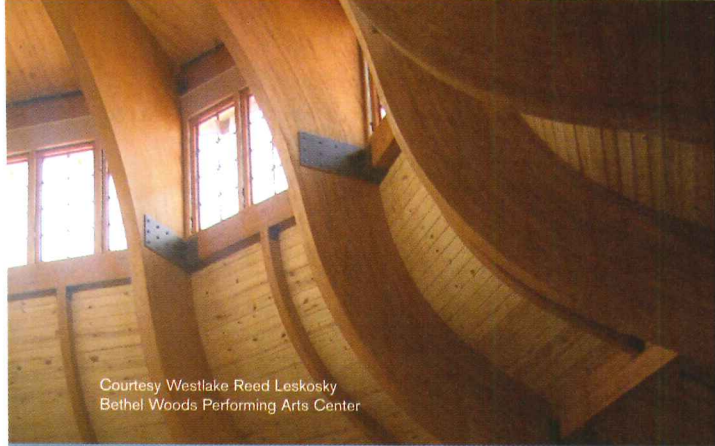

Courtesy Westlake Reed Leskosky
Bethel Woods Performing Arts Center

Building Types Studies: Performing Arts

For all the stories of struggling orchestras and embattled theater troupes, halls that offer a superior audience experience are drawing wide community support. We showcase 12 here, from Luxembourg to Omaha, Nebraska.

Sponsored by



Lighting

Wood, acrylic domes, and playfully geometric fixtures are just some of the clever ways lighting designers have chosen to filter or showcase, but never hide, the rhythmic sensory lighting experiences we feature this month, including a lounge, a high-style furniture showroom, and an art gallery.

Sponsored by

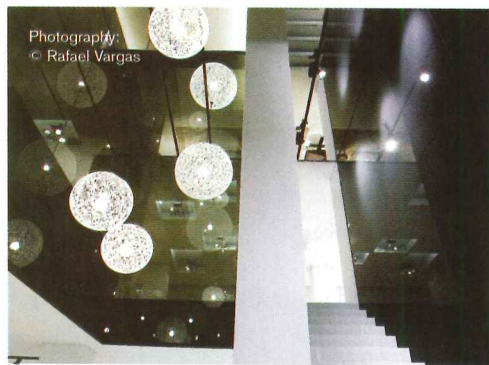

Photography:
© Rafael Vargas

Fios fulfills the luminous visions of Patricia Urquiola and Martino Berghinz at B&B Italia in Barcelona

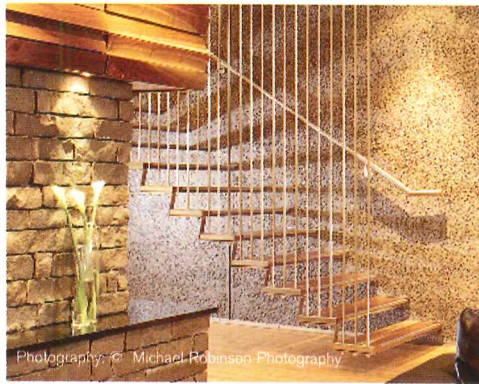

Photography: © Michael Robinson Photography

Archrecord2

archrecord2 focuses on two architects who followed their hearts. While Matthew Hufft traveled a path that presented itself to him at age six, architect and real-estate management consultant Winnie Lee found her way by transitioning with the jobs that came her way. Both architects discovered what makes them tick, and the results speak for themselves.

House of the Month

Somewhere between the ground and a canopy of trees, in Massachusetts, is the Geothermal House, by Maryann Thompson Architects. Oriented to take advantage of the daily path of the sun, the home uses cross-ventilation, geothermal heating and cooling systems, and flexible partitions throughout.

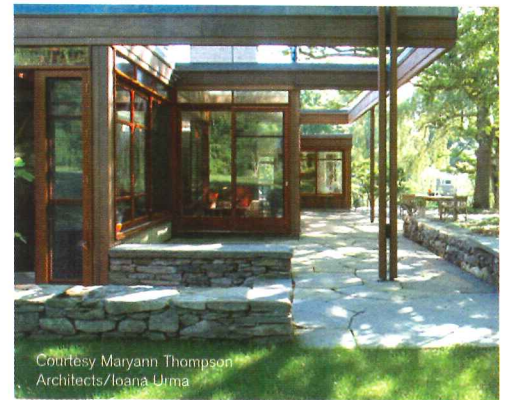

Courtesy Maryann Thompson Architects/Joana Urma

connecting people_projects_products

Dodge
Sweets
McGraw Hill
CONSTRUCTION
Architectural Record
ENR
Regional Publications

Find us online at www.construction.com

The McGraw-Hill Companies

**If you look real close you can see 25 years
of fire-rated glazing experience reflected in it.**



SCHOTT PYRAN® fire-rated glass-ceramics are an architect's best friend.

PYRAN® is everything you've been looking for in fire-rated glass. It's fire-protective, impact-resistant and, aesthetically speaking, quite fetching. PYRAN® Crystal offers the highest standard of clarity, transmission and true color rendition. And PYRAN® Star is both beautiful and economical. PYRAN® is available with a surface applied film, laminated or polished. It comes in large sizes and is easily accessible through distributors, fabricators and glaziers. For new construction or retrofit, spec the glass with a loyal following among fire professionals – PYRAN®.



Home Tech
SCHOTT North America, Inc.
Phone: 502-657-4417
Fax: 502-966-4976
E-mail: pyran@us.schott.com
www.us.schott.com/pyran

©2005 SCHOTT North America, Inc.

® PYRAN is a registered trademark of SCHOTT AG, Mainz, Germany

SCHOTT
glass made of ideas

**CIRCLE 10 ON READER SERVICE CARD OR GO
TO ARCHRECORD.CONSTRUCTION.COM/PRODUCTS/**

ALUCOBOND®



LANDMARK PROJECT

ALUMINIUM CENTRUM
HOUTEN, NETHERLANDS

4

WHO

Architectenbureau Micha de Haas,
Amsterdam

Alucobond Installer:

Alcan Service Center Nederland, Breda/
Hoogerwaard Gevelbouw, Rotterdam

HOW

18,000 sq. ft. of Silver Metallic
Alucobond Material attached with tray
panels, hooked on bolts in U-profiles

WELL BALANCED

DYNAMIC DESIGN. ABSOLUTELY ALUCOBOND.

Alucobond® Material provides a solution that balances form and function in the striking design of the new headquarters of the Dutch aluminum industry organization. Inspired by the typical Dutch poplar-strewn landscape, the architect placed the building on 368 aluminum columns to accentuate the lightness and strength of aluminum. Resting atop "the aluminum forest", the office building utilizes 1150mm-wide Alucobond panels. Each panel is well balanced, too, with a 0.02" aluminum skin on *both* sides, unlike some competitors. This symmetry contributes to Alucobond's superior flatness, long a hallmark of the material. The Silver Metallic Alucobond strengthens the aluminum appearance and guarantees long-lasting quality. The remarkable architecture gives the building an extraordinary character. Dynamic Design. Absolutely Alucobond.

ALUCOBOND®

THE WORLD'S FAVORITE ALUMINUM COMPOSITE MATERIAL

ALCAN COMPOSITES

ALCAN COMPOSITES USA INC.
1.800.626.3365
www.alucobond.com

CIRCLE 11 ON READER SERVICE CARD OR GO
TO ARCHRECORD.CONSTRUCTION.COM/PRODUCTS/



Five Distinct Dramas

Editorial

By Robert Ivy, FAIA

This summer, five superintendents of education gathered in a conference room in Washington, D.C. Somewhat nervous to be meeting so far from home, one member admitted that she had never visited the capital before; another had lived in nearby Arlington, Virginia. She and her colleagues formed no ordinary sampling of educators: Each had survived Hurricane Katrina.

Convened by the American Architectural Foundation (AAF), this elite cadre all hailed from the Mississippi Gulf Coast and were attending a School Design Institute, a special iteration of an AAF program called "Great Schools by Design." The event formed the second gathering for the group, following a larger meeting on their home turf in Gulfport, Mississippi, in February. Intended to improve the quality of educational facilities, the Great Schools program routinely brings together leaders in education, then pairs them with nationally recognized experts who act as advisers in architecture, regulation, and planning—with the hope of advancing innovative new school designs.

The stories that these administrators told, and the images that they showed, presented five distinct dramas. In one case, a superintendent shared images of her school, which remained filled with waterborne debris months after the cataclysmic storm had washed back to sea. Already, she and her board had marshaled resources to purchase a large plot of land on higher ground, but they were filled with questions. Should they sell the original school property located near the Gulf? Where on their new property did it make the most sense to erect a new building, and could they achieve the same sense of community away from the comfortably scaled downtown streets?

Another leader presided over a historic school whose wood-framed plaster walls had soaked up the seawater and filled with mold. Yet FEMA refused to classify the property as a total loss, allotting significantly less than the total cost for repairs. Who could she call for advice? A state historic preservation officer? Could the property be converted to other, more commercially valuable uses? Should it be demolished? And if so, where should the students relocate? Most were currently housed in trailers.

At the conclusion of the day, one lesson stood out: This group of dedicated citizens had been asked to do more than we should expect of public servants. Confronted with the weight of catastrophe, each had risen to the challenges, even heroically, struggling in the aftermath through long hours with little but local help. By and large, they had managed to get their school systems functioning again (all were operating by November), yet something was missing.

In the throes of the Depression, when the nation faced a period of

intractable poverty, the Roosevelt Administration devised a quasi-governmental agency, the Tennessee Valley Authority (TVA), to confront Appalachian poverty. Reaching across local and state borders, this federally chartered organization dealt with endemic flooding, brought electric power to the poorest mountain coves and small towns, then subsequently functioned as an economic development engine for a still-poor region. Its charter in 1933 made its mission explicit: "a corporation clothed with the power of government but possessed of the flexibility and initiative of a private enterprise." Ironically, when the lights went on at the Tupelo Cotton Mill, the small Mississippi town became America's first TVA city.

The analogy seems clear. Louisiana, Mississippi, Florida, and parts of Texas faced a perfect storm of troubles following Katrina that no local effort could fully understand or solve. In the wake of immense loss, what should be rebuilt, and where? Months after the disaster, local governments continue to struggle with the answer, chafing at the disparity between new FEMA flood maps, federal regulations, and the rights of property owners. The voters clearly want their land back. Despite the best efforts of trained planners, architects, or committed professionals in a variety of fields, from health care to education, the future of the area remains clouded. Who can sort through competing claims?

The daunting challenges faced by those five educators demonstrate the need for an authority like the TVA, mandated by Congress, capable of spanning state governments and resource networks, cutting red tape, and leading the way toward the thoughtful redevelopment of the Gulf South after this country's largest natural disaster. Schools are so critical for economic development that even the slightest diminution of their effectiveness would spell a kind of permanent doom for future growth. But a guiding hand, supported by economic development as the affected region rebuilds, could set the stage for decades of enlightened 21st-century prosperity, moving away from danger and pointing to the higher ground.

The American Architectural Foundation is to be commended for taking a leading role in helping this stricken area recover its school facilities. It remains for Congress and the current administration to take the next, bold step toward ensuring our nation's well-being by creating an authority to oversee the rebuilding of the Gulf South in a bold, visionary manner. While we are still reeling from Katrina, new storms are brewing in the Gulf, and our planning has just begun.

**Strong enough
to generate energy.**

Smart enough to help you conserve it.

By making turbine blades stronger and lighter, carbon fiber technology has helped wind power become the world's fastest growing clean energy source. Now, that same technology can help you conserve energy in your buildings. CarbonCast precast concrete wall systems and cladding use ultra-strong C-GRID™ carbon fiber grid for secondary reinforcing and C-GRID trusses for shear transfer. C-GRID is non-corrosive so it requires less concrete cover, giving you thinner and

lighter precast sections with more insulation and higher R-values. And because epoxy-coated carbon fiber grid has relatively low thermal conductivity, it does not transfer heat or cold through walls like steel does. The result? Greener, more environmentally friendly buildings. So while carbon fiber can help generate sustainable energy, it's no surprise that it can contribute to sustainable architecture, too. For more information, call 866-GO-ALTUS or visit www.altusprecast.com.

 **carboncast**™



altusgroup™

 **C-GRID**
REINFORCED
© 2010 by a trademark of TechFab, LLC

Oldcastle Precast, Building Systems Division • High Concrete Group™ • Metromont Corporation • TechFab, LLC
Gate Precast Company • Heldenfels Enterprises, Inc. • Blakeslee Prestress, Inc. • Shockey Precast Group

CIRCLE 12 ON READER SERVICE CARD OR GO TO ARCHRECORD.CONSTRUCTION.COM/PRODUCTS/



Fire safety and sound control.
All mixed into one poured underlayment.

LEVELROCK[®]

Meet fire and sound codes with a single self-leveling flooring product. Levelrock[®] brand floor underlayment.
Safe and sound. For more information, visit www.usg-levelrock.com or call 877 USG.4200.

USG

Letters

The power of education

Thank you for a wonderful editorial [July 2006, page 17] that speaks to the power of an education in architecture, to the contributions of the best of those who make that education possible, and to the insights and accomplishments of our newest Topaz Laureate. Those of us who have had the privilege of teaching and working with William McMinn, of being mentored and taught by him, and of understanding architecture through his eyes, gladly echo your warm praise.

—Marilyn Nepomechie
Miami, Fla.

The architectural continuum

Though I attended the AIA convention, I had to depart prior to Bill McMinn's speech. However, the recap in Robert Ivy's July editorial evoked a memory that I think is worth recounting.

This past year my son was able to attend the Florence Studio, in Italy, of Kent State University, where he is undertaking his master's degree in architecture. He arrived in Florence on a Sunday afternoon and, unlike my experience arriving in London 36 years earlier to study at the Architectural Association, he had a cell phone with which he could instantly communicate what he was experiencing.

He was standing before the Duomo and was overwhelmed. He walked through the archway of the Uffizi and stood on the steps of the Medici Library and called home. "Dad," he started, "I just realized something about architecture that never occurred to me until I came here: It's a continuum," he noted. "I am the next generation, carrying on a tradition of design that connects me to these great architects."

With this observation, his passion to learn and experience architecture grew immeasurably. Those of the profession who hold

deep passions for design and its power to uplift our communities begin, I believe, by reaching the understanding my son shared with me.

—Judson Kline, AIA
Cleveland

A blustery submission

I cannot understand how the scheme by workshop/apd [June, 2006, page 122] could have won a prize in your High Density on the High Ground Competition, given that the building would reside in a category five hurricane zone. This scheme violates all the rules of lateral wind force design along a major waterway! Although flooding may not be a problem on the high ground along the river's edge, Bernoulli principle wind forces would certainly be important, probably rendering the impact-resistance materials and structural loadings on such a promontory scheme unaffordable to most potential buyers. Furthermore, the orientation is perpendicular to the probable direction of winds blowing down the river corridor. The architect of that project does not appear to have ever experienced a real hurricane.

—James L. Wells, AIA
Miami, Fla.

L.A.'s highs and lows

As an urban planner and designer, I have always been intrigued by Los Angeles, and I appreciated the variety of projects and articles covered in the May 2006 issue.

Your Snapshot [page 77] captured the essence of the Watts Towers project well. It's noteworthy that this important symbol of determination, attitude, and community spirit survived the Watts riots of 1965.

However, as I looked over the photos of Morphosis's Science Center School [page 132], the last facility I would have guessed to

occupy the building was a school. It reads like an armory that should have been reused as a laboratory for testing chemicals or lab mice, not educating children. The breezeway looked as if the kids were marching to prison, not a class or a field trip. I can't imagine the author having fun writing about this building, for she retracted most of her compliments from the body of the piece in the last paragraph, "Mayne's muscular, industrial-strength, steel-and-concrete apparatuses could be a wee bit overwhelming." No kidding.

—John G. Howard
Charlotte

What New Orleans needs

Am I the only one who shuddered in horror at the headline "Morphosis unveils plan for downtown New Orleans" [July 2006, Record News, page 25]? Hasn't the city suffered enough? I am not saying that there is no place for the type of aggressive, style-driven, dark gray, placeless, pointy-stick architecture Morphosis practices, but it is the very opposite of what New Orleans needs at the moment: a continuation of its own distinctive, colorful, and humane architectural traditions. The accompanying image of a giant suburban corporate office park where downtown should be makes the point. I recommend that New Orleans follow the recent trend of replacing the architect with Renzo Piano.

—David D. Quillin, AIA
Berlin, Md.

Hybrid hotel

The 21C Museum Hotel in Louisville, Kentucky [June 2006, page 305], is composed of five former warehouses that were morphed into gallery spaces, a restaurant, and a hotel. What is unclear is whether or not downtown Louisville needs a space like this that atypically fuses these functions. And though an

attempt was made to preserve the facade for historic purposes, one cannot trace the original bourbon warehouses in the new design—a missed opportunity indeed.

Furthermore, since a visitor may be able to explore the galleries without leaving the hotel premises, it may deter one from venturing out into the rest of the city. In *The Death and Life of Great American Cities*, the late Jane Jacobs emphasized the importance of old buildings in cities. The impact the hotel will have on the community remains to be seen, as does whether or not Louisville can support a nontraditional building type of this sort.

—Adrienne Batson-Cooper,
Assoc. AIA
Brooklyn, N.Y.

Corrections:

The Wellesley College Wang Campus Center project story [July 2006, page 110] had two errors in the Sources section at the end: The furniture companies Fritz Hansen and Nienkamper were misspelled. Two architects were incorrectly credited for the MIT Brain and Cognitive Sciences Complex [July 2006, page 138]. Julian Beinart is a principal at Charles Correa Associates, and Roger Goldstein, FAIA, should have been listed as principal in charge at Goody Clancy. In the July coverage of the AIA Housing/HUD Awards [page 212], three projects were mistakenly listed as HUD winners: Building Community, 6 North Apartments, and Metro Hollywood Mixed-Use Building (though Metro Hollywood won a Housing award). Also, the Alan J. Rothman Accessibility award was misspelled. A rendering of the Standard Hotel in July's News section [page 34] should have been credited to Stephen Alesch of the New York City firm Roman and Williams.

Send letters to rivy@mcgraw-hill.com.

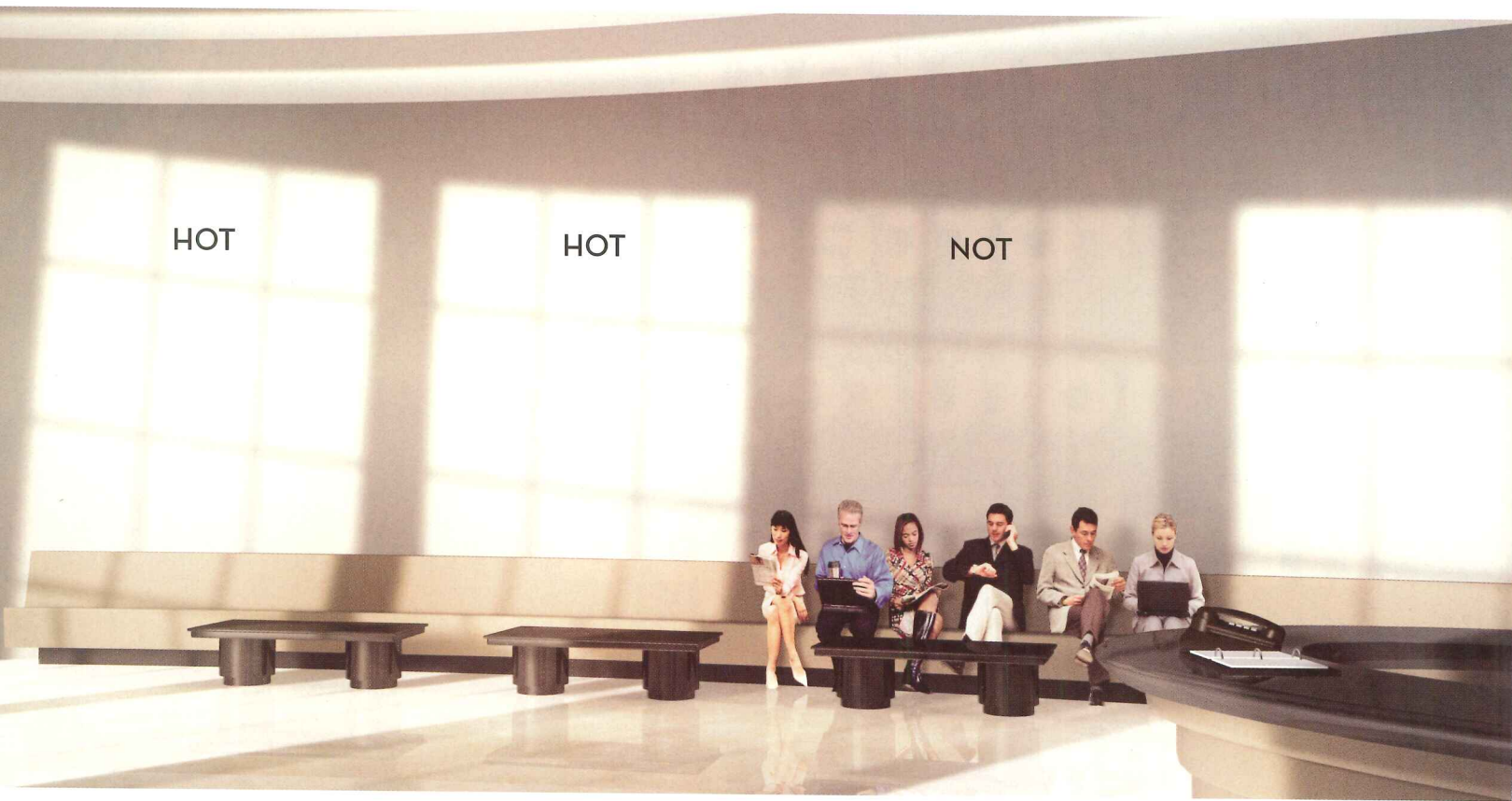

Presenting glass so cool it draws a crowd.

SageGlass® electronically tintable glass gives you the power to change your environment indoors without blocking your view to the outdoors. Now you can enjoy all of the sun's benefits while rejecting its undesirable qualities such as excessive heat gain. This grants you the freedom to design with more daylighting as you create a comfortable, productive and energy-efficient environment.

SageGlass glazing does what no other glass can do – it switches from clear to highly tinted at the push of a button. This provides an ultra-low solar heat gain coefficient when you need it, and high visible light transmission with spectrally selective properties when you don't. Revolutionary, but not unproven – SageGlass technology has been tested for years by the U.S. Department of Energy with outstanding results.

Why limit yourself to conventional glass with add-on solar control devices? Specify SageGlass glazing in your next building for a design that's hot, but a space that's not. To learn more, **call SAGE Electrochromics, Inc., 1-877-724-3321 or visit sage-ec.com.**

SageGlass products are built with Pilkington TEC™ Glass.  PILKINGTON

SageGlass technology provides an unparalleled solar heat gain coefficient of 0.09 in its tinted state, so large expanses of glass are possible without compromising comfort, view, or energy conservation.



The only glass that:

- Dynamically controls heat gain
- Actively controls daylighting
- Dramatically reduces all fading
- Stops glare

while always preserving the connection to the outdoors.

CIRCLE 14 ON READER SERVICE CARD OR GO TO ARCHRECORD.CONSTRUCTION.COM/PRODUCTS/

Sage Glass®
The power to change™

To express the forces of nature, think Trespa

Water. Wind. Temperature. Time. These random forces of nature move in mysterious ways—creating unpredictable beauty and character, especially when given the time to do so. For your inspirational consideration, Trespa has applied this universal truth to create seven new Meteon exterior panels—six new Naturals and one new Wood Décor.

Trespa Perspectives—not just building panels, but innovative ways to use them.

1.800.4.TRESPA (487-3772)

www.trespa.com

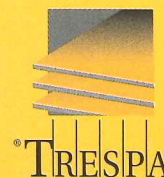

Trespa North America
12267 Crosthwaite Circle
Poway, CA 92064
Info@trespanorthamerica.

CIRCLE 15 ON READER SERVICE CARD OR GO
TO ARCHRECORD.CONSTRUCTION.COM/PRODUCTS/

AVONITE SURFACES

Every design needs a hero

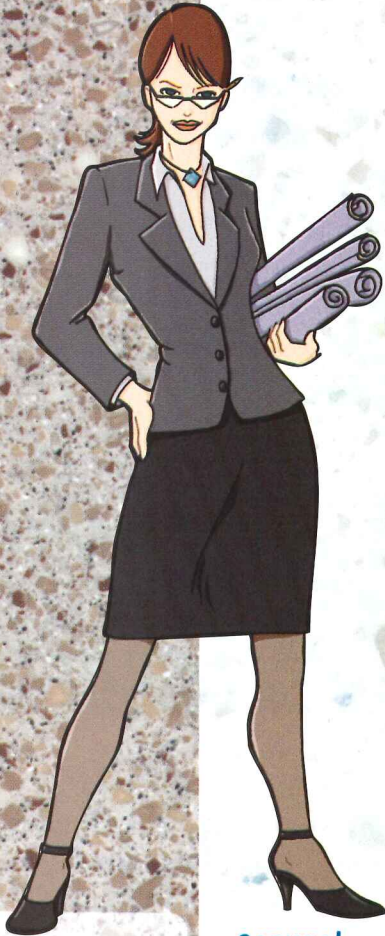

Palermo
Available in Custom Sheet Dimensions

Cozumel
Avonite Surfaces Recycled collection

Avonita

designer superhero

Episode 3: Haste Makes Waste

 **SCS Certified**
SCIENTIFIC CERTIFICATION SYSTEMS

Ava Knight takes sustainable design to a new level by specifying custom solid surface sheet dimensions as well as recycled products, from Avonite Surfaces. Will Avonita overcome mildewed tile and cultured marble vanities? To see the next episode, visit www.avonita.com.



CIRCLE 16 ON READER SERVICE CARD OR GO
TO ARCHRECORD.CONSTRUCTION.COM/PRODUCTS/



Sustainability + Design =

TERRAZZO



Terrazzo is the word in sustainability in flooring - utilizing 100% post-consumer recycled glass aggregate, and lasting the life of the building! And for aesthetic needs it is unrivaled. The Dallas/Fort Worth International Airport Board commissioned four teams to create designs for 4 SkyLink Stations. From Texas topography to birds to wildflowers, each design is a unique work of art!

Terrazzo A PERFORMING ART

Job Name: Dallas/Fort Worth
International Airport

Location: Dallas, Texas

Architect: Corgan Associates

Designers: Phillip Lamb, Susan Maglow,
Dan Blagg, Nancy Lamb, Brad Goldberg

Contact us at: **1.800.323.9736**

or visit us at: **WWW.NTMA.COM**

CIRCLE 17 ON READER SERVICE CARD OR GO
TO ARCHRECORD.CONSTRUCTION.COM/PRODUCTS/



p.26 Remembering Hugh Stubbins

p.28 Aalto ruckus at Harvard

p.30 Special section: Green news

p.36 Reality-TV invasion

Bergdoll offers glimpse of MoMA tenure

In June, the Museum of Modern Art announced that Barry Bergdoll will succeed Terence Riley, AIA, as Philip Johnson Chief Curator of Architecture and Design. Bergdoll, who is currently the chair of the art history department at Columbia University, says he is taking the job at a time when architecture exhibitions are in vogue. Not long ago, mounting an architecture show “was a way for a museum to empty out its galleries,” he says. “Now it seems to be a way to fill them.”

The problem for Bergdoll is that other New York museums seem far ahead of MoMA in exploiting the public's infatuation with architecture. The Guggenheim (where the current Zaha Hadid exhibition runs through October 25) is planning shows on Frank Lloyd

Wright, Eero Saarinen, and Le Corbusier in conjunction with the 50th anniversary of its Wright building, while the Whitney Museum has a Buckminster Fuller retrospective in the works. And the Metropolitan Museum of Art has scheduled a show on the architecture of Frank Stella. Meanwhile, MoMA, which Riley left in April, has only one show in the pipeline: a survey of the relationship between art and science curated by Paola Antonelli and tentatively set for 2008.

Bergdoll won't move to MoMA full-time until January 1, and he will continue teaching at Columbia. But he says he plans to spend the fall “in overdrive,” developing programs for the museum.

The historian's academic interests include not only 20th-

century stars like Marcel Breuer, but Karl Friedrich Schinkel and Leon Vaudoyer. Bergdoll says he has no plans to present shows on the pre-Modernists.

His main focus will be the 20th century—and the 21st. In addition to what he calls “monographic shows,” he expects to mount shows on “process,” including, most likely, digital fabrication, which he says is changing the “command structure” by allowing architects to assume responsibility for making the things they design. He says his interest in the topic was piqued when, at Columbia, he worked with Marble Fairbanks Architects on a slide library made from digitally produced components.

While developing ideas for exhibitions, Bergdoll is also looking to fill two curatorial positions that were left

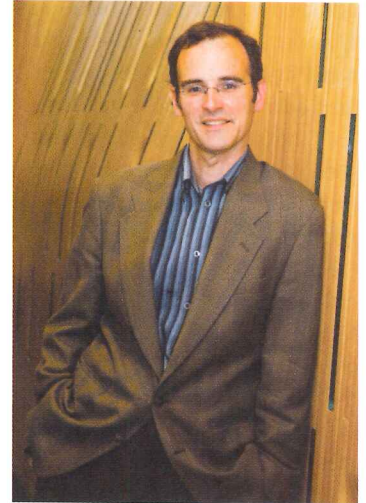

Columbia's Barry Bergdoll takes over Riley's MoMA role in January.

open as Riley's tenure was ending. “One of the most exciting parts of this is that it's not just about taking over the helm; it's about putting together a team.” *Fred A. Bernstein*

Childs unveils final design for Freedom Tower

To mark the end of design development on the World Trade Center Freedom Tower, in June, David Childs, FAIA, of Skidmore, Owings & Merrill, presented several final drawings and maquettes to an audience of 700 architects, engineers, and clients at the AIA New York Chapter's 2006 Design Awards.

“The building is remarkably the same as the one I unveiled a year ago,” Childs said, but he stressed three significant design refinements. The building's antenna, for example, will be a closed form; Childs

and collaborator Kenneth Snelson originally proposed an open lattice-work. This final iteration features a

lozenge shape that tapers to a point, and the weblike frame is slightly visible underneath it. Childs said the iconographic element will still have the quality of lightness, and suggested that it would be programmed with light displays and other dynamic features.

In addition, the glazing surrounding the building's 69 office floors will eliminate spandrels. Each

glass component will stretch to the floor's full, 13-foot-4-inch height. This feature offers “a unique character of monumentality,” Childs said. “It also provides a marker in the sky of the most important place, the memorial itself.”

Childs confided that he “wasn't sure” of the ultimate evolution of the building's base. Safety concerns forced the design team to wrap the bottom, 186-foot-tall portion in a wall of concrete that is almost uniformly 3 feet thick. “The concrete could have looked like a barracks,” he said. The solution: Two thousand sheets of prismatic, laminated safety glass will clad the concrete. The 4-by-13-foot panels feature prisms of different depths; the variety is meant to animate the skin with abstractions of shadows and colors that move according to weather

conditions, or with the changing perspective of the viewer. “Most consistent with the building would be to build the space out of glass,” Childs noted. “This is a friendly, warm plinth to the shaft above it.”

The multifaceted skin will fold and morph into seating at the plaza level. Childs is working with Peter Walker, who is also the memorial's landscape architect, on this aspect of the project.

World Trade Center developer Larry Silverstein introduced Childs at the ceremony. He promised listeners that the Freedom Tower—for which below-grade excavations, footings, and foundations were begun in April—would be ready for occupancy by 2011, and the entire site completed the following year. *David Sokol*



The Freedom Tower design has been finalized.

Record News

Dispatch from the 2006 London Architecture Biennale

This year's London Architecture Biennale (LAB), the city's second, attracted approximately 75,000 visitors over 10 days in June—despite public funding issues and protests from animal-rights activists.

The festivities kicked off with a sheep drive. Richard Rogers, Renzo Piano, butchers, and shepherds guided a flock of 30 sheep and thousands of onlookers along a city-center route, crossing the Millennium Bridge and passing a crowd of animal-rights protesters on the way. Enabling the shepherds to exercise historic droving rights was meant to highlight the huge urban changes that have occurred in the capital over the centuries.

Coinciding with Britain's annual Architecture Week celebration, LAB

was planned as a "contrast to the Venice Biennale, where star architects flew in, showed off completed models and projects, and flew out again," LAB director Peter Murray said. "The place was fairly irrelevant."

London is currently going through a period of change that is "greater than at any time since the Victorians," Murray explained. The Biennale's theme this year was "Change": About 200 public events and exhibitions—including what is billed as the world's biggest Pecha Kucha (Japanese for "chit chat")—engaged in discussions about the past and future of London. Plans for a Biennale radio station, however, were axed for lack of funds; LAB organizers received only half the money that they were expecting from the Arts



Architects Rogers and Piano (in T-shirts, left and right) joined in the LAB launch.

Council development agency.

"London Architecture Biennale," said an Arts Council spokesperson, "requested sums to make capital changes to a building that would act as the Biennale Hub for two weeks. This was not considered value for money in relation to our financial criteria for grants for the arts."

Murray, who was forced to raise

the shortfall, had expected that the public funding "would reflect the growth of the Biennale." Indeed, compared to 2004, this Biennale grew threefold. Plans for further extensions in 2008 will largely depend on funding. "It would be really nice to find somebody who'd come in with quarter of a million quid," Murray quipped.

Robert Such

Hugh Stubbins, architect of landmarks, dies at 94

Hugh Stubbins, Jr., the Cambridge, Massachusetts, architect who died on July 5 at age 94, will best be remembered for the slant-topped Citicorp Center in midtown Manhattan. The slender, 914-foot tower was designed to snap the boredom of what Stubbins called "the new, slick, slab buildings that march up the avenues." Completed in 1978, Citicorp was clad in alternating bands of aluminum and glass and capped by a 160-foot-high roof pitched at 45 degrees. Its large public plaza, which provided enough airspace at ground level to build a new St. Peter's Lutheran Church, and its unique three-story market energized the streetscape.

Citicorp exemplified a lifetime of innovation and achievement. Stubbins was born January 11, 1912, in Birmingham, Alabama, and graduated from the Georgia Institute of Technology in 1931. A nationally ranked track star in college, a pulled hamstring kept him

out of the Olympics. He received a master's from Harvard Graduate School of Design (GSD) in 1935, then worked for a firm that designed Cape Cod-style homes, although he championed Modernism. Walter Gropius invited

Stubbins to teach at the GSD, where he remained for more than a decade. During that period he was best known for the Berlin Congress

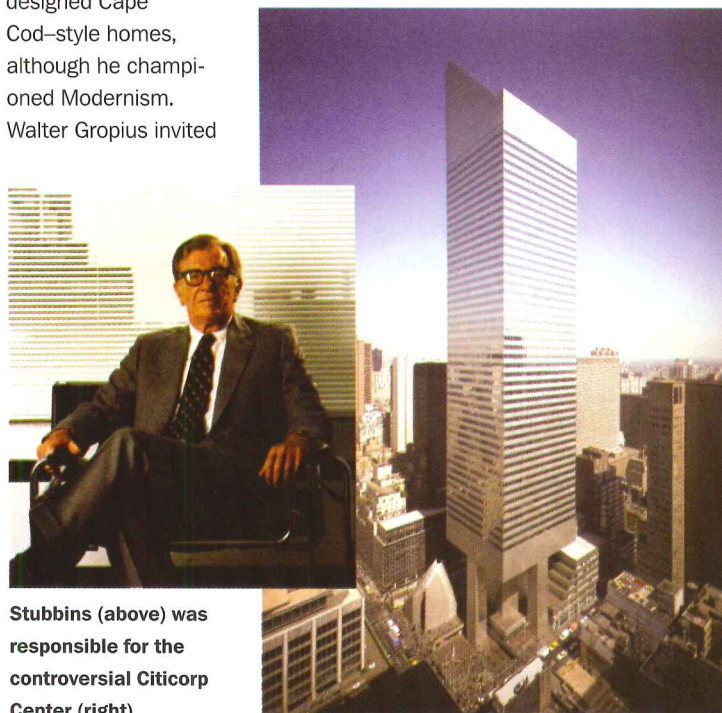

Stubbins (above) was responsible for the controversial Citicorp Center (right).

Hall, which got the nickname the "pregnant oyster" after the shape of the roof's concrete shell.

Over the next 50 years, Stubbins's firm designed more than 800 buildings, many of which sported firsts and won superlatives. Citicorp pioneered the use of a tuned-mass damper in tall buildings. Congress Hall was the largest effort at employing concrete shell technology at the time. And his last design, for Landmark Tower in Yokohama, Japan, mixed templelike corners and modern engineering in a flexible skeleton meant to absorb earthquake shocks. "I think his personality was formed by the period," says Stubbins Associates director of design C. Ron Ostberg, AIA, who joined the firm in 1984. "Coming out of the Second World War, there was a tremendous optimism that architects were going to build America. He was enthusiastic and he was self-confident. The attitude in this country today is, in my opinion, extremely different." Greg Goldin

Details, details, details...

The stainless steel bollard.



BEGA sets the standard

www.bega-us.com
805.684.0533

No. 149

Controversy over plans to renovate Aalto interior

Alterations to a quiet poetry room, designed by Alvar Aalto for Harvard's Lamont Library, have sparked protest from members of the university's Graduate School of Design (GSD) and others in the preservation community. The work is currently under way inside the Woodberry Poetry Reading Room, which was designed in 1949 and is one of only four Aalto projects in America. The 1,030-square-foot room was designed for the intimate enjoyment of poetry. Four consoles were equipped with record players, and ambient lighting and comfortable seating enhanced the contemplative atmosphere.

The Woodberry is cited as a fine example of both midcentury interiors and of Aalto's execution of design that completely integrates finishes, furnishings, and lighting. Toshiko

Mori, FAIA, chair of the Department of Architecture at GSD, calls this room "one of the greatest examples in this country of total design."

Harvard plans to update the room's technological capacity and replace worn-out elements. Two of the consoles have been removed, and the remaining two will be converted into reading tables. One of the bookshelves is cited as a security concern and will be taken out to provide librarians with an unobstructed view. Also, the room will be equipped for computer use; digital recordings will coexist with vinyl. Einhorn Yafee Prescott principal David Fixler, AIA, the historic preservation specialist consulting on the project, says the rest of the room will be untouched.

Mori spearheaded the faculty protest and has, along with GSD alumnus Frederic Schwartz, FAIA,

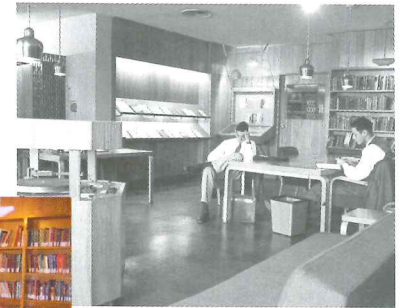
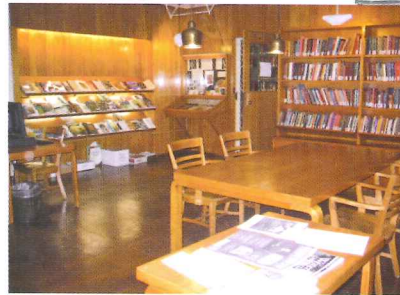

Harvard says the 57-year-old Woodberry reading room needs freshening up.

Fixler calls Mori's response an "overreaction,"

noting, "Preservation is about adapting buildings and managing change." He adds that Aalto would have disapproved of freezing the room in a historic moment.

With backing from historic preservationists as well as from faculty from Harvard and other institutions, Mori hopes to force a reconsideration of the renovation. The project, which began June 9, was originally scheduled for completion by September. *John Gendall*

initiated a letter-writing campaign against the project. Mori learned of the renovation from an anonymous letter and has requested a stay of execution on a "very drastic renovation that removes any trace of Aalto."

"This reading room is highly significant and quite rare," says John Stubbs, World Monuments Fund vice president of field projects, who has gotten involved with Mori's campaign. "It should be a gem in the crown of America's greatest university."

Mixed-use complex to replace Saarinen lab



Ma Bell facility will be demolished.

In April, the future owner of the Bell Telephone research facility in Holmdel, New Jersey, announced that he would demolish the signature building of the Eero Saarinen-designed complex once the sale is finalized. In a recent interview, Preferred Real Estate Investments founder and C.E.O. Michael O'Neill sketched out the company's plans for the site.

O'Neill says that the 2-million-

square-foot laboratory, completed in 1962, does not have adaptive-reuse potential: "This building was built for a single purpose, and that purpose no longer exists. There is nothing usable here." Saarinen had unified Bell's entire R&D program under one roof, with interior spaces articulated for specific purposes.

In addition, O'Neill says that the mirrored-glass curtain wall, which

contributed to the status of the building as a celebrated piece of Modern architecture, is energy inefficient.

Preferred's master plan for the 472-acre site retains the water tower and artificial lakes from Saarinen's original design. The lab building will be replaced by three or four smaller low-rises dedicated to corporate and pharmaceutical facilities, as well as restricted-age housing. *J.G.*

Factory designed by Albert Kahn is now progressive mixed-use building

Not every Modernist marvel is destined for the trash heap. In August, tenants will start taking occupancy of phase one of a redeveloped Ford plant in Richmond, California, that was designed by Albert Kahn in 1930. The 517,000-square-foot, National Register building will contain a city in miniature: residential and office space, a performance venue, shops, and light industrial uses.

Local firm Orton Development acquired the building in 2004 from the City of Richmond, which had taken possession of the structure in 1975. Orton retained Marcy Wong & Donn Logan Architects to oversee the resurrection of the building, which had been damaged in the 1989 Loma Prieta earthquake. Wong says that Kahn's "practical solutions for assembly-line mass

production," such as long structural spans and sawtooth skylight monitors, suit an adaptive reuse that is "consistent with the original architectural rhythm of the building's structural and fenestration systems." Moreover, the waterfront location, which Ford required for transportation purposes, "means unobstructed, sensational views of the Bay and San Francisco and

Marin County beyond."

The complex, renamed Ford Point, also will be distinguished by the 75,000-square-foot performance space retrofitted into the factory's former craneway—with one of the machines still intact. Wong says the space will host arts as well as sports events; Orton expects it to be completed by the spring of 2007. *D.S.*

UNCONTROLLED, WATER SHAPES NATURE.

Controlled,
it can shape
our future.

The Sloan Water Conservation Division was established to identify and develop the most advanced plumbing conservation systems — products which control water and contribute toward LEED® credits. Sloan is **THE** Water Conservation Company.

- **Solis™ Solar-Powered Faucet**
- **Waterfree Urinals**
- **FLUSHMATE® 1.0 gpf Pressure-Assist Units**
- **Crown® HET Flushometers**
- **Dual-Flush Flushometer**
- **XLerator® Hand Dryers**



For more information call
800-9-VALVE-9 (800-982-5839) ext. 5609
www.sloanvalve.com

CIRCLE 18 ON READER SERVICE CARD OR GO
TO ARCHRECORD.CONSTRUCTION.COM/PRODUCTS/

In China: Sloan Valve Water Technologies (Suzhou) Co. Ltd.
Suzhou New District, China • www.sloan.com.cn

U.S. Mayor's Conference president says 2030 Challenge is realizable

In May, the U.S. Conference of Mayors unanimously adopted the ambitious 2030 Challenge [RECORD, July 2006, page 158]. The resolution calls for an immediate 50 percent reduction in fossil-fuel energy consumption in new and renovated buildings, and it seeks to eliminate fossil fuels from new construction by the year 2030.

The president of the U.S.

Mayor's Conference, Dearborn, Michigan, mayor Michael Guido, says soaring energy prices and global warming research impelled the mayors to adopt the 2030 Challenge: "If we don't meet greenhouse gas reduction targets, [then] there will be catastrophic climate change."

The country's mayors have tools at their disposal through which they

can change energy policy, Guido adds. "Cities build buildings—whether that is the local schoolhouse or the fire station. We are consumers of building materials so we can have an influence," he says. "And with zoning and building codes and other tools, we can have an additional influence on the general public's concept of what constitutes a good building."

Guido says that Chicago, San Francisco, Salt Lake City, and Seattle have taken steps toward mandating a greener built environment. But the mayors have just gotten started. "We are going to take up the Challenge in October at our energy summit, which is where our resolutions come to life, and from there we take the show on the road." *Alex Ulam*

First cradle-to-cradle house built in Roanoke

The Roanoke, Virginia, neighborhood of Gainsboro may be an unlikely place to find America's first cradle-to-cradle (C2C) home. But this month local architects Stephen Feather, AIA, and Richard Rife, AIA, will complete a 1,623-square-foot, two-bedroom house that is designed according to those sustainability principles.

Feather and Rife's design was one of 625 entries in a 2004 international competition to apply architect William McDonough's C2C protocol to residential construction. Local firm SmithLewis Architecture arranged the competition when Roanoke officials

hired firm Principal Gregg Lewis, AIA, as consultant to jump-start the city's neighborhood revitalization initiative.

"We feel that sustainability needs to be part of the discussion," Lewis says of the decision to launch the competition as a way to solicit the best designs. Several other C2C submissions are now in various stages of development.

This inaugural project features locally harvested wood, low-VOC interior finishes, a geothermal heat pump, and roof-mounted photovoltaics. It was also designed for modular production, although this



The C2C house fits in with the neighbors.

example was stick-built. "We hope our C2C house will be an impetus to get the industry involved in green building; we see this as a way to

make green building more affordable and more mainstream," Rife says.

When complete, the house will blend aesthetically with the modest Southern homes surrounding it. To Lewis, what began as "an incredibly rich design problem" now promises to be an engine for redevelopment. "All of

a sudden you have this gem on the block," he says. "People will be motivated to reinvest in the community." *Violet Law*

2006 COTE winners reflect green trends

A decade ago, Gail Lindsey, FAIA, remembers "begging and pleading" friends to submit the 14 projects needed to be considered for the first Top Ten Green Projects program, which she began as chair of the AIA Committee on the Environment (COTE). Times have changed. This year's crop was chosen from more than 70; where entries were once limited to homes and environmental centers, the winners range from a Paul Rudolph-inspired home to a dog-adoption park to a warehouse turned corporate headquarters.

The 2006 Top Ten list was announced this spring. While exemplary, it also takes the pulse of green building in the U.S., according to

Lindsey and Henry Siegel, FAIA, a member of the COTE national advisory group that revised the Measures of Sustainable Design last year.

For example, Siegel says, "In my perception, some architects think that sustainable design is all about the technological solution—they don't get that an architect has a lot of influence about how they shape it and shade it." The 56,000-square-foot Benjamin Franklin Elementary School in Kirkland, Washington, demonstrates that they're coming around. Mahlum Architects deployed natural ventilation and used the surrounding forest as a protective screen to eliminate unnecessary systems—including ceiling fans. (As part of last year's metrics

revisions, such passive design elements were given more prominence on COTE's Top Ten application.)

This year's list also confirms that green design is developing its own aesthetic vocabulary. "We don't mean tacked-on solar panels," Siegel says, "but integrating it in a meaningful way." The Solar Umbrella House in Venice, California, designed by Pugh + Scarpa, was inspired by Rudolph's 1953 Umbrella House, but clads its canopy in photovoltaics. Lindsey and Siegel add that buildings like Seattle's Ballard Library, by Bohlin Cywinski Jackson, are more sustainable because communities are less likely to knock down beautiful designs.

The buildings also may be har-

bingers of change. More green buildings emphasize long-term evolution, and what Lindsey calls a "regenerative" stance toward context. While Susan Maxman & Partners renovated the Motherhouse convent in Monroe, Michigan, with an eye to ecological targets, it was also prepared for reuse when its order of sisters can no longer use it.

Even if the Top Ten program doesn't pave the way for evolution in green building, there's a good chance that architects will feel its effects: The AIA, Siegel says, is considering adapting COTE's rigorous submission process to its other honor award programs. This year's winners can be viewed at aiatopten.org. *D.S.*

SHAKEN OR STIRRED? PRECISELY HOW WE FELT WHEN WE SAW IT.

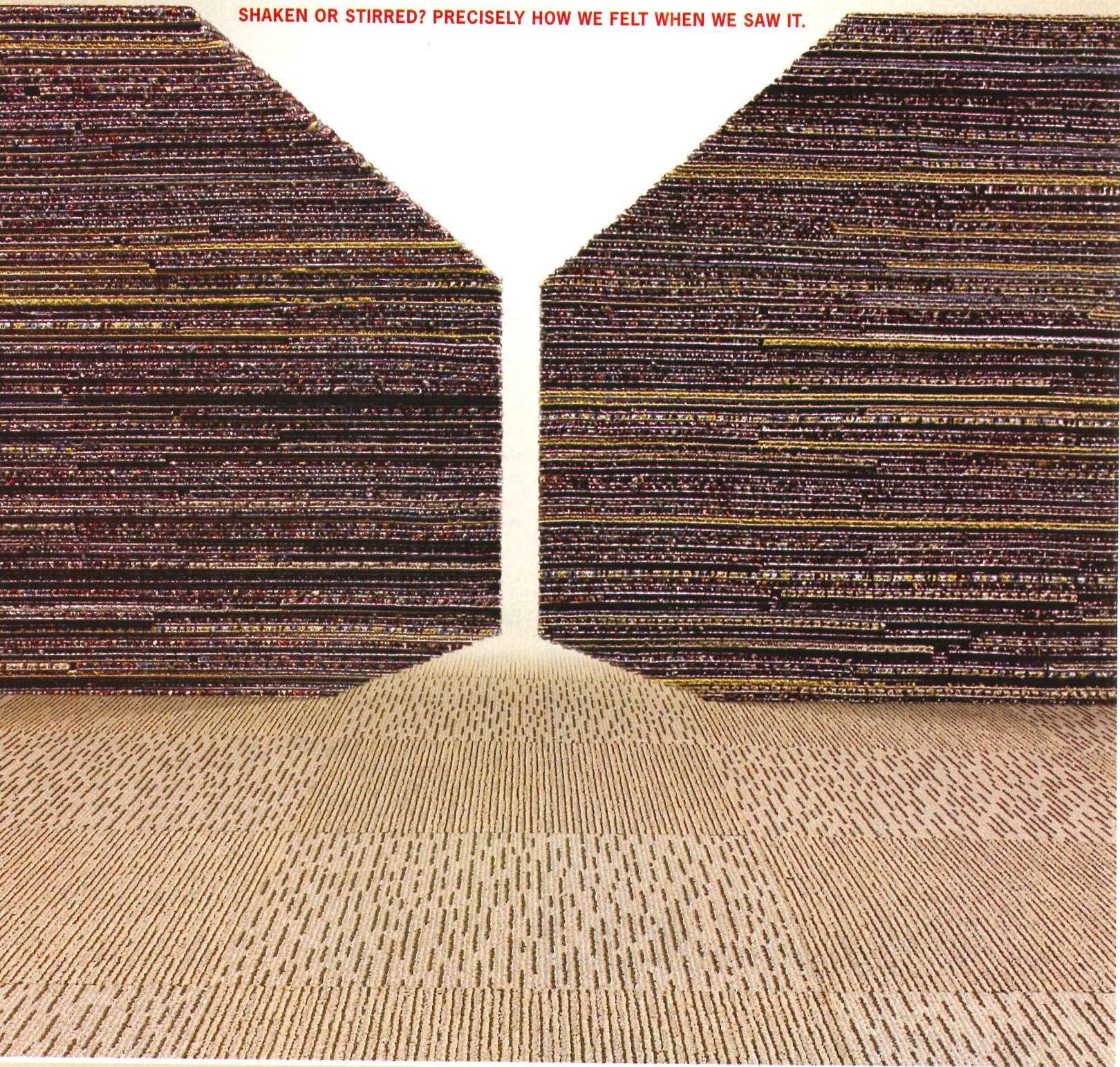

Shaken or Stirred? Two new coordinating Nexus™ Modular products from J&J Commercial complement one another beautifully. With nine colorways, you'll never question whether Shaken or Stirred look great on the floor.



J & J C O M M E R C I A L

Carpet for spaces that work.

Carpets: Shaken or Stirred? Color: Dry - www.jjcommercial.com - 1.800.241.4585

CIRCLE 19 ON READER SERVICE CARD OR GO
TO ARCHRECORD.CONSTRUCTION.COM/PRODUCTS/

ASLA retrofits headquarters with green roof

The American Society of Landscape Architects opened a green roof on its Washington, D.C., headquarters in conjunction with Earth Day this year. "We wanted to show how you can maximize both the environmental benefits and the aesthetic and amenity benefits of a green roof through the landscape architect's design," says Nancy Somerville, executive vice president of the ASLA.

The 3,300-square-foot roof, the design of which was led by New York-based Michael Van Valkenburgh Associates, replaces a standard black tar surface on the 10-year-old brick building. Visitors to the roof climb a staircase to reach an aluminum-grate landing suspended

above various succulents. Sweet fern and fragrant sumac grow among other plants in deeper soil on the roof over the staircase platform. Two formerly imposing air-return units are also hidden within slopes of semi-intensive plantings that include African ice plants, evergreen moss flox, and various leafy stonecrops, anchored by a system of steel cables. "Having blooming plants around you at and above eye level is a very different experience from having them just around your feet," Somerville says, adding that the roof feels cooler than neighboring roofs, giving visitors an "oasis feeling."

Roof accessibility was key but costly, with a staircase and entryway

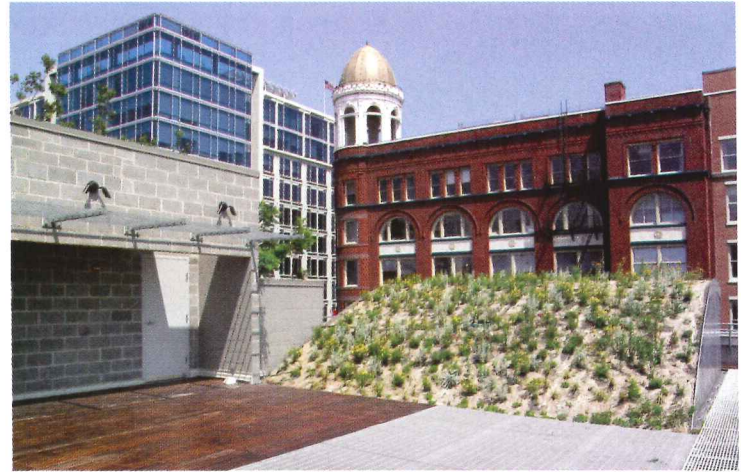

An air-return unit is transformed into stadium seating for plants.

taking up two thirds of the \$950,000 budget. The narrow building envelope limited room for construction staging and storage, thereby increasing labor costs. ASLA officials also cite high materials costs in the wake of Hurricane Katrina.

The ASLA has ongoing plans to

monitor the project and share findings to help further green-roof development: flow meters are being fine-tuned to gauge the roof's storm-water retention, and temperature readings will be compared with those from an adjacent non-green roof. *Paul Burkhardt*



The subterranean Stuttgart Main Station, a Holcim Gold winner, was commended for reclaiming above-ground public space and reducing energy consumption.

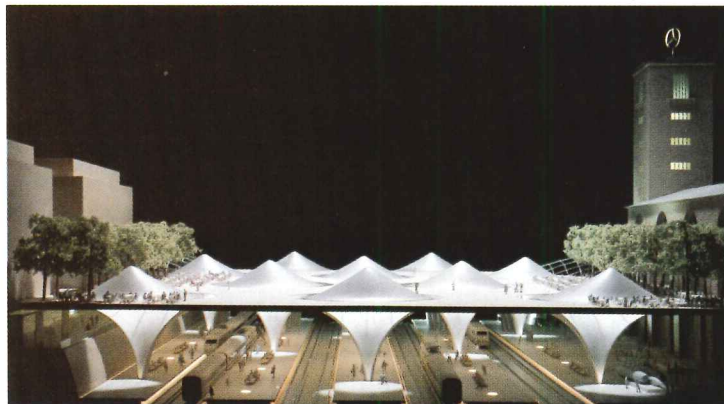

Cash awards for eco buildings announced

The Holcim Awards, the first global competition for sustainable construction projects, awarded \$1 million in prize money at a ceremony in Bangkok in April. One \$300,000 Gold Prize went to Ingenhoven Architekten of Düsseldorf, Germany, for a new main train station in Stuttgart, and another to Proyectos Arqui 5 CA of Caracas for an infrastructure project in a shantytown located in the Venezuelan capital. The \$250,000 Silver Prize went to a team coordinated by Luigi Centola and Mariagiovanna Riitano for a master plan for the Mulini Valley in Italy. Daniel Pearl, with Mark Poddubiuk and Bernard Olivier of Montreal-based L'Office de L'Eclectisme Urbain et Fonctionnel, received the \$150,000 Bronze Prize for an urban-renewal project in Montreal that stressed community involvement and incorporated high-performance building technologies.

The announcement culminated three years of forums and regional competitions underwritten by the Holcim Foundation, which is endowed by Swiss cement company Holcim.

The international jury included architects Enrique Norten, Thom Mayne, FAIA, and Adele Naude Santos, FAIA.

Because development pressures and needs vary throughout the world, criteria for sustainable design are often applied differently in different regions, says Adele Santos, who served as jury head and who is dean of the MIT School of Architecture and Planning. Choosing winners from such a wide range of building practices required evaluating social equity, economic performance, and ecological impact. "In Africa and Latin America, there was more emphasis on building sustainability into community development, whereas in North America and Europe, the solutions were more technologically oriented and generally within the green-building arena," Santos says.

The United States failed to rank. Santos reasons that the competition wasn't well publicized here, and that Americans are relatively new to sustainable design. "In Europe, building in a sustainable way has been going on for a while," she says, adding, "Here the clients don't think long-term." *A.U.*

Cool Savings

Save up to 15% on energy costs with our cool roof pavers. Reflecting up to 70% of the solar energy, Wausau Tile's Cool Pavers are compliant with California's Title 24 for cool roofs, enabling you to transform any rooftop area into a usable, energy-efficient surface. Now available in a variety of colors and sizes to meet your needs.



These Benches are too Cool

Reflecting on our successful cool pavers, we put the same technology into our cool benches. Reflecting the solar rays keeps these colorful benches cool. Choose from a wide variety of colors.



You've got our guarantee. Wausau Tile guarantees that Cool Pavers meet Energy Star ratings.

WAUSAUTILE
America's One Source™



www.wausautile.com • 800.388.8728

Head of the Glass

Developed in conjunction with Columbia University, all of our concrete based products, more than 800 of them, are available with recycled glass. From our modern Signature Line of site furnishings, to our colorful Thin Terrazzo Tile products, recycled glass will add magnificent colors to your projects.



WAUSAUTILE
America's One Source™



www.wausautile.com • 800.388.8728

CONCRETE THINKER DAN KAPLAN

“CREATING VIBRANT URBAN ENVIRONMENTS
IS THE KEY TO SUSTAINABLE DESIGN.”

AMBITIOUS URBAN SPACES

Dan Kaplan is driven by a new vision of architecture that uses sustainable design to strengthen communities and the environment. Compelling models of density reduce sprawl and energy usage, revitalize the urban landscape, and bring people together.

CONCRETE MAKES IT POSSIBLE

Using more than 34,000 cubic yards of concrete, the Mosaic is an immense urban regeneration project that will integrate housing, parkland, retail, and cultural uses in one dynamic complex. The project—with its concrete structural system—spans over old infrastructure on Manhattan’s West Side, repairing the urban fabric and creating an attractive setting for people to live, work, and play for years to come.



Dan Kaplan, AIA
FXFOWLE ARCHITECTS

Join Dan and other Concrete Thinkers who are creating their legacies with sustainably developed buildings by relying on the durability, versatility, and energy efficiency of concrete.

Visit the new www.concretethinker.com, a comprehensive toolkit for architects rich in content, technical resources, and creative ideas.



Concrete Thinking
for a sustainable world



Portland Cement Association

Chicago's Green Permit Program exceeds expectations

When it is completed in early 2009, the 60-story 300 North LaSalle tower will be one of Chicago's taller structures. But local real estate players may take closer note that developer Hines Interests snatched a building permit faster than average, too—in a speedy 30 days.



300 North LaSalle finds it easier being green.

The 1.3-million-square-foot office tower is one of a growing number of buildings participating in Chicago's year-old Green Permit Program, which expedites permitting for sustainable buildings. Designed by architecture firm Pickard Chilton, the building will have a 50 percent green roof and will use condenser water supplied by the Chicago River, thus eliminating cooling towers. Hines vice president of construction Scott Timcoe says that while the building was green anyway, the company applied to the program because "there is a huge construction boom in Chicago—sometimes getting a permit can be really laborious."

With the support of Chicago's Mayor Richard M. Daley, the city's Department of Construction and Permits initiated the program in April 2005 to "encourage the use of green incentives, especially in private development, and to make sure that they're doing it well," says Erik Olsen, who has been the program's chief administrator since its launch.

Projects fall into one of three tiers, and greener projects gain greater benefits.

The owners of Tier I commercial and other nonresidential projects, including 300 North LaSalle, promise that they will be LEED-certified. These buildings also feature one item from a "menu" of sustainable building strategies that include, among others, a green roof, extra affordability, and transit-oriented development. Owners who accomplish LEED Silver building with one menu item advance to Tier II, which waives the consultant review fee in addition to granting permits in 30 days. Tier III projects must earn LEED Gold and feature two menu items, for which the consultant fee is waived and a permit issued within 15 days. Olsen explains that LEED status verifies an application (residential projects must conform to the Chicago Green Homes rating system), while the menu items act as billboards for sustainability.

Olsen first sits down with project teams several months before they make permit submittals. Applicants view this extra attention as an added benefit: "We received good advice from Erik and his department, which found its way into the design of the building," says Roark Frankel, senior vice president of U.S. Equities, project managers for the Spurdis Institute for Jewish Studies, a Tier II building currently under construction.

Granting incentives at such an

early stage in a building's development can be problematic. Besides submitting a LEED project registration number as part of a permit review, developers must file a proof of submission for LEED certification within 180 days of completion. They are also required to sign contracts binding them to their sustainability plans, and there are considerable consequences—fee reimbursement or permit revocation, for example—for not following through.

And yet, by the end of the 2005 calendar year, 19 green permits were issued for projects, and 36 permits have been issued so far this year, which puts the program well on track to meet its goal of 40. Olsen says that nonprofit and university owners took to the program the quickest, but that it now spans a fuller range of building types.

Although there are no other cities with a program as comprehensive as Chicago's, Olsen has received inquiries from cities as far as Seattle and Toronto. In Washington, D.C., the organization GreenHome is pushing for local legislation for a green permitting system because, as GreenHome's executive director Patty Rose says, "Erik is running a program that is moving green building faster through permits, and I'm convinced that he's actually helping make better green buildings." *Amanda Webb*

Big bucks for green-roof retrofits in Chicago

A cool hundred grand: That's what the city of Chicago is offering downtown building owners to combat the urban heat-island effect. In June the city council approved the \$500,000 Green Roof Improvement Fund, a tax-increment financing pilot program. It authorizes the Department of Planning and Development (DPD) to award grants as large as \$100,000 for retrofitting buildings

with green roofs.

The ordinance applies to the 40-square-block Central Loop District, which Green Projects administrator Michael Berkshire says is one of the city's most severe zones for heat-island warming as well as storm-water runoff. Building owners who are considering planting their roofs either apply online at the DPD's Web site (which will also feature information regarding green

roof designers, contractors, and other resources) or by contacting the department directly. Successful applicants will be reimbursed for half of all expenses up to the \$100,000 limit. Even though Berkshire reports that Chicagoans are currently cultivating 2.5 million square feet of green roofs across 200 projects, he admits, "There is risk: This is a new venture in the U.S. and cost is the main impediment."

City assistance should ease that pain. Green-roof retrofits cost \$10 per square foot on average, Berkshire says, and most downtown buildings' roofs measure 10,000 to 12,000 square feet. By that calculation, he hopes to fund as many as 10 retrofits by the end of the year. If the funds dry up, then the program is a success and, he notes, "We'll move to more districts." *Kevin McCarthy*

SAVE THE PLANET. SCORE POINTS.



Every VT door can assist you with LEED points. Because no matter which color you choose, all VT doors are green. VT uses earth-friendly cores in each masterfully crafted architectural wood door. Some even offer the option of FSC-certified material. And you'll also have your choice of either veneer or HPDL face material. VT Architectural Wood Doors. Give the earth a break—they're the perfect way to score LEED points for any project. For more information, call 1.800.827.1615, EXT. 345.



**Architectural
Wood Doors**

WWW.VTINDUSTRIES.COM

CIRCLE 21 ON READER SERVICE CARD OR GO
TO ARCHRECORD.CONSTRUCTION.COM/PRODUCTS/

Record News

Architects, decorators, artists stop being polite on new HGTV program

A flamboyant artist, a former Miss Utah turned decorator, and three Harvard Graduate School of Design (GSD) graduates, among others: Their worlds collide on the new *HGTV Design Star*—and it turns out that these reality-show participants aren't so different, after all. They're all competitive, self-promoting, and have that certain telegenic something.

The new, eight-installment series is *Project Runway* meets *Trading Spaces*: Ten designers, formally educated or self-proclaimed, compete in weekly residential-design challenges that force one elimination per episode (expect double slaughters in the show's third and fourth installments). *HGTV Designed to Sell* host Clive Pearse plays mother hen, while the panel of judges includes *In Style* mag-

azine executive editor Martha McCully, fashion designer Cynthia Rowley, and TV design personality Vern Yip. Audiences will select the victor—who lands her own HGTV series—from the final two. “This is a huge commitment for the network,” says James Bolosh, vice president of original programming. The channel is distributed to approximately 90 million American homes.

Competitors were chosen from 1,500 submissions. Was HGTV hoping to engage mainstream Americans in a dialogue with academic architecture

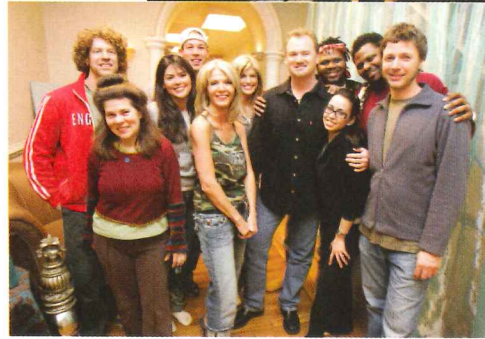

Pearse (above, at right of center, in dark shirt) and contestants posing for the camera. Contestants in the midst of their first task, a house makeover (top).

or cut a few highfalutin architects down to size? Bolosh says it was

pure coincidence that yielded Harvard GSD grads Joseph Kennard and twin brothers Teran and Teman Evans. “I think they bring something very different to the table,” he concedes. In that spirit of variety, the competition's challenges will range from decorating to

large-scale projects. “They do everything from ripping out cabinets to adding walls to resolving fish-out-of-water situations. It's not just paint and fabric swatches.”

In the July 23 premier episode, viewers learned that the trio of architects completed the first task, meeting their initial challenge. And so has the program itself. Even though the final smack-down doesn't tape until August 25, the second season of *Design Star* is already in the works. *D.S.*



Image of the Bank of America Tower at One Bryant Park courtesy of dbx. Architecture by Cook+Fox Architects.

Autodesk and 3ds Max are registered trademarks or trademarks of Autodesk, Inc., in the USA and/or other countries. All other brand names, product names, or trademarks belong to their respective holders. Autodesk reserves the right to alter product offerings

Futuristic tanks make sludge “magical”

A proposed set of structures for Washington, D.C., would lend a design sensibility to a building type not usually known for beauty: the wastewater treatment plant.

The Blue Plains Advanced Wastewater Treatment Plant plans to build a series of eight “digester tanks” on the banks where the Anacostia and Potomac Rivers meet. Sorg & Associates designed the new structures, which use microbes to convert solid waste into a product suitable for agricultural use.

Models of the digester tanks show two rows of four 108-foot-tall, egglike forms connected by footbridges and anchored by elevator towers. The tanks will be covered in a ribbed anodized cladding, which the designers say will make the towers appear “magical” and “other-

worldly.” The structures (which process 350 tons of sludge daily) will be visible from Alexandria, Virginia.

As a part of the \$311 million project, Sorg & Associates has also designed several other structures that will be clad in more conventional metal and brick to match the facility's existing buildings, some of which date to 1938. According to the D.C. Water and Sewer Authority, the first of the digesters should be operating by fall 2010, with all eight completed by 2011. *Kevin Lerner*

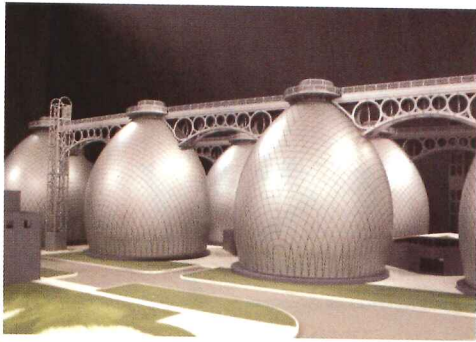

D.C.'s designer wastewater treatment plant.

Inspired by Chinese example, Livingstone says London will build a model eco city

London's Mayor Ken Livingstone announced in April that he would like to have a 1,000-home “eco city” built in the Thames Gateway district, which is located in the city borough of Newham.

Livingstone made the announcement while he was in China reviewing plans for Dongtan [RECORD, March 2006, page 46], a city that will be powered by renewable energy. Located on the island of Chongming at the mouth of China's Yangtze River and designed by Arup, Dongtan is being planned as a self-sufficient community for 500,000 people. Its first phase, for 80,000 residents, will be completed by 2020.

Greenpeace originally proposed the London plan to the London Development Agency (LDA), also working with Arup. The LDA already owns land in Newham, but the exact location of the proposed development has not been

determined. Like Dongtan, the London development would most likely be powered entirely by renewable sources such as wind turbines and photovoltaic cells. Livingstone said in a statement, “London's zero-emissions development will demonstrate that it is affordable and achievable to make all major new developments low-carbon.” He hopes to break ground within a year.

According to Peter Head, a director of Arup who is also leading the planning for Dongtan, the Thames Gateway development could be realized by 2010. Head reflected that the London effort was meant to get the attention of the marketplace: “The idea is to demonstrate that a zero-carbon development can be a viable commercial proposition. With scale comes the opportunity to make the most of renewable technology.” *John E. Czarnecki, Assoc. AIA*

An advertisement for Autodesk. The background is a night view of a modern skyscraper with a glass facade, illuminated from within. The sky is dark with some clouds. The Autodesk logo is prominently displayed in the upper right corner, oriented vertically. Below the logo, there is text describing the software's capabilities and a call to action.

Autodesk

Idea:
Show clients all the possibilities.

Realized:
Industry-leading Autodesk® 3ds Max® and Autodesk® VIZ software are the tools you need to present stunning photorealistic visualizations to your clients. They work hand in hand with your existing software and allow you to easily create and refine your ideas, giving you the best chance to win that next project.

Get the full story at
autodesk.com/onebryantpark

Autodesk, Inc. is not responsible for typographical or graphical errors that may appear in this document. © 2006 Autodesk, Inc. All rights reserved.



Mortar Net[®]
USA LTD.

Design Green Breathe Easy

A mold-free building—like a virus-free body—begins by defending the skin.

Much attention has been focused in recent years on mold caused by failures of internal systems, like plumbing and air conditioning. Thanks to that scrutiny, serious internal failures have become somewhat less common.

Meanwhile, though, moisture constantly assaults a building's exterior walls—from rain, snow, soffit-leakage, or condensation—and has done so forever. As a result, it's inevitable that moisture will infiltrate the dark cavities of exterior masonry walls.

And while moisture-penetration of masonry walls is far more predictable than moisture from internal sources, it's also far more costly to remediate. So it's vital to expel that moisture—quickly, dependably, and cost-effectively.

At Mortar Net USA, we've concentrated our full technological firepower on solving that one perplexing problem. Today, no products are more reliable than ours in defeating the "damming" effects of mortar droppings and getting rid of troublesome moisture.

That's why so many builders (of chain-stores, schools, churches, auditoriums, office complexes, and sports stadiums) specify Mortar Net USA's patented products to protect their masonry walls from harboring the moisture that can create mold. If you'd like to see the research that convinced them, please contact us.



*Use of our products may help you
obtain credits toward LEED™
Green Building Certification.*

800-664-6638

www.MortarNet.com/ar



ARCAT



CIRCLE 22 ON READER SERVICE CARD OR GO
TO ARCHRECORD.CONSTRUCTION.COM/PRODUCTS/



Standard Thermoplastic
Membrane

ReflexEON

After 18 months

IT'S A CLEAN JOB, BUT SOMEBODY'S GOT TO DO IT.

Introducing Firestone ReflexEON TPO, an enhanced thermoplastic formulation that goes on—and stays—more reflective for years, all without compromising weatherability or durability. The secret is ReflexEON's environmentally safe additives that help resist staining caused by microbial growth, as shown by over 10 years of field and laboratory testing. To help your next roof stay cleaner—and reflect longer—choose the TPO membrane that reflects brilliance—Firestone ReflexEON. Find out more at 1-800-428-4442 or at www.firestonebpco.com.

Firestone
BUILDING PRODUCTS

NOBODY COVERS YOU BETTER™

www.firestonebpco.com

CIRCLE 23 ON READER SERVICE CARD OR GO TO ARCHRECORD.CONSTRUCTION.COM/PRODUCTS/

BUILD IT QUIETER.

The people of CEMEX are experts in concrete, peace and quiet. That's why we were selected to help build the new Georgia International Convention Center, which happens to be just across the freeway from Atlanta's Hartsfield-Jackson International Airport. Where planes take off every 90 seconds. The answer to meeting their stringent sound specifications? Encase the structure in more than 25,000 cubic yards of concrete, including 7-inch slabs over meeting rooms and the exhibit hall. So conventioners can actually hear their welcoming speeches instead of the latest departures.

We invite you to learn more about this and other unique CEMEX projects at www.cemexusa.com.



CIRCLE 24 ON READER SERVICE CARD OR GO
TO ARCHRECORD.CONSTRUCTION.COM/PRODUCTS/

For and about the emerging architect

archrecord2

DEPARTMENTS

Listen. To yourself. This month, archrecord2 focuses on two architects who followed their hearts. While Matthew Hufft traveled a path that presented itself to him at age six, architect and real estate management consultant Winnie Lee found her direction through the varied jobs that came her way. Both architects discovered what makes them tick, and the results speak for themselves. Visit www.archrecord.com/archrecord2/ for more about these talented individuals.

Design

Hufft:Projects shows the show-me state

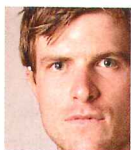

Sometimes you're just born with it. Matthew Hufft, principal of architecture firm Hufft:Projects in Springfield, Missouri, and New York City, says his parents recently uncovered a time capsule he had put together as a child. "It's a tape with my six-year-old self saying I wanted to be an architect," he says.

Those same parents—whose son by the age of 10 could either build a fence or demolish a barn with a chain saw, a hammer, and nails—eventually became Hufft's first client. Hufft had been working for Tigerman McCurry Architects in Chicago after receiving his B.Arch. from the University of Kansas in 2000 and traveling from Japan to Indonesia studying Eastern architecture, when his parents, who lived in a traditional farmhouse full of French Country antiques in Springfield, shocked him with a request. "I don't know how they got there—maybe because of all the books I had brought home during architecture school—but they told me they wanted to go Modern," he says. "They were ready to get rid of all the clutter and streamline their lives, and they asked me if I would design their new house." The "Line House," as Hufft dubbed it, took three years to create. "I was so naive," he says. "The house went from 16 drawings to 50. It's due to the patience of my parents and the contractor, whom I still work with, that it all came together." The design is based on two concepts—configurations of a line, made most prominent by a retaining wall that was needed because of the sloped site, and the idea that the house would be split into three separate sections connected by that line. Thinking, doing, and living occur separately in this house, as the library, workshop (Hufft's father loves carpentry), and living areas have their own individualized environments, with the wall in common. Hufft admits the project was a lot to take on, but since its completion, it has served a purpose greater than just providing a happy home for his family. "Most of the clients I've had go see the house before hiring me," he says. "It's become a calling card."

As an example of what Hufft can do, the house surely



Line House, Springfield, Mo., 2005

A retaining wall was essential for this home, built on a steep site. Designed of exposed concrete and modular block, the house separates activities of everyday life into individualized environments (thinking, doing, living) connected by "the line."

The Residence, Springfield, Mo., 2006

This home was conceived as two tubes, one for entertaining and one for sleeping. The structure is made of prefabricated steel and concrete, with a solid side that faces the neighborhood and a transparent side facing a lake and trees.

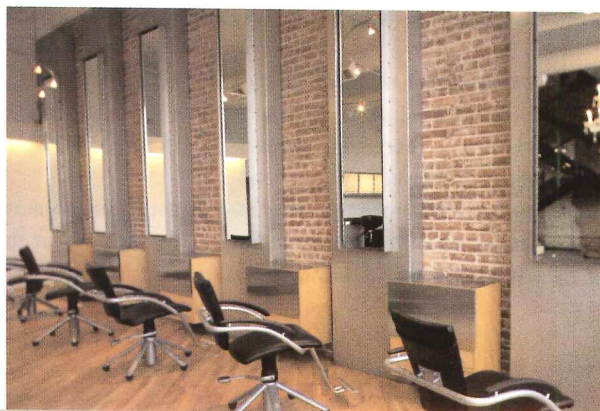

Studio 417, Springfield, Mo., 2006

This face-lift for an urban salon called for replacing storefront windows with a large glass curtain wall, and a staircase of painted steel and acrylic that appears to float over the reception desk.

delivers. He moved to New York City in 2001 to get an M.Arch. degree from Columbia University, then went to work for Bernard Tschumi Architects until last year. Now on his own, he has remained in New York to be on the pulse of the design scene, yet all of his current work is in Missouri. "Missouri is the land of awesome opportunity," says the architect, who runs an office of four people. "It feels like unexplored territory, while New York is the land of inspiration and community." Hufft currently spends three weeks in New York City and one in Kansas City, Missouri, but has plans to flip that and eventually move to Kansas City full time. "I like that in Missouri I can build things from the ground up," he says.

And while his residential clients continue to recommend him to their friends who own businesses (he recently renovated a salon and will soon break ground on a 25,000-square-foot shopping complex in Springfield for which he hopes to achieve LEED Gold status), he's also working on establishing a bathtub-fixture company called Edwin, from his middle name. "For every problem, there's a solution," says Hufft, who has found a few solutions he thinks Edwin could share with the public. Keep an eye on this one—he's now armed with more than a chain saw, a hammer, and some nails. *Ingrid Spencer*

For more photos and projects by Hufft:Projects, go to archrecord.construction.com/archrecord2/.



Kuntz Residence, Springfield, Mo., ongoing

To conform to the sloped site, this home for a family of five elbows 45 degrees. The facade will resemble two undulating ribbons: poured-

in-place concrete with punched windows on the ground level, vertical cedar siding that runs onto the decks on the second story. The roof appears to float on a steel channel above the third, glass-walled floor.

Work

Winnie Lee: Designing a career in business



Architect and real estate management consultant Winnie Lee.

Like most young architects, when Winnie Lee, AIA, graduated with her B.Arch. from Carnegie Mellon University, in Pittsburgh, she imagined a future world full of buildings of her design. And despite her architecture professors' advice to graduates to "cast a wide net" during the economically turbulent 1990s, Lee went to work for a small firm in Chicago. From that point on, however, she kept an open mind about her career, and 10 years and one M.B.A. later, she works in corporate real estate, as a management consultant for massive global management consulting firm Deloitte Consulting in Chicago.

"I currently provide consulting services to corporations with capital assets," says Lee, "and focus on areas such as portfolio management, facility strategies, and capital construction." A far cry from designing buildings, but for Lee, it seems not only satisfying, but a better fit for her personality. After graduating, she worked for a firm that was looking for ways to expand its services, and Lee was put on a project to digitize property asset information for clients. She found that she had a natural inclination for the diligent, systematic organization involved. "It was my entry into this world called real estate," she says.

From there, Lee was offered a job in New York City for a hospital's facility management department. Run like a studio, it was morphing into an atypical model—the architects in the department were the architects of record for expansion projects, and they managed projects and real estate much the way Lee had experienced at her previous job. "I transitioned with my jobs," says Lee. "And I realized that I enjoyed the management side more than getting my hands dirty. Most architects want to see their designs materialized, and they have to 'sell' their ideas

to clients. I found that on the management side I had more control of the outcome."

A few years ago, Lee went back to school, getting her M.B.A from the Stern School of Business at New York University. Armed with a knowledge of building technology and design, facility management, as well as business and finance, she joined a large firm doing predesign work emphasizing the business case of why and how much a company should build, divest, or lease. From there, she moved into corporate real estate.

Despite the pressure of often being "the only woman in the room," and the acknowledgement that some business environments are less supportive of employees having lives outside of the office, Lee enjoys the work and the salary (Lee quoted a recent *Wall Street Journal* salary survey that says M.B.A. graduates going into corporate real estate can begin with a salary range starting at \$80,000), and she defies a common accusation that success on the business side of architecture comes with a selling of the soul. "I'm giving high-level advice to very sophisticated clients," she says. "The bottom line is important, but unethical recommendations aren't even on the table. There are pluses and minuses, but I have never had to recommend anything that I know is wrong. We as architects have to put together a case, then speak the clients' language and quantify our recommendations in terms they understand. That's the challenge. I give subjective recommendations supported by objective data."

And while she has no regrets, Lee still feels a bit as if her career happened to her, rather than the other way around. She has this advice for architecture students: "Know your strengths, be mentally prepared, and check in with yourself along your path. If I could go back, I would tell my earlier self to explore different opportunities and be more aware of my career. If I had, nothing might have changed, but I wouldn't wonder where life might have taken me." *Ingrid Spencer*

For more information and salary comparisons between architect and consultant jobs for recent graduates with B.Arch. or M.B.A. degrees, visit archrecord.construction.com/archrecord2/.

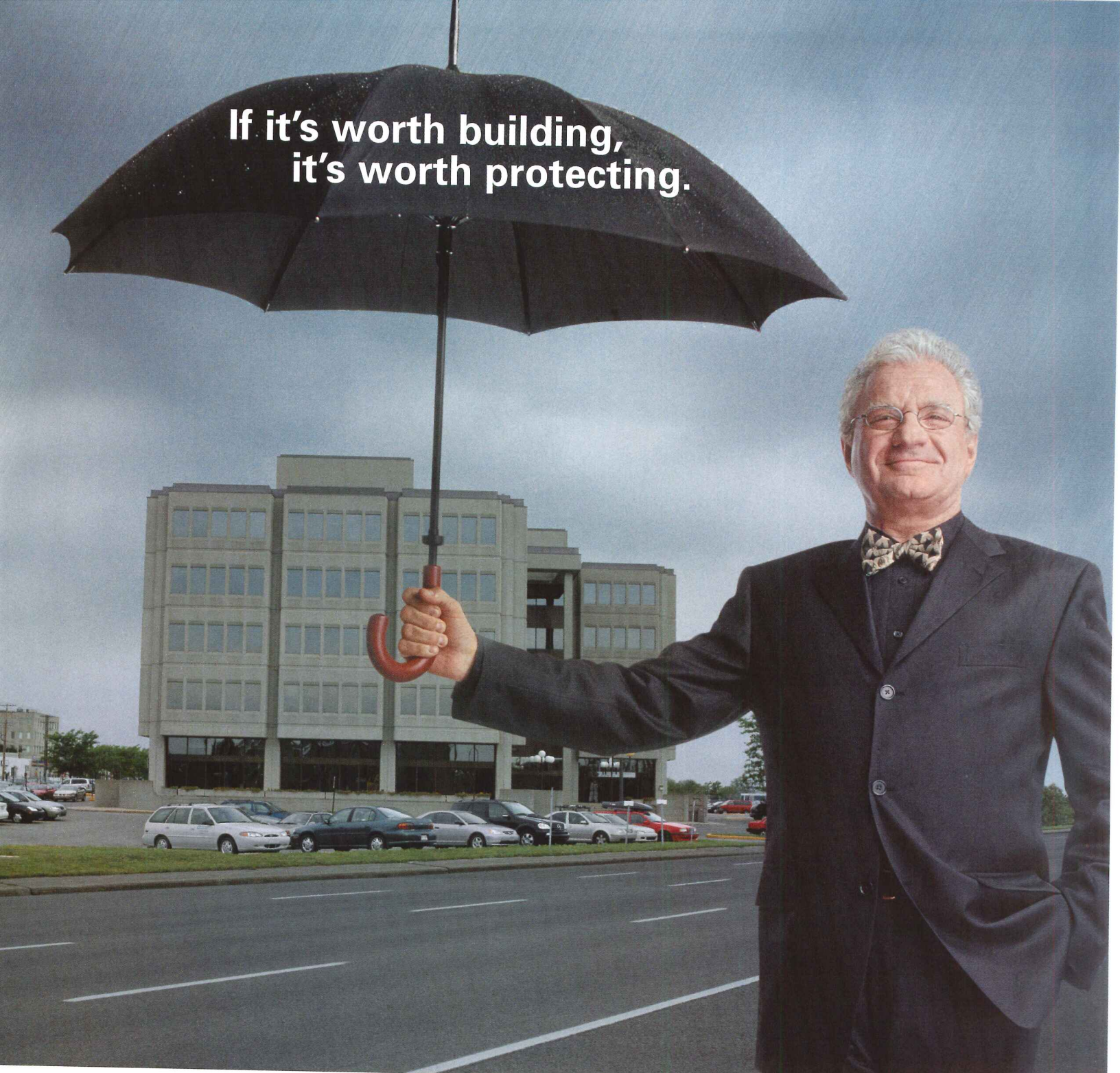

If it's worth building,
it's worth protecting.

The forecast calls for Tyvek®.

Nothing threatens the structural integrity of a building like unwanted water and moisture. That's why intelligent moisture management is so critical to sound design and construction. And why more architects now protect their projects with DuPont™ Tyvek® CommercialWrap®.

DuPont™ Tyvek® CommercialWrap® was engineered specifically to help protect exterior wall systems in today's higher-value light commercial construction. It's up to 300% better at bulk water holdout than conventional building papers. And because DuPont™ Tyvek® breathes, it helps allow moisture vapor molecules to escape the wall cavity. So walls stay dryer.

You can't do anything about the weather. But you can prepare for it, with DuPont™ Tyvek®. Find out more at 1-800-44-TYVEK® or www.TYVEK.com.

Copyright © 2006 E.I. du Pont de Nemours and Company. All rights reserved. The DuPont Oval Logo, DuPont®, The miracles of science™, Tyvek® and CommercialWrap® are registered trademarks or trademarks of E.I. du Pont de Nemours and Company or its affiliates.

CIRCLE 25 ON READER SERVICE CARD OR GO TO ARCHRECORD.CONSTRUCTION.COM/PRODUCTS/

**Tougher, stronger,
higher-performance**

DuPont™
Tyvek®
COMMERCIALWRAP®



The miracles of science™

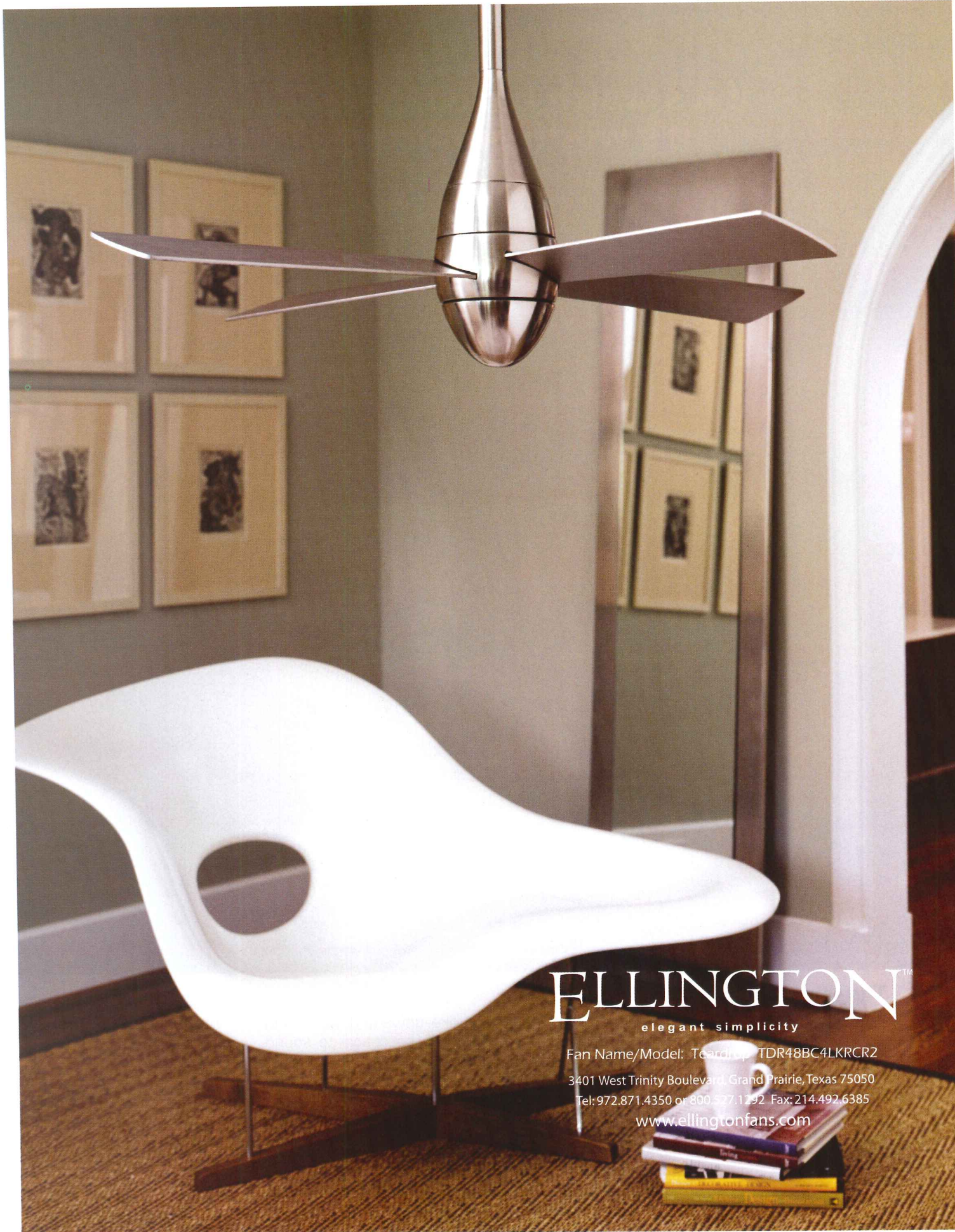

ELLINGTON™

elegant simplicity

Fan Name/Model: Teardrop TDR48BC4LKRCR2

3401 West Trinity Boulevard, Grand Prairie, Texas 75050

Tel: 972.871.4350 or 800.327.1292 Fax: 214.492.6385

www.ellingtonfans.com

CIRCLE 26 ON READER SERVICE CARD OR GO
TO ARCHRECORD.CONSTRUCTION.COM/PRODUCTS/

Living the green life: A quest for affordable and beautiful sustainability

Exhibitions

By Andrea Oppenheimer Dean

The Green House: New Directions in Sustainable Architecture & Design. Curated by Donald Albrecht. At the National Building Museum, Washington, D.C., until June 3, 2007.

"The walls between high design and environmental responsibility are crumbling," contends Chase Rynd, director of Washington, D.C.'s National Building Museum—and he has a point. Such leading architects as Renzo Piano, Glenn Murcutt, Kengo Kuma, and Herzog & de Meuron have recently incorporated significant sustainable features into their designs. As Rynd sees it, "Consumers now want their products not only well designed, but also ecologically benign."

The museum's *Green House: New Directions in Sustainable Architecture & Design* is, in part, a nuts-and-bolts primer for architects and builders, as well as homeowners, who may want to make their houses more environmentally responsible. The museum set out, according to Rynd, to illustrate that residential design can be "beautiful, affordable, and sustainable." As Donald Albrecht, the show's curator, puts it, "Going green no longer means going weird or living in a house of recycled tires."

The exhibition begins with a full-size, furnished mock-up of the main living area of the prefab *Glide House*, designed by California-based Michelle Kaufmann for a site, says the catalog, "anywhere." The interior is Modern but welcoming, and most museum visitors will easily imagine themselves living there. Which is precisely the idea: to persuade the



California-based Michelle Kaufmann designed the prefabricated *Glide House* (above) for a site "anywhere," according to the exhibition catalog. The show includes a mock-up of its main living space (rendering, top).

Exhibitions



Tasmania's Walla Womba Guest House by 1+2 Architecture (2003), raised on a steel frame, treads lightly, preserving the woodland's natural drainage patterns.

not-quite-yet converted. Glide House, named for its sliding south-facing glass wall with movable louvered screens, is configured to amplify breezes and, with a north-facing clerestory, reduce the need for electric lighting. The key features include: flooring of fast-growing (i.e., replenishable) bamboo, carpet tiles of such recycled materials as polyester and nylon, walls finished with paint low in volatile organic compounds (VOCs), countertops of recycled paper, furniture of sustainably harvested or reclaimed wood with organic upholstery, and only energy-thrifty appliances. Glide House is factory built—hastening production, reducing waste materials, and providing strict quality controls—and can be customized for each locale and client. Ten versions have been constructed, with more on order. At \$120 per square foot, totaling under \$200,000 for most versions, they cost \$83,000 less than the average American home in 2005, according to exhibition literature.

Next, visitors enter a gallery of graphic panels and hands-on displays elucidating five green principles: wise land use; attunement to the sun; high-performance energy efficiency; improvement of

indoor air-quality; and judicious approaches to the earth's resources. A heliodon (or sun simulator) shows how solar rays affect a house during different times of day and seasons.

A third gallery displays 21 contemporary green houses from around the world. The high quality and range of expression affirm Rynd's contention that the clash between environmental responsibility and high design has been resolved. The houses are organized according to location: desert, waterside, forest/mountains, tropics, suburb, and city. Some examples, rooted in the vernacular, apply such age-old materials as adobe, in new ways. Other projects incorporate new materials and technologies, such as the House with Shades (2000) in Jebenhausen, Germany, by Achenbach Architekten + Designer. Here, light and wind sensors regulate a retractable, textile shading system.

For the average homeowner, the Materials Resource Room is particularly compelling, with its 60 or so samples of green materials: carpet, flooring, paint, concrete, metal, and

The show's Materials Resource Room (right) features samples of green materials: carpet, countertops, flooring, paint, concrete, metal, and wood.

wood, all chosen for "availability, affordability, and good looks," says Albrecht. The idea, adds Rynd, is to "make environmental responsibility utterly unremarkable—an integral, if not always obvious, aspect of design." The samples show "you can start small," says David Lewis of Lewis.Tsurumaki.Lewis, the installation's designers.

The final gallery returns to the Glide House via video, showing the architect talking about her own home, one version of the Glide prototype. This gallery also revisits the principles of sustainability graphically, while Post-It-type notes pepper the walls throughout the show, defining such buzz words as "reusability" and offering tips for resource conservation.

Here is a major museum show addressing the consumer with an underlying mission to hook new

believers. The bait combines good taste and common sense with accessible, handsome images and products, as well as HGTV-type tips. For those interested in greening their homes, the presentation instructs without preaching or preening. While the exhibition offers few new ideas for the initiated, its strength lies in its essential intelligence and lovable examples.

Finally, visitors receive the take-home *Green Resource Guide*, listing the show's lessons and displayed materials or products, as well as contact information for green resources, advocacy groups, and the featured architects. Consulting curators Alanna Stang and Christopher Hawthorne have produced an excellent book to accompany the show. After it closes in D.C., *The Green House* may travel to other cities, such as New York, Atlanta, Los Angeles, and Chicago. ■



Add interest...add drama...add a ray of color!

The **New Wall Commander™ Color Ray** option

adds color to up lighting while
providing highly effective area down lighting.

Choose single color or multi-color kit.

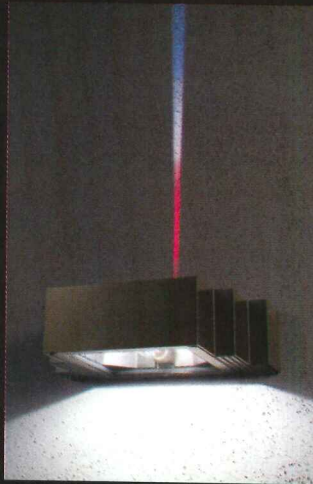

KIM LIGHTING

16555 East Gale Avenue
City of Industry, CA 91745
626/968-5666

www.kimlighting.com



Made in America

ISO 9001:2000



CIRCLE 27 ON READER SERVICE CARD OR GO
TO ARCHRECORD.CONSTRUCTION.COM/PRODUCTS/



New Lecture Theatre, Victoria University, Werribee Campus, Werribee, Victoria, Australia; Architect: Michael McKenna Pty Ltd, Melbourne, Australia

RHEINZINK® – The Material with a Future

RHEINZINK® is a titanium zinc copper alloy that is environmentally friendly with unmatched longevity and elegance, making it the ideal building material. With many detail variations possible, RHEINZINK complements both traditional and modern architecture. Curvilinear surfaces can be clad with ease due to the material's natural

flexibility. At RHEINZINK, we take great pride in our customer support, providing technical assistance to both architects and installers. With a large number of installers throughout North America and material stocked in several states, there is never a problem with material availability.

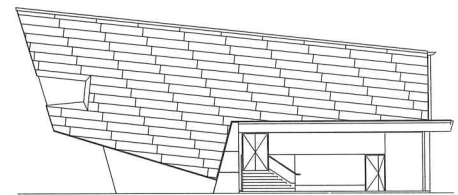

CIRCLE 28 ON READER SERVICE CARD OR GO TO ARCHRECORD.CONSTRUCTION.COM/PRODUCTS/



ENVIRONMENTAL-
PRODUCT DECLARATION
BY THE ASSOCIATION
FOR ENVIRONMENTALLY
PROOFED BUILDING
PRODUCTS NUMBER OF
CERT AUB-RHE-11105-D



RHEINZINK America, Inc., 955 Massachusetts Avenue, Suite 770, Cambridge, MA 02139
Tel. +1 (617) 871-6777, Fax +1 (617) 871-6780, E-Mail: info@rheinzink.com, www.rheinzink.com



GYPSUM NEXUS

Summer '06

- 1 Gypsum Association Unveils 18th Edition of Flagship Publication
Glass Mesh Tape
Language Offered
- 2 What Level Is Your Finish?
- 3 Using Details from the Gypsum Association GA-600, Fire Resistance Design Manual
What Level Of Finish Qualifies As Fire-Taping?
- 4 Essentials from the Gypsum Association

GYPSUM ASSOCIATION UNVEILS 18TH EDITION OF FLAGSHIP PUBLICATION

Every three years the Gypsum Association produces a new edition of the *Fire Resistance Design Manual*. Each new edition is a milestone for the Association staff and the members of the Association's technical and building code committees; the new manual also provides contractors, designers, specifiers, owners, and others with a convenient compilation of the latest in tested gypsum-board designed fire-rated protection systems (as well as some tried and true older systems that have been with us for quite awhile). It also helps building officials keep up with fire-rated gypsum board systems that are permitted under the codes.

The Gypsum Association just completed the 18th edition of the *Fire Resistance Design Manual*. A copy of the new manual may be obtained by using the order form on the back page of this insert, by placing an online order at the Association's website www.gypsum.org, or by calling for an order form at 202-289-5440. The 18th edition depicts over 300 systems that may be used for fire-rated walls and partitions, floor/ceiling systems, roof/ceiling systems, and to protect columns, beams, and girders. Included for the first time in this edition are several new floor- and roof-ceiling systems and double-stud steel partition designs. The nominal price of \$18.00 includes shipping.

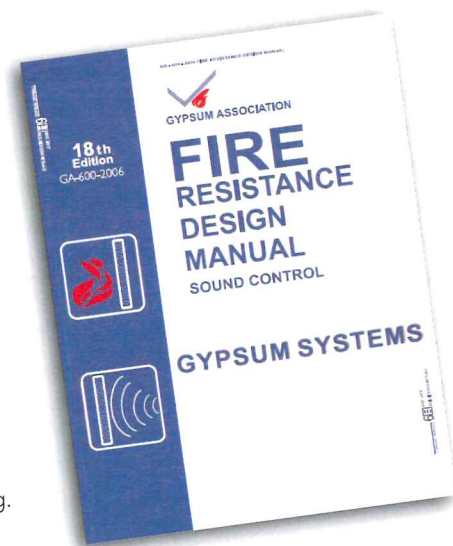

GLASS MESH TAPE LANGUAGE OFFERED

ASTM International Committee C11 on Gypsum is currently considering a proposal that would place language allowing the use of glass mesh joint tape into ASTM C 840, *Standard Specification for Application and Finishing of Gypsum Board*. This development comes after several years of attempting to create a separate standard for the application of glass mesh tape – a process that proved unachievable when consensus on acceptable language could not be attained.

The proposed language would require one coat of setting-type joint compound to be applied over the mesh tape when it is used to finish gypsum board joints. "The restriction requiring

setting-type joint compound is intentional," says Robert Wessel, Assistant Executive Director of the Gypsum Association and Secretary of the C 11 Committee, "since the committee continues to deliberate on the use of ready mix compounds with mesh tape. After much discussion, the C 840 task group believed it better to propose the revision with a restriction and incorporate the use of glass mesh tape into the standard rather than hold up the use of the tape completely. If and when the issue regarding ready mix material is resolved, the sections will be revised accordingly."

The item is currently being balloted within the ASTM process. Parties with an interest in the issue are encouraged to contact the C 11 Committee.



Books

purely technological solutions, the book's research into the human and social issues will help them in this task. *Kira Gould*

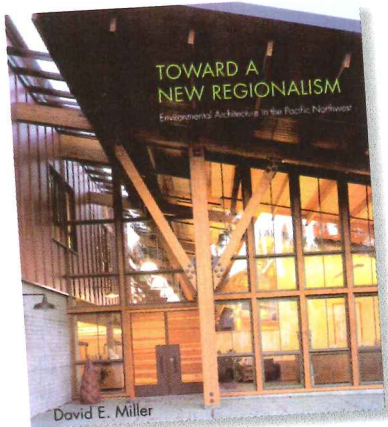

Toward a New Regionalism: Environmental Architecture in the Pacific Northwest, by David E. Miller. Seattle: University of Washington Press, 2005, 174 pages, \$19.

The obvious problem with this book is its ambition, evident in the title, echoing Le Corbusier's famous *Toward a New Architecture*.

Miller's aim is to derive a blueprint for sustainable design from Pacific Northwest regional architecture. Contending that the origins and development of modern green architecture "lie in the essential principles of Modernism," which the Northwest adopted and adapted, the author investigates geographic and climatic conditions that define the Northwest style. He equates the Northwest's architecture of wood, dramatic uses of landscape, and manipulation of light with early Modernism and calls these features "the basic building blocks of sustainable design." Add technology, he says, and you "have the opportunity to bring these elements together into a comprehensive design approach."

True, but perhaps not every-

where. Northwest regionalism will offer few lessons for sub-Saharan Africa or southern California. Like his thesis, Miller's language lacks finesse, but his book offers a good illustrated survey of sustainable design in the Northwest, including a brief history and a rundown of often-used strategies, such as earth sheltering, passive solar design, daylighting, and photovoltaic systems. The book offers examples of large buildings that use their site wisely, buildings of light construction that conserve resources, buildings that are models in admitting light and ventilation, and buildings for the future that integrate technology with older strategies. *A.O.D.*

SITE: Identity in Density, edited by Steve Womersley, with a foreword by Tom Wolfe, and essays by Michael Crosbie, Michael McDonough, and James Wines. Easthampton, Mass.: Images Publishing, 2005, 253 pages, \$65.

The redoubtable Tom Wolfe writes in a

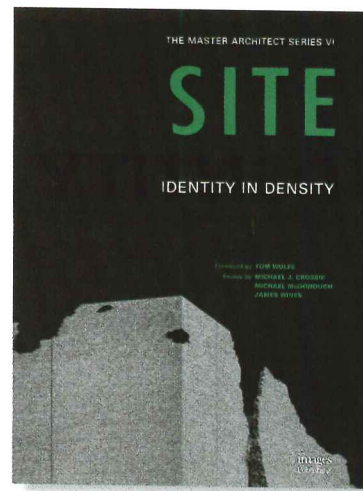

foreword that SITE and its founder James Wines "have their high-intensity eyes fixed upon the Green ground, figuring God is more likely to be found in the sod than in a to-the-rear march back into the miserly, constipated bowels of the Bauhaus." Opposition to Modernism energized SITE from its beginnings and remains a spur to Wines's fecund intellect and projects. "The orthodox Modernist imagery still being used is increasingly irrelevant in this disordered, pluralistic world," he writes.

SITE burst onto the scene in the

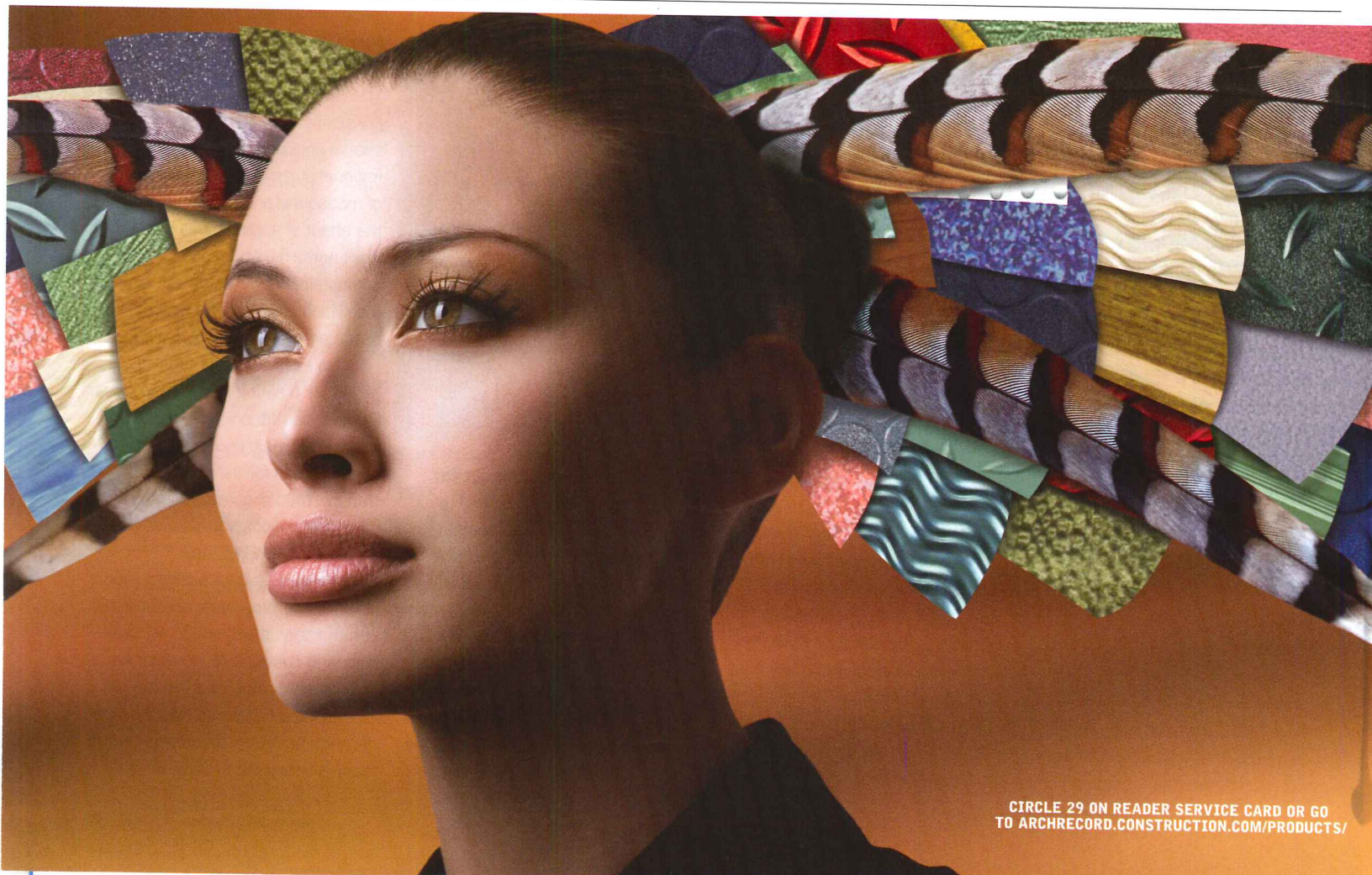

1970s with a series of showrooms for Best Products that foreshadowed many of today's trends, including the dematerialization of buildings, bringing nature into transparent buildings, and merging buildings with their natural surroundings.

In recent years, Wines has sharpened his focus on ecological architecture, lamenting here in an essay from 2000 that so-called green architecture merely tacks a checklist of environmental and land conservation strategies onto conventionally designed buildings and landscapes. Architecture remains "enthroned as a sculptural centerpiece," he writes, and landscaping is "reduced to a girdle of lollypop trees." He calls for more poetry in architecture and for recovering "those fragile threads of unity, which Heidegger called 'connectedness to the earth.'" Wines struggles valiantly to enunciate and shape an architecture for our times, which he calls the Age of Information and Ecology.

This survey of SITE's ideas and

projects revisits some material included in earlier publications by and about the firm. Which is all right: It's nice to have SITE's work and Wines's spirited, clearly expressed ideas and superb drawings in one place, complete with lists of projects, staff members, and publications by and about his firm. *A.O.D.*

Ken Smith Landscape Architect: Urban Projects, edited by Jane Amidon. New York: Princeton Architectural Press, 2005, 176 pages, \$30.

The second in a series of books presenting single projects or groups of related work "significant to the practice and study of landscape architecture today," this book aims to give readers "a sense of the project from start to finish," and to see "early concepts that persist into built form as well as the ideas and methods that are shed along the way." Using these criteria, this work succeeds.

The book presents three projects all in New York: the Museum of

Modern Art's roof garden (2002–05); East River Ferry Landings (2000–05); and P.S. 19 (2002–04). You might argue that two of three aren't "significant": The East River project is an installation of plants meant to replicate the riparian landscape, and P.S. 19 is an intervention with colorful graphics, plantings, and a scrim-covered fence at a school in Queens. They are creative solutions but hardly paradigm shifts. On the other hand, the MoMA garden—an installation of plastic rocks and trees, crushed glass, recycled rubber, and pebbles—though not open to the public and visible only from adjacent high-rises, is an important work that artfully resolves a challenging program.

The text provides chronological data for each project and "conversations" with Amidon reveal Smith's design approach—an emphasis on public space, the "social aspects of design," and "ecology and environmentalism ... as an artistic instrument"—and his reflections on the three projects. The book is well designed and offers excellent images.

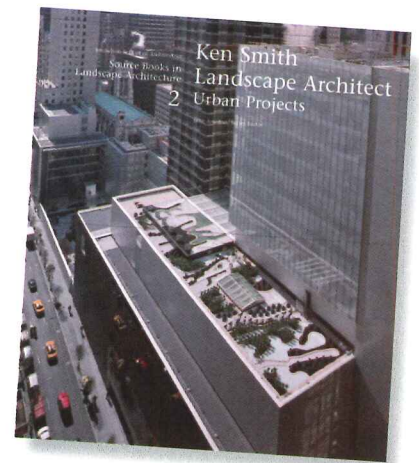

Critic Nina Rappaport's concluding, brief essay, however, borders on effusive artspeak.

Smith worked in Martha Schwarz's office when she partnered with Peter Walker, and he shares their approach, which emphasizes collaborative planning and public participation, nontraditional materials and found objects, irony and cultural comment. This monograph documents at least one project that represents how the profession is being reimagined and reinvigorated. And that merits attention. *Lake Douglas*

The advertisement for LONSEAL Collection features a collage of various textured and colored material samples, including papers, fabrics, and plastics, arranged in a fan-like pattern. A pen is visible in the upper left corner of the collage. The background is a solid, warm brown color.

The LONSEAL Collection

LONSEAL

www.lonseal.com/ar2

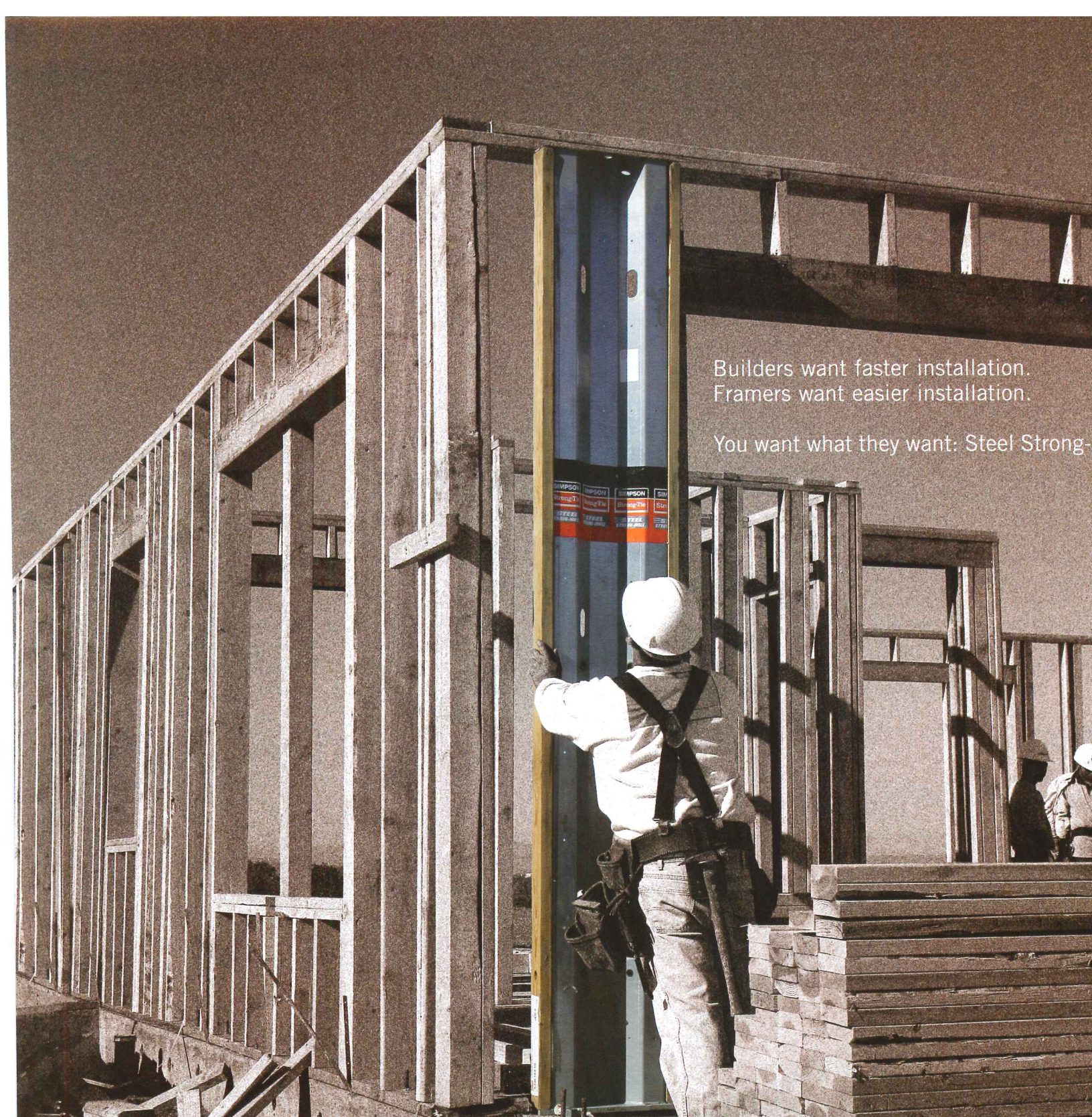

Builders want faster installation.
Framers want easier installation.
You want what they want: Steel Strong-

Specify Steel Strong-Wall® by Simpson Strong-Tie and you'll also get what you want without sacrificing your design. By combining steel and wood, Steel Strong-Wall makes it easy to achieve high loads in narrow spaces. Steel Strong-Wall is available in five widths from 12 inches to 24 inches and heights ranging from 7 feet to 13 feet. For more information on how Steel Strong-Wall can work for you, visit us at www.strongtie.com or call 1.800.999.5099.

Widths from 12" to 24" | Heights from 7' to 13' | ICC-ES ESR-1679

CIRCLE 30 ON READER SERVICE CARD OR GO
TO ARCHRECORD.CONSTRUCTION.COM/PRODUCTS/

SIMPSON
Strong-Tie

5
ANNI

Product View

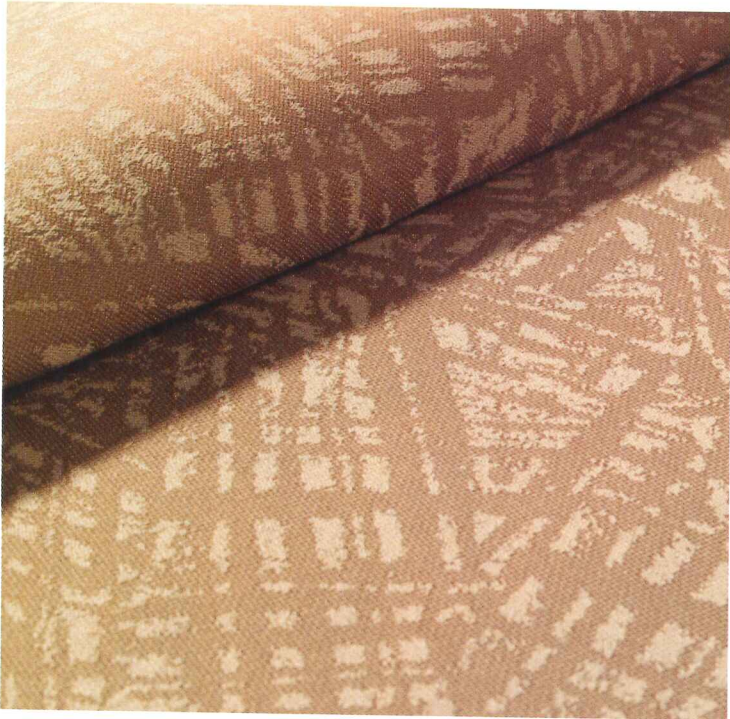

By Rita Catinella Orrell

The 180 Walls collection, developed by Milliken, is a group of 100 percent recycled polyester contract wall coverings that, in place of paste or water, use a pressure-sensitive adhesive to enable them to be installed with little downtime and carefully removed later without damage to walls (a premium Sheetrock surface is recommended). 180 Walls exhibits antimicrobial and stain-repelling features—air and moisture can pass back and forth through the “breathable” surface, an advantage over Type II vinyls. The Class A fire-rated product meets Greenguard certification requirements and contributes to LEED credits. In addition to Milliken’s 10 patterns, five fresher patterns are now available exclusively through Designtex. Milliken & Company, Spartanburg, S.C. www.milliken.com **CIRCLE 200** Designtex, New York City. www.designtex.com **CIRCLE 201**

Recycled wall covering breathes and sticks on its own

Clockwise from top left: Designtex’s 180 Walls collection includes Riviera, a bold, swirling scroll motif (with a corner peeled back); Lario, a barklike motif; Lario, Bari, Riviera, and Seine (stacked top to bottom); and Varenna, featuring a fresco effect.

Sleek New Tools For Lighting

Great lighting requires tools that fit the project.

Visa Lighting's latest designs combine profiles smaller than a deck of cards with efficient optical features. The result produces minimal presence and maximum impact.

All three designs feature T5 fluorescent lamping and electronic ballasts to meet strict energy codes. To meet demanding design tastes, these sleek new tools are rendered in quality die cast and extruded aluminum.

The result is a trio of efficient lighting tools that look as great as they work.

Visage

Recessed Lighting Sconce
24" to 60" Lengths
Wall or Ceiling Installation
Numerous Trim Options
Indoor and Outdoor Applications

Raven

Lensed Sconce
24" to 60" Lengths
Symmetric or Asymmetric Optic
Wall or Ceiling Mount
Indoor and Outdoor Applications

Ether

Ambient Sconce
24" to 96" Lengths
Symmetric or Asymmetric Optic
Wall or Ceiling Mount
Indoor Applications

 **VISA LIGHTING**
An Oldenburg Group Company

1717 West Civic Drive

Milwaukee, WI 53209

1-800-788-VISA

www.visalighting.com

CIRCLE 31 ON READER SERVICE CARD OR GO
TO ARCHRECORD.CONSTRUCTION.COM/PRODUCTS/

Snapshot



By Beth Broome

Leading off Los Angeles's Silver Lake Boulevard, a weblike bamboo bridge transports visitors out of traffic, over monster-infested waters, and into a surreal, miniature universe.

The work of a Los Angeles design collaborative called Workshop Levitas, the bridge, created with advanced design tools and eco-effective materials, aspires to the collaborative's mission of exploring the built world from a perspective of lightness. Delicate in appearance yet robust in character, the structure does, indeed, appear to defy gravity.

Part of an installation by design group *infranatural*, at Materials & Applications, an architecture research center, the bridge traverses the center's courtyard, which over the spring and summer has been flooded with rain water collected from the building's roof. The temporary body of water plays host to a gaggle of "monsters," a system of submerged, computer-controlled jets that lurk in the water, occasionally jumping above the surface. The bridge leads visitors over and into the installation, providing them with a stage from which to interact with the creatures below.

A bamboo tube leads into the great unknown



Snapshot

Chosen for its sustainable properties, the bamboo was harvested by Workshop Levitas from the Los Angeles County Arboretum and Botanic Garden. Rather than clear-cutting, the group trimmed the forest with the arboretum's blessings. "The bamboo grows so fast, if you don't cut it back it will kill itself," says Workshop Levitas's Shu-Chi Hsu.

Like the untreated bamboo itself, the structure's design process was organic. The design was inspired by structural/moment diagrams drawn by structural engineer Bruce Danziger. Hsu and Moritz Freund, both emerging architects, together with Danziger, designed the tubelike form using Rhino software. In the end, however, the bamboo took its own form. "Each piece of bamboo has its own way of bending," explains Hsu. "The bridge becomes itself, freeing itself from the computer model. The computer rendering is just a concept."

The choice of bamboo as a building material also contributes to the constantly evolving environment of the overall installation. At first green and relatively supple, the shoots have browned and stiffened over time, causing the bridge to transform in appearance and form over its short life span. "*infranatural* asked for a bamboo bridge," says Danziger. "We gave them that, but also something that works with the composition of the whole space and creates an experience in and of itself."

But the bridge is not the end of the line for these bamboo sticks. In yet another nod to green practices, when the installation concludes later this summer, Workshop Levitas plans one more reincarnation for their building material: It will take on a new life as furniture, perhaps as a giant outdoor sofa. ■



The bridge, made from approximately 150 locally harvested bamboo shoots and connected with 2,000 cable zip ties, can be seen from the street, inviting passersby to enter this experimental space and interact with the entire installation.

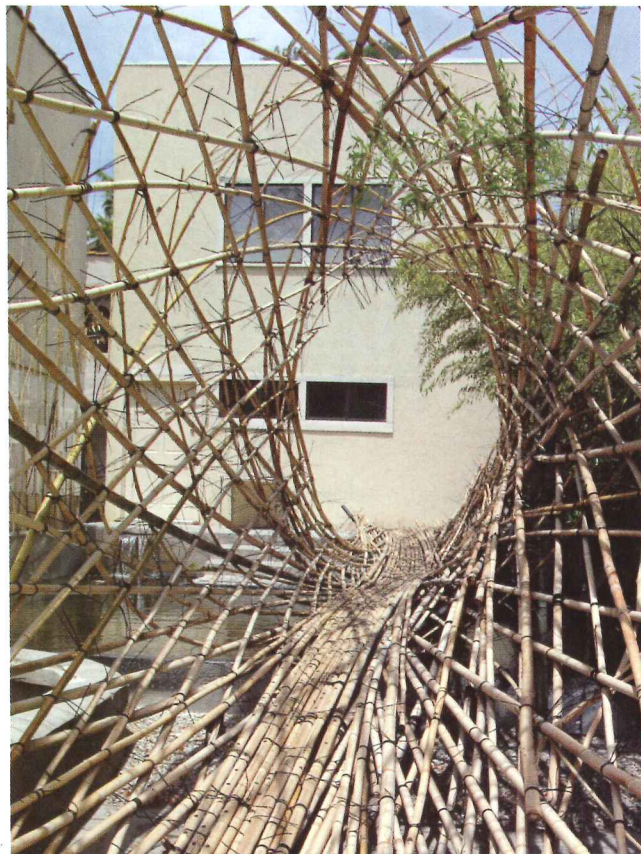

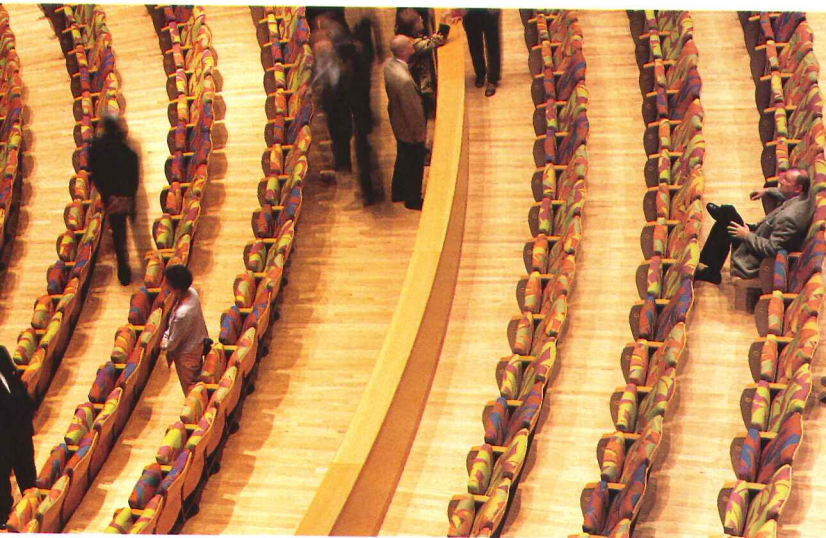
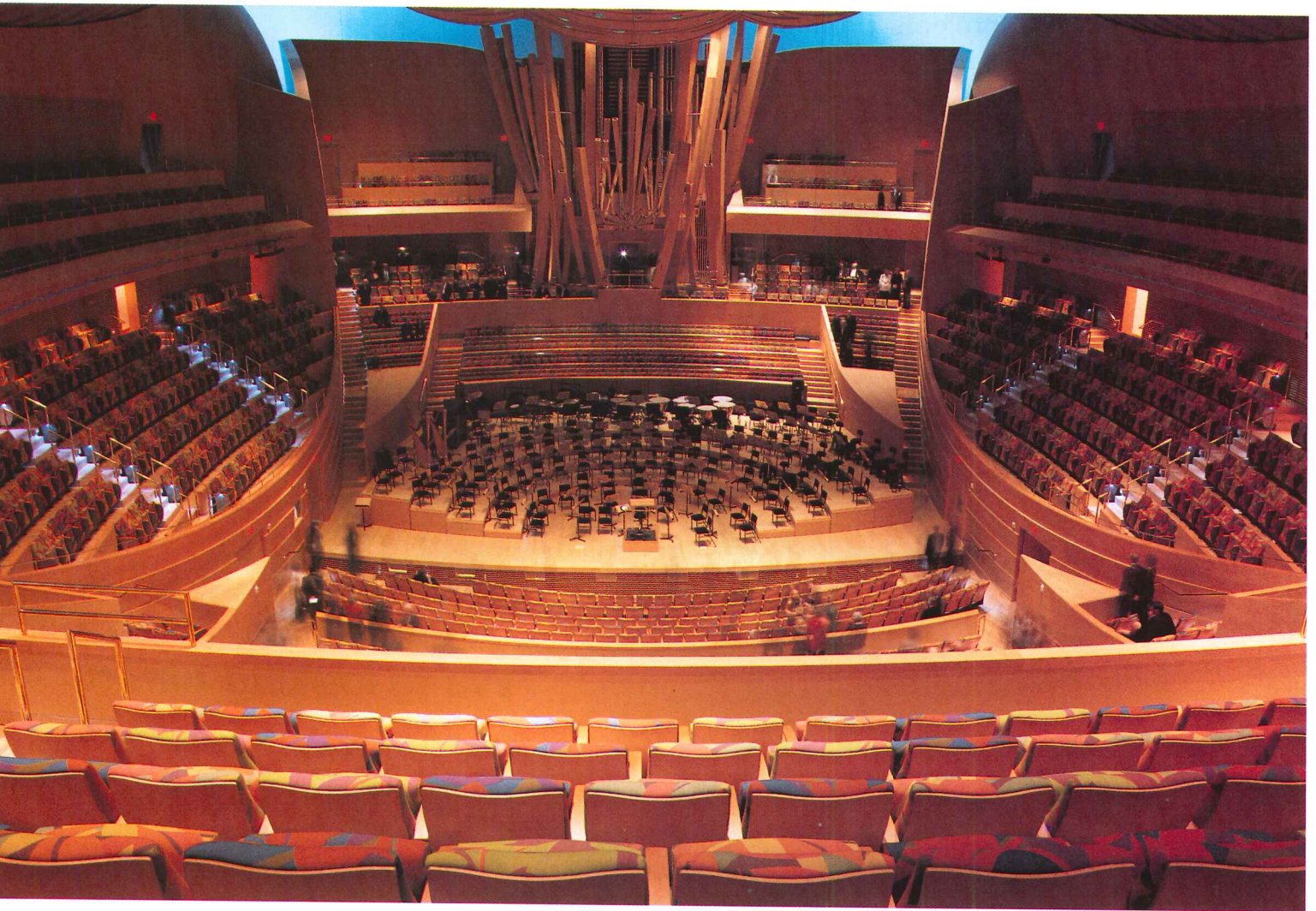

Walt Disney Concert Hall, Los Angeles - Project Frank O. Gehry & Partners
Model Frank O. Gehry Chair, custom benches for the balconies

Poltrona Frau Contract can provide standard and custom variations
for auditoriums, theatres, airports, museums, restaurants, hotels and offices

45 Wooster St. New York, NY ph. 212 777 7592 fax 212 777 8481 www.frauusa.com frauusa@frauusa.com



CIRCLE 32 ON READER SERVICE CARD OR GO
TO ARCHRECORD.CONSTRUCTION.COM/PRODUCTS/

connecting people_projects_products



“We’re looking for an easier way to ‘do the right thing’ and profit from the growing green building market.”

McGraw Hill
CONSTRUCTION

Now you can.

McGraw-Hill Construction makes
it easier to be green.

One name. One source for green
information and solutions.



Currently valued at \$10 billion, the green building market is projected to grow 3-8% to \$29-\$59 billion. How can you participate and profit? Getting your share couldn't be easier with 'one source' for green market solutions: McGraw-Hill Construction. Connect to green information and intelligence essential for firms that want to make a difference to a responsible built environment:

Market smart: Profit from vital green market sizing, projections, trends, expert insights and key areas of opportunity with McGraw-Hill Construction's *Green Building SmartMarket Report*, developed in partnership with USGBC.

Media: Explore design, building technology, legislation, best practices and products essential to creating sustainable buildings in *GreenSource* magazine and web site.

Products: Go to networkforproducts.com to find, select and source green products for your projects easily. Explore products in real projects. Insert CAD details and 3-part specs into documents. Connect with reps and suppliers.

Projects: Find, bid and win the right projects with the McGraw-Hill Construction Network—powered by the Dodge database. Search for LEED-registered projects. Or find out if your product has been specified.

**Profit from the power of our green connections.
All it takes is one call: 1-800-221-0088**

Just tell us what you need, we'll deliver.

MAR68GS

Go to www.construction.com/greensource/

The McGraw-Hill Companies



An architect can't turn over a mossy green rock today without finding the word sustainability written under it. Thirty years ago, few in the building industry considered "ecologically responsible" design much more than some geodesic domes on a commune in Northern California. By July 2006, more than 550 million square feet of commercial building was registered or certified with the U.S. Green Building Council's LEED certification process. Green policies in cities and states continue to expand their influence, from rooftop solar and wind turbine programs in Chicago to California's LEED Silver state building initiative. Manufacturers persist in rolling out at a dizzying pace new products pushing the limits of energy efficiency, recycled content, and conservation.

This year, Al Gore's documentary film on global warming, *An Inconvenient Truth*, and the PBS series on green building, *design:e²*, raised issues that have touched a nerve with receptive audiences. All indications suggest 2006 as a benchmark for the sustainability movement, in terms of the design and construction industry, as well as public awareness.

Yet we haven't seemed to have reached what writer Malcolm Gladwell calls the "tipping point." As consumers, we want to buy less, but consumer spending is still up for 2006, though factoring out pricey gas purchases, there are signs of a slowing. As architects, we want to design better buildings, but LEED-rated buildings represent a mere fraction of a percentage of overall building in the U.S. (To put it in perspective, Wal-Mart opened more than 3.2 million square feet of new buildings in the U.S. in June 2006 alone, though even that conspicuous-consumption behemoth has begun to consider building sustainably.) Furthermore, the establishment of separate green architecture academic programs, the most recent of which was at Yale, gets it exactly wrong: Sustainability should be integrated throughout the field, not offered as an elective curriculum. What will it take for truly radical change? And when will it come?

RECORD asked these questions, and others, of some key people in a variety of fields in the realm of sustainability, but all outside of strict architecture practice. In these areas, which include mechanical engineering, industrial ecology, and population-growth management, we see a fluid understanding of sustainability, one easily adapted to diverse working methods. We did not set out to achieve a comprehensive examination, but to take a wide view of a handful of provocative ideas. We feel strongly that innovation within the green architecture movement represents the best of the field; after much hand-wringing in recent decades about what to do with the failed project of the Modern movement, the mounting evidence seems clear. Russell Fortmeyer

Interviews were conducted by Russell Fortmeyer, John Gendall, and Charles Linn.

Big Ideas for a Little Planet

RECORD asks leading voices
about the innovative ideas
shaping sustainability's future

Defining sustainability

John Ehrenfeld, who teaches at the Massachusetts Institute of Technology, speaks on his extensive writing about sustainability.

ARCHITECTURAL RECORD: *What is your definition of sustainability?*

JOHN EHRENFELD: I define sustainability as the possibility that human and other forms of life will flourish on the planet forever. Sustainability is a consequence of the culture, but it's accumulated over a long time. The modern, technological, objective world is about a lot of pathology that leads to many human and natural dysfunctions.

AR: *Why do you think environmental issues are still so up for debate in the U.S.?*

JE: Sustainability is a long-time, systems issue. The senior politicians in the U.S. have dissed this issue to some degree because we have a very simplistic political system now. The time constant of the press and the political system is in seconds, minutes, maybe hours, and it cannot deal with issues that are long-term, difficult to grasp or even perceive.

AR: *Do you think true sustainability is possible?*

JE: I think it's possible. No global society has come close to making the demands and stressing the global ecosystem the way we have today. The situation today is more tenuous

than it was in the past. We need to deal with the symptoms of the dysfunction, like global warming, but that isn't going to bring us a sustainable world. It will prevent, perhaps, catastrophic change, but it is a reactive response.

AR: *Many argue that innovation is a distinctly human quality that will advance sustainability.*

JE: People aren't inventive, they can't cope. Most people can't deal with life unless their technological things are working for them. Turn off one of those things and they are bored. Invention is being lost, and without that humans can't sustain themselves.

AR: *Do you think there is a "big idea" that will push the world into changing?*

JE: It's going to happen one invention and one building at a time, but I'm confident that will produce better results than a grand plan. I'm putting my eggs in subversive projects. It's not about creating green buildings, it's about creating place. Sustainability is a systems property. Architecture is the closest thing we have to the whole world, so architects have been systems thinkers forever.

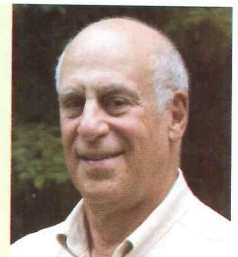

John Ehrenfeld, executive director of the International Society for Industrial Ecology.

“Net” zero-energy buildings

AR talks to Roger Frechette about SOM's design for the 71-story, 2.2-million-square-foot Pearl River Tower in Guangzhou, China. The tower is designed to have a “net” zero-energy footprint, using a combination of strategies, including wind turbines, radiant slabs, microturbines, geothermal heat sinks, ventilated facades, waterless urinals, integrated photovoltaics, condensate recovery, and daylight responsive controls.

ARCHITECTURAL RECORD: *What is the biggest technical challenge you need to overcome to make a “net” zero-energy building?*

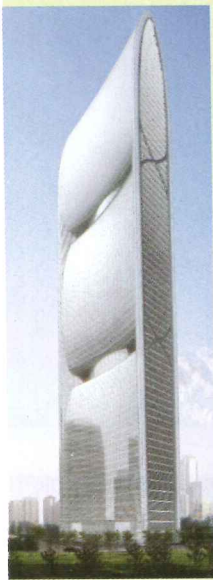

Pearl River Tower, Guangzhou, China.

ROGER FRECHETTE: Trying to design a low-energy-consuming building in Guangzhou is very difficult. It's a harsh environment with respect to indoor air quality, heat, and humidity. We know if we can make it work there, we can make it work anywhere.

AR: *What was unexpected about the process of designing the Pearl River Tower?*

RF: We had the notion that we could capture wind energy as one of the many energy strategies in the building design. The building's facade was formed to accelerate the wind as it moved through the opening in the building. We had estimated that we could increase the wind velocity to 1.5 times the ambient wind speeds. As the design advanced, we tested our

building model in a wind tunnel. We were pleasantly surprised to see that not only did the wind accelerate as we had hoped, but in some cases it reached 2.5 times the ambient wind velocity. Because power potential is the cube of wind velocity, this strategy will yield power well beyond our original estimates. Our “building-embedded” wind turbine could generate power 15 times greater than a “freestanding” turbine.

AR: *Do you consider this a prototype for SOM's skyscraper designs?*

RF: I do not think the term “prototype” would be appropriate. The proper approach is to truly understand the uniqueness of environment for each project. This Pearl River responds to the natural forces available in Guangzhou. Wind speed, wind direction, solar angles, air quality, temperature and humidity profiles all inform the design. Putting this building in a different environment wouldn't be appropriate at all.

AR: *What has been your overall strategy with the tower?*

RF: Our philosophy on the Pearl is to “blur the lines” between the traditional disciplines. We think of a conventional building as having architectural, structural, mechanical, and electrical systems as independent layers. The Pearl Tower project is a statement of integration. It breaks the rules. We have a building skin that generates power, a structural system that provides thermal comfort, and a mechanical system with sculptural qualities and aesthetic beauty. Each system of the building works in concert with the others and with the building's environment.



Roger Frechette, director of MEP Sustainable Engineering at Skidmore, Owings & Merrill, Chicago.

The future of energy use

Jay Stein, an energy industry researcher, reveals what it will take to make clean electricity competitive.

ARCHITECTURAL RECORD: *In the future, what's going to change about how we think about how buildings use energy?*

JAY STEIN: Well, I think someday small gas and oil burners, such as those found in furnaces and water heaters, will be viewed as uncontrolled carbon-dioxide emitters. I doubt the government will actually shut them down, but our society may choose to stop adding new ones to the network. When that comes to pass, the only external energy source for new buildings will be the electricity grid. Then, we'll rely on heat pumps to transform that electricity into comfortable space and hot water.

AR: *What's going to cause that to happen?*

JS: At some point, our society is going to regulate CO₂. I'm foreseeing a stage in which there aren't cheap carbon offsets and

there's simply great pressure on the utilities to dramatically reduce their carbon emissions. The gas companies will have very few options, unlike the electric companies, which have many, like nuclear power, carbon capture and storage, and renewables.

AR: *Yet, there really isn't low-carbon electricity available today.*

JS: Higher costs because of carbon regulation combined with technological improvements in products like heat pumps and the plug-in hybrid vehicle will make the electric-utility industry competitive in sectors that it's been locked out of forever. The electric-power industry has many options that its competitors don't. The best thing is to have regulation that empowers these industries to be innovative.



Jay Stein, executive vice president, E Source.

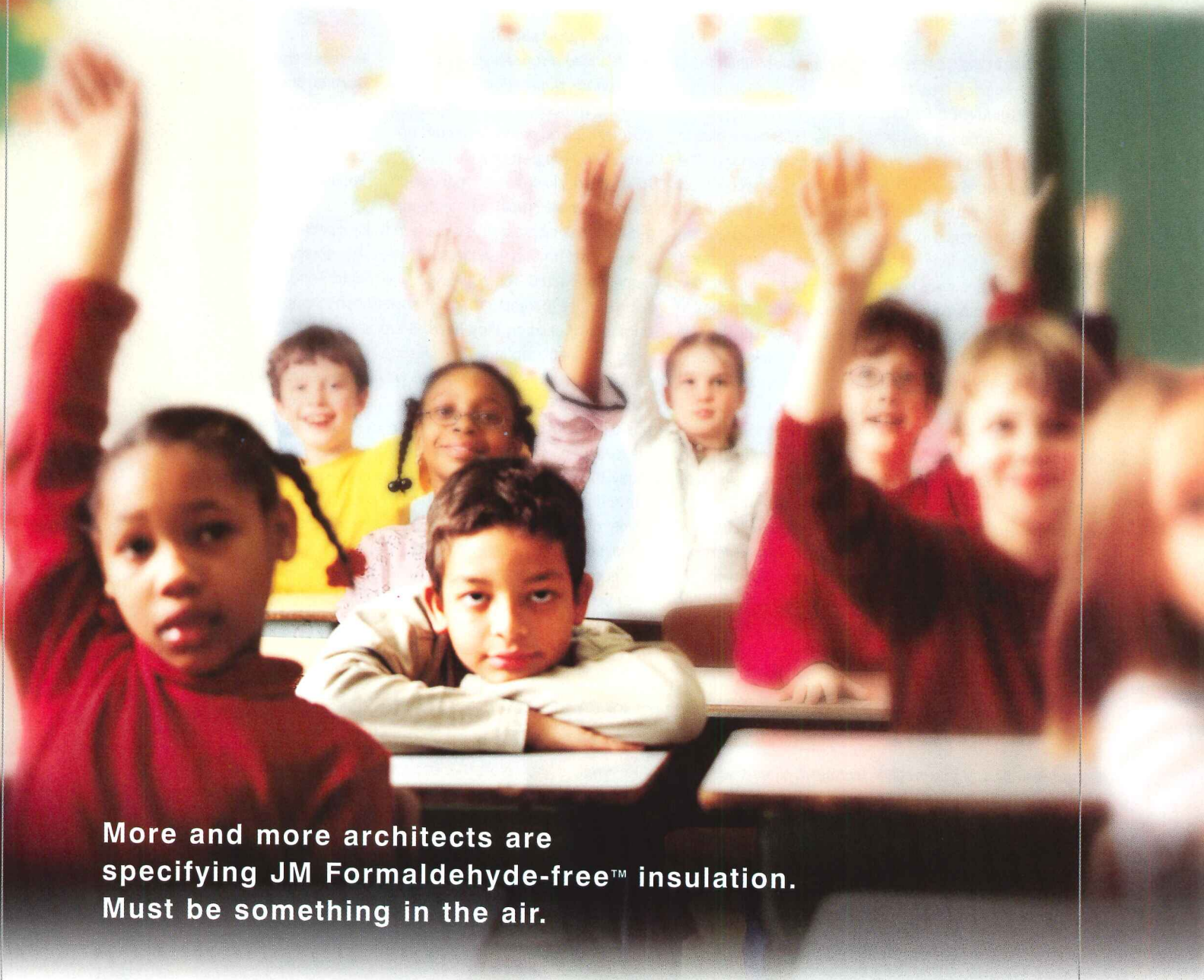

More and more architects are specifying JM Formaldehyde-free™ insulation. Must be something in the air.

Only Johns Manville offers a complete line of fiber glass insulation made without formaldehyde. And only insulation made without formaldehyde can pass Environmental Specification 1350 with a non-detect for formaldehyde. ES 1350 is the nation's toughest indoor air quality test, and it's the standard that California architects and public school officials use to protect 6.2 million children. To learn more, visit specJM.com.



Johns Manville Formaldehyde-free™ Insulation  It's Comforting to Know We're There.™

CIRCLE 33 ON READER SERVICE CARD OR GO TO ARCHRECORD.CONSTRUCTION.COM/PRODUCTS/

Managing population growth

Rogelio Fernandez-Castilla discusses the challenges faced by the United Nations Population Fund, as well as architects and other agencies, for assisting developing countries in handling dramatic population growth.

ARCHITECTURAL RECORD: *What problems do cities in developing countries face today?*

ROGELIO FERNANDEZ-CASTILLA: Population at present is between 6 and 7 billion, but by 2050 it may be 8 billion plus to 10 billion plus, depending on how population is trending. The growth of urban areas is almost entirely in developing countries. If we repeat the patterns of urbanization that have been observed in Latin America in, say, Africa, we will have a disaster. The question is are we learning and taking measures to prevent the problems. The answer is no. In many countries, urbanization is something a country tries to avoid. But migration from rural to urban areas is going to continue. The concentration of slums in large cities could be handled more effectively if this migration process were planned for by governments.

AR: *How can a discipline like architecture address such a complex issue?*

RFC: At present, these urban settlements are growing in very environmentally fragile areas. For example, in many developing countries, newcomers to the cities with no place to live establish themselves at the margins of rivers and in areas that are more vulnerable to natural disasters, as well as where services are not available. If there is some kind of urban planning that faces this inevitable urban growth, where the government and

society decides to reserve certain spaces where future development would be more affordable and less environmentally damaging, it would make a huge impact.

AR: *Is there a role for government-mandated population control in creating a more sustainable world? Can the earth possibly accommodate 10 billion people?*

RFC: If you look at the population sectors where rapid demographic growth is taking place, it is exactly in those population groups that lack information and lack services. The surveys that are being conducted—demographic and health—indicate that people in the poorest groups of society don't want the large numbers of children they have. There is a significant unmet need for contraception. The question is not to worry about population control to change the way these people behave. Their behavior is not something they have decided to adopt, but it is because they do not have the means to exercise their choices. Family-planning programs are heavily underfunded today throughout the world. It's not a question of having to convince people of radical population control methods, as in China or India, which have been criticized throughout the world, but rather to provide additional education, information, and services for those who would like to postpone their next birth or would prefer to have fewer children.



Rogelio Fernandez-Castilla, director of the Technical Division of the United Nations Population Fund.

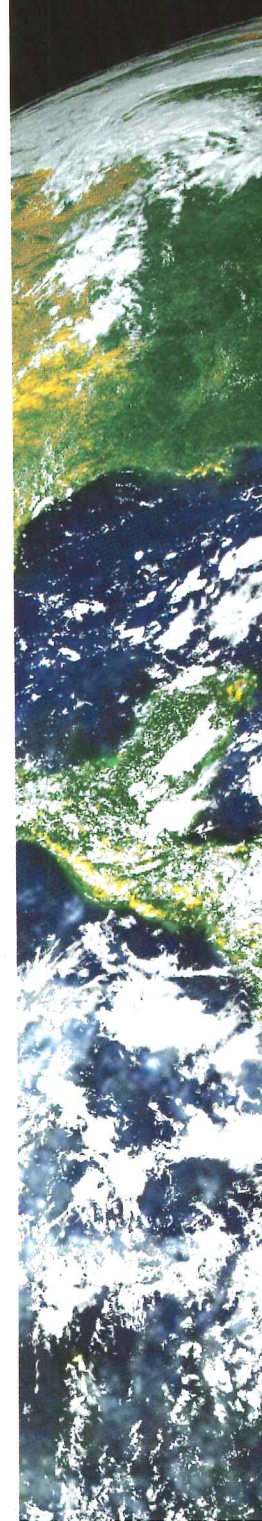

Greening the landscape

Margie Ruddick, a landscape architect, discusses her experience incorporating sustainable design strategies into a variety of urban and rural landscapes.

ARCHITECTURAL RECORD: *What is your definition of sustainability?*

MARGIE RUDDICK: No one really knows what it is. It's something that people recognize, but it's still not that clear. People have ideas about its very basic principles: It is about minimizing impact and thinking about systems, about integrating environmental health with social and economic sustainability. Anything that involves more than what is needed is unsustainable.

Some practices have internalized sustainable design. For example, using sustainable urban drainage is becoming the norm. I have built a reputation for sustainability, but that all started just because of a low budget. I was working on a 2.5-acre, \$700,000 project. Because of the budget, it had to be an innovative, low-maintenance, local-material project. It just happened to be that ultimately these practices became more recognized as sustainable design.

AR: *What is the role of landscape architecture in sustainable design?*

MR: Landscape architects used to be brought in after the architects had done the planning work. Now we're brought in at the outset to look at siting and planning and the underlying site structure.

AR: *Have there been surprises in recent years for sustainable practices?*

MR: When you get excited about sustainable design, you think you can have a perfect solution, you can create a closed-loop system where everything is off the grid. The assumption that you're going to find a solution has been questioned. Other considerations must involve an economic or programmatic sense.

So what has changed is the assumption that you're going to be able to do it all. We must acknowledge that we're consumers, that we're going to do damage, but figure out how to minimize the damage. But whatever it is, it must involve a lot of local input.



Margie Ruddick, principal, Wallace, Roberts & Todd, Philadelphia.

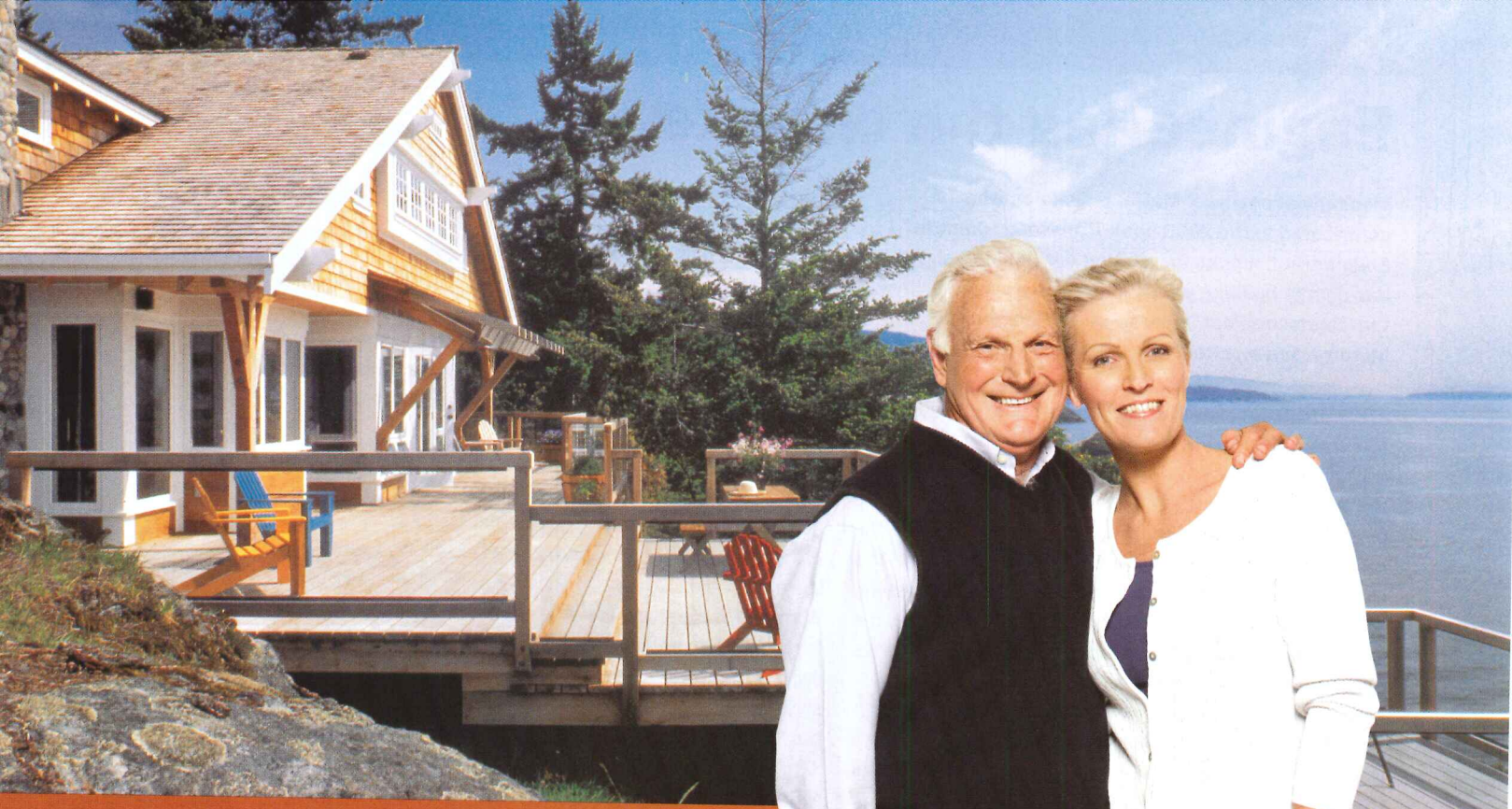

A PERFECT PAIR: CEDAR SIDING & ROOFING

Real Cedar siding and roofing are the perfect combination. After all they have so much in common. They both have unsurpassed natural beauty and centuries of proven performance unmatched by any man made alternative. And they offer natural durability, longevity and the highest insulation value which helps reduce your energy costs.

The versatility of Western Red Cedar means you can choose from a variety of styles to suit your taste. In fact, you are only limited by your own imagination. Homeowners around the world prefer Western Red Cedar to add distinction and prestige to their project. Whether remodeling or building your dream home, Real Cedar siding and roofing are a classic touch that you'll appreciate for a lifetime.

So don't settle for the ordinary: Partner with Real Cedar siding and roofing. Call us at 1-866-778-9096 or visit our website to get started.



B.C. SHAKE & SHINGLE ASSOCIATION

bcshakeshingle.com



realcedar.org

THERE IS NO SUBSTITUTE

CIRCLE 34 ON READER SERVICE CARD OR GO TO ARCHRECORD.CONSTRUCTION.COM/PRODUCTS/

Engineering the climate

Mechanical engineer Matthias Schuler, who contributed to the 2003 book *Transsolar, Climate Engineering*, argues for shifting our thinking about low-energy building projects. He was involved in the Deutsche Post Tower in Bonn, Germany, with Murphy/Jahn architects [RECORD, May 2004, page 96].

ARCHITECTURAL RECORD: *What is climate engineering?*

MATTHIAS SCHULER: We define it as high comfort, low impact. We are mostly mechanical engineers and physicists, so we are approaching this by rethinking everything as basic physics—using basic physical phenomena to improve the comfort of people with their environment, while doing this with the lowest consequences for the natural environment. You have to do this in an early stage with the architects in a close collaboration. Architects feel this supports and pushes their design; they don't see it as a restriction.

AR: *You write in the book that you consider climate engineering a discipline within architecture. Can you clarify what that means and how that relates to conventional consulting engineering?*

MS: We see it as a discipline with the entire design team, not necessarily within architecture. Climate engineers take a holistic approach. In a certain way, they are trying to pull together all of the forces rather than letting every discipline go their own way. That's the difference from the m/e/p or HVAC approach that takes the building as it is—this is my load, what is the equipment you need to cover that, and so

on. You need to first ask what creates that load and how you can influence it to decrease; only then can you think about the mechanical equipment that effectively covers it.

AR: *How well do architects respond to your process?*

MS: We have to translate our ideas into a language that architects can understand and accept. First, we have to listen to their architectural intentions, then we can add our sustainable intentions to push them in a direction where the building not only looks cool, but it acts cool in terms of thermal design. It's always a compromise.

AR: *What is your definition of sustainability?*

MS: It's an overused term, to a certain extent. If we are living sustainably, then we have to consider our ecological footprint. What are the consequences of being here, living here, in respect to resources, impact on climate, impact on waste. We are in our own discipline only covering a part of it. Compared to a basic society like that of the Native Americans, our modern society has left the sustainable circle, and we need to find a new one.

AR: *Where do we start? Have we already lost?*

MS: We have to be creative enough. We have the mind to find solutions out of it. Some of it may lead us to step back from what we already consider our needs. Mobility is a key thing in this respect, such as spending all of these resources on traveling all over the world. Maybe we need to learn to live our lives and do our jobs in smaller circles.

AR: *What in the past five years has changed your mind about sustainability?*

MS: The statistics on hurricanes in the last year around New Orleans—we are doing a student center at Tulane University—made us aware. We were down there four weeks before Katrina and we talked to the local people about how New Orleans is the most endangered city in America in terms of global warming, and then the storm hit. It made it clear the system is in a sensitive balance, and we need to be careful not to bring it so far out to the point the system can't return.

AR: *With global warming, do you think humans need to just adapt to the idea of environmental extremes? How much can we control our environment?*

MS: For example, take Tokyo. In the past 10 years, the city temperature has risen around 18 degrees Fahrenheit in summer because of the heat-island effect. The city just finished three or four residential towers on Tokyo Bay that basically cut off natural ventilation to the city. In New York, buildings are heated to 80 degrees F in winter and cooled to 68 degrees F in summer. That is ridiculous. It should be heated to 68 in the winter and cooled to 80 in the summer. The human body can easily adapt to change. We have to understand that the same temperature indoors is not always good for the human body. Our buildings need to be able to adapt to changing bodily conditions. By sealing buildings (artificially conditioning them without operable windows), architects forgot how to shape them. That is a tradition that has been lost.

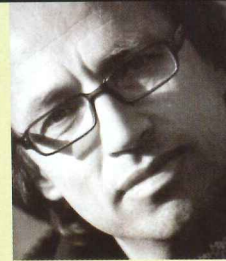

Matthias Schuler,
principal, Transsolar,
Stuttgart, Germany.



Deutsche Post Tower in Bonn, Germany (top and above right), and a model of Steven Holl's Beijing Looped Hybrid (above left).



(Save the date)

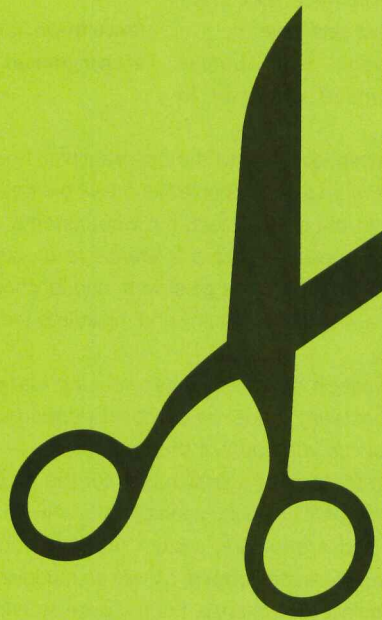

GREEN BUILD 2006

11/15/06

THROUGH

11/17/06

DENVER

EARLY REGISTRATION

DISCOUNT

UNTIL SEPTEMBER 6, 2006

WWW.GREENBUILDEXPO.ORG



CIRCLE 35 ON READER SERVICE CARD OR GO
TO ARCHRECORD.CONSTRUCTION.COM/PRODUCTS/

Green markets and policies

Rick Fedrizzi discusses the role of the U.S. Green Building Council in helping change design culture.

ARCHITECTURAL RECORD: *In light of the expanding corporate and manufacturer membership of the USGBC, how do you grow without losing touch with core beliefs?*

RICK FEDRIZZI: We're finding that architects, engineers, and contractors were the early adopters, but now we're not only finding manufacturers, we're also finding financial institutions, accountants, C.F.O.s, people with insurance backgrounds, health-care practitioners, educators—and you're scratching your head asking, why? They are all looking at their business and how to protect their interests. Becoming accredited doesn't give them the ability to build a LEED building. It does give them enough information to ask the right questions and to make intelligent decisions.

AR: *The USGBC doesn't currently lobby governments to adopt the LEED program. Will that ever change?*

RF: We have almost 70 chapters in the United States. The idea that chapters would become the front door to the USGBC is important. The chapters live, work, design, and construct in those cities and states and have a much more focused view of

what they can accomplish from a local advocacy standpoint. When a particular city says all new buildings in the city have to be LEED Gold, we don't like that. We don't like the idea of special tax credits for green buildings. If you remember the solar tax credits in the 1970s, the minute those dried up, so did people's interest in solar.

AR: *Do you think we have reached a new peak of public consciousness in terms of environmental issues?*

RF: The political climate, the physical climate that gives us horrific weather patterns, an increase in science reporting information we didn't have before—such as photography from space showing in a 10-year period the reduction of the polar ice caps—and probably every one of us knows three to five people who had or have cancer. People who are aware have started to understand there is something we have to do.

AR: *Can government drive this?*

IP: It's got to stop being a Democratic or Republican issue, it's just a human issue.



Rick Fedrizzi, president, C.E.O., and founding chairman of the U.S. Green Building Council.

The green prototype house

Steve Glenn, of LivingHomes, has developed in Santa Monica, California, a prototype modular house based on a design by well-known Los Angeles architect Ray Kappe, FAIA. The house is designed to achieve a LEED Platinum rating under the USGBC's pilot LEED for Residential program.

ARCHITECTURAL RECORD: *Prototype houses litter the Modern movement, particularly in Los Angeles. Why haven't they seemed to work?*

STEVE GLENN: I don't know many who were thinking of an environmental agenda, but there was less interest in Modernism in the public domain. Also, I think these architects approached it as an architectural problem,

LivingHomes prototype model (above left), and the house as built (left).

and not a production or product problem. What's changed is we have much greater interest in Modern design in a more affordable price-point. Modern design has transformed most major consumer product categories.

AR: *You haven't built homes before—what made you want to start now?*

SG: When I started looking into the opportunities, I quickly concluded there were a lot of people like me who cared a lot about design and the environment, but who currently don't have the time or money or stress tolerance to do custom houses. I value things that have great form and functionality and are built in a way that is healthy and minimizes the ecological footprint.

AR: *Commodification drives the mass-housing market in that people constantly trade up or down depending on their needs. How do you address that market?*

SG: We want to try to offer a growth plan for the house to accommodate people's changing needs. That's why we have movable walls and a structural system that lets you add space both internally and externally, as well as modular millwork you can replace and change. From a price standpoint, our current line is about \$250 a square foot, and we expect that to get as low as \$150 a square foot in time.

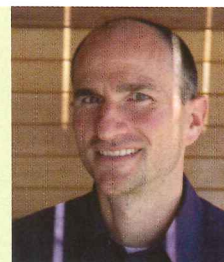

Steve Glenn, C.E.O. of LivingHomes.



iInnovation

**SOME BUSINESSES RESIST CHANGE.
OTHERS MAKE CHANGE HAPPEN.
WHICH WILL YOU WORK WITH?**

Technology can't solve every problem. The key is to recognize areas where it can help. And that's just what we're doing at iLevel™. We have premium wood products from Trus Joist, Structurwood and Weyerhaeuser that are strong and easy to work with. A streamlined supply chain to help you manage costs. And software tools that enable you to work strategically, reducing build time and jobsite waste. We believe it's a simpler way to do business. And we think you'll agree. To learn more, go to iLevel.com or call 1-888-iLevel8 (1-888-453-8358).

iLevel™

© 2006 by Weyerhaeuser, all rights reserved. Structurwood® and Trus Joist® are registered trademarks, and iLevel™ is a trademark of Weyerhaeuser Company.

 Weyerhaeuser

**CIRCLE 36 ON READER SERVICE CARD OR GO
TO ARCHRECORD.CONSTRUCTION.COM/PRODUCTS/**

connecting people_projects_products



"I want to easily learn and earn Continuing Education units and be inspired by the latest designs, trends and applications."

Now you can.

Experience
Education/Information/Inspiration
With McGraw-Hill Construction
Continuing Education Connections

Earning continuing education units is easier than ever with McGraw-Hill Construction Continuing Education Connections.

Read *Architectural Record* for credit. Continuing education courses from leading editors and building product manufacturers appear in every issue and online. Most qualify for HSW credits.

Online. Access continuing education courses on the web.

In person. McGraw-Hill Construction offers conferences and events that qualify for continuing education credits.

Learn and earn continuing education credits twenty-four hours a day, seven days a week.
Go to www.construction.com/ContinuingEd/.



Go to www.construction.com/ContinuingEd/

McGraw Hill
CONSTRUCTION Architectural Record

MAR6

The McGraw-Hill Companies

Build on our experience.

For over four decades US Aluminum has developed a reputation for outstanding products, unparalleled service and complete customer satisfaction throughout North America.

That wealth of experience coupled with a large selection of architectural aluminum products enables you to design, create and build with complete confidence.



Entrance Doors



Curtain Walls

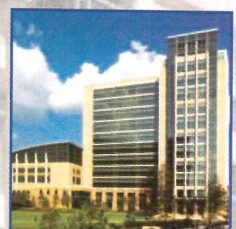

Storefronts



Impact Resistant

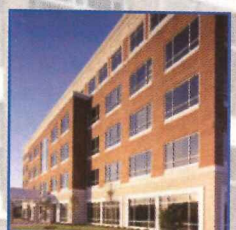

Window Walls



Operable Windows

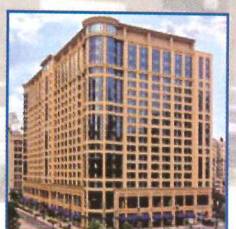

1-800-627-6440 • 200 Singleton Drive
Waxahachie, TX 75165 • www.usalum.com

CIRCLE 37 ON READER SERVICE CARD OR GO
TO ARCHRECORD.CONSTRUCTION.COM/PRODUCTS/



PELLA ADVANTAGE NUMBER 23:

WOOD CAN TAKE THE HEAT.

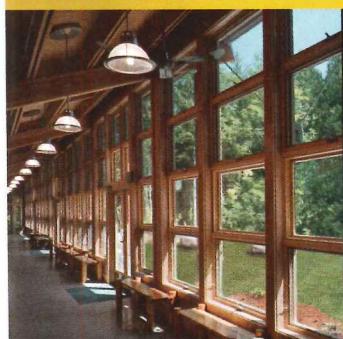

Wood is a natural insulator. That's why wood windows reduce energy costs better than aluminum. And they create a more comfortable indoor environment that enhances employee or student productivity. The confidence that you won't get burned using wood. That's **The Power Of Yellow.**SM

800-84-PELLA www.pellacommercial.com



COMMERCIAL

CIRCLE 38 ON READER SERVICE CARD OR GO
TO ARCHRECORD.CONSTRUCTION.COM/PRODUCTS/

It's easy being green

Sustainability's reach now extends well beyond buildings

By Russell Fortmeyer

The July 17, 2006, cover of *Newsweek* shows a smiling family consisting of a father, mother, child, and dog arranged in a quaint living room. Everything in the photograph, except hair and flesh, pulsates in a shower of eye-popping shades of char-treuse. Against this hallucinatory image rests the headline “The New Greening of America.”

Whether you like it or not, the impulse to insert the word “green” before every noun seems to have overtaken the American consciousness. As architects, we’re in an ideal position to take advantage of this strike-while-it’s-hot mentality.

Of course, architecture and sustainability are inseparable. We could trot out any number of great architects to make our point, but one will do. In 1910, Frank Lloyd Wright summed up his philosophy in a simple statement on “organic architecture,” writing in his German-published *Collected Works* that “it is quite impossible to consider the building as one thing, its furnishings as another, and its setting and environment still another.”

In the pages that follow, you’ll find this philosophy reiterated in various ways. Today, instead of Wright’s organic architecture, we call it “integrated design.” You see it in the way Sauerbruch Hutton Architects uses trapped methane gas from a landfill to provide an energy source for heating the Dessau Federal Environmental Agency building or how Ken Yeang’s Singapore National Library uses natural ventilation to cool an atrium. We’ve followed Norman Foster’s Hearst Building from its initial design [RECORD INNOVATION, November 2005, page 20] to its realization today, and we bring you that other great British architect, Richard Rogers, and his new Welsh Assembly. All are leading lights in the realm of sustainability.

If *The New York Times* calls green “the new black,” as they did in their May 17, 2006, special section, we’re inclined to agree.



1. **Hearst Tower**
Foster and Partners
2. **Federal Environmental Agency**
Sauerbruch Hutton Architects
3. **The National Library**
T.R. Hamzah & Yeang
4. **National Assembly for Wales**
Richard Rogers Partnership

PHOTOGRAPHY: © CHUCK CHOI (1); ANNETTE KISLING (2); TIM GRIFFITH (3); RICHARD BRYANT/ARCAID (4)

The architects restored the landmarked exterior of the Art Deco base, but made the radical decision to gut that six-story building and float the tower above it visually (this page and opposite).



For its Manhattan debut, **Foster and Partners** creates the new **HEARST TOWER** with a glass-and-steel shaft hovering atop a vintage low-rise

By Sarah Amelar

New York City's Hearst building is a bit of a jack-in-the-box without the Jack. Springing from an ornate 1920s base, the structure's stainless-steel-clad diagrid rises like a great scissor lift, but then, defying expectation, the shaft stops short, without a culminating form topping its 46 stories. A faceted glass-and-steel tower erupting from a six-story, cast-limestone base—adorned with grandiose allegorical sculptures and monumental urn-crowned columns—the building simultaneously defies, realizes, and (surely in its sustainable character) exceeds the aspirations behind the creation of its lowest floors 78 years ago.

In 1928, when those first six stories went up, media magnate William Randolph Hearst envisioned them as the base for a future tower and the beginning of a real estate empire he imagined dominating Columbus Circle, just to the north. Though the Great Depression thwarted this grand scheme, architect Joseph Urban's six-story, 40,000-square-foot building served as the Hearst Corporation's magazine headquarters for the next seven-and-half decades. Extending from 56th to 57th Streets along Eighth Avenue, the topless U-shaped base, theatrically eclectic in its Art Deco style, remained an oddly truncated monument in a city of skyscrapers.

By 2001, when the corporation commissioned Foster and Partners to realize a tower here, the original exterior was already landmark-protected, and there to stay. Since completion of the base, naturally, some of the company's ambitions had shifted, while others remained virtually unchanged. A prime goal was still to bring Hearst's New York-based magazines under a single roof, but the 12 titles of 1928 had grown to 16, including such familiar glossies as *Esquire* and *Cosmopolitan*. While providing a 20,000-square-foot floor for each magazine (with a few larger or smaller exceptions), the new building would need to house test kitchens, a lab, a fitness center, and a full TV station, bringing the gross total area to 856,000 square feet.

And over the course of the project, the client would become interested in minimizing as well as maximizing its building's impact on the city—creating an iconic yet environmentally responsive tower or, as touted on Hearst's Web site, "not just a better skyline, but a better sky." Though the corporation had no particular history of architectural sustainability, Foster and Partners did, with applied research and a roster of techno-green projects, including Europe's tallest building, Commerce Bank, in Frankfurt. Even if Hearst's leaders had no initial green agenda, says Foster senior partner Brandon Haw, they readily embraced the possibilities—seizing the opportunity to raise the bar for environmental responsibility in a high-profile way, much as their competitor, Condé Nast, had attempted with its headquarters

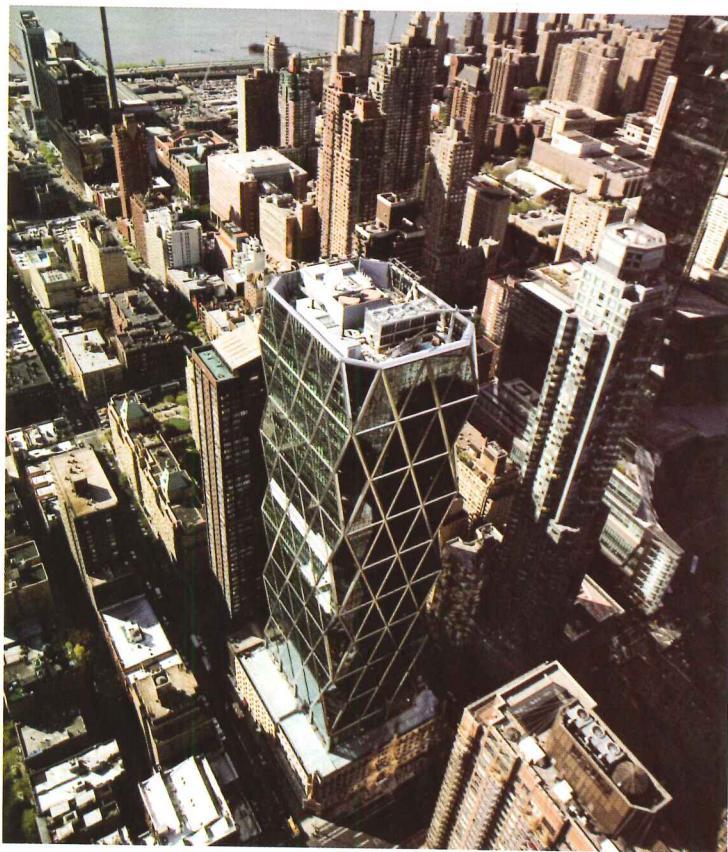

building by Fox & Fowle, 14 blocks away [RECORD, March 2000, page 90].

The choice of Norman Foster, a world-class architect who had yet to debut in New York City, seems hardly a fluke, especially given the practice's experience in adding onto prominent, if quasi-derelect, historic structures or sites, including the Reichstag, in Berlin [RECORD, July 1999, page 103], and the British Museum court, in London [RECORD, March 2001, page 114]. But even with that résumé, the architects initially found the Urban building "a rather strange Deco piece and a tired-looking landmark," recalls Haw. "And we wondered what would be the way into this project."

The firm's radical "way in" ultimately involved gutting the base and restoring its exterior, while opening up the interior via removal of the existing floor plates. The architects argued that the original floor-to-ceiling height of 11.5 feet would be inadequate by today's state-of-the-art office

Project: Hearst Tower, New York City

Architect: Foster and Partners—
Norman Foster, Brandon Haw, Mike Jelliffe, Michael Wurzel, Peter Han, David Nelson, Gerard Evenden, Bob Atwal, John Ball, Nick Baker, Una

Barac, Morgan Flemming, Michaela Koster, Chris Lepine, Martina Meluzzi, Julius Streifeneder, Gonzalo Surocca, Chris West, John Small, Ingrid Soken
Associate architect: Adamson Associates

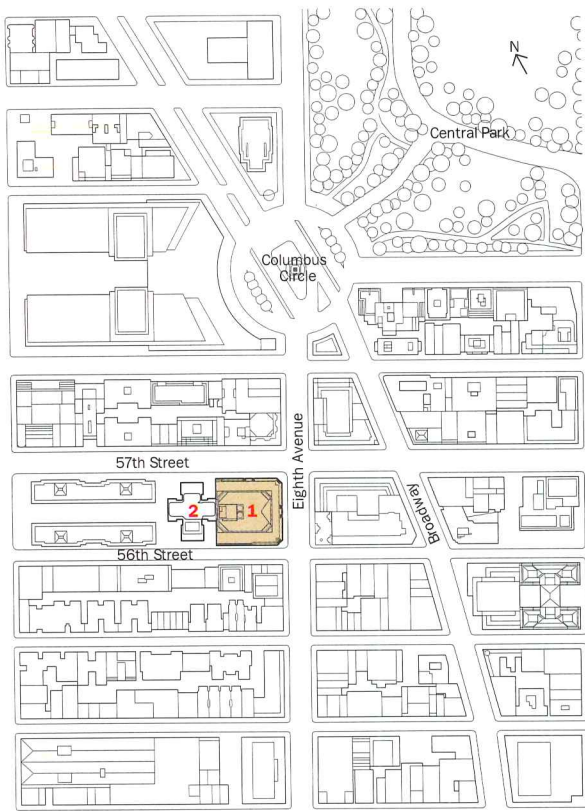

SITE PLAN

- 1. Hearst Tower
- 2. Sheffield Building

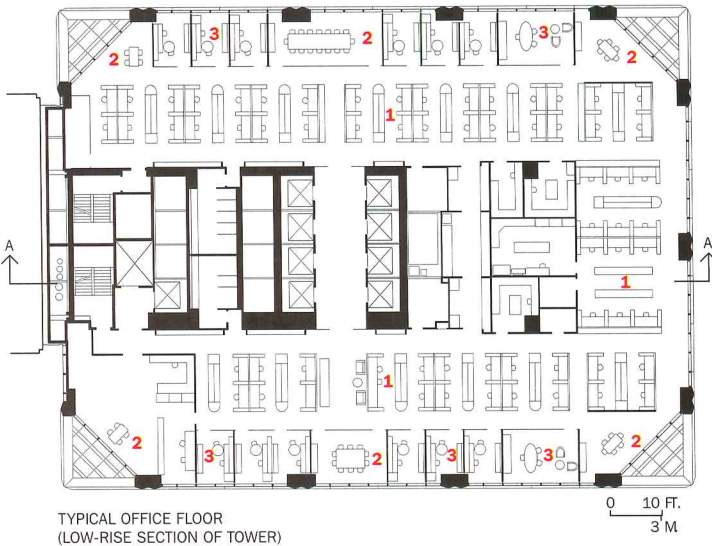

TYPICAL OFFICE FLOOR
(LOW-RISE SECTION OF TOWER)

- 1. Open cubicles
- 2. Meeting/conference
- 3. Office

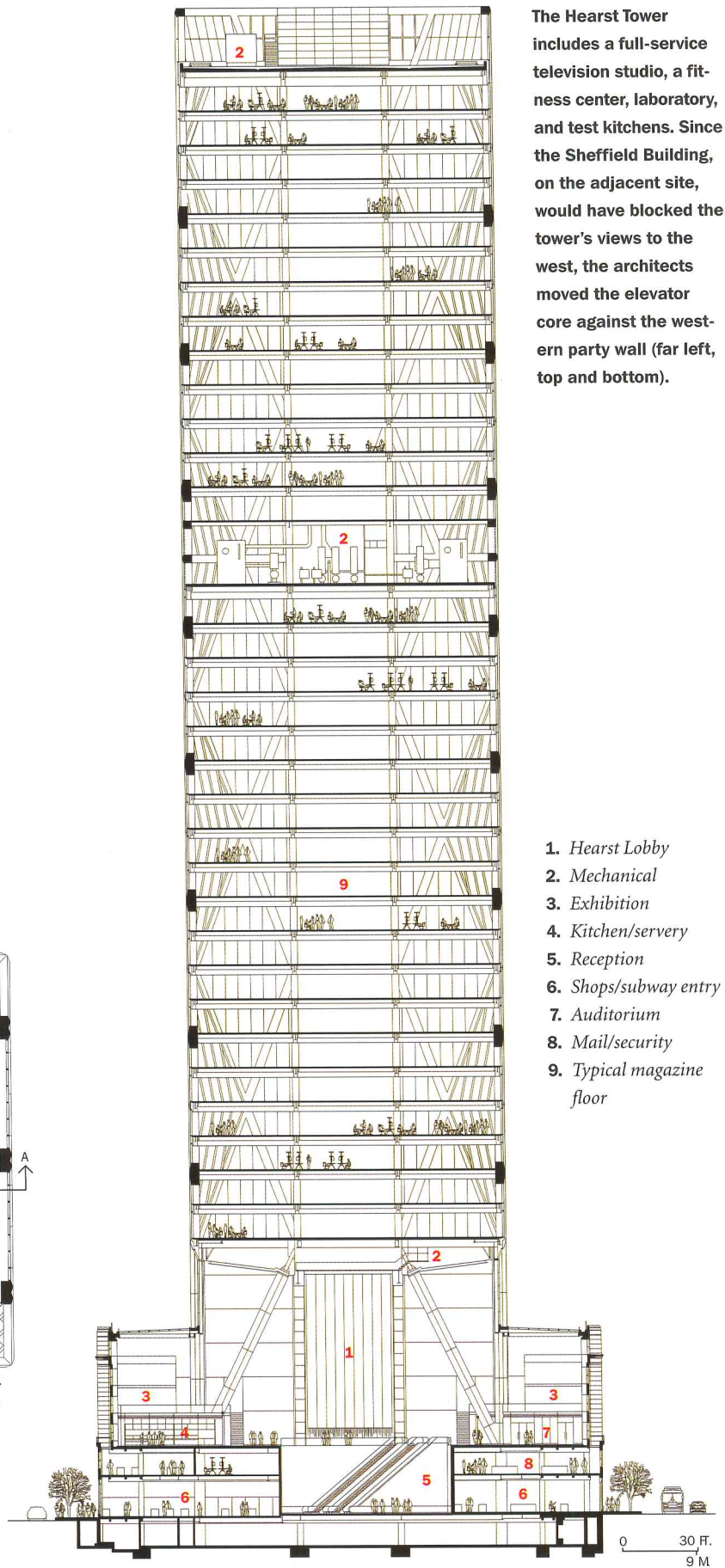

SECTION A-A

The Hearst Tower includes a full-service television studio, a fitness center, laboratory, and test kitchens. Since the Sheffield Building, on the adjacent site, would have blocked the tower's views to the west, the architects moved the elevator core against the western party wall (far left, top and bottom).

- 1. Hearst Lobby
- 2. Mechanical
- 3. Exhibition
- 4. Kitchen/servery
- 5. Reception
- 6. Shops/subway entry
- 7. Auditorium
- 8. Mail/security
- 9. Typical magazine floor



Since the diagrid eliminated the need for corner columns, the architects were able to carve back the volume and create the faceted and sculptural "open bird mouths."



A clerestory band and skylights bring daylight into the lobby, while marking a significant separation between the new tower and its vintage base. The three-story *Icefall* and escalators connect this area with the street level, below it. The employee cafeteria flows out into the larger communal space.

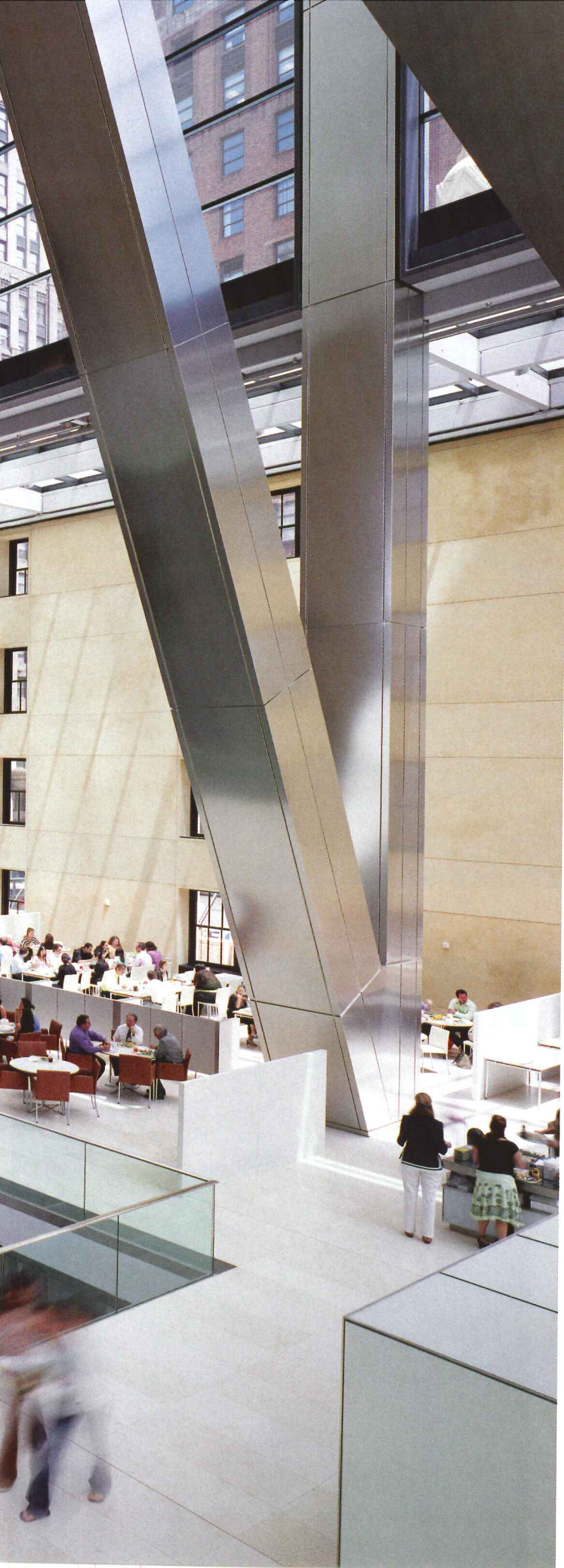

standards—and a more straightforward rehab would relegate “celebratory” communal spaces to the tower, rather than connect them with the street. The team envisioned turning the hollowed-out volume into an interior “town square,” with the tower “hovering” above it. “Certainly not the conventional solution,” confesses Lord Foster. “Everyone said, ‘You can’t do this in New York—you’ll be accused of Facadism’” (though in the end, the Landmarks Commission gave its blessing).

To realize this scheme, the architects reinforced the existing shell structurally (a necessity in the absence of the original floor plates), furred it out, and lined it with exterior stucco—an inside-out inversion akin to the outdoor walls the firm had transformed into indoor ones at the British Museum. At the Hearst building, Foster and Partners retained street-level retail space and subway entrances, raising the grand lobby (along with a new 492-seat cafeteria and 167-seat auditorium) three stories above grade, accessible by escalator. But even as the communal space fills with daylight and its modified walls show their heft, the town-square conceit remains semiconvincing, with the shell never quite shedding its stage-set quality.

Inside the lobby, the tower appears overhead through flat perimeter skylights—an apparition described by some as “floating” or stunningly soaring, and by others as outright jolting. Certainly the bold juxtaposition of the ornate base and prismatic tower is consistent with the practice’s earlier work, which distinguishes between old and new, favoring the contrasting play of materials, forms, and structural systems over pastiche or stylistic blending. This design, says Haw, “really evolved from a series of pragmatic considerations,” including a desire to set the tower back from its historic base, optimize the new structure’s view corridors, and fit into the skyline.

Because the Sheffield Building, on the adjacent site, blocks westward views, the architects moved the elevator core against the western party wall. While this shift from a conventionally centered core increased the unobstructed floor area, it could have left the eastern facade unstable and vulnerable to lateral wind forces. The structural solution, the architects determined, would require either a “robust” (i.e., hefty) moment frame or a visually and physically lighter diagrid, which, by their calculations, could (a) reduce the total amount of steel by 20 percent, (b) increase structural rigidity while reducing weight, (c) allow for 40-foot spans, maximizing column-free space, and (d) permit the elimination of corner supports. They chose the diagrid and later finessed its triangulated, faceted 3D form, trimming away volume at corners to create sculpturally distinctive “bird mouths.” The exoskeleton, reminiscent of a harlequin supergraphic, is deceptively scaled, with its triangles each rising four stories.

“Triangulation permeates the natural world,” says Foster, adding, “It’s an elegant system that brings visual lightness to what could have been a dumpy tower—after all, 46 stories is low by New York standards.” While the crystal geometry successfully shifts and shimmers with changing vantage points, the structure appears, in places, more muscular than light—as in the lobby, where huge stainless-steel-clad columns and diagonal members forcefully penetrate the space, carrying down the diagrid’s loads.

The language of triangles (largely pragmatic, rather than decorative) permeates the interior of both the base and tower. Just inside the building’s front door, a trio of three-story escalators connects the street level and grand lobby, or *piano nobile*, as Foster calls it. The escalators cut diagonally (in both plan and section) through the *Icefall*, a water feature that flows over a lit and canted cast-glass wall, a collaborative work by the architects with artist James Carpenter. Fed by recycled rainwater, the fall plays a significant role in cooling the vast lobby in summer (using chilled water) and humidifying it in winter. Rain, harvested in a 4,000-gallon reclamation tank in the basement, not only feeds the fountain, but also replaces moisture lost to evaporation in the office air-conditioning and irrigates plantings outside



WHAT MAKES THIS BUILDING GREEN?

- A waterfall that uses recycled rainwater, harvested in a 14,000-gallon tank, to cool or humidify the lobby, as needed.
- Recycled materials, including more than 85 percent of the steel.
- Low-E-coated glass that lets in sunlight without heat-producing radiation.
- An interior fit-out featuring sustainable, low-toxicity materials and products, mostly sourced locally.
- Sensors to conserve electricity and water.

Escalators (above) connect the entry, at street level, with the lobby or indoor “town square.” Skylights offer views from the town square to the tower, hovering above it. Structures supporting the stainless-steel-clad diagrid penetrate into the lobby (right).

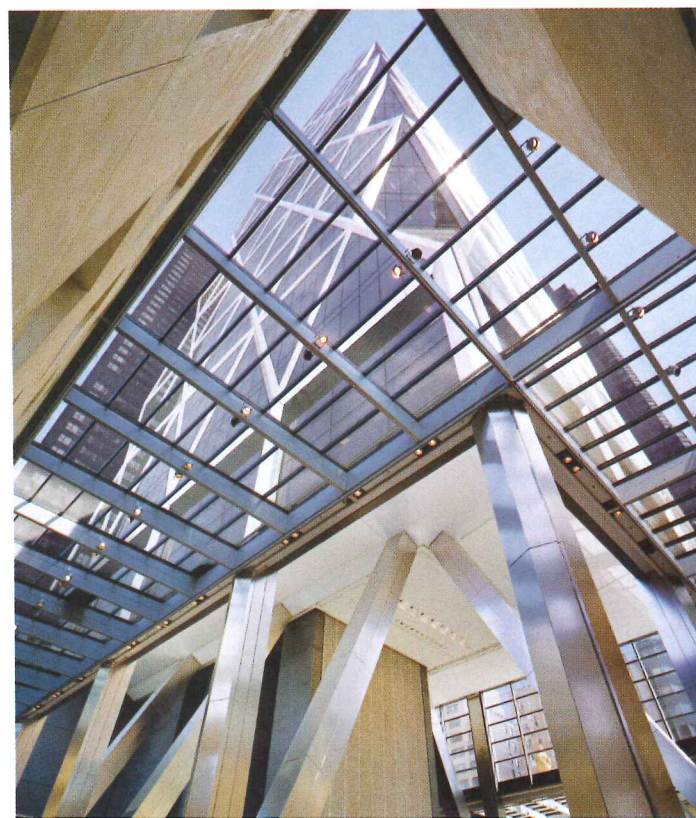

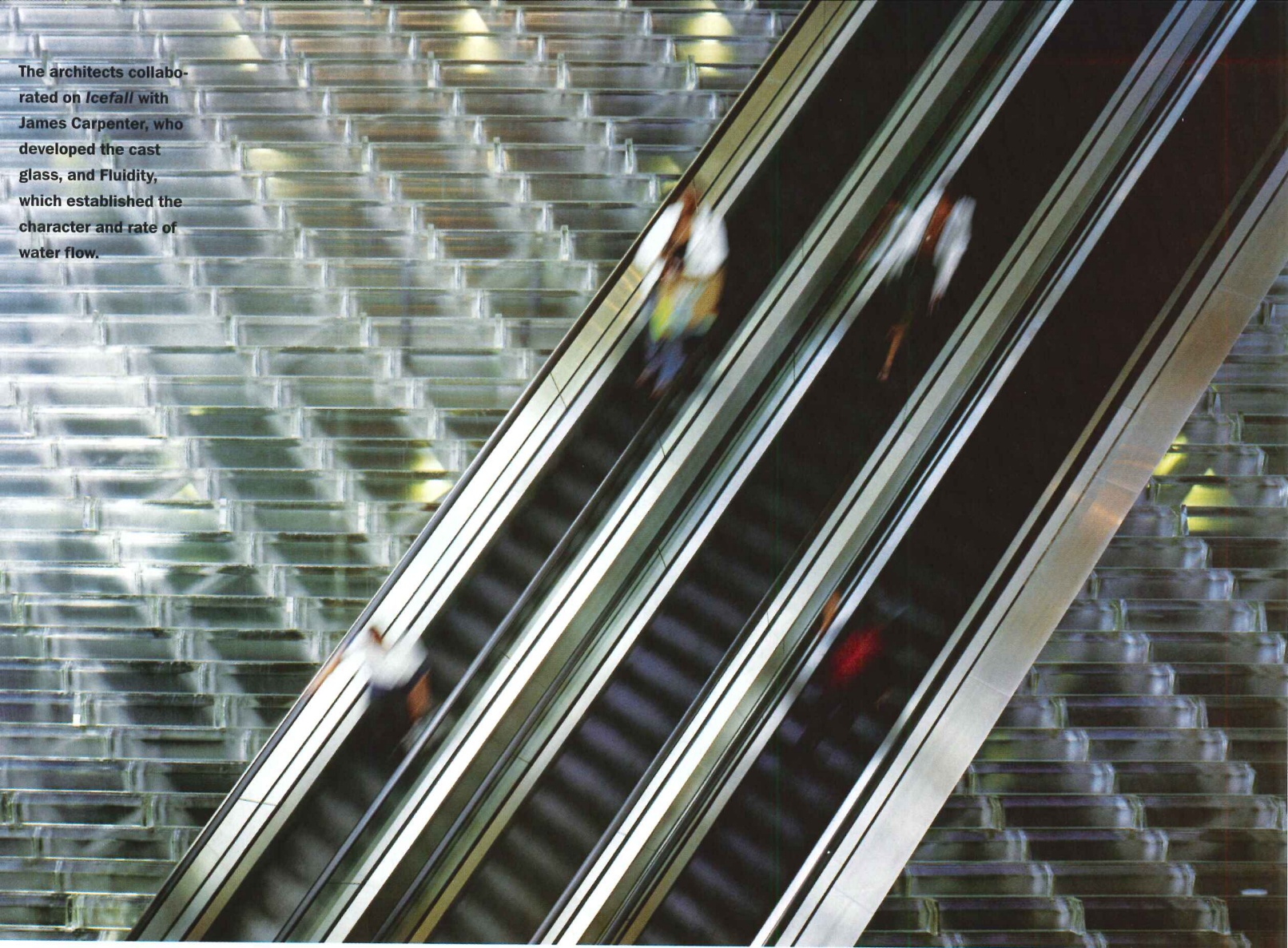

The architects collaborated on *Icefall* with James Carpenter, who developed the cast glass, and *Fluidity*, which established the character and rate of water flow.

the main entrance. Also, a radiant system of water-filled pipes under the lobby's limestone floor helps cool or heat the area, as needed, exploiting the stone's thermal mass and the water's efficiency in temperature conveyance.

The Hearst Tower, expected to receive a LEED Gold certification from the United States Green Building Council (USGBC), boasts a long list of environmentally responsible features. For starters, recycling began at the demolition site. More than 85 percent of the tower's steel is recycled, and the diagrid saves an estimated 2,000 tons of steel. The climate-control system incorporates "free air-cooling," using filtered outside air without temperature adjustment 75 percent of the year, according to project architect Michael Wurzel. Other features include reflective roof pavers that increase energy efficiency by reducing solar absorption, and low-E-coated glass that ushers in daylight without heat-producing radiation. And such small measures as sensors throughout the building conserve both electricity and water.

Because the building (at a cost exceeding \$500 million) is privately held and entirely owner occupied, the client and architect could guide many levels of green decision making. Even the fit-out, from carpets to desktops, features sustainably harvested finishes, low in toxicity, with the majority of materials and products sourced locally. And although 7 World Trade Center beat Hearst in receiving the city's first Gold LEED rating, that tower—a speculative project intended for rental tenants and certified under the USGBC's pilot core-and-shell program—is far less comprehensively green.

From an aesthetic standpoint, the Hearst Tower's private ownership and occupancy permitted the architect to take risks with spatial allocation and formal invention—creating the soaring lobby and corner "bird mouths"—that a client poised to collect rent on every square inch would have nixed. Hearst employees, now gradually moving in, are already flocking to the cafeteria and fitness center (on the 14th floor), mingling in the indoor "piazza," and basking in the luxury—so rare in Manhattan office towers—of light, air, and space. Though the idea of a fountain in a grand lobby springs from the very cliché of corporate prowess, the architects have given it new life and green purpose. And surely, in their investigation of the building skin, they have developed an unprecedented perimeter structure.

A controversial building, the Hearst Tower has its admirers, who look for it eagerly on the skyline, and, undeniably, its detractors—including a critic who describes it as "arbitrarily sliced off" and "meeting the sky abruptly" or the lady on the street who likens it to a "crystal vase on a doily."

But controversy is not necessarily a bad thing. "I know the tower doesn't have a conventional flourish on top," says Lord Foster, "but the building's not conventional in many ways—and for that I make no apology." ■

Sources

Curtain wall: *Permasteelisa*
Office furniture: *Steelcase*

Demountable partitions: *Lema*
Upholstery: *Vitra; Walter Knoll*

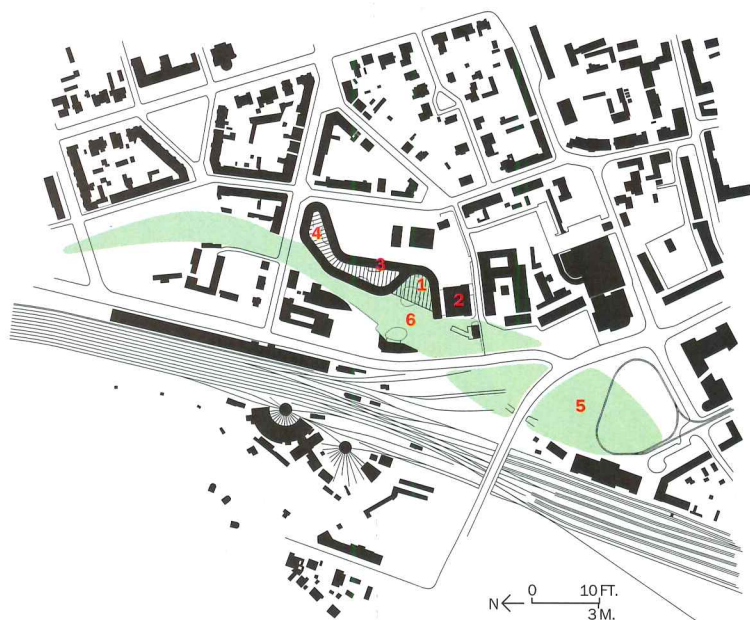

1. Public lobby
2. Library
3. Offices
4. Atrium
5. Green space
6. Park

By Suzanne Stephens

One of the most “iconic” buildings erected in Europe in the past few years does not arrest your attention as a monumental architectural and engineering extravaganza. While its sinuous, polychromatic features unfold intriguingly before you, its entire gestalt can be taken in only by viewing it from the air. The symbolic impact of the Federal Environmental Agency (Umweltbundesamt/UBA) building, in Dessau, Germany, owes more to its achievement in energy-conscious measures than as a quickly grasped image. Designed by the Berlin-based Sauerbruch Hutton Architects, a firm known for its sustainable buildings rendered with unusual verve, such as the GSW Headquarters in Berlin [RECORD, June, 2000, page 156], the amoeboid concrete structure, clad in colored glass panels and wood, represents an imaginative combination of energy-saving design and technology.

Ironically, the Federal Environmental Agency decided to build its new home in Dessau, where Walter Gropius designed the legendary Bauhaus in 1925–26, after he had moved the school from its original

Project: Federal Environmental Agency, Dessau, Germany
Architect: Sauerbruch Hutton Architects—Matthias Sauerbruch, Louisa Hutton, Juan Lucas Young, Jens Ludloff, principals in charge; Andrew Kiel, René Lotz, project architects
Engineers: Zibell Willner & Partner (energy concept and environmental

engineering); Krebs & Kiefer, (structural); ITAD (plumbing); KEMPA (civil); G.U.T. (environmental remediation)
Landscape architect: ST raum a
Consultants: GFÖB (ecological); IEMB (energy); Mueller-BBM (building physics); Schallschutzbuero Diete (acoustics)

The sinuous office complex (this spread) is located on the site of a former gasworks. A reclaimed park includes a metal sculpture by Hans-Joachim Härtel (below), which hides air ports for a geothermal heat exchanger.



PHOTOGRAPHY: © ANNETTE KISLING, EXCEPT AS NOTED; PAUL RAFTERY/VIEW (THIS SPREAD AND INSET)

Sauerbruch Hutton Architects brings
pizzazz to sustainability in the
FEDERAL ENVIRONMENTAL AGENCY

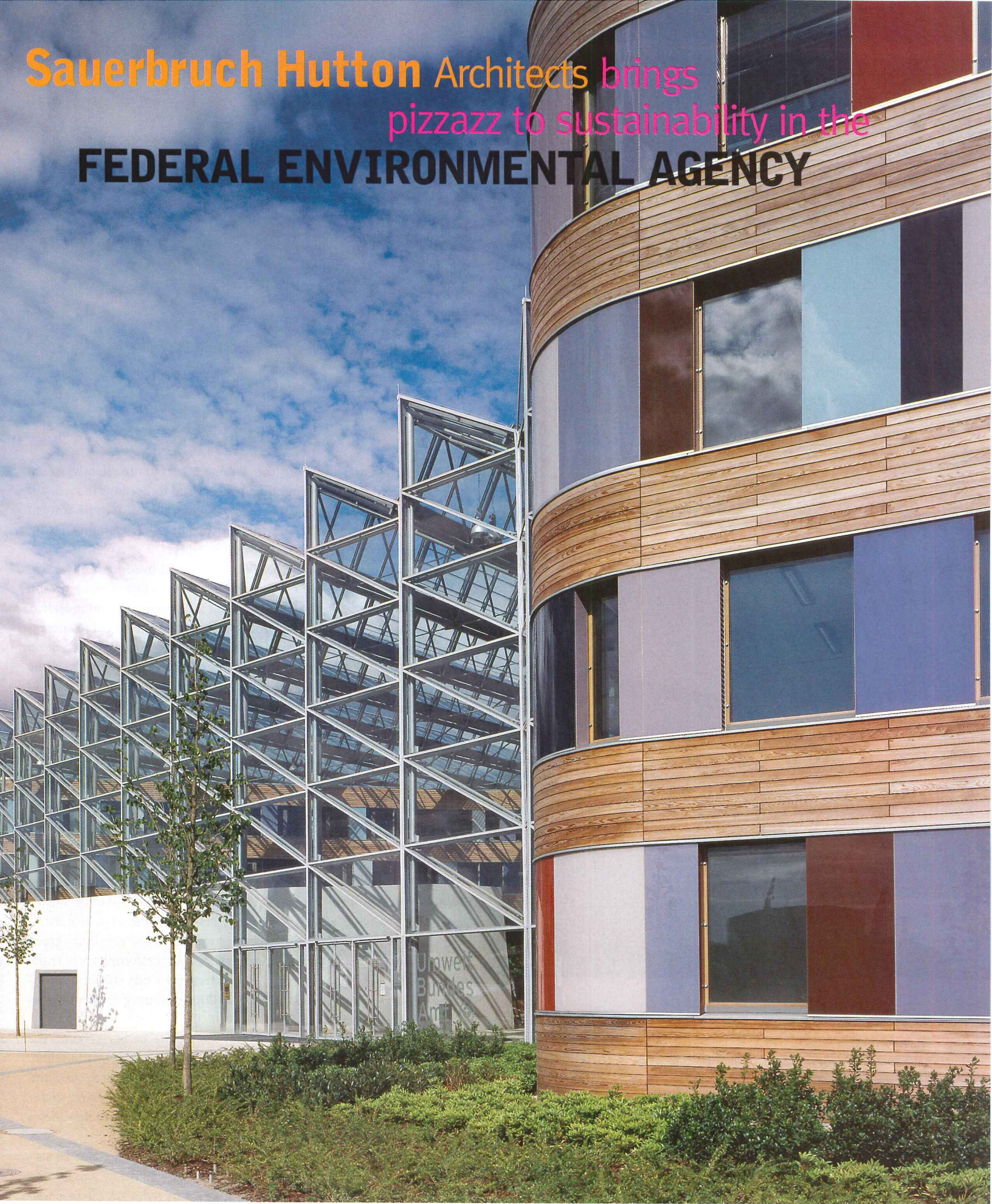



WHAT MAKES THIS BUILDING GREEN?

- Twenty percent of the energy comes from renewable sources.
- A compact form and high levels of thermal insulation minimize heat loss.
- A geothermal heat exchanger precools air in the summer and preheats air in the winter.
- Thermal solar collectors and photovoltaic cells make use of solar energy.
- Natural ventilation and convection replace air-conditioning.



The old Wörlitzer Bahnhof station (above) is being recycled for an information center for the environmental complex. The café is detached from the main building (far left in photo above) and overlooks a pond.

home in Weimar. Although the Bauhaus served excellently as an International Style icon of functional design and technology in its day, it was hardly energy-conscious: All you had to do was look at its prominent glass facade facing west to get the picture. But that was then. Now, Modernism increasingly embraces sustainability.

In planning the new 400,000 square-foot headquarters for 800 employees, the agency decided this would not only be a demonstration project for energy-conscious practices, but also a learning center. Hence, it includes a library—the largest public one in Europe devoted to energy-conscious topics—plus an auditorium, exhibition area, information center, and café. The agency called for 20 percent of the energy to come from renewable sources, and required that heating consumption be 40 percent less than Germany's energy standards currently in effect.

Although the agency had been based in Berlin, the government wanted to help revitalize Dessau, a former industrial center, which is now afflicted with a 40 percent unemployment rate. Nevertheless, many of the agency employees still commute an hour and 20 minutes from Berlin. Fortunately, rail commuters need only walk a few minutes to the site, formerly the location of a gasworks factory. The bad news was that the gasworks had contaminated the soil and groundwater, leaving a nasty mess that required replacement of 30,000 cubic feet of earth.

Traces of the industrial past remain: A former factory building (Building 109) and the mansard-roofed old Wörlitzer Bahnhof, once a station for a rail line, as well as unused tracks along the west, give the 7-acre site a picturesquely gritty aspect. However, to the north lies green open space now connected to a linear park within the complex where the tracks are being landscaped. To the east stretches a tidy cluster of 19th-century houses, and to the south, a mix of 20th-century apartment blocks and commercial buildings.

In keeping with the program, the architects are recycling the Wörlitzer station for an information center, while the old factory building, notable for its Belgian bond-brick walls, has already been renovated and expanded for the library. To link the old building to the complex, the architects created an extension with an ascending giraffe-neck form that allows natural ventilation to flow into the library.

For the main office building, Sauerbruch Hutton created a serpentine plan enclosing a glass-topped atrium. Not only would the four-story building be more compact in terms of reducing exterior wall



The main building's spandrel panels, sheathed in Bavarian larch, alternate with bands of clear and colored glass. Thirty-three colors refer to the surrounding context: Panels nearest the park on the north (right) are green, while the panels nearest the old brick factory and its new library wing (left and right) are dark red, lavender, and purple. The eastern facade, facing a 19th-century residential neighborhood (above), features ochre, orange, and red hues.



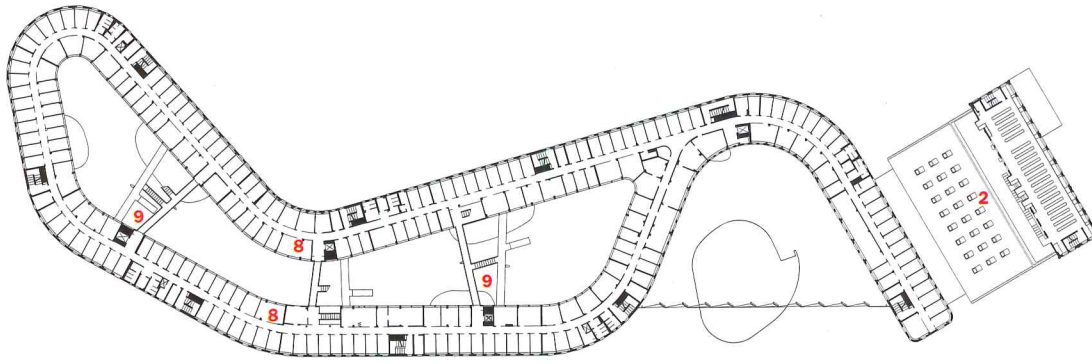

SECOND FLOOR

Daylight is admitted to the landscaped atrium through the serrated-glass roof (right). The offices in the double-loaded looping plan receive daylight and air through use of operable windows. All employees have their own offices with windows, and ones overlooking the atrium seem to be favored.

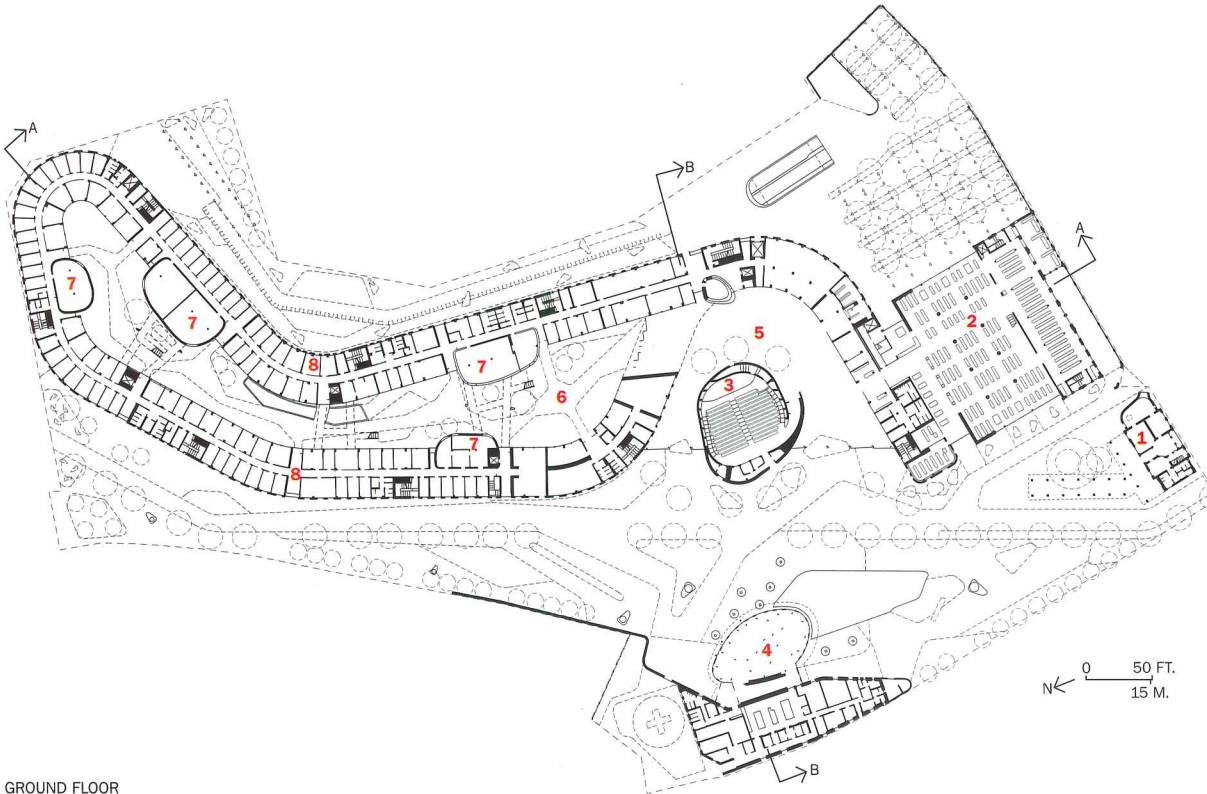

GROUND FLOOR

1. Wörlitzer Bahnhof
2. Library
3. Auditorium
4. Cafeteria
5. Forum (public lobby)
6. Atrium
7. Meeting spaces
8. Offices
9. Bridges
10. Parking

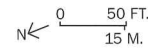

SECTION A-A

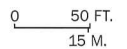

SECTION B-B



surface exposed to the harsher elements, but workers wouldn't be drawn down seemingly mile-long, straight corridors.

The ends of the 1200-foot-long loop don't meet; a large serrated glazed wall acts as the entrance and flanks a discretely sculptural concrete form containing the auditorium. (Several other such sculptural objects, dubbed "boulders," positioned around the atrium, provide conference spaces.) Within the atrium, ST raum a, Berlin landscape architects, designed a park of variegated plantings. It is in turn crossed by bridges at three points to connect the looping strand of double-loaded offices.

In keeping with the back-to-nature look, Sauerbruch Hutton covered the exterior spandrels in Bavarian larch, now weathering to a light gray. Polychromatic glass panels, with the colors screen-printed on their backs, alternate with clear glass windows for the horizontal fenestration. The varied hues stemming from seven different families of colors alleviate any sense of monotony in the long, linear form; on top of that, contrast-

ing colors on the reveals of flat steel or louvered panels heighten the facade's three-dimensional quality.

To keep the building within the \$82 million budget, the architects relied on a poured-in-place concrete frame with a flat-slab construction generally supported by two rows of edge columns. Exposed concrete ceilings provide thermal mass to hold heat and cold at the appropriate times of the year.

The building's atrium remains about 22 degrees Fahrenheit warmer than the outdoors during the cold months, helping to minimize heat loss. In another move, Sauerbruch Hutton cut down on consumption of electricity and heat with cogeneration systems that reuse waste heat from the mechanical system. For the building's overall heating needs, the firm took advantage of methane gas from a local landfill. In addition, photovoltaic panels in the glazed shed roof over the entrance area can supply a percentage of the electrical load. On the roof of the main building,

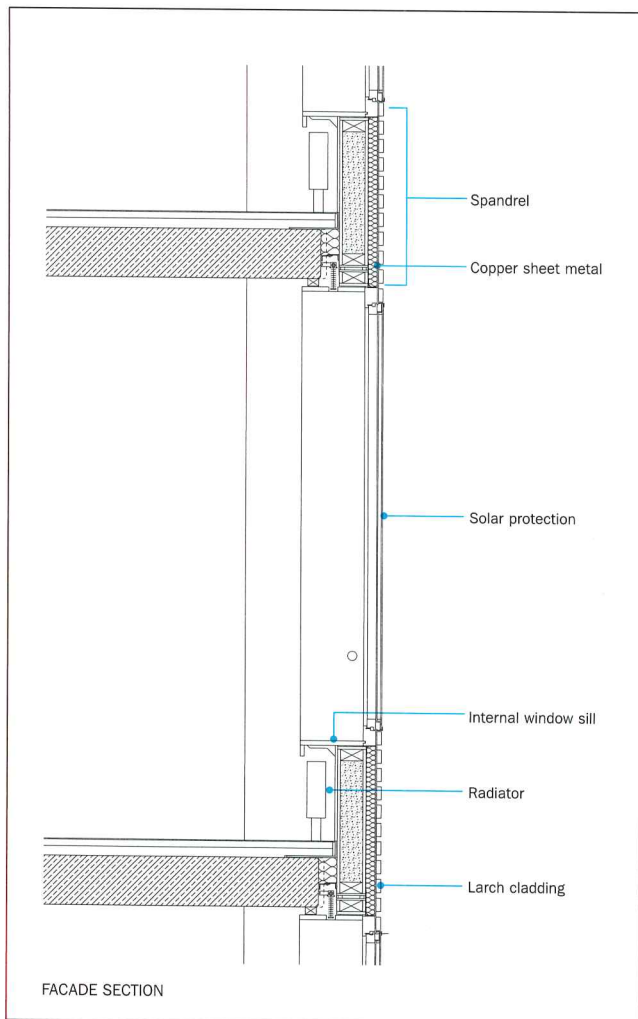

In the summer, hot air is drawn over the subterranean geothermal heat exchanger to cool it; natural convection takes hot air out through the atrium. In the winter, cool air is preheated by this system.

vacuum-tube heat pipe collectors harness solar energy to help cool the building's mechanical system. The most significant energy-saving feature, explains principal Louisa Hutton, is the geothermal heat exchanger, which involves a subterranean system of pipes, 3 miles long, the largest air-based geothermal exchange system in the world. The heat exchanger allows preheating of air in the winter and precooling in the summer before it is circulated to the offices. The air is drawn from the outside, into the underground air passages by four air-handling units in the basement. It then moves through ducts in the foundation slabs to riser shafts, and finally into the ducts in offices' suspended ceilings. The agency jettisoned air-conditioning for natural ventilation, with operable windows, and natural convection. In the summer, convection ventilates air through the atrium, while cooler air is drawn in at night through wood panels that automatically open.

Owing to UBA's role as a demonstration project, intensive research informed the battery of environmental approaches to save energy consumption in the building, and ongoing analyses are being undertaken

Each of the 800 employees has his or her own office of 129 square feet (a fitting rebuke to the acoustically challenged open office). Triple glazing keeps heat from being lost in the winter, with operable windows used for natural ventilation.

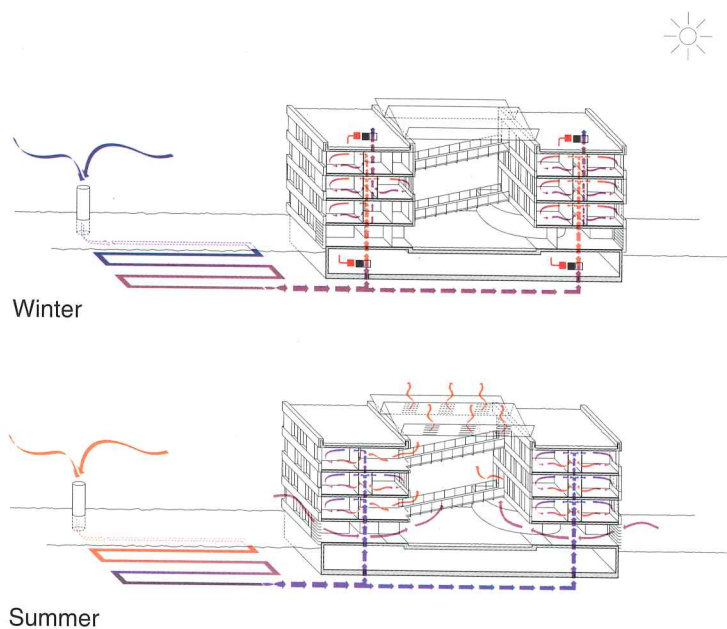

to monitor the efforts. In the year it has been open, the architects found that the energy strategies have not only met expectations, but the agency is using even less electrical energy than originally estimated. Now visitors to Dessau have yet another architecturally significant attraction to visit. Here in Dessau, the Federal Environmental Agency shows how sustainability can seize the avant-garde imagination, overriding (but not neglecting) the Bauhaus's attention to function, technique, and material. ■

Sources

- Wood panels and windows:** Schindler GmbH
- Colored glass:** BGT-Glastechnik
- Serrated-glass roof and metal-and-glass curtain wall:** Brakel-Aero GmbH
- Steel for library and cafeteria**

- facade:** ER+TE Stahl und Metallbau
- Masonry:** Peschek GmbH
- Built-up roofing and elastomeric:** Sinhor Dach GmbH

For more information on this project, go to Projects at www.archrecord.com.



Sauerbruch Hutton renovated a former factory building for the library, and linked it to the main office complex with a structure whose roof swoops up to a 50-foot height (above). Controlled daylight permeates the stacks of the recycled library building (near left), and penetrates glazed interior corridors of the office structure (right).

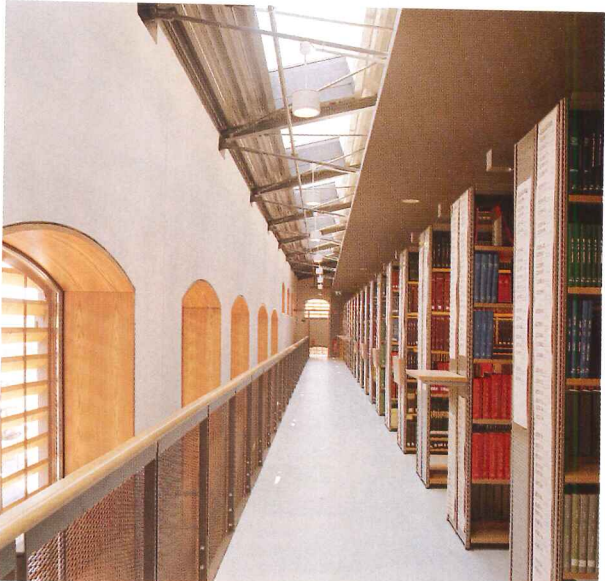

The 630,000-square-foot library anchors an important site in downtown Singapore (this page), just a block from the historic Raffles Hotel. From the south, visitors can see that the building divides into two parts: a curving structure facing east and a rectilinear block to the west (opposite two).



T.R. Hamzah & Yeang applies its trademark bioclimatic design principles to the new NATIONAL LIBRARY in Singapore

By Clifford A. Pearson

Ken Yeang has been preaching the green gospel for more than 30 years. He has written books with titles such as *Bioclimatic Skyscrapers* (1994), *Designing With Nature* (1995), and *The Green Skyscraper* (2000). He has participated in exhibitions such as *Big & Green* at the National Building Museum in Washington, D.C. (2003), and served as a talking head in the recent ecodesign television program *Design: e2*. He worked on a doctorate in ecological design in the early 1970s, when most architects thought green was just something you found on a Pantone card. And when he returned to his native Malaysia after school in England (the Architectural Association and Cambridge University), he started designing modern buildings that worked with the local climate instead of merely fighting it with airtight envelopes and lots of air-conditioning—buildings such as the Menara Mesiniaga [RECORD, March 1993, Pacific Rim section, page 26] and the Guthrie Pavilion [RECORD, August 1998, page 81]. With his new National Library in Singapore, he has applied all this expertise to a building type often seen as resistant to energy-saving design and, in the process, has created a civic icon for a city-state bent on leveraging knowledge as an economic engine.

Libraries tend to fall into two basic categories—the fortified box and the refrigerator. The first protects books from temperature changes and ultraviolet rays by erecting thick walls with few openings,

Project: *The National Library, Singapore*

Owner: *National Library Board Singapore*

Architect: *T.R. Hamzah & Yeang—Ken Yeang, principal in charge; Timothy Andrew Mellor, Lim Hock Huat, Chong Voon Wee, Rodney Ng, project architects; Rajiv Ratnarajah, resident architect; Ridzwa Fathan, design director (schematics); Jason Yeang, Monie Mohariff, Yvonne Ho, Kenneth Cheong, Kevin Chung,*

design architects

Architect of record: *DP Architects*

Engineer: *Buro Happold Singapore (structural, mechanical/electrical)*

Consultants: *Woodhead Wilson (interiors); DLQ Design (landscape); Lighting Planners Associates (lighting); Total Building Performance Team (acoustics); Arup Singapore (facade design); Ove Arup & Partners International (IT)*

General contractor: *Nishimatsu-Lum Chang Joint Venture*



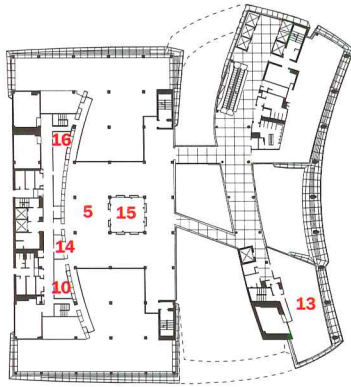

THIRTEENTH FLOOR

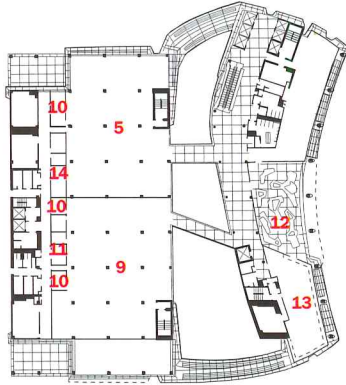

TENTH FLOOR

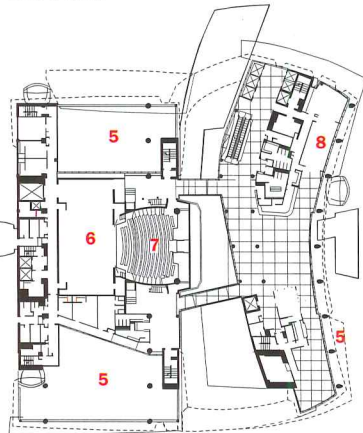

THIRD FLOOR

1. Drop-off
2. Covered plaza
3. Outdoor dining
4. Information
5. Library collections
6. Drama center
7. Theater
8. Training
9. Offices
10. Meeting
11. Prayer
12. Skycourt
13. Exhibition
14. Staff
15. Rare books
16. Storage

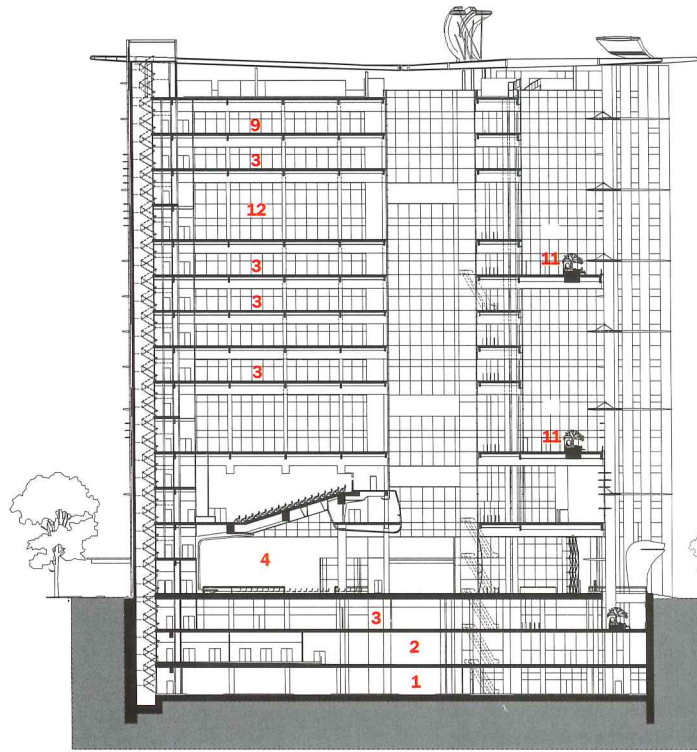

SECTION A-A

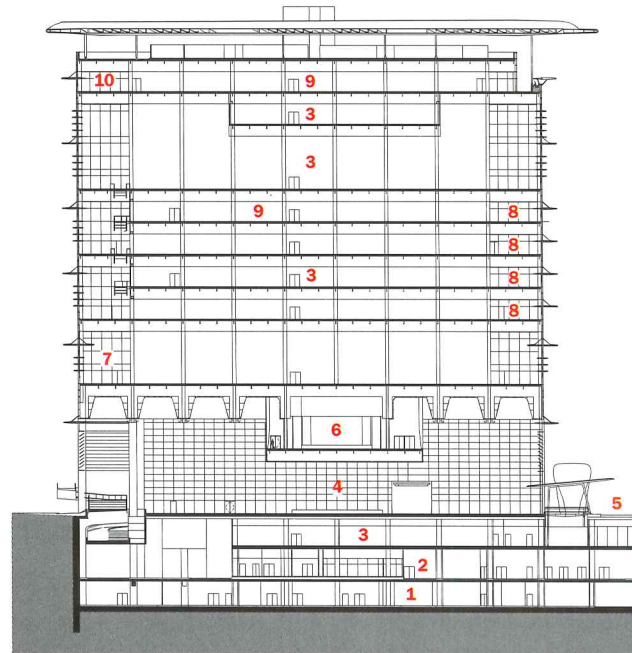

SECTION B-B

- | | |
|------------------------|---------------------------|
| 1. Parking | 7. Theater administration |
| 2. Loading | 8. Reading |
| 3. Library collections | 9. Library offices |
| 4. Covered plaza | 10. Terrace |
| 5. Main drop-off | 11. Skycourt |
| 6. Theater | 12. Periodicals |

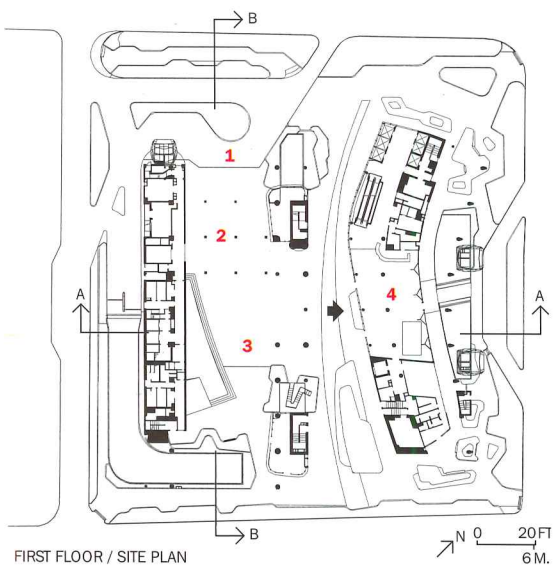

FIRST FLOOR / SITE PLAN



The gap between the building housing the library collections and the one with exhibition and cultural spaces brings cooling air through the site. "Super-fins" that are 20 feet wide span the gap, helping to shade the building.



In a tropical place such as Singapore, shade rather than sun attracts pedestrians. The building's perimeter is protected by a series of glazed canopies (opposite), and visitors enter the library from a covered plaza underneath part of the building. A shaded walkway runs along the eastern side of the site (left), where a sunken courtyard brings daylight into the basement level.

WHAT MAKES THIS BUILDING GREEN?

- A variety of shading devices, including 20-foot-wide super-fins, protect the glass curtain wall.
- The building is separated into two blocks, and one is raised off the ground so wind cools the structure.
- Only parts of the building are fully air-conditioned; others are naturally ventilated or cooled by mechanical means such as fans.
- Sensors control light fixtures to reduce their use.
- Nearly 70,000 square feet of planted areas shade the building.

while the latter controls temperature by chilling interior spaces, albeit at the expense of energy efficiency. In his design for the National Library, Yeang explores a third way—harnessing cooling breezes, sun-shading devices, daylighting strategies, and planted terraces and skycourts to create a building that is both transparent and ecofriendly.

At first glance, the building seems to be trying a bit too hard to impress, with a sweeping facade on the east, a vast array of projecting blades and shelves, and a UFO-shaped viewing pavilion hovering above the roof. But these moves help animate what could have been a large, squat building—630,000 square feet and only 16 stories high. And by carving deep recesses and skycourts into the white blocky form, the architect creates a lively play of shadow and light that not only pleases the eye but offers cool spaces for people using the building.

When the National Library Board of Singapore held a design competition for the project in 1998, it didn't ask for a green building, recalls Yeang. "They were looking for a civic icon," he says. As the Singapore economy has shifted in recent years from an industrial base to one driven by information technologies and services, the government has undertaken the construction of sprawling educational campuses, some designed by high-profile international architects such as James Stirling/Michael Wilford [RECORD, May 1997, page 102] and Gwathmey Siegel [RECORD, December 2001, page 92]. Now it is trying to add a cultural layer to an urban mix that had previously emphasized shopping and eating as the island nation's primary spare-time activities. A new

national library building in a busy part of downtown offered a chance to bring learning and culture together in an attention-grabbing venue.

Yeang's competition entry pulled the building into two separate parts—a banana-shaped structure on the east for exhibition spaces and cultural activities and a blockier structure on the west that would house the library collections and reading rooms. A tall atrium or semienclosed "street" would run between the two pieces, with bridges at the upper levels connecting the two sides. By raising the collections block one story off the ground, Yeang created a covered plaza at ground level that offers a large, shaded space for an outdoor café and all kinds of public events, such as book fairs and dance performances. The jury was impressed by the new civic space Yeang's design would offer the city and by the opportunities to program exhibition spaces on each floor in conjunction with the particular library collections on that level. "The client told me I made them rethink how a library works," says Yeang. In May 1999, the jury awarded Yeang the commission over designs by Michael Graves, Moshe Safdie, Mitchell/Giurgola, and Nikken Sekkei. Construction began in November 2001 and the library opened in November 2005 at a cost of \$204 million. By the end of construction, Yeang had become a partner in the London firm Llewelyn Davies Yeang, which now serves as a sister company to his Kuala Lumpur-based firm T.R. Hamzah & Yeang.

As he does with all of his projects, Yeang started work on the National Library by figuring out the proper orientation of the building in relation to the sun and prevailing breezes. To block the impact of the



Central Lending Library
Level B1

e-King Club Reference Library

How has this library transformed you?

- I Love My Library
- Please make the most of the library
1. Borrow books
 2. Borrow e-books
 3. Borrow audiobooks
 4. Borrow DVDs
 5. Borrow CDs
 6. Borrow magazines
 7. Borrow newspapers
 8. Borrow reference books
 9. Borrow study materials
 10. Borrow research materials

- Small Research Services
1. Reference services
 2. Information literacy
 3. Research support
 4. Academic writing
 5. Study skills
 6. Career guidance
 7. Language support
 8. Disability services
 9. Library tours
 10. Library events

Lee Kong Chian Reference Library

Information Services



The “pod” on top of the building offers views and space for special events (right). Each of the library’s collections has its own reading and stacks space and a great curving wall of books (opposite).



afternoon sun, he lined up support and service areas for the collections along the western edge of the building, creating a climate buffer for the large reading rooms and open book stacks. On the east facade, he angled the building so the sun would deliver only glancing, not direct, blows, and he protected the low-E glass curtain wall with plenty of protruding shading planes and opaque spandrel glass. Slicing across the north and south ends of the open atrium, giant metal blades block direct sun rays while bouncing daylight deep into interior spaces. With their crossed-steel-cable bracing, these 20-foot-wide “super fins” recall the wings of old biplanes and add a dash of derring-do to the north and south facades. Although most large buildings in southeast Asia have concrete frames, Yeang and structural engineer Buro Happold Singapore designed a steel framing system for the National Library, in part because steel is recyclable and is faster to erect.

Raising the collections block off the ground not only creates a public plaza, but allows air to circulate and cool the building. Likewise, the covered atrium runs north-south to capture breezes (and to frame the view north to the historic St. Joseph’s Church across Victoria Street). By installing louvers in the glass roof above the atrium, Yeang used convection to pull hot air up and out of the space. And because the covered plaza and atrium aren’t enclosed, he was able to convince the regulatory authorities that these spaces shouldn’t count as part of the building’s floor area ratio.

Combining generous glazing with a variety of sun-shading devices, Yeang was able to use daylighting for much of the interiors and reduce the library’s dependence on electric light. Two sets of sensors (one just within the building perimeter and the other farther in) control light

fixtures so illumination levels can remain adequate in each zone with the least amount of energy used.

The architect also used a zoning system for temperature control inside the building. Instead of treating all spaces the same, he customized climate control depending on the way each area is used. So the library collections, reading rooms, and theater are fully air-conditioned and lit with electric fixtures (what Yeang calls “full mode”), while the covered plaza is naturally ventilated and mostly daylit (“passive mode”), and transitional spaces such as lobbies and foyers use a combination of natural ventilation and mechanical means, such as fans (“mixed mode”).

Yeang’s buildings not only act green, they *are* green, thanks to his use of planted terraces and landscaped skycourts. For the National Library, he created nearly 70,000 square feet of such green spaces with planted corner terraces on most floors and six large skycourts spread throughout the building. “In nature, most things are a combination of organic and inorganic material,” states Yeang. “We’ve tried to imitate that by bringing veggies deep into the building mass.” In this project, the green material starts below the street, where he carved out a planted courtyard that brings daylight into the basement to create a bright, attractive space that serves as the lending-library floor. (Books in all other parts of the library do not circulate.) On the 5th and 10th floors, he cut into the east elevations to create 45-foot-high skycourts with large trees, winding paths, and benches.

In previous projects, Yeang had always tested his design ideas with computer and physical simulations during design development. But with the larger scale (and budget) of the National Library, he was able to run thermal, sun-shading, daylighting, and wind simulations at several



A large skylcourt provides an outdoor green space for visitors to enjoy (above). Sensors help reduce the use of light fixtures (diagram below), as does plenty of daylight (above right).

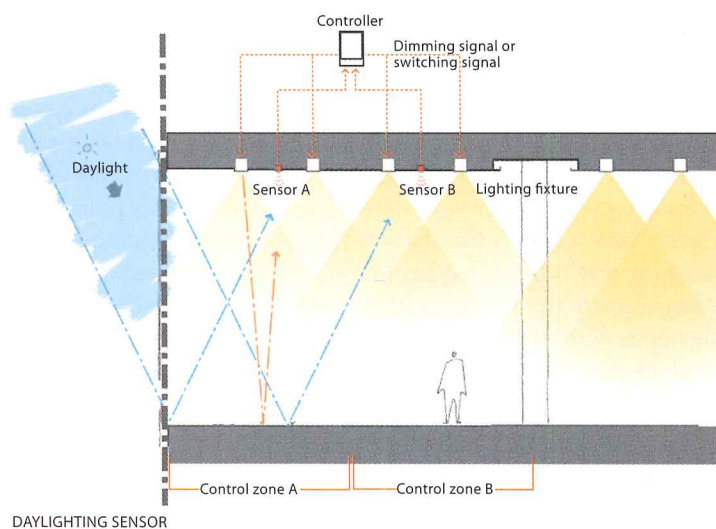

stages in the process, fine-tuning his design at each step. As a result, he reduced projected energy consumption to 185 kilowatt hours per square meter per year, well below 230 kwh/m²/year, the amount used by a typical office tower in Singapore. After opening last November, the building ended up using 162 kwh/m²/year, below even the projections. In recognition of this, the Singapore Building and Construction Authority awarded the building the Green Mark Platinum rating, its highest.

For Singapore, the National Library stands as a symbol of a new era. As the nation tries to shed its image as an efficient, but uptight, “nanny state,” it hopes to unleash economic growth by encouraging its people to use their minds more than their muscles. (The new, more freewheeling climate even includes casinos, but that’s another matter.) With his gleaming, ecofriendly design, Ken Yeang has given the country a building that points to a future in which information, environmental technologies, and cultural development lead the way. ■

Sources

Structural steel: Continental Steel
Structural sealant: Dow Corning
Gaskets: Gaintect
Glazing: Singapore Safety Glass
Vision glass and spandrel glass: AFGD Glass
Pivot-swing entry doors: Flamelite
Paints and stains: ICI Paints
Composite interior panels: Mitsubishi Chemical Functional

Products

Aluminum panels: Alcom Malaysia
Floor and wall tiles: Leefon
Carpeting: Shaw Industries
Auditorium seating: Ergoworld;
 Besco Building Supplies
Black-box seating: Besco Building Supplies
Upholstery: Pacific Furnishing;
 Fabrication
Accessibility lift: Fujitech Singapore



Each of the library's collections is served by an open reading area. On the other side of the building (seen through the curtain wall), spaces for exhibitions can be programmed to work in conjunction with the collections.



The building's steel roof incorporates six elliptical domes, with one topped by a lantern and a 20-foot-tall, rotating wind cowl (above and below). An iconic funnel above the debating chamber is visible at night (opposite).



Richard Rogers used transparency and ecological responsibility as guiding values in his design for the NATIONAL ASSEMBLY FOR WALES

By Catherine Slessor

For such a comparatively modest building, the new National Assembly for Wales was charged with immense political, economic, and architectural expectations. Politically, it represents the aspirations of the Welsh people, who voted for a degree of autonomy in their national affairs in a referendum in 1999. Though Wales has effectively been part of the United Kingdom for over four centuries, the modern principality sustains a strong nationalist movement, wary of what it perceives as the remote and often overbearing power of Westminster, the London-based parliament. This desire for political autonomy is matched by a highly evolved sense of Welsh identity and culture, exemplified by the resurgence of the Welsh language, now extensively taught in schools and omnipresent in a bilingual public realm.

Economically, the new Assembly was conceived as an impetus for a broader program of urban ambition in Cardiff, which despite its status as the Welsh capital is better known as a rough-around-the-edges port city. Poised on a pierhead and surrounded by disused docklands, the building is a crucial catalyst for the redevelopment of Cardiff Bay, an area blighted by the collapse of heavy industries such as coal and shipping. Architecturally, the stakes were high with the commissioning of Richard Rogers, who prevailed in a limited competition by creating a physical and symbolic embodiment of Welsh nationhood and modern democratic government. Yet local reaction to the visions of high-profile architects has not always been favorable. During the 1990s, Zaha Hadid's aborted proposal for the Welsh Opera House on a nearby site on Cardiff Bay proved a bitter triumph of petty provincialism over architectural invention. Doubtless mindful of Hadid's experience, Rogers treaded carefully, but even so, costs rose from an original budget of £27 million (\$49 million) to a final £67 (\$121.5 million), leading to design changes and a baffling procurement saga that involved Rogers being sacked from the project and subsequently reinstated.

Compared to the overwrought Scottish Parliament [RECORD, February 2005, page 98] by the late Catalan magus Enric Miralles and his widow Benedetta Tagliabue, the Welsh Assembly is a simpler, more legible urban proposition. Transparency and physical openness were key tenets of the building's program and were decisively resolved in the form of a glazed pavilion set on a massive plinth clad in dark Welsh slate. Sunk into the dense, geological plinth is a subterranean debating chamber illuminated by an

Catherine Slessor is the managing editor of *Architectural Review* in London.

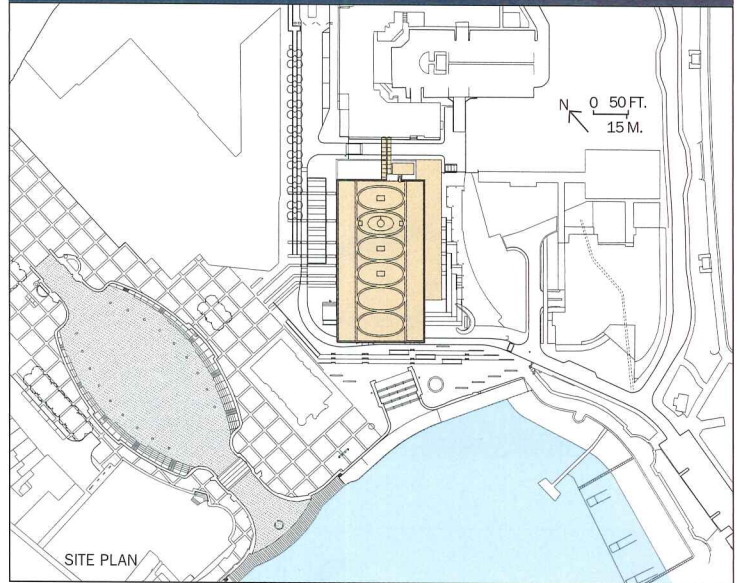
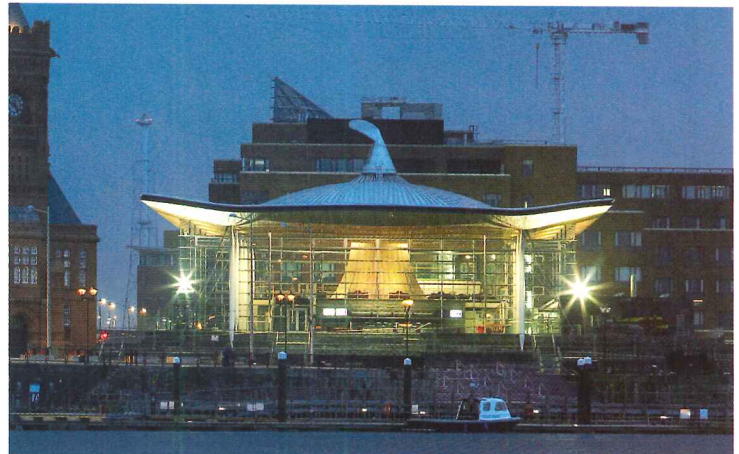

immense conical funnel that tapers up through the glazed pavilion to pierce a hovering roof plane. Ripping and swelling like a shaken carpet, the contoured underside of the roof is lined with thin strips of untreated red cedar. Slender steel columns support the undulating roof as it extends beyond the Miesian glass box to form a dignified and welcoming colonnade.

The composition reflects the strong public/political duality of the building's internal organization. The politicians' domain, a hermetic

Project: National Assembly for Wales, Cardiff, Wales

Architect: Richard Rogers

Partnership—Richard Rogers, principal; Ivan Harbour, project director;

John Lowe, project architect

Engineer: Arup (structural, wind)

Consultants: BDSP (environmental); Gillespies (landscape)

General contractor: Taylor Woodrow

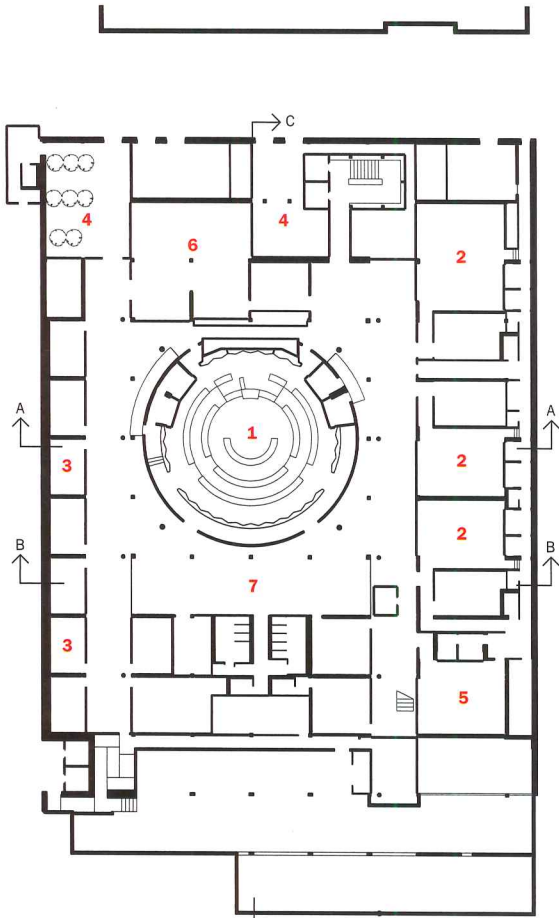

MAIN FLOOR

N 0 30 FT.
9 M.

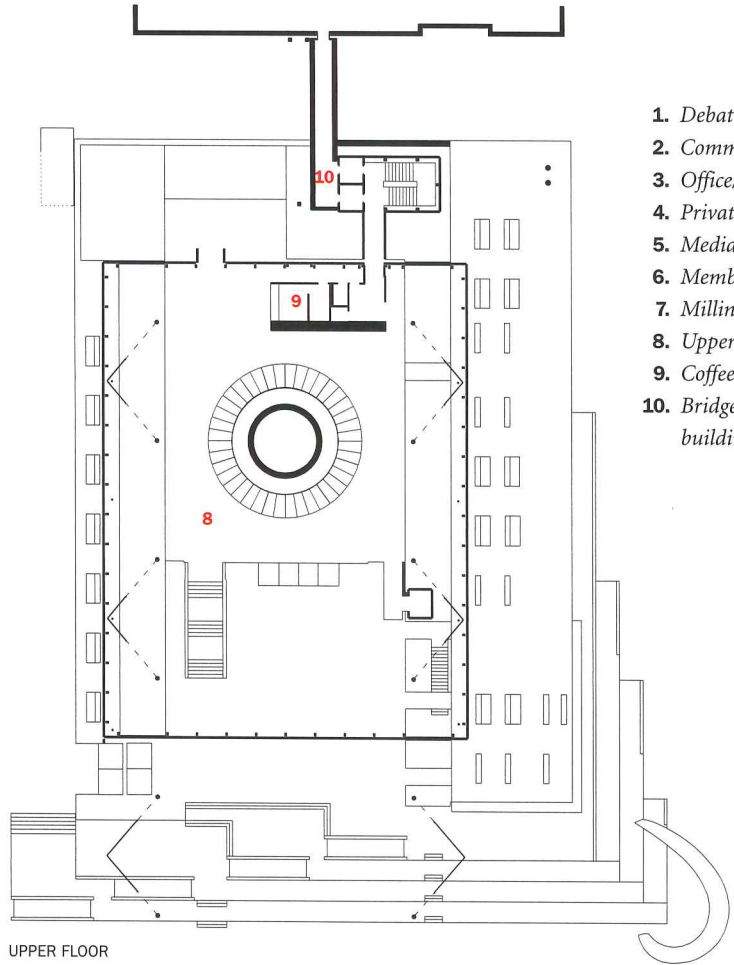

UPPER FLOOR

1. Debating chamber
2. Committee room
3. Office/meeting room
4. Private courtyard
5. Media briefing room
6. Members tea room
7. Milling space
8. Upper foyer
9. Coffee shop
10. Bridge to existing building

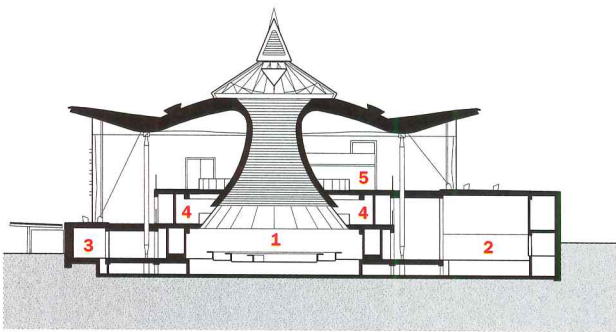

SECTION A-A

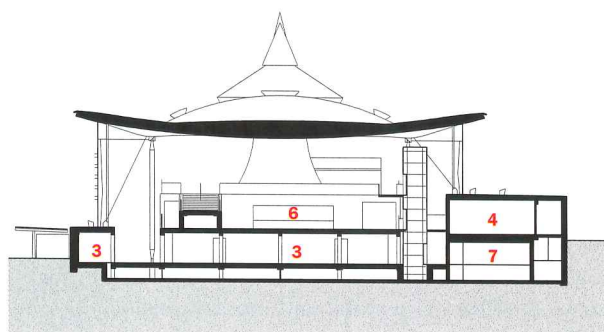

SECTION B-B

Two of the building's three floors are open to the public. An existing structure behind the assembly provides administrative and office space and is connected to the new building by a bridge on the upper level.

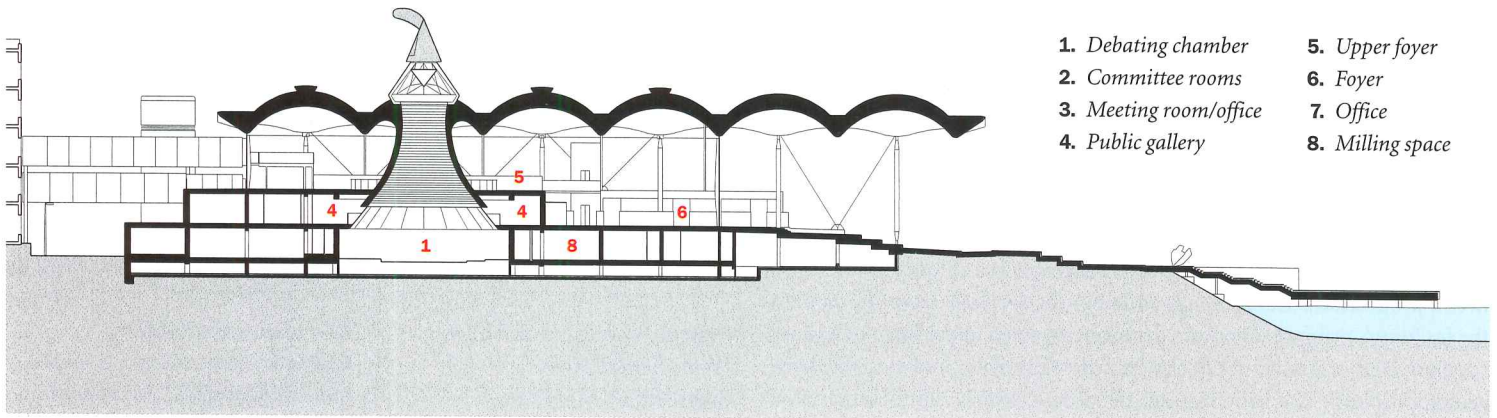

SECTION C-C

1. Debating chamber
2. Committee rooms
3. Meeting room/office
4. Public gallery
5. Upper foyer
6. Foyer
7. Office
8. Milling space

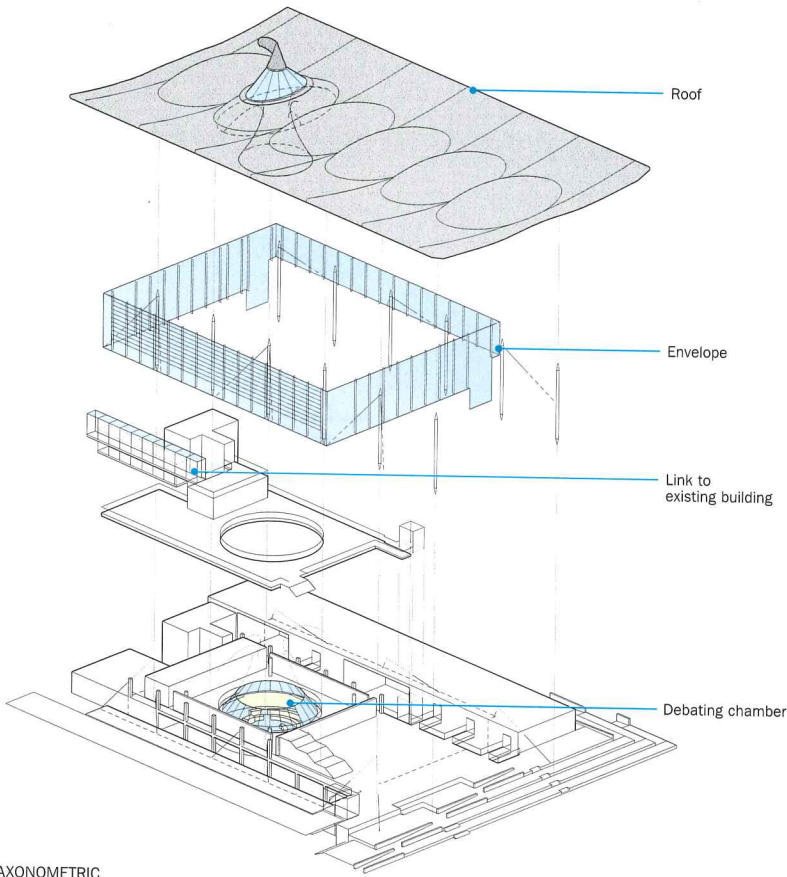

AXONOMETRIC



underground labyrinth of debating chamber, press facilities, and meeting and committee rooms, is placed underneath the plinth, while the lighter, more open public spaces are elevated above it. In effect, the shimmering, glazed pavilion becomes a kind of civilized urban living room, where the public is at liberty to wander, once the obligatory airport-style security has been negotiated. Here visitors can savor the views across Cardiff Bay, hang out in a café, take in impromptu music or theater performances, or watch televised relays of the more serious proceedings in the chamber below. Sculptural Arne Jacobsen seating adds a touch of Scandinavian elegance.

Dark slate creates a plinth for the glass pavilion to sit on (above right) and is brought inside the building for flooring in the main public areas (right). Welsh oak appears on much of the furniture and fittings.

In a riposte to the Westminster parliament, which encourages confrontation through its historic arrangement of opposing banks of seating, the circular form of the Welsh debating chamber is consciously anti-adversarial. The 60 seats are arrayed concentrically, with more senior cabinet members occupying the innermost circle. A public gallery with high-backed, pewlike seats overlooks the chamber, giving it the intimate appeal of a theater-in-the-round. Post 9/11, the original aim of making this space a single, fluid entity was regrettably but understandably modified, so now politicians are physically separated from the public by an angled screen of toughened glass. Other enhanced security measures include blast resistance in the glazed walls, cunningly and seamlessly incorporated in a series of lateral restraining ties.

Daylight infiltrates the debating chamber through the apex of the great conical funnel, aided by an array of reflective tubes and mirrors. Originally the building was to have three such protrusions, but requirements changed. The lone funnel now emphatically signals the presence of





The reception area and the upper foyer around the wood-clad funnel encourage the public to come inside, relax, even enjoy a cup of tea.

WHAT MAKES THIS BUILDING GREEN?

- Extensive use of daylighting in public spaces.
- Reflective tubes and mirrors bring daylight into the debating chamber in the basement.
- Air is cooled by drawing it into a plenum at the base of the building, then distributed through the space.
- Natural ventilation.
- Wind cowl on top of conical funnel harnesses wind for ventilation.
- Geothermal heat-exchange via 30 boreholes 330 feet deep.

wind cowl (the largest in Europe), which tracks and harnesses the wind to ventilate the chamber. This principle is a modern interpretation of the traditional oast house where a cowl is employed to draw air through hop-drying kilns. And for guides showing parties around the building, associating politicians with hot air offers limitless quip potential.

The assembly also has a geothermal heat-exchange system, comprising 30 boreholes drilled 330 feet deep into the ground. Refrigerant is

the underground chamber, and also plays a key role in the building's environmental control strategy. Issues of environmental impact and sustainability were identified as significant at the competition stage and the Rogers team responded with a design that relies mostly on natural ventilation, with the building's concrete frame and slate plinth contributing thermal mass. Air is drawn into a large plenum at the base of the building and into the committee rooms and out through vents in the ceiling skylights. The great funnel of the debating hall is capped by a 20-foot-tall rotating

pumped into the boreholes and through a heat exchanger. In summer, cool air extracted from the earth supplements natural ventilation. As the ground around the holes progressively warms up over the hot season, the system can be used in reverse during winter months to heat the building. A conventional cooling plant kicks into action only on very hot days (rare in wet, windy Cardiff), and a woodchip boiler provides an extra boost in winter's chill. More general issues of sustainability involved the specification of local materials to reduce transport and energy costs, such as Penryn slate and Welsh oak.

The new Assembly synthesizes issues of literal and metaphorical transparency, structural ingenuity, and environmental consciousness into a dignified yet accessible expression of the role of politics and government in a modern society. It makes no bombastic nationalistic statement, yet clearly and lyrically celebrates Wales. Hopefully the quality of the politics will live up to the quality of the architecture. ■

Sources

Glazing: Haran Glass

Roofing: Lakesmere

Glazing for elevator shaft: Astec Projects

Outdoor stone paving: Marbrerie Allard & Fils

Boardwalk: Dean & Dyball

Ventilation cowl/inverted mirror cone in debating chamber: Vision

Lighting: Whitecroft Lighting

Movable furniture: Attic 2

For more information on this project, go to Projects at

www.archrecord.com.



Originally, the debating chamber and the public gallery were to be one, fluid space. But after 9/11, security concerns forced changes, including separating the two areas with glass.



Randy Brown Architects

Product: High Flex® Wallboard Project: Bizarre Boutique
Category: Specialty Location: Omaha, Nebraska

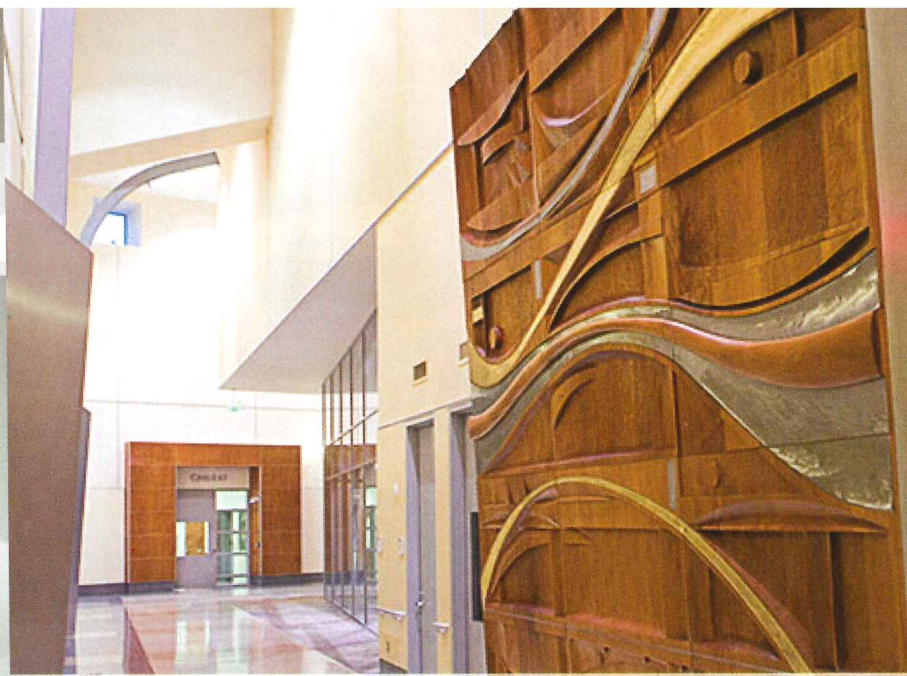

Koonce Pfeiffer Bettis, Inc.

Product: Hi-Impact® XP® Wallboard Project: Alaska Psychiatric Institute
Category: Institutional Location: Anchorage, Alaska



KKE Architects, Inc.

Product: Hi-Impact® XP® Wallboard Project: Hassan Elementary School
Category: Educational Location: Rogers, Minnesota

Wall-to-Wall Inspiration

Congratulations to the 2006 Rock Award Winners.

As these designs reflect, the potential of National Gypsum's specialty wallboard products is limited only by the minds that put them to use. We salute all firms who not only use our walls, but raise the bar in doing so.

THE
ROCK AWARD

Presented by National Gypsum

CIRCLE 39 ON READER SERVICE CARD OR GO
TO ARCHRECORD.CONSTRUCTION.COM/PRODUCTS/

PERFORMING ARTS

Building Ovations

For all the stories of struggling orchestras and embattled theater troupes, halls that offer a superior audience experience are drawing wide community support.



GUTHRIE THEATER

Minneapolis, Minnesota

In this famed theater's new home, Jean Nouvel layers evocative imagery, theatrical lighting, and dramatic formmaking to help audiences enter the actors' world.



LUXEMBOURG PHILHARMONIE

Luxembourg City, Luxembourg

Christian de Portzamparc animates a monumental setting with the lively spatial dynamism and acoustic excellence of a grand concert venue designed to serve a wide range of music.



HOLLAND PERFORMING ARTS

Omaha, Nebraska

A transparent, lanternlike lobby invites the public to experience Omaha's new arts center, with its luminous auditorium, by HDR in collaboration with Polshek Partnership Architects.

By James S. Russell, AIA

New theaters bring viewers as close as possible to the art being created onstage, whether by actors, musicians, or singers. In an iPod and video-on-demand age, excellent sight lines and superior acoustics are requirements, not luxuries.

In Minneapolis, Ateliers Jean Nouvel (with Architectural Alliance) enhanced the thrust-stage design on which the Guthrie Theater built its national reputation, while adding a proscenium theater calibrated to draw audiences deeply into the psychological intensity that is the bedrock of modern theater. The classic shoe-box shape of the Luxembourg Philharmonie can deliver full, rich sound, but Christian de Portzamparc overcame the configuration's shortcoming—a lack of visual intimacy—by wrapping towers of seating around the orchestra seats and the stage. Omaha may not be a large city, but it aspires to boost both musical and civic life with an elegant orchestral space (by the Polshek Partnership collaborating with locally headquartered HDR) in its Holland Performing Arts Center.

It's no secret that performing-arts facilities are seen as economic-development tools, even in Europe, where the Philharmonie is supposed to spice up a city rather too devoted to the Eurocrat banquet. In recent years, performing arts have become more widely recognized as expressions of urban vitality and civic achievement—qualities more valuable than tourists per seat.

But that also means that these structures take a place much more central to civic life, symbolized boldly in Minneapolis by the “endless bridge” that spectacularly unites the introverted nature of theater with panoramas of the city and the Mississippi River. The Guthrie shares its theatrical use of color with de Portzamparc's Philharmonie, a glowing lantern by night that enlivens the dour facades of the pan-European institutions that surround it. The Holland Center eschews architectural fireworks, yet opens the rich life within to the increasingly lively streets of downtown Omaha.

Major facilities designed for enhanced audience expectations are opening all over North America. The Four Seasons Center for the Performing arts, by Diamond & Schmitt, opened last June in Toronto. This fall brings the completion of the Schermerhorn Symphony Center, in Nashville (David Schwartz, architect), and two venues by Cesar Pelli: the Performing Arts Center of Greater Miami and Segerstrom Hall in the Orange County Performing Arts Center, in Costa Mesa, California. Given such wide community support, the future of art created by real people in front of real audiences looks rosy indeed. ■

For more information on these projects, go to Building Types Study at www.archrecord.com.

One: GUTHRIE THEATER

Minneapolis, Minnesota

Ateliers Jean Nouvel prepares audiences for the artifice of drama with ghostly imagery, bold colors, and bravura form.

By James S. Russell, AIA

Architect: *Ateliers Jean Nouvel*—Jean Nouvel, Bertram Beissel, Brigitte Metra, Vincent LaPlante, Nathalie Sasso, Eric Stephanie, Anna Ugolini, Damien Faraut, Michel Calzada, Athina Faraut, Edwin Herkens

Architect of record: *Architectural Alliance*—Tom DeAngelo, FAIA, Bob Zakaras, AIA, Scott Sorenson, Ken Sheehan, AIA, Ross Naylor, Assoc. AIA, Jim Mornes, AIA, Jeff Loeschen, Assoc. AIA, Aaron Mullins

Client: *The Guthrie Theater*

Engineers: *Ericksen Roed & Associates (structural); Michaud Cooley Erickson (m/e)*

Consultants: *Fisher Dachs Associates (theater); L'Observatoire International (lighting); The Talaske Group, Kahle Acoustics (acoustics)*

Size: 285,000 square feet

Cost: \$125 million

Completion date: June 2006

Sources

Aluminum sandwich panel: *Centria*

Paint on panel: *Valspar*

Glass: *ISG; Viracon; Rochester Glass; Oldcastle Glass*

Exterior graphics: *Artistic Screening*

Doors: *Jamison Door Company; Skyfold Autolift Wall Systems; Won-Door Corporation; Total Door; Electir Power Door; Schweiss Bi-Fold Doors*

For more information on this project, go to Building Types Study at www.archrecord.com.

The bladelike form that projects 178 feet from the shimmering, midnight-blue bulk of the Guthrie Theater sums up everything willfully idiosyncratic yet keenly intuited about Jean Nouvel's design. What he calls "the endless bridge" extends a two-story lobby inside, offering a sublime connection between Minneapolis's downtown and the long-isolated banks of the Mississippi River. That attention-grabbing form will certainly become iconic, but the dreamlike procession Nouvel built inside almost subconsciously prepares patrons for the unique "reality" of dramatic artifice.

In making a presence that is urban, yet architecturally and theatrically evocative, Jean Nouvel (with Minneapolis-based firm Architectural Alliance) realizes the expansive vision of Joe Dowling, the Guthrie's artistic director. He speaks of the \$125 million building that opened in June as "an artistic, architectural, and economic force on the banks of the Mississippi."

Program

Dowling wanted to reproduce the thrust stage that had become the theater's signature. The stage, pioneered by legendary director Tyrone Guthrie, who founded the theater in 1963, juts into the audience bowl with an asymmetrical platform, creating a uniquely involving and intimate, in-the-round experience. (Guthrie worked with renowned local architect

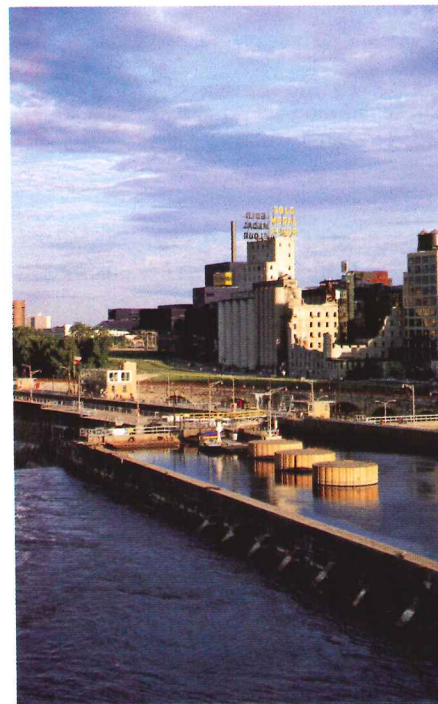

Ralph Rapson. The much-altered original will be torn down.) Dowling added a conventional proscenium theater, which the Guthrie had never had. Its distinct division between audience and players would "get beyond the limitations of the thrust stage," he said in an interview. Those limitations include props that can block views, and the necessity for actors to constantly move around to include the audience on all sides. The new structure also brings to the Guthrie a home-based black-box studio. With its expanded learning spaces, Dowling sees the new Guthrie as not just one of America's

PHOTOGRAPHY: © ROLAND HALBE



The Guthrie's industrial image draws from preserved mill buildings (opposite). The "endless bridge" brings Guthrie patrons to the edge of the river. Nouvel layers playwright's faces on billboards (below) and stage scenes on the blue panels (right). Actors' images appear on rooftop zipper signs.



The zipper signs, visible from afar (right), evoke smokestacks, a sly reference to the “industry” of culture. The apsidal form (below) conforms to the shape of the thrust hall within. Patrons enter under a bridge that connects to set shops before proceeding to the lobby, located on the fourth floor.

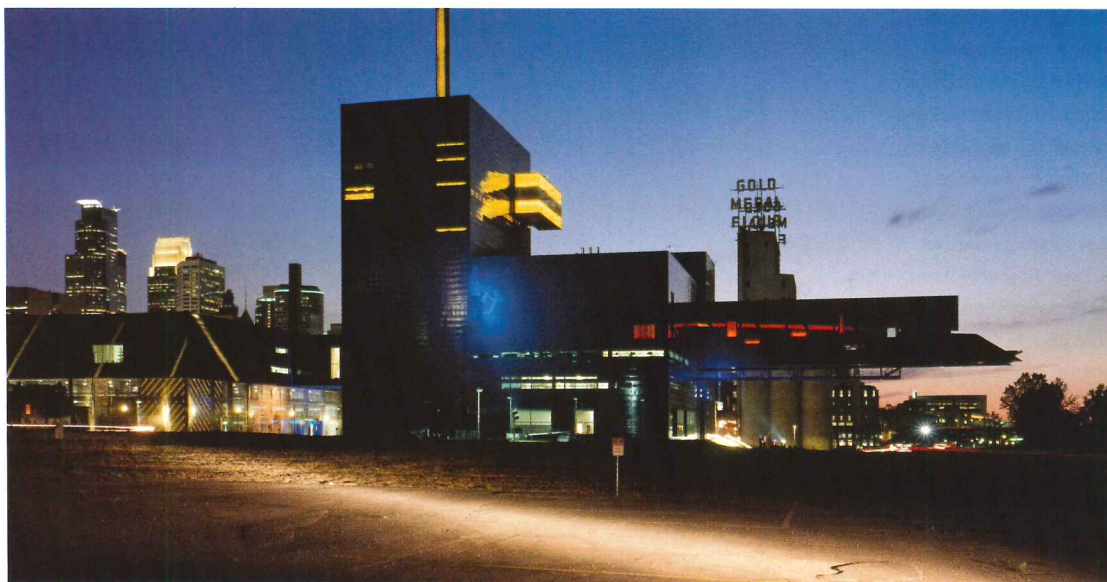

premier regional theaters, but “a national center for theater arts and theater education.”

Solution

Paris-based Ateliers Jean Nouvel was selected for its first American building largely because Dowling was impressed by Nouvel’s well-regarded concert hall in Lucerne, Switzerland, and an opera house in Lyons, France. Though the theater had obtained a 900-foot-long site, Nouvel shocked Dowling by proposing to mound up the 285,000-square-foot building to a 10-story height at the site’s western end. (The unused land will become a park.) The building’s form exudes a barely contained energy, like an early-20th-century factory by Eric Mendelsohn. Scudding across its shimmering facade, by contrast, are what seem at first reflections. They coalesce into ghostly images screen-printed onto the surface: scenes from *Hamlet* or *Of Mice and Men*. The haunting images evoke the Guthrie’s distinguished history and future ambitions: The building’s industrial forms extend a 12-story-high skyline formed by an adjacent grain silo and flour mills—monumental relics of the city’s past that have been adapted as condominiums, the Mill City Museum [RECORD, February 2004, page 122], and a park of industrial archaeology.

Nouvel added bold color: the deep blue aluminum panels, in contrast to the butter-tinted, lanternlike block that clings improbably to the building (the studio-theater lobby). He layers the images and colors atop the assertive architectural formmaking—not attempting to reconcile them to each other.

Nouvel proposed his most bravura gesture, the cantilevered lobby bridge, “to touch the Mississippi River.” It links the most architecturally introverted of art forms to a panorama of the Mississippi and the city beyond. Because it is elevated, the bridge/lobby inevitably required that the two main-stage theaters it serves be located 50 feet above the street. The idea “raised eyebrows,” dryly observed Thomas DeAngelo, FAIA, principal with

The endless bridge hangs over the riverbanks (below) offering a sublime panorama of the city and the vast midwestern horizon. In good weather, the bridge opens to a tiny terrace (right).

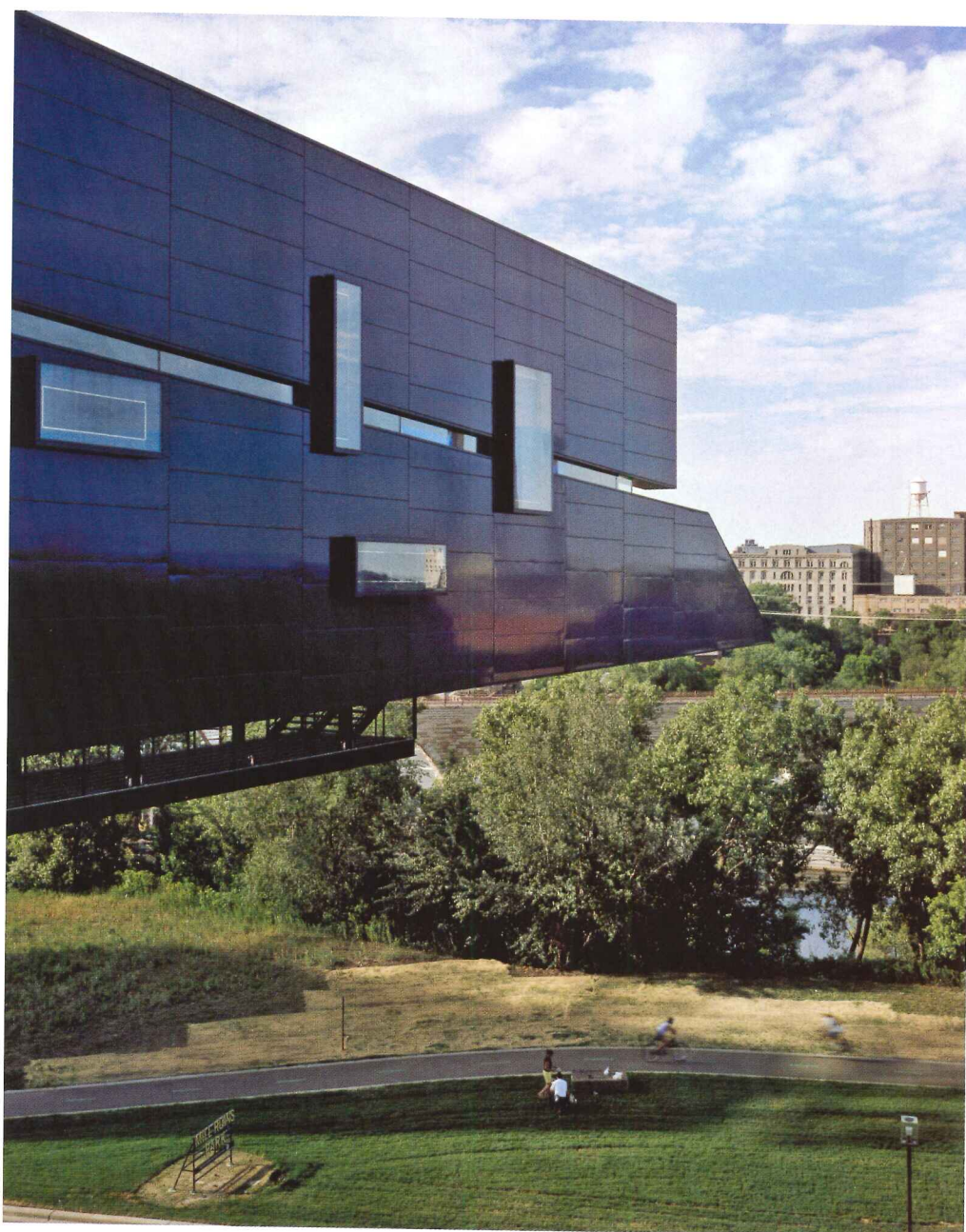
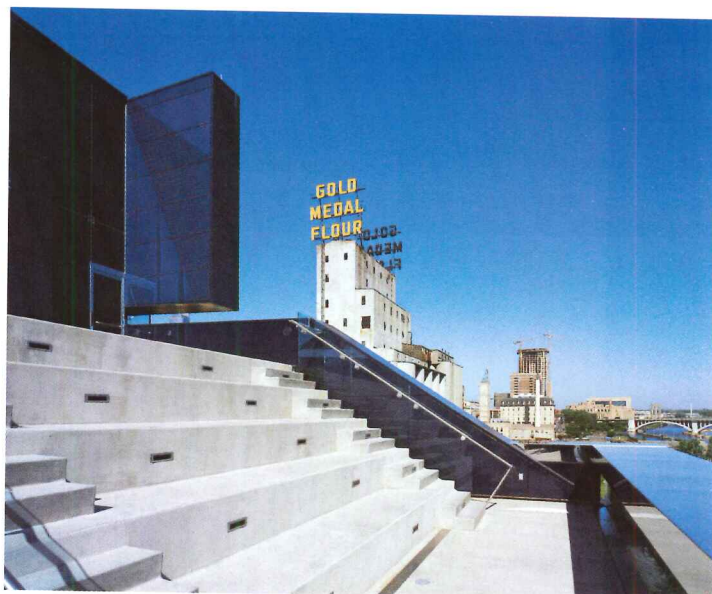

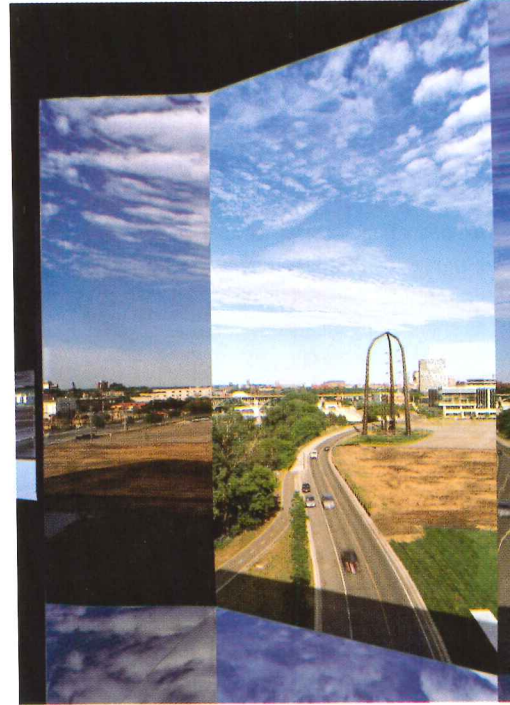

Images from past productions scud across walls and ceilings of the ground-floor lobby (left). The upper lobby bridge teases the senses with windows lined in reflective metal that fragment the view (top right). The bridge ends in a plane of blue glass (top left) that Nouvel says “lures you through” to a tiny set of outdoor steps (prior page, top photo).

From the fourth-level lobby (below, with blue glass opening to ghostly views of the set-shop bridge), a switchback ramp in the endless bridge rises to the fifth-level lobby (right, with blue-glass opening to an urban panorama). Glowing semicircular openings link bars and a restaurant on the two levels.



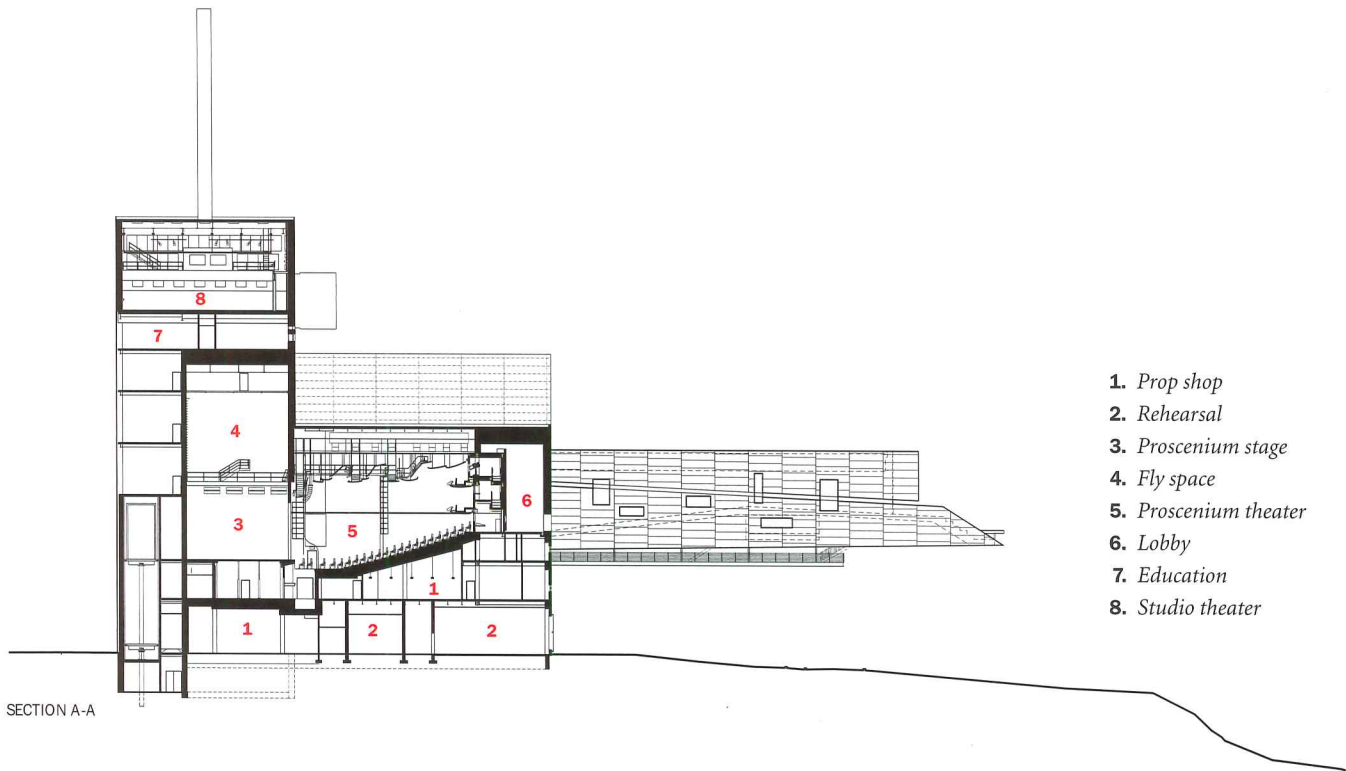

- 1. Prop shop
- 2. Rehearsal
- 3. Proscenium stage
- 4. Fly space
- 5. Proscenium theater
- 6. Lobby
- 7. Education
- 8. Studio theater

SECTION A-A

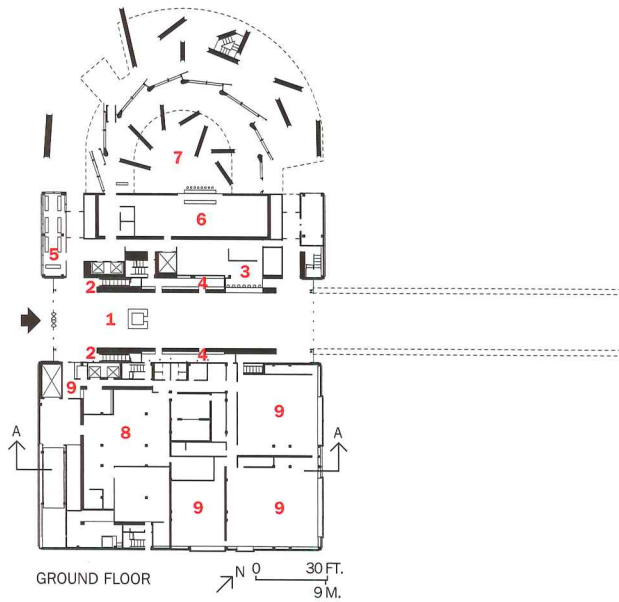

- 1. Ground-floor lobby
- 2. Escalators
- 3. Ticketing
- 4. Coats
- 5. Shop
- 6. Kitchen
- 7. Restaurant
- 8. Props
- 9. Rehearsal
- 10. Theater lobby
- 11. "Endless bridge"
- 12. Thrust lobby
- 13. Thrust auditorium
- 14. Stage
- 15. Proscenium lobby
- 16. Proscenium auditorium
- 17. Link to set shops
- 18. Elevator to studio theater
- 19. Restaurant
- 20. Bar
- 21. Terrace
- 22. Upper lobby
- 23. Balcony access
- 24. Control booth

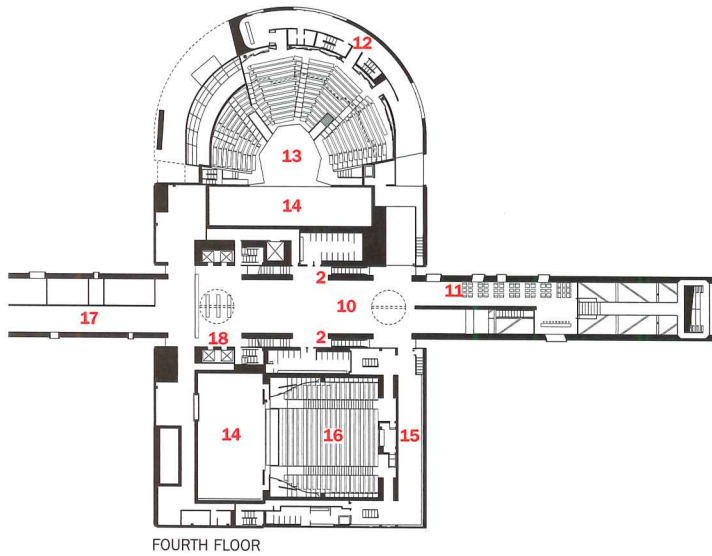

FOURTH FLOOR

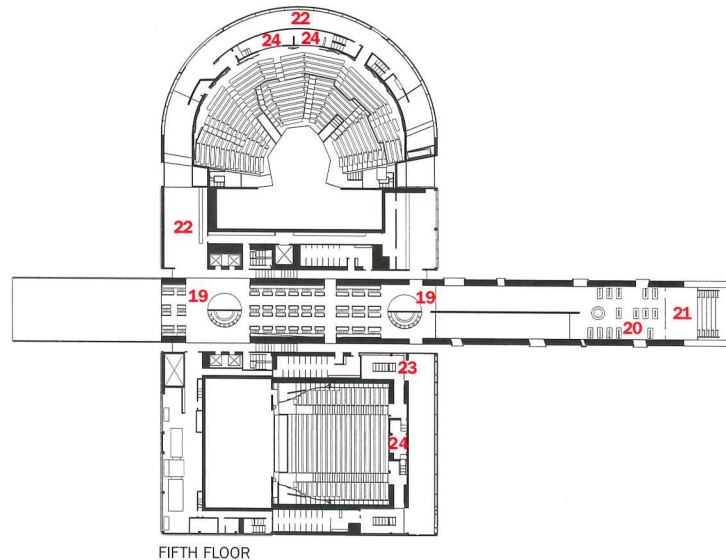

FIFTH FLOOR

Architectural Alliance, the project's architect of record. "You not only have to get sets and equipment up and down, but you have to get people up and down, both for performances and for emergency exiting."

The Guthrie endorsed the theater-in-the-air idea, especially once the design team moved the scene shops to a parking structure across the street. They connect at stage level through an enclosed bridge. (Production and rehearsal spaces fill the levels below the main stages.)

By framing the building in steel, large trusses could span the auditoriums as well as suspend ceilings and technical catwalks. Each auditorium is structurally separated for sound isolation. The outer surfaces of the endless bridge frame a three-dimensional steel truss that counterbalances the bridge's weight by extending the full depth of the building. Braced columns anchor the truss to bell-shaped concrete caissons poured into solid rock.

Nouvel favors interiors cast into nightclub gloom, but he orchestrates contrasts of shadow, light, and color with all the skill of a stage-production designer. The tall ground-floor ticketing lobby—in glass and austere grays—leads up theatrically lit, shaftlike escalators to the fourth-level lobby that opens onto the endless bridge. Nouvel unveils its views kaleidoscopically through long slit windows and big square openings. One window opens, admitting breezes and the roar of the Saint Anthony Falls. A plane of blue glass at the bridge end tints the panorama beyond like a two-tone etching. Beyond, the floor plane drops away as a miniature stepped, open-air amphitheater that hangs high over the riverbanks.

These visual effects don't have anything to do with the reason people come to the Guthrie, but they have an architectural theatricality that Nouvel has long explored, especially in the luscious surface of the Agbar Tower [RECORD, January 2006, page 88]. These effects subtly act on the senses, stimulating patrons for the experience to come, augmented by more stage-scene images that float

The scalloped ceiling (below) and the narrow balconies that perch at the back of the cubic proscenium auditorium (right) were shaped to aid sight lines and acoustics. (Unlike many stages today, Guthrie productions are not amplified.)

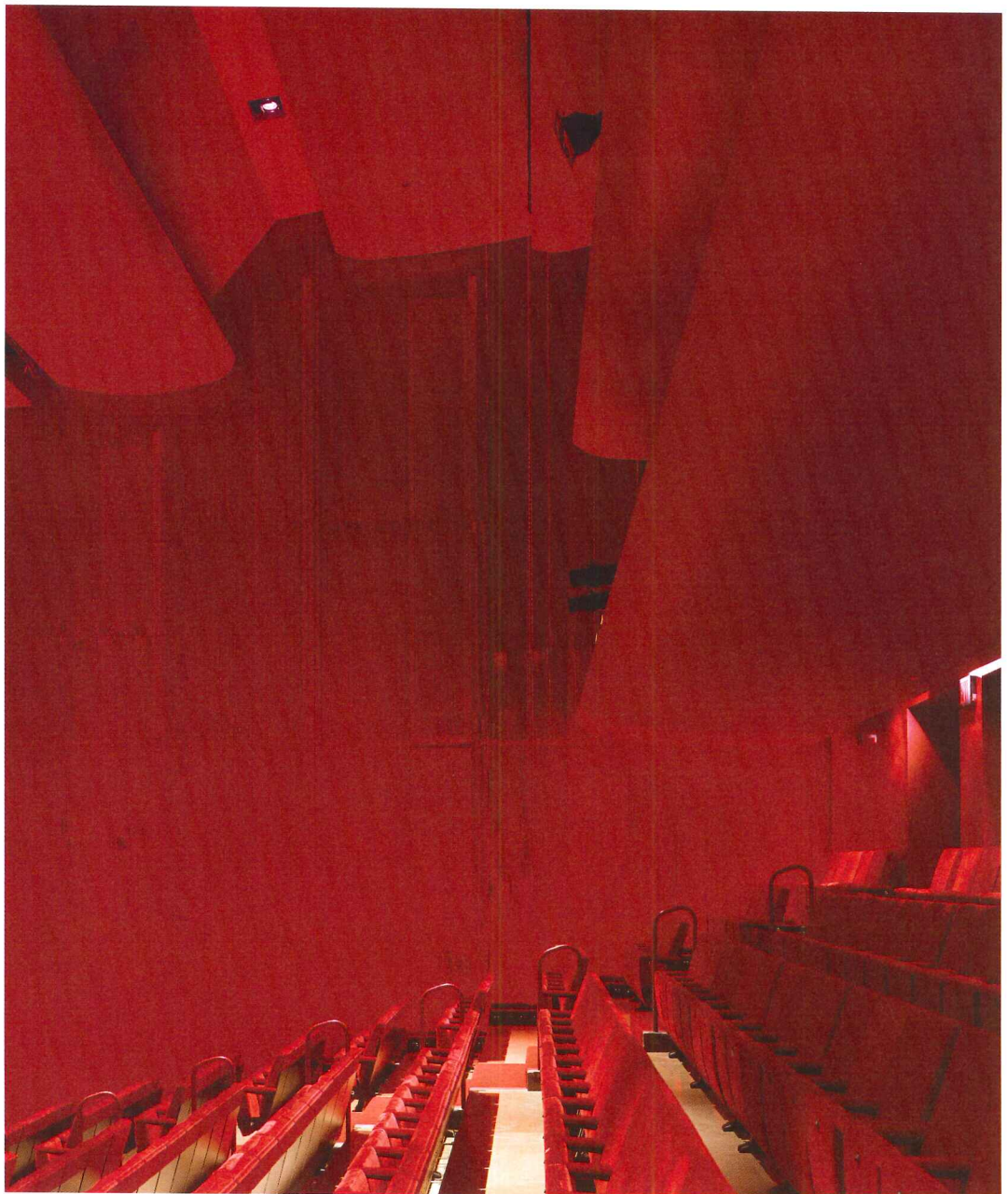
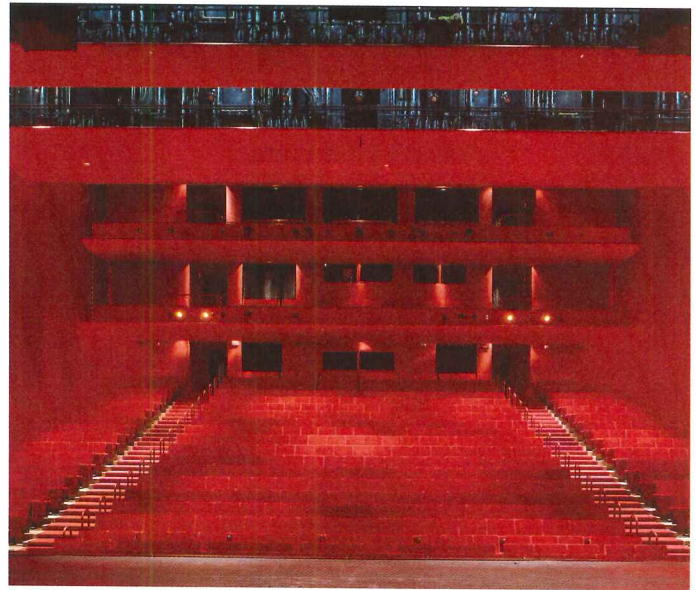



into view across walls and ceilings, what Nouvel calls “the souls of a lot of people from the beyond.”

In the 700-seat McGuire proscenium stage, Nouvel unleashes a more conventional theatricality by bathing the room in red light, including the veils of shining metal mesh that line the walls. The straight rows of seats serve Dowling’s vision: “The great 20th-century works of psychological realism, like those of Arthur Miller or Eugene O’Neill, demand to be seen by everyone in the theater in exactly the same way,” he explained, “as if no other audience members were present.” The design team has essentially replicated the old Guthrie’s famous thrust stage in the new Wurtele Theater while subtly altering it to improve acoustics and technical flexibility. At 1,100 seats, it holds 198 fewer patrons than its predecessor, a concession to comfort and sight lines. Atop eighth-floor classrooms, Nouvel has mounted the 200-seat Dowling Studio Theater. Its lantern-like lobby, sheathed in yellow-tinted glass, feels like a jaw-dropping but vertigo-inducing aerie. A wide, upward-folding door can unite the studio with its lobby, which, crisscrossed by beams of yellow-tinted light, puts one in mind of Caravaggio.

Commentary

At first viewing, the willful idiosyncrasy of this design shocks. Is the bravura bridge sublime or a tourist-brochure stunt? The evocative use of images and the theatrical effects of lighting, color, and surface seem drawn from some separate conception. This building is utterly intuitive (Nouvel says he chose the red to match the infrared color he saw in a computer mouse, for example). It is neither tidily conceptualized nor systematic. Its variety of effects may take some getting used to, but it will likely win over audiences because Nouvel understands—in his heart, perhaps, rather than in his head—the nature of theatergoing. The architecture does help people enter the world conjured by actors: one of dreams, hopes, and memories, in which each evening is unique and evanescent. ■

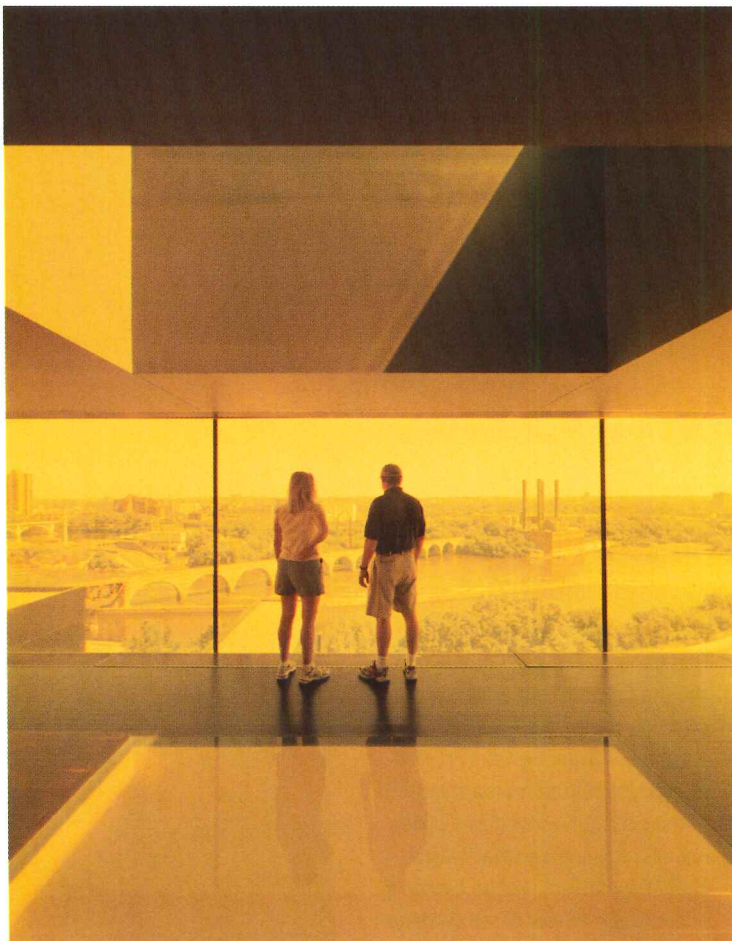

The colors and configuration of the thrust theater (opposite) were largely replicated from the Guthrie’s first home. A wide doorway links the studio theater (bottom) to a lobby bathed in light from tinted glass (left). Augmenting the floor-to-ceiling glazing is a skylight and glass floor.



Two: LUXEMBOURG PHILHARMONIE

Luxembourg City, Luxembourg

Christian de Portzamparc animates a monumental plaza with a spatial dynamism that takes its sophisticated urbanism inside.

By Joseph Giovannini

Architect: Christian de Portzamparc Studio—Christian de Portzamparc, François Barberot, Wilfrid Bellecour, Jean-Charles Chaulet, Urban Stirnberg, Pierre Van den Berg, Alexi Lorch, Céline Barda, Christophe Echapasse, Odile Pornin, Duccio Cardelli, Rémi Oliel, Constantin Dölher, Burkhardt Schiller, Frédéric Binet, Jean-Daniel Boyé, Mathieu Faliu

Executive architect: Christian Bauer & associés

Client: Grand Duchy of Luxembourg

Engineers: Gehl Jacoby & Associates, SETEC (structural); S&E Consult, SETEC (plumbing); Felgen & Associés (electrical)

Consultants: Xu-Acoustique (acoustics); L'Observatoire 1 (lighting)

Size: 215,000 square feet

Cost: Withheld

Completion date: June 2005

Sources

Metal panels: Reynobond

Auditorium acoustical reflectors: Glass-reinforced gypsum

Sound-absorbing wood panels: Topakustik

Furnishings: Matteo Grassi; Arne Jacobsen

For more information on this project, go to Building Types Study at www.archrecord.com.

French architect Christian de Portzamparc won the competition for the the Luxembourg Philharmonie—officially, the Grande-Duchesse Josephine-Charlotte Concert Hall—by recognizing the monumentalism of the setting he was given while imbuing this concert hall with a spatial dynamism. As the capital of a founding member of the European Union, Luxembourg City has become host to many of its institutions, including the European Court of Justice. Over the past 20 years, a modern bureaucratic acropolis has risen on the Kirchberg Plateau, across the valley from the old, walled city. With political and economic success, however, the country has turned to developing a cultural infrastructure commensurate with its new status.

Program

A 1997 competition sought an urban centerpiece for the triangular Place de l'Europe, bounded by monumental glass governmental structures. The brief called for a 1,500-seat concert auditorium, a 300-seat chamber-music hall, and a black-box theater seating 120. Along with acoustic excellence for concerts ranging from symphonic music to amplified jazz, the tacit expectation was that the structure

Joseph Giovannini is a critic and principal of Giovannini Associates based in Los Angeles and New York City.



rise to its ceremonial function as a crowning symbol of the new, sophisticated Luxembourg City. The concert hall also had to address the plateau's main thoroughfare and ceremonial boulevard, Avenue John F. Kennedy.

Solution

De Portzamparc conceived a densely colonnaded monument, elliptical in plan, with 823 tall, closely spaced steel columns at the perimeter supporting a thin, radius-edged roof. At the front prow of the ellipse, de Portzamparc widens the spacing between columns to accommodate the entrance that runs parallel to Avenue Kennedy. Two shells clad in metal panels rise on either side of the main structure. The tangential curve of one appears to launch visitors arriving from underground parking into the peri-

style. The other arcs up as the carapace of the chamber-music hall.

In ranges of three and four deep, the closely grouped columns fall in and out of alignment as audience members approach, like trees in a park, shifting the perception of the building between transparency and opacity. The first, interior layer of columns accommodates ventilation and electrical ducts; second-row columns act as structural mullions between windows; the outer layers support the roof.

Inside, a soaring peristyle hall circles the main auditorium, which reads as a building within the building. Tall, prismatic masses form the hall's "facade," reflecting the angular arrangement of seating towers within. The architect, working with acoustician Albert Yaying Xu of the Paris firm Xu-Acoustique, configured the

At night, digitally mixed colors turn the elliptical temple of the Philharmonie, set on its triangular plaza (opposite), into a chromatic lantern (right). The plaza arcs up to roof a chamber-music hall. The layers of columns open up at the Avenue Kennedy entrance (below).

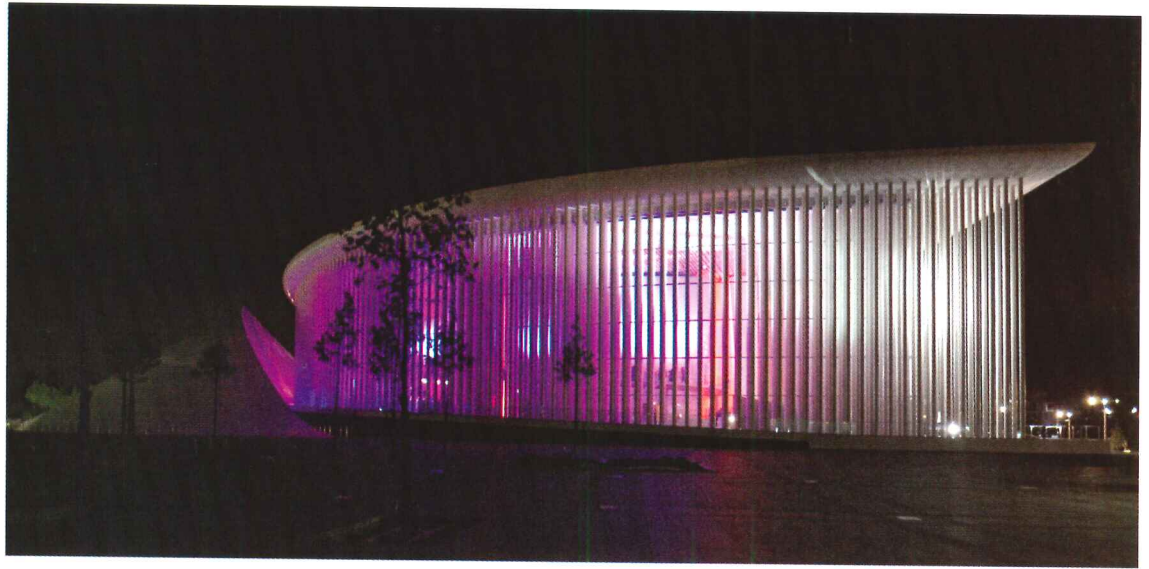

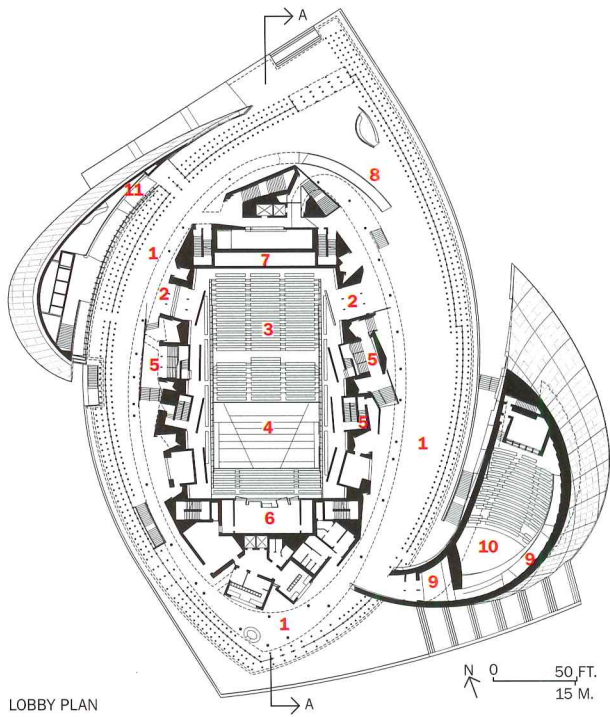

LOBBY PLAN

50 FT.
15 M.

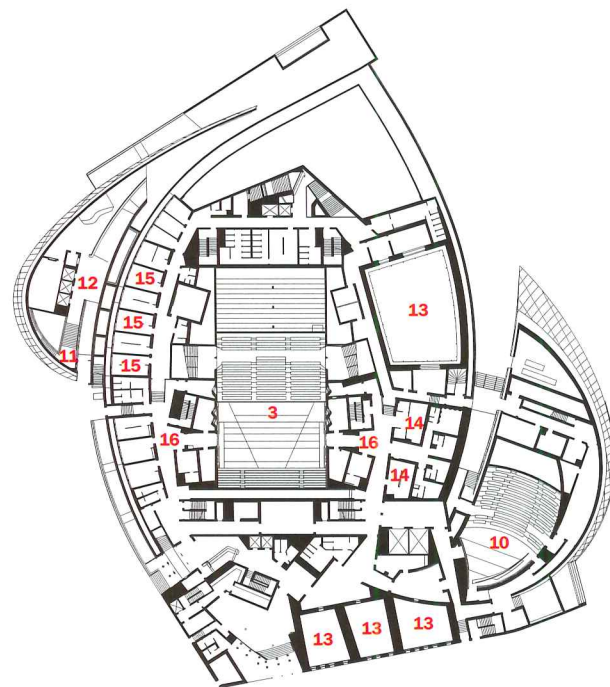

STAGE LEVEL

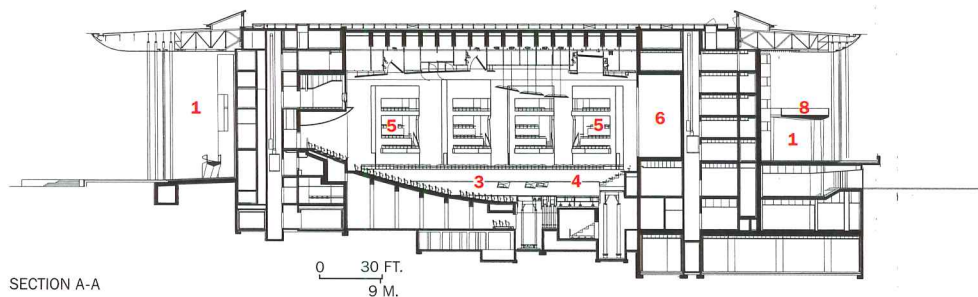

SECTION A-A

30 FT.
9 M.



1. Lobby
2. Access to orchestra
3. Auditorium
4. Stage
5. Seating towers
6. Organ
7. Mechanical
8. Ramp to seating towers
9. Ramp to chamber-music hall
10. Chamber-music hall
11. Access to parking
12. Ticketing
13. Rehearsal (below)
14. Soloist dressing
15. Dressing
16. Stage door

main auditorium as the tried-and-true shoe box (think Boston's Symphony Hall). Above orchestra seats fitted into this rectangle, eight freestanding, four-level seating towers rise, angled forward from the auditorium box and out of plane with each other. Architecturally, the towers evoke town houses overlooking the orchestra-level's village square, creating an intimacy unusual in shoe-box halls, because the performers feel wrapped by the audience.

While the shoe box creates reverberant sound throughout the hall, the shaping of the seating towers diffuses a wide spectrum of sound, especially at low frequencies, just as the heavy decoration of older halls does. Much of the sound listeners receive is reflected from a surface, as in most halls. Because sound tends to arc upward from musical instruments, the highest seats, which are close to the stage, receive sound directly from the players. Stairs within each tower give internal access to its 28 seats. Special curtains increase sound absorption for amplified music, while three sound reflectors hovering over the stage can move to aid sound distribution for a piano recital. Xu has achieved a reverberation time that varies from 2.0 seconds for orchestral music to 1.6 seconds for amplified jazz or pop.

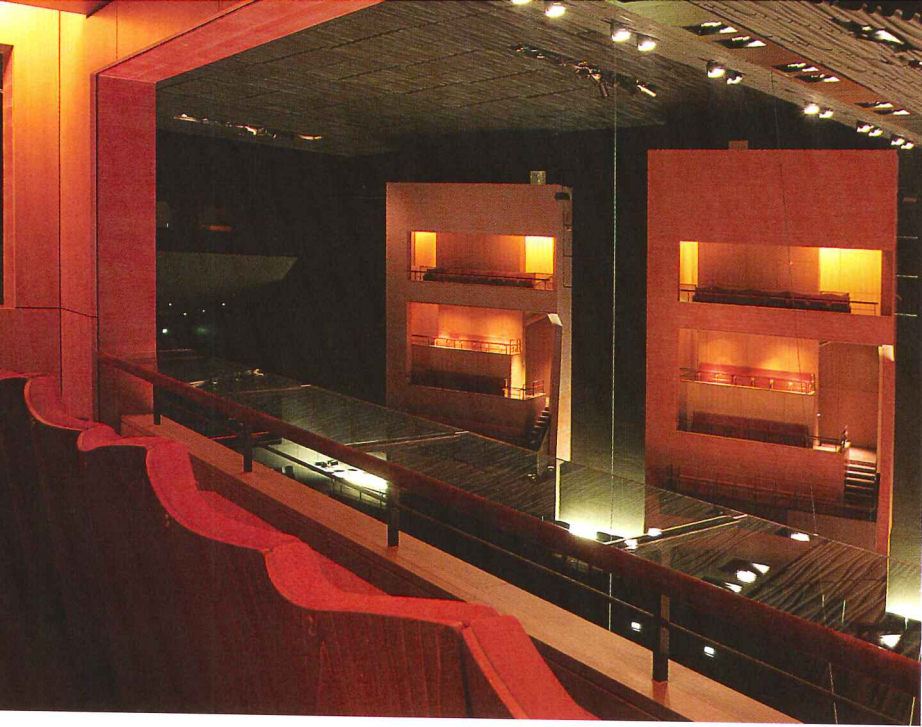

Within the main auditorium's shoe-box envelope, seating towers aid sound diffusion while creating a kind of "village square" in which viewers wrap the orchestra stage (left and opposite). Listeners enter the chamber-music hall (bottom) along a ramp behind the long elliptical form visible behind the stage. The leaflike panel overhead diffuses sound.



Echoing the external ellipse, a ramp delivers concertgoers to the seating towers in the concert hall (below) and to the rear of the orchestra level (opposite, bottom).



A curved corridor leads patrons from the peristyle hall into the chamber-music auditorium, where a roof shell gracefully vaults over an asymmetrical auditorium curved in plan. The shape works because the placement of chamber instruments (and the way they emit sound) tends to asymmetry, according to Xu. De Portzamparc tucked the black-box theater under the auditorium, accessing it from behind the hall with a zigzag of stairs.

Commentary

The colonnaded monument stands autonomously in the square, very much the modern abstraction of a temple. But the relationship of the building to the plaza is not purely one of figure to ground, because the “ground” itself heaves topographically in the organically shaped chamber-music hall and parking entrance. De Portzamparc has kept a clarity by separating the three halls and the parking entrance, while conferring a Platonic purity on the parts.

The architect creates a visual tension by juxtaposing the formality of the lobby colonnade against the chaotic vitality of the fragmented auditorium facade. Beyond their acoustical function, the haphazardly angled towers humanize the hall itself through their “town square” urbanism while seeming both to dilate the box and break it open. Xu has won appreciative comments on the sound from prominent conductors.

Its classicized elements notwithstanding, de Portzamparc’s monument is defined by light rather than mass. The rounded elevations, curving in relationship to other curves, and the shifting parallax that makes the structure seem alternately solid and porous, add a dynamism to the static temple form. Visitors come to understand the building by experiencing it. The chromatic plays of light confer another layer of movement and transformation. Johann Wolfgang von Goethe said that architecture is frozen music, but de Portzamparc has defrosted the architecture so that, like music, it can be experienced in the fourth dimension of time. ■



The tower seating within is echoed in the hall's exterior, crossed by passages leading

to the seats (top). De Portzamparc illuminates the deep crevasses with lights

(below left), and silhouettes the facets into a Cubist composition of planes (below right).



Three: HOLLAND PREFORMING ARTS

Omaha, Nebraska

HDR and Polshek Partnership collaborate to build a light-filled concert hall that invigorates a prominent downtown Omaha site.

By Russell Fortmeyer

Architect: A collaboration between HDR and Polshek Partnership Architects

Client: Heritage Services and the Omaha Performing Arts Society

Consultants: HDR (m/e/p/structural); Kirkegaard and Associates (acoustical); Fisher Dachs Associates (theater); Brandston Partnership (lighting)

Size: 175,000 square feet

Cost: \$95 million, including an addition and renovation at the Orpheum Theater

Completion date: October 2005

Sources

Exterior cladding: VM Zinc; Berridge (metal panels), Revere (copper panels)

Windows: Wausau; Pittco

Glazing: Viracon; Okalux; Solera

Doors: Vistawall; Crane Revolving Doors

Carpet: Bloomburg; Shaw

Polished plaster: Armourcoat

Lighting: Kurt Versen; Lithonia; Peerless; Poulsen

Chairs: Irwin Seating

Upholstery: Knoll; De Ball

Controls: Johnson Controls

Plumbing: American Standard; Toto

For more information on this project, go to Building Types Study at www.archrecord.com.

The first thing you notice about Omaha's new Holland Center for the Performing Arts is that you can see right through it. Walls of glass along the ground floor lobby help to enliven the Gene Leahy Mall, a flowing civic park across the street developed in part by Lawrence Halprin in the 1970s to renew the city and reconnect it with the river.

In a bid to drive downtown Omaha's continuing resettlement and to bolster a thriving fine arts scene, a former Swanson's foods plant was demolished to make way for the Holland, a \$95 million home for the Omaha Symphony. Nearly 85 percent of that money came from private fund-raising, testament to the community's commitment to having the arts downtown.

Program

The symphony previously performed at Omaha's Orpheum Theater, a historic, 1920s-era proscenium stage it shared with the opera and Broadway-style touring companies. With its new home at the Holland, Nebraska's premier symphony has expanded its programming with more performances each year and the ability to offer jazz and pop music in a smaller recital hall with a more flexible seating arrangement.

The Holland's design was a collaboration between the architecture and engineering giant HDR, which is headquartered in Omaha, and New York-based Polshek



Partnership Architects. "We felt strongly about the hall's relationship with the park," said HDR's Bruce Carpenter, AIA, adding that they also "wanted people to be drawn into the building."

Solution

HDR and Polshek developed the concert and recital halls as discrete rectangular elements within a topography inspired by the rolling landscape of southeast Nebraska. The moss green Chinese granite lobby floors patterned with the site's topographical contour lines reinforce the landscape theme. The ground floor is enclosed in half-inch, highly transparent, low-iron glass panels to attract street life to the activity within. Aluminum track in the floor anchors the glass, while a fin system minimally supports it

at the ceiling. Exterior materials include a zinc rain-screen system, a painted metal-panel system, prepatinated copper panels, and a 1.5-inch-thick French limestone cladding clipped to the concert hall's concrete structure.

The architects created a "floating wedge" element, clad in zinc panels, which acts as the main design strategy for the hall's exterior presence and for the interior lobby and circulation. The wedge doubles as flexible pre- and postperformance space, with sweeping views of the city and street through an expanse of south-facing fritted glass attached to an aluminum structure.

Once in the light-filled interior, visitors find a clerestory reminiscent of Vienna's revered Musikverein, an intentional reference incorporated by the architects following a plan-



The second-floor lobby “floating wedge” is clad in zinc panels, while the box of the concert hall is limestone with a glass clerestory (left). The ground floor’s glass curtain wall, supported by thin fins, creates a “see-through” effect for the Holland’s public spaces.



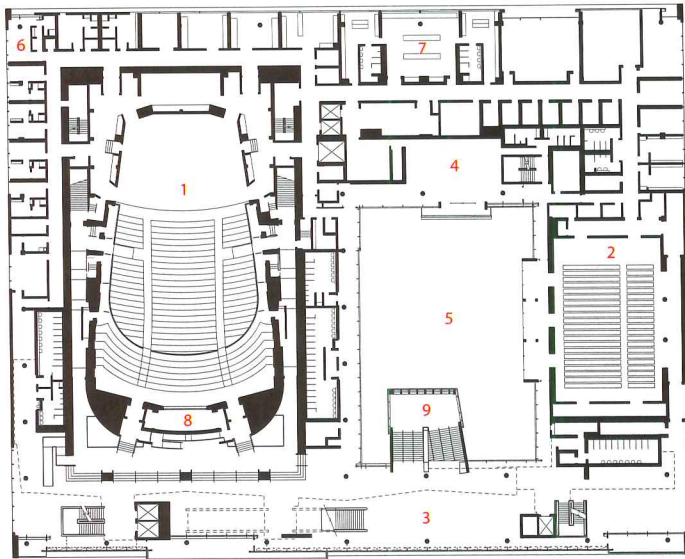

ORCHESTRA LEVEL

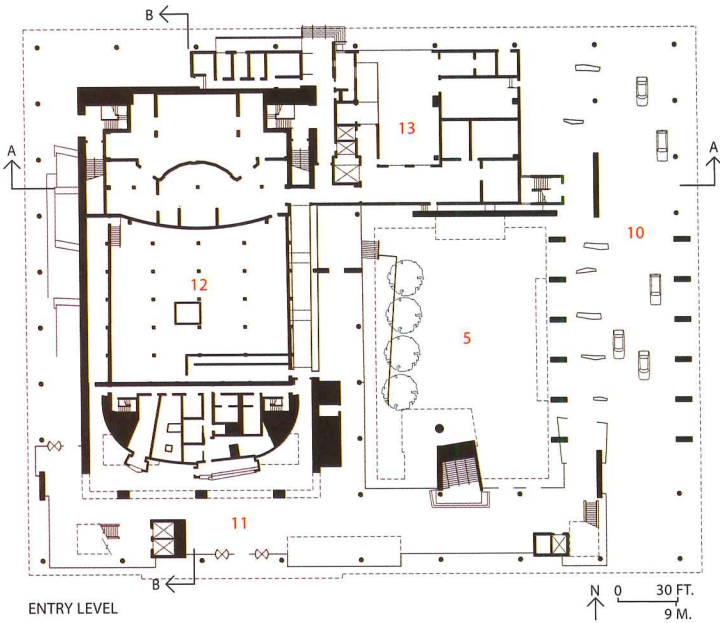

ENTRY LEVEL

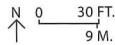

SECTION A-A

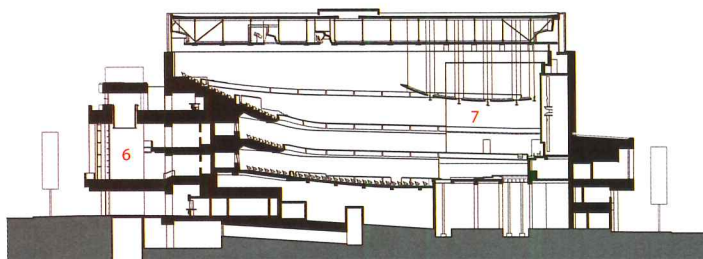

SECTION B-B

1. Concert hall
2. Recital hall
3. Second-floor lobby
4. Founder's room
5. Exterior courtyard
6. Conductor's suite
7. Instrument storage
8. Projection booth
9. Grand lobby stair
10. Driveway
11. Ground-floor lobby
12. Mechanical plenum
13. Loading dock

1. Concert hall
2. Mechanical plenum
3. Clerestory
4. Recital hall
5. Driveway
6. Lobby
7. Orchestra canopy

A grand stair connecting the ground floor's entrance lobby with the second-floor lobby (opposite, top left) includes a landing overlooking the exterior courtyard (opposite, top right). A second main stair, constructed of translucent glass treads, connects all lobby floors (below). Bridges take the audience from the lobby spaces into the concert hall on the second and third floors (below right).









The concert hall's clerestory floods the interior with daylight, which ripples across the plaster-cast wall panels, all 7,000 of which were crafted in downtown Omaha.

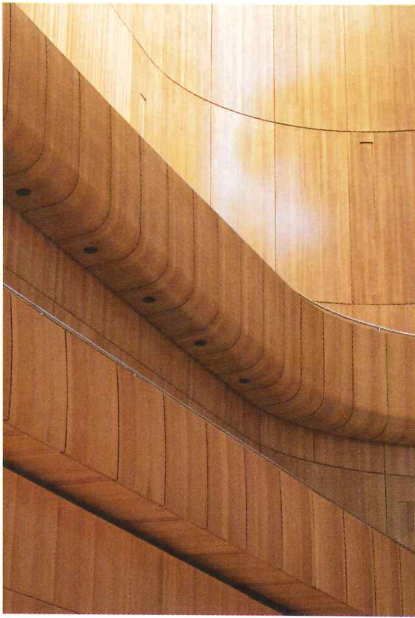

American sycamore wood panels are used sparingly across the balconies (far left), but envelop the orchestral stage (left). A slot pattern introduced around the stage will eventually provide sound openings for a planned organ (below left).

ning trip to visit European concert halls. Working with the Chicago-based acoustical consultant Kirkegaard and Associates, the architects shaped the hall as an ovoid modification of the classic shoe-box volume, with 738 seats on the orchestra level, 278 on a mezzanine, 576 in the balcony, and 88 loose chairs in side boxes. Dedicated solely to music, the hall could forgo the need for a theatrical proscenium, wings, or fly space.

An adjustable canopy over the stage reflects and diffuses sound. Pulled high and coupled with fiberglass panels that drop out of the ceiling, technicians can effectively eliminate the canopy for amplified music performances. Precast-concrete ceiling panels boost bass frequencies and support catwalks. Cast-plaster panels, with varied patterns to bolster sound diffusion, were glued to the hall's concrete shell.

Dawn Schuette, of Kirkegaard, said the glass clerestory could have presented a number of acoustical issues, but creating an air gap between two glass walls inhibited outside noise pollution and permitted the interior glass to be configured for acoustical reflectance rather than driven by thermal performance.

Commentary

HDR and Polshek have given Omaha a concert hall worth visiting for its rich sound, excellent sight lines, and striking interior, emboldened by the perfectly deft handling of the clerestory and its seemingly floating concrete ceiling. While the hall's programming director notes visiting musicians praise the hall's acoustics, the true evidence is the vibrant, precise sound one hears in practically any seat in the house. The clerestory further embellishes the ethereal pleasure of listening to the music performed.

If the relatively restrained exterior architecture of the Holland doesn't burst forth from its site by day, its clerestory becomes a giant glowing lantern for downtown Omaha at night, fulfilling the architects' desire to create a new icon for the city. ■

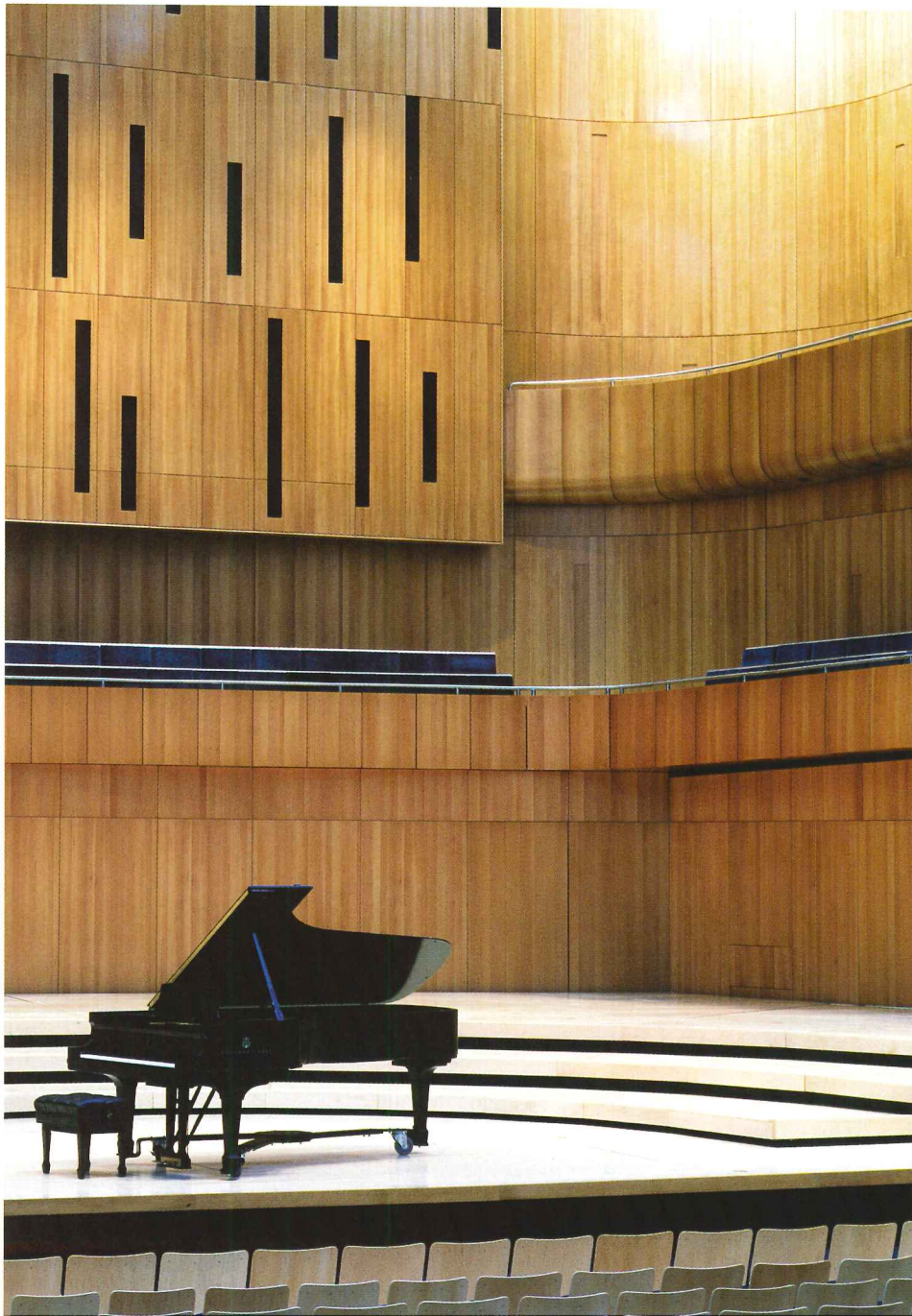

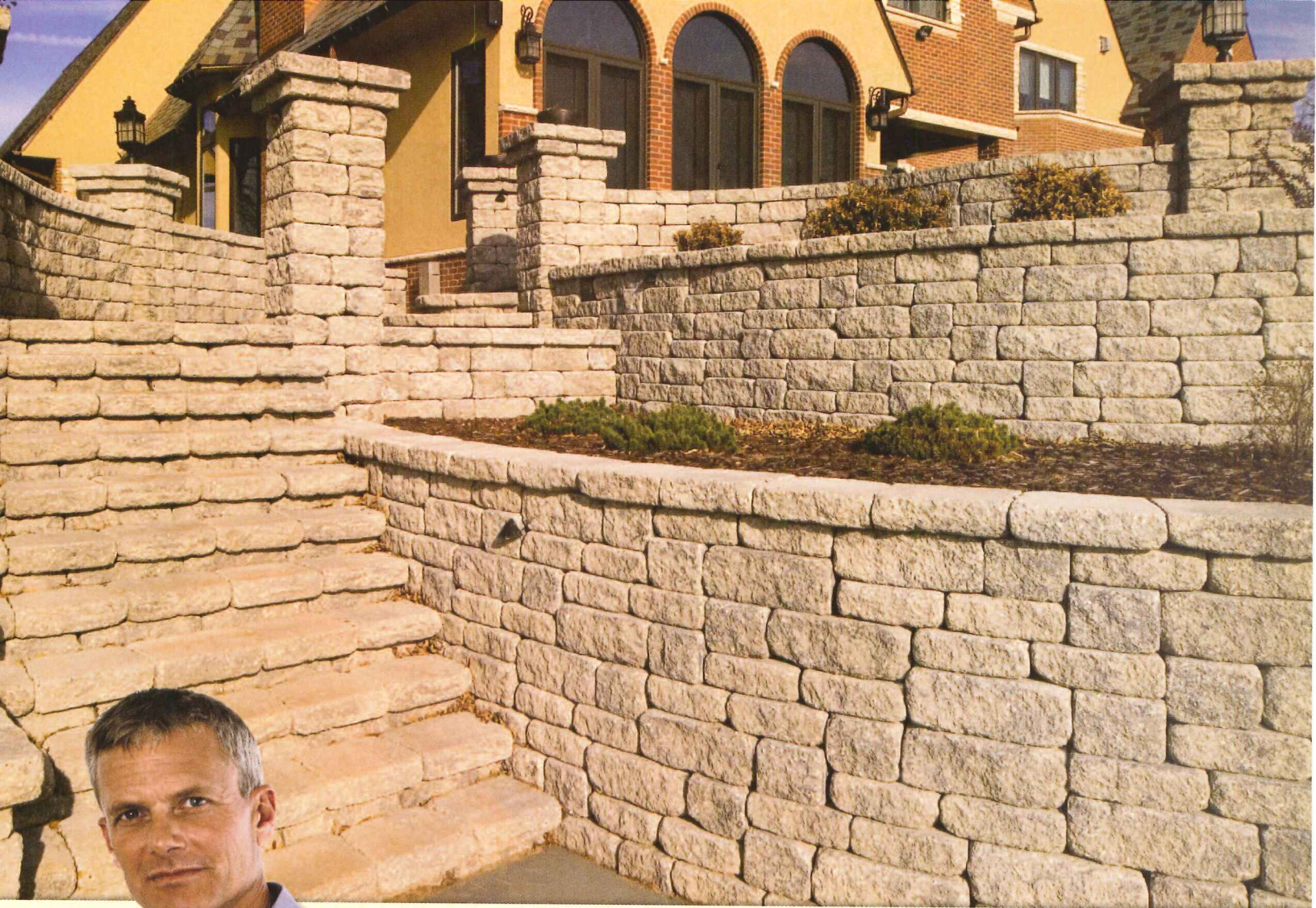

DESIGN FLEXIBILITY—AND REFERRALS—COME STANDARD.

“No matter what retaining wall design I have in mind, whether it includes stairs, columns, curves, corners, freestanding walls or Mosaic® random-pattern faces—I know VERSA-LOK can do it. And because it’s so easy to install, the contractors love it as well. As a landscape architect, you can’t be successful without referrals. After 18 years, I know that whenever VERSA-LOK is specified, my clients become my best salespeople.”

For more information on how VERSA-LOK can help you enhance your next design, call (800) 770-4525 or visit www.versa-lok.com.



Freestanding Walls



Mosaic Random Face Patterns



Fully Integrated Stairs



Random-Pattern Tall Walls

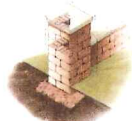

Freestanding Columns



Multi-Angle Corners

VERSA-LOK®
 Retaining Wall Systems
Solid Solutions.™

CIRCLE 40 ON READER SERVICE CARD OR GO TO ARCHRECORD.CONSTRUCTION.COM/PRODUCTS/

© 2006 Kiltie Corporation • Oakdale, MN

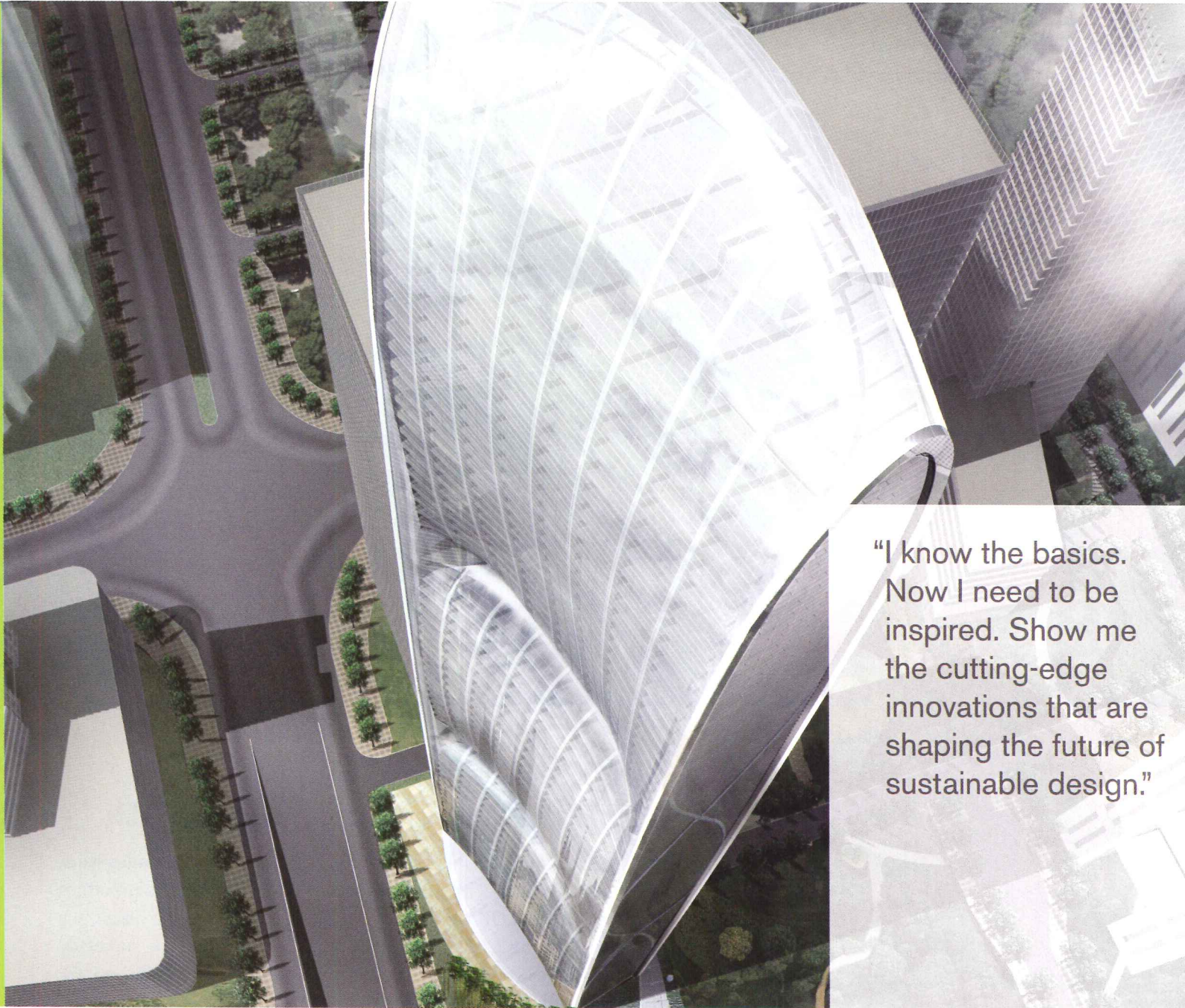

"I know the basics. Now I need to be inspired. Show me the cutting-edge innovations that are shaping the future of sustainable design."

Skidmore Owings and Merrill's Pearl River Tower (above and right) will be built in Guangzhou, China. It's designed to produce more energy than it consumes, and is just one of the case-study buildings that will be presented at the conference.



Key Corporate Sponsors:



INNOVATION

sustainable design that makes you say, "Hmm!"

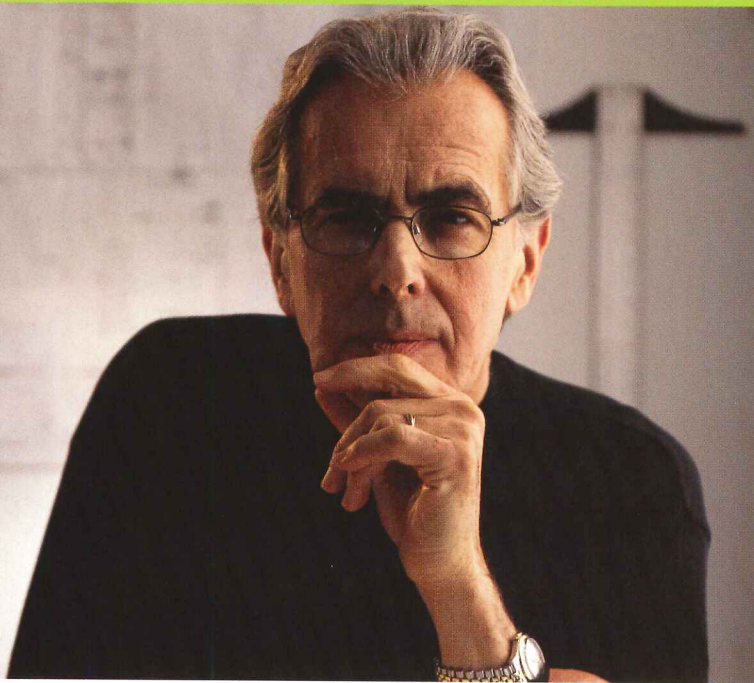

Architectural Record Innovation Conference

October 11-12, 2006—New York City

The future of sustainable design

For two days in October, experience the advanced thinking that's poised to transform the sustainability movement.

Imagine where this knowledge can take you...

- Technical reviews of the latest in high-efficiency HVAC, intelligent facades, daylighting systems, and alternative energy.
- Case study presentations of zero-carbon buildings that couple technically-advanced sustainability strategies with great design.

Presented by *Architectural Record* and McGraw-Hill Construction
Qualifies for 6 AIA HSW credits.

Imagine the possibilities...

Be there when the future is revealed at *Architectural Record's* annual conference on innovations in technology and design.

Now, imagine more...

Reserve your seat today!

Call Cristina Hoepker, 1-866-727-3820

Email cristina_hoepker@mcgraw-hill.com

Agenda and registration forms are available at:
www.construction.com/event/2006innovation/

Go to www.construction.com/event/2006innovation/

MAR68INN2-B

The McGraw-Hill Companies

TITE-LOC

Metal Roofing Panels

The grand Gaylord Texan Resort of the Lone Star State, references the natural materials rooted in the architecture of Texas. The Hnedak BoBo Group, Inc. chose the Tite-Loc Metal Roofing Panel in Galvalume Plus to mirror the metal roofs used throughout the region. The roofing contractor, Supreme Systems, installed 163,261 square feet of Tite-Loc Panels over this expansive roof.

Our newest roofing profiles, Tite-Loc and Tite-Loc Plus, have been designed for structural and architectural metal roofing applications and are available in a variety of materials including 22 and 24 gauge steel, and aluminum. Both profiles feature factory-applied hot melt sealant to insure weather tight performance. Panels are corrective-leveled during fabrication to provide superior panel flatness. Both profiles feature our PAC-CLAD® Kynar 500® finish, now available in 42 standard colors on steel and 37 standard colors on aluminum.

For more information regarding our complete line of metal roofing products, please call us at 1-800-PAC-CLAD or visit our website @ www.pac-clad.com.

CIRCLE 41 ON READER SERVICE CARD OR GO TO ARCHRECORD.CONSTRUCTION.COM/PRODUCTS/

PAC-CLAD
Petersen Aluminum

1005 Tonne Road • Elk Grove Village, IL 60007
1-800-PAC-CLAD or 1-847-228-7150
Fax: 1-800-722-7150 or 1-847-956-7968

Other Plant Locations:

Annapolis Junction, MD: 1-800-344-1400

Tyler, TX: 1-800-441-8661

Kennesaw, GA: 1-800-272-4482

<http://www.pac-clad.com>

A Lone Star in the State of Texas.

Gaylord Texan Resort and Convention Center
Grapevine, TX
Owner: Gaylord Properties
Architect: Hnedak BoBo Group, Inc. - Memphis
Roofing Contractor: Supreme Systems
Panel Profile: Tite-Loc
Color: Galvalume Plus

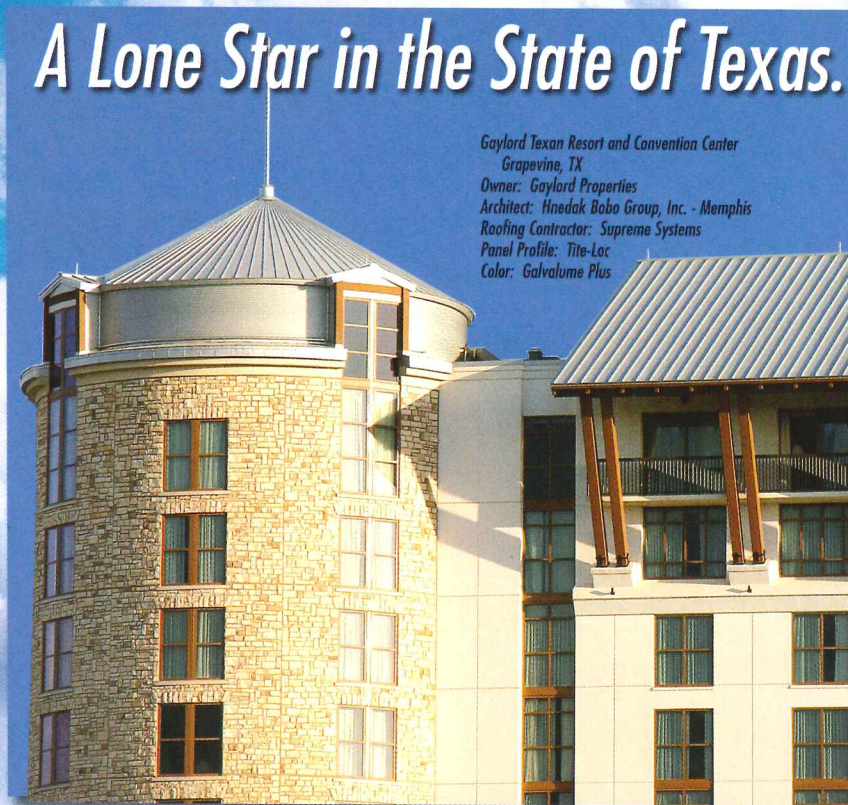

Rooftops Slowly, but Steadily, Start to Sprout

TECHNOLOGY BEGINS TO TAKE ROOT ON ROOFS IN NORTH AMERICA AS NEW RESEARCH SUPPORTS CLAIMS OF ENVIRONMENTAL BENEFITS, AND POLICIES ENCOURAGING IMPLEMENTATION MULTIPLY

By Joann Gonchar, AIA

Planted material on top of buildings is hardly a new concept. From the fabled hanging gardens of Babylon to the vernacular sod-covered buildings of Scandinavia and the settlers of the American Great Plains to earth-sheltered architecture, vegetated roofs have many precedents.

Today, planted rooftops, while still far from common building practice in North America, are slowly gaining ground as a growing body of research supports the claim that green roofs are well suited for our climate. A properly installed green roof can reduce storm-water runoff, provide both heat and sound insulation, and create habitat for birds and insects. As part of a network of green roofs, it can mitigate urban heat-island effect. According to Green Roofs for Healthy Cities, a nonprofit industry association with the mission of promoting the technology, almost 2.5 million square feet of green roofs were planted in North America last year, a 72 percent increase from 2004.

Contemporary green roofs, also known as eco roofs, have their roots in German technology that is well developed after more than three decades of use. Although a number of systems are commercially available and a variety of combinations are possible, a green roof generally consists of planted material in a lightweight growing medium on top of a drainage and water-retention layer, a root barrier, and a waterproofing membrane.



Michael Graves's Portland Building will soon have a green roof as the result of a local resolution passed earlier this year. Officials will monitor how effectively the installation mitigates storm-water runoff.

Green roofs generally fall into two categories—either extensive or intensive. Extensive green roofs are lightweight, and may have as little as 3 or 4 inches of soil. They are usually planted with hardy, drought-resistant vegetation that requires little maintenance or irrigation.

With greater soil depth, intensive green roofs can support a wider variety of plant material, such as flowers, shrubs, or even small trees. These systems can be used to achieve a more landscaped, garden-like environment, but intensive green roofs may require maintenance such as watering, fertilization, or weeding. Designers also need to take into account the heavier roof loads that the deeper soil and more elaborate plantings will impose on the building's structural system.

Sticks and carrots

Green roofs are taking hold most firmly in jurisdictions with policies and incentives that encourage implementation. "About 75 percent of the market is regulatory driven, but I see this as changing over time," says Sandra McCullough, business team leader for Green Grid, a supplier of a modular planted roof system.

In Chicago, building owners have planted more square feet of green roofs than those in any other North American city for two years in a row, according to Green Roofs for Healthy Cities. A total of 2.5 million square feet of green roofs are planned, in construction, or installed, says Michael Berkshire, the city's green projects administrator.

Not surprisingly, Chicago has an aggressive set of programs aimed at increasing implementation of green roofs and other sustainable building practices. Since planting of a 20,300-square-foot green roof on city hall in 2000, Chicago has instituted an incentive in the form of a density bonus for building owners that install green roofs. It also requires green roofs on construction projects that receive public assistance or are

CONTINUING EDUCATION



Use the following learning objectives to focus your study while reading this month's ARCHITECTURAL RECORD/AIA Continuing Education article. To receive credit, turn to page 142 and follow the instructions. Another opportunity to receive Continuing Education credits in this issue can be found in the sponsored section beginning on page 145.

LEARNING OBJECTIVES

After reading this article, you should be able to:

1. Identify the benefits of planted rooftops.
2. Describe the composition of planted rooftops.
3. Explain why the number of structures with planted rooftops is increasing.

For this story and more continuing education, as well as links to sources, white papers, and products, go to www.archrecord.com.



Howard Hughes Medical Institute Research Campus
 Slated to open in September, the Howard Hughes Medical Institute is building a research facility covered by a 180,000-square-foot green roof in Loudoun County, Virginia (left). Clusters of offices and conference rooms form the edges of curved and planted terraces. Support spaces not requiring natural light, such as the central plant and parking garage, are located away from the terrace edges.

South Loop Target Store Green Roof Installation
 Chicago has an aggressive set of policies to stimulate green roof development. The city requires green roofs on all buildings subject to review by its planning department. It also offers a density bonus and provides matching funds. So far, Chicago has about 2.5 million square feet of green roofs either planned, in construction, or completed. Green roofs have been planted on top of Chicago office towers, multifamily residential buildings, and stores, including the roof of a Target store in the city's South Loop (opposite, left).

Top Cities for Green Roofs (2005)*

1. Chicago	295,600 square feet
2. Washington, D.C.	206,900
3. Suitland, Md.	205,000
4. Ashburn, Va.	120,000
5. New York City	119,895
6. Culpepper, Va.	100,000
7. Austin, Tex.	97,384
8. Arlington, Va.	96,768
9. Des Moines	94,750
10. Ottawa, Ont.	84,600

*Represents 2005 installation activity reported by Green Roofs for Healthy Cities corporate members.

Building owners in Chicago, a city with several policies directed at promoting green roof implementation and sustainable building practices, installed more square feet than those in any other North American municipality in both 2004 and 2005.

subject to review by the department of planning. Earlier this summer, the city council approved a plan to offer matching funds up to \$100,000 toward the installation of green roofs on downtown buildings. "Our approach is a combination of the carrot and the stick," says Berkshire.

Green roof development is also relatively strong in several

THE MARKET FOR GREEN ROOFS IS STILL PRIMARILY REGULATORY DRIVEN, ACCORDING TO SYSTEM SUPPLIERS.

Washington, D.C.-area communities. Some sources attribute this demand for green roofs to the regional presence of the General Services Administration (GSA) and its commitment to sustainable building practices and certification of its facilities under the U.S. Green Building Council's LEED program. LEED recognizes green roofs as a storm-water rate- and quantity-management strategy. "Around Washington, D.C., the GSA is a large public landowner that is 'walking the talk,'" says Steven Peck, Green Roofs for Healthy Cities president.

Local regulations directed at safeguarding the health of the



National Oceanic and Atmospheric Administration
 At NOAA's new satellite operations center (below and bottom) in Suitland, Maryland, a conventionally roofed, 70,000-square-foot building houses the satellite control equip-

ment. But the bulk of the facility—a 140,000-square-foot office space—is built into a grassy slope. The site's primarily permeable surfaces provide almost all of the required storm-water quantity and quality management.

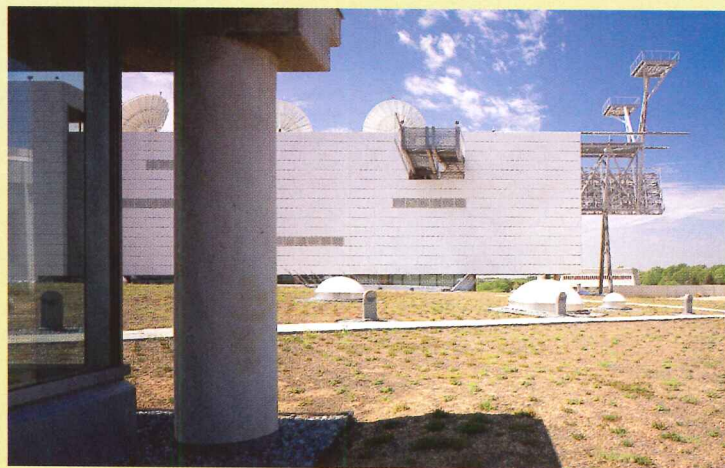

ARCHITECTURAL TECHNOLOGY

Chesapeake Bay stemming from the federal Clean Water Act may also be responsible for the regional growth. In many of the municipalities comprising the bay's watershed, a green roof is considered an acceptable storm-water-management practice, says Pat Devlin, director of policy and protection at the Alliance for the Chesapeake Bay.

One recently occupied GSA project, the \$61 million National Oceanic and Atmospheric Administration (NOAA)'s satellite operations center, in Suitland, Maryland, has the largest completed green roof on the Eastern Seaboard. Designed by Morphosis and Einhorn Yaffee Prescott, an approximately 70,000-square-foot, above-ground, conventionally roofed building houses the satellite control equipment. But the bulk of the facility—a 140,000-square-foot office space—is built into the side of a grassy slope. Courtyards and skylights provide natural light to the interior.

The primarily permeable surfaces of NOAA's site slow the rate and quantity of runoff and help remove undesirable solids and nutrients from this water, according to Max Kantzer, an associate at A. Morton Thomas & Associates, the project's civil engineer. The site needed only minimal storm-water-management features, such as a small detention structure, and shallow grass-lined swales. "The green roof reduces the

amount of storm-water management needed on-site, and contributes a significant amount of water-quality control," he says.

Another project under way in the region will have an even larger green roof. The Howard Hughes Medical Institute is building a research center in Loudoun County, Virginia, designed by Rafael Viñoly Architects (RVA). Clusters of offices and conference rooms are set into curved terraces covered by a 180,000-square-foot green roof punctuated with interior courtyards. Support spaces not requiring natural light, such as a 300-car parking garage and a central plant, are also submerged under the green roof but are set away from the terraced edges.

The landscaped roof of the Howard Hughes facility will retain more storm water than a traditional lawn, and the runoff will not require extensive treatment to remove contaminants, due to its engineered drainage and planting media, says Jay Bargmann, AIA, RVA vice president. A built-up roof is considered to have a runoff coefficient of 0.95; in other words, about 95 percent of the water hitting a conventional roof will leave the surface and need to be accounted for in the design of the building's storm-water system. In comparison, a traditional lawn or turf area is considered to have a runoff coefficient of 0.35, while that of

Green Roof Evaluation Project
A Seattle research project is tracking both weather and runoff data at five green roof

test plots (below). The plots each employ a different green roof system. Performance under the same conditions varies (right).

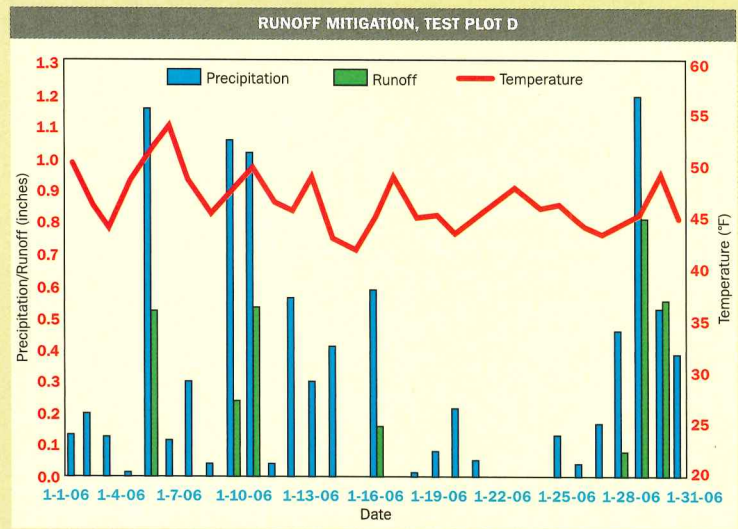
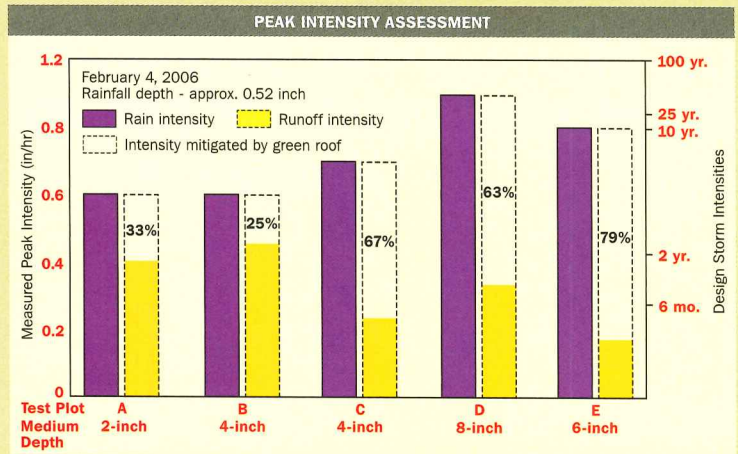
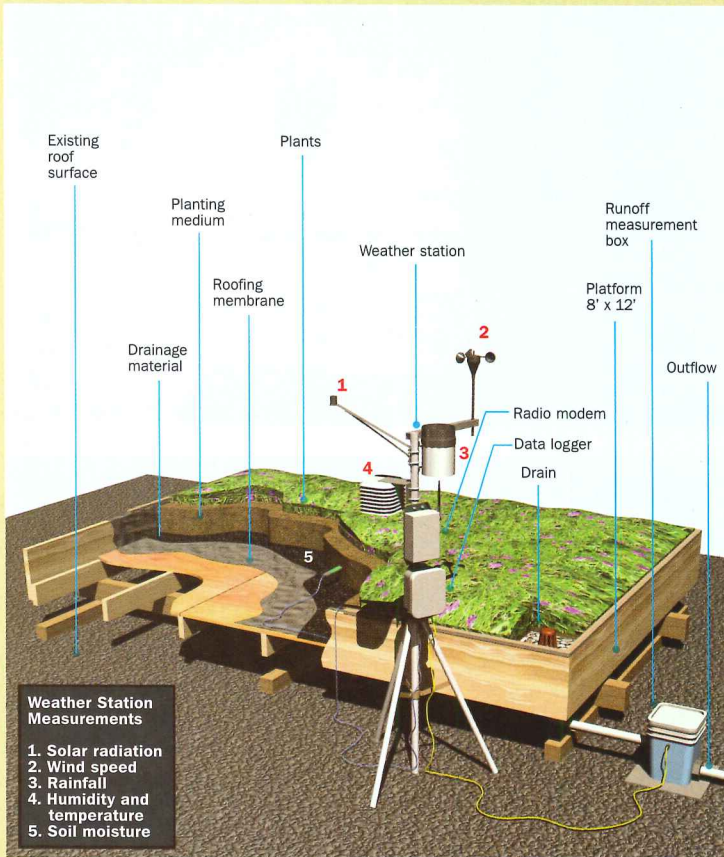

Data from one Seattle test plot (above) demonstrates that even after successive storms, green roofs typically mitigate at least some runoff.

the Howard Hughes landscaped roof is 0.25. But Bargmann points to a less tangible benefit of the green roof as even more important. As he notes, “The project sets a standard for [preserving] open spaces in that suburban environment.”

In the Pacific Northwest, a more modest size green roof is in the process of being installed on top of Michael Graves’s Portland Building, completed in 1982. The 18,200-square-foot extensive installation, designed by Macdonald Environmental Planning, will include a variety of sedums and grasses, and was spawned by a city council resolution passed earlier this year. The regulation requires that new city buildings include a green roof, if practical, and also applies when roofs on existing buildings are replaced.

The Portland Building roof will include a system to monitor how well the installation mitigates storm-water runoff. City officials hope to ultimately use the data collected, along with data from four other roofs it has been monitoring for several years, to fine tune requirements for various incentives aimed at increasing implementation of the technology. Results thus far show that the installations mitigate between 30 and 60 percent of total runoff, depending on factors such as the thickness and

composition of the growing medium, and the type of plant material, according to Tom Liptan, the city’s environmental specialist.

Portland offers a floor area ratio (FAR) bonus to building owners who incorporate green roofs into buildings in the center of the city. About 12 projects have taken advantage of the policy since it was instituted in 2001. “We are now starting to evaluate how we might improve the FAR bonus or develop policy to encourage green roof development in

EVEN THE MOST UTILITARIAN EXTENSIVE INSTALLATION CAN ADD \$7 TO \$10 PER SQUARE FOOT TO THE COST OF A ROOF.

other areas of the city,” says Liptan.

Green roof advocates say incentives are necessary to offset the expense. Even the most utilitarian extensive installation adds about \$7 to \$10 per square foot to the cost of a roof, estimates Drew Gangnes, director of civil engineering at Magnusson Klemencic Associates, a Seattle-based consulting firm.

Some jurisdictions allow a green roof as a substitute for other



William Duff, Architect, WDArch.com



James Walbridge, Architect, tektonarchitecture.com

Open the door to exhilaration

Enjoy the best of both worlds—a room with a view that opens to the outdoors yet gives you the peace of mind only a weathertight NanaWall provides.

800.873.5673

nanawall.com

NanaWall® 
The Leader in Opening Glass Walls

CIRCLE 42 ON READER SERVICE CARD OR GO
TO ARCHRECORD.CONSTRUCTION.COM/PRODUCTS/

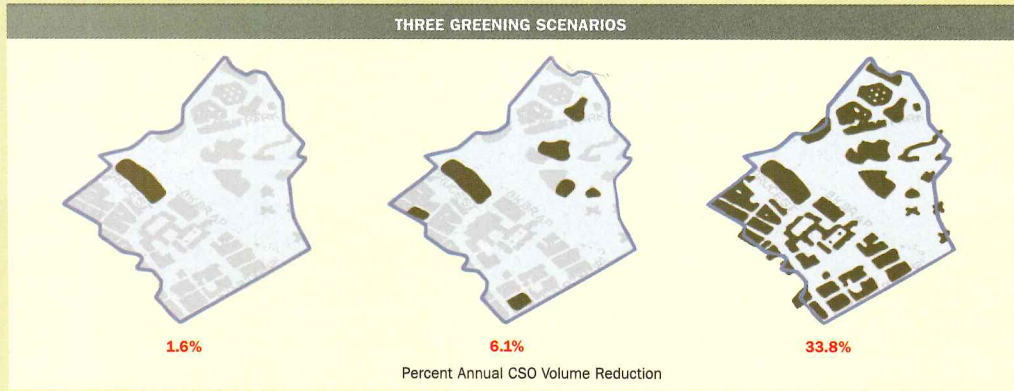

Earth Pledge Storm-Water Model

Predictive models can be helpful in analyzing the aggregate impact of a network of green roofs on an entire neighborhood. Earth Pledge, a New York City–based environmental group, is developing a model that can be used to evaluate the affect of green roof development on urban storm-water infrastructure. It shows that greening the roofs for one sewer-shed subbasin in Lower Manhattan would reduce the volume of combined sewer overflows by almost 34 percent.

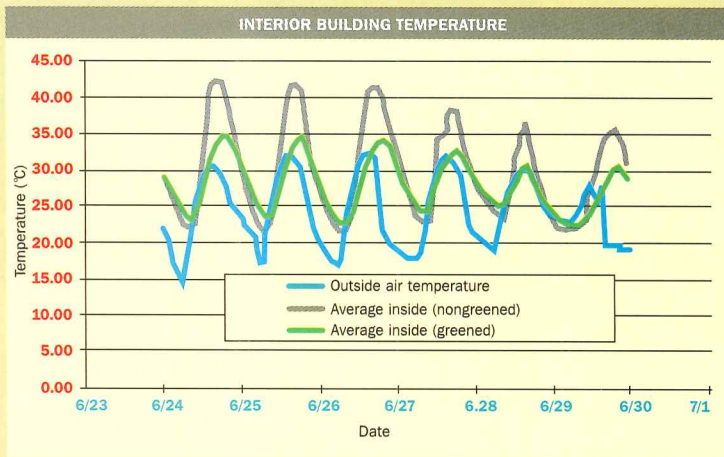

Penn State University Center for Green Roof Research

A green roof can keep buildings cooler in summer (above) and can therefore help save on air-

conditioning costs, according to studies conducted at PSU's Center for Green Roof Research (right). This strategy makes most sense in regions with long cooling seasons.



storm-water-management measures. However, even elimination of an underground retention tank will cover only 30 to 70 percent of the roof's cost, says Gangnes. "The public sector should provide incentives since there are public benefits," he says.

Gangnes's firm, along with a construction firm and several local developers, is monitoring the performance of five green roof test plots installed on top of four existing buildings around Seattle in February 2005. The 8-by-12-foot test plots each employ a different proprietary system, with a different thickness and composition of growing media and different plant material. So far, the data collected indicates that even in soggy Seattle, green roofs can be an effective storm-water-management strategy. The plots, even after successive storms, generally held water long enough for it to evaporate from the soil and transpire from the plants—a process called evapotranspiration.

Some researchers are developing predictive modeling tools to help building designers and owners calculate the retention and detention potential of a green roof with specific characteristics on an individual

building. Earth Pledge, a new York City–based nonprofit environmental organization, is developing such a tool. The program will also have macro capabilities, allowing urban planners and government leaders to evaluate the aggregate impact of green roof development in a given sewer shed and direct resources. "It is a policy-making tool that will help identify the neighborhoods where green roofs will have the most significant impact," says Leslie Hoffman, executive director.

Toxic cocktail

A model of the type that Earth Pledge is developing could be particularly useful in cities with older, overtaxed combined sewer systems that transport both storm water and sewage. About half the time it rains in New York, for example, the volume of raw sewage and contaminated storm water exceeds the system's capacity. These occurrences, known as combined sewer overflows (CSOs), result in the release of this toxic mix directly into the city's surrounding waters.

Earth Pledge has so far built out the model with building-stock

Design
with Light.

*The West Midtown Intermodal Ferry Terminal, NYC, NY
Architect: William Nicholas Bodouva & Associates
50 Monumental Shades: 25' high*

A New Vision:
WindowManagement™ Solutions
Daylighting Controls
www.mechoshade.com

 **MechoShade**®
The Architect's Choice.™
MechoShade Systems, Inc.
718-729-2020 • www.mechoshade.com



CIRCLE 43 ON READER SERVICE CARD OR GO
TO ARCHRECORD.CONSTRUCTION.COM/PRODUCTS/

© 2006, MechoShade Systems, Inc. All Rights Reserved.
Photography: Jim Roof Creative, Inc.

data, land-use characteristics, and infrastructure information for one sewer-shed subbasin in Lower Manhattan. The model predicts a 34 percent reduction in the volume of CSOs if all buildings in the study area were covered with green roofs. The reduction in the number of incidences of CSOs would be minimal due to the high percentage of impervious surfaces in the selected sewer shed, according to Earth Pledge. The group hopes to license the model to other cities, incorporating their rainfall and infrastructure data.

The storm-water model is part of a larger Earth Pledge green roof project. About a year ago, the group installed a 35,000-square-foot green roof on top of Silver Cup Studios in Long Island City, Queens, and

TAILORED MODELING TOOLS COULD HELP DETERMINE WHERE GREEN ROOFS WOULD HAVE THE MOST SIGNIFICANT IMPACT.

is monitoring its thermal performance and storm-water-management capabilities. It will also monitor a 10,000-square-foot green roof that it is now installing on top of a warehouse in the same New York City neighborhood. Data from both sites will be used to test and refine the model.

Storm-water issues are not the only area of current green roof investigation and modeling. One of several topics of study at the Pennsylvania State University (PSU) Center for Green Roof Research is

the potential for green roofs' evaporative cooling to ameliorate the urban heat-island effect. PSU's facilities consist of six garden-shedlike wood-framed buildings that are heated and cooled. Three of these buildings have green roofs, while the other three have conventional roofs and serve as experiment controls, explains Robert D. Berghage, associate professor of horticulture. He tracks the temperatures on the test buildings' roofs and then determines the impact at the city scale through modeling.

Brad Bass, an adjunct professor at the Center for the Environment at the University of Toronto, has developed a modeling tool that can predict how much energy can be saved by including a green roof on an individual building. It takes into account such factors as local climate data, building configuration, and regional construction practices. Some researchers caution, however, that a green roof employed merely as an energy-saving device may not make economic sense to a building owner in a climate with a short cooling season.

PSU tests confirm that the insulative properties of green roofs reduce thermal loading and therefore can help save on air-conditioning costs. However, green roofs also prevent desirable heat during winter, says Berghage. But he points out that use of green roofs in climates with short cooling seasons could still have advantages. Widespread adoption of measures like green roofs that help cut energy use in the summer, the season associated with peak utility loads, could reduce the need for additions to the power-generation infrastructure. "Although this may not translate into a benefit for an individual owner, there is a societal benefit." ■



AIA/ARCHITECTURAL RECORD CONTINUING EDUCATION

INSTRUCTIONS

- ◆ Read the article "Rooftops Slowly, but Steadily, Start to Sprout" using the learning objectives provided.
- ◆ Complete the questions below, then fill in your answers (page 211).
- ◆ Fill out and submit the AIA/CES education reporting form (page 211) or download the form at www.archrecord.com to receive one AIA learning unit.

QUESTIONS

1. Contemporary green roofs have their roots in which?
 - a. German technology
 - b. nonprofit industry
 - c. hanging gardens of Babylon
 - d. sod-covered Scandinavian buildings
2. Characteristics of extensive green roofs include all except which?
 - a. they are lightweight
 - b. use a wide variety of plant materials
 - c. require little maintenance
 - d. require little irrigation
3. Characteristics of intensive green roofs include all except which?
 - a. a gardenlike environment
 - b. deeper soil
 - c. require fertilization
 - d. hardy, drought-resistant plants
4. The benefits of a planted rooftop include all except which?
 - a. provide heat and sound insulation
 - b. mitigate urban heat-island effect
 - c. increase storm-water runoff
 - d. create habitat for birds
5. Research supports the claim that green roofs are which?
 - a. contributors to combined sewer overflows
 - b. contributors to desirable heat gain in winter
 - c. well suited for North American climate
 - d. a substitute for insect habitats
6. Green roof technology is most prominent where?
 - a. in areas with hot, dry climates
 - b. in areas where policies and incentives encourage the technology
 - c. in Washington, D.C.
 - d. in New York
7. Where is a green roof considered an acceptable storm-water-management practice?
 - a. in General Services Administration buildings
 - b. in Seattle
 - c. in some municipalities comprising Chesapeake Bay's watershed
 - d. in Chicago
8. The Portland Building is getting a green roof for which reason?
 - a. the city offered a bonus to building owners who incorporate a green roof
 - b. all city buildings must have a green roof when their roof is replaced
 - c. all new city buildings must have a green roof
 - d. all GSA buildings must have a green roof
9. Why do green roof advocates say incentives are necessary?
 - a. to offset the cost of adding green roofs to a building
 - b. even if the green roof substitutes for other storm-water management, the roof still costs more
 - c. there are public benefits to green roof installations
 - d. all of the reasons above
10. Research in five test plots in Seattle has shown which outcome?
 - a. Seattle is too soggy for green roofs to help storm-water management
 - b. green roofs do better in cloudy, rainy climates
 - c. green roofs need special considerations in rainy climates
 - d. green roofs can be an effective storm-water-management technique



Sculpt your space.

Nowhere is it chiseled in stone that ceilings have to be flat. USG specialty ceilings give you the flexibility to add dramatic twists, turns and movement, with surprising ease and affordability. So go ahead. Sculpt your space. Visit our photo gallery at www.usg-ceilings.com to see the possibilities.



Specialty Ceilings

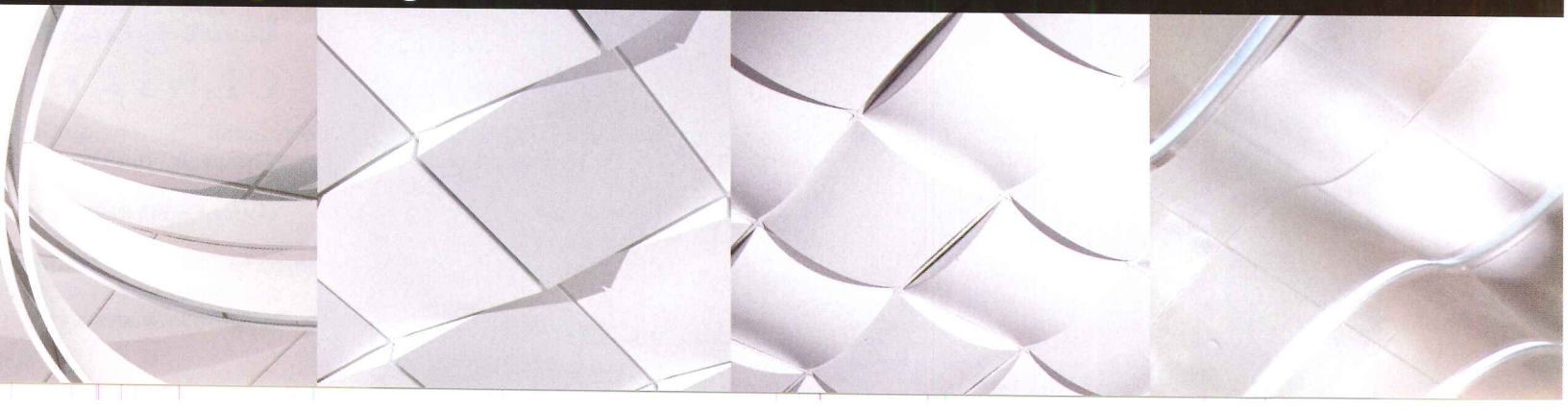

Designing a wall?
Or an Advanced Thermal and
Moisture Protection system?

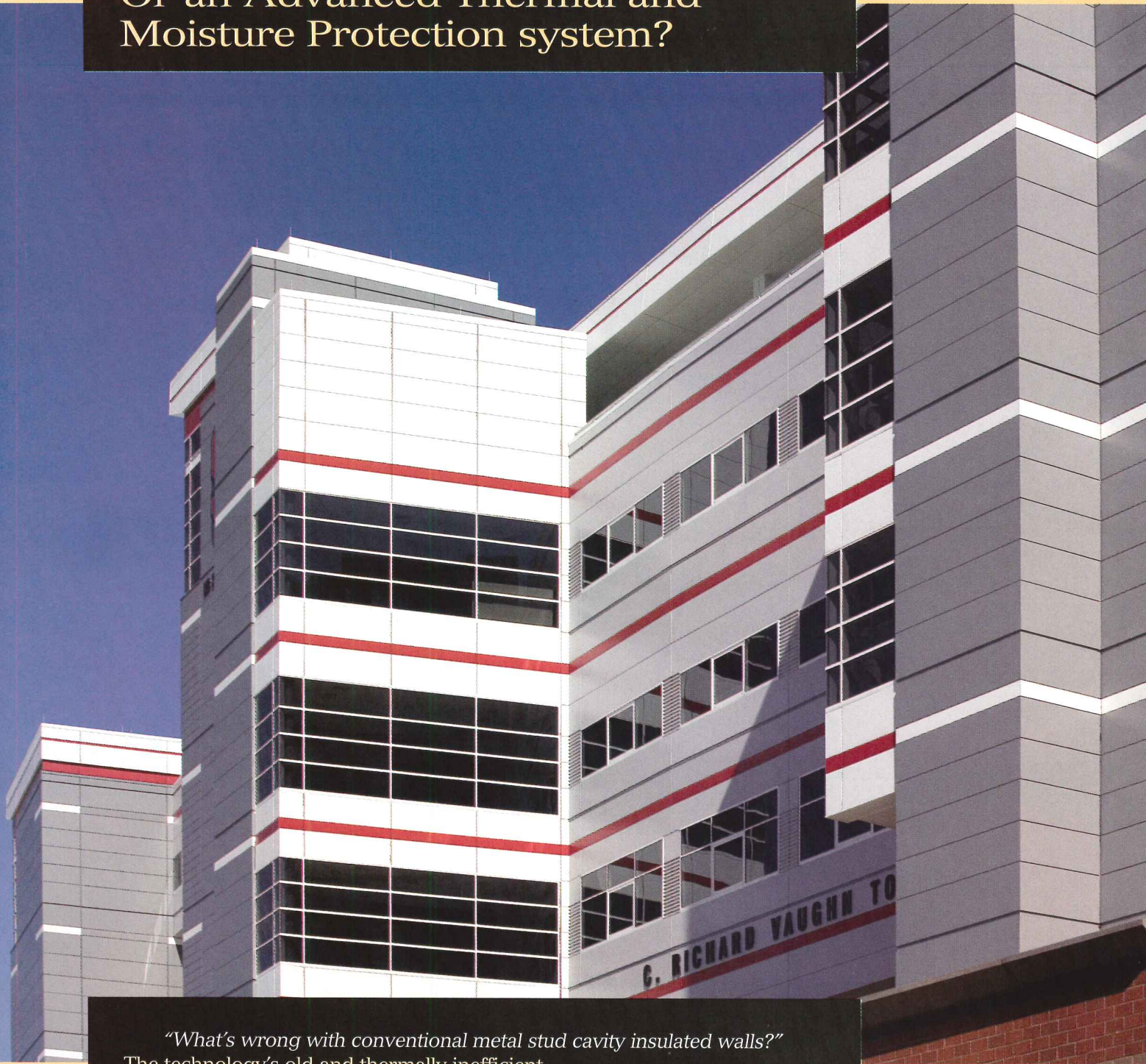

"What's wrong with conventional metal stud cavity insulated walls?"
The technology's old and thermally inefficient.

"But, we use multiple components for moisture control."
And any component, not installed perfectly, can cause total wall failure.

"But, we use the details recommended by wall component manufacturers."
And who is responsible for the total wall system's integrity?

"So, what makes CENTRIA Formawall Dimension Series a better system?"
One panel, one step, one manufacturer. And it works.



CENTRIA Formawall Dimension Series is the first and only building envelope product to receive Cradle-to-Cradle Certification by McDonough Braungart Design Chemistry for its human and environmental health benefits.

CIRCLE 44 ON READER SERVICE CARD OR GO TO ARCHRECORD.CONSTRUCTION.COM/PRODUCTS/

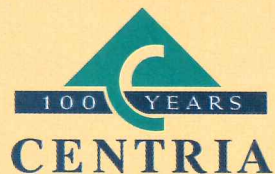

Formawall™ Dimension Series
The Wall That Works.

www.CENTRIA.com

North America **1.800.752.0549**

China **+86.21.5831.2718**

Dubai **+971.4.339.5110**

21st Century Building Envelope Systems: Merging Innovation with Technology, Sustainability, and Function

Presented by:
Dryvit
Vistawall
CENTRIA
W&W Glass
Oldcastle
Alcoa



CONTINUING EDUCATION

Use the learning objectives below to focus your study as you read **21st Century Building Envelope Systems: Merging Innovation with Technology, Sustainability, and Function**. To earn one AIA/CES Learning Unit, including one hour of health safety welfare credit, answer the questions on page 156, then follow the reporting instructions on page 212 or go to the Continuing Education section on archrecord.construction.com and follow the reporting instructions.

LEARNING OBJECTIVES

After reading this article, you should be able to:

- Evaluate the latest materials, technology, architectural components, and related systems that comprise the building envelope.
- Identify performance characteristics and qualities that are important considerations during building envelope design, specification, and construction.
- Explain how to minimize risk and liability when approaching design, specification, and selection of building envelope products and systems.
- Analyze the sustainability benefits and attributes of various building envelope products, systems, and performance criteria.

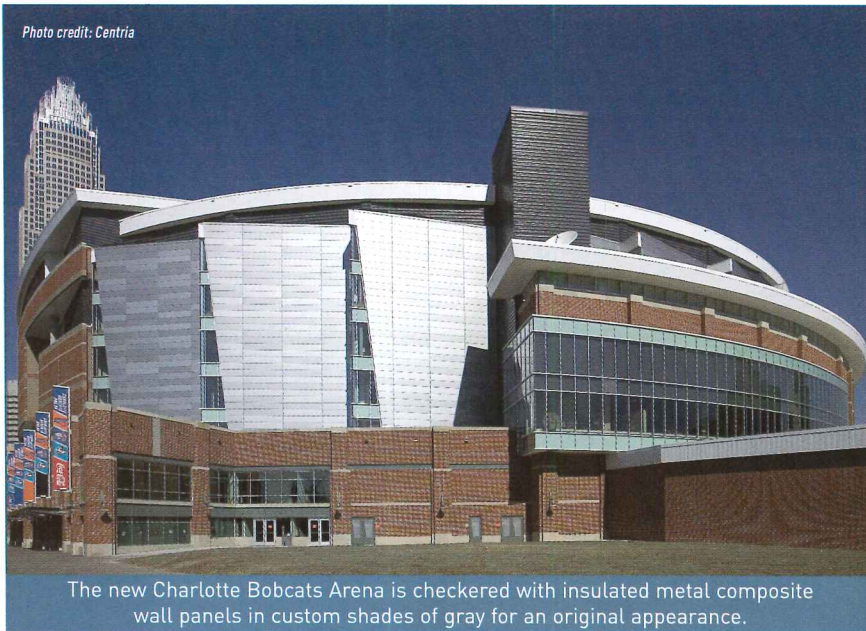

Photo credit: Centria

The new Charlotte Bobcats Arena is checkered with insulated metal composite wall panels in custom shades of gray for an original appearance.

Innovative architectural design is enhanced by careful attention to detailing, selection and specification of compatible materials and related component systems. At the same time, architects, specifiers, and design professionals must be aware of component installation methods and construction techniques. With so many advances in manufacturing processes, emerging new materials, and enhanced technology in the marketplace, along with ongoing updates of building codes and industry testing criteria, and an often unskilled labor force, the required knowledge base for effective building envelope design is constantly expanding.

“A multi-component building envelope system that is engineered, fabricated, and assembled by the manufacturer can reduce design efforts, errors, and associated liability, if architects and specifiers can define the required performance criteria. Because the system can be tested as an assembly extensively in labs, it avoids field-testing, which is often required for large-scale buildings or critical facilities. The systems also benefit owners of large and multiple facilities because of the standardization of facility design and management. They generally simplify construction planning and shorten project duration,” observes Tian Feng, AIA, FCSI, Chief Architect, San Francisco Bay Area Rapid Transit, and former construction expert witness consultant, Oakland, California.

21st Century Building Envelope Systems: Merging Innovation with Technology, Sustainability, and Function

By addressing energy efficiency, moisture infiltration, aesthetics, and occupant comfort, building envelope elements and component systems enhance design opportunities and minimize potential risk

By Barbara A. Nadel, FAIA

“The building envelope is more than a façade—it is the poetic mediation between an internal spatial realm and the outside world.”

**-Antoine Predock, FAIA, 2006 American Institute of Architects Gold Medalist
Antoine Predock Architect, PC, Albuquerque, NM**

The fundamental goals of a successful building, regardless of location, aesthetics, program, owner, and building type, are essentially to keep water out and allow thermal control within. The building envelope encompasses the entire exterior surface of a building, including walls, doors, and windows, which enclose, or envelop, the interior spaces. Weaknesses in the building envelope can result in several undesirable results, from moisture infiltration, often leading to mold and mildew; damage caused by wind loads, high energy costs, ongoing maintenance problems, and failure of one or more architectural and engineering building systems. Any of these scenarios, and the numerous ripple effects that may ensue, can potentially increase risk and liability concerns for architects, design professionals, building owners, and occupants.

For these reasons, and the desire to promote sound professional design standards, a thorough understanding of building envelope design methods and construction techniques are critical aspects of architectural practice. When building envelope problems arise, liability concerns often focus on factors and parties relating to design, construction, manufacturing, and testing of systems and materials.

This article will address several components and systems that comprise the building envelope, and explore innovative qualities, trends, and characteristics. These building envelope design elements include: high performance insulated metal composite panels; point supported, bolted glass systems; curtain wall and ribbon window systems; seamless building envelope solutions using different types of glass and fenestration components; hurricane-resistant aluminum composite materials with high strength organic fiber, and a product not visible on the building envelope exterior, a liquid-applied flashing system.

Insulated Metal Composite Panels

Innovative building envelope materials often address several issues, from promoting sustainability and energy efficiency, to minimizing liability and risk stemming from mold issues. At the 2006 AIA Convention, William McDonough, FAIA, described the development of “cradle to cradle” strategies, which analyze the nature of materials in products. This analysis goes beyond cradle to grave (manufacture to disposal), extending from creation to re-creation, through complete cyclical reuse.

Sustainability and Product Life Cycle

Cradle to Cradle Certification, a new sustainability evaluation method, is administered by McDonough Braungart Design Chemistry (MBDC), which reviews material or product ingredients, and the formulation for human and environmental health impacts throughout the overall life cycle. The certification assesses a material’s potential for being recycled or safely composted. Certification criteria include: material reutilization and design for the environment; energy; water, and social responsibility. The program focuses on products whose materials are perpetually circulated in closed loops, thus cradle to cradle.

A series of insulated metal composite panels have met, or exceeded, certification criteria. These insulated metal composite panels have several characteristics that may help a building qualify for credits within the U.S. Green Building Council’s Leadership in Energy and Environmental Design (LEED®) Green Building Rating System, including:

In an increasingly risk-prone environment, design professionals must have a broad understanding of building envelope design and construction.

Photo credit: Centria

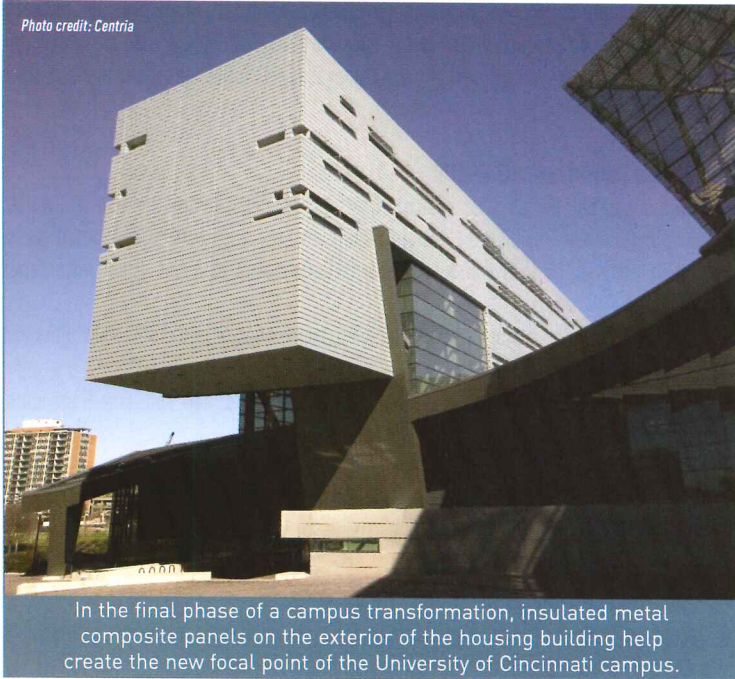

In the final phase of a campus transformation, insulated metal composite panels on the exterior of the housing building help create the new focal point of the University of Cincinnati campus.

Innovative ATMP solutions involve insulated metal composite panels that are installed outboard of a building's metal studs. Available systems can be utilized individually as a complete exterior wall system or combined with other exterior aesthetic panels for a superior multi-component wall solution. ATMP is important because many city, state, and national codes are requiring better thermal barriers within the building envelope, as energy conservation continues remain a priority.

Even the smallest leak in an air or vapor barrier can be a potential source for moisture control failure. Air and pressure alone can cause significant amounts of moisture-laden air to flow through cuts, rips, and staple penetrations. The moisture can condense and remain inside the wall cavity, damaging materials, and thus creating an environment for mold, which causes other problems.

Liability Issues

Mold concerns and related health issues linked to this fungus have been the central issue of many lawsuits. The Insurance Information Institute estimates that \$3 billion in building mold claims were paid in 2002. Specifying an insulated metal composite panel system engineered for superior thermal performance and moisture control will significantly reduce mold-related risks for owners, occupants, and design professionals.

There is another reason that specifying such systems will further reduce risk and liability. "Insulated metal composite panel construction requires one supplier and installer, so the need for multiple trades, contractors, materials, and manufacturers on the jobsite is significantly reduced. In other types of construction, if leaks occur, it's hard to determine who is responsible for the faulty work or installation. High performance insulated metal composite panels eliminate this potential scenario, thereby reducing risk and liability concerns for owners and architects," said Rick Brow, Director of Marketing, CENTRIA Architectural Systems, Moon Township, Pennsylvania.

Insulated metal composite panel systems are suitable in new construction and renovations, in all climates. In addition to sustainability, superior thermal and moisture protection performance, and reducing mold concerns, they offer aesthetic qualities as well. Insulated metal composite panel systems are available in a variety of finishes, colors, shapes, and profiles with reveals, curves, and other design options that meet technical criteria, testing standards, and national codes.

- **Tested insulation value:** Based on independent testing, insulated metal composite panels show low U-values, ranging from 0.050 to 0.076 (lower is better). This series of metal composite panels provides superior insulating value that can result in significant energy savings.
- **High recycled content:** Based on the LEED®-NC Reference Guide, this panel series has an average post consumer recycled content of 16 to 19 percent, and an average post industrial recycled content of six to seven percent, for a total recycled content of 22 to 26 percent.
- **Low-emitting materials:** A factory-applied sealant may have a volatile organic compound (VOC) below the limit established by LEED®.
- **Reduced jobsite scrap:** Pre-fabricated panels made in the factory result in little to no jobsite scrap generated, since field cutting of the panels is generally not required. Products that are shrink-wrapped eliminate wasteful crating and packing materials.
- **Regional materials:** LEED®-NC (for new commercial construction and major renovation) provides credits for products manufactured within 500 miles of the project site. In many instances, this criteria is achievable for insulated metal composite panels systems.
- **Sustainability:** Insulated metal composite panels replace multiple materials with one-piece panels, reducing jobsite scrap and minimizing the fuel consumption multiple freight deliveries would require. The durability and advanced thermal and moisture protection qualities of insulated metal composite panels promote energy efficiency and reduce maintenance demands.
- **Durability:** Insulated metal composite panels are durable, low maintenance, and decrease the need for water-washings or toxic chemical cleanings. A product life cycle averaging 20 years or more minimizes the need for replacement.
- **Energy costs:** Reflective coatings are typically available for high solar reflectance, potentially resulting in lower building cooling costs.

Photo credit: Centria



Insulated metal composite panels with an aggregate coating create the appearance of pre-cast on the exterior of the Parkwest Medical Center in Knoxville, TN.

Thermal and Moisture Protection

Advanced thermal and moisture protection (ATMP) refers to building envelope wall systems that provide superior thermal and moisture control, especially when compared to traditional wall systems.



Photo credit: W&W Glass

The Mall at Millenia, in Orlando, Florida, uses point supported bolted glass to maximize transparency between the outdoors and the indoor retail environment. Architect: JPRA Architects

Point Supported, Bolted Glass: Maximizing Transparency

Building envelope materials and systems can enhance dramatic interior spaces, such as lobbies and public assembly areas, by maximizing natural daylight and visibility to the outdoors. Point supported, bolted glass systems provide maximum transparency to large expanses of the building envelope. This bolted glass system relies on mechanical fasteners to connect the glass to the structural frame, without mullions.

The point supported, bolted glass system is comprised of glass, fittings, and structural supports. Each element has many options, to meet the design solution for various applications. Structural glass façades rely on the quality of the glass for their performance and aesthetics. An extensive range of glass types can be used with this system, for flexibility of design, appearance, performance, and transparency, such as tempered, laminated, coated, insulating, high performance energy efficient, acoustical, and solar glass.

Structural elements that work with the system include stainless steel cables, space frames, simple steel pipes and tubes, and elaborate prefabricated trusses. The fitting is critical, to ensure loads are transferred to the structural elements supporting the glass.

Point supported, bolted glass is a flush glass application using a countersunk bolt in the glass that is bolted to the building structural system. This method provides a flush glass surface using countersunk holes, and stainless steel fittings to connect the glass façade to the structure, instead of the conventional framing systems. The result is an engineered system with minimum of structure and maximum visual clarity. A silicone seal between adjacent panels provides weatherproofing.

These systems are suitable for various applications and projects of all sizes and budgets, not only for monumental, iconic buildings. Successful applications include airports, high-rises, cultural facilities, shopping malls, courthouses, universities, hospitals, and corporate headquarters.

Design and Performance Benefits

The point supported, bolted glass system is suitable for new construction and renovation, in any climate zone. Flexibility of design options enables architects to use tinted glass, silkscreen patterns, various colors, as well as large spans of glass. Other advantages include:

- Ability to glaze in any plane, up, over and under, from canopies and roofs to skylights and soffits, without metal framing.
- Enhanced thermal and optical performance, with the use of soft coat Low-E products, to provide better thermal insulation and solar control.
- Acoustical high performance.
- Impact resistance, and tested for various conditions and codes.
- Blast resistance, through the use of specially engineered connections and high-strength laminates.
- Resistance to high winds and seismic loads.
- Design for peak performance properties, including for a super typhoon, equivalent to a Category 5 hurricane in the Far East, for over 200 psf pressure.

This glass system has been tested for hurricane impact in Broward County, Florida. Based on updates to the Florida Building Code, as of Summer 2006, additional test results are pending.

Recent Developments

Bolted glass products have three new and innovative developments, impacting performance and aesthetic qualities.

New technology has allowed the countersunk bolts to be hidden, concealed, or sunk in the glass panel, further eliminating the use of metal. The result enhances the overall look of the glass façade.

Bolted structural glass is fully tempered for strength. New tempering technology is available to create glass that is flatter, and minimize waviness, known as roller wave

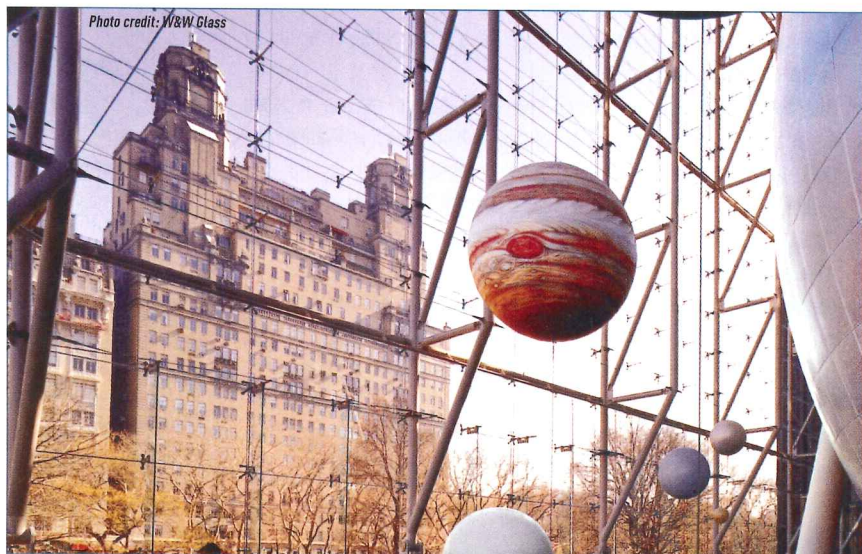
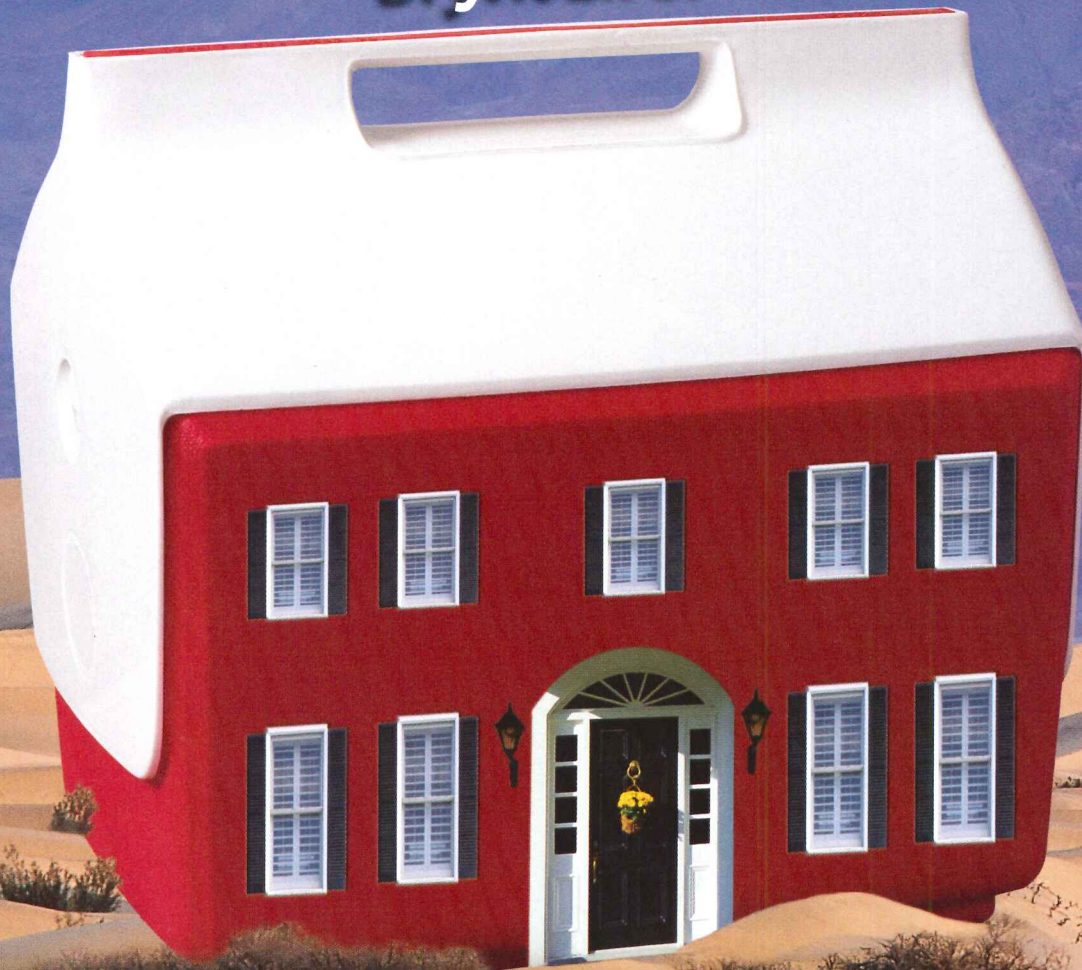

Photo credit: W&W Glass

Point supported bolted glass allows visitors to enjoy natural daylight at the Rose Center for Earth & Space, American Museum of Natural History, New York City. Architect: Polshek Partnership LLP

Dryvit EIFS.



Equal parts insulation and inspiration.



Your clients will thank you after they see their home. And they will thank you again when they see their first energy bill. Beautiful exteriors and up to 40% savings on heating and cooling costs? It's hard not to be inspired by that.

To find out more, visit our new residential web site at www.DryvitHomes.com.

dryvit® 

An **RPM** Company

CIRCLE 45 ON READER SERVICE CARD OR GO
TO ARCHRECORD.CONSTRUCTION.COM/PRODUCTS/



perfect fit

What if the glass and metal needs on your next project were engineered to integrate seamlessly from one source? Now they can be! **Introducing Oldcastle Glass® Envelope™**. Architectural glass, operable windows and curtain wall, all designed to work together in perfect harmony. And only **Oldcastle Glass®** can pull it off. So how do we do it? Simple! We're the only curtain wall and window manufacturer that truly understands glass.

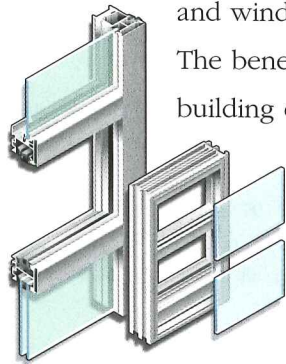

The benefits? Better buildings for starters. Add to that, seamless building envelope solutions and project management all under one roof. When your project calls for **architectural glass, curtain wall and windows**, rely on Oldcastle Glass® to orchestrate it. Call **1-866-OLDCASTLE** (653-2278) or visit the new **www.oldcastleglass.com**.



Sky Condo in Las Vegas, Nevada features curtain wall, operable windows and architectural glass—all from Oldcastle Glass®. Architect: Klai Juba Architects.



Oldcastle Glass® *Where glass becomes architecture™*

CIRCLE 46 ON READER SERVICE CARD OR GO
TO ARCHRECORD.CONSTRUCTION.COM/PRODUCTS/



distortion. During the tempering process, glass softens as it gets hot. Newer tempering furnaces and technology can limit roller wave distortion, thereby improving the optical qualities of tempered glass.

Newer quality control measures and techniques will reduce nickel sulfide, and thereby limit breakage. Nickel sulfide is a contaminant inherent in heavy float glass, which is typically 12mm (about a half-inch) thick, or greater. During the tempering process, contaminants are trapped and can expand, causing spontaneous breakage. The goal during quality control is to limit and catch the nickel sulfide in the glass, and create a safer product through what is known as the heat soaking process.

“These products need complete, fully engineered systems in order for the owner to obtain their full benefit. The glass and related hardware fittings go together, and should ideally be from the same source, not different systems with different warranties, which increases risk to the owner and design professionals,” says Jeffrey Haber, Managing Member, W&W Glass, LLC, Nanuet, New York.

To avoid these potential problems, specifications should indicate a single source approach for furnishing and designing the system, to ensure that one manufacturer is responsible for engineering and glass production. This will provide better integration of all system components and warranties, and minimize risk and liability.

As in other building envelope systems, it is important that compatible elements perform to specified loads, meet aesthetic criteria, and don't leak or become maintenance problems over the building and product life cycle, which generally ranges from 20 to 50 years.

Curtain Wall and Ribbon Window Systems

Architectural product manufacturers are increasingly developing systems comprised of compatible components that often provide many advantages. Another approach to this trend involves the use of curtain wall and ribbon window systems, utilizing aluminum fenestration. Curtain walls refer to a system that does not carry any dead load from the building other than its own weight. The loads are generally transferred to the main structure through connections at floors and building columns. Curtain walls are designed to resist air and water infiltration, and span multiple floors. Ribbon windows are horizontal architectural elements that are located around the building façade on a per floor basis.

“Building envelope systems must be designed with the goal of reduced field labor costs, greater thermal efficiency, and more flexibility for off-site assembly, sealing, and glazing. This will result in savings that can be passed on to building owners,” says Greg Hall, Senior Product Development Designer, Vistawall Architectural Products, Terrell, Texas.

A new high-performing pressure-equalized curtain wall system features exceptional water control, outstanding thermal performance, straightforward fabrication techniques, and easy installation. Several new related curtain wall framing systems share many common parts, such as gaskets, setting blocks, face members and anchors. This common chassis allows architects to combine two applications, curtain walls and ribbon windows, from a single system on the same building. These compatible parts allow easy transitions to occur between curtain wall and ribbon window details, design features, and construction installation. Use of common members and components between systems reduces construction errors and costs, and simplifies site fabrication.

Among the curtain wall and ribbon window systems, even more variations are available, such as a traditional pressure wall system, composite vertical mullion with traditional pressure wall horizontal members, and inside-glazed curtain wall, utilizing composite mullions throughout. These systems are typically available to meet a range of performance and thermal efficiency criteria. For maximum flexibility, these systems also share a common platform, the same glazing pocket design. This allows easier transitions from one system to another in the same project.

Curtain wall systems that offer excellent thermal performance can provide lower energy costs to building owners and tenants, and add to a project's sustainability features.

Some new curtain wall systems utilize composite mullions, which offer several advantages. They include better thermal performance, decreased field labor due to factory-assembled one-piece design, and reduced glazing time due to elimination of screw-applied temporary glass retainers.



Reynobond[®]
with KEVLAR[®]



See for yourself at www.reynobond.com/kevlar

Now there's a panel system that can stop hurricane-propelled debris in its tracks. *Without a backer board.* Introducing new Reynobond with KEVLAR[®]—an innovative panel solution that combines all the weight and flexibility benefits the industry has come to expect from Reynobond with the impact-resistant strength that can come only from KEVLAR[®]. Visit our website today to see how Reynobond with KEVLAR[®] stands up to Miami-Dade testing requirements. It's footage that really makes an impact.

Dedicated to your success.



Alcoa Architectural Products • 50 Industrial Boulevard • Eastman, GA 31023-4129 • 478.374.4746 phone • www.alcoaarchitecturalproducts.com

©2006 Alcoa Architectural Products. Reynobond[®] is a registered trademark of Alcoa Inc. KEVLAR[®] is a registered trademark of E. I. du Pont de Nemours and Company and is used under license by Alcoa Architectural Products.

CIRCLE 47 ON READER SERVICE CARD OR GO
TO ARCHRECORD.CONSTRUCTION.COM/PRODUCTS/

The inside-glazed version of the composite mullion curtain wall offers added benefits of glazing the system from inside the building. This feature eliminates the need for scaffolding, along with the safety risks and field installation costs, and further improves thermal performance. These curtain wall systems are suitable for projects in all climates, year round.

Flexibility of design options is another aspect that allows design professionals and specifiers to address finishes, sunshade systems, loading capabilities, horizontal mullions, and various tools for LEED® certification under the U.S. Green Building Council's LEED® Green Building Rating System.

A new ribbon window system provides a high level of thermal performance, and offers many accessories to accommodate various door framing and anchoring options. High performance criteria include levels of air infiltration, static water, deflection load, structural load, sound transmission class (STC), thermal performance, and testing results and certifications by recognized industry organizations, such as the National Fenestration Rating Council (NFRC).

Seamless Building Envelope Solutions and Solar Glass

Innovation can apply to the way services are delivered, as well as to new and different methods of using technology, materials, and products. Delivering quality products and services in the building industry is generally dependent on effective project management, and meeting budgets and schedules. When manufacturers meet project targets, they provide enhanced value to building owners and design professionals, in addition to the high performance characteristics inherent in the building envelope products they provide.



Four Seasons Hotel & Tower, Miami, Florida.
Architect: Bermello, Ajamil & Partners
and Gary Edward Handel Associates.

Multiple vendors, trades, installers, and contractors can complicate project coordination, especially when glass, metal, and storefront window suppliers and different warranties are involved. Each additional party and company involved during the design, construction, manufacturing and testing process adds more risk to projects, as well as potential costs and scheduling challenges.

"Providing a one-stop, seamless building envelope solution to owners, architects

"When the Gulf Coast was hit by Hurricanes Katrina and Rita, flying debris caused significant damage, in addition to the flooding. Some building envelopes held up better than others."
- Doug Ashe, AIA

and design professionals can significantly streamline construction management. The benefits of this approach include reducing the number of vendors, better delivery coordination, minimizing procurement delays, and the ability to provide a single warranty for the entire system. All of these factors mean less risk during construction, faster project completion, and lower total project costs," says Deep Bhattacharya, Vice President of Business Development and Technology, Oldcastle Glass, Inc., Santa Monica, California.

Architectural elements considered part of building envelope solutions include curtain wall systems, skylights, operable windows, storefronts, doors, and structural glass walls. Additional elements that are part of the building envelope include glass canopies, metal panels, revolving and sliding doors, and related engineered products.

Energy Efficiency Through Solar Control Glass

With energy costs rising steadily, the need to control solar heat gain and maintain energy efficient buildings that provide occupant comfort and aesthetics is an opportunity for innovation.

A new type of neutral color solar control glass allows sunlight to enter a space, without accumulating heat gain, through a combination of high performance solar control and visible light transmittance. This solar glass can provide significant reductions in energy costs, and heating, ventilation, and air conditioning (HVAC) equipment expense. Solar glass also reduces harmful ultraviolet rays that can discolor fabrics and finishes, causing them to fade, so interior furnishings will look better over time.

The Light to Solar Gain (LSG) value of solar glass far outperforms high performance solar control Low-E glass, and clear insulating glass, at values of 2.14, 1.44, and 1.12 respectively. The higher the LSG value, the better the glass performs at transmitting daylight and reducing heat gain from the sun.

These qualities contribute to the sustainability of solar glass, from energy efficiency and maximizing the use of natural daylight to minimizing ultraviolet rays and enhancing occupant comfort.

Hurricane Impact-Resistant Glazing

Glazing has always been vulnerable to the high winds and flying debris that occur during hurricanes. High performance hurricane impact-resistant glass can withstand 140 miles per hour (mph) winds, along with high-speed projectiles and debris, including design pressures in excess of 100 pounds per square foot (psf). These standards are tested and proven by independent laboratory results.

Hurricane impact resistant glazing meets the most stringent building codes for large glazed openings up to 50 sq. ft. in residential and commercial applications. This results in an aesthetic and functional design solution that provides peace of mind for owners and architects. ■

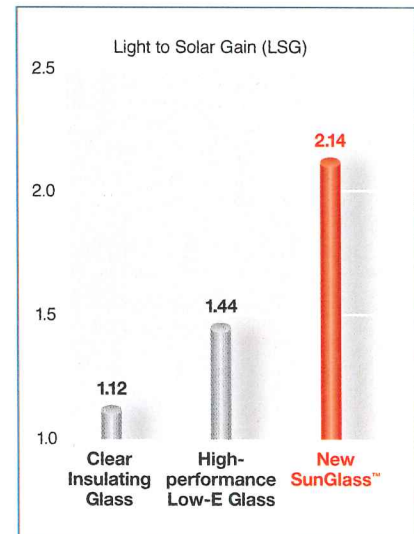

One company ...
taking a wider view.

VISTAWALL
ARCHITECTURAL PRODUCTS

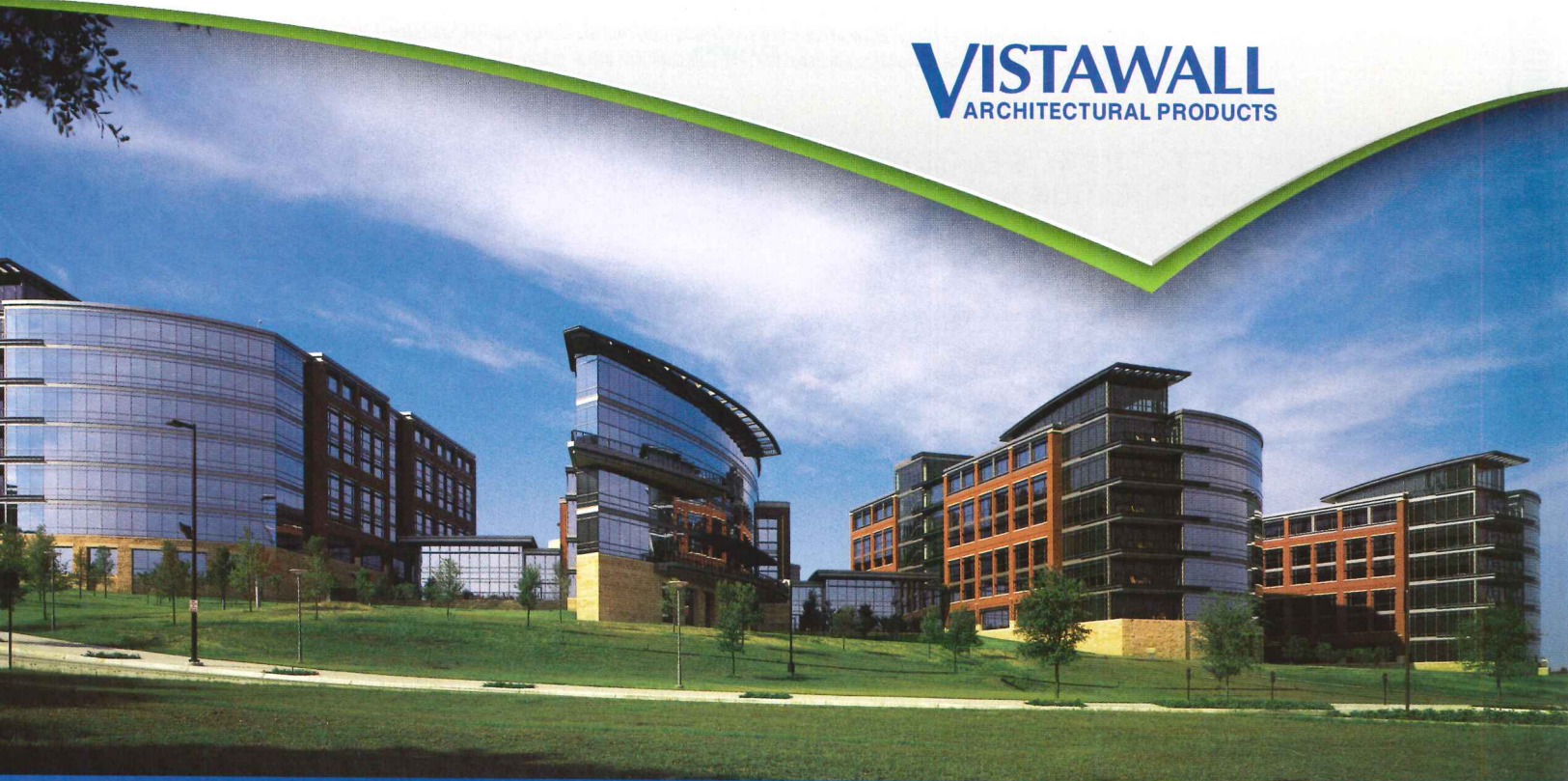

RadioShack® Corporate Headquarters – Fort Worth, TX
Architect: HKS, Inc. – Dallas, TX

Our wide range of products covers the full landscape of design possibilities.

From grand entrances to grand views, sunny atriums to airy offices, Vistawall Architectural Products has it all covered, with custom **Vistawall** curtain walls, entrances and storefronts, plus our popular **Moduline** window systems, **Naturalite** skylights and **Skywall** translucent systems. And with streamlined production, aesthetic consistency, precise structural integration, on-spec performance and peerless project management, we've covered all the other bases, too. When you're selecting products for the exterior of your next building, give us a call.

Vistawall Architectural Products

1.800.869.4567 • vistawall.com

A BlueScope Steel Company

CIRCLE 48 ON READER SERVICE CARD OR GO
TO ARCHRECORD.CONSTRUCTION.COM/PRODUCTS/

CLICK FOR ADDITIONAL REQUIRED READING

The article continues online at <http://www.archrecord.com/resources/conteduc/archives/0608building-1.asp>
To receive AIA/CES credit, you are required to read this additional text. The quiz questions below include information from this online reading.

AIA/ARCHITECTURAL RECORD
CONTINUING EDUCATION Series

LEARNING OBJECTIVES

After reading this article, you should be able to:

- Evaluate the latest materials, technology, architectural components, and related systems that comprise the building envelope.
- Identify performance characteristics and qualities that are important considerations during building envelope design, specification, and construction.
- Explain how to minimize risk and liability when approaching design, specification, and selection of building envelope products and systems.
- Analyze the sustainability benefits and attributes of various building envelope products, systems, and performance criteria.

INSTRUCTIONS

Refer to the learning objectives above. Complete the questions below. Go to the self report form on page 212. Follow the reporting instructions, answer the test questions, and submit the form. Or use the Continuing Education self report form on *Record's* web site—archrecord.construction.com—to receive one AIA/CES Learning Unit including one hour of health safety welfare credit.

QUESTIONS

1. Thermal and moisture protection performance criteria are important to building envelope design because of all except which of the following?
 - a. Leaks in an air or vapor barrier can be a potential source for moisture control failure.
 - b. Many city, state, and national codes are requiring better thermal barriers within the building envelope
 - c. Mold and health concerns are unrelated to thermal and moisture protection, and liability.
 - d. Moisture can condense and remain in the wall cavity, creating an environment for mold to grow.
2. What are the three elements comprising point supported, bolted glass systems?
 - a. Countersunk bolts, prefabricated trusses, mullions
 - b. Storefront stainless steel frames, concealed bolts, tempered glass
 - c. Heavy float glass, concealed hinges, aluminum space frames
 - d. Structural supports, glass, and fittings
3. Attributes of composite mullion curtain wall systems include all except which of the following?
 - a. Can only be inside-glazed under certain climate conditions
 - b. Decreased field labor
 - c. Better thermal performance
 - d. Reduced glazing time
4. The Light to Solar Gain (LSG) value of solar glass outperforms high performance solar control Low-E glass and clear insulating glass.
 - a. True
 - b. False
5. Aluminum composite material with high strength organic fiber is designed to withstand which condition?
 - a. Exploding vehicle bomb near large window expanses of a blast curtain wall
 - b. Bullets and blasts originating within 30 feet of the building envelope
 - c. Category 4 hurricane, wind speeds to 155 mph
 - d. Category 3 hurricane, wind speeds to 130 mph
6. Which best describes the main function of aluminum composite material with high strength organic fiber?
 - a. Bullet resistance for exterior cladding systems on buildings considered to be terrorist targets.
 - b. Protect building facades from the impact of flying debris during hurricanes.
 - c. Provide blast resistance protection from vehicular bombs outside a building.
 - d. Allow large expanses of insulated or solar glass to be installed 30 feet above ground level.
7. Liquid applied flashing systems create a seamless condition because:
 - a. The components form a chemical bond.
 - b. The liquid is applied to a peel and stick membrane and then cures.
 - c. The components form a mechanical bond.
 - d. Only highly trained, certified laborers can install it.
8. Which of the following is *not* a factor that typically leads to greater liability and risk?
 - a. Thermal performance and moisture control
 - b. Different warranties from different manufacturers within a single system
 - c. Multiple trades, contractors, materials and manufacturers on the jobsite
 - d. One source for multi-component building envelope systems
9. Recent developments relating to point supported, bolted glass include all except which?
 - a. Concealing countersunk bolts
 - b. Increasing nickel sulfide content, to strengthen glass and reduce breakage
 - c. Create safer heavy float glass through the heat soaking process
 - d. Minimizing roller wave distortion
10. Which of the following statements is not true about insulated metal composite panels?
 - a. When engineered for thermal performance and moisture control, they can reduce mold-related risks.
 - b. Pre-fabricated panels typically reduce job site scrap.
 - c. Approximately \$3 billion in building mold related claims were paid in 2005.
 - d. Reflective coatings for high solar reflectance on building envelope systems can lower building cooling costs.

The World's Leading Structural Glass System



Pilkington Planar™

- GLASS FIN WALLS
- TENSION STRUCTURES & CABLE NETS
- ROOFS, SKYLIGHTS & CANOPIES

CIRCLE 49 ON READER SERVICE CARD OR GO
TO ARCHRECORD.CONSTRUCTION.COM/PRODUCTS/

Providing Structural Glass Solutions For Over 30 Years



W&W GLASS, LLC

800.452.7925 wwglass.com





21st Century Building Envelope Systems
PRODUCT REVIEW



Vistawall

Vistawall introduces versatile Reliance™ curtain wall system, Terrell, TX-Vistawall Architectural Products recently introduced Reliance Curtain Wall, a new high-performance, pressure-equalized curtain wall system. The new zone-glazed system features outstanding water control and thermal performance.

Using the latest in trends in glazing, Reliance offers competitive pricing, labor saving and simplified installation. The system meets current specifications that require high-performance curtain wall and is ideal for low-rise, mid-rise and even high-rise buildings.

One of the greatest features of Reliance Curtain Wall is its versatility. It includes an integral anchor for sunshades, and photovoltaic cells can be integrated into Reliance. Vistawall also engineers a blast-resistant curtain wall using the Reliance system.

Reliance Wall is offered as 1-inch infill system, with snap-in adaptors for 1/4-inch infill for spandrel applications, as well as complete 1/4-inch infill systems.

Vistawall Architectural Products, a BlueScope Steel Company, is a leading supplier of architectural building products, including curtain wall systems, storefront and entrance systems and window systems. The company is a single-source supplier. Its capabilities include engineering, extrusion, fabrication, finishing and performance testing.

CIRCLE 100



W&W GLASS

W&W Glass, LLC selected as glazing subcontractor for Julliard School of Music and Alice Tully Hall at Lincoln Center.

W&W has been awarded a design assist contract to provide structural glass walls, aluminum curtain walls and storefronts for the renovation and expansion of the Julliard School and Alice Tully Hall as part of the renovation of Lincoln Center in New York City.

Highlighting W&W's work will be a 38' high cable net facade featuring 10,000 s.f. of the Pilkington Planar™ System with their proprietary "integral" fitting. In addition to the cable net, Pilkington will be providing a cantilevered glass fin system utilizing high performance Low E coated insulated glass.

The architects are Diller Scofidio + Renfro/FX Fowle. Turner Construction is the construction manager.

Project completion is due mid-2008.

CIRCLE 101



Dryvit

The best liquid applied flashing and membrane available to protect your building.

Dryvit offers the best solution for EIFS substrate protection. AquaFlash®, a revolutionary liquid applied flashing system, provides optimal protection for building openings. When used in conjunction with Backstop NT®, a liquid weather-resistant membrane that prevents water penetration and eliminates air infiltration, you achieve the ultimate in substrate protection.

CIRCLE 102

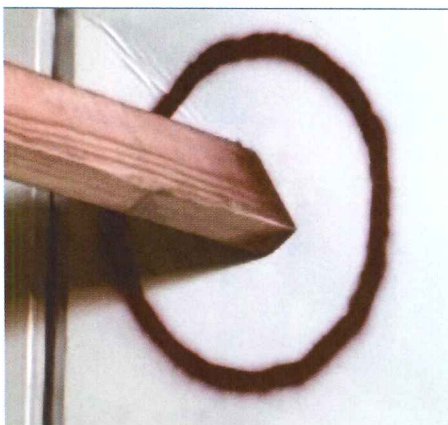

Alcoa

Introducing New Reynobond with KEVLAR®

Reynobond with KEVLAR® is an innovative panel solution that combines all the weight and flexibility benefits of Reynobond with the impact-resistant strength that can only come from KEVLAR®. Visit www.reynobond.com/kevlar today to see how Reynobond with KEVLAR® stands up to Miami-Dade hurricane testing requirements.

CIRCLE 103

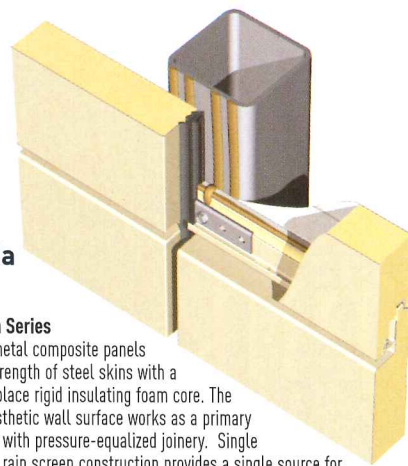

Centria

Formwall Dimension Series

Insulated metal composite panels offer the strength of steel skins with a foamed in place rigid insulating foam core. The exterior aesthetic wall surface works as a primary rain screen with pressure-equalized joinery. Single component rain screen construction provides a single source for all wall cavity components, eliminates trade jurisdiction problems and creates a solution for all climates.

CIRCLE 104

Oldcastle

Solar Control Glass

Exclusive, new SunGlass™ Solar Control Glass delivers the beauty of the sun without the heat. Now architects can specify a neutral color glass that invites the sun in without making building occupants sweat. That's because SunGlass™ delivers a combination of unprecedented solar control and visible light transmittance. It's the look you want with the performance you need.

CIRCLE 105

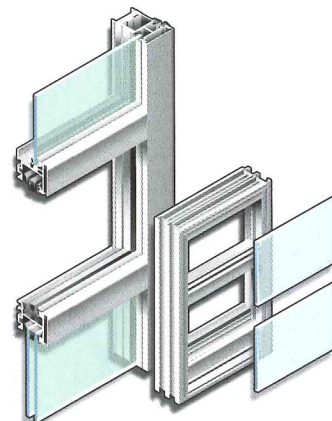

DO YOUR
DESIGNS
PUSH THE
BUILDING
ENVELOPE?

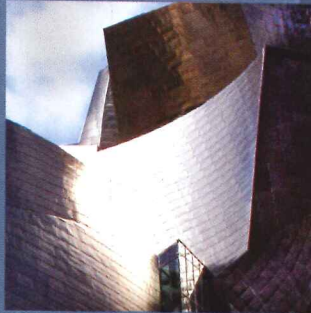

Or do you
take a more
conservative
approach?

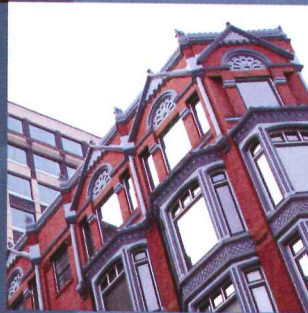

The National Council of Architectural Registration Boards' monograph, *Building Envelope*, offers an overview of the design and construction of conventional building envelopes as well as a detailed introduction to the changing expectations of building envelopes and the factors that distinguish them. The course includes two case studies and an extensive resource listing.

Order online; take the quiz online.

To order *Building Envelope* now, visit the NCARB web site at www.ncarb.org/envelope.

Building Envelope; 144 pages, 10 PDUs
Regular Price: \$215
NCARB Record Holder Price: \$135

The NCARB Monograph Series: The most cost-effective way to earn health, safety, and welfare PDUs or AIA learning units available.

I N S I G H T



INNOVATIVE SOLUTIONS TO LIGHTING CHALLENGES



MASQUE™

ENLIGHTEN THE OUTDOORS

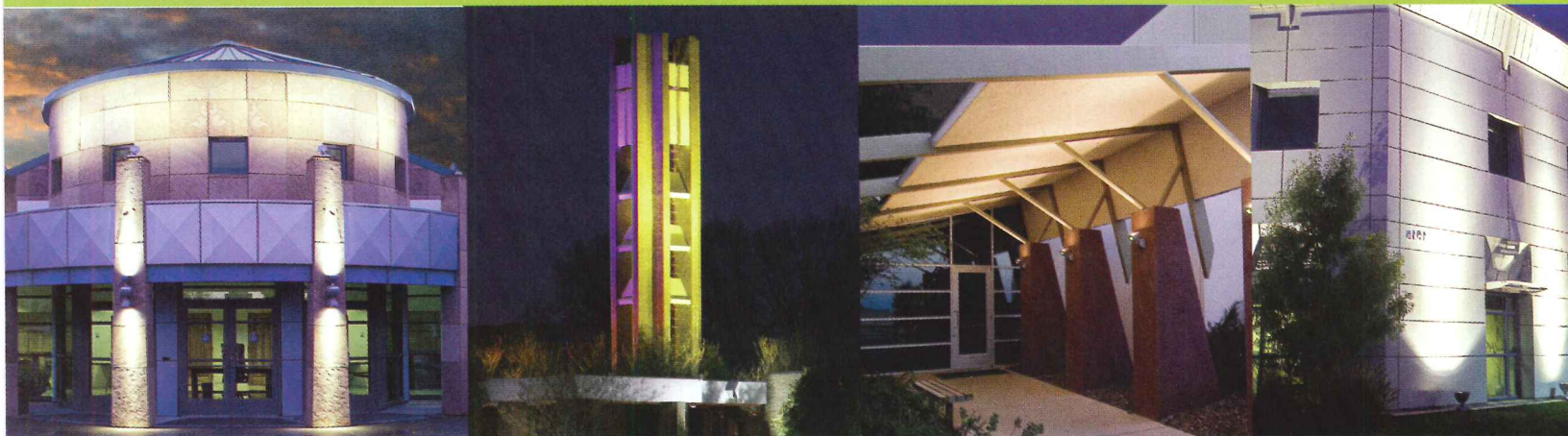

MASQUE™

A SINGLE FAMILY OF EXTERIOR LIGHTING PRODUCTS TO ACCENTUATE ARCHITECTURAL DETAILS, BUILDING FACADES AND CANOPY LIGHTING. FOUR SCALED LUMINAIRE SIZES, TEN DISTINCT OPTICAL SYSTEMS AND FORTY DIFFERENT LAMP CHOICES TO ACCOMPLISH A WIDE VARIETY OF APPLICATION REQUIREMENTS.

ILLUMINATED FASCIAS

IMAGINE THE ABILITY TO PERSONALIZE THE LIGHTING TASK BY INCORPORATING DISTINCT ARCHITECTURAL FEATURES OR CORPORATE LOGOS ONTO THE ILLUMINATED FASCIA OF A MASQUE FIXTURE.

INSIGHT LIGHTING - THERE IS NO SUBSTITUTE FOR INTEGRITY

CIRCLE 51 ON READER SERVICE CARD OR GO
TO ARCHRECORD.CONSTRUCTION.COM/PRODUCTS/



I N S I G H T
505.345.0888
www.insightlighting.com

Lighting

From sleek Italian luminaires to improvised LED bubbles, pixels of light provide aesthetic punch

BRIEFS

Sustainable lighting design was honored on May 31 for the first time as part of the annual honors program presented by the International Association of Lighting Designers (IALD). **Renzo Piano's High Museum of Art** expansion in Atlanta [RECORD, November 2005, page 131], with lighting by Arup, garnered a top award of excellence, in addition to winning the sustainable prize. The IALD instituted the category in 2004, but this was the first year in which the judges felt an entry "met the qualitative needs of the visual environment with the least impact on the physical environment." Of the 23 projects recognized with awards this year, two projects merited awards in a new **residential lighting** category: The Briar Cliff Residence, in Kansas City, with lighting by Derek Porter Studio; and the Penthouse at the Four Seasons in San Francisco, with architectural illumination by H.E. Banks and Associates. For photos and descriptions of all the winning projects, go to www.iald.org.

CONTENTS

- 162 B&B Italia, Barcelona**
Flos
- 170 Diva Lounge, Boston**
Studio Luz
- 174 Mixed Greens, New York City**
Tillotson Design Associates
- 179 Lighting Products**

You may not have considered harnessing worm-eaten butternut wood as a filter for light. But for Boston's Diva Lounge, the young architecture firm Studio Luz recently fashioned reclaimed wood into banquettes, a bar, and a maître d' stand (below). Looming as a sculptural presence near the entrance, the stand sandwiches the porous wood veneer between sheets of laminated glass. Backlighting the structure with T5 fluorescents fitted with colored gels, the architects emphasize the organic nature of the wood and turn the scattering of holes into intriguing points of light.

The entire lounge, in fact, is enlivened by a similar improvisational approach to illumination. Partners Hansy Better Barraza and Anthony Piermarini wanted to create a luminous envelope for the nighttime bar and eatery. Assembling an armature of acrylic skylight domes to cover the walls and ceiling and backlighting them with colored LEDs, they created a custom effect on a budget from stock architectural materials. Each dome, or bubble, appears as a pixel of light mapping a sensory experience.

The Mixed Greens art gallery in Manhattan forgoes such colorful illumination, but employs a similarly monolithic lighting element. Tillotson Design Associates worked with architect Leven Betts Studio to mask mechanical ducts and pipes within the ceiling plane. Fluorescents set behind acrylic panels create an oversize light box that serves as a subdued canopy.

To orchestrate its new flagship furniture showroom in Barcelona, B&B Italia enlisted architects Patricia Urquiola and Martino Berghinz. Collaborating with the project design arm of the Italian lighting manufacturer Flos, the architects devised a ceiling plane that Urquiola also refers to as "a composition of pixels of light." Fixtures designed by Konstantin Grcic are set within rectangular coves that establish a visual rhythm overhead. The arrangement of the lighting was inspired by cutouts in a table Urquiola designed. Throughout the showroom, B&B Italia's first line of luminaires reveals its evolving role at the center of European design. *William Weathersby, Jr.*





A cluster of spherical Random Light pendants, designed by Bertjan Pot, floats near the main stairway. Downlights graze a metal partition seen through the double-height glazing of the facade (opposite).

Flos fulfills the luminous visions of Patricia Urquiola and Martino Berghinz at B&B Italia in Barcelona

By William Weathersby, Jr.

Since she founded her own multidiscipline studio in 2001, Spanish-born architect Patricia Urquiola has become a major force at the Milan Furniture Fair—the design star to watch. Each year she orchestrates trendsetting furniture lines for more than a half dozen leading manufacturers, in addition to plotting multiple temporary installations and showrooms. Expanding from her home base in Milan last spring, the prolific designer created a new flagship in Barcelona for the furniture manufacturer B&B Italia, for whom she has designed 11 series of tables and chairs over the past 5 years. Working with her frequent collaborator architect Martino Berghinz, Urquiola has created a space with a polish that matches the precision of her industrial designs. The showroom's white stone flooring, floating staircase, diamond-faceted walls, and mirrored surfaces create a fluid backdrop for high-style, contemporary furniture.

For the lighting of the 1,800-square-foot showroom, the architects collaborated with Flos, the Italian fixture manufacturer that also operates a commercial lighting design consultancy. In addition to illumination for B&B showrooms, the Flos team frequently collaborates with and works for the manufacturer's contract division that supplies furniture for hotels, restaurants, and offices.

"For the Barcelona showroom, the architects wanted crisp, flexible lighting that would make a strong impression without overpowering the bold lines of the furniture," says Luca Bolla, Flos designer in charge of the project. (He notes that Berghinz also has a particular affinity for architectural illumination, having designed fixtures for several manufacturers.) "There are areas when the lighting fixtures intentionally become the focus of the customer's eye, and in other places you barely notice them," he notes. With so many white surfaces and a wealth of mirror and glass, it was also important to evenly light the space while carefully focusing the lamps to avoid glare, Bolla adds.

As part of a recent expansion into lighting and accessories, B&B Italia has introduced several lines of table and floor lamps created by renowned European designers, such as Ettore Sottsass and Jean-Marie Massaud, that are showcased here. But the workhorses of the venue's display lighting are two highly tooled, low-voltage fixtures manufactured by Flos, their sleek profiles becoming a strong component of the overall aesthetic effect.

Encompassing 1,800 square feet within a historic building that was previously rehabilitated by architect Carlos Ferrater, the Barcelona showroom is centrally located on Paseo de Gracia in the Eixample district, a popular shopping destination for fashion and design. The new store is a step in B&B Italia's corporate strategy to open single-brand



stores in international cities; other locations with new flagships include Munich and Dubai.

In her furniture designs, Urquiola is best known for playful geometry: One new lounge chair's cover, supported by a painted or chrome-plated metal frame, is composed of triangular petals sewn together in combinations of felt, wool, and leather. The B&B Italia store is a similar assemblage of shapes. Rectangles, canted walls, and converging planes both reveal and shield sight lines.

Visitors enter through a double-height box of gray-frosted glass, which creates a prelude to the mostly white space. The two-story-high, street-facing window frames a towering screen made of two overlapping panels of metal fretwork, which serves as a backdrop for the main display area on the first floor. (Urquiola calls the screen "the chain-link fence," but it's more refined than that.) A grouping of Massaud's chrome-plated metal Delta floor lamps sits before a polished-plaster wall. Each lamp features a triangular shade with rounded corners that catches the eye with a shimmering surface—a combination of chrome-plated film and fabric. A display of the designer's Cubik lamps showcases each fixture's rectangular

Project: B&B Italia showroom, Barcelona

Lighting designer: Flos—Luca Bolla, principal designer

Architects: Martino Berghinz; Studio Urquiola—Patricia Urquiola, principal architect; Rodrigo

Izquierdo, associate

Architect of record: Ramón Cortés

Building architect: Carlos Ferrater

Project coordination: B&B Italia research and development center, with Studio Collage

Luminaires designed by Konstantin Grcic are set within "pixels" on the ceiling (right). Patricia Urquiola's modern spin on a Moroccan ottoman, called Fat Fat, sits in the foreground. The showroom also displays new floor and table lamps designed by international design stars, including Jean-Marie Massaud and Ettore Sottsass (below).



shade with a cloud pattern on a slender box frame of gun-metal-gray tubular steel. Atop a credenza, Sottsass's lamp, the Abat Jour, has a truncated cone base supporting a cylindrical shade of black glass.

Adjacent to the entrance, a floating staircase fabricated of solid, glossy white acrylic surfacing is framed by a cluster of pendants called Random Lights, designed by Bertjan Pot for the Dutch company Moooi. (B&B Italia took a 50 percent stake in Moooi last winter and is folding some of its lighting into B&B-branded showrooms.) In each fixture, white strands of epoxy-treated fiberglass surround a single incandescent bulb, floating like luminous, oversize balls of yarn. The underside of the staircase merges into a partial wall that does not meet the ground plane, an effect enhanced by downlighting on its underside.

The central architectural gesture of the store is the syncopation of the longitudinal wall that runs through the depth of the interior. The profile of the wall changes geometrically to appear like the facets of a diamond in some areas, while some canted planes pull away to create display

BOYD



BOYD LIGHTING 944 FOLSOM STREET SAN FRANCISCO CA 94107 TELEPHONE 415.778.4300 WWW.BOYDLIGHTING.COM
STUNNING NEW PENDANTS IN RICH DARKER FINISHES. CLOCKWISE FROM TOP LEFT: CRISSCROSS, PARISIAN, PALOS VERDES, PARASOL

CIRCLE 52 ON READER SERVICE CARD OR GO
TO ARCHRECORD.CONSTRUCTION.COM/PRODUCTS/



Throughout the showroom, Flos downlight units each feature four low-voltage lamps that can be tightly focused on furniture and accessories (above left and right). Illuminated with downlighting, a section of the wall beneath the staircase appears to float (below).



niches for accessories. The niches are illuminated by halogens fitted with dichroic filters. Furniture is grouped in residential vignettes along the main axis of the space, inviting customers to move through it.

The ceiling plane integrates two different models of Flos light fixtures, both designed by Konstantin Grcic, himself a Milan Fair critic's favorite whom the legendary industrial designer Achille Castiglioni called his "spiritual heir" [RECORD, September 2002, page 364]. The configuration of the ceiling was inspired by Urquiola's occasional table, named Digtale, designed in 2005 for B&B Italia, which features rectangular cutouts in a black- or white-painted aluminum surface, in a random pattern that evokes old computer punch cards. Rectangular boxes—Urquiola calls them pixels—dot the showroom ceiling, each enclosing a Herz 2 fixture. Each downlight houses four low-voltage lamps that can be tightly focused on display areas. "By hiding the lights in openings following a pixel-like pattern, the line of the ceiling is kept clean and a sense of height is added to the space," Urquiola says.

The luminaires were modified, with the length of the support bar shortened, in order to integrate the fittings inside the pixels. "A similar format was used to light the window displays, where the illumination levels needed to be more than the 500 lux of the ambient showroom lighting," Bolla says. To accent the window vignettes, five Herz fixtures each house AR111, 75-watt halogen sources. An additional 10 Herz fixtures are equipped with CDM-R111 metal-halide lamps yielding a color temperature of 3000K.

On the first level, in areas without double-height ceilings, 30 Magnum track lights from Flos house low-voltage, AR111, PAR20 lamps within polished aluminum casings. An additional 30 fixtures accommodate CDM-R111 metal halides for ambient lighting. Over the staircase, 11 Magnum track luminaires are also equipped with metal halides and focused at an angle of 40 degrees.

Throughout the showroom, the use of metal-halide lamps grants a high level of lumens per square foot with low energy consumption, while the halogen sources offer chromatic illumination that is closer to the ambience of daylight, according to Bolla. Aiding an interplay of reflections, transparencies, and changing volumes within the showroom, the lighting brightens B&B's Barcelona debut. ■

Sources

Recessed downlights, track lighting: *Flos*

Pendants: *Mooodi*

Table and floor lamps: *B&B Italia*

Additional lighting: *Daide Groppi*;

Antares

Solid surfacing: *LG HI-MACS*

For more information on this project, go to Lighting at

www.archrecord.com.

Think you can't afford Award Winning Classroom Lighting?

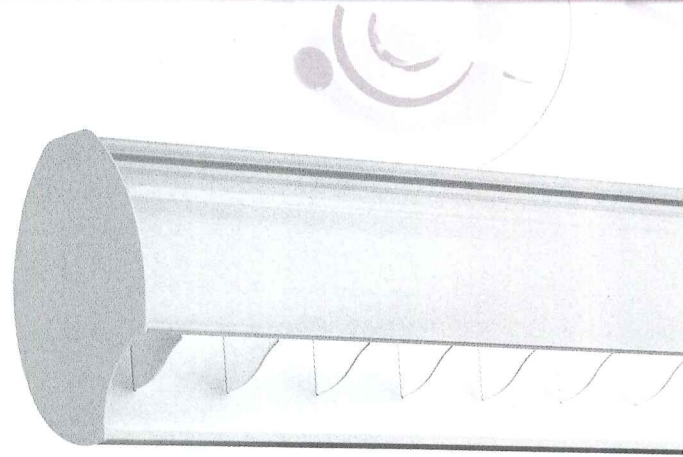

ICLS

- Award Winning

- Patent Pending Technology



Think Again!

Finelite's Integrated Classroom Lighting System

is **affordable**, delivers **energy savings 25-40%** beyond national standards, and features a **5-year single source warranty**. ICLS was rigorously tested in a state-sponsored study where **teachers preferred it 9:1** to existing systems. Visit www.finelite.com to see how quality indirect lighting, general and audiovisual modes, and easy-to-use controls make **ICLS** a powerful and effective teaching tool.

FINELITE

Better Lighting

www.finelite.com

CIRCLE 53 ON READER SERVICE CARD OR GO TO ARCHRECORD.CONSTRUCTION.COM/PRODUCTS/

You know Finelite for... Service • 10-day Shipping • Performance • Quality • Affordability...and now for Lighting Systems

Lighting. YOUR WAY.

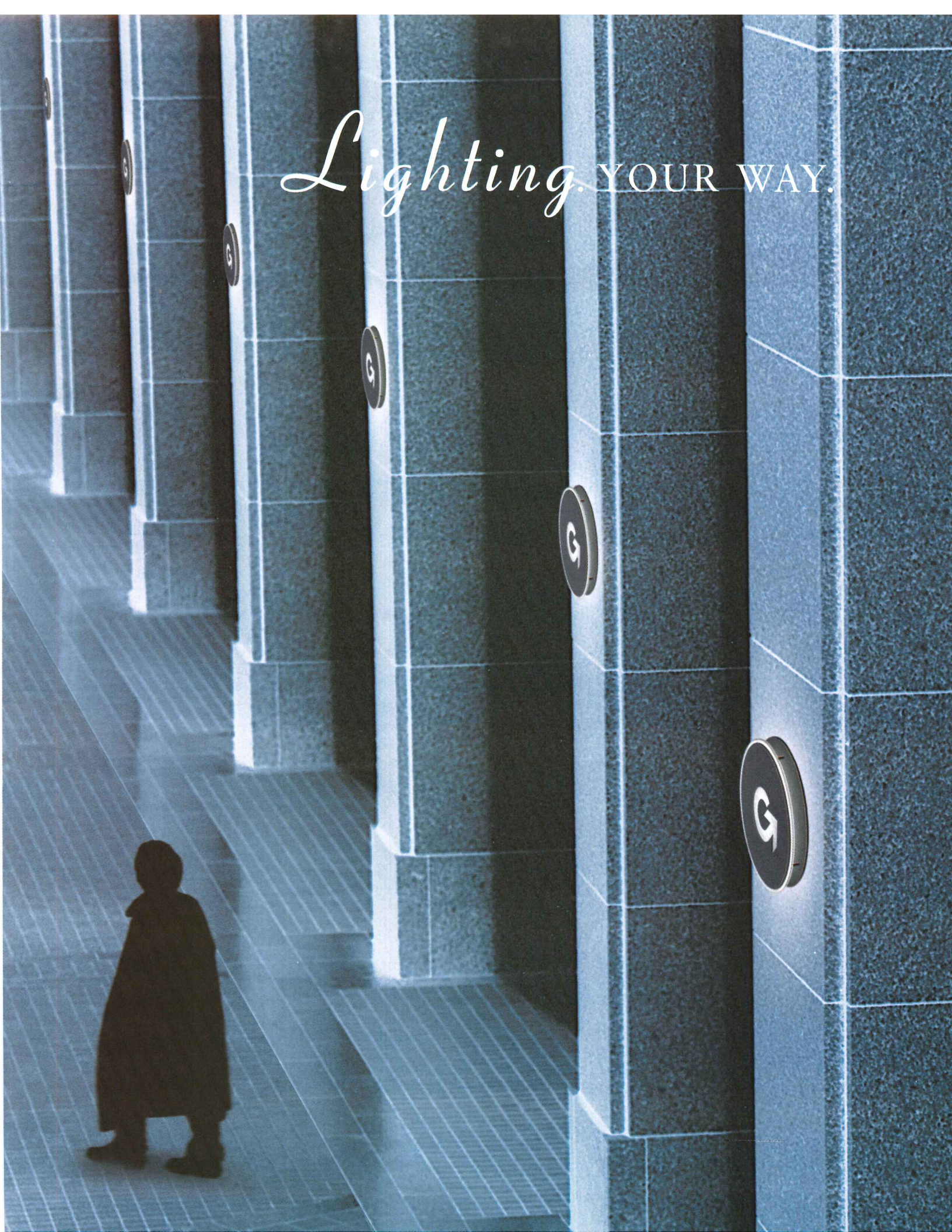

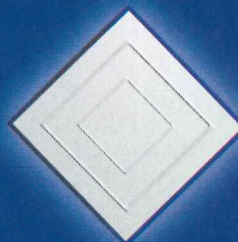
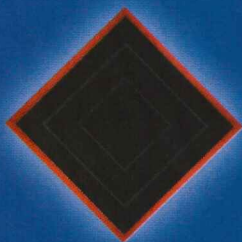
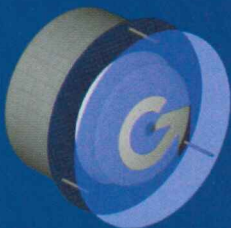
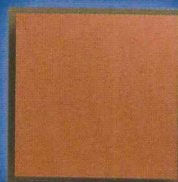
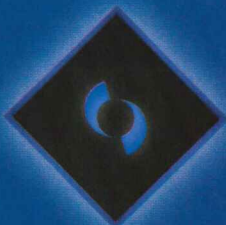
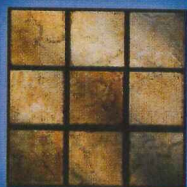

Fascia Plates are part sconce, part architecture, part decoration, part identity system and completely unlike any lighting system ever invented. You can select from one of many standards or use your own imagination to create a custom Plate. Custom versions can range from your client's logo to your unique idea. Architectural, practical, decorative, illuminating, inspirational and endlessly versatile, Fascia Plates are among all else... Gardco.



GARDCO
LIGHTING

www.sitelighting.com

CIRCLE 54 ON READER SERVICE CARD OR GO
TO ARCHRECORD.CONSTRUCTION.COM/PRODUCTS/



Studio Luz orchestrates a landscape of LED bubbles for Diva Lounge in Boston

By William Weathersby, Jr.

Boston-based architects Hansy Better Barraza and Anthony Piermarini are intrigued by the way lighting can visually shape space. In fact, the name of the firm the husband-and-wife team founded in 2001, Studio Luz, incorporates the Spanish word for “light,” reflecting their mutual obsession. As Barraza says, “Evocative lighting can heighten the sensuous aspects of an interior. We explore how the interplay of light, materials, and perspective can bring about a human connection to place.”

Often the architects employ unorthodox lighting techniques, rather than install standard fixtures. For their recent design of the restaurant OmBar, in Boston, for example, they backlit shards of glass set behind resin to achieve a fractured composition of shadow and light. At Diva Lounge, which debuted outside the city, in Somerville, last spring, they further elevated lighting’s role as a primary architectural element. Transforming a former grocery store in the Davis Square neighborhood into a nighttime lounge, the architects wrapped the entire space with a landscape of cloudlike lights. Patrons find themselves passing through zones of mysterious illumination that glow from white to red. The lighting creates an intimate enclosure where backlit occupants seem to be thrust to the foreground.

The 140-by-14-foot lounge was planned as an annex to Diva, the popular Indian restaurant next door. With 14-foot ceiling heights but few architectural details, the existing space called for a solution that could overcome the tunnel-like quality of the room. “We decided to create an architectural skin that ‘blushes’ with color, across billowing surfaces that introduce a sculptural effect,” Barraza says.

To create a syncopation of curved, illuminated surfaces along all the walls and the ceiling within a tight budget, the architects designed a metal framework to support 500 standard skylight domes, or bubbles, that act as translucent diffusers for LEDs set behind them. The architects enlisted technical consultant Daina Yurkus, principal of Light This!, to engineer and plot the lighting array.

The team specified four colors of low-voltage LEDs: white, amber, yellow, and red. Two strips of 24 LEDs are set behind each 24-inch square bubble. “The individual bubbles do not change color, but the arrangement of colors is abstractly based on the LED readout of a digital music player,” Piermarini says. More intense colors, such as red and amber, are concentrated near more active areas, such as the center of the bar. Behind the bar, two rows of the bubbles are set into the wall to accommodate perforated metal shelving within the concave openings.

Project: Diva Lounge, Somerville, Mass.

Architect/lighting designer: Studio Luz Architects—Hansy L. Better Barraza, Anthony J. Piermarini, AIA, principals; Michael Beaman, Jason Frantzen, Rachel Shauer, Shane Zhao, project team

Consultants: Light This!—Daina Yurkus, principal (technical lighting); Albert Costa Architect (codes)

Engineers: Ibrahim & Ibrahim Consulting Engineers (m/e/p); Zeroumian Associates (structural)

Contractor: IDS Construction

Backlit with LEDs, 500 acrylic skylight bubbles cover the walls and ceiling of the Diva Lounge. White, amber, yellow, and red lights create a visual pulse abstractly inspired by the readout of a digital music player.

PHOTOGRAPHY: © JOHN HORNER

The warmth of salvaged butternut wood used to fabricate the bar and banquette dividers contrasts with the cool glow of the lighting units (right). Additional glass-shaded pendants enhance ambient lighting in seating areas (below). Toward the rear of the lounge, bathrooms are enclosed in pods whose tactile plaster surfacing was achieved via molds surfaced with waffled bed-foaming material.

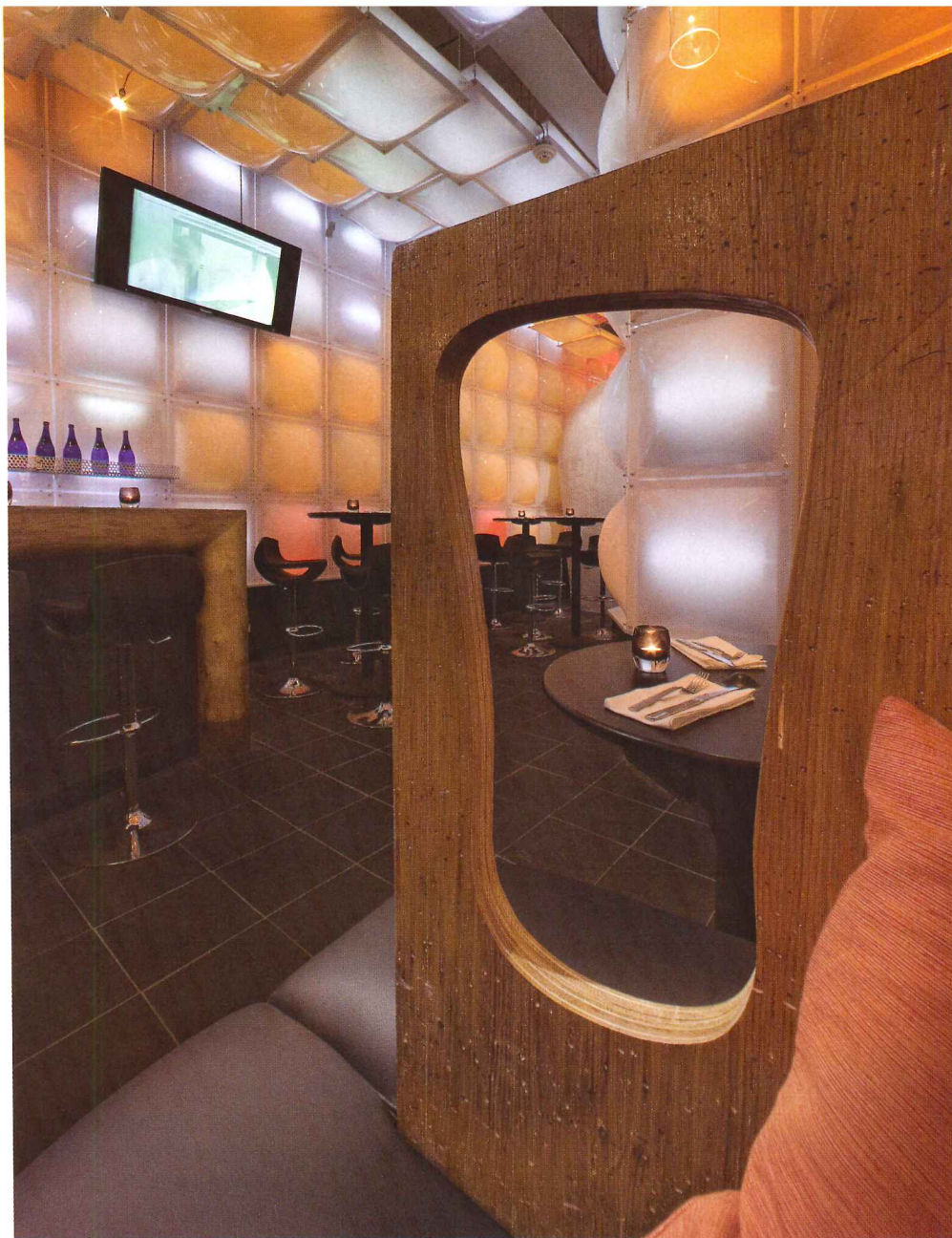

The grid of bubbles also perforates the facade to create a convex, pixelated surface. Additional glass pendants housing MR16 lamps graze seating areas, while downlights between the ceiling framework add ambient light.

Contrasting with the luminous bubbles, furniture elements are fabricated from distressed wood salvaged from worm-eaten butternut forests in Vermont. The bar is a single log, hand-peeled and carved to reveal a pattern of the wormholes within. For the host stand, wood veneer set between sheets of laminated glass is backlit by color-gelled fluorescents; the form engages arriving customers with mystery. “We wanted to juxtapose the nonmateriality of the lighting bubbles with a very tactile, almost coarse material,” Barrata says. The spongelike pattern of holes within the wood are as organic as the light bubbles are otherworldly. n

Sources

Low-voltage LEDs: *ElectraLED*
Bubbles: *American Skylight*
Mounting brackets: *Quality Metal Craft*
Polycarbonate panels: *Sheffield Plastics*
Pendant downlights: *Illuminating*

Experiences

Accent spotlights and tracks:
Tech Lighting

For more information on this project, go to Lighting at www.archrecord.com.



Y
S

 prescolite
ABOVE & BEYOND

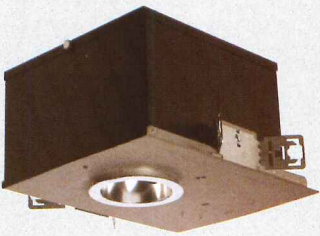

A
aim

Make your life easy with Prescolite's new Architektür A4 adjustable accent lights. Hot aiming, 45° vertical and 362° rotational adjustment, tool-less locking, multiple media accommodation, top access, a wide array of trim and lamp types and more... A4 has it all. What could be easier? To learn more about Prescolite's A4 family, contact your local Hubbell Lighting representative or visit us at www.prescolite.com or call 888-PRS-4TEC.

CIRCLE 55 ON READER SERVICE CARD OR GO TO ARCHRECORD.CONSTRUCTION.COM/PRODUCTS/

W

Architektür

ARCHITECTURAL DOWNLIGHTS

Hubbell Lighting, Inc.

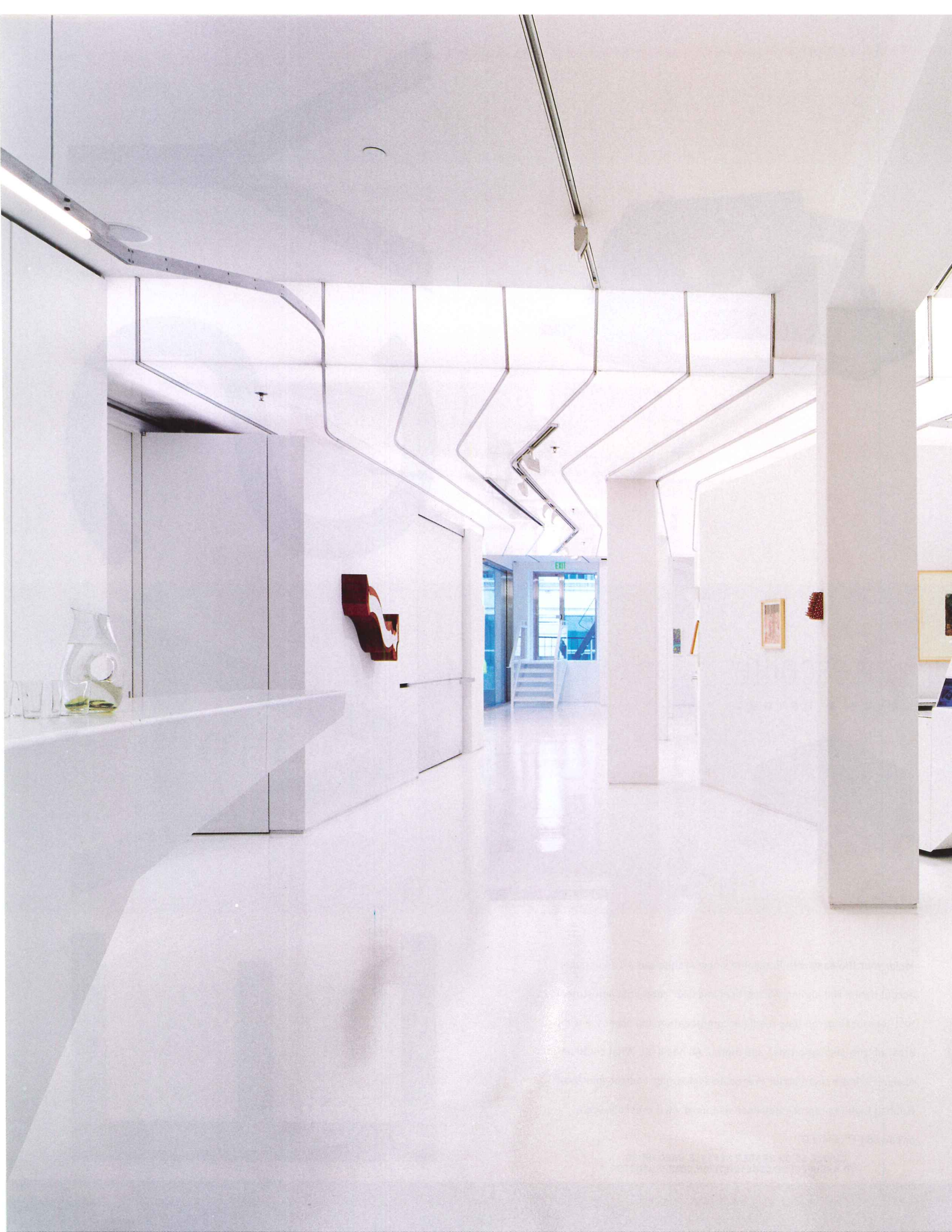

Tillotson Design Associates wraps the **Mixed Greens** art gallery with white light

By **Leanne French**

The Mixed Greens gallery aims to counter the often-rarefied trappings of the contemporary art world. Launched in 1999 as an online operation and later expanded to a bricks-and-mortar gallery in New York City's Chelsea district, the business was founded with the philosophy that "great, affordable art should be part of everyone's life," says owner Paige West. This egalitarian approach extends to its new location on West 26th Street, a 3,500-square-foot, white-on-white landscape set beneath a luminous fluorescent ceiling that emphasizes the art on display.

Architects David Leven and Stella Betts, principals of Leven



Betts Studio, allowed the challenging conditions of the gallery's existing raw space to dictate the renovation. A deep central beam and five irregularly spaced columns led the architects to create a custom dropped ceiling as a unifying element. Clad with translucent acrylic panels, the ceiling houses lighting, HVAC, and sprinkler systems. Supported by flat, mill-finish aluminum bars, the monolithic structure also serves as a visual cue that draws visitors through the two main display areas.

Lighting designer Suzan Tillotson, principal of Tillotson Design Associates, orchestrated the ceiling's luminous glow. The client was initially opposed to fluorescent lighting, fearing it would be too harsh, so Tillotson created a lighting mock-up to compare three sources set behind

Leanne French is a freelance writer based in New York City. She is a frequent contributor to the RECORD lighting and interiors sections.

Project: *Mixed Greens, New York City*

Lighting designer: *Tillotson Design Associates—Suzan Tillotson, principal designer; Shiri Cnaani, Greg Emetez, project team*

Architect: *Leven Betts Studio—*

David Leven, Stella Betts, principal architects; Tim Furzer, Jonathan Man, associates

Interior designer: *Ghislaine Vinas Interior Design*

Contractor: *Taocon*

The dropped ceiling's acrylic panels mask T8 fluorescent strip lights strategically placed around ductwork and pipes to create a uniform glow (above). Exposed, pendant-mounted linear fluorescents light key task areas (right).

PHOTOGRAPHY: © MICHAEL MORAN



The spacing of the ceiling's flat aluminum support bars varies to establish a strong directional pull from the front to the back of the gallery (above left and right). Sculptural dividers and furnishings are lit by the canopy and exposed fluorescents (below).

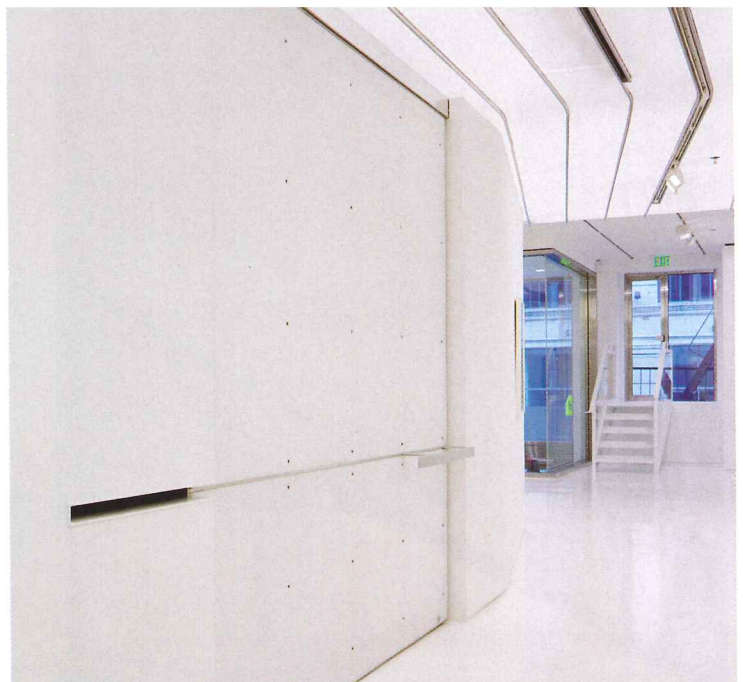

acrylic: incandescents, dimmable 3000K fluorescents, and warmer 2700K fluorescents. "After the client saw the three options, she chose the 3000K fluorescents," Tillotson says. "Our challenge was to translate the mock-up to a larger scale, and make the lighting set off the art without the gallery seeming too cool or 'surgery-suite' sterile."

Tandem-mounted, T8 fluorescent strip lights were carefully placed to eliminate shadows from the ductwork and pipes, ensuring a uniformity of illumination across the ceiling plane. The design team optimized the plenum depth at 16 inches to create a consistent surface and a comfortable finished-ceiling height. The ambient glow of the translucent canopy compensates for a lack of natural light, which was sacrificed when windows were covered to accommodate additional wall displays. To further accent the art, additional downlights attach to ceiling tracks.

The ambience of the space was intended to be more casual than most galleries. "The client wanted to celebrate the office in the middle of the space and make it more accessible for clients," says Betts. "At exhibition openings, the experience is more fun and lounge-like."

Inspired by the structure of airplane wings and sci-fi imagery ("We looked at George Lucas's film *THX 1138*, a movie with a palette that was completely whited out," says Leven), the architects designed a custom reception desk, a bar, and a pivoting media table that features built-in laptops where visitors can view the gallery's archived collection. The furniture clads inner steel-tube structures with aluminum panels. Accent lights can be ceiling-mounted on extensions to downlight key furniture pieces. Exposed, pendant-mounted fluorescent lamps with rear sockets also appear to float below the ceiling above the bar and pivoting table, while halogen wall washers illuminate key areas throughout the space. In the office and storage areas—and inside cabinets—the architects worked with interior designer Ghislaine Vinas to punctuate the white-on-white color scheme with swaths of green, a nod to the gallery's name.

At night, interior lighting viewed from the street substitutes for signage. Gelled T5 fluorescent strip lights and a Mylar scrim set between the drywall and three front windows cast an outward green glow. The subtle stroke of illumination along the multitenant building's facade quirkily invites passersby to enter and explore the art that awaits inside. ■

Sources

Fluorescent strip lights: *Bartco*
Incandescent track lights: *Capri*
Exposed fluorescents: *Nippo*

For more information on this project, go to Lighting at www.archrecord.com.

balancing

work

single source, for task *and* ambient lighting

person

enhances comfort and productivity

place

clean, no lights on the ceiling

planet

green, < 0.75 watts/sf



Tambient.
lighting at work

Complete catalog, design
tools and pricing information at
www.tambient.com



CIRCLE 56 ON READER SERVICE CARD OR GO
TO ARCHRECORD.CONSTRUCTION.COM/PRODUCTS/

a division of Sylvan R. Shemitz
Designs, Inc., makers of **elliptipar**



Designing for a Sustainable Future...

AAL's Indirect product line added a sibling, the 'Straight Fixed Head'. The Dark-Sky Friendly luminaire produces soft, glare-free illumination making it a perfect match for applications where mood is just as important as illumination. The 'Straight Fixed Head' model is available for post and wall mount configurations and can be styled with a round or square upper reflector to complement architectural themes. The Indirect product family utilizes energy efficient lamp sources up to 150 watts and Egress (emergency) options may be added for enhancing public safety.

For product information, log onto: www.aal.net/indirect_sfh.html

Architectural Area Lighting

CIRCLE 57 ON READER SERVICE CARD OR GO
TO ARCHRECORD.CONSTRUCTION.COM/PRODUCTS/



Hubbell Lighting, Inc.



◀ Spheres of light and shadow

Intended for hospitality and residential interiors, the Farinelli chandeliers and sconces are the latest addition to Boyd Lighting's Kentfield Collection division. Designed by Bentivoglio/Heefner, the fixtures feature hand-sculpted woven spheres that float above the light source, diffusing the light into shadowy patterns on the wall and ceiling. The curving brass arms, with brass or nickel finish, are topped with white glass tulip-shaped shades. The chandelier's curvilinear form is repeated in a single arm wall sconce. The series is available in finishes of satin nickel, satin brass, and blackened brass, while the woven sphere is finished in polished nickel. Halogen lamping and mouth-blown, cased white Italian glass are standard. For more understated interiors, the fixtures are available without the spheres. Boyd Lighting, San Francisco. www.kentfieldcollection.com **CIRCLE 202**

▶ Illuminating ceiling fan

Propeller is a new ceiling fan created by Israeli designer Yaacov Kaufman for the serien.lighting collection. The fan's "blades" are made of a translucent synthetic white fabric stretched over a wire frame. According to the manufacturer, the blades can easily be removed to change the lamp (one 150-watt halogen bulb) or remove the fabric for cleaning. The strength of the illumination and the rotor speed (60, 120, 180 rpms) can be set and controlled independently of each other by IR remote control with various settings. There is also a rightward/leftward running motor for summer and winter operation. Propeller has a wing span of 39" and comes in approximately 17", 25", and 32½" lengths. The fixture is currently available in the U.S. through Plug Lighting in Los Angeles. serien.lighting, Rodgau, Germany. www.serien.com **CIRCLE 203**

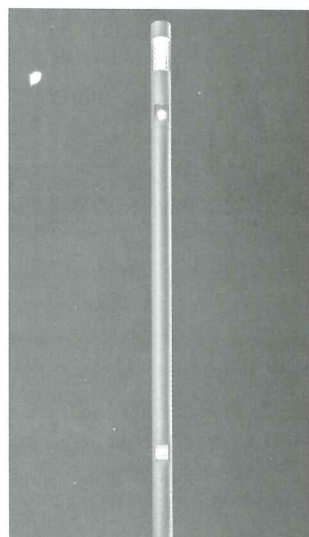

◀ Skinny lighting options

HessAmerica had several strong introductions this year, including the Ledia and Night Elements fixtures. Ledia LED illuminated embedded glass tile and strip lighting (far left) is appropriate for indoor, outdoor, and underwater use. Designed by German architect Karsten Winkels, Ledia recesses into paver stones, concrete walkways, patios, reflecting ponds, corridors, and the like, across a scale of municipal and upscale residential applications. Night Elements (near left) are multifunctional columnar luminaires in modular sections for outdoor area, site, and landscape lighting. The unobtrusive poles offer combinations of upward, downward, and laterally aimed lighting for area, accent, walkway, and landscape illumination, as well as zone definition. Modules can be configured from ground-mounted beacons and bollards up to columns 18' in height. Night Elements features cast-aluminum housings and extension modules in extruded aluminum: Standard colors are natural aluminum, matte silver-gray metallic, or graphite gray. Illumination is provided by a choice of metal-halide or fluorescent lamps for crisp, white light. HessAmerica, Gaffney, S.C. www.hessamerica.com **CIRCLE 204**

COOPER LIGHTING ARCHITECTURAL OFFERINGS



Invue Mesa



Shaper 674 Luminous Wall Sconce



Invue Vision Flood



Lumière 1235C-RD Step Light

Cooper Lighting offers versatile and distinctive architectural lighting solutions that enrich any environment. Inquire about the industry's most trend-setting architectural products.



COOPER Lighting

www.cooperlighting.com

Walt Disney Concert Hall in Los Angeles is illuminated with Invue Vision Flood. Lighting design by Kinetic Lighting; Photo courtesy of Line 8 Photography.

CIRCLE 58 ON READER SERVICE CARD OR GO TO ARCHRECORD.CONSTRUCTION.COM/PRODUCTS/

Lighting Products

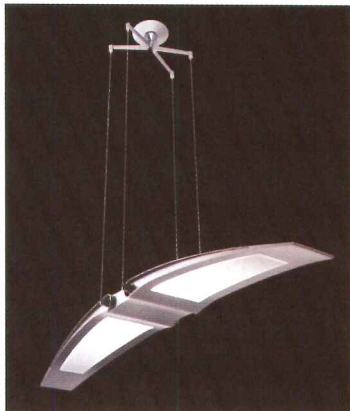

◀ New design takes flight

L'ale is Ivalo Lighting's newest fixture family. The first piece in the line is an indirect/direct pendant designed by William Pedersen, FAIA, of Kohn Pedersen Fox. Resembling a spaceship model, the fixture features a 4'8" long shell that ranges in width from 11" in the center to 5" at the tips and includes a removable acrylic lens. The elegant power and support I-wire cable system comes 12' and 16' standard lengths. Ivalo Lighting, Coopersburg, Pa. www.ivaloighting.com **CIRCLE 205**



◀ Overbed health-care family

Patientlite is a multifunctional family of direct/indirect T5 fluorescent overbed lights for patient rooms in a range of health-care and institutional facilities. The housings are manufactured from extruded aluminum plates with heavy-duty die-cast aluminum end plates. The fixture's break-resistant polycarbonate lenses are flexible, nonyellowing, and chemical-resistant for the life of the fixture. A seam-free top and clean edges eliminate dust traps. Luxo, Elmsford, N.Y. www.luxous.com **CIRCLE 208**

▶ LED mixing chamber

Evo solid-state lighting uses an integrating chamber to mix and blend LED light into one smooth, blended light source without striations or pixelation. The line is currently available in interior downlights and recessed or surface-mount linear configurations. Renaissance Lighting, Herndon, Va. www.renaissancelighting.com **CIRCLE 206**



▶ Light projector

When illuminated, the inner porcelain shades of the Clair De Lune Collection, adorned with a carved design, project the reflection of the pattern onto outer fabric shades. Intended for high-end residential and hospitality interiors, the Clair De Lune family of fixtures includes a flush-mount and semiflush-mount ceiling light, a four-light chandelier, three-light and two-light island fixtures, a wall sconce, and a single-light pendant in two sizes. The larger of the two single-light pendants (right) measures 14" wide x 16" high and uses one 150-watt bulb. All hardware is in a satin nickel finish. Stylicon, Louisville. www.stylicon.com **CIRCLE 207**



For more information, circle item numbers on Reader Service Card or go to www.archrecord.com, under Products, then Reader Service.

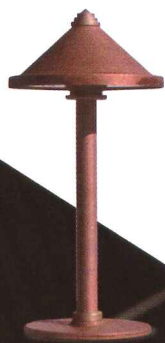

FORM MEETS FUNCTION

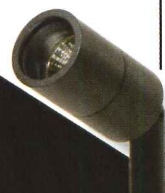

B-K LIGHTING  **TEKA ILLUMINATION**

www.bklighting.com • 559.438.5800 • www.teka-illumination.com

CIRCLE 59 ON READER SERVICE CARD OR GO TO ARCHRECORD.CONSTRUCTION.COM/PRODUCTS/

Lighting Products

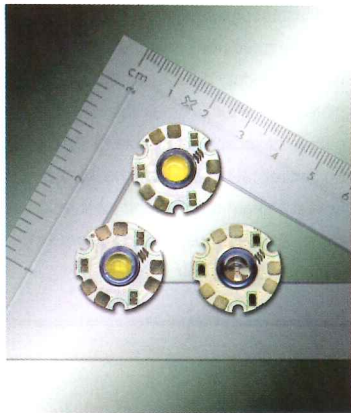

◀ Ultra-bright LEDs

At the 2006 Light+Building show in Frankfurt, Germany, Lamina Ceramics introduced Atlas, a new line of ultra-bright LED light engines, including a warm white model designed to replace halogen and tungsten filament competitors and a powerful "daylight white" model designed to replace fluorescents. The new line also features an RGB LED light engine generating any of 16 million blendable colors, including white. Lamina Ceramics, Westampton, N.J. www.laminaceramics.com **CIRCLE 210**



◀ Taking on the task

Lightolier has introduced a line of specification-grade task lighting to address the visual needs of an aging workforce. The new line includes adjustable arm task lights, undercabinet lighting, and portable ambient lighting fixtures. Table base, floor stand, panel, and binder bin mounting options are available. Adjustable arm task lights are spring-balanced and feature parallel motion, keeping lamp heads at the optimum angle as the arm positions are changed. The fixtures incorporate energy-saving 13-watt compact

fluorescent, LED, or T5HO lamps (halogens are also an option). Adjustable arm task lights come with a variety of head shapes such as the 1960s retro globe shades above. Lightolier, Fall River, Mass. www.lightolier.com **CIRCLE 212**

▶ Natural light in a bulb

The Natural White pulse-start metal-halide lamp and ballast system features a high color rendering index (CRI) of 90+. The lamp is intended to replicate natural daylight in applications including retail, lobby, and roadway lighting. Venture Lighting, Solon, Ohio. www.venturelighting.com **CIRCLE 209**

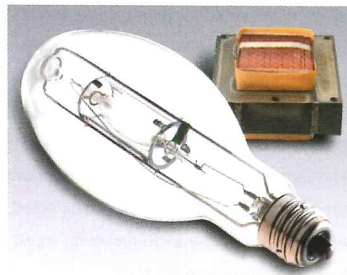

▶ Spotlight on recent history

The Leucos Historic Collection includes fixtures popular in the 1960s and '70s suited for contemporary settings. Leucos's first design, the Gill wall sconce and ceiling fixture (right), features handblown crystal glass surrounded by a white circular detail across the glass front. Leucos USA, Edison, N.J. www.leucos.com **CIRCLE 211**



For more information, circle item numbers on Reader Service Card or go to www.archrecord.com, under Products, then Reader Service.



Featuring:

PROGRESS LIGHTING

Lighting Universe PRO

LightingUniverse.com • 1-888-404-2744

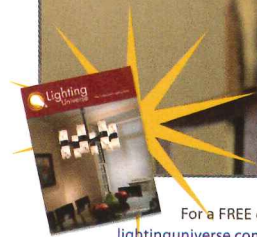

For a FREE catalog visit lightinguniverse.com/AR or call!

ATG ALLIEDTRADEGROUP Family of Stores

Special Trade Pricing • Free shipping
500,000 products • Project Management Tools

LightingUniverse.com | FixtureUniverse.com | FloorsandSurfaces.com | KnobsandHardware.com | DecorUniverse.com

©Allied Trade Group, Inc.

CIRCLE 60 ON READER SERVICE CARD OR GO TO ARCHRECORD.CONSTRUCTION.COM/PRODUCTS/

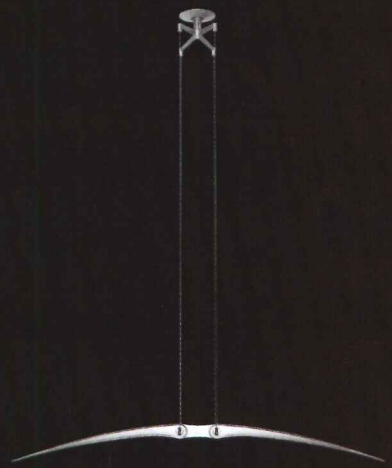
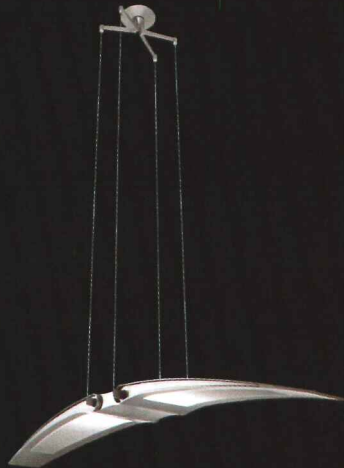
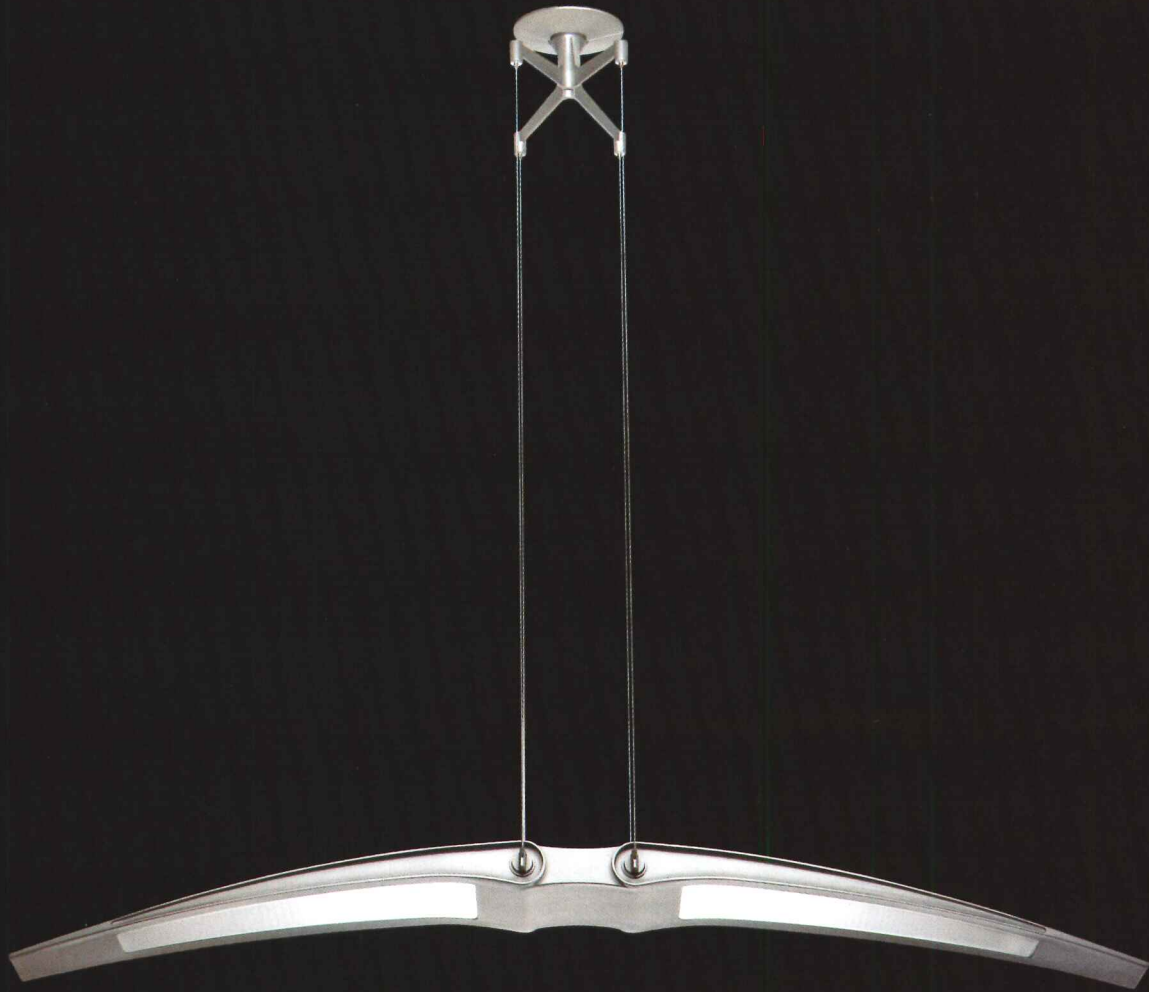

L'ale

Lighting fixture designed by William Pedersen

A 4'8" long, compact fluorescent pendant designed to be used singly or in multiples at the same or varying heights. Dimmable indirect/direct with slender line voltage suspension/power cable.

CIRCLE 61 ON READER SERVICE CARD OR GO TO ARCHRECORD.CONSTRUCTION.COM/PRODUCTS/



**IVALO
LIGHTING**

Ivalo Lighting Incorporated

www.ivaloighting.com

7136 Suter Road
Coopersburg, PA 18036

telephone 610.282.7472
facsimile 610.282.7600

CALL FOR ENTRIES

ARCHITECTURAL RECORD

Product Reports 2006

Attention All Building Product Marketers:

Please submit your new products to ARCHITECTURAL RECORD's Product Reports 2006. Product Reports will again be a major editorial feature in the December issue of ARCHITECTURAL RECORD, presenting the most interesting and useful new building products that will be available to the architect, specifier, and designer in 2007. A panel of architects, design professionals, and editors will select products for publication from those submitted by September 8, 2006. **There's no entry fee. Just download a submission form** at the "Call for Entries" section at www.archrecord.com. Our panel will view each product category as a group, so please include an image of each submission in a slide, transparency, glossy color photo, or color printout of a digital image. If you send a CD, you must provide a labeled color printout of each image on the disk. Please make sure the digital image is a high resolution TIFF (300 DPI, at least 4 x 5 inches). If you have a labeled sample of your product (no larger than 8 x 10 inches), please include it with your submission.



Product Reports 2005

There is always a bit of excitement in the air at ARCHITECTURAL RECORD on Product Reports jury day—and it's not just for the winners from the current launch. Early that morning, a conference room is arranged with hundreds of samples and submissions, organized by division, that have been collected over the previous months from the nation's leading building product manufacturers. Once the jurors are settled, the race falls quiet as they tackle the task of helping us choose the year's most outstanding new products.

This year, we compiled our entries according to the 2004 edition of MasterFormat, but kept Digital Products as a separate category. Senior editor Deborah Swanson, LE, organized her third annual "virtual jury" to select the most innovative digital technology products. Her jury included Edward A. Goytia, AIA, director of practice operations at Mervin Duffi, New York City, and Darren J. Rizzi, Assoc. AIA, principal director of digital design at Skidmore, Owings & Merrill, Chicago.

Over and over again, the jurors were drawn to colorful, well-researched, and sustainable products. Some were recognized for increasing sustainability without increasing price point, while others may address a common everyday problem, such as privacy in the open workplace environment. In most cases, the winners push the boundaries of what is normally expected, rather than reinterpreting the standard.

Our 2005 Product Reports Jury

Yun Chang, AIA (seated, left), joined Hultand Architecture in New York City in 1998 and has served as project manager for clients including HBO, TimeOut NY, and designer Calvin Klein. Chang has managed design projects from initial design through construction administration.

Susan Kaplan (seated, center) is a LEED-accredited, certified construction specifier. In her role as director of specifications and coordinator of sustainable design at HOK in New York City, she ensures integration between members of the project team. Presently, she is environmental chair of HOK's CSI and a N.Y. Chapter USGBC board member.

Jim Condit, AIA (seated, right), is principal and director of lighting design at Jim Condit Lighting Design, Brooklyn, New York. Condit teaches lighting design at Parsons School of Design and Pratt Institute. Awards include a grant from the Trustees Fund for Lighting Education for a lecture series emphasizing a theoretical approach to lighting design.

Liamon Walsh, P.E. (standing, left), has been principal of Hultand Lighting Design in Brooklyn since 1983. Walsh is an environmental psychologist, and her projects have received awards including the 2005 USGBC Award for Impact, The Shaw Show, Leland, Pittsford, with artist Kiki Smith and architect Lebbeus Woods.

Joseph Rata, AIA, LEED (standing, second from left), joined Lewis Winchell Associates Architects in Boston in 1999 and was promoted to associate in 2001. Rata is the project manager for Harvard's New College Theater at the Hasty Pudding and its Library Services Building at 90 Mount Auburn Street, Cambridge, Massachusetts, to be completed this fall.

After training as an associate with Richard Heiler and L&L, Paul David Ling (standing, center) founded David Ling Architects in New York City in 1992. Ling's project list includes galleries, retail, and high-end residential work. His list of awards includes ICFP's Best Exhibition Design (2001).

Elizabeth Weeks, AIA (standing, second from right), is an architect and associate at Gruen Samton in New York City. For the past three years she has been responsible for organizing the resource collections at the firm. Weeks is a member of the Interior Designers' Association, an organization of product and material specialists working at AIA firms.

Michael Morris (standing, right) has been a partner with Yoshiko Sato in the Morris Sato Studio in New York City since 1996. Morris and Sato were recently included in the *Placemakers* press publication (2005), one of 200 firms to emerge internationally during the past five years. R.C.O.

Favorites this year include interactive tiles that transfer light, described by one juror as "inventive and ingenious"; a concrete technology that can be utilized as a display interface, and a rechargeable solar ball. Functions again emerged as one of the strongest categories due to "a great range of development and material research," according to the jury. Jeter Elizabeth Weeks, AIA, noted a trend in that category toward better-designed surfaces with sustainable polygons, but wished more site manufacturers would follow suit. An interesting paradox: The architects loved a tile with integrated LEDs, while the lighting designers were considerably less impressed.

In columns, we hope that in the following pages you will find the perfect product solution for your next project. Rita Catinella Orrell

180 Editors' Picks	215 Specialties
182 Top 25 Green Products	217 Equipment
185 Digital Products	222 Finishes
187 Concrete & Masonry	227 Special Construction & Core-Jacking Equipment
189 Metals, Woods, Plastics & Composites	239 Plumbing & HVAC
193 Thermal & Moisture Protection	235 Electrical
199 Openings	241 Communications, Security & Exterior Improvements
205 Finishes	

Download your submission form now at the Call for Entries section at www.archrecord.com. If you have any questions, please e-mail Rita Catinella Orrell at rita_catinella@mcgraw-hill.com. E-mailed submissions will not be accepted.

Celebrating the best in contemporary
American architecture

call for entries

The American Institute of Architects

2007 Institute Honor Awards

Thornycrown Chapel, Eureka Springs, Arkansas | AIA 2006 Twenty-five Year Honor Award | architect: E. Fay Jones, FAIA | photograph by Greg Hurstley



The Institute Honor Awards program recognizes achievements for a broad range of architectural activity to:

Elevate the general quality of architecture practice

Establish a standard of excellence against which all architects can measure performance

Inform the public of the breadth and value of architecture practice.

For information on submission requirements or to submit an entry form online, visit www.aia.org/nationalawards.

architecture

SUBMISSION DEADLINE: SEPTEMBER 1, 2006

interior architecture

SUBMISSION DEADLINE: SEPTEMBER 15, 2006

regional & urban design

SUBMISSION DEADLINE: SEPTEMBER 29, 2006

the twenty-five year award

SUBMISSION DEADLINE: SEPTEMBER 1, 2006

The American Institute of Architects www.aia.org



We've all searched...



The perfect floor
has been there
all the time,

Concrete!

The Eco-Friendly
floor that out
performs all
other flooring
systems.

*DeCicco's Tuscan Market
Ardsley, NY*

Imagine! A diamond polished floor without coatings, epoxies or waxes.

For More Information
352.258.9232
yesitsconcrete.com

Concrete
Reflections^{INC}
The Ultimate in Concrete Polishing.

CIRCLE 62 ON READER SERVICE CARD OR GO
TO ARCHRECORD.CONSTRUCTION.COM/PRODUCTS/

Products **Green Options**

This month's focus is on new solutions for designing sustainable buildings—from an **energy-saving air-conditioning** system to good-looking OSB panels. To scout out the latest environmentally friendly products, visit the **USGBC's GreenBuild show** to be held this year from 11/15 to 11/17 in Denver. *Rita Catinella Orrell*

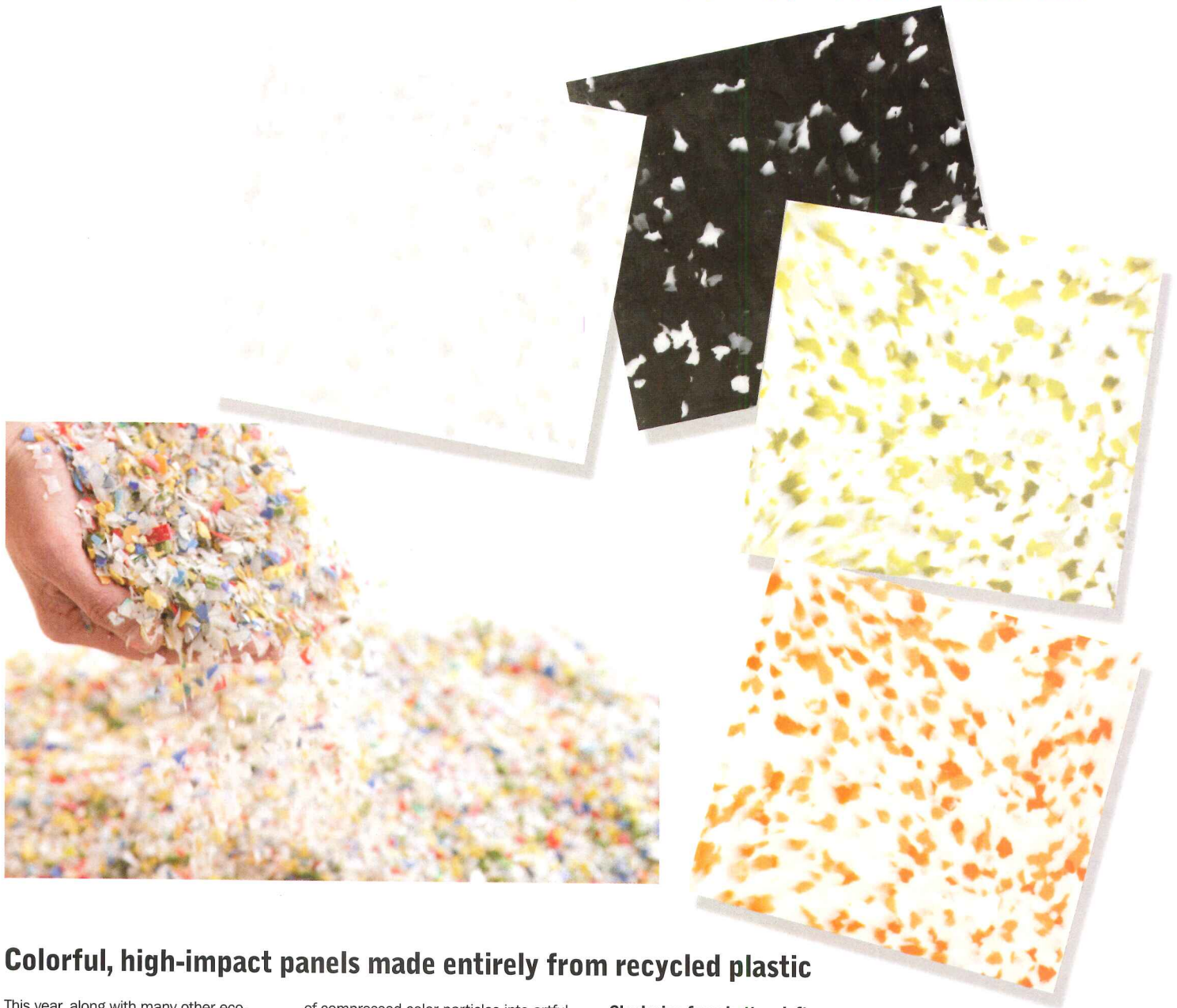

Colorful, high-impact panels made entirely from recycled plastic

This year, along with many other eco-friendly resin additions, 3form introduced 100 Percent, a new sustainable material offering made entirely from postconsumer-recycled high-density polyethylene (HDPE). HDPE is typically generated from recycled bottles used for detergent, shampoo, milk, and cosmetics. 3form worked with a recycling partner to devise a state-of-the-art sorting and cleaning technology to sort the waste by color and then arrange a confetti-like sprinkling

of compressed color particles into artful combinations within the panels. The company's own 240 member workforce at its Salt Lake City facility contributes to the recycling effort, even bringing in discards from their homes that are regularly shipped to the recycler in Alabama. 100 Percent panels are UV stable, offer chemical-resistance, and are suited for high-impact environments, such as restroom partitions, education and health-care facilities, as well as outdoor

Clockwise from bottom left: Confetti-like recycled particles; 100 Percent panels in a range of colors; examples of recyclable bottles.

applications. Initially, 100 Percent is available in four colorways in 4' x 8' sheets that are 1" thick. Color patterns can be varied according to the needs of the specifier, depending on the availability of specific recycled content. 3form, Salt Lake City. www.3-form.com **CIRCLE 212**



Product Green Options

► Latest addition to solar control family

At last year's GreenBuild, Hunter Douglas Contract's Nysan division introduced GreenScreen Eco fabric, the latest addition to the GreenScreen family of PVC-free solar shading fabrics designed exclusively for internal and external contract roller shades and solar control systems. The fabric is made of prestretched polyester available in 3 percent openness and five colorways. Customized dual coloring allows for a greater level of heat control, glare reduction, and outward visibility. Hunter Douglas Contract, Upper Saddle River, N.J. www.hunterdouglascontract.com **CIRCLE 213**

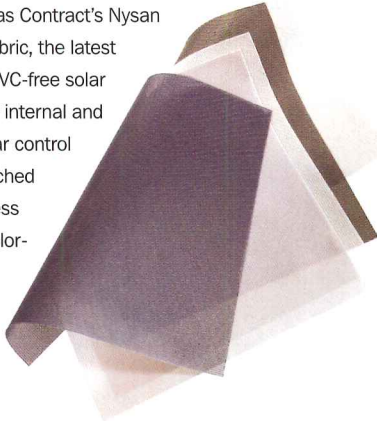

► Sustainable "new wood species"

Accoya, from U.K.-based Titan Wood, is produced using a patented acetylation process that converts sustainably forested softwoods and nondurable hardwoods into a modified wood product that offers durability, dimensional stability, and a nontoxic, 100 percent recyclable alternative to tropical hardwoods, biocide-treated woods, and artificial materials in external applications. The company is currently negotiating overseas distribution rights and expects Accoya to be available in the U.S. next year. Titan Wood, Earlston, U.K. www.titanwood.com **CIRCLE 215**

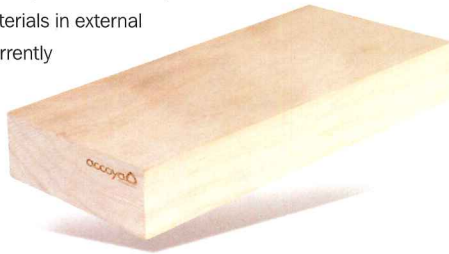

▼ Easy to install green roof system

GreenGrid, a division of Weston Solutions, introduces a new DIY Green Roofing System ideal for homes or smaller commercial buildings. The GreenGrid DIY Kit includes 2' x 2' x 4" modules, GreenGrid's specially formulated lightweight soil media, and low-maintenance, drought-resistant sedum plants. After the soil media and plants are placed in the modules, the units can be installed directly on top of the existing roof. Although the system is light, the roof's structural integrity may need to be tested to verify that it can support the extra weight. Weston Solutions, Chicago. www.greengridroofs.com **CIRCLE 217**

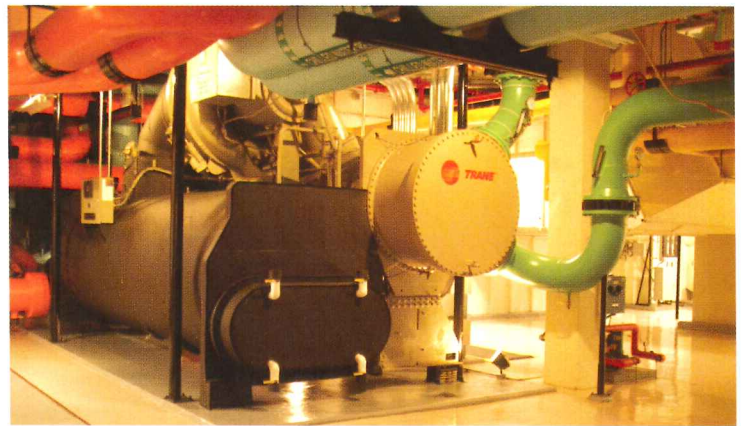

▲ Chilling out overnight

Last June, New York State and County officials presented Morgan Stanley with a ceremonial incentive check for \$300,000 for installing the Metropolitan area's largest ice-storage-based air-conditioning system at its Purchase facility. The system, provided by Trane, makes ice at night during off-peak hours to provide cooling the next day during on-peak hours. The system is expected to lower the facility's peak energy usage by 740 kw, reduce overall electric usage by 900,000 kwh, and reduce the site's overall fuel consumption by 15,000 MBtu. Trane, Long Island City, N.Y. www.tranenewyork.com **CIRCLE 214**

◀ Reducing odor and VOCs

Sherwin-Williams's new ProGreen 200 (left) is a competitively priced, low-odor, low-VOC paint that exceeds Green Seal's GS-11 standards for paints. At 50 grams per liter VOC, the product complies with environmental regulations and is ideal for new commercial construction. Another low-odor introduction is Sherwin-Williams's Harmony Interior Latex line, which offers zero VOCs and antimicrobial properties. Sherwin-Williams, Berea, Ohio. www.sherwin-williams.com **CIRCLE 216**



► OSB panels with style

Taking home Best Overall product at GlobalShop, the nation's largest retail trade show, Ecotextures architectural panels are crafted from environmentally friendly OSB products. Certified, rapidly renewable timber is used to create a durable, shrink-resistant material ideal for millwork, feature walls, column covers, fixtures, and furniture. Ecotextures are engineered in varying panel sizes in four patterns that interlock for a seamless finish. Four colors are offered in addition to a natural unfinished surface that can be stained on-site. No urea-formaldehydes are used in the panel production. Architectural Systems, New York City. www.archsystems.com **CIRCLE 218**



WinGuard
windows.
Stronger than
plywood and
much, much
prettier!!

WinGuard® Impact-Resistant Windows and Doors spell the end of plywood. The end of unsightly shutters and brackets, too. WinGuard maintains the look of your design, and even enhances it with a wide variety of custom shapes and sizes. But as beautiful as these windows and doors are, they're also tough. WinGuard protects against strong winds and flying debris, meeting the strictest hurricane code requirements in the nation. In fact, even after the extraordinary 2004 hurricane season, with over one million units installed, WinGuard had zero reported impact failures.

EFFORTLESS HURRICANE PROTECTION

PGI **WinGuard**
IMPACT-RESISTANT WINDOWS & DOORS

To learn more, visit Architect View at www.NoMorePlywood.com
or call 1-877-WINGUARD

CIRCLE 63 ON READER SERVICE CARD OR GO
TO ARCHRECORD.CONSTRUCTION.COM/PRODUCTS/



The architect looks good with

New Jersey
SmartStart
BUILDINGS®



*"My clients get designs that
save them a lot of money.
That's my blueprint for success."*

New Jersey SmartStart Buildings® is a registered trademark.
Use of the trademark, without permission of the New Jersey
electric and gas utilities is prohibited.

- Incentives for efficient equipment design and installation
- Custom incentives for qualified energy-efficient innovations
- Multiple measure bonus
- Design support and expert consultation
- Technical assistance for premium-efficiency opportunities

New construction projects, with the exception of K-12 public schools, must be located within a designated Smart Growth area to be eligible for incentives.

NJ SmartStart Buildings is an energy efficiency program administered by the New Jersey Board of Public Utilities and currently managed by Atlantic City Electric, Jersey Central Power & Light, New Jersey Natural Gas, Elizabethtown Gas, PSE&G, Rockland Electric and South Jersey Gas Company for their commercial and industrial customers.

Don't start a project without NJ SmartStart Buildings! Visit the website today.

njcleanenergy.com



New Jersey's
Clean Energy
PROGRAM™
Your Power to Save
njcleanenergy.com
New Jersey Board of Public Utilities
Office of Clean Energy

Incentives for an energy-efficient New Jersey

CIRCLE 65 ON READER SERVICE CARD OR GO
TO ARCHRECORD.CONSTRUCTION.COM/PRODUCTS/

Product Briefs

NeoCon Review

The 38th annual NeoCon trade show for contract interiors, held last June in Chicago, hosted more than 50,000 attendees in 1.2 million square feet of exhibition space. Here are a few outstanding introductions. *Rita Catinella Orrell*

▼ Naturally strong and beautiful

The Lineage collection of stainless-steel and bronze tiles from Flux Studios have a living finish; no coatings or chemical patinas are applied over the metal. Patterns in the line include an hourglass and blank tile (bottom left). Flux Studios also recycles wood from sustainably harvested and plantation grown lumber too small to be used for fine-furniture making to create their line of solid bamboo, teak, and rosewood tiles (bottom right, shown with tile inserts). Fortis Arbor Grout was developed specifically to move with the natural expansion and contraction of the tiles in applications such as flooring, walls, countertops, backsplashes. Flux Studios, Chicago. www.fluxstudios.com **CIRCLE 219**

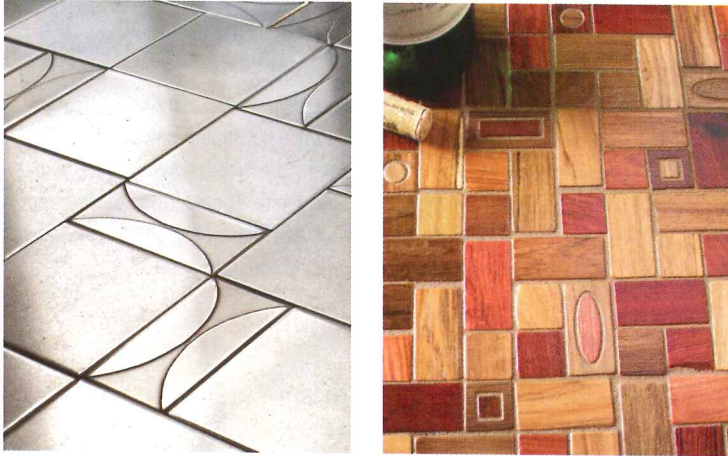

▲ Recyclable family of seating

Metro's Poly family of seating features side and swivel chairs, a lounge, and an ottoman ideal for reception and lounge areas, enclaves, and both formal and informal meeting spaces. The Poly side chairs offer a pull-up seating alternative and are available with two base options: four-leg and sled. The grouping is created through the bonding of nonwoven PET (polyethylene terephthalate) fiber and a 100 percent recycled polyester fabric, creating a structural shell that is entirely recyclable. Metal components are finished with a VOC-free abrasion-resistant powder coating. Assembled together, the seating components are composed of over 25 percent recycled content by weight. Metropolitan Furniture, Oakland, Calif. www.metrofurniture.com **CIRCLE 220**

◀ Glass cameos

Skyline Design's products made cameos in several showrooms at NeoCon—including Herman Miller and izzydesign—where they were integrated into new office furniture systems. Skyline's newest collection of architectural etched glass, light + shadow, was on display at its temporary booth at the show. Designed by Lydia Esparaza, Wayne Susag, and Deborah Newmark, the series is inspired by the interplay of abstract organic forms and translucency. The collection comes in tempered, laminated, or clear plate glass in 10 patterns in standard sizes (up to 56" x 124"); ¼", ⅜", and ½" thicknesses; and it meets all glass safety requirements. Skyline Design, Chicago. www.skydesign.com **CIRCLE 221**



► Orderly office assistant

Designed to help professional service firms take back their work areas from piles of files and boxes, Allsteel has developed the Clerk mobile storage stand. Clerk's open, multiple shelves provide easy access to files, and the sliding shelf brackets stabilize and hold smaller files in an organized position. Clerk also provides convenient mobility of files within and between offices, project rooms, and archival storage. The stand holds up to 80 pounds per shelf—240 pounds total—while still being easy to push or pull. When not in use, folding shelves allow it to easily nest to allow for compact storage of multiple units. Allsteel, Muscatine, Iowa. www.allsteeloffice.com **CIRCLE 222**

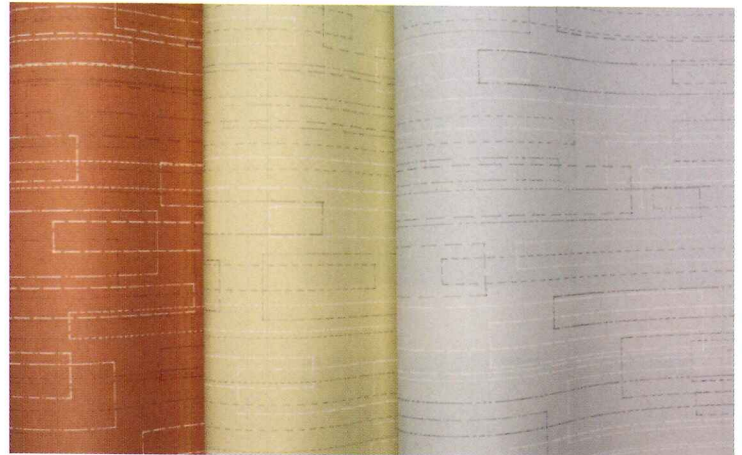

▲ The writing's on the wallpaper

The Parallel Lines collection is a group of three wall coverings from KnollTextiles designed by the New York City architecture and design firm Lewis.Tsurumaki.Lewis (LTL). Vector, Perimeter (above), and Margin feature a series of parallel lines that when installed appear as if they were drawn on the wall. To achieve the handcrafted effect, pencil drawings were scanned and digitally duplicated. The collection draws on LTL's experiments with producing conceptual architecture through drawings. All three patterns are color coordinated using a natural palette, including a range of neutrals punctuated by rich bronze, copper, and bright green. KnollTextiles, New York City. www.knolltextiles.com **CIRCLE 223**

Design at its
most functional.

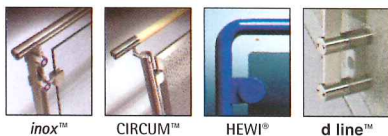

HDI Railing Systems

3905 Continental Drive • Columbia, PA 17512 USA
PH: 717-285-4088 • FAX: 717-285-5083
Email: info@hdirailings.com
www.hdirailings.com

Product Briefs NeoCon Review

► **From Bangkok to Portland**

As in years past, Shaw Contract Carpet launched two new lines at the show, partnering with an outside designer for one, and developing the other in-house. The later group is the Silk collection of four broadloom and six tile



products (left) showcasing a rich, saturated palette of 16 colors. Shaw Contract Group designers immersed themselves in the culture of silk by traveling to Thailand where they documented the visit with more than 2,000 photos of fabrics and colors. Suited for executive and professional services office spaces, Silk won a Gold Best of NeoCon Award for broadloom at the show. Also new from Shaw was Maine-based designer Angela Adams's first commercial carpet collection of tile and broadloom products (above right), which borrows heavily from Adams's own line of area rugs and accessories. Shaw Contract Carpet, Calhoun, Ga. www.shawcontractgroup.com **CIRCLE 224**



► **Products in motion**

Keilhauer has introduced two new designs from the Vienna-based design firm EOOS. The Tablett collection includes a lounge chair with four legs or a swivel base (left) and a two-person sofa, all available with one or two tablet arms, or with none. A simple magnet release



mechanism enables users to access the arm; when not in use, it rests within the chair's arm. The Squig task chair (right) is the result of seven years of research into gender-based differences in seating. Among other features, Squig integrates spring bouncing action in the design (reminiscent of sitting on an exercise ball) to encourage back and abdominal muscle activity. Keilhauer, Toronto, Canada. www.keilhauer.com **CIRCLE 225**



◀ **Pliable laminate material**

Milanese designer Luisa Cevese adapted the technique she developed for her Riedizioni collection of accessories to create Ply, a "pliable laminate" material for interior applications manufactured for Maharam. The product is based on a proprietary process Cevese developed to embed textile remnants in a soft, translucent polyurethane. Variations of the substrate, coupled with jute, chenille, and tweed yarns, create bold effects: Low-contrast combinations accentuate texture, and high-contrast variations add an optical twist. The translucent variation of Ply allows for opportunities to showcase materials underneath the surface. Polyurethane, the foundation of Ply, is a PVC-free organic polymer that offers the elasticity of latex coupled with extreme durability. Maharam, New York City. www.maharam.com **CIRCLE 226**



For more information, circle item numbers on Reader Service Card or go to www.archrecord.com, under Products, then Reader Service.

Product Briefs NeoCon Review

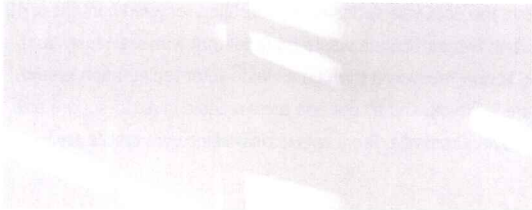
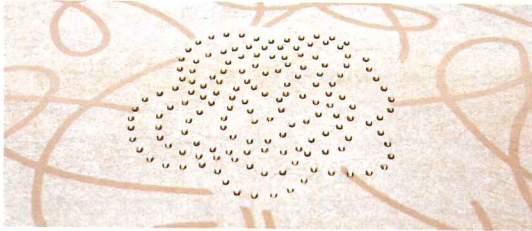

◀ Glitter and shadow

The new Wolf-Gordon Vescom collection is an exclusive group of wall coverings adorned with whole, individual, or crushed crystals from Swarovski (left). The collection offers three designs in 12 luminescent colors and two application techniques, one of which is customizable to any design. Wolf-Gordon's inaugural student design competition, *Surface Over Structure*, resulted in a stellar collection of designs by students from Harvard's GSD. The winning design, *Light* (bottom left), by Corinne Ulmann and Isamu Kanda, abstracts the simple effect of daylight coming through a window and leaving its trace on the wall. Wolf-Gordon, Long Island City, N.Y. www.wolf-gordon.com **CIRCLE 227**

▶ Get into the zone

The TechZone ceiling system from Armstrong organizes light fixtures, air diffusers, and sprinkler heads in a linear 6"-wide "technical zone" to create a more monolithic ceiling visual. By partnering with the nation's leading lighting, diffuser, and flexible-sprinkler connection manufacturers, Armstrong is able to provide an engineered, easy-to-specify ceiling system that uses only standard components and eliminates the long lead times, hassles, and cost often associated with custom materials to achieve the same effect. The system coordinates with the look of large-scale Optima panels and is appropriate for use in large expanses and open areas that require superior acoustical performance, such as open-plan offices, libraries, media centers, retail settings, and airports. Armstrong, Lancaster, Pa. www.armstrong.com/techzone **CIRCLE 228**



▲ Constructive work patterns

Haworth's Patterns product collection spans from systems furniture to private offices to architecture. Designed by Studio & Partners in Milan and Haworth's Design Studio, the collection is offered in a variety of heights, can be easily reconfigured, and also includes studio tables, benches, and file wrappers. Patterns inspired Haworth designer Joey Ruitter to create Spool, a complementing work stool made for indoor and outdoor environments. Spool's aluminum components contain a minimum of 25 percent recycled content, and all components are 100 percent recyclable. Both Patterns and Spool are in the process of being Greenguard certified. Haworth, Holland, Mich. www.haworth.com **CIRCLE 229**



For more information, circle item numbers on Reader Service Card or go to www.archrecord.com, under Products, then Reader Service.

HAMPSTEAD
LIGHTING & ACCESSORIES
20th Anniversary 1986 2006
LIGHTING A PATH TO EXCELLENCE

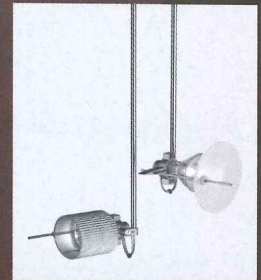
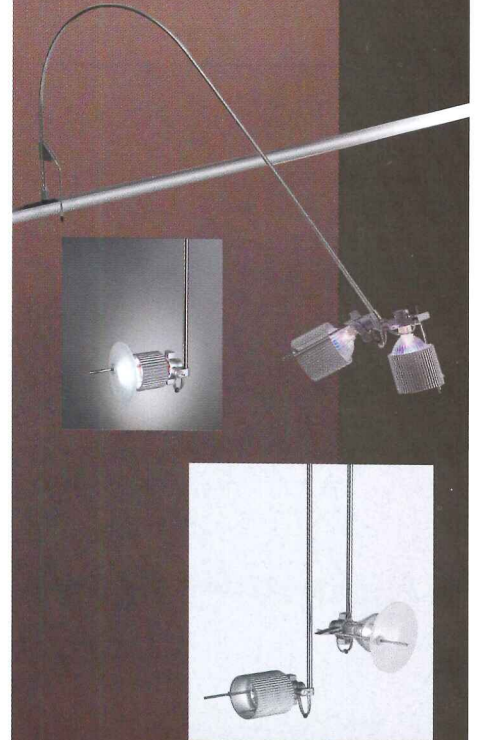

LUCINALIA
The Kri Collection

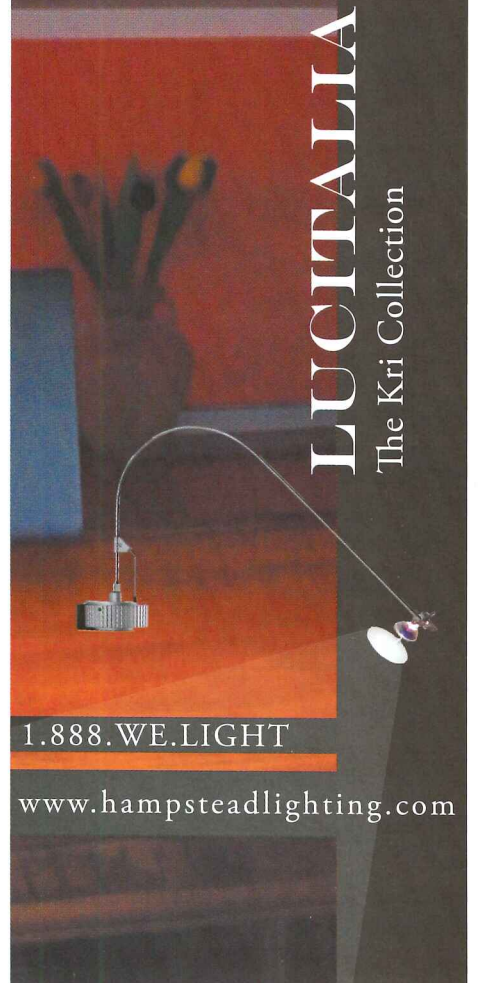

1.888.WE.LIGHT

www.hampsteadlighting.com

CIRCLE 68 ON READER SERVICE CARD OR GO TO ARCHRECORD.CONSTRUCTION.COM/PRODUCTS/

get
~~I need~~
 cabinetry
 specs to
 create great
 designs.
 at
 kraftmaidspec.com



Only KraftMaidSpec.com lets you download AutoCAD drawings of every single cabinet and gives detailed information on door styles, finishes, storage solutions and our quality construction. Visit KraftMaidSpec.com and see why so many architects rely on it as their design resource.

Made just for you.

KraftMaid
 Cabinetry

www.kraftmaidspec.com

CIRCLE 69 ON READER SERVICE CARD OR GO TO ARCHRECORD.CONSTRUCTION.COM/PRODUCTS/

Product Briefs NeoCon Review



◀ Recycled content certification

Scientific Certification Systems announced recycled content certification for the new EcoCycle Series of eight porcelain stone tile products manufactured by Crossville. Certification of the EcoCycle Series confirms that Crossville meets the necessary criteria for recycled content claims based on internationally recognized standards and guidance established by the International Organization for Standardization and LEED. The eight natural-stone-look products in the EcoCycle series have a certified recycled content of 40 percent; fine particulate waste material that was previously land-filled is now recovered through a wastewater reclamation system. All are 5/16" thick, and all but one are available in a 12"-square size. Crossville, Crossville, Tenn. www.crossvilleinc.com **CIRCLE 230**

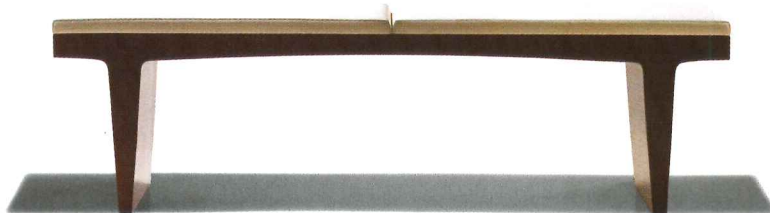

▲ Well-edited furniture collection

Suzanne Trocmé's award-winning 18-piece collection for Bernhardt Design is an elegant grouping of sofas and lounge pieces, side chairs, occasional tables, and benches. Trocmé, an editor for *Wallpaper** magazine, has written on art, fashion, music, interiors, and architecture for a variety of publications. One of the highlights of the collection is the Egalité bench (above), its named derived from the French Revolutionary motto "Liberté, Egalité, Fraternité." The seat cushion is cut in two equal portions with a "V" cut in the center, allowing a shadow gap to provide an invisible border. Constructed in solid maple, it measures 60" x 19½" x 17½" and is offered in multiple light and dark wood finishes. Bernhardt Design, Lenoir, N.C. www.berhardtdesign.com **CIRCLE 231**

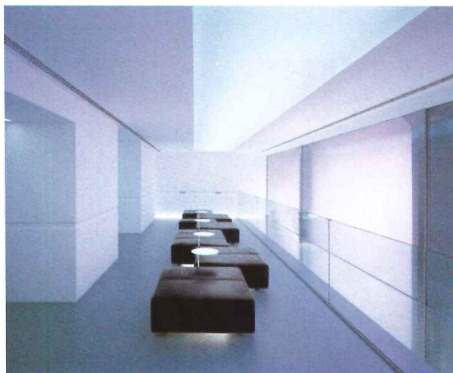

▲ Unexpected touches

Await (above left), designed by the Viennese firm EOOO, is a new line of modular lounge seating introduced by Brayton. The system features modular sofa and bench components that offer an unexpected radiant element of LED lighting under the seat frame. The low-energy lighting feature can be used to create a feature element in the space, provide a highlight to a flooring detail, or set the mood of the environment. Await also features ganging tables, tablets, a freestanding table in two heights, and a mobile ottoman on casters. The product will soon be UL-listed. The mobile Oom stool (above right), by furniture designer Matthew Weatherly, features a soft, upholstered seat with an integrated, handcrafted solid maple coatrack with a walnut inlay. Oom won an Innovation award in the Alternative Office category at the show. Brayton International, High Point, N.C. www.brayton.com **CIRCLE 232**

For more information, circle item numbers on Reader Service Card or go to www.archrecord.com, under Products, then Reader Service.

We've met the tests and aced them.

Visit us
at AIA Booth
#1243

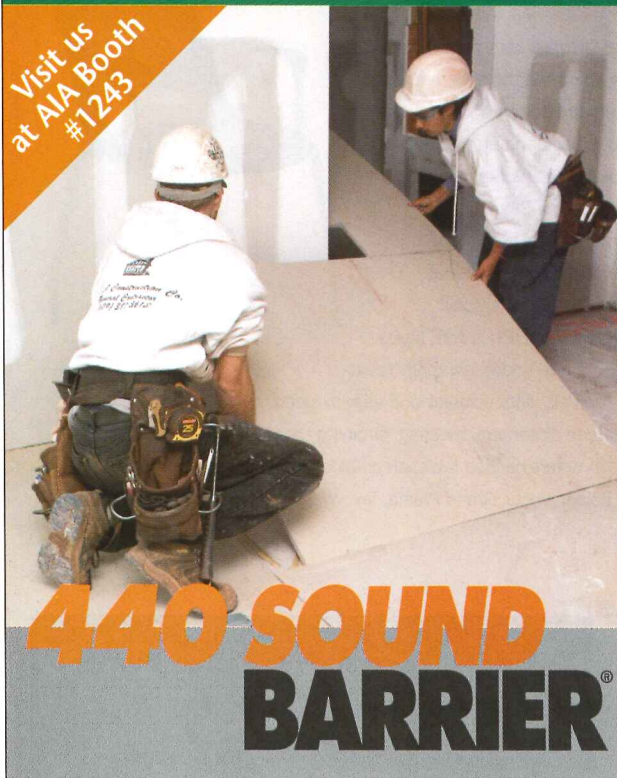

Make no mistake: 440 SoundBarrier® is the ultimate sound control for floors, walls and ceilings.

- Meets code for STC and IIC; UL-rated floor/ceiling assemblies
- Uniformly manufactured with resistance to mold, mildew, and moisture
- Compatible with all finished flooring
- Used in millions of square feet of multi-family housing
- No Cracking or Spalling

Architects and specifiers demand structural, economical 440 SoundBarrier panels when they need a high performance sound-control product that provides high STCs and IICs without cracking or spalling.

homasote
COMPANY



932 Lower Ferry Road, West Trenton, NJ 08628
800-257-9491-Ext 1500, Fax 609-883-3497

Visit
www.Homasote.com
for all the green building
products from America's
oldest manufacturer of
building products
from recycled
material.

CIRCLE 70 ON READER SERVICE CARD OR GO
TO ARCHRECORD.CONSTRUCTION.COM/PRODUCTS/

Not your garden variety green roof



A "successful" green roof is one that stays watertight and looks great over time - not for just the first or second year, but for decades. American Hydrotech's Garden Roof® Assembly is based on more than 35 years of proven green roof technology and experience. Because it's designed from the substrate up as a "complete assembly", it's much more than just the sum of its parts.



Ballard Library - Seattle, WA (2006 Green Roof Awards of Excellence winner)

American Hydrotech's Total System Warranty provides owners with single source responsibility from the deck up. This is a warranty that only American Hydrotech can offer, and peace of mind that only American Hydrotech can provide.



Long recognized as an industry leader, American Hydrotech continues to offer new products that allow us to better meet your needs. To learn more about what American Hydrotech can do for you, please give us a call at **800.877.6125** or visit www.hydrotechusa.com for more information.

303 East Ohio Street

Chicago, IL 60611

800.877.6125

www.hydrotechusa.com

CIRCLE 71 ON READER SERVICE CARD OR GO
TO ARCHRECORD.CONSTRUCTION.COM/PRODUCTS/

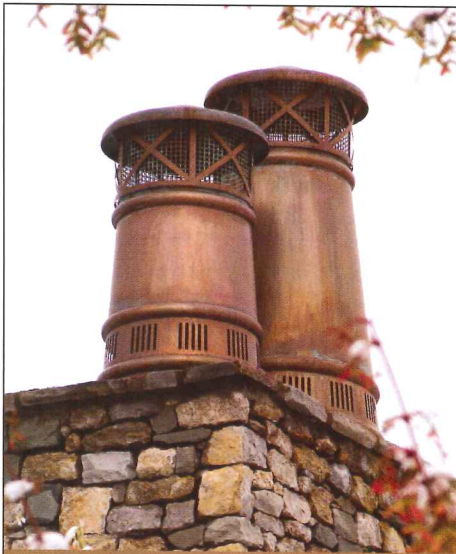

TAKE DETAIL TO NEW HEIGHTS.



A copper chimney pot by European Copper will take your next project over the top. UL-listed and International Building Code compliant, they are compatible with both masonry and steel fireplace systems.

Call today at 800-391-0014
for a dealer near you or visit
www.europeancopperchimney Pots.com

FEATURES

- Fine stainless steel and copper
- UL Listed, IBC compliant, patented
- For masonry or metal fireplaces
- Existing or new construction chimneys
- Withstands hurricanes, seismic shifts
- Keeps out pests and water
- Improves draft, reduces spark
- Lightweight, easy to install
- Three styles, seven sizes available

**EUROPEAN
COPPER**
BY JACK ARNOLD

CIRCLE 72 ON READER SERVICE CARD OR GO
TO ARCHRECORD.CONSTRUCTION.COM/PRODUCTS/

Product Briefs NeoCon Review

► Chairs that let you move

Designed by the renowned design firm IDEO, the Permiso conference chair from Vecta allows users to change posture, remain comfortable, and stay engaged in meetings through the application of four features:

a folding arm option, continuous back and arm, recessed arms, and a chair back of ideal height for an armrest.

Another Vecta introduction is the x-Stack chair,

made of glass-filled nylon and flexible thermoplastic urethane (TPU), a material

found in skateboard wheels, sport

shoes, and watchbands. TPU is soft, flexes

with user contact points, and is inherently resist-

ant to stains, naturally antimicrobial, and easy to clean.

X-stack caters to classroom, meeting, or dining-room applications, with an optional right- or left-handed table, an ambidextrous monopod for laptop use, and a cup holder. Vecta, Grand Prairie, Tex. www.vecta.com **CIRCLE 233**



► Opening up the line

Mitre casegoods, designed by Gary Lee Partners and introduced by Halcon at last year's show, has been expanded for 2006 to include an open office system, lounge seating, and guest seating. Mitre Open Office (right) bridges the gap between the look of custom millwork and the function of a furniture system. Also new from Halcon is an expansion of last year's Medio Conference collection, designed by the SOM Collaborative.

The expanded line includes credenzas, training tables, and wall-mounted cabinetry for marker boards and videoconferencing. The dual-purpose wood training tables feature elegant, functional metal legs that accommodate plug-and-play power and communication requirements. Credenzas provide conference companion work surfaces with optional functions, including storage, AV equipment, and refrigeration. Halcon, Stewartville, Minn. www.halconcorp.com **CIRCLE 234**

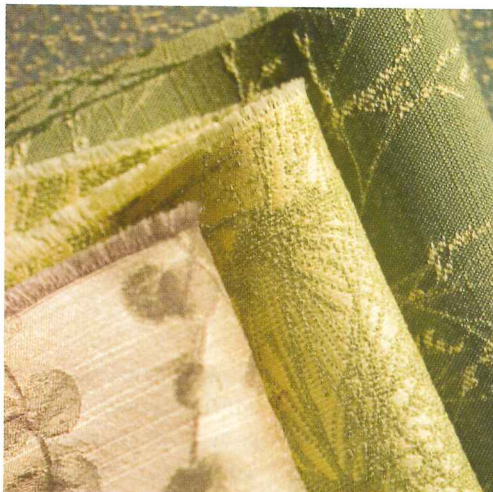

◀ Pretty as a picture

Textile designer Lori Weitzner based her Shadowgraphs collection of textiles for Pallas Textiles on the images found in fine art photographer Zeva Oelbaum's latest book, *Flowers in Shadow*. Oelbaum's botanical studies take inspiration from cyanotypes, a vintage photographic process achieved by coating paper with a solution of iron salts, placing a plant specimen on the paper, and then exposing it to sunlight. When the paper was rinsed with water, the section exposed to the sunlight turned blue. The new line of woven jacquards is intended for a broad variety of contract applications, including corporate, hospitality, commercial, institutional, and public spaces. Pallas Textiles, Green Bay, Wis. www.pallastextiles.com **CIRCLE 235**

For more information, circle item numbers on Reader Service Card or go to www.archrecord.com, under Products, then Reader Service.



“While SketchUp is great visualization software, it’s also an integral part of our design process. Time and again, SketchUp has proven to be a highly valued tool that has expanded our ability to communicate with the client effectively in real time.”

– Kevin O’Brien; Design Director, HMC Architects

SketchUp
from Google™

Visit www.sketchup.com to download a free trial of SketchUp Pro 5.

© 2006 Google Inc. All rights reserved. SketchUp and the Google logo are trademarks of Google Inc. Model courtesy of HMC Architects, Project: College of the Desert Public Safety Academy, Rendering: James Krueger & Chris Grant.

**CIRCLE 73 ON READER SERVICE CARD OR GO
TO ARCHRECORD.CONSTRUCTION.COM/PRODUCTS/**

 **BSD
speclink**

Fast specification writing . . . by design.

BSD SpecLink is intuitive. It was created by specification writers – people who know what you need in specification writing software.

BSD SpecLink is powerful. It has advanced productivity features – to help you create a complete project specification in record time.

BSD SpecLink is current. It keeps your specifications up-to-date automatically – with timely, accurate, and comprehensive updates that don’t overwrite your edits.

Our customers tell us they realize time savings of 40-70% on specs for every project that uses BSD SpecLink. Now, you can too.

Find your fast solution to specification writing on our website: www.bsdssoftlink.com. Read the success stories from our customers.

Start saving time today.

 **BSD**
Building Systems Design, Inc.

Exclusive offering of
CSI-DBIA and BSD.

Microsoft
GOLD CERTIFIED
Partner



**Call for a free, personal on-line demo:
1-888-BSD-SOFT (1-888-273-7638)**

**CIRCLE 74 ON READER SERVICE CARD OR GO
TO ARCHRECORD.CONSTRUCTION.COM/PRODUCTS/**

McGraw Hill CONSTRUCTION Architectural Record

Announcing the **NEW** *Architectural Record* Back Issue Store!

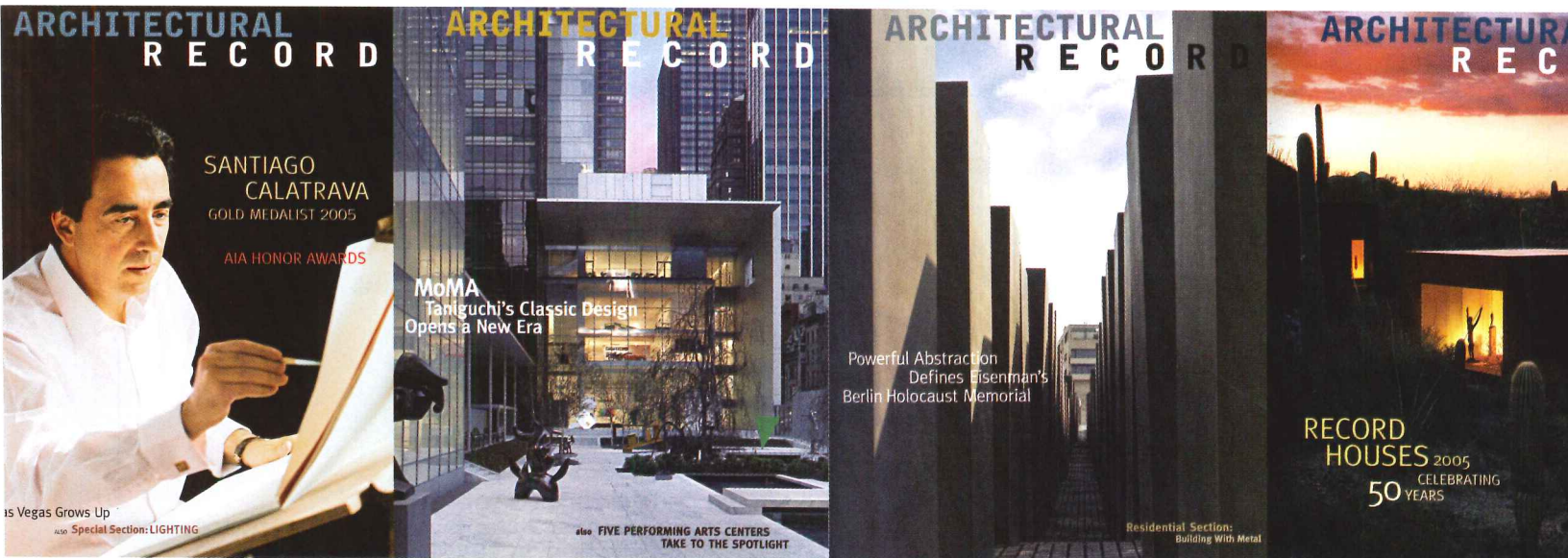

point. click. Get 'em!

Order back issues of *Architectural Record* online — quickly and easily!

Back issues of *Architectural Record* are now available in **BOTH** digital format or print edition — It's your choice!

This is a great opportunity to add to your library! Previous issues are an excellent reference tool, and the digital editions can be accessed immediately.

For more information, visit the web store today at www.archrecord.com/backissues/default.asp



Discounts are available for multiple copy purchases

Product Resource: Literature

Recycle and Reverb

DUSK, in collaboration with Tricycle, Mohawk Paper, and Aquafil USA, has produced *REVERB*, a unique report showcasing essays about interior design and sustainability. The report is printed on 100 percent recycled paper and half of the proceeds from each book will go to Architecture for Humanity. DUSK, Parsippany, N.J. www.duskusa.com **CIRCLE 236**

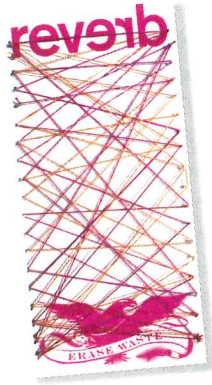

New WindsorOne catalog

WindsorOne recently released a new full-line catalog for its specialty lumber, molding, and millwork products. Utilizing innovative design and featuring updated photos, half of the 36-page catalog is devoted to interior product uses, while the other half is devoted to exterior uses. The catalog also includes a "Products at a Glance" specifications section and useful tips on product installation. WindsorOne, Windsor, Calif. www.windsorone.com **CIRCLE 237**



Miro movie

Watt Stopper/Legrand is featuring its Miro RF wireless lighting controls and architectural wiring devices in a new product portfolio. A 57-minute DVD details the process of installing and configuring a Miro system, and a new brochure provides information on every Miro product. Watt Stopper/Legrand, Santa Clara, Calif. www.wattstopper.com **CIRCLE 238**

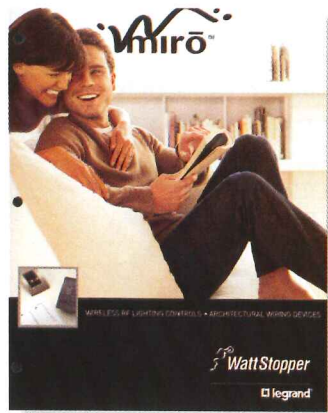

Sticks of brick

As an alternative to unwieldy traditional brick sample panels, Acme Brick now offers a "fan" style color guide for its 67 commercial brick blends. The guide is organized by color families, coded for sizing, and is small enough that it can fit in a briefcase or coat pocket. Acme Brick Company, Fort Worth, Tex. www.brick.com **CIRCLE 239**



For more information, circle item numbers on Reader Service Card or go to www.archrecord.com, under Products, then Reader Service.

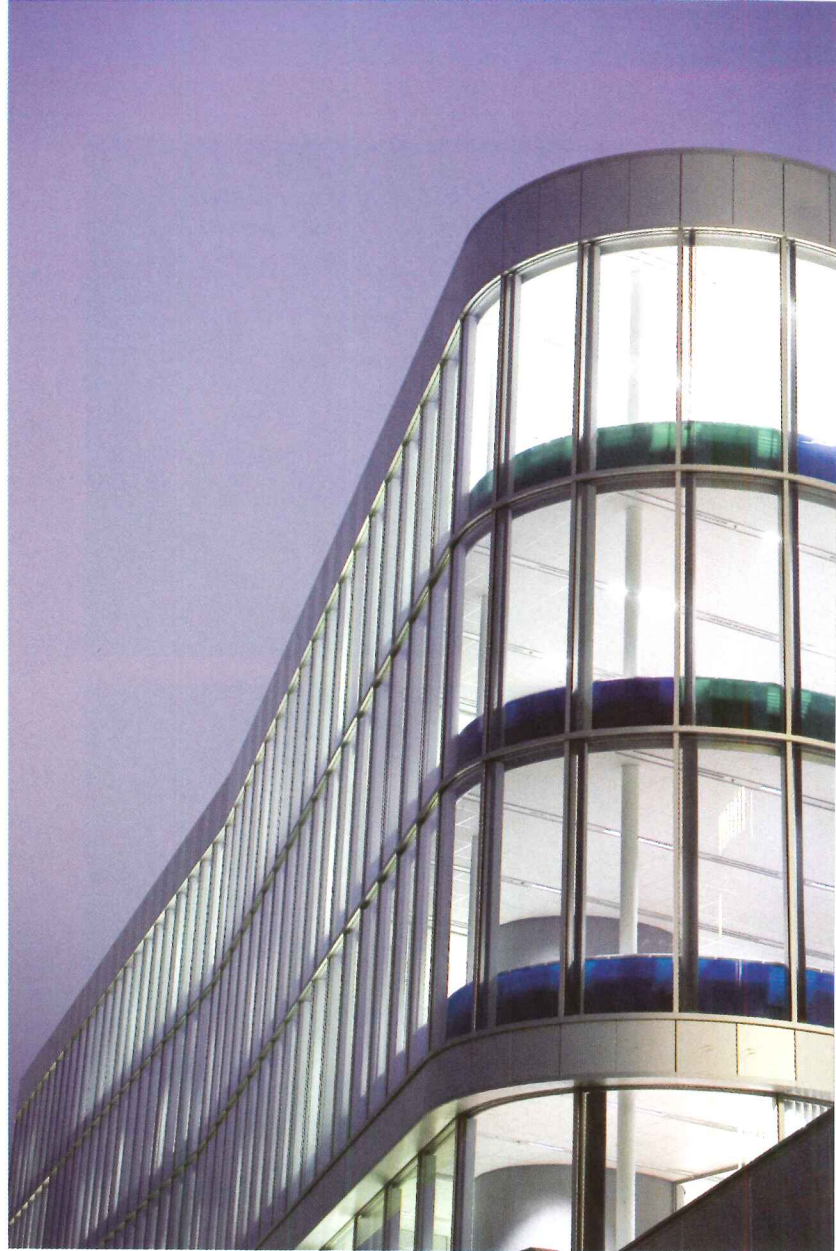

M-Series Linear Fluorescent Lighting

The sophisticated simplicity and elegance of the M-Series encourage a harmonious solution to any project challenge. Understated Elegance, Light and Small. Endless options for shadowless continuous light. Please call for our new specification guide.

se'lux®

Light. Ideas. Systems.

www.selux.com/usa
(800) 735-8927

CIRCLE 75 ON READER SERVICE CARD OR GO TO ARCHRECORD.CONSTRUCTION.COM/PRODUCTS/



DAHLIA



ORGANZA



BOUQUET

Sheer Embossed Crystal

CHARLES LOOMIS, INC.
425.823.4560 / 800.755.0471 / www.charlesloomis.com

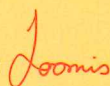

CIRCLE 76 ON READER SERVICE CARD OR GO
TO ARCHRECORD.CONSTRUCTION.COM/PRODUCTS/

Product Resource: On the Web

www.sherlink.sherwin.com/ swapp/color_visualizer

The Sherwin-Williams Color Visualizer Web site just received the 10th annual Webby Award for excellence in Web design. The free site lets the user apply single colors or color schemes to available interior and exterior photos at the click of a button. One caveat: The site requires the latest version of Flash.

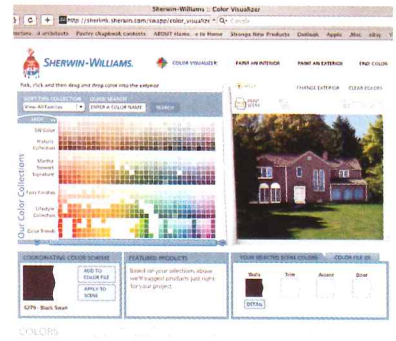

www.concretethinker.com

To provide an online green building resource for architects, the Portland Cement Association has launched a lively new Web site. The comprehensive site includes cross-indexed case studies, a list of the many uses of concrete, and a virtual city with pop-up buttons that help bring all of the information on the site to life.

www.zucchettidesign.it

Zucchetti's revamped Web site now showcases its designer faucets in five different languages. Despite a few technical kinks, the well-organized site features information on product designers, product photos, press releases, and an interactive map of the Zucchetti worldwide sales network.



www.realmdekor.com

Realm Dekor's Web site presents its line of Modernist home furnishings with a touch of quirky humor. A goldfish bowl is called a "Fish Condo," and cleaning products, including a faux-fur broom, are listed under "Necessary Evils." Lots of helpful mouseovers make for easy shopping.

As GREEN As You Can Get

When Firestall® or Easy Ply® Roof Deck Tops Off Your Next LEED™ Project

Call Us For Data and Installation Instructions

Dial Tech Support at 800-257-9491 Ext. 1332

Structural Fire-Rated Assemblies

UL® P500 Series: P-518, 535, 536 and Others

Daylighting High-Performance for Open Plenums

Reflective or Natural Finishes

Commercial Roof Lines

With Residential Looks

Combine With Thermasote® or N.C.F.R.® Thermasote®

R-30 and More

Up to 98% Post-Consumer Recycled Content

Specify Homasote® and *Every Day is Earth Day™*. America's oldest manufacturer of building products from recycled materials

More than 3,000 architects and specifiers have attended AIA-approved, CES, *Rethinking Materials in the Context of LEED™*. Call 800-257-9491 Ext. 1215 for a free presentation at your firm.

homasote

COMPANY

932 Lower Ferry Road., P.O. Box 7240, West Trenton, NJ. 08628-0240
609-883-3300 • 800-257-9491 Sales Extension 1500 • Fax: 609-883-3497 • www.homasote.com



CIRCLE 77 ON READER SERVICE CARD OR GO
TO ARCHRECORD.CONSTRUCTION.COM/PRODUCTS/

Kalwall®

Since 1955

50 Years of Innovation!

...Light-Years Ahead!™

The leader in daylighting.

The most highly insulating fenestration...
LEED™ credit Contribution in 6 separate categories.

Now... with Super-Insulating Nanogel®.

800-258-9777 (N. America)

See more at kalwall.com

For monumental, translucent clearspan Skyroof™ systems, consider our strategic partners...

Structures Unlimited, Inc.

And for tensioned fabric structures...

SPAN SYSTEMS, INC.

CIRCLE 78 ON READER SERVICE CARD OR GO
TO ARCHRECORD.CONSTRUCTION.COM/PRODUCTS/

Fletcher Priest Architects: Chris Gascolgue/View Photo



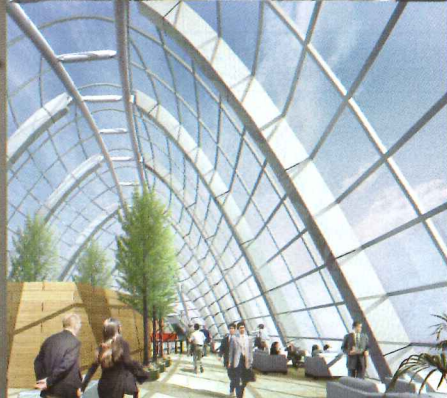
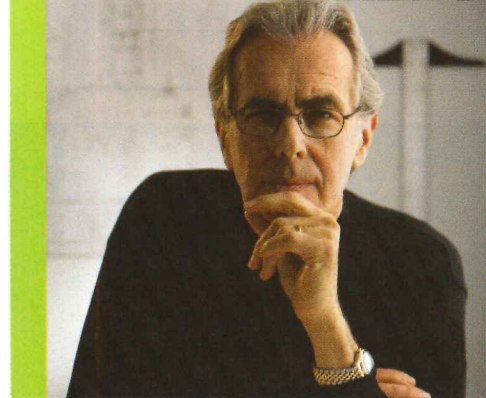
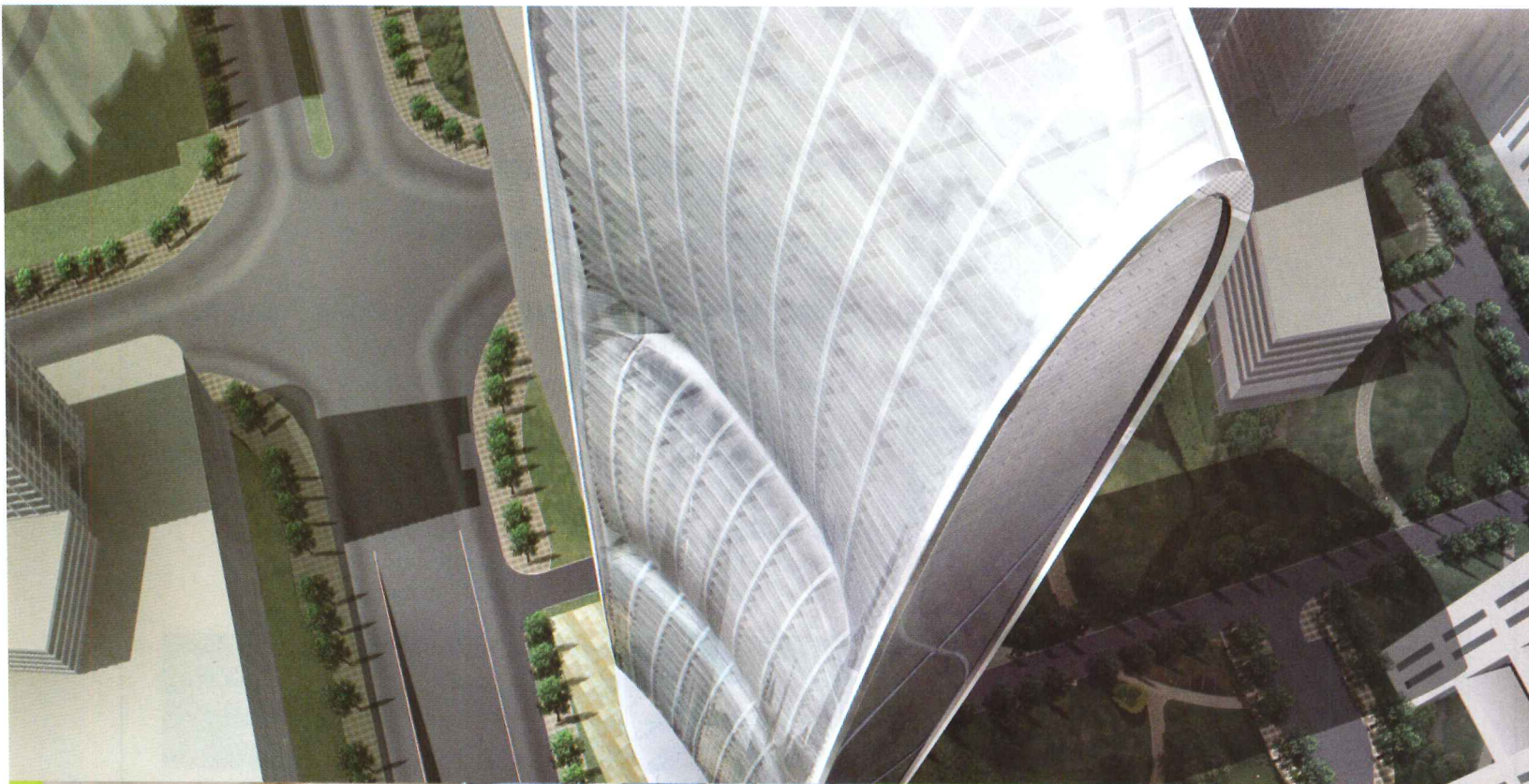

“I know the basics. Now I need to be inspired. Show me innovations shaping the future of sustainable design.”

Now you can.

Architectural Record Innovation Conference

October 11-12, 2006
New York City

Sustainable design that makes you say “Hmm!”

For two days in October, experience advanced thinking that's poised to transform the sustainability movement.

Imagine where this knowledge can take you...

Imagine the possibilities...

Be there when the future is revealed at *Architectural Record's* annual conference on innovations in technology and design.

Now, imagine more...

Reserve your seat today!

Agenda and registration forms are available at:
www.construction.com/event/2006innovation/

*Skidmore Owings and Merrill's Pearl River Tower (above) will be built in Guangzhou, China.



Key Corporate Sponsors:



Go to www.construction.com/event/2006innovation/

Dates & Events

New and Upcoming Exhibitions

Investigating Where We Live **Washington, D.C.**

Opening August 18, 2006

Celebrate the opening of this new exhibition showcasing the results of the National Building Museum's five-week outreach program "Investigating Where We Live" (IWWL). IWWL teaches young people to use photography as a tool for exploring and documenting neighborhoods in Washington, D.C. Through this process they gain an understanding of city planning, architecture, photography, and exhibition design. As part of a partnership with the Anacostia Community Land Trust, participants explored three neighborhoods in the Southeast quadrant of the city. At the National Building Museum. Call 202/272-2448 or visit www.nbm.org.

Team 10: A Utopia of the Present **New Haven**

September 5–October 20, 2006

In 1956, several young architects from England, France, the Netherlands, and Italy were charged with organizing the 10th meeting of the International Congress of Modern Architecture (CIAM), a formal gathering of proponents of Modernism. This multimedia show pays homage to the coterie of Pan-European architects who, challenging the orthodoxies of Modernism in post-World War II Europe, raised issues of urban design that continue to reverberate in architectural discourse today. This exhibition draws on a range of resources and media that includes correspondence, transcripts, tape recordings, photographs, drawings, and film. At Yale's landmark Art & Architecture Building. Call 203-432-2288 or visit www.architecture.yale.edu.

The Loop: Designs for a Vertical City **Chicago**

September 8–November 25, 2006

An exhibition of original conceptual and design drawings, working blueprints, and hectographs from the historic archives of D.H. Burnham and Company. ArchiTech's collection of vintage photographs by Richard Nickel and Aaron Siskind capture the heroic era of building in Chicago's famed Loop, the epicenter of skyscraper invention. At ArchiTech Gallery. Call 312-475-1290 or visit www.architechgallery.com.

Some Assembly Required: Contemporary Prefabricated Houses **New Haven**

October 27, 2006–February 2, 2007

This exhibition featuring the work of eight contemporary architecture studios demonstrates how far prefabricated homes of the digital age have come from the "straight-off-the-assembly-line" look of the mid-20th century. At the Yale School of Architecture. Call 203-432-2288 or visit www.architecture.yale.edu.

Ongoing Exhibitions

Todd Eberle: Architectural Abstractions **Chicago**

Through August 13, 2006

A traveling exhibition of Todd Eberle's works, which subvert traditional ways of picturing architecture. In these 13 large-format photographs, Eberle takes the most unlikely architectural details and recasts them as haunting, abstract images. In his work, photography is not a means to identify or document buildings; rather, it is a means to isolate supposedly "mundane" architectural elements, such as fluorescent light panels and tiles, and give them new life as glowing, mesmerizing compositions in their own right. Eberle draws his subjects from the most widely known architects of the modern era, including Frank Lloyd Wright, Adolf Loos, Gordon Bunshaft, and Philip Johnson. At the Art Institute of Chicago. Call 312/443-3600 or visit www.artic.edu.

Alvaro Siza/Architect: Drawings, Models, Photographs **Santa Monica, Calif.**

Through August 19, 2006

The first museum survey in the United States to explore the distinguished 50-year career of Portuguese architect and Pritzker Prize-winner Alvaro Joaquim de Meio Siza Vieira. The exhibition's drawings, models, and photographs illustrate the attention to spatial relationships, sensitivity to material and texture, and use of light as an expressive and active element. At the Santa Monica Museum of Art. Call 310/586-6488 or visit www.smmoa.org.

From Wood to Architecture: Recent Designs from Finland **New York City**

Through August 25, 2006

This exhibition takes a fresh look at the possibili-

{avant-garde}



{organic}



{flowing}

Tom Barber

Gyford Productions™ presents the Tom Barber Furniture Collection™. The patented fermatspace design system uses stainless steel tubing and wire, laced together so none of the members touch. This kinetic collection is ever-growing and challenging contemporary design aesthetics as never before.

GYFORD PRODUCTIONS • 775.829.7272
standoffsystems.com

CIRCLE 79 ON READER SERVICE CARD OR GO
TO ARCHRECORD.CONSTRUCTION.COM/PRODUCTS/

“To talk to me about **sustainability** is like talking to me about giving birth. Am I against giving birth? **No.** But would I like to spend my time doing it? Not really. **I'd rather go to a baseball game.”**

PETER EISENMAN
Metropolis, October 2001

{ NOW in
Washington DC
SUSTAINABILITY
AND Major League Baseball }



**NEW DIRECTIONS
IN SUSTAINABLE
ARCHITECTURE & DESIGN**

AT THE **National Building Museum**

EXHIBITION AND ACCOMPANYING BOOK

Featuring the Architecture and Design of:

Rick Joy

Michelle Kaufmann

Shigeru Ban

Peter Carmichael

Steven Holl

THROUGH **June 3, 2007**



401 F Street, NW
Washington, DC 20001
202.272.2448
www.nbm.org

PRESENTING SPONSOR: The Home Depot Foundation
LEAD SPONSORS: ASID Foundation, Bosch home appliances, Portland Cement Association
MAJOR SPONSORS: Benjamin Moore® Paints, EPA/Energy Star, The Nathan Cummings Foundation, U.S. Department of Energy
PATRON SPONSORS: Global Green, Band, Inc., James G. Davis Construction Corp.
MEDIA SPONSOR: Dwell

Dates & Events

ties offered by the oldest of building materials: wood. Organized by the Museum of Finnish Architecture, the exhibition explores the current resurgence of wood as a building material. The show presents 17 recently constructed buildings in Finland, ranging from cultural centers to summer cottages to churches. The architects include established, internationally known figures such as Kristian Gullichsen, Mikko Heikkinen, and Markku Komonen, as well as a new generation of young designers, including Anssi Lassila and Ville Hara. At Scandinavia House: The Nordic Center in America. For more information, call 212/879-9779 or visit www.scandinaviahouse.org.

Joe Colombo: Inventing the Future Weil am Rhein, Germany

Through September 10, 2006

One of the most successful designers of his time, Colombo produced design classics such as the Elda armchair, the Universale chair, and the Alogena lamp. Colombo died in 1971 at 41. Produced in close cooperation with his estate, the exhibition—the first international retrospective of Colombo's work—presents an abundance of never-before-shown materials. These include early original objects and prototypes of his most important furniture designs, as well as many original rough sketches, plans, brochures, architectural models, and several films and original photos. At Vitra Design Museum. For more information, call 49 76 21 702 3200 or visit www.design-museum.de.

Prairie Skyscraper: Frank Lloyd Wright's Price Tower

Through September 17, 2006

Organized by Price Tower Arts Center (Bartlesville, Oklahoma) in cooperation with the Frank Lloyd Wright Foundation (Scottsdale, Arizona), Prairie Skyscraper will present for the first time a comprehensive selection of the Arts Center's collection of historic artworks and objects relating to the Price Tower, including never-before-exhibited Wright documents and drawings from its own holdings and from those of the Wright Foundation's archives. At the National Building Museum. For more information, call 202/272-2448 or visit www.nbm.org.

Crafting a Modern World: The Architecture and Design of Antonin and Noemi Raymond

Through September 24, 2006

Antonin Raymond (1888–1976) and Noemi Raymond (nee Pernessin, 1889–1980) were married in 1914 and worked as partners in design for more than 60 years. Through their works, the Raymonds were able to forge a meaningful connection with the ancient traditions of Japan that widened the visual as well as the nonvisual possibilities of Modern design. This retrospective includes some 200 works, including drawings, models, photographs, videos, furniture, and other objects. At the University of Pennsylvania School of Design. Call 215/898-8323 or visit www.design.upenn.edu.

Artist's Choice: Herzog & de Meuron New York City

Through September 25, 2006

The seventh exhibition in MoMA's *Artist's Choice* series, in which contemporary artists are invited to select, juxtapose, and comment on works from the museum's collection. Drawing from across the museum's departmental collections, the internationally renowned architects Jacques Herzog and Pierre de Meuron approach the collection not as conventional curators, but as architects. At the Museum of Modern Art. Call 212/708-9400 or visit www.moma.org.

Best of Friends: Buckminster Fuller and Isamu Noguchi

Through October 15, 2006

The relationship between the artist Isamu Noguchi and visionary designer and inventor Buckminster Fuller is illuminated in this special exhibition, which includes models, sculptures, drawings, photographs, film footage, and letters. At the Noguchi Museum. Call 718/204-7088 or visit www.noguchi.org.

Insight Out Knislinge, Sweden

Through October 22, 2006

An exhibition of eight American artists showing site-specific installations in the Park, in the Stable, and in the Sculpture Yard surrounding the Wanas medieval castle. The work investigates subject matter such as architecture, narrative, scientific processes, and psychological perception. At the nonprofit Wanas Foundaton. Call 46 44 660 18 or visit www.wanas.se.

Zaha Hadid New York City

Through October 25, 2006

The first woman to be awarded the distinguished Pritzker Architecture Prize, which she won in 2004, Hadid is internationally known for both her theoretical and academic work, as well as a portfolio of built projects that have literally "shifted the geometry of buildings." This exhibition provides a comprehensive look at her projects worldwide. True to Hadid's interdisciplinary approach to architecture, there is a wide range of mediums on display, including painting, drawing, large-scale urban plans, proposals for international design competitions, building designs for contemporary cultural and sports facilities, and documentation of current projects under construction. At the Solomon R. Guggenheim Museum. Call 212/423-3500 or visit www.guggenheim.org.

Seattle Architecture Foundation Tours Seattle

Through October 28, 2006

Seattle Architecture Foundation connects people to architecture through popular guided walking tours, exhibitions, youth programs, and public forums—programs that inspire participants to engage in shaping their community. Visit www.seattlearchitecture.org.

Cantilever-Chairs: Architectural Manifesto and Material Experiment Vienna

Through October 29, 2006

The Cantilever-Chair represents one of the most significant products of avant-garde design of the 1920s. These steel-tube chairs stem from the Bauhaus movement and the German Werkbund, and still challenge architects and designers today to experiment anew with their form and material. The exhibition covers more than 80 years of innovative suspension design with chairs by Marcel Breuer and Ludwig Mies van der Rohe, right up to Tom Dixon and Ross Lovegrove. In the MAK Study Collection Rooms. Visit www.mak.at.

The Chicago Architecture Foundation Architecture River Cruises Chicago

Through November 19

Led by trained volunteer docents, these cruises are well known as highly enjoyable as well as educational. They visit 53 historic sites that include the Wrigley Building, Merchandise Mart, the Tribune Tower, Sears Tower, Marina City Towers, River City, and many more. The docents

also provide background information on the lives of many of Chicago's famous architects and firms: Daniel Burnham, Graham Anderson Probst, Bertrand Goldberg, Mies van der Rohe, Helmut Jahn, Skidmore, Owings & Merrill, and Kohn Pedersen Fox. The cruises start at the southeast corner/lower level of the Michigan Avenue Bridge, just below the Hyatt Regency Chicago Hotel. Call 312/902-1500 or visit www.architecture.org.

Lectures, Conferences, and Symposia

The Public Realm: A Series of Civic Forums: Parts 2 and 3 Houston

August 9 and September 6, 2006

The Civic Forum series on the Public Realm presented by Houston's Rice Design Alliance focuses on the areas of the city where significant transformation has been or will soon be experienced. The series aims to discuss these changes in a manner that relates directly to the overall community of greater Houston. At the Museum of Fine Arts, Brown Auditorium. Call 713/348-4876 or visit www.rice.edu.

Lecture: David Hertz and the McKinley House—A Case Study in Green Residential Design Washington, D.C.

August 10, 2006

With so many technologies available to make a house sustainable—solar panels, geothermal heat pumps, recycled building materials, and more—selecting from these choices and incorporating the technologies into an aesthetic design can be a challenge. David Hertz, principal of the Santa Monica-based firm David Hertz Architects/Syndesis and creator of Syndcrete, a "green" concrete, will discuss the design technologies employed in his McKinley House. This program complements the exhibition *The Green House*, which will be open for viewing. At the National Building Museum. Call 202/272-2448 or visit www.nbm.org.

Films: An Evening with FLW Washington, D.C.

August 16, 2006

Frank Lloyd Wright built his legacy as one of the greatest 20th-century architects through his buildings, teachings, and writings. The National Building Museum presents an evening of conver-

Cost estimating data you can count on!

The 2005 Sweet's Cost Guides

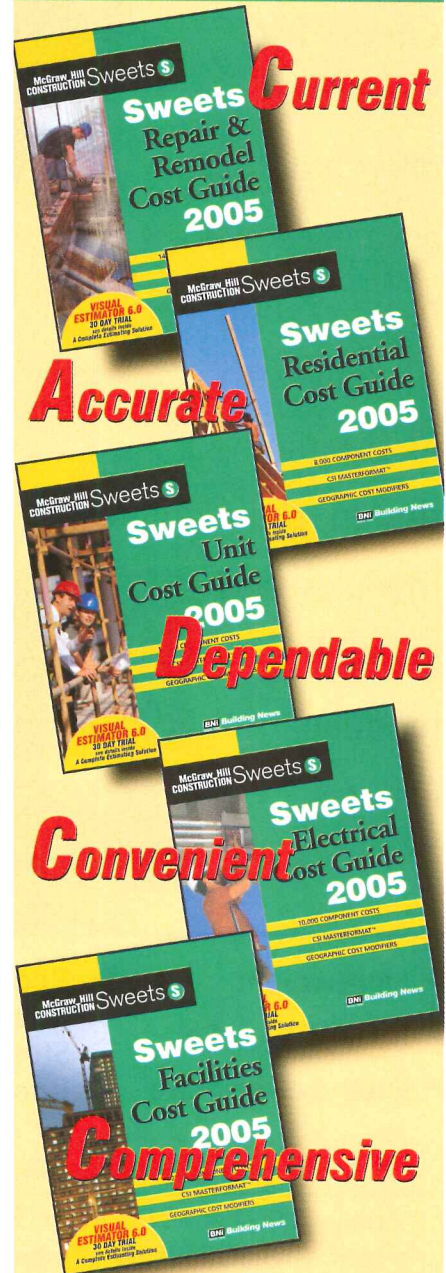

CALL 1-888-264-2665

Please specify priority code 444T

McGraw-Hill
CONSTRUCTION Sweets **S**

BNI Building News

1612 S. Clementine, Anaheim, CA 92802
www.bnibooks.com

GREENGRID®

The Natural Choice for Your Roof



The PREMIER Green Roof System

The GreenGrid® System

offers a distinct advantage over more complex systems with its simplicity of design, pre-planted modules, and movable modular features.



- ▶ Lightweight
- ▶ Installs Quickly
- ▶ Extends Roof Life

- ▶ Reduces Energy Costs and Stormwater Run-off



Contact Information:

phone: 312-424-3319 • fax: 312-424-3330
e-mail: GreenGridRoofs@WestonSolutions.com
website: www.GreenGridRoofs.com



GreenGrid® is a registered trademark of
American Builders & Contractors Supply, Co.

CIRCLE 80 ON READER SERVICE CARD OR GO
TO ARCHRECORD.CONSTRUCTION.COM/PRODUCTS/

Dates & Events

sations with and about Wright with two film screenings. *Frank Lloyd Wright: The Mike Wallace Interviews* (1994, 53 min.) documents the architect in conversation with Mike Wallace in 1957. *The Frank Lloyd Wright Way* (1997, 60 min.) shares perspectives on Wright from four of his apprentices. This program complements the exhibition *Prairie Skyscraper*, which will be open for viewing. At the National Building Museum. Call 202/272-2448 or visit www.nbm.org.

London Design Festival 2006 London

September 15–30, 2006

Established in 2003 to celebrate and promote London as the creative capital of the world, the London Design Festival (LDF) has rapidly grown to become one of the key constituents of the U.K.'s burgeoning festival season, along with London Fashion Week and the London Film Festival. Disciplines include architecture, fashion, furniture, textiles, craft, product, digital, interiors, and jewelry. Visit www.londondesignfestival.com.

Lecture: Structure, Identity, and Existence in the Work of Team 10

New Haven

September 18, 2006

The distinguished architect and author Kenneth Frampton will deliver a lecture in connection with the exhibition *Team 10: A Utopia of the Present*. At the Yale School of Architecture. Call 203/432-2288 or visit www.architecture.yale.edu.

Symposium: Team 10: Thoughts on a Shiny New Brutalism New Haven

September 21, 2006

This symposium, offered in conjunction with the Yale exhibition on Team 10, examines the legacy of the group as it intersects with contemporary architectural thought and production. Long marginalized, the

work of Team 10 and its core protagonists Aldo van Eyck, Alison and Peter Smithson, Giancarlo de Carlo, and Shadrach Woods is the subject of renewed historical and theoretical interest as architectural discourse turns once again to the intersections of architecture, urbanism, infrastructure, landscape, and society. Participants include Thomas Avarmaete, Peter de Bretteville, Keith Krumwiede, Ana Miljacki, and Alan Plattus. At the Yale School of Architecture. Call 203-432-2288 or visit www.architecture.yale.edu.

Resurfacing the City: A Lecture Series Houston

September 27–October 18, 2006

This lecture series will examine the renewed role of landscape and its emergence as an important motif in the discourse on architecture and urbanism. It will bring together the most innovative practitioners and thinkers of landscape as urbanism. James Corner of Field Operations will present the opening lecture. At the Museum of Fine Arts, Brown Auditorium. Call 713/348-4876 or visit www.rice.edu.

Urban Waterfronts 24: Celebrating 20 Years of Excellence on the Waterfront Portland, Ore.

September 28–30, 2006

The Waterfront Center's annual international conference. Call 609/884-7997, 202/986-2549, or visit www.waterfrontcenter.org.

Symposium: The Dynamic Economies of Asia and Global Wellness—Opportunities for the Pittsburgh Region Pittsburgh

October 3, 2006

This symposium raises scholarship money for Carnegie Mellon School of Architecture students. The goal is to connect the business, medical, policy, architecture, and the academic fields together to recognize ways to adapt

metro regions into a global economy. At Carnegie Mellon School of Architecture, McConomy Auditorium and Rangos Ballroom. Call 412/268-9554 or visit www.andrew.cmu.edu.

**Pacific Crossings:
2006 AIA Northwest & Pacific
Region Conference and
AIA Committee on Design Fall
Conference**

Hong Kong and Shanghai

October 16–22, 2006

AIA Hong Kong in collaboration with the AIA Committee on Design hosts *Pacific Crossings*, a week-long event that merges the 2006 AIA Northwest & Pacific Region Conference with the AIA Committee on Design Fall Conference. Beginning in Hong Kong and concluding in Shanghai, *Pacific Crossings* features a wealth of professional, educational, and cultural activities. For information, visit www.aiahk.org, or call 852/2882-6011 or 202/626-7468.

Competitions

**Tokyo Lights International
Design Competition for
Street Lighting**

*Proposal Submission Deadline:
August 25, 2006*

An international competition for a new street lamp design. The winning design will be used to renew the street lamps along Tokyo's Chuo-dori Street running through the areas of Ginza, Kyobashi, and Nihonbashi. This competition aims to present a new model for street lighting in harmony with the city landscape in Chuo-dori, one of the major streets in Japan. The competition is open to designers in the areas of lighting design, urban landscaping, architecture, industrial and product design, and the arts. Visit www.tokyolights.jp for further information.

**Imagining Penn Center: A
National Student Design**

**Competition to Plan New Life
for Philadelphia's
Central Civic Space**

Deadline: September 15, 2006

Penn Center is one of Center City Philadelphia's most important spaces, housing Suburban Station, office towers, retail, and public plazas. Originally conceived by the late Edmund N. Bacon, Philadelphia's renowned former planning director, Penn Center changed the face of the city when it was built in the 1960s as one of the largest and most ambitious downtown redevelopments of its time. Today, Penn Center is vastly underutilized by the public, yet it holds great potential for revitalization. The Ed Bacon Foundation challenges students to imagine the site's potential and to generate ideas for restoring this important space as a modern Philadelphia epicenter and icon. For additional information, visit www.edbacon.org/penncenter.

**Fire Station Design Awards
Program**

Deadline: September 15, 2006

The Fire Industry Equipment Research Organization (FIERO), in conjunction with the International Association of Fire Chiefs (IAFC) and *Fire-Rescue* magazine, invites submissions for its awards program to encourage excellence in fire-station design. The awards program is being held in as a part of FIERO's 5th National Symposium on Fire Station Design. Visit www.fierofirestation.com.

**BSA's 2007 Research Grants
in Architecture Program**

Deadline: September 22, 2006.

Individuals and teams (architects, academics, designers, product developers, students, etc.) in the national design and construction industry seeking support for an original research project are encouraged to submit applications to the BSA's 2007 Research Grants in Architecture program. The BSA is

How do you Swing?

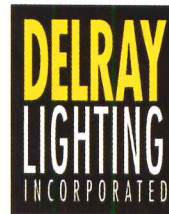
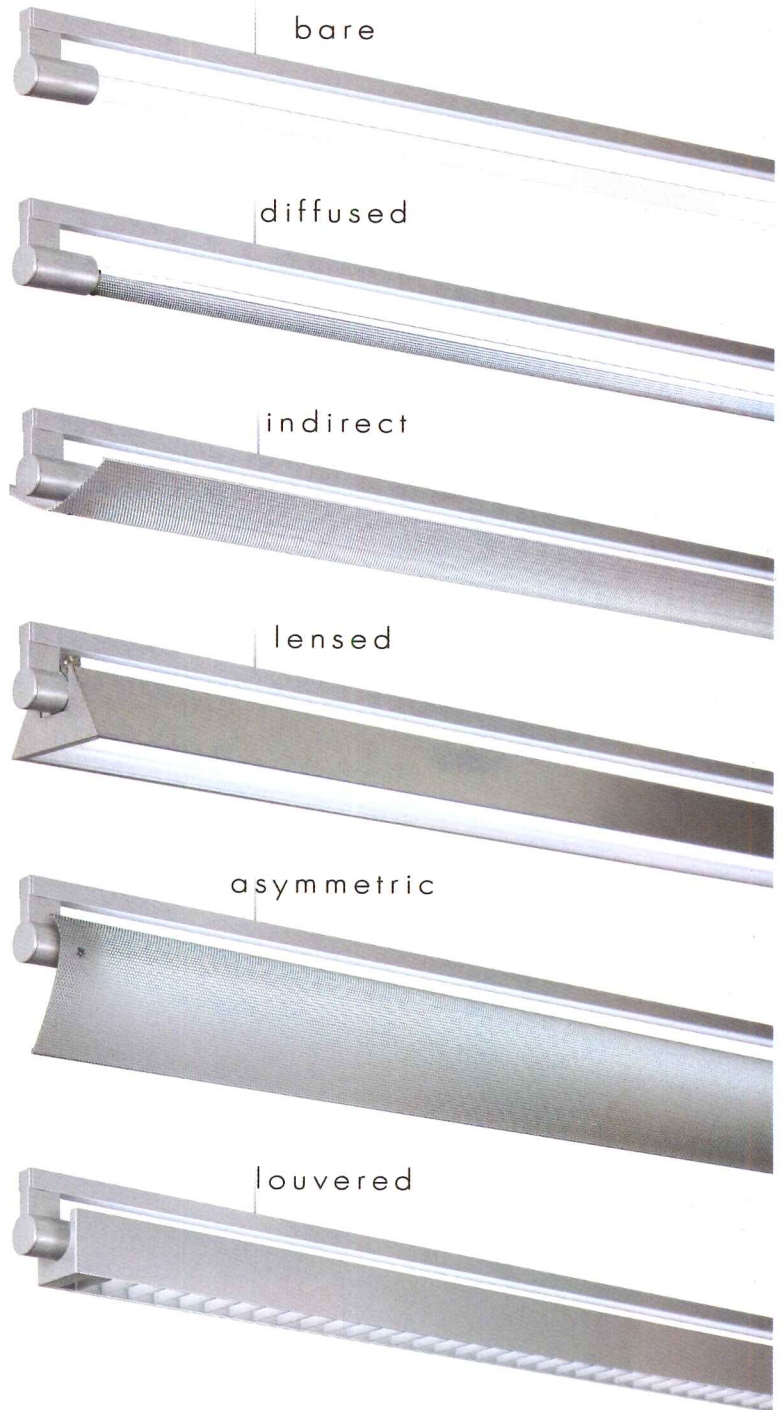

delraylighting.com

CIRCLE 81 ON READER SERVICE CARD OR GO
TO ARCHRECORD.CONSTRUCTION.COM/PRODUCTS/



What's on your mind?

From retail design to urban design, the AIA's Knowledge Communities connect you with like-minded architects. Use your head—go to www.aia.org/knowledge and join today. Find the Knowledge Community that's right for you and network with architects who share your interests.

Whatever you're interested in, the American Institute of Architects has a Knowledge Community for you.

AIA Knowledge Communities



What the best-dressed
homes wear.

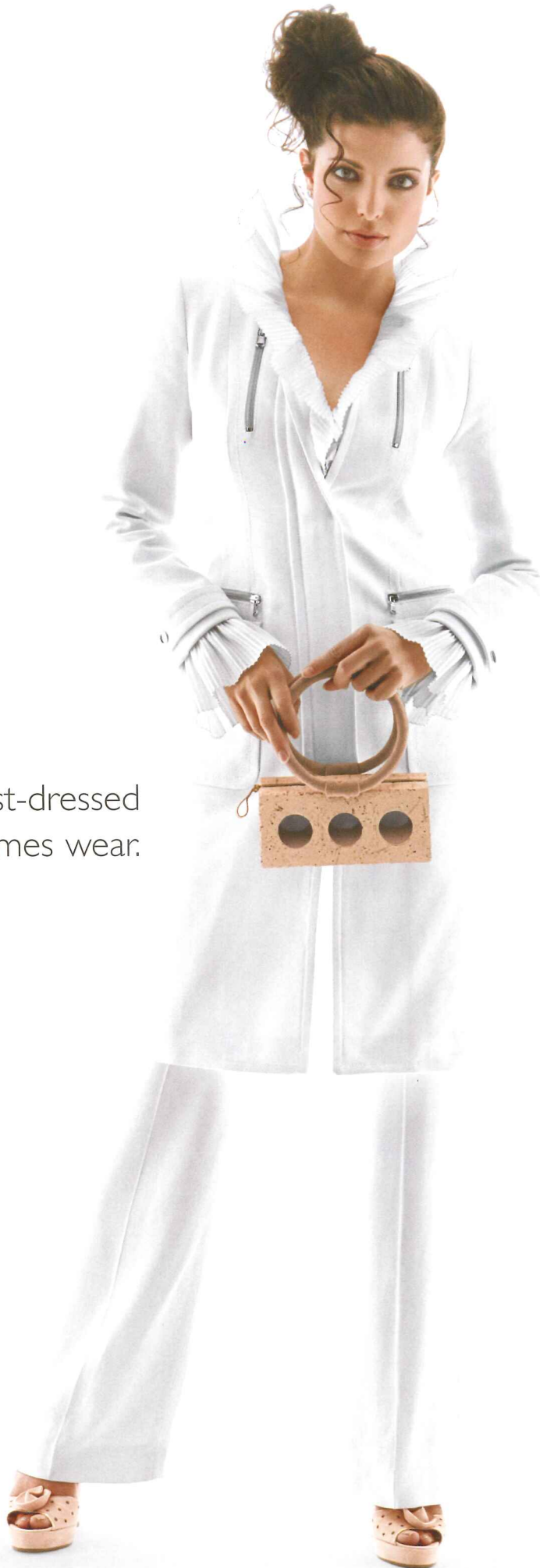

Fashion comes in many forms, which is why Hanson Brick offers hundreds of colors and textures to turn the house you design into a home. To learn more about our products, call 877-HANSON8 or visit us at www.hansonbrick.com.

 **Hanson**
The face of brick™



Pinnacle of Style

Your customers want roofing materials that reflect their personal style and Hanson Roof Tile has the exceptional products they desire. With hundreds of combinations of colors and profiles from which to choose, Hanson Roof Tile crowns the buildings you design with a look that appeals to style conscious buyers.

For the finest roof tile and service in the industry visit us at www.hansonrooftile.com.
*Roof tile shown: Regal Meadow

 **Hanson**
The name you can look up to



American Institute of Architecture Students

Life safety, dignity and comfort are the foundation of and the reason for Freedom by Design™. Freedom by Design is an AIAS-led program that utilizes the talents of architecture students in service to their communities by helping individuals with physical challenges. Minor modifications to the homes allow individuals to live safely, comfortably and with dignity by addressing their struggle with everyday tasks such as getting in and out of showers, ascending stairs, or egress to the home itself.

Through its 130 chapters, the AIAS is implementing a program that involves students resolving accessibility issues, and simultaneously provides the students with the "real world" experience of working with a client, mentorship from a local architect, and an understanding of the practical impact of architecture and design.

You are invited to get involved. The AIAS is seeking mentors and supporters to help us grow this important program. Please help us help others. To learn more, visit www.aias.org/freedom.

FREEDOM BY DESIGN™

SAFETY. DIGNITY. COMFORT.



The AIAS is an independent, non-profit, and student-governed organization that is the sole official student voice in the profession. 50 YEARS OF LEADERSHIP: CONNECTING. INTEGRATING. UNITING.



Patented



Building on Our Tradition

Bil-Guard®

Hatch Rail System

- Independently tested and proven to exceed OSHA fall protection regulations for guardrails (CFR 1910.23)
- Quick, simple installation using basic tools (no training or certification required)
- Standard self-closing gate feature
- Corrosion-resistant construction carrying a 25-year warranty
- High-visibility safety yellow color
- Non-penetrating attachment
- Available in a variety of sizes to fit all brands of roof hatches



Self-Closing Gate Hinge
Ensures continuous protection



Pivoting Mounting Sleeve
For installation flexibility

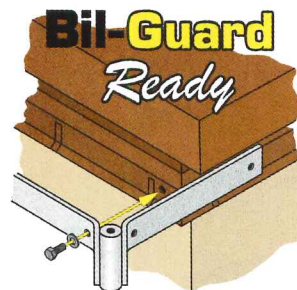

NEW!

Roof products are now supplied with pre-punched capflashing to receive the hatch rail system

For more information call (203)934-6363 or log on to www.bilco.com

CIRCLE 89 ON READER SERVICE CARD OR GO TO ARCHRECORD.CONSTRUCTION.COM/PRODUCTS/

Free AIA Continuing Education

AEC Daily

Learn & Earn!

Take a Continuing Education Course at AEC Daily and you could be a winner!



aecdaily.com
AECDAILY
CONSTRUCTION • INFORMATION • RESOURCES

Every month you could win \$100 just for successfully completing any of over 100 free online AIA-certified courses at AEC Daily's Online Learning Center. You could also win bonus prizes from Sealflex, Whirlpool, or Benjamin Moore for their courses. No purchase/course necessary. Visit www.aecdaily.com/contest for complete information.

877-566-1199 ext. 801
www.AECDaily.com

| Circle Reader Service #150

Pre-Engineered Railings

Handrail Design, Inc.

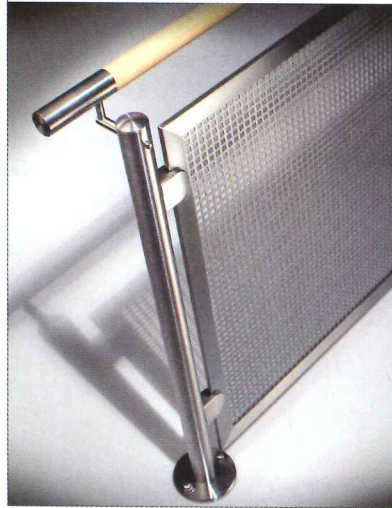

CIRCUM™ stainless railing system: Manufactured of corrosion-resistant stainless steel, CIRCUM is ideal for interior or exterior applications in commercial and residential facilities. Infill panels available in, but not limited to, perforated stainless steel, tempered glass, and stainless steel rods. Handrails in wood/stainless, stainless, or colored nylon. Curved rails and custom designs are available. HDI Railing Systems. Email info@hdirailings.com

717-285-4088
www.hdirailings.com

| Circle Reader Service #153

Pass the ARE 3.1. Study With Archiflash

Nalsa

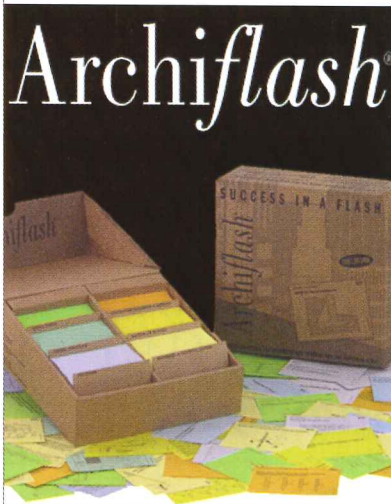

Get the NEW 6th Edition. Celebrating Over 13 years of Success. Prepare for the Architect Registration Exam with Archiflash. Each set contains 1,152 expertly written flashcards covering all six multiple choice tests: Pre-design, General Structures, Lateral Forces, Mechanical & Electrical Systems, Building Design/Materials & Methods, and Construction Documents & Services. Learning is easy with timesaving charts, definitions, diagrams, and multiple choice Q & A. More information than you ever thought possible in an easy-to-use flashcard format. Only \$109.95. Individual divisions available for \$27.00 each.

800-411-7314
www.archiflash.com

| Circle Reader Service #151

Handrail Systems

P & P Artec



P & P Artec Modesto system, has 1 single round baluster. All fittings are powder coated. Their other systems include the Chicago - (flat bar baluster), Double Baluster - (2 round balusters), and Munich - (3 oval baluster). Artec has built a reputation in 100% seamless handrail tubes. All of their systems are assembled and finished in the field, to provide each project a unique custom installation, without any visible joints.

630-860-2990
www.artec-rail.com

| Circle Reader Service #154

Thin Stone Cladding Systems

Thin Stone Systems, LLC



Thin lightweight natural stone wall cladding by THIN STONE SYSTEMS, LLC offers economical solutions for new construction and renovation, for both exterior and interior. Reinforced by a special patented process, the thin veneer panels of natural granite, marble, or limestone are applied to a structural framing system of extruded aluminum. Weighing only 6-lb. psf, the wall system provides many advantages including speed and simplicity of installation.

212-838-7667
www.thinstonesystems.com

| Circle Reader Service #152

Beams, Headers & Columns

iLevel™ by Weyerhaeuser



iLevel™ Trus Joist® Parallam® parallel strand lumber (PSL) is known for uniform quality, strength and good looks. iLevel's revolutionary technology delivers beams, headers and columns that are stronger, straighter and longer than conventional lumber. Parallam PSL beams and headers are available in large sections, eliminating field assembly and are compatible with common hardware—making installation quick and easy.

888-iLevel8
www.ilevel.com

| Circle Reader Service #155

Columns, Balustrades and Cornices

Melton Classics, Inc.



Melton Classics provides the design professional with the most comprehensive selection of quality architectural products in the industry, including architectural columns, balustrades, mouldings, cornices, and a wide array of architectural elements. Architectural columns are available plain or fluted, load-bearing or column covers, round or square in fiberglass, fiberglass/marble composite, synthetic stone, cast stone, GFRC, and wood for paint or stain. Melton Classics offers maintenance-free balustrade products ideal for any application.

800-963-3060
www.meltonclassics.com

| Circle Reader Service #156

6-in. Combination Louver Now Available

Airolite



Airolite continues to expand its louver line by offering a new combination louver. Airolite Louver Type K8206A features a drainable fixed blade and airfoil adjustable blade in a 6-in. frame depth with concealed linkage and a sloped sill. This louver can be specified in sizes as large as 60-in.-wide by 96-in.-high. Blade and jamb seals are standard, and different actuator options are available. Airolite Louver Type K8206A is licensed to bear the AMCA Seal for Water Penetration and Air Performance allowing designers to specify with confidence.

740-373-7676
www.airolite.com

| Circle Reader Service #159

Bamboo Plyboard

Smith & Fong Company



Providing a full range of bamboo plyboard for commercial and residential environments coast to coast and worldwide. A refreshing look in sustainable architecture and design. Plyboo® plyboard is a contributing finish under the 6.0 Section of LEED™.

866-835-9859
www.plyboo.com

| Circle Reader Service #157

Extreme Performance Insulating Glass

AZON USA INC.

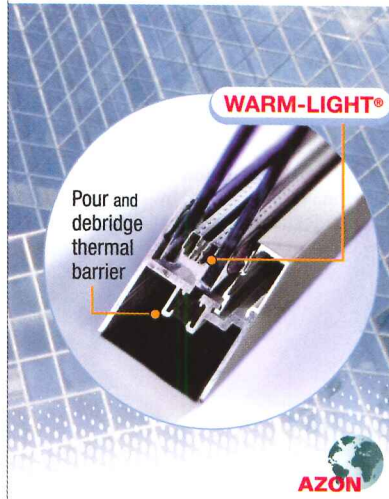

Warm-Light® spacer for insulating glass provides a more comfortable interior environment, reduces thermal conductivity and condensation on the glass surface while lowering utility costs. Azon is the global leader in developing technology for the manufacture of thermal barrier aluminum fenestration, commonly referred to as the pour and debridge method.

800-788-5942
www.warmedge.com

| Circle Reader Service #160

Waterproofing Sheet Membrane

The Noble Company

NobleSeal TS
The best choice for thin-set waterproofing

NobleSeal TS is a thin, sheet membrane that provides uniform thickness and quality. Using TS helps insure watertight installations by minimizing workmanship variables.

Guaranteed to Last.

Simple solutions... Proven performance

Easy to install

Noble Company
800-878-5788
www.noblecompany.com

NobleSeal TS is a sheet membrane for thin-bed waterproofing and crack isolation. TS can be bonded to vertical or horizontal substrates and tile can be thin-set to TS. It's ideal for shower walls, floors, handicapped showers and other applications where a mortar bed is not desired. TS is a sheet membrane which insures uniform thickness and quality and minimizes workmanship variables. Proven performance with millions of square feet installed.

800-878-5788
www.noblecompany.com

| Circle Reader Service #158

Versatile Windows

Fenevations, LLC



Fenevations manufactures MegaWood, Infinity Bronze, and SteelView windows. Megawood offers fine hardwoods with furniture-grade finishes, combined with heavy gauge bronze or hand welded, aluminum extruded exteriors. Infinity Bronze is a unique thermally broken solid bronze system offering beauty, style and traditional sightlines. SteelView offers stainless steel beauty for contemporary designs.

908-688-5710
www.fenevations.com

| Circle Reader Service #161

Opaque Glass Coatings

Goldray Industries Ltd.



LCBA is a colorful opaque glass coating available in a wide palette of standard and custom colors including both solid and metallic. Goldray's glass cladding is an impact-and abrasion-resistant product which has an easy to clean, low maintenance surface. Customize your next project with the color and style of Goldray's opaque glass products.

800-640-3709
www.goldrayindustries.com

| Circle Reader Service #162

Solar Control Glass

Oldcastle Glass®

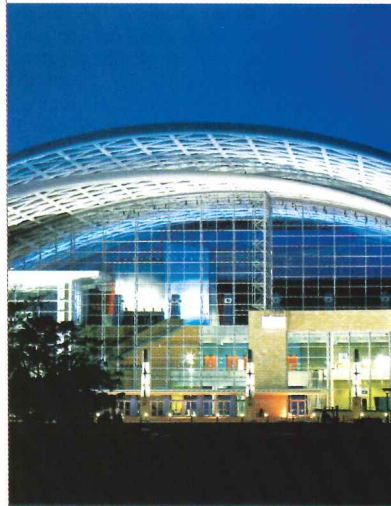

Exclusive, new SunGlass™ Solar Control Glass delivers the beauty of the sun without the heat. Now architects can specify a neutral color glass that invites the sun in without making building occupants sweat. That's because SunGlass™ delivers a combination of unprecedented solar control and visible light transmittance. It's the look you want with the performance you need.

866-OLDCASTLE (866-653-2278)
www.oldcastleglass.com

| Circle Reader Service #165

Anti-Reflective Glass

IGT Glass



Luxar anti-reflective glass is perfect for any glass application where glare and reflection are not wanted. Luxar reduces glare and reflection to less than 0.5%. It is perfect for museums, store fronts, stadiums, restaurants, projection rooms and display cases. It is available on low iron float glass for maximum clarity in 2mm to 12mm thicknesses to meet any project requirement.

480-767-8220
www.luxar.ch

| Circle Reader Service #163

Brochure & Data Sheet

Pilkington Fire Protection Glass North America



Pilkington introduces a new product brochure and technical data sheet. The brochure includes information on both the Pilkington Pyrostop™ Fire Resistant Glass and Pilkington Pyrodur™ Fire Protection Glass products. You can download a copy of the new brochure and data sheet from their web site or call them. The products are available in the U.S. through Technical Glass Products (TGP).

419-478-0165
www.pilkington.com/fire



| Circle Reader Service #166

Curved Translucent FRP Panel Systems

Major Industries, Inc.



When your daylighting project demands something special, the TransCURVE™ translucent building panel system provides exceptional performance, with the added benefit of a striking, unique appearance. TransCURVE™ translucent panels feature a visually attractive aluminum grid core in several popular patterns, giving panels a refined look while maintaining exceptional strength. TransCURVE™ also features a premium architectural-grade FRP exterior skin that blocks damaging UV rays while transmitting the beauty of natural light.

715-842-4616
www.majorskylights.com

MAJOR INDUSTRIES
GUARDIAN 275® TRANSLUCENT DAYLIGHTING

| Circle Reader Service #164

Fire Rated Aluminum Framing

SAFTIFIRST



With SAFTIFIRST's SAFTIfire Frames, rated 45-min. to 2-hr., you can create the maximum barrier against fire and radiant heat while providing attractive framing that meets all the temperature requirements of the national building codes. Design flexibility of multiple forms makes for easy installation, creating a sleek, attractive profile.

888-653-333
www.safti.com

| Circle Reader Service #167

Entrance Products Ideal for Green Construction

Special-Lite, Inc.



Special-Lite Entrance Systems

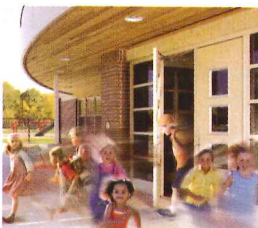

Choose the Doors with More Life...
For Better Quality of Life

Not only are Special-Lite entrance products the first with GREEN-GUARD™ Certification, their durable finishes never need to be painted or refinished reducing maintenance costs and eliminating associated health risks. When compared to hollow metal doors, Special-Lite doors provide superior thermal performance, longer service life for the entire entrance, and lower lifecycle cost. Clearly, Special-Lite doors are the more sustainable choice. To learn more, request Special-Lite's green brochure.

800-821-6531
www.special-lite.com

| Circle Reader Service #168

Carpet Tile

Binvetec, LLC

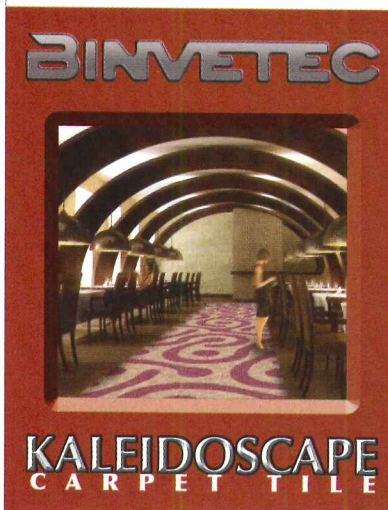

Kaleidoscope Carpet Tile with TractionBac non-adhesive installation system is the only modular floor covering solution that can create a wholly non-repetitive and free-flowing pattern from a single tile design. They can also be arranged in groups to create myriad patterns. Available in nine color combinations, they can be used to create entire wall-to-wall floor coverings, runners, or assembled together to make six-tile area rugs (6-ft. by 9-ft.).

714-731-2369
www.binvetec.com

| Circle Reader Service #171

Fire-Rated Glass & Framing

Technical Glass Products



Technical Glass Products has been a national distributor of fire-rated glazing and framing materials since 1980. They are committed to providing reliable, rapid service and outstanding product options. Their knowledgeable staff can assist you in determining which product is right for your application. Contact Technical Glass Products at 1-800-426-0279 or www.fireglass.com.

800-426-0279
www.fireglass.com

| Circle Reader Service #169

Decorative Wall Panels

Crane Composites / Kemlite Company

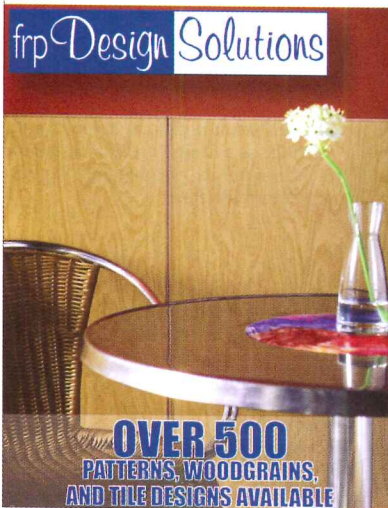

frpDesign Solutions is a family of decorative wall panels that provides an alternative to traditional wall coverings such as ceramic tile, wood paneling or vinyl wall coverings. Offering both functionality and design, products in the frpDesign Solutions line are made of a moisture-resistant frp panel with a decorative finish that includes myriad colors, patterns, and woodgrains, as well as a tile-look panel. Available with over 500 choices, frpDesign Solutions is easy to install and maintain. For more information, visit Kemlite on the web.

888-332-6377
www.frpdesignsolutions.com

| Circle Reader Service #172

Ornamental Plaster Ceiling Tiles

Above View Mfg., By Tiles, Inc.

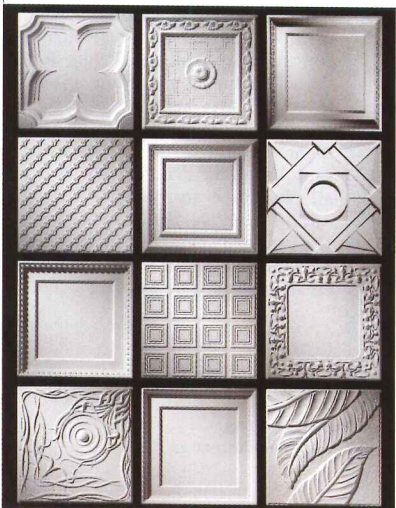

Above View ornamental plaster ceiling tiles are fabricated from a non-toxic, non-combustible, proprietary composition. They drop into any standard 15/16-in. T-Bar grid system. There are more than 50 standard designs, custom design work, and 1,300 custom colors and faux finishes available upon request.

414-744-7118
www.aboveview.com

| Circle Reader Service #170

Custom Column Covers

Eventscape Inc.



Mirrored chrome, and over 150 hand-bent aluminum strips cover these 15 ft.-high custom column covers. Built for the FILA flagship store in NYC; it won the 2006 NASFM Store of the Year. Just one example of the numerous custom column solutions engineered and fabricated to meet your specifications. View their complete portfolio on the Eventscape web site. "Create without boundaries."

416-231-8855
www.eventscape.net

| Circle Reader Service #173

Cast Metal Wall Surfacing

Gage Corporation

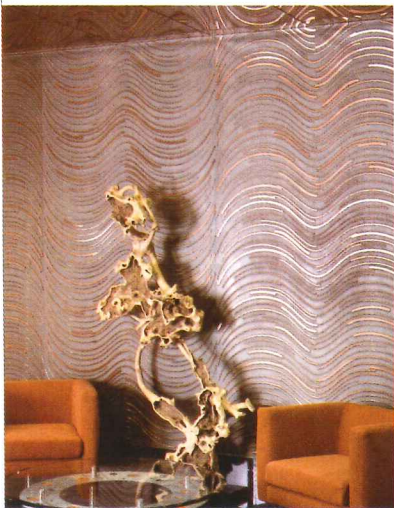

Gagecast® is a cast metal wall surfacing material suitable for a variety of interior architectural applications where patterns that feature high luster, relief, durability, and cost effective installation are a requirement. Twenty-eight designs are standard, however, custom collaboration is encouraged. Gagecast® is one component of Gage Vertical Surfacing. Contact the factory for product literature and selected samples.

800-786-4243
www.gageverticalsurfacing.com

| Circle Reader Service #174

Authentic Tin Products

The American Tin Ceiling Co.

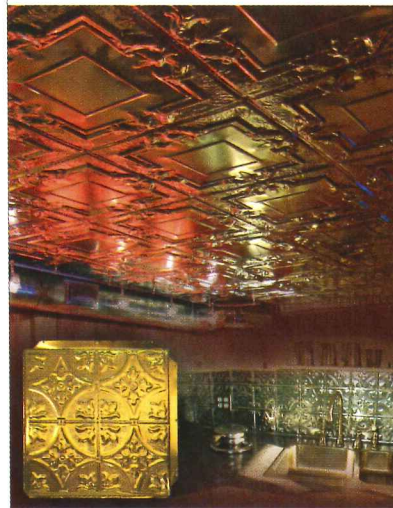

One of the largest manufacturers of authentic tin ceilings panels, offering over 30 of the finest embossment patterns and over 50 high quality powder coat finishes. Exclusive distributors of the innovative SnapLock™ and 3D Dropin tin ceiling panels. Eight designers provide free phone consultation six days a week. Orders shipped direct worldwide. Fax number 941-359-8776

888-231-7500
www.americantinceilings.com

| Circle Reader Service #177

Decorative Metal Ceilings

Gage Corporation, Inc.



The Gage Corporation International has been designing and manufacturing decorative metal ceilings since 1989. Gage ceilings feature more than 50% post-consumer recycled material and are visually rich, functional, and versatile as a design medium. Custom collaboration is encouraged. Email gage@centurytel.net

800-786-4243
www.gageceilings.com

| Circle Reader Service #175

Unique Surface with Metallic Glaze

Viva Ceramica



Viva has added to their philosophy the idea of not weighing down this world with useless products, copies of things that have already been seen, interchangeable repetitions of objects that are born today and die out with fashion. IRIDIUM is created to be exclusive, for those who understand and know how to appreciate the value of things that last and the work and passion that is part and parcel of their ceramic workshop. A metallic glaze with iridescent tones creates an absolutely new type of surface. Ideal for homes, offices, shops and public venues.

www.cerviva.it

| Circle Reader Service #178

Stainless Steel Floor System

Gage Corporation, Inc.



The Gage Stainless Steel Floor System is a durable, high-tech flooring solution designed in Italy for purity of form and ease of installation. The embossed stainless steel finish has been specifically designed to prevent traffic wear and is virtually indestructible. "The system is the solution."

866-855-4243
www.gageverticalsurfacing.com

| Circle Reader Service #176

Architectural Sun Control

ASCA, Inc.

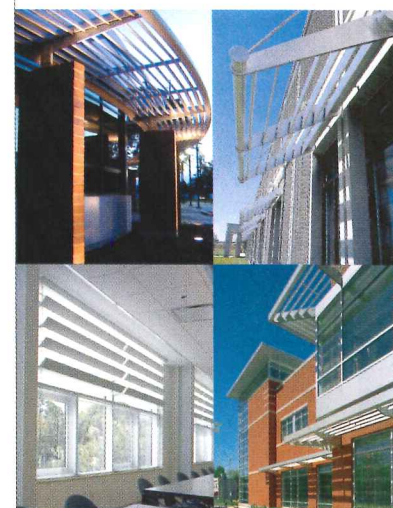

ASCA, Inc. provides an infinite assortment of efficient and cost effective sun shading solutions. While functionally reducing heat gains upwards to 80%, ASCA's sun control systems provide a striking architectural statement. Custom or traditional, intelligent heat and light control is now afforded to every designer through ASCA's creative component design and versatility of manufacturing techniques. Fax number 603-433-6700 Email info@asca-design.com

866-ASCA-USA
www.asca-design.com

| Circle Reader Service #179

Architectural Sheetmetal Products

CopperCraft



CopperCraft manufactures a complete line of high-quality architectural sheetmetal products including ornamental dormers, roof vents, roof drainage products, conductor heads, steeples, cupolas, and spires, as well as items which are custom built to your specifications. Design, engineering, testing, and fabrication methods that meet stringent structural and performance standards make the difference. You get unsurpassed quality, delivery, and custom service including a nationwide network of representatives.

800-486-2723
www.coppercraft.com

| Circle Reader Service #180

Extruded Aluminum Shelves

Rangine Corporation / Rakks



Rakks extruded aluminum shelves feature an attractive low-profile design that exceeds the strength and stiffness of 3/4-in. plywood. Shelf depths up to 18-in. can be achieved by combining 4- and 6-in. deep sections. This lightweight, easy-to-ship shelving can be ordered in specified lengths up to 12-ft. Please visit the company's web site for information on aluminum shelves and their full line of wall mounted and pole supported shelving. (Shown at left: Rakks extruded aluminum shelves on "C" standards and brackets at Clicquot, Inc. New York. Design: Traboscia Roiatti Architects).

800-826-6006
www.rakks.com

| Circle Reader Service #183

Lighted Address Plaque

Custom Home Accessories, Inc.

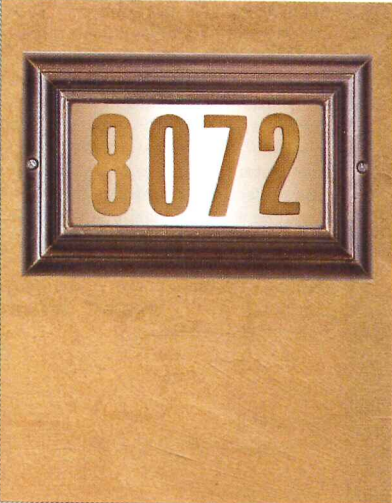

During an emergency, a reduction of just a few seconds in response time can mean the difference between life and death. Clearly visible at over 100 feet away, the Edgewood provides fast and accurate address identification, day or night. Made of cast aluminum or brass, these fixtures come in 5 styles and 10 finish options.

800-265-0041
www.mailboxes.info

| Circle Reader Service #181

TV Lifts

Architectural Products by Outwater, LLC

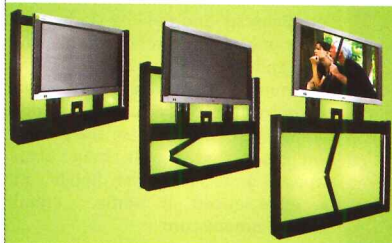

Although LCD, DLP and plasma screen televisions and computer monitors have readily emerged as accepted fully integrated commonplace fixtures within today's homes, aesthetically speaking, they are viewed as the modern day Achilles heel; monumental physical eyesores devouring vast areas of much needed space without regard...until now. Outwater introduces its new series of low cost, very high-quality motorized TV Lifts and complementary accessories to accommodate all formats and sizes of commercially available LCD, DLP and plasma screen televisions and computer monitors for any type of design application.

800-835-4400
www.outwater.com

| Circle Reader Service #184

Retail Canopies

Mapes Industries



Mapes Industries has developed a complete line of hanger rod canopies for any retail project. Extruded or roll formed can be used for retail branding, mixed use shopping centers, fast food franchises and downtown redevelopment. Custom fascia, deck escutcheons and colors are available. Canopies are designed for high wind or snow loads. They can be mounted on any wall including metal buildings, EIFS, CMU or any retrofit wall condition. For complete information visit www.mapes.com or call 888-273-1132.

888-273-1132
www.mapes.com

| Circle Reader Service #182

Clean-Lined Outdoor Furniture

Modern Outdoor



Modern Outdoor offers three complete lines of high-style, clean-lined environmentally conscious outdoor furniture. The Modern Outdoor Collections are commercial grade products designed for use in all manner of public spaces—restaurants, hospitality, parks, resorts, hotels—yet have an aesthetic that is perfect for a residential client's backyard setting. Their products now come in ipe or polyboard, stainless steel or powder-coated steel, and a natural composite material. They offer net pricing to qualified members of the trade. View the entire collection online.

818-785-0171
www.modernoutdoor.com

| Circle Reader Service #185

Custom-built Steam Shower

Sculptured Homes, LLC



The WetSpa is a contemporary alternative to a custom-built steam shower, in one complete package. The package includes a 3 1/4-in. Corian floor system that can be recessed for barrier free entry, 3/8-in. tempered glass walls that can be custom color-coated for installation in a corner or alcove, pre-plumbed wet-wall, choice of shower fittings and optional steam, fiber-optic lighting, marine-grade stereo speaker and seating. Standard sizes facilitate easy specification for remodels and new constructions for both commercial and residential applications.

248-723-5230
www.wetspas.com
HD Boutique Booth #2088

| Circle Reader Service #186

Underground HVAC Duct System

Foremost Duct Division of ARK II Mfg.



Foremost Duct PCD (Polyvinyl Coated Ductwork) is specified by more engineers and architects than any other underground HVAC duct system. By combining the strength of steel and the chemical inertness of plastic, PCD is lightweight, as well as corrosion- and weather-resistant. PCD ductwork is guaranteed not to rust, chip, crack, peel, corrode, or produce odors. Foremost offers spiral, rectangular, flat oval, single wall, and dual wall ductwork, manufactured with numerous metals and connection systems.

800-521-9316
www.foremostduct.com

| Circle Reader Service #189

Bathroom Fittings

Symmons Industries, Inc.

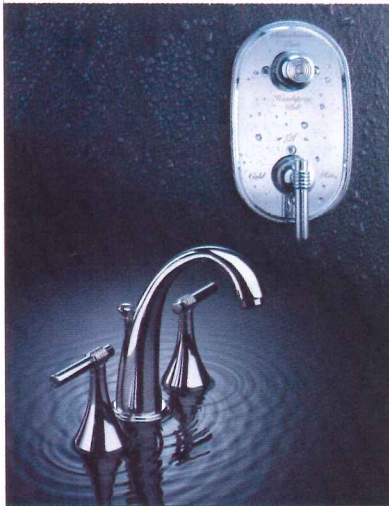

Elements is the newest collection of exquisitely designed bathroom fittings from Symmons Industries. These same fittings were custom-designed by world-class luxury hotels such as the Mandarin Oriental, the Four Seasons, and the Ritz-Carlton, to name only a few. Architects, designers, and developers all turn to Symmons' Signature Design Studio to create such uniquely designed fittings for their properties. Now, the luxury and class that people have been exposed to at such lavish hotels can be experienced at home. Email info@symmons.com

800-SYMMONS
www.symmons.com

| Circle Reader Service #187

Custom Light Fixtures

CP Lighting

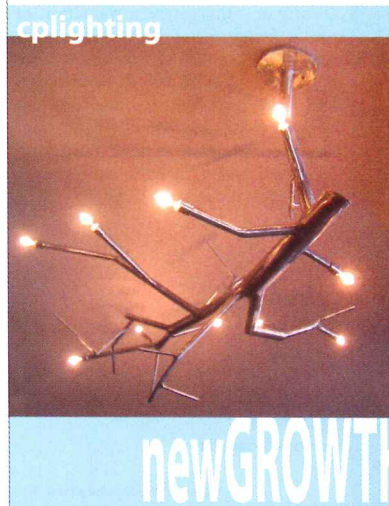

CPLIGHTING introduces the newGROWTH chandelier. Custom fabricated from brushed aluminum, these UL listed fixtures are a modern sculptural interpretation of fallen branches. Like real trees, no two newGROWTH fixtures are ever alike. Each fixture is built to suit your specific project needs utilizing line-voltage type JCD halogen bulbs. Please visit their web site to see their complete line of modern light fixtures designed by Christopher Poehlmann including their recycled acrylic Popsicle Pendant series.

866-597-4800
www.cplighting.com

| Circle Reader Service #190

Tub & Shower Valve

Zurn Plumbing Products Group



Temp-Gard III, manufactured by Zurn AquaSpec® is a single-handle pressure balancing mixing tub and shower valve, with an ADA-compliant handle, chrome finish, and a heavy duty ceramic control cartridge with a stainless steel balancing piston. It features a built-in reverse connection capacity and two integral service stop/check stops and an adjustable temperature limit stop. The four-port valve body has a tub port plug included for shower-only applications. The valve inlet, shower outlet, and tub outlet are standard with half inch N.P.T. female thread connections.

877-987-6669
www.zurn.com

| Circle Reader Service #188

Large Lighting for Large Spaces

Engineered Lighting Products

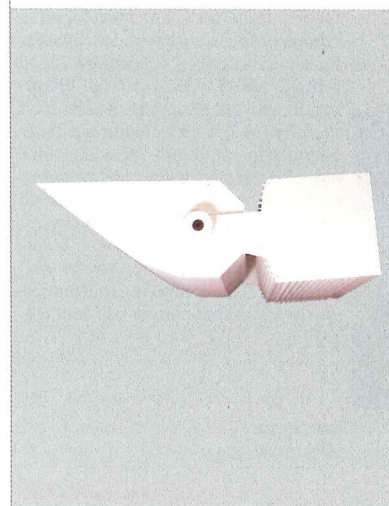

These extruded, A15 fixtures are 7-1/4-in. by 25-5/8-in. by 28-in. They tilt for precise aiming of the asymmetric beam and can be secured in place. Interior and exterior wet location styles are available in one or two lamp configurations for Metal Halide, HPS or Fluorescent models. Fax number 626-579-6803 Email elp2@aol.com

626-579-0943
www.elplighting.com

| Circle Reader Service #191

Architectural Ceiling Fans & Lighting

G Squared

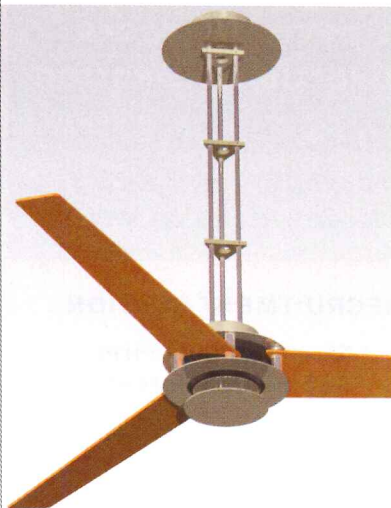

Balanced design that is light and airy. Moving sculpture.... The San Francisco ceiling fan is a GOOD DESIGN Award winner by Mark Gajewski. Whisper quiet, powerful, reliable and beautifully made. Also available with a light kit. Lifetime warranty. Buy great fan and lighting designs on G Squared Art's web site or call.

877-858-5333
www.g2art.com

| Circle Reader Service #192

Sleek & Contemporary Pendants

W2 Architectural Lighting



Bridging function and design, W2 ARCHITECTURAL LIGHTING introduces "Architectural Elements," contemporary pendants crafted with a sleek design and scale for large, challenging spaces. W2 ARCHITECTURAL LIGHTING, a new division of W.A.C. Lighting, offers specification grade products for commercial, hospitality and retail applications. Achieving a perfect balance of color and light, the pendants are designed with glossy, cased Opal glass shades to spread light evenly and minimize glare.

866-788-2100
www.W2lighting.com

| Circle Reader Service #195

Architectural Outdoor Illumination

Lithonia Lighting

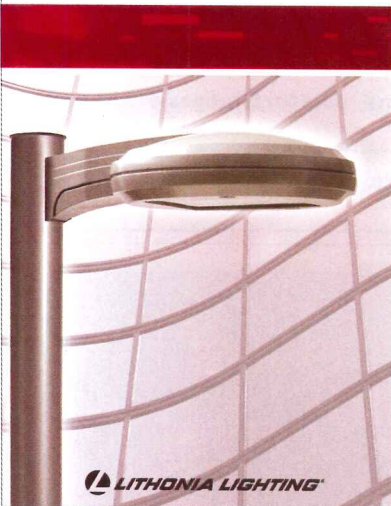

Unique, sleek, and expressive in unexpected ways, the OMERO™ Architectural Outdoor family of Area, Wall Mounted and Bollard luminaires from Lithonia Lighting takes outdoor lighting to the forefront. The distinctive designs, signature accents and uncompromising performance of the OMERO™ complement any environment. With versatile mounting options, multiple performance optics and an entire family of cohesively designed products, the OMERO™ family provides you with another choice from Lithonia Lighting.

800-279-8041
www.lithonia.com/omero

| Circle Reader Service #193

European Cobblestone

Eurocobble



An updated catalog features authentic European cobblestone preassembled in modular form. Modules in square, fan, concentric ring, and custom formats arrive at the job site ready for a quick and easy installation. Pedestrian or vehicular application. Eurocobble® has supplied the design community with traditional and customized paving solutions for over 20 years. Call toll free or visit the Web site.

877-877-5012
www.eurocobble.com

| Circle Reader Service #196

Column Light

SELUX Corporation



Integrating the SELUX patented MTR refractor technology for glare reduction, MTR Column is a perfect choice for pedestrian and urban area lighting. Choose from three distinct styles in standard heights of 12-, 14- and 16-ft., or in user specified heights. Accommodates up to four T-8 fluorescent lamps, with H.I.D. possible.

800-735-8927
www.selux.com/usa

| Circle Reader Service #194

Gate Safety Brochure

FAAC International, Inc.

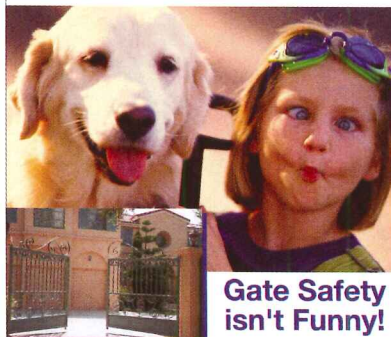

Gate Safety isn't Funny!

Since 1965, FAAC has been a world leader in developing safer automated gate systems. They have now produced a unique brochure to help educate consumers on new UL-325 safety standards and various safety and convenience options, using great visuals and easy-to-understand descriptions. Learn about FAAC swing, slide and barrier gate systems plus download a copy of the new "Gate Safety" brochure by visiting their web site at www.faacusa.com.

800-221-8278
www.faacusa.com

| Circle Reader Service #197

TO ADVERTISE: Contact Diane Soister
T: (212) 904-2021 / F: (212) 904-2074
Diane_Soister@McGraw-Hill.com

CLASSIFIED ADVERTISING

POSITIONS AVAILABLE

ARCHITECT – INDIANAPOLIS

Simon Property Group, Inc., headquartered in Indianapolis, IN, is a real estate investment trust engaged in the ownership, development and management of retail real estate, primarily regional malls, premium outlet centers and community/lifestyle centers. Through its subsidiary partnership, it currently owns or has an interest in 285 properties in the United States containing an aggregate of 200 million square feet of gross leasable area in 39 states plus Puerto Rico. Simon also holds interests in 52 European shopping centers in France, Italy and Poland; 5 premium outlet centers in Japan; and 1 premium outlet center in Mexico. We now have a great career opportunity available at our downtown Indianapolis headquarters. This person will be responsible for managing workflow and issues related to new project development, property expansion and renovations, pre-development and other company initiatives. You will work directly with our Vice-President of Architecture & Engineering along with technical consultants, outside design firms and property managers. We are seeking the following: Bachelor's degree in Architecture; 7-10 years of Architecture experience; 4 years experience supervising projects and/or managing work products of other Architects, preferred; knowledge of retail development; good communication & organizational skills; ability of handling multiple tasks simultaneously with minimal direction; strong knowledge of design principles, retail renovations and expansions; site planning a plus. You'll enjoy a competitive salary, excellent benefits and the satisfaction and recognition of being part of our industry leading team. For immediate consideration, please submit your resume to: Simon, Human Resources, P.O. Box 7033, Indianapolis, Indiana 46204, careers@simon.com, Fax: 317-263-2318, Job Line: 317-685-7300. EOE

ARCHITECT

Send resume to attn: Human Resource Manager; Cion Companies, Inc.; 329 W. 18th Street, Ste. 501, Chicago, IL 60616.

WWW.SMPSCAREERCENTER.ORG

Find marketing/BD professionals with A/E/C exper. Call 800-292-7677, ext. 231.

BUSINESS OPPORTUNITIES

FIRM AVAILABLE FOR OWNERSHIP TRANSFER

Well-established Kansas architectural firm for sale Public, institutional, religious, edu. and medical facilities 80% repeat clientele. PH: 785-625-6425. www.sbarchitectspa.com

EQUIPMENT & MATERIALS

Q-CAD DRAFTING SERVICES
800-700-3305 | www.Q-CAD.com

PAPER DOCUMENTS HAND-DRAFTED INTO CAD

- 1, 3, 5, 10, 30-Day Turnarounds
- AutoCAD and Microstation
- Guaranteed Quality, Turnaround
- 14-Years Experience, GSA Contract

\$80 Per Sheet LITE Layers (E-size)

archrecord.construction.com

Special Careers Advertising Section

"Architectural Firms: A Great Place to Work"

RECRUITMENT SECTION

*** Promote Your Firm
* Recruit Top Talent**

**Issue: September 2006
Ad Close: 8/1**

**Contact: Diane Soister Recruitment-Careers
Account Manager
(All Territories)**

**Tele: 212-904-2021 or Email:
diane_soister@mcgraw-hill.com**

connecting people.projects.products
McGraw_Hill CONSTRUCTION
Find us online at www.construction.com

The McGraw-Hill Companies

Pollmeier's German Beech –
It's about the closest thing to a perfect close-grain temperate hardwood there is.

Availability – Beech is the pre-eminent species of Europe's temperate forest, the second largest in the world.

Sustainability – German law limits cutting to less than 66% of the new-growth rate. Europe's forests have the highest growth rate percentage in the world.

Durability – More solid than red oak and hard maple.

Machinability – Although Beech is heavy, hard and quite strong, it's easy to machine.

Finishes beautifully – German Beech dresses very smoothly, sands to a high polish, and takes a wide range of finishes.



European Beech.

One wood, so many cabinet possibilities.

W H A T E V E R Y O U R S T Y L E



W H A T E V E R Y O U R F I N I S H

German Beech is readily available, sustainable, durable, easy-to-machine, and—best of all—surprisingly affordable.

To find out more about German Beech or receive a free sample for your next design, contact us today!



North American Sales Office, Portland, OR
Toll Free 866-432-0699
Outside U.S. 503-452-5800
Fax 503-452-5801
usa@pollmeier.com • www.pollmeier.com



CIRCLE 90 ON READER SERVICE CARD OR GO TO ARCHRECORD.CONSTRUCTION.COM/PRODUCTS/

PVC-free is just the tip of the corn stalk



Arden Architectural's new corn-based crash rails, corner guards and handrails are made using an innovative protein-based biopolymer. This revolutionary material exceeds the impact performance of PVC and meets ASTM E-84 requirements for a Class 1 fire rating. It also provides the benefits of a rapidly renewable resource grown within 500 miles of our plant.

Committed to service and innovation, Arden Architectural is leading the way.

www.ardenarch.com/corn3
sales@ardenarch.com
1-800-521-1826



© Copyright 2006 Arden Architectural Specialties, Inc.

CIRCLE 98 ON READER SERVICE CARD OR GO TO ARCHRECORD.CONSTRUCTION.COM/PRODUCTS/



the ultimate cable system

Arakawa



Arakawa Hanging Systems supplies quick release cable Grippers. Easily install displays, secure them quickly and change them with little effort.

Shown here is our popular floor tensioner that also works well as a turnbuckle for balustrades. This gripper, like many of Arakawa's products, encompass multiple uses and flexible designs. The mechanical grip uses no set screws, which saves time and eliminates damaged cable.

Visit us today.

www.arakawagrip.com

Arakawa Hanging Systems fax: 503.236.0427 toll free: 888.ARAKAWA

CIRCLE 91 ON READER SERVICE CARD OR GO TO ARCHRECORD.CONSTRUCTION.COM/PRODUCTS/

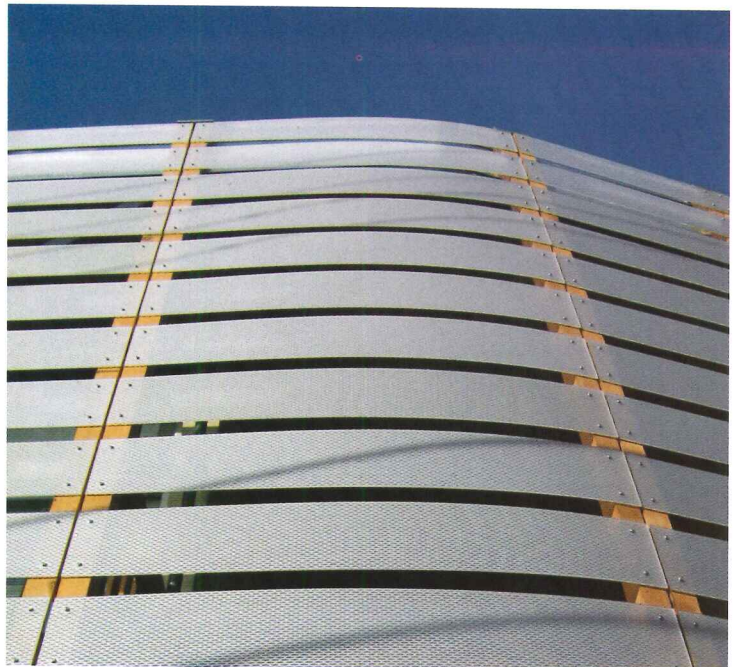

3form
you can do that™

3-form.com | 800.726.0126

CIRCLE 92 ON READER SERVICE CARD OR GO TO ARCHRECORD.CONSTRUCTION.COM/PRODUCTS/



ADVANCE LIFTS

DISAPPEARING DOCK LIFT

NOW YOU SEE IT

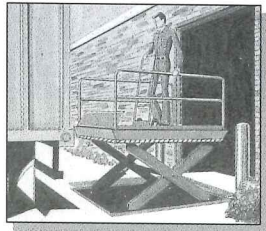

NOW YOU DON'T

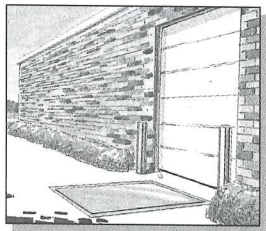

We can tailor a dock lift to fit your needs and budget.

1-800-843-3625

www.advancelifts.com

EVERY DOCK NEEDS A LIFT

CIRCLE 93 ON READER SERVICE CARD OR GO TO ARCHRECORD.CONSTRUCTION.COM/PRODUCTS/

It's Hip to be Square

Visit our website or order our catalog -- browse our broad selection of furniture legs and other components.

FL13

Square table leg with a polished aluminum finish is designed to fit snugly and attractively into the corner of a table. It is 1" square and choice of 3^{25/32"}, 5^{3/4"} or 8^{1/8"} tall. New -- Custom heights now available. Aluminum glide can adjust up to 1/2".

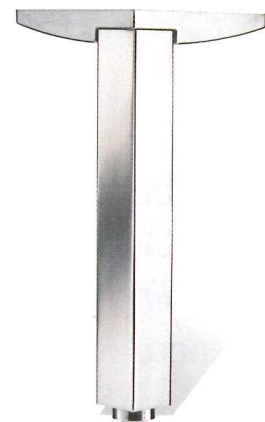

"FINE ARCHITECTURAL HARDWARE FOR YOUR FINE FURNITURE"®

Doug Mockett & Company, Inc. • Manhattan Beach, CA • 800.523.1269

MOCKETT
DOUG MOCKETT & COMPANY, INC.

www.mockett.com

CIRCLE 94 ON READER SERVICE CARD OR GO TO ARCHRECORD.CONSTRUCTION.COM/PRODUCTS/



“We want an easy way to understand growing trends and opportunities in sustainable design and construction.”

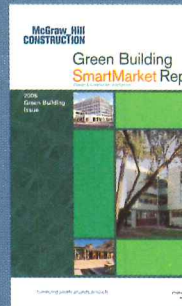

Now you can.

Get smart about green building with the McGraw-Hill Construction *Green Building SmartMarket Report* series.



McGraw_Hill
CONSTRUCTION

One smart, comprehensive report connects you to 'green building' trends, market data, research results and insights from leading professionals—so now getting your share is easier than ever.

Go to www.greensmartmarket.construction.com to order:

- *Green Building SmartMarket Report 2006*—(for commercial construction information)—just \$99—that's more than 60% off the cover price of \$295
- *Green Residential Building SmartMarket Report*—(for residential construction information)

Get started today!

All it takes is a call: 1-800-591-4462

Or a click: www.greensmartmarket.construction.com

Go to www.greensmartmarket.construction.com

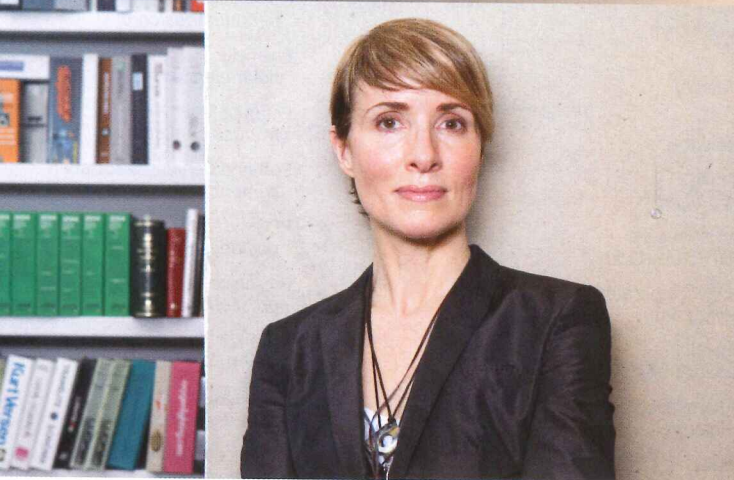

“ My search results need to be relevant, and I want to be able to save, share, and evaluate products easily.”

Robin Elmslie Osler
Elmslie Osler Architect, New York
www.eoarch.com

Now you can.
Introducing the new
McGraw-Hill Construction
Network[®] for products

Experience faster, easier product selection. By design. Comprehensive. Accurate. Innovative. Inspiring. Built on Sweets' 100-year history of connecting you to product information and intelligence. A better online specification experience than any single product web site or search engine listing alone. At your fingertips. One connecting point. So you can get what you need to realize your vision. Your work. Your Network. A winning combination.
Now, what do you need to find?

Go to networkforproducts.com

MAR67NFPA1

McGraw Hill
CONSTRUCTION Network[®] for products 

The McGraw-Hill Companies

ADVERTISERS INDEX

Bold: Indicates Page Number. *Italic:* Indicates Reader Service Number. *****: Indicates Sweets Marketplace Participation

223	92	3form 3-form.com	43	25	* DuPont Tyvek tyvek.com	58-59, 70	McGraw-Hill Construction construction.com
223	93	* Advance Lifts advancelifts.com	9	13	* EFCO Corporation efcocorp.com	132-133, 198	McGraw-Hill Construction construction.com
185, 210		AIA aia.org	44	26	Ellington ellingtonfans.com	202, 224-225	McGraw-Hill Construction construction.com
208, 213		AIA aia.org	8	6	* Fabral Metal Wall and Roof Systems fabral.com	141	43 * MechoShade Systems Inc mechoshade.com
16	11	* Alcan Composites USA Inc alucobond.com*	167	53	Finelite finelite.com	38	22 * Mortar Net mortarnet.com
153	47	* Alcoa Architectural Products alcoacladdingsystems.com	39	23	* Firestone firestonebpco.com	139	42 * Nana Wall Systems Inc nanawall.com
18	12	* AltusGroup altusprecast.com	10	7	* Fypon fypon.com	204	National Building Museum nbm.org
195	71	* American Hydrotech hydrotecusa.com	168-169	54	Gardco Lighting sitelighting.com	106	39 * National Gypsum Company nationalgypsum.com
223	91	Arakawa Hanging Systems arakawagrip.com	197	73	Google sketchup.com	24	17 * National Terrazzo & Mosaic Assn ntma.com
178	57	Architectural Area Lighting aal.net	203	79	Gyford Productions standoffsystems.com	159	50 NCARB ncarb.org
14		Architectural Record archrecord.construction.com	48A-D		Gypsum Association gypsum.org	190	65 NJ SmartStart Buildings njsmartstartbuildings.com
222	98	* Arden Architectural ardenarch.com/corn3	193	68	Hampstead Lighting hampsteadlighting.com	212	87 Northwest Door Inc nwdusa.com
cov2-1	1	* Armstrong armstrong.com	208A-B		Hanson Brick hansonbrick.com	150-151	46 * Oldcastle Glass oldcastleglass.com
36-37		Autodesk autodesk.com	cov4	97	* Haworth haworth.com	227	95 * Overly Door Company overly.com
23	16	Avonite Surfaces avonite.com	192	67	HDI Railing Systems hdirailings.com	72	38 * Pella Windows & Doors pella.com
181	59	B-K Lighting bklighting.com	210	84	Headwaters Resources flyash.com	134	41 * Petersen Aluminum pac-clad.com
27	149	BEGA bega-us.com	209	82	Hess hessamerica.com	189	63 * PGT Industries pgtindustries.com
cov3	96	* Belden Brick Company, The beldenbrick.com	201	77	* Homasote homasote.com	222	90 Pollmeier pollmeier.com
213	89	* Bilco Company, The bilco.com	195	70	* Homasote homasote.com	57	32 Poltrona Frau frauusa.com.com
205		BNi Building News bnibooks.com	160	51	Insight Lighting insightlighting.com	33	20 Portland Cement Association cement.org
165	52	Boyd Lighting lightspacebyboyd.com	211	85	* Invisible Structures Inc invisiblestructures.com	2-3	2 * PPG ppgideascales.com
197	74	Building Systems Design bsdsoftlink.com	183	61	Ivalo Lighting Incorporated ivalolighting.com	173	55 Prescolite prescolite.com
227		BuildingGreen Inc buildinggreen.com	31	19	J&J Commercial jjcommercial.com	48	28 RHEINZINK rheinznk.com
210	83	Cascade Coil Drapery cascadecoil.com	196	72	Jack Arnold Architect jackarnold.com	21	14 SageGlass sage-ec.com
40	24	CEMEX cemexusa.com	63	33	* Johns Manville specjm.com	212	88 * Salsbury Industries mailboxes.com
144	44	* CENTRIA Architectural Systems centria.com	201	78	* Kalwall kalwall.com	15	10 Schott Corporation us.schott.com
200	76	Charles Loomis charlesloomis.com	11	8	* Kawneer Company Inc kawneer.com	199	75 Selux selux.com/usa
186	62	Concrete Reflections Inc concrete.com	47	27	Kim Lighting kimlighting.com	12	9 * Sherwin-Williams sherwin-williams.com
180	58	Cooper Lighting cooperlighting.com	194	69	KraftMaid Cabinetry kraftmaid.com	52	30 * Simpson Strong-Tie Company Inc simpsonstrongwall.com
207	81	Delray Lighting Incorporated delraylighting.com	182	60	LightingUniverse.com lightinguniverse.com	29	18 * Sloan Valve Company sloanvalve.com
211, 223	86, 94	Doug Mockett & Company Inc mockett.com	50-51	29	* Lonseal lonseal.com	177	56 Tambient tambient.com
149	45	* Dryvit dryvit.com	6-7	5	Marvin Windows & Doors marvin.com	5	4 Technical Glass Products fireglass.com

For additional information on these advertisers, circle corresponding number on Reader Service Card, or go to archrecord.construction.com/products.

4	3	Teragren teragren.com
190	66	★ Thermique Technologies thermique technologies.com
22	15	★ Trespa trespanorthamerica.com
71	37	United States Aluminum usalum.com
67	35	US Green Building Council usgbc.org
19, 143	★	USG Corporation usg.com
189	64	Verizon Wireless verizonwireless.com
131	40	VERSA-LOK versa-lok.com
54	31	Visa Lighting visalighting.com
155	48	Vistawall Architectural Products vistawall.com
35	21	VT Industries vtindustries.com
157	49	★ W&W Glass Systems Inc wwglass.com
32A-B	★	Wausau Tile wausautile.com
65	34	Western Red Cedar Lumber Association realcedar.org
206	80	Weston Solutions greengridroofs.com
69	36	★ Weyerhaeuser weyerhaeuser.com

EXECUTIVE OFFICES

Laura Viscusi, VP, Associate Publisher
(212) 904-2518 Fax: (212) 904-2791
lviscusi@mcgraw-hill.com

Assistant: Pina Del Genio
(212) 904-6791 Fax: (212) 904-2791
pina_delgenio@mcgraw-hill.com

NORTHEAST / MID-ATLANTIC (CT, MA, ME, NH, NJ, NY, PA, RI, VT)

Janet Kennedy
(212) 904-3603 Fax: (212) 904-2791
janet_kennedy@mcgraw-hill.com

Joe Sosnowski (NJ, PA)
(610) 278-7829 Fax: (610) 278-0936
joseph_sosnowski@mcgraw-hill.com

MIDWEST (IL, IN, KS, MI, ND, NE, OH, OK, SD, TX, WI)

Lisa Nelson
(312) 233-7402 Fax: (312) 233-7403
lisa_nelson@mcgraw-hill.com

Bret Ronk (IA, LA, MN, MO, MS, OK, TX)
(972) 437-7877 Fax: (972) 437-7876
bret_ronk@mcgraw-hill.com

SOUTHEAST / MID-ATLANTIC (AL, DC, FL, KY, MD, NC, TN, AK, GA, LA, MS, W.PA, SC, VA, WV)

Susan Shepherd
(404) 843-4770 Fax: (404) 252-4056
sshepherd@mcgraw-hill.com

WEST (AZ, CA, CO, NM, NV)

Bill Hague
(253) 858-7575 Fax: (253) 858-7576
(760) 340-5575 Fax: (760) 340-0439
bill_hague@mcgraw-hill.com

WEST (ID, MT, OR, S.CA, UT, WA, WY)

Bill Madden
(503) 224-3799 Fax: (503) 224-3899
bill_madden@mcgraw-hill.com

INTERNATIONAL

Dean Pushka (Canada)
(905) 309-4458 Fax: (905) 309-1737
dean_pushka@mcgraw-hill.com

Martin Drueke (Germany)
(49) 202-27169-12 Fax: (49) 202-27169-20
drueke@intermediapartners.de

Ferruccio Silvera (Italy)
(39) 022-846716 Fax: (39) 022-893849
ferruccio@silvera.it

Katsuhiko Ishii (Japan)
(03) 5691-3335 Fax: (03) 5691-3336
amskatsu@dream.com

Young-Seoh Chin (Korea)
(822) 481-3411/3 Fax: (822) 481-3414

PRODUCT NEWS SPOTLIGHTS / POSTCARD SERVICE

Deidre Allen
(212) 904-2010 Fax: (609) 426-7136
deidre_allen@mcgraw-hill.com

CLASSIFIEDS

Diane Soister
(212) 904-2021 Fax: (212) 904-2074
deidre_allen@mcgraw-hill.com

SUBSCRIBER SERVICE

(888) 867-6395 (USA only)
(609) 426-7046 Fax: (609) 426-7087
p64cs@mcgraw-hill.com

BACK ISSUES

(212) 904-4635
phyllis_moody@mcgraw-hill.com

REPRINT MANAGEMENT SERVICES

(800) 360-5549 x129
architecturalrecord@reprintbuyer.com



BuildingGreen

Trustworthy • Dependable • Timely

Design professionals who create healthier, greener buildings have relied on the information resources from BuildingGreen, Inc. since 1985.

BuildingGreen Suite™ • GreenSpec® Directory
Environmental Building News™

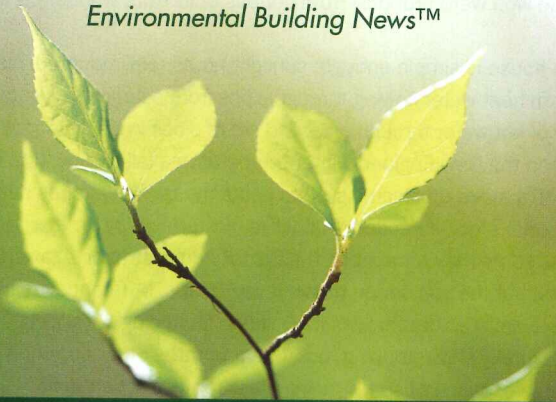

BuildingGreen, Inc.

Battleboro, VT • 800-861-0954

www.BuildingGreen.com

Need Specialty Doors?



- Acoustic Door and Window Systems
- Blast- and Pressure-Resistant Door and Window Systems
- Bullet-Resistant and Security Products
- Fiberglass Reinforced Plastic Doors and Window Systems

OVERLY
DOOR COMPANY

Phone: 1-800-979-7300

Fax: 724-830-2871

Web: www.overly.com



Phone: 1-888-891-4416

Fax: 402-346-0561

Web: www.tigerdoor.com

AR Past and Present

ARCHITECTURAL ENGINEERING TECHNICAL NEWS AND RESEARCH

M. I. T. BUILDS SOLAR-HEATED HOUSE

Test house combines solar with electric auxiliary heat to minimize installation expense

It has long been an open secret that M. I. T. was seriously researching the age-old idea of using solar heat for space heating. The study has now arrived at the point of completion of the first occupied test house.

The house is basically a compromise between theory and practice. Probably nobody ever doubted that a house could be heated entirely by direct solar energy. The conflict between idea and reality has been in the size and expense of the necessary gadgetry to collect heat and store it against the rainy days. So this house does not attempt an installation large enough for 100 per cent solar heat; the

approach was rather to do what seemed reasonable with the sun's energy, and supplement that with auxiliary electric heating.

The house is in the Boston area, which is considered to be about the northern limit for solar space heating. It is the latest development of M. I. T.'s Solar Energy Research Project, endowed by Dr. Godfrey L. Cabot of Boston.

This house uses water as the heat storage medium, and the necessary size of the water tank is a limiting factor, as well as the size of the heat collector plate. The tank here holds 1200 gal. The electric heat is easily added to this sys-

tem by the simple means of introducing two 3.5 kw immersion-type heaters in the water storage tank.

The heat collector is of the flat-plate type (parabolic, conical and other shapes have been studied), as the flat form seems generally the most practical. It consists of a blackened metal sheet behind two sheets of glass, the assembly tilted toward the winter sun.

If we could put a heat collector perpendicular to the sun's rays somewhere outside the atmosphere, there would be about 130 Btu per sq. ft. available outside the glass. But by the time the solar radiation has passed through

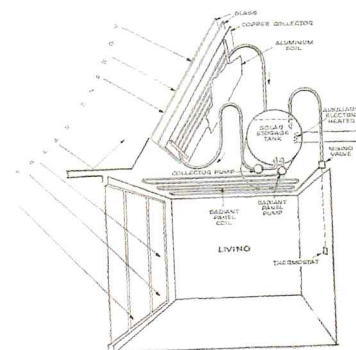
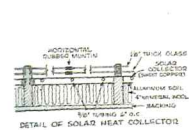
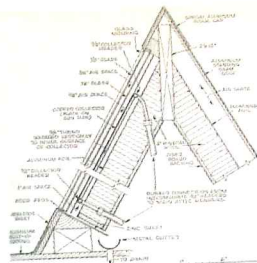

The diagram, right, shows the main features of the M. I. T. solar heating system—how the heat is nicked up, stored and distributed. The heat collector, detailed above, traps about 37 per cent of the solar energy hitting the glass. An opening at the bottom lets out water in case the glass gets broken. In the photo, Edmund Caspell is examining a flow meter in the attic; note the heavy insulation on a line leading to the storage tank.

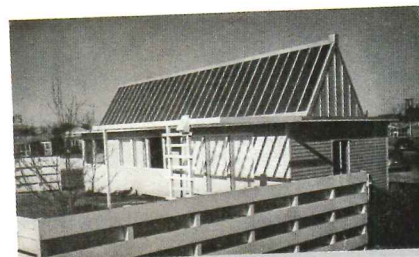

Another view of the house with "sun-measuring" gadgets called pyrheliometers evident on the eaves and peak (right) of the roof. They measure the intensity of solar radiation outside a collector tilted at the 57 degree angle or oriented vertically.

From the pages of ARCHITECTURAL RECORD 1949

Nothing new under the sun

How far have we come? We ask this question in the face of this 600-square-foot test house built by the Massachusetts Institute of Technology's Solar Energy Research Project and published in RECORD in April 1949. Sustainability, let alone such trendy programs as the U.S. Green Building Council's LEED rating system, was not a term one would likely hear from an architect's lips before the 1990s. The only "points" this house won were probably from curious onlookers wondering what on earth MIT had done this time.

The concept employed in the house is simple enough: sunlight heats roof-mounted, glass-encased copper panels that in turn heat water flowing through pipes from a large storage tank. A thermostat then regulates the flow of hot water through a second set of pipes in the ceiling of the house, thereby warming the structure. When the New England winter temperatures fall too low (the copper panels' efficiency is only 37 percent), a make-up electric system heats the tank's water as needed.

The MIT test house provides some proof, if needed, that while our terminology may change, interest in sustainability precedes us. As some may remember, the Carter Administration's tax credits were the golden age of the solar collector, but the sun set on those in the 1980s. MIT continues its research today in various areas of sustainable architecture through its Building Technology Program.

The MIT house wasn't architecturally showstopping, but it incorporates other common-sense sustainable gestures, such as a large expanse of south-facing glass for winter heat gain—a design and site consideration the vast majority of mass-market, American homebuilders shoe-horning a site with new homes would hardly contemplate today. So, have we really come that far? Probably not. There may be nothing new under the sun, but it doesn't have to stay that way. *Russell Fortmeyer*

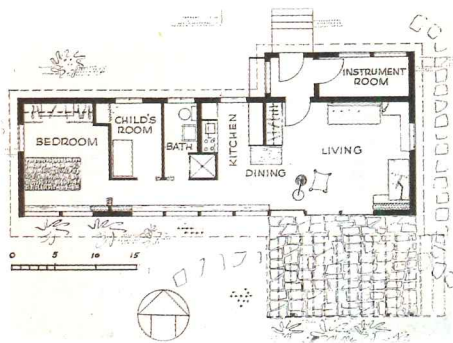

Floor plan, 1949 MIT solar test house, with an equipment room for the solar heating system about as large as the child's bedroom.

Not Just Another Brick In The Wall.

With Belden Brick you get more than just another brick in your wall. You get unrivaled quality and durability. Belden Brick products are available in a variety of colors, textures, sizes and shapes. All in all ... Belden Brick - more than just another brick in the wall.

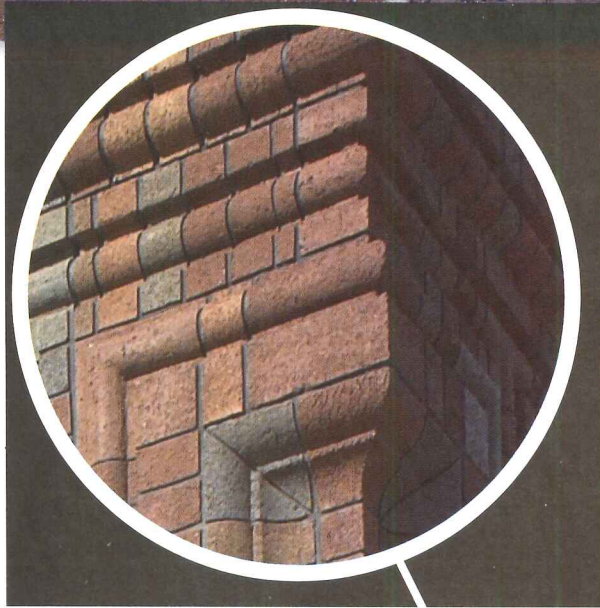

BELDEN
THE BELDEN BRICK COMPANY

Canton, Ohio / (330) 456-0031
www.beldenbrick.com

An ISO 9001:2000 Registered
Quality Management System

CIRCLE 96 ON READER SERVICE CARD OR GO
TO ARCHRECORD.CONSTRUCTION.COM/PRODUCTS/

HAWORTH®
change by design

See the new Compose™ furniture system – and other products and solutions – that help make workspaces great spaces.

Visit our new Washington, D.C. showroom or any of the other Haworth locations around the world.

www.haworth.com
866.833.4343

great spaces.

CIRCLE 97 ON READER SERVICE CARD OR GO
TO ARCHRECORD.CONSTRUCTION.COM/PRODUCTS/