

A Wallboard Tough Enough To Stand The Test Of Time.

Developed with a tough Lexan® backing, **Hi-Impact® Brand Wallboard** from National Gypsum can absorb more than 2188 pounds of direct impact. An important feature to consider when developing plans for prisons, hospitals, schools or any other place people and walls often interact.

National
Gypsum
COMPANY

TECHNICAL INFO: 1-800-NATIONAL

www.nationalgypsum.com

Excellence Across The Board

*Lexan is a registered trademark of General Electric Company.

CIRCLE 7 ON INQUIRY CARD

Downlight Fabulous.



Better color stability, energy efficiency and 10,000-hour T6 lamp life make the MH-T6 ideal for retail applications, atria and other spaces with high ceilings.

The new MH-T6 luminaire is the latest addition to the Specification Downlighting Series. Compact ceramic metal halide technology combined with our new reflector and lens assembly gives you controlled and desired distribution.

Find out how we create worlds of experience with light at www.zumtobelstaffusa.com or call us at 1-800-932-0633.

Design by Alan Newell

ZUMTOBEL STAFF
THE LIGHT[®]

CIRCLE 8 ON READER SERVICE CARD OR GO TO WWW.LEADNET.COM/PUBS/MHAR.HTML

ARCHITECTURAL RECORD

03.2002

On the Cover: Milwaukee Art Museum, by Calatrava Valls. Photograph by Alan Karchmer/ESTO.
Right: Kimmel Center, by Rafael Viñoly Architects. Photograph by Jeff Goldberg/ESTO.

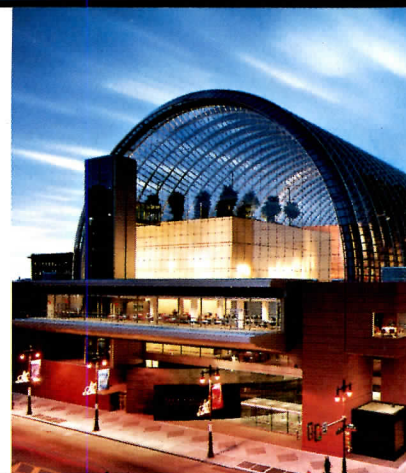

News

- 23 Boston's Museum of Fine Arts expansion
- 26 Assessing the damage in the WTC region

Departments

- 15 Editorial: Street Smarts*
- 17 Letters*
- 39 Dates & Events*
- 47 Archrecord2: For the emerging architect*
- 51 Critique: Why urban design is suffering by Michael Sorkin
- 55 Practice Matters: Fear and form by Charles Linn, FAIA*
- 59 Exhibitions: A New World Trade Center by Sarah Amelar*
- 63 Snapshot: Steelworker's monument by Ingrid Whitehead
- 240 Profile: Andrew Altman by John E. Czarnecki, Assoc. AIA*

Features

- 69 Introduction: The City remade, from Boston to Berlin
- 70 World City by Michael Gallis with James S. Russell, AIA
Why globalization makes cities more important than ever.
- 76 The New Berlin by James S. Russell, AIA
A city that has been divided for 50 years is knit together by design.
- 84 The Big Dig by Robert Campbell, FAIA
What's up under Boston?

Projects

- 92 Milwaukee Art Museum Expansion, Wisconsin by Blair Kamin*
Calatrava Valls
Sculpture and structure unite and help a city take flight.
- 106 Kimmel Center, Philadelphia by Suzanne Stephens*
Rafael Viñoly Architects
An arresting and controversial design puts a concert hall under glass.

Building Types Study 807

- 115 Essay: Community Buildings by Clifford A. Pearson
- 116 IJsselstein City Hall, the Netherlands by Tracy Mertz*
UN Studio
- 120 Hunts Point Community Center, New York by Clifford A. Pearson*
Hanrahan + Meyers Architects

- 124 Coal Harbour Community Center, Vancouver by Sheri Olson, AIA*
Henriquez Partners Architects
- 128 Heritage Park Community Center, California by Alice Kimm*
Rob Wellington Quigley, FAIA

www For 10 additional community building projects, go to Building Types Study at architecturalrecord.com. The monthly expanded Web BTS features project descriptions, photographs, drawings, statistics, and links to people and products.

Building Science & Technology

- 135 After 9/11 the urban landscape appears vulnerable 
by Sara Hart*
Architects and consultants focus on risk assessment and security.

Digital Practice

- 161 News & Trends
- 165 Space Invaders by Jacqueline Emigh
Pervasive computing technologies change building use and design.
- 171 Digital Architect: Printers and plotters by Jerry Laiserin, FAIA*
- 177 Digital Product Reviews

Interiors

- 179 Introduction
- 180 Nouveau Casino, Paris by Claire Downey*
Périphériques
- 186 Mohegan Sun, Connecticut by William Weathersby, Jr.*
Rockwell Group; Kohn Pedersen Fox Associates
- 194 Foliage and Mandarin Bar, London by John Peter Radulski*
Adam D. Tihany International
- 198 Cliff, San Francisco by Therese Bissell*
Philippe Starck
- 203 Interior Products

Products

- 205 Doors
- 209 Product Briefs
- 210 Cologne Intl. Furniture Fair by Josephine Minutillo
- 218 Product Literature
- 13 What's at architecturalrecord.com
- 224 Reader Service*
- 226 AIA/CES Self-Report Form*
- 232 Manufacturers' Spotlight
- 236 Classified Advertising*

 The AIA/ARCHITECTURAL RECORD Continuing-Education Opportunities are "After 9/11 the urban landscape appears vulnerable" (page 135); "Life Safety in Building Design" (page 144c), sponsored by USG; "Fire Protection for Steel: Myths Debunked" (page 147), sponsored by AISC; and "The New

Architectural Stile and Rail Doors" (page 153), sponsored by WDMA.

www * You can find these stories at architecturalrecord.com, including expanded coverage of projects. Explore the latest news about emerging architects at architecturalrecord.com/archrecord2.



A Site Designed With **Y**our business is in the details. Architects In Mind.

You make numerous critical project decisions – and fast. Through **nationalgypsum.com**, we put an invaluable resource at your fingertips – 24/7. Offering the Web's most comprehensive information on gypsum and related products, our site is designed to make your job that much easier. So the next time you need in-depth information, turn to the gypsum industry's service leader – and click.

National
Gypsum
COMPANY

CIRCLE 8 ON READER SERVICE CARD
OR GO TO WWW.LEADNET.COM/PUBS/MHAR.HTML

TECHNICAL INFO: 1-800-NATIONAL

www.nationalgypsum.com

Excellence Across The Board™

ARCHITECTURAL RECORD

04.2002

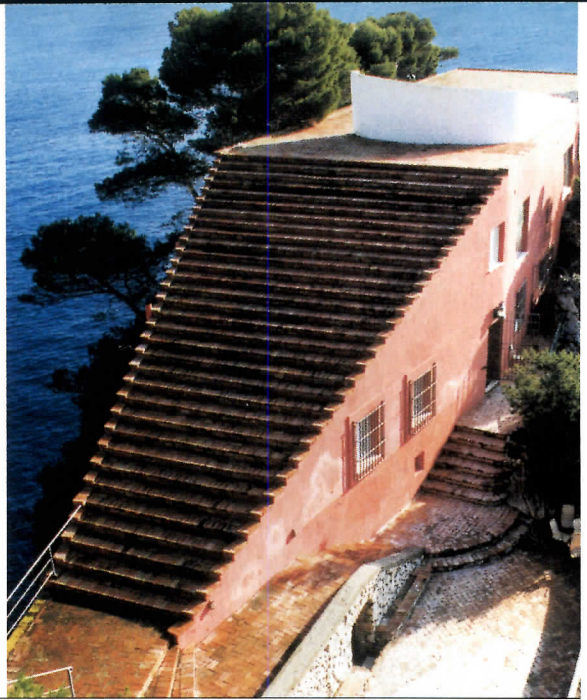

On the Cover: *Vancouver House*, by Patkau Architects. Photograph by Paul Warchol.
Right: *Adalberto Libera's 1940 Casa Malaparte*. Photograph by Andrejs Grants.

News

- 23 **Libeskind riles up Canadians**
- 28 **NYC remembers with temporary memorials**

Departments

- 15 **Editorial: The Security Paradox***
- 18 **Letters***
- 45 **Dates & Events***
- 55 **Correspondent's File: Vancouver** by Sheri Olson, AIA
- 59 **Archrecord2: For the Emerging Architect** by Kevin Lerner*
- 65 **Critique: Public open space** by Robert Campbell, FAIA
- 69 **Commentary: Modernist outpost** by John Morris Dixon, FAIA
- 73 **Snapshot: Laminata House** by Ingrid Whitehead
- 208 **Profile: Garrett Finney** by Ingrid Whitehead*

Features

- 80 **Movie Houses** by Thomas Hine
Modern homes, in starring or cameo roles, grace the silver screen.

Building Types Study 808

- 93 **Record Houses 2002** by Sarah Amelar*
Introduction
- 94 **Vancouver House, British Columbia** by Sheri Olson, AIA*
Patkau Architects
- 102 **Howard Street House, San Francisco** by Clifford A. Pearson*
Jim Jennings Architecture

- 108 **Reeve Residence, Lopez Island, Wash.** by Sheri Olson, AIA*
Cutler Anderson Architects
- 114 **F-2 House, Mexico City** by Sarah Amelar*
Adriá + Broid + Rojkind
- 120 **Island House and Tower House, Ontario** by Clifford A. Pearson*
Shim-Sutcliffe Architects
- 128 **Beverley House, Santa Monica, Calif.** by Thomas Hine*
Daly, Genik Architects
- 132 **Stein-Fleischmann House, France** by Claire Downey*
Moussafir Architectes Associés

www See 10 special unbuilt houses, including plans, renderings, and models, at architecturalrecord.com.

Building Science & Technology

- 141 **Architects Discover the Flexibility of Lightweight and Durable Fabrics** 
by Todd Willmert*
Advances in films and coatings make fabric an excellent alternative to glass.
- 153 **Digital Architect: CAD standards converge** by Jerry Laiserin, FAIA*

Products

- 173 **Windows and Skylights**
- 184 **Product Literature**
- 181 **Product Briefs**
- 13 **What's at**
architecturalrecord.com
- 192 **Reader Service***
- 188 **Record Interiors Form***
- 198 **Manufacturers' Spotlight**
- 190 **AIA/CES Self-Report Form***
- 204 **Classified Advertising***



The AIA/ARCHITECTURAL RECORD
Continuing-Education Opportunities are "Architects Discover the Flexibility of Lightweight and Durable Fabrics" [page 141]; "High Performance Windows and Doors" [page 157], sponsored by Marvin Windows & Doors; "Vinyl Windows Come of Age" [page 167], sponsored by Simonton Windows.

www * You can find these stories at architecturalrecord.com, including expanded coverage of projects. Explore the latest news about emerging architects at architecturalrecord.com/archrecord2.



*Missy
Merfeld, CSI
Technical
Marketing*

We Cater To Architects. Designed to help you make qualified decisions, our “Lunch and Learn” program is a convenient way to stay on top of the latest industry trends while earning continuing education credits. As a registered Passport Provider, our program is recognized by the AIA, CSI and architectural firms everywhere. So e-mail Missy at ngcaia@nationalgypsum.com to pick up valuable credits and useful information – and we’ll pick up lunch.

National 
Gypsum
COMPANY

CIRCLE 8 ON READER SERVICE CARD
OR GO TO WWW.LEADNET.COM/PUBS/MHAR.HTML

TECHNICAL INFO: 1-800-NATIONAL

www.nationalgypsum.com

Excellence Across The Board™ 

ARCHITECTURAL RECORD

05.2002

On the Cover: AIA Gold Medal winner Tadao Ando,
photographed by Kinji Kanno.

Right: American Folk Art Museum, by Williams Tsien Architects,
photographed by Michael Moran.

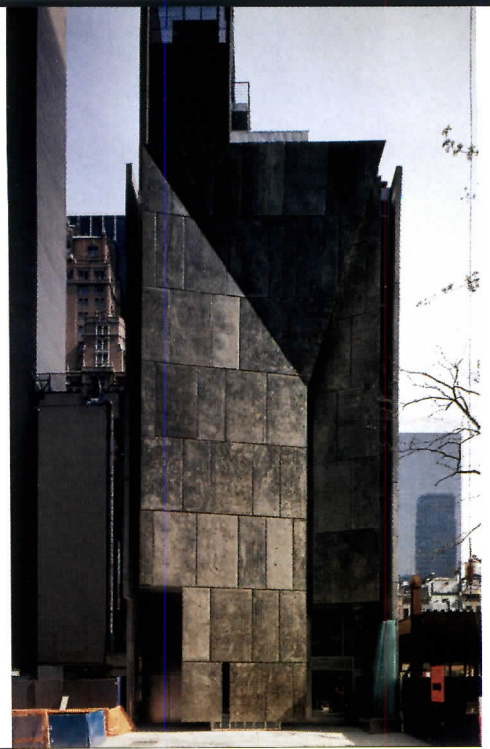

News

- 39 Glenn Murcutt awarded Pritzker Prize
- 42 Planning for Ground Zero
- 46 Neutra house destroyed
- 54 Educators discuss future

Departments

- 23 Editorial: The Case for a Competition*
- 29 Letters*
- 63 Dates & Events*
- 77 Correspondent's File: Charlotte, N.C. by Richard Maschal
- 81 Archrecord2: For the emerging architect by Kevin Lerner*
- 87 Critique: Critical moment for WTC site by Michael Sorkin
- 91 Practice Matters: MasterFormat by Charles Linn, FAIA
- 93 Commentary: Christopher Alexander's work by William Saunders
- 99 Books: Sprawl, and listening to architects
- 107 Exhibitions: Arverne by Jayne Merkel
- 113 Snapshot: Summer Stage by Ingrid Whitehead
- 388 Profile: Marion O. Sandler by Therese Bissell*

Features

- 121 AIA Awards Introduction by Jane F. Kolleeny*
- 122 Architecture Awards*
From burger joints to barns, the winners are bound by excellence.

142 Interior Awards*

A collection of creative spaces that find ways to celebrate people.

154 Urban Design Awards*

Four designs confirm the central importance of a sound plan.

158 25 Year Award*

Josep Lluís Sert's Fundació Joan Miró combines Modernism and the Mediterranean in a tribute to Miró's art.

162 Firm of the Year Award by Deborah Snoonian, P.E.*

TVS wins for its understanding of public space.

171 Tadao Ando by Robert Ivy, FAIA, and Naomi Pollock*

With simple geometric forms, Tadao Ando brings poetry to the most mundane and the most spiritual buildings.

190 Small, Medium, Large: Is Growth a Burden or a Blessing?

by Jane F. Kolleeny and Charles Linn, FAIA*

Small and large firms both seem to feel that their size is awkward. A survey of firms of various sizes looks at the dilemma.

Projects

202 American Folk Art Museum, New York City by Clifford Pearson*

Tod Williams Billie Tsien, Architects

Materials and space make a small museum into a big deal.

212 Gannett/USA Today Headquarters, McLean, Virginia

by Andrea Oppenheimer Dean and Allen Freeman*

Kohn Pedersen Fox Associates

KPF create a small city for the newspaper giant.

222 Neue Galeries, New York City by Suzanne Stephens*

Selldorf Architects

A large town house provides a classy backdrop for Austrian art.

230 Berlin Chancellery, Germany James S. Russell, AIA*

Axel Schultes Architekten

An architect takes an opportunity to embrace greatness.



The AIA/ARCHITECTURAL RECORD

Continuing-Education Opportunities are "Buckminster Fuller's Dreams of Spanning Great Distances are Being Realized in Big Projects" (page 267), and "Selecting and Specifying Sustainable Walls, Ceilings, and Substrates" (page 293), sponsored by USG.

www * You can find these stories at architecturalrecord.com, including expanded coverage of projects. Explore the latest news about emerging architects at architecturalrecord.com/archrecord2.

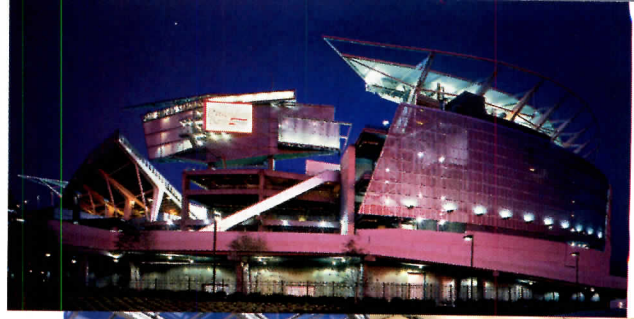

Paul Brown Stadium by NBBJ (top), photographed by Tim Griffith. Miller Park by NBBJ (bottom left), photographed by Tim Griffith. MoMA Design Store by 1100 Architects (bottom right), photographed by Peter Aaron/ESTO.

Building Types Study 809

- 245 Stadiums: The Only Game in Town** by Elizabeth Harrison Kubany
- 246 Sapporo Dome, Japan** by Naomi R. Pollock, AIA*
Hiroshi Hara
A movable grass field solves a problem: Grass needs sunlight, but snow loads preclude a retractable dome.
- 250 American Airlines Arena, Florida** by Beth Dunlop*
Arquitectonica
Modern design and bright colors liven up an arena on a prominent waterfront site.
- 254 Paul Brown Stadium, Ohio** by David Mohney*
NBBJ
The centerpiece of an urban revitalization scheme, this football stadium avoids the historicist trap.
- 258 Indianapolis Speedway, Indiana** by Elizabeth Harrison Kubany*
Browning Day Mullins Dierdorf Architects
A new iconic tower provides a recognizable form for the most famous track in American auto racing.

www For 10 additional stadium projects, go to Building Types Study at architecturalrecord.com. The monthly expanded Web BTS features project descriptions, photographs, drawings, statistics, and links to people and products.

Building Science & Technology

- 267 Buckminster Fuller's Dreams of Spanning Great Distances are Being Realized in Big Projects** by Sara Hart*
Long spans amplify the collaborative relationship between architects and engineers.
- 279 Energy Update** by Lindsay Audin*
New power pricing affects conservation.
- 283 Tech Briefs**
3D CAD models facilitate complex structural engineering.

- 289 Digital Architect** by Deborah Snoonian, P.E.*
The case for a digital master builder.

Lighting

- 299 Introduction**
- 301 Creative Uses**
- 306 Rain, Toronto** by Nayana Currimbhoy*
Dappled with light, the glossy planes of Rain frame an evocative setting for Toronto nightlife.
- 315 RealNames Corporation, California** by Leanne B. French*
A building core wrapped with tinted fluorescents creates a vibrant open-plan workspace in California.
- 320 MoMA Design Store, New York City** by William Weathersby, Jr.*
A second satellite store for MoMA in Manhattan places singular design objects in a landscape of light.
- 325 The Foundry Lobby, New York City** by William Weathersby, Jr.*
Interlocking volumes outlined in light enhance the lobby of a high-rise apartment tower in Manhattan.
- 331 Light Technology** by Charles Linn, FAIA
Inside the new compact, indirect luminaires.
- 333 Lighting Resources**

Products

- 343 Roofing**
- 347 Product Briefs**
- 356 Product Literature**
- 60 What's new on architecturalrecord.com**
- 366 AIA/CES Education Self-Report Form***
- 369 Reader Service Card***
- 374 Manufacturers' Spotlight**
- 384 Classified Advertising***

ARCHITECTURAL RECORD

06.2002

On the Cover: *The Gallery of Horyuji Treasures.* Photograph by Shinkenchiku Sha
Right: *Catalunya Congress Center,* by Carlos Ferrater. Photograph by Alejo Bagué

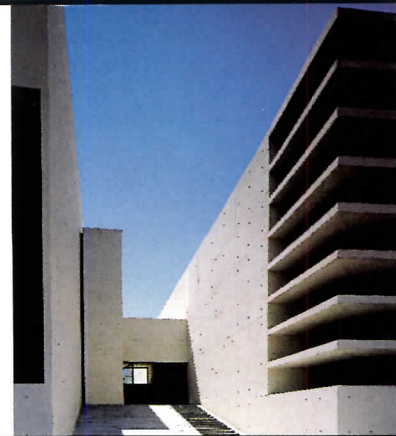

News

- 23 Implications of "design" examined at AIA convention**
- 26 Winter Garden rebuilt**

Departments

- 15 Editorial: Is Idealism Dead?***
- 17 Letters***
- 41 Dates & Events***
- 51 Archrecord2: For the emerging architect** by Kevin Lerner*
- 55 Critique: Rem to Earth** by Robert Campbell, FAIA
- 59 Snapshot: Kasahara Amenity Hall** by Jane F. Kolleeny
- 256 Profile: Maxine Griffith** by Ingrid Whitehead*

Features

- 66 Innovation in Dallas** by Francis Duffy
Ericsson's Swedish sensibilities influence the design of its Texas headquarters to create a workplace infused with freshness.
- 78 Small, Medium, Large Firms, Part II: Size and Firm Culture** by Jane F. Kolleeny and Charles Linn, FAIA
In Part II of our three-part series, we report on how a firm's size affects its culture and everything from benefits to profitability.

Projects

- 89 Why Modernism?** by Robert Ivy, FAIA*
- 90 The Gallery of Horyuji Treasures, Japan** by Robert Ivy, FAIA*
Taniguchi and Associates
The ancient and the contemporary join in stunning synthesis.
- 102 Dresden Synagogue, Germany** by David Cohn*
Wandel Hoefer Lorch + Hirsch
A complex and tragic history informs this poetic place of worship.
- 108 The Experimental Factory Magdeburg, Germany** by Nina Rappaport*
Sauerbruch Hutton Architects
In a cluster of new scientific buildings, a colorful factory stands out.
- 114 Catalunya Congress Center, Spain** by David Cohn*
Carlos Ferrater
Careful workmanship transforms concrete into pure, crisp forms.
- 120 Innovation Center, Switzerland** by James S. Russell, AIA*
Barkow Leibinger Architects
A sophisticated modern building that is reconciled with its magnificent setting.

Building Types Study 810

- 129 Introduction: Offices** by Suzanne Stephens
- 130 Abercrombie & Fitch Headquarters, Ohio** by David S. Morton*
Anderson Architects
- 136 Computer Science Corporation, Texas** by David Dillon*
Lawrence W. Speck Studio of PageSoutherlandPage
- 140 9350 Civic Center Drive, California** by Thomas S. Hines*
Barton Myers Associates
- 144 Colorium, Germany** by James S. Russell, AIA*
Alsop Architects

www For 10 additional office projects, go to Building Types Study at architecturalrecord.com for project descriptions, links, and more.

Building Science & Technology

- 151 Urban Infrastructure: The "Out of Sight, Out of Mind" Mentality Is an Outmoded Concept** by Barbara Knecht*
Architects have new opportunities to affect the built environment.

Digital Practice

- 175 News & Trends**
- 180 Mapping Places and Spaces** by Bill McGarigle*
- 189 Digital Architect: Display devices** by Tomas Hernandez, Jr.*

Interiors

- 195 Introduction***
- 196 Tribune Interactive, Chicago** by Rosemarie Buchanan*
Perkins & Will
- 203 American Meteorological Society, Boston** by Deborah Snoonian, P.E.*
Anmahian Winton Architects
- 208 Quality Telemarketing, Vermillion, S.Dak.** by Bill Weathersby, Jr.*
Randy Brown Architects
- 215 Interior Products**

Products

- 221 Office Furnishings**
- 229 Product Briefs**
- 12 What's at**
architecturalrecord.com
- 234 Product Literature**
- 241 Reader Service***
- 247 Manufacturers' Spotlight**
- 238 AIA/CES Self-Report Form***
- 252 Classified Advertising***

 **The AIA/ARCHITECTURAL RECORD Continuing-Education Opportunities** are "Urban Infrastructure: The 'Out of Sight, Out of Mind' Mentality is an Outmoded Concept" (page 151); "Daylighting: Many Designers are Still in the Dark" (page 161), sponsored by Vistawall; and "Understanding Acoustics in

Architectural Design" (page 167), sponsored by USG.

www * You can find these stories at architecturalrecord.com, including expanded coverage of projects. Explore the latest news about emerging architects at architecturalrecord.com/archrecord2.

news

daily news
from the field

projects

project portfolio
building types study
record houses
lighting

archrecord2

for the emerging
architect

features

interviews
bw/ar awards

departments

digital practice
building science/
continuing ed.
green architect
editorial
letters
events

about record

new this month
magazine index
subscribe
how to submit
advertise
editorial calendar
privacy policy
contact us
site map

the AIA

join the AIA
www.aia.org
contract documents

services

recruitment
advertisers
professional
directories

home

in the CAUSE of
ARCHITECTURE

The **New Online Journal of Ideas** from *Architectural Record*
This month:

- **Jim Cutler, FAIA** sets out his case for "tangible reality" in architecture with his heartfelt essay.
 - **Louis Sullivan**, the father of the skyscraper, writes about the Chicago Tribune Competition in an article from the February, 1923 issue of *Record*.
- Plus, **other essays, interviews and reviews** from the previous issues of *In the Cause of Architecture*.

Check back every Friday for new content.

BTS: Offices



Photography: © Christian Richters



Photography: © Brad Feinkopf

Check out June's **Expanded Building Types Study** section showcasing a Web-only portfolio of offices in addition to the projects featured in the magazine. From Holland to Ohio, get project descriptions, plans, specs, photos, and links to people and products involved.

archrecord2 for the emerging architect

DESIGN: New York architect **David Hu** designs two takes on the personality of tea. **WORK:** Alternative careers for young architects. **LIVE:** **Pop-a-Wheelie...** Saratoga Springs architect **Eric Whiting** uses his CAD talent to design three-wheeled racing cycles. **TALK:** Share your thoughts and opinions in the latest forum.

sponsored by

Green Architect

Find Web-only product reviews, links to manufacturers and weekly Web features on green projects and issues. **New green features appear regularly.**

sponsored by

DAILY NEWS

Get the latest scoop from the world of architecture.

sponsored by



Project Portfolio

Pack your bags...

Come with us as we travel to Japan, Spain, Germany and Austria to discover what **International Modernism** means today.

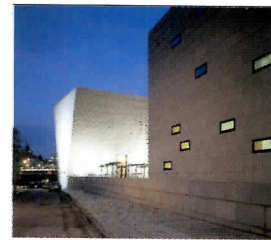

Photography: © Roland Halbe

sponsored by

House of the Month

Make yourself at home. This month, we give you the keys to the **LB House** by New York architect **Stan Allen**.

Interiors

Extra! Extra! Enter the Chicago Tribune Building's newly renovated press room. See the offices that **Perkins and Will** created for the Tribune's website staff.

Digital Practice

Connect to high-tech resources through product vendor guides and software reviews with links to manufacturer's websites. This month: **Profile: Display Devices.**

sponsored by

ARCHITECTURAL RECORD

07.2002

On the Cover: *Fisterra Cemetery*, by César Portela. Photograph by Hisao Suzuki
Right: *León Tanatorio*, by Baas Architects. Photograph by Eugeni Pons



News

- 23 **SOM designs WTC skyscraper for Silverstein**
- 29 **ARE pass rates increase**

Departments

- 15 **Editorial: A Singular Voice***
- 16 **Letters***
- 43 **Dates & Events***
- 51 **Archrecord2: For the emerging architect** by Kevin Lerner*
- 55 **Correspondent's File: Puerto Rico** by James S. Russell, AIA
- 61 **Critique: Urbanism is politics** by Michael Sorkin
- 65 **Practice Matters: Back to school** by Charles Linn, FAIA*
- 67 **Books: Urbanism gone awry**
- 71 **Projects Undertaken: Interment structures** by Sarah Amelar*
- 73 **Snapshot: Social sculptures in canvas** by Ingrid Whitehead
- 224 **Profile: Frank "Chip" Briscoe** by Deborah Snoonian, P.E.*

Projects

- 83 **Architecture for Remembrance** by Clifford A. Pearson*
The need to memorialize is eternal. In stone, steel, and glass, architects can create beauty in response to death.
- 84 **Memorials, Monuments, and Meaning** by Robert Ivy, FAIA*
- 88 **Memorial Garden, Germany** by Clifford A. Pearson*
Michael Singer/Luz and Partner
- 92 **León Tanatorio, Spain** by David Cohn*
BAAS Architects
- 98 **Chapel of St. Mary of the Angels, the Netherlands**
by Tracy Metz*
Mecanoo Architecten
- 102 **Srebrnice Cemetery, Slovenia** by William J. R. Curtis*
Ales Vodopivec with Nena Gabrovec
- 108 **Fisterra Cemetery, Spain** by David Cohn*
César Portela
- 112 **Reception Pavilion, Zorgvlied Cemetery, the Netherlands**
by Clifford A. Pearson
Claus en Kaan Architecten
- 116 **Anne Frank House, the Netherlands** by Clifford A. Pearson*
Bentheim Crouwel Architecten
- 120 **Who Owns Grief?** by James S. Russell, AIA*
- 124 **Architects Without Architecture at Ground Zero**
by Suzanne Stephens*

Building Types Study 811

- 131 **Introduction: Health Care** by John E. Czarnecki, Assoc. AIA
- 132 **Children's Medical Center, Georgia** by John E. Czarnecki, Assoc. AIA*
Stanley Beaman & Sears Architecture
- 136 **Sekii Ladies Clinic, Japan** by Naomi Pollock, AIA*
Atelier Hitoshi Abe
- 140 **Dental Clinic, Brazil** by John E. Czarnecki, Assoc. AIA*
MMBB Arquitectos
- 144 **Mott Children's Center, Washington** by Sheri Olson, AIA*
Zimmer Gunsul Frasca Partnership

www For 10 additional health-care projects, go to Building Types Study at architecturalrecord.com.

Building Science & Technology

- 149 **The House of the Future Has Arrived** 
by Sara Hart*
MIT researchers revolutionize house design for aging boomers.
- 163 **Digital Architect: Tools for the aging population** by Alan Joch*

Residential

- 171 **Introduction/News Briefs**
- 172 **PIA Awards** by Jane F. Kolleeny
Eight firms win awards for design excellence in housing.
- 174 **Bohlin House, Waverly, Pa.** by Raul A. Barreneche
Bohlin Cywinski Jackson
- 180 **Summer Cabin, Norway** by S.A. Miller
Jarmund/Vignsnæs
- 182 **Ocean Beach Residence, San Francisco** by Lisa Findley
Nick Noyes Architecture
- 188 **Van Sweden Bay House, Sherwood, Md.** by Jane F. Kolleeny
Sorg and Associates
- 193 **Kitchen & Bath Portfolio** by Rita Catinella
- 201 **Residential Products**

Products

- | | |
|--|-------------------------------------|
| 205 Paints and Finishes | 210 Product Literature |
| 209 Product Briefs | |
| 12 What's at | 215 Manufacturers' Spotlight |
| architecturalrecord.com | 217 Reader Service* |
| 212 AIA/CES Self-Report Form* | 220 Classified Advertising* |

 The AIA/ARCHITECTURAL RECORD
Continuing-Education Opportunities are "The House of
the Future Has Arrived" (page 149); "Want Drama? Need Solutions? Think
Doors!" (page 165), sponsored by Jeld-Wen.

www * You can find these stories at architecturalrecord.com,
including expanded coverage of projects. Explore the latest news about
emerging architects at architecturalrecord.com/archrecord2.

Visit

www.architecturalrecord.com

in the CAUSE of ARCHITECTURE

The **Online Journal of Ideas** from *Architectural Record*

In the Cause of Architecture presents a collection of essays, reviews, commentary, and interviews by and about the best minds in architecture and the associated arts. In the Cause of Architecture picks up where *Architectural Record* leaves off, delving more deeply into arts and ideas than the magazine can.

Submissions are always welcome. Go to the Web site for submission guidelines.

Check back every Friday for new content.

BTS: Health Care



Photography: © Alejandro Leveratto

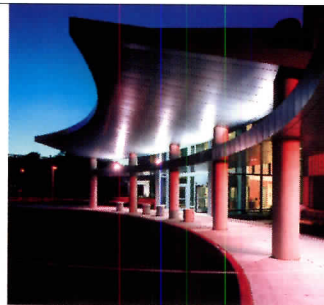

Photography: © Peter Vanderwerker

Check in to July's **Expanded Building Types Study** section showcasing a Web-only portfolio of health-care facilities in addition to the projects featured in the magazine. From Argentina to Kalamazoo, get project descriptions, plans, specs, photos, and links to people and products involved.

archrecord2 for the emerging architect

DESIGN: 26-year-old Brooklyn designer **Mike Latham** takes a maverick approach to becoming an architect and designs his own loft. **WORK:** How do young architects make a name for themselves in a competitive environment? This month: **Non-Traditional Careers for Architects** **TALK:** Share your thoughts and opinions in the latest forum.

sponsored by



Green Architect

Find Web-only product reviews, links to manufacturers and weekly Web features on green projects and issues. **New green features appear regularly.**

sponsored by **National Gypsum COMPANY**

Dodge
Sweets
McGraw Hill
CONSTRUCTION
Architectural Record
ENR
Regional Publications

DAILY NEWS

Get the latest scoop from the world of architecture.

sponsored by



Project Portfolio



Photography: © Christian Richters

In remembrance..

A look at how countries around the world remember the dead, with stone, steel and glass

sponsored by



House of the month

Your house is our homepage. This month, we give you the keys to the **House in Mulmur Hills** by Canadian architect **Ian MacDonald.**

Residential

There's no place like home. This month's quarterly residential section makes a splash with waterfront homes from San Francisco to Norway.

Digital Practice

Connect to high-tech resources through product vendor guides and software reviews with links to manufacturer's websites. This month: **Digital Tools for Age-Smart Housing.**

sponsored by



- news
 - daily news from the field
- projects
 - project portfolio
 - building types study
 - record houses
 - lighting
- archrecord2 for the emerging architect
- features
 - interviews
 - bw/ar awards
- departments
 - digital practice
 - building science/continuing ed.
 - green architect
 - editorial
 - letters
 - events
- about record
 - new this month
 - magazine index
 - subscribe
 - how to submit
 - advertise
 - editorial calendar
 - privacy policy
 - contact us
 - site map
- the AIA
 - join the AIA
 - www.aia.org
 - contract documents
- services
 - recruitment
 - advertisers
 - professional directories
- home

Earn CES Credits Online

Read *Record's* building science features/continuing education self-study courses and file for CES credits. New this month: **The House of the Future Has Arrived:** Fitting the house for aging architects.

The McGraw-Hill Companies

ARCHITECTURAL RECORD

08.2002

On the Cover: MoMA QNS, by Michael Maltzan, with Cooper, Robertson & Partners. Photographs by Christian Richters
Right: Austrian Cultural Forum, by Raimund Abraham.
Photograph by Michael Moran



News

- 23 **Initial WTC plans raise questions**

Departments

- 15 **Editorial: Outside the Lines**
- 17 **Letters***
- 40 **Dates & Events***
- 49 **Archrecord2: For the emerging architect** by Kevin Lerner
- 53 **Correspondent's File: Johannesburg** by Lisa Findley
- 59 **Critique: Advice for architects** by Robert Campbell, FAIA
- 63 **Practice Matters: Limited contract agreements** by Satish Rao
- 67 **Books: The ethics of design**
- 71 **Exhibitions: Zaha Hadid** by Joseph Giovannini
- 74 **Exhibitions: Swiss Expo.02** by Fred Bernstein
- 79 **Snapshot: Tee Houses** by Ingrid Whitehead
- 256 **Profile: Patricia Gay** by Ingrid Whitehead*

Features

- 84 **B.Arch.? M.Arch.? What's in a name?** by Andrea Oppenheimer Dean*
Is the familiar method used to train architects still relevant?
- 96 **Small, Medium, Large Firms, Part III: Which size is ideal for the future?** by Jane F. Kolleeny and Charles Linn, FAIA
Preparation and perception are the keys to success for any size firm.

Projects

- 105 **City Limits: Street-smart designs** by Robert Ivy, FAIA*
- 106 **MoMA QNS, New York City** by Clifford A. Pearson*
Michael Maltzan Architecture and Cooper, Robertson & Partners
The Manhattan institution gets a temporary address in Queens.
- 116 **Yerba Buena Lofts, San Francisco** by Clifford A. Pearson*
Stanley Saitowitz Office/Natoma Architects
A California developer tests the market for Modernist homes.
- 122 **Austrian Cultural Forum, New York City** James S. Russell, AIA*
Atelier Raimund Abraham
A needlelike building sews itself into the fabric of New York City.
- 130 **Beehive, Culver City, Calif.** by Dana Hutt*
Eric Owen Moss Architects
A playfully sculptural building generates an active workplace.

Building Types Study 812

- 141 **Introduction: Colleges and Universities** by Suzanne Stephens
 - 142 **Rothermere American Institute, England** by Suzanne Stephens*
Kohn Pedersen Fox Associates (International)
 - 146 **Information Services Building, New Zealand** by Elizabeth Arcuri*
Hardy Holzman Pfeiffer Associates
 - 150 **Mattin Center, Maryland** by Suzanne Stephens*
Tod Williams Billie Tsien Architects
 - 154 **Donald Danforth Plant Science Center, Missouri** by Peter MacKeith*
Nicholas Grimshaw and Partners in association with HOK
- www** For 10 additional college and university projects, go to Building Types Study at architecturalrecord.com.

Building Science & Technology

- 163 **Facade Engineering Emerges as a Highly Specialized Science and a Striking Art Form** by Sara Hart*
The modern curtain wall has evolved.
- 175 **Digital Architect: Painless upgrades** by Alan Joch*

Lighting

- 193 **Introduction**
- 195 **Creative Uses**
- 196 **MTV Online** by Leanne B. French
Horton Lees Brogden Lighting Design
- 200 **Multiplied Light** by Sheri Olson, AIA
Bullseye Connection Gallery; various Portland architects
- 209 **Rumi** by William Weathersby, Jr.
Nancy Mah Design
- 215 **Lighting Technology: HID** by Lindsay Audin
- 217 **Lighting Resources**

Products

- 223 **Glass and Glazing**
- 231 **Product Briefs**
- 236 **Product Literature**
- 12 **What's at architecturalrecord.com**
- 240 **AIA/CES Self-Report Form***
- 240 **Reader Service***
- 246 **Manufacturers' Spotlight**
- 252 **Classified Advertising***



The AIA/ARCHITECTURAL RECORD

Continuing-Education Opportunities are "Facade Engineering Emerges as a Highly Specialized Science and a Striking Art Form" (page 163); "Plumbing Sensor Technology Brings Innovative Solutions to Bathroom Design" (page 179), sponsored by Sloan; and

"Design Techniques for Controlling Movement Stress in Partitions and Ceilings" (page 185), sponsored by USG.

www *You can find these stories at architecturalrecord.com, including expanded coverage of projects.

Visit

www.architecturalrecord.com

Features

A Guide to American Schools of Architecture

This comprehensive compendium of information will become the indispensable resource for anyone researching and comparing the offerings of U.S. architecture programs.

Project Portfolio

A day trip to MoMA QNS! Be among the first to take the trip from Manhattan's West 53rd St., the legendary home of the Museum of Modern Art, to its new temporary home in Queens. Make the trip with an interactive diary with photos and 3D panoramas of the new building and the trip over.



Photography: © Susannah Shepherd

sponsored by  BENTLEY

a r c h i t e c t u r a l r e c o r d 2

PLY Architecture and Design, this month's featured firm, has designed much more than was shown in the magazine this month. Check out the other projects in **DESIGN**, only online. Plus, more news and features from the world of the emerging architect.

sponsored by  BlueBolt  ALUCOBOND  PITTSBURGH CORNING

in the CAUSE of ARCHITECTURE

The Online Journal of Ideas from Architectural Record

Presenting a collection of essays, reviews, commentary, interviews, and excerpts by and about the best minds in architecture and the associated arts. Check back regularly for new features.

Digital Practice

Connect to high-tech resources through product vendor guides and software reviews with links to manufacturer's websites. New this month: **The Upgrade Treadmill**.

sponsored by  Meridian PROJECT SYSTEMS  BlueBolt

Dodge
Sweets
Architectural Record
ENR
Regional Publications

**McGraw Hill
CONSTRUCTION**

DAILY NEWS

Get the latest scoop from the world of architecture.

sponsored by



Lighting

Record **lights up your life**, with links to the people and products behind this month's projects in the quarterly lighting section.

sponsored by



House of the Month

There's no place like home. A house designed by **Brian MacKay-Lyons** celebrates the form of the barn and the craftsmanship of Nova Scotia's shipbuilding tradition.



Photography: © James Steeves

BTS: Colleges & Universities



Photography: © Timothy Hursley

School is back in session with August's **Expanded Building Types Study** section, which features college and university architecture, including ten projects not seen in the magazine. From St. Louis to Switzerland, get project descriptions, plans, specs, photos, and links to people and products involved.

Green Architect

Find Web-only product reviews, links to manufacturers and weekly Web features on green projects and issues. **New green features appear regularly.**

sponsored by  National Gypsum COMPANY

Earn CES Credits Online

Read *Record's* building science features/continuing education self-study courses and file for CES credits. **New this month: Façade Engineering.**

ARCHITECTURAL RECORD

09.2002

On the Cover: SoHo Skyline Loft, by Dean/Wolf Architects. Photograph by Jeff Goldberg/ESTO

Right: W New York Times Square, by Brennan Beer Gorman Architects, interiors by Yabu Pushelberg. Photograph by Evan Dion

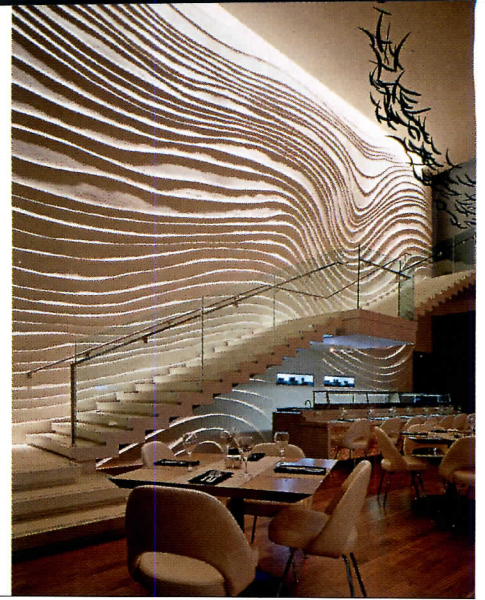

News

- 33 Design modified for SOM's Trump Tower Chicago**
- 36 Competitions for WTC announced**

Departments

- 19 Editorial: One Year Later***
- 25 Letters***
- 54 Dates & Events***
- 63 Archrecord2: For the emerging architect** by Kevin Lerner*
- 67 Critique: Power Plays at Ground Zero** by Michael Sorkin
- 71 Commentary: Ground Zero Planning** by James S. Russell, AIA
- 77 Practice Matters: Liability Insurance** by Roger C. Brady, AIA*
- 83 Exhibitions: Helmut Jacoby** by Clifford A. Pearson*
- 87 Books: Architecture's greatest hits**
- 93 Snapshot: A new pavilion in Ghent** by Ingrid Whitehead
- 264 Profile: Konstantin Grcic** by Josephine Minutillo*

Features

- 100 Richard Meier** by Robert Ivy, FAIA
Richard Meier speaks about current and future work.
- 110 Tunneling into the depths of color and light** by Sarah Amelar
A light installation bathes an underground tunnel in luminous color.

Building Types Study 813

- 121 Record Interiors Introduction**
- 122 Lee Residence, New York City** by Raul A. Barreneche*
Joel Sanders Architect
- 130 TBWA\Chiat\Day, San Francisco** by Lisa Findley*
Marmol Radziner + Associates
- 136 ImageNet, Oklahoma City** by David Dillon*
Elliott + Associates

- 140 Beacon Communications Office, Tokyo** by Naomi Pollock*
Klein Dytham Architecture
- 146 SoHo Skyline Loft, New York City** by Fred Bernstein*
Dean/Wolf Architects
- 154 W New York Times Square, New York City** by William Weathersby*
Brennan Beer Gorman Architects and Yabu Pushelberg
- 160 Cruise Bar and Restaurant, Australia** by David Clark*
Landini Associates

www For eight additional interior projects, go to Building Types Study at architecturalrecord.com.

Building Science & Technology

- 173 New Building Systems Mimic Nature and Return to a Biocentric Approach to Design** 
by Nancy B. Solomon, AIA*
Growth is good when in accordance with nature's blueprint.
- 183 Tech Briefs** by Barbara Knecht*

Digital Practice

- 205 News and Trends**
- 206 Man As a Meter** by Deborah Snoonian, P.E.
An electronic classroom is home to innovative audio-visual research.
- 213 Digital Architect: Digital Cameras** by Michael Bordenaro*
- 219 Digital Products** by Deborah Snoonian, P.E.*

Products

- 225 Interior Finishes**
- 229 Product Briefs**
- 230 ICFF Review**
- 232 Milan Furniture Fair Review**
- 240 Product Literature**
- 48 What's at architecturalrecord.com**
- 248 AIA/CES Self-Report Form***
- 254 Manufacturers' Spotlight**
- 224 Reader Service***
- 260 Classified Advertising***



The AIA/ARCHITECTURAL RECORD Continuing-Education Opportunity are "New Building Systems Mimic Nature and Return to a Biocentric Approach to Design," (page 173); "Wire and Cable Management with Poke-Thru Devices and Floor Boxes," (page 185), sponsored by Wiremold; "Designing with Architectural Precast: Enhance Your Next Project, Achieve Design Goals,

Control Costs," (page 191), sponsored by PCI; and "Gypsum Cavity Shaft Wall Systems: The Standard for Life Safety in Low-, Mid-, and High-Rise Construction," (page 197), sponsored by USG.

www * You can find these stories at architecturalrecord.com, including expanded coverage of projects, and Web-only special features.

Visit

www.architecturalrecord.com

Record Interiors



Photography: © Benny Chan/Fotoworks

The 32nd Annual installation of **Record Interiors** features a selection of projects from Tokyo to Oklaholma. Visit these spectacular spaces through the use of interactive floorplans that show you the view from inside. Plus, link to the people and products behind these interiors.

World Trade Center

The World Trade Center: Your Designs. Students, professionals and other members of the architectural community present design proposals for the World Trade Center site. Give us your opinion of the six official first-stage World Trade Center Proposals in our forum.

in the CAUSE of ARCHITECTURE

The Online Journal of Ideas from Architectural Record Presenting a collection of essays, reviews, commentary, interviews, and excerpts by and about the best minds in architecture and the associated arts. Check back regularly for new features.

archrecord2

The University of Arkansas **Design/Build Studio** built an entire house in a single semester. See construction photos and pictures of the crew online. Also, check out the projects in **DESIGN**, only online. Plus, more news and features from the world of the emerging architect.



Photography: © Courtesy of Phillip Todd

sponsored by



Digital Practice

Connect to high-tech resources through product vendor guides and software reviews with links to manufacturer's Web sites. New this month: **Digital Cameras.**

sponsored by



DAILY NEWS

Get the latest scoop from the world of architecture.

sponsored by



BTS: Interiors

Come inside! September's **Expanded Building Types Study** section features eight interior projects not seen in the magazine. From New York to California, get project descriptions, plans, specs, photos, and links to people and products involved.



Photography: © Marvin Rand

House of the Month



Photography: © Wayne Thom

Head for the mountains. Visit Studio B's 7th & Main, a multi-family housing unit in Aspen, Colorado, which reflects its neighborhood's Old West mining town character.

sponsored by



Features

A Guide to American Schools of Architecture This comprehensive compendium of information will become the indispensable resource for anyone researching and comparing the offerings of U.S. architecture programs.

Earn CES Credits Online

Read Record's building science features/continuing education self-study courses and file for CES credits. New this month: **Building Systems: New Building Systems Mimic Nature and Return to a Biocentric Approach to Design.**

Green Architect

Find Web-only product reviews, links to manufacturers and weekly Web features on green projects and issues. **New green features appear regularly.**

sponsored by



ARCHITECTURAL RECORD

10.2002



On the Cover: *HydraPier*, by *Asymptote*. Photograph by *Christian Richters*
Right: *Imperial War Museum North*, by *Studio Daniel Libeskind*. Photograph by *Richard Bryant/Arcaid*

News

- 35 Proposals for WTC
- 37 Winter Garden opens

Departments

- 17 Editorial: A Public Advocate*
- 19 Letters*
- 54 Dates & Events*
- 67 Archrecord2: For the emerging architect by *Kevin Lerner**
- 71 Correspondent's File: Chicago by *John E. Czarnecki, Assoc. AIA*
- 79 Critique: Name tags and architecture by *Robert Campbell, FAIA*
- 83 Books: Art, philosophy, and design by *Andrea Oppenheimer Dean*
- 87 Exhibitions: A new director at the CCA by *Clifford A. Pearson*
- 91 Snapshot: An observatory in New York by *Raul A. Barreneche*
- 288 Profile: Elizabeth Barlow Rogers by *John E. Czarnecki, Assoc. AIA**

Features

- 96 Ethics and the Architect by *John T. Matteson and Mary Z. Donovan*
How to represent clients' interests without betraying your own.

Projects

- 109 Small, Medium, Large by *Robert Ivy**
- 110 HydraPier, the Netherlands by *Tracy Metz**
Asymptote
An exhibition pavilion takes cues from water and a nearby airport.
- 116 Camp Paintrock, Wyoming by *Sarah Amelar**
Charles Rose Architects
A camp for inner-city teens echoes the rural Wyoming landscape.
- 124 Imperial War Museum, United Kingdom by *James S. Russell, AIA**
Studio Daniel Libeskind
On a budget, a museum settles for a building of less complexity.
- 132 Thaw Conservation Center, New York City
by *Deborah Snoonian, P.E.**
Samuel Anderson Architect
An attic becomes a new home for a museum's paper conservators.
- 136 Iron Studio, North Carolina by *Sara Hart**
Frank Harmon, FAIA
A few considered moves make architecture out of a prefab shed.

- 140 Munich Re South 1, Germany by *David Cohn**
Baumschlager + Eberle
A sleek corporate office emerges from a nondescript building.

Building Types Study 814

- 155 Introduction: Retail by *Sara Hart*
- 156 Apple Store, New York City by *Raul A. Barreneche**
Bohlin Cywinski Jackson
- 162 Max Mara, New York City by *Suzanne Stephens**
Duccio Grassi Architects
- 166 Hermès, Tokyo by *Raul A. Barreneche**
Renzo Piano Building Workshop

www For 10 additional retail projects, go to Building Types Study at architecturalrecord.com.

Building Science & Technology

- 185 Both New and Improved Advances in Seismic Technology Promise Safer Buildings by *Michael Bordenaro**
Architects are developing creative solutions for earthquake safety.
- 199 Digital Architect: E-documents vs. paper by *Alan Joch**

Residential

- 227 Introduction/News Briefs
- 228 1310 East Union, Seattle by *Sheri Olson, AIA**
The Miller/Hull Partnership
- 234 Housing at Almere, Holland by *James S. Russell, AIA**
UN Studio
- 239 Split, Tokyo by *Naomi Pollock, AIA**
Chiba Manabu Architects
- 244 Davis and Warshaw Building, New York City by *Suzanne Stephens**
Jon Michael Schwarting Architect
- 249 Residential Products

Products

- | | |
|---|-------------------------------|
| 257 Thermal and Moisture Protection | 261 Product Briefs |
| 14 What's at architecturalrecord.com | 268 Product Literature |
| 272 Record Houses 2003 Form | 274 AIA/CES Self-Report Form* |
| 273 Reader Service* | 278 Manufacturers' Spotlight |
| | 284 Classified Advertising* |



The AIA/ARCHITECTURAL RECORD

Continuing-Education Opportunities are "Both New and Improved Advances in Seismic Technologies Promise Safer Buildings" (page 185); "Impact Resistant Systems: Security in a Tiffany Setting" (page 206), sponsored by *Weather Shield*; "Understanding the UL Directory: Fire Resistant

Assemblies" (page 213), sponsored by *National Gypsum*; and "Designing for Occupant Comfort" (page 219), sponsored by *American Plastics Council*.

www * You can find these stories at architecturalrecord.com, including expanded coverage of projects, and Web-only special features.

www.architecturalrecord.com

Project Portfolio



Photography: © Chuck Choi Photography

sponsored by



Call your travel agent. Travel across the country and around the world for this month's featured projects. Visit New York's Morgan Library, a kid's camp in Wyoming and then cross the Atlantic for a tour of the Imperial War Museum in Manchester, England. Plus, link to the people and products behind these interiors.

World Trade Center

The World Trade Center: Your Designs. Students and professionals in the architectural community present design proposals for the World Trade Center site. See the projects and learn how to submit your own. Share your opinion of the official proposals in our forum, and keep up with the latest design news.

in the CAUSE of ARCHITECTURE

The Online Journal of Ideas from Architectural Record Presenting a collection of essays, reviews, commentary, interviews, and excerpts by and about the best minds in architecture and the associated arts. This month: A conversation with Craig Whitaker, author of Next Steps, Hard Choices, an urban plan for the World Trade Center site.

archrecord 2

DESIGN Ann Arbor, Michigan architect Keith Mitnick bridges the divide between theory and practice. See a complete portfolio of his work, exclusively online. Plus, more news and features from the world of the emerging architect.



Photography: © Keith Mitnick

sponsored by



Digital Practice

Connect to high-tech resources through product vendor guides and software reviews with links to manufacturer's Web sites. New this month: Paper or Digitized?

sponsored by



McGraw Hill
CONSTRUCTION

Dodge
Sweets
Architectural Record
ENR
Regional Publications

DAILY NEWS

Get the latest scoop from the world of architecture.

sponsored by



BTS: Retail

Come shopping with us in October's Expanded Building Types Study, featuring ten retail projects not seen in the magazine. While visiting Jil Sander, Van Cleef and Arpels, the Nike Goddess Prototype Store, D'Fly, and others, get project descriptions, plans, specs, photos, and links to people and products involved.



Photography: © Peter Aarons/Esto

Residential

Raise the bar. Raise the roof. This month, Record shows innovative projects in Seattle, New York, Japan, and the Netherlands that set new standards of quality in residential design.

sponsored by



House of the Month



Photography: © Peter Bastinelli Kerze

Not your typical lakefront cottage. Leesa+Sam's Cottage, designed by Charles R. Stinson, displays a vibrant use of color to warm up the cold Minnesota winters.

sponsored by



Earn CES Credits Online

Read Record's building science features/continuing education self-study courses and file for CES credits. New this month: Seismic Technology.

Green Architect

Find Web-only product reviews, links to manufacturers and weekly Web features on green projects and issues. New green features appear regularly.

sponsored by



ARCHITECTURAL RECORD

11.2002

On the Cover: *Cathedral of Our Lady of the Angels*, by Rafael Moneo. Photograph by Julius Shulman
Right: *Morimoto*, by Karim Rashid. Photograph by David Joseph/Snaps



News

- 26 **Pelli's transparent Minneapolis library**
- 28 **Architects begin WTC planning**

Departments

- 17 **Editorial: Down They Come***
- 19 **Letters***
- 47 **Dates & Events***
- 53 **Archrecord2: For the emerging architect** by Kevin Lerner*
- 57 **Correspondent's File: Postcard from Berlin**
by Michael Stanton, FAIA
- 63 **Critique: Picking Ground Zero Design Firms** by Michael Sorkin
- 69 **Practice: The Collaboration Matrix** by James F. Porter, FAIA
- 73 **Books: Looking Back on Modernism** by Kenneth Caldwell
- 79 **Snapshot: Intergalactic Design in Japan** by Naomi Pollock
- 292 **Profile: Ayala Sefarty** by Randi Greenberg*

Features

- 84 **Architecture as Image-Maker** by Jane F. Kolleeny
Wise clients work with architects to build their businesses.
- 88 **Business Week/Architectural Record Awards***
These projects demonstrate that good design is good business.

Projects

- 124 **Cathedral of Our Lady of the Angels, Los Angeles**
by Suzanne Stephens*
Jose Rafael Moneo Arquitecto
Moneo attempts to inspire religious awe with architecture.
- 134 **South Court of The New York Public Library, New York City**
by Raul A. Barreneche*
Davis Brody Bond
A reclaimed Beaux-Arts courtyard gives birth to a sleek addition.
- 142 **Yokohama International Port Terminal, Japan** by Naomi Pollock*
Foreign Office Architects
A port terminal blurs the line between building and landscape.
- 150 **Herman Miller plant, Georgia** by Christine Kreyling*
Mack Scogin Merrill Elam Architects
A new facility mediates between the natural and the man-made.

Building Types Study 815

- 159 **Introduction: Restaurants** by Clifford A. Pearson
- 160 **Suba, New York City** by Elizabeth Harrison Kubany*
Andre Kikoski Architect
- 164 **Morimoto, Philadelphia** by Clifford A. Pearson*
Karim Rashid
- 168 **Chosun Galbi, Los Angeles** by Suzanne Stephens*
Richard Cutts Lundquist, AIA
- 172 **Astro, Iceland** by Clifford A. Pearson*
M.Y. Studio

www For 10 additional restaurants, go to Building Types Study at architecturalrecord.com.

Building Science & Technology

- 187 **Designers Get More Information Earlier and Faster via Affordable Rapid-Prototyping Tools**
by Michael Bordenaro*
The creation of 3D models is increasingly being applied in schematic design.
- 189 **Digital Architect: Maintaining a Technical Edge** by Alan Joch*

Lighting

- 227 **Introduction** by William Weathersby, Jr.
- 229 **Creative Uses**
- 230 **Lighting Profile: Yann Kersalé** by Claire Downey*
- 238 **D'Fly, New York City** by Leanne B. French*
3deluxe and OSRAM Lighting Consulting
- 244 **Craft, New York City** by William Weathersby, Jr.*
Bentel & Bentel Architects/Planners
- 253 **Lighting Technology** by Charles Linn, FAIA
- 255 **Lighting Resources** by Rita Catinella

Products

- 261 **Architectural Metalwork**
- 265 **Product Briefs**
- 270 **Product Literature**
- 276 **Reader Service***
- 282 **Manufacturers' Spotlight**
- 288 **Classified Advertising***
- 14 **What's at**
architecturalrecord.com
- 274 **AIA/CES Self-Report Form***



The AIA/ARCHITECTURAL RECORD

Continuing-Education Opportunities are "Designers Get More Information Earlier and Faster via Affordable Rapid-Prototyping Tools" (page 187); "Window Walls: Bringing the World into Your Living Room" (page 203), sponsored by JELD-WEN; "Fluid Applied Air/Moisture Barriers for Moisture Control and Mold Prevention in Wall Construction" (page 209), sponsored by Sto

Corporation; "Acrylic Block Offers Privacy and Light" (page 215), sponsored by Hy-Lite Products; and "Building Tomorrow's Parking Structures Today with Steel Frames" (page 221), sponsored by The American Institute of Steel Construction.

www * You can find these stories at architecturalrecord.com, including expanded coverage of projects, and Web-only special features.

Project Portfolio

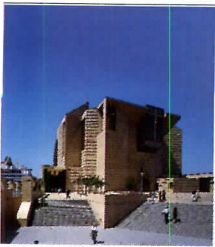

Photography: © Julius Shulman

Rafael Moneo's Cathedral of Our Lady of the Angels: Take an exclusive look at this new landmark's state-of-the-art seismic underpinnings. Plus, an addition to the New York Public Library, a sea terminal in Yokohama, and the new headquarters for Herman Miller.

sponsored by



World Trade Center

The World Trade Center: Your Designs. Students and professionals in the architectural community present design proposals for the World Trade Center site. See the projects and learn how to submit your own. Share your opinion of the official proposals in our forum, and keep up with the latest design news.

in the CAUSE of ARCHITECTURE

The Online Journal of Ideas from Architectural Record Presenting a collection of essays, reviews, commentary, interviews, and excerpts by and about the best minds in architecture and the associated arts. *Before the Architecture:* Excerpts from a report on Ground Zero by urban planner Craig Whitaker, plus an interview with Whitaker. Coming this month: Edward Durell Stone's Conger Goodyear House: saving a neglected Modernist masterpiece on Long Island, featuring interactive walk-throughs.

archrecord2

DESIGN Studio Completiva: complete coverage of this emerging firm from Denver, including several large-scale projects not seen in the magazine. **WORK** Further coverage of the Tree Theatre + Play Compound, including in-progress photos of the team that built it. Plus, more news and features from the world of the emerging architect.



Photography: © Courtesy of Studio Completiva

sponsored by



Digital Practice

Connect to high-tech resources through product vendor guides and software reviews with links to manufacturer's Web sites. **New this month: Technology & Firm Structure.**

sponsored by



Dodge
Sweets
Architectural Record
ENR
Regional Publications



DAILY NEWS

Get the latest scoop from the world of architecture.

sponsored by



BTS: Restaurants

Savor two weeks worth of dinners in November's Restaurant **Expanded Building Types Studies** including the four restaurants featured in the magazine, plus an extra ten, exclusively on the web. And for dessert, an international selection, Montreal, Atlanta, Amsterdam...and others. Get project descriptions, plans, specs, photos, and links to people and products involved.



Photography: © Robert Reck

sponsored by



Lighting

Shedding a light on the subject: This month, *Record* shows links to the people and products behind the lighting projects, plus a more in-depth look at two of the projects, through links to coverage in the BTS.

sponsored by



Good Design is Good Business



Photography: © Peter Paige Photography

2002 Business Week/ Architectural Record Awards:

Full coverage of the awards, including the finalists and the winners, with photographs of the projects.

sponsored by



Earn CES Credits Online

Read *Record's* building science features/continuing education self-study courses and file for CES credits. **New this month: Prototyping, plus four additional new courses.**

Green Architect

Find Web-only product reviews, links to manufacturers and weekly Web features on green projects and issues. **New green features appear regularly.**

sponsored by



ARCHITECTURAL RECORD

12.2002

On the Cover: *Busan Observation Tower* competition entry, by Plexus r+d.
Right: *Wall-less House*, by Tezuka Architects. Photograph by Katsuhisa Kida



News

- 23 **Forecasts predict construction industry boom to end**
- 26 **Development at the WTC site***

Departments

- 17 **Editorial: Another Pair of Eyes***
- 20 **Letters***
- 39 **Dates & Events***
- 45 **Archrecord2: For the emerging architect** by Kevin Lerner*
- 49 **Critique: Picking fights in architecture** by Robert Campbell, FAIA
- 53 **Practice Matters: Planning strategies for firms** by Satish Rao
- 57 **Commentary: A debate about a book** by Christopher Alexander
- 59 **Books: Exploring Japan** by Naomi R. Pollock, AIA
- 63 **Exhibitions: Arne Jacobsen** by Nicholas Adams
- 67 **Snapshot: Aluminum Centre** by Christina Rogers
- 256 **Profile: Marcel Wanders** by Josephine Minutillo*

Features

- 72 **Taking a Leap of Faith** by John E. Czarnecki, Assoc. AIA*
Why would a client entrust a young, untested firm with a project?

Projects

- 85 **Design Vanguard 2002** by Joseph Giovannini
At a time when there is no clear path for the profession of architecture, young architects are choosing and inventing their own.
- 88 **propeller z, Austria** by Sarah Amelar*
- 92 **Tolkin & Associates, California** by Suzanne Stephens*
- 98 **Tezuka Architects, Japan** by Naomi R. Pollock, AIA*
- 102 **René van Zuuk Architekten, the Netherlands** by Tracy Metz*
- 108 **Plexus r+d, Georgia** by Sara Hart*
- 114 **JKMM Architects, Finland** by Clifford A. Pearson*
- 118 **3SIX0, Rhode Island** by William Weathersby, Jr.*
- 122 **Sahel Al-Hiyari, Jordan** by Kevin Lerner*
- 126 **Adjaye Associates, England** by James S. Russell, AIA*
- 130 **Predock_Frane Architects, California** by Charles Linn, FAIA*

Building Types Study 816

- 135 **Introduction: Design Studios** by Jane F. Kolleeny
- 136 **Oliva - Remolà Studio, Terrassa, Spain** by David Cohn*

- 140 **Suyama Peterson Deguchi, Seattle** by Sheri Olson*
- 144 **RSP Architects, Minneapolis** by Camille LeFevre*
- 148 **Hammel, Green and Abrahamson, Minneapolis** by Camille LeFevre*

www For 10 additional design studio projects, go to Building Types Study at architecturalrecord.com.

Building Science & Technology

- 153 **There Is No North Arrow in Outer Space** 
by Sara Hart*
Space architecture is already a specialty within the profession. Its lessons will infiltrate the mainstream, changing the way we design.

Digital Practice

- 167 **News & Trends**
- 170 **Building with clicks, not bricks** by Sam Lubell
Architects who design in virtual space say they enjoy the pleasures of design, with none of the headaches of construction.
- 177 **Digital Architect: Scanner update** by Michael Bordenaro
- 180 **Product Reviews: Tools to draw, model, bill, manage**
by Deborah Snoonian, P.E.

Product Reports

- 182 **Introduction** by Rita Catinella
- 184 **Editors Picks**
- 187 **General Data**
- 191 **Sitework, Concrete & Masonry**
- 195 **Metals, Wood & Plastics**
- 199 **Thermal & Moisture**
- 201 **Doors & Windows**
- 207 **Finishes**
- 212 **Specialties**
- 215 **Equipment**
- 218 **Furnishings**
- 223 **Special Construction & Conveying Systems**
- 225 **Mechanical**
- 228 **Electrical**

- 48 **What's at**
- 240 **AIA/CES Self-Report Form***
- architecturalrecord.com
- 241 **Manufacturers' Spotlight**
- 240 **Reader Service***
- 252 **Classified Advertising***

 **The AIA/ARCHITECTURAL RECORD**
Continuing-Education Opportunities are "There Is No North Arrow in Outer Space" (page 153); "Vinyl By Design" (page 161), sponsored by The Vinyl Institute.

www * You can find these stories at architecturalrecord.com, including expanded coverage of projects, continuing-education opportunities, and Web-only special features.

OUR CONNECTION TO THE LAND IS OUR CONNECTION TO THE FUTURE.

Kendall Wilson, Principal of Envision Design

*"No one owns the air we breathe or the rain that falls.
The earth belongs to everyone so we all have to respect it.
When people ask me 'what is the cost to do sustainable design?'
I ask them, 'what is the cost not to?' "*

At DuPont Antron we pay close attention to our total environmental impact. So close that DuPont™ Antron® nylon is the first and only carpet fiber certified as an Environmentally Preferable Product. Call **1-800-4 DUPONT** or visit **antron.dupont.com** to see how this makes it easier than ever to meet your sustainable design needs. DuPont™ Antron®. There is no equal.

Environmentally Preferable Products, established by Executive Order 13101, are certified by Scientific Certification Systems as having a lesser or reduced effect on health and the environment when compared with competing products that serve the same purpose. The DuPont Oval Logo, DuPont™ and Antron® are trademarks or registered trademarks of DuPont. Antron® is a registered trademark of DuPont for its brand of nylon. Only DuPont makes Antron®. © 2002 DuPont

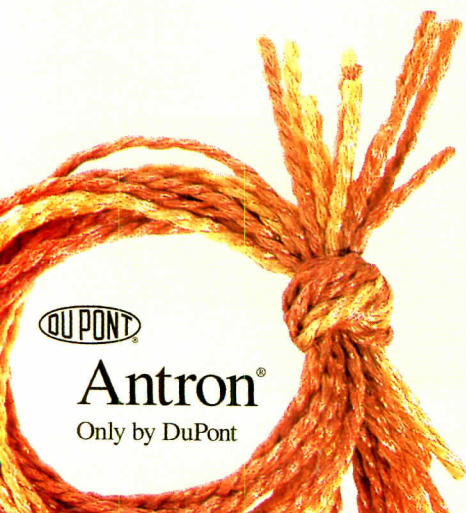

DUPONT

Antron®
Only by DuPont





Prize Research

Editorial

By Robert Ivy, FAIA

Nicholas Grimshaw's Eden Project in Cornwall, England, featured on this month's cover, both startles and instructs. The human form appears diminished above the 35-foot geometry of the geodesic dome, here covered in the air-filled, gossamerlike skin of ETFE, a space-age foil that was actually invented decades ago. The geodesic dome's inventor, Buckminster Fuller, whose prodigiously fertile mind was devoted to architectural research, would not be surprised to see this marriage of materials by a British architect, transforming his structural ideas into light-as-air bubbles at the lunar scale.

Bucky was the tip (quite a tip!) of a tsunami. For the post-World War II generation, for whom Ronald Reagan (the spokesperson for General Electric) declared "Progress is our most important product," research promised an ever-brighter future; space, our national challenge, lent a cosmic impetus to scientific pursuits. Tarnished, even perverted, by subsequent events such as the war in Vietnam, our national hunger for continually unfolding newness waned, as architects took up formal exploration, historicism, or theory: We left the heavy lifting, and the role of invention, to others.

Research did not disappear. Like monasteries that kept the world of ideas alive when the secular world seemed bent on upheaval, universities carried the torch. Institutions such as MIT, Carnegie Mellon, and Georgia Tech, aided by corporate sponsorships, have continued to advance our understanding of productivity in the workplace, building materials, the feasibility of mass-produced housing, and the benefits of digital technology. Nor was research locked up in ivy. Engineers, always hungry for new applications and improved systems, have encouraged research within their firms.

As the millennium turned, however, architects rejoined the race. Today, research extends beyond pure science to engage social analysis, as Rem Koolhaas examines sprawling cities worldwide for clues to their messy vitality. Or, for architects like Santiago Calatrava, research may mean artistic discovery, in which drawings merge into kinetic sculpture. The

gigantic moving roof at the Milwaukee Museum of Art owes its undulating form to smaller-scale investigations by Calatrava that blur the distinction between science and art.

Here is breaking news: Whether in building systems or in more esoteric pursuits, architectural research has a major new champion. As reported in this magazine in December, the College of Fellows of the American Institute of Architects recently inaugurated the Latrobe Fellowship. Initially funded by the executive committee of the College of Fellows with a \$50,000 prize to "promote research to advance the profession," the first award went to a Philadelphia firm, Kieran Timberlake Associates. Our current building-science story on technology transfer (see page 131) describes how the winning architects dedicated their grant to devising a new construction methodology. A stunning wall system with improved thermal characteristics under construction at the University of Pennsylvania resulted.

Encouraged by the program's initial successes, the Fellows decided to up the ante to international prominence: AIA meets Pritzker Prize or the Premium Imperiale. By consolidating a welter of worthwhile but smaller stipends already offered by the Institute, the money fell automatically into place. In the future, the Latrobe will consist of a single biennial award of \$100,000—twice the original amount. Because of the heft of the purse, this grant will bring strong focus to architectural research throughout the media and the profession, while the advances made will spin out their own benefits during the intervening months. In a single stroke, with vision, action, and cash, the College of Fellows has elevated the content of architecture to the same high plane as its form. No research is required to admire the decision.



Record News

Highlights **Piano's N.Y. Times tower** p. 24
Examining WTC wreckage p. 26
Trump's Chicago plans p. 32
Lincoln Center redevelopment p. 34



Ando (above) has designed the Fabrice Complex (top) in Treviso and the Eychaner/Lee House in Chicago (left).

Tadao Ando honored with 2002 AIA Gold Medal

On December 6, 2001, the day before the 60th anniversary of Pearl Harbor, the American Institute of Architects (AIA) selected Japanese architect Tadao Ando, Hon. AIA, as the 59th recipient of the AIA Gold Medal, the highest honor the AIA confers on an individual.

The Gold Medal recognizes someone whose body of work has had a significant and lasting influence on the theory and practice of architecture. Ando, 60, will receive the Gold Medal at the 2002 American Architectural Foundation Accent on Architecture gala Friday, March 1, in Washington, D.C.

Past Gold Medal winners include Thomas Jefferson, Frank Lloyd Wright, Louis Sullivan, I.M. Pei, FAIA, and 2001 winner Michael Graves, FAIA. In recognition of their legacy to architecture, the name of each Gold Medal recipient is chis-

eled into a granite wall of honor located in the lobby of the AIA headquarters in Washington, D.C.

Ando told RECORD, "Having learned from masters such as Frank Lloyd Wright, Mies van der Rohe, and Louis Kahn, I feel so honored to be awarded the greatest medal from the AIA. I will continue trying my best to make buildings that will give a stimulus to the architectural culture in the world."

Born in Osaka, Japan, in 1941, Ando did not receive any formal architectural education. He established Tadao Ando Architect & Associates in 1970. His recent projects include the Fabrice/Benetton Communications Research Center [January 2001, page 80], Pulitzer Foundation for the Arts in St. Louis (this issue, page 55), and the Eychaner/Lee House in Chicago. *John E. Czarnecki, Assoc. AIA*

Thompson, Ventulett, Stainback wins 2002 AIA Firm Award

The American Institute of Architects (AIA) named Atlanta firm Thompson, Ventulett, Stainback & Associates (TVS) as recipient of the 2002 AIA Architecture Firm Award.

The highest honor the AIA confers on an architecture firm, the award recognizes a practice that has produced distinguished architecture consistently for at least 10 years. The award will be presented to TVS at the 2002 American Architectural Foundation Accent on Architecture gala Friday, March 1, in Washington, D.C.

Previous recipients include Gensler; Kohn Pedersen Fox Associates; I.M. Pei & Partners;

Cesar Pelli & Associates; Skidmore, Owings & Merrill; and 2001 winner Herbert Lewis Kruse Blunck Architecture.

"The reaction [when notified that TVS won] was just overwhelming. It really was a rewarding experience to tell the firm," said Roger Neuenschwander, AIA, presi-



TVS employees in Atlanta.

dent of TVS. "To be selected by peers is fantastic: it validates our commitment to create good design. It's the ultimate recognition for us."

Founded in 1968, TVS established itself in the Atlanta area by designing the Omni/CNN Center and the Georgia World Congress Center. Recent projects include the Woodruff Arts Center Renovation, Philadelphia Convention Center, McCormick Place Expansion, and the United Parcel Service world headquarters.

In nominating the firm, Lugean L. Chilcote, FAIA, and Thompson E. Penny, FAIA, write: "We have



Chicago's McCormick Place expansion.

observed at TVS a corporate culture that emphasizes collaboration, continuity, and depth and breadth of achievement and expertise." *JEC*

OFF THE RECORD

San Francisco architect **Gordon Chong, FAIA**, has begun his term as the 2002 president of the American Institute of Architects. Chong is the founding partner of the 85-person firm Gordon H. Chong & Partners.

Terry Farrell and Partners has been selected to master plan London's Millennium Dome site with 5,000 homes, as well as offices, retail, and open space. **HOK** will design a 20,000-seat Millennium Dome arena.

Bill Lacy, FAIA, executive director of the Pritzker Prize, stepped down as president of Purchase College of the State University of New York in December. Lacy had that position since 1993.

Rafael Viñoly, FAIA, has been selected to design the new Tampa Museum of Art building. Construction on the 125,000-square-foot building will begin in 2003. Viñoly was one of four finalists considered for the job, including **Arquitectonica, Polshek Partnership**, and **Machado & Silveti**.

The Prairie View A&M University School of Architecture has selected **Michael Rotondi of Roto Architects** with **HKS** of Dallas as the architects of its new school facility. Short-listed firms included **Gwathmey Siegel & Associates, Carlos Jimenez, Antoine Predock**, and **Michael Graves**.

Prince Charles at the Building for the 21st Century conference in London in December: "At the top of these new structures, let's see genuine artistry that truly reaches the heart and soul of those who look on, rather than the overblown phallic structures and depressingly predictable antennae that say more about architectural ego than craftsmanship." For a complete story by *Engineering News Record* ("Rapid Evacuation Concepts Aired") on the Building for the 21st Century conference, visit architecturalrecord.com/wtc.

Piano's N.Y. Times tower moves forward

Renzo Piano unveiled his detailed architectural models and drawings for a 52-story tower for The New York Times Company at a December 13 press conference.

The event took place just hours after the New York Times Company and developer Forest City Ratner Companies (FCRC) posted letters of credit valued at \$106 million to acquire the site on Eighth Avenue between 40th and 41st streets. A total of 55 businesses—ranging from sex shops to architecture firms—will be displaced by the tower. The estimated construction cost was not released. Ground breaking will likely occur in 2003.

Piano called his design, developed with Fox & Fowle Architects, "an expression of love for this city and the values it represents." The building will have two skins. Suspended on



A photomontage (left) illustrates Piano's tower. A model (above) shows the 40th Street elevation.

screens 18 inches from one skin of transparent glass will be a second skin with about 250,000 white ceramic rods, 1/8 inches in diameter. The rods will filter sunlight but will be spaced to allow views outside. The building itself will be 748 feet tall, but the ceramic screens will reach 840 feet, and a central mast will top out at 1,142 feet.

The Times will own and occupy 800,000 square feet of space on floors 2 through 28. FCRC will lease offices on floors 29 through 50. The

ground floor will include a lobby, auditorium, and retail space. A conference facility on the top floor will be surrounded by a grove of trees.

In the wake of the September 11 tragedy, the Times emphasized that it was committed to a tall building that appeared welcoming, visible, and transparent. Michael Golden, vice chair of The New York Times Company, said, "This building is designed from the ground up to reinforce the values of The New York Times Company." *JEC*

AIA anticipates positive net assets total through 2001; shifts primary access to electronic means for key member services

Taking steps to financial recovery, the American Institute of Architects (AIA) expected to report a positive net assets total for the end of 2001 and continues to plan for net assets of \$2.5 million by the end of 2003.

Through 2000, the AIA's completed audit by PricewaterhouseCoopers shows total net assets of negative \$1.475 million, which is an improvement from the auditor's worst-case calculation (in May 2001) of negative \$4.4 million. As *ARCHITECTURAL RECORD* has reported [June 2001, page 28; December 2001, page 24], a combination of events in late 2001 further improved the AIA's net assets total. Through financial settlements by the AIA with nearly 60 AECdirect creditors, the AIA's net assets deficit was reduced by almost \$1.5 million. PricewaterhouseCoopers revised downward the sum of the AECdirect deficit that must be consolidated with the AIA budget. The institute's financial situation is also improved with a forecast net income of \$2.146 million for 2001 that far exceeds the budgeted net income of \$1.446 million. The exact cost of AECdirect to the institute has not been calculated, and previously reported estimates of losses attributed to AECdirect had no basis in fact.

Following the board of directors meeting in early December, the AIA instituted changes that ensure primary access to key services will be through electronic means. The AIA restricted physical access to its library/archive to an appointment-only basis and eliminated the print version of *AIArchitect*, the AIA's national newsletter. In a written statement to *ARCHITECTURAL RECORD*, Chuck Hamlin, managing director of communications for the AIA, said: "These changes are a direct response to the ways in which AIA members wish to receive services."

What had been a monthly print newsletter through 2000, *AIArchitect* was reduced to quarterly digest print publication last year. It will now be published exclusively via the AIA members-only Web portal.

The AIA library and archives, located in the AIA national office in Washington, D.C., is now open by appointment only. Hamlin said, "The AIA library and archives will continue to provide a range of services to members, but with an emphasis on electronic search capabilities through the MyAIA members-only portal (www.aia.org). While this ongoing emphasis required the elimination of several staff positions at the national component, the change focuses more resources on the needs of the AIA's worldwide membership." *JEC*

GROUP SKETCHPAD



With a Compaq Evo™ Workstation, architects and engineers can collaborate to build complete, three-dimensional building models. Quickly and easily. Because they use the latest Intel® Xeon™ Processor technology, our workstations can handle the load—even complex CAD applications. A reliable design platform means faster time to market. And fewer trips back to the drawing board.



The Power of
MACROPROCESSING

to find out more go to compaq.com/workstations
or call 1-800-888-0414

Compaq PCs use genuine Microsoft® Windows®
www.microsoft.com/piracy/howtotell

Compaq is not liable for editorial, pictorial or typographical errors in this advertisement. Compaq and the Compaq logo are registered in the U.S. Patent and Trademark Office. Evo is a trademark of Compaq Information Technologies Group, L.P. Inspiration Technology is a trademark of Compaq Information Technologies Group, L.P. in the U.S. and other countries. Intel, the Intel Inside logo, and Intel Xeon are trademarks or registered trademarks of Intel Corporation or its subsidiaries in the United States and other countries. Products and company names mentioned herein may be trademarks and/or registered trademarks of other countries. ©2001 Compaq Computer Corporation.

COMPAQ
Inspiration Technology

SPECIAL REPORT

Symposium speakers, including Moynihan, insist on freedom without fortresses

Buildings in the United States, especially public buildings, cannot be built as insular fortresses that are unwelcoming to the public. That was the message of speakers, including the Honorable Daniel Patrick Moynihan, former U.S. senator from New York, in a symposium "Freedom Without Fortresses? Shaping the New Secure Environment," at the National Building Museum in Washington, D.C., on November 27. The symposium, cosponsored by ARCHITECTURAL RECORD, the American Institute of Architects, the Urban Land Institute, and RTKL, explored the impact of the September 11 attacks on the built environment.

Moderated by Robert Ivy, FAIA, editor in chief of ARCHITECTURAL RECORD, the panel addressed questions related to urban planning, psychology, and public spaces.

Harold L. Adams, FAIA, RIBA, JIA, chair of RTKL, introduced Moynihan, who said public buildings must have free and open access. "Architecture is inescapably a political art and it reports faithfully for ages to come

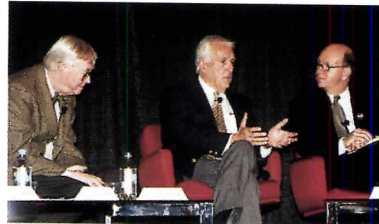

Symposium participants (from left) Daniel Patrick Moynihan, Richard Farson, Robert Ivy, FAIA, and Harold L. Adams, FAIA, with Farson.

what the political values of a particular age were," Moynihan said. "Surely ours must be openness and fearlessness in the face of those who hide in the darkness. A precaution, yes. Sequester, no."

Other speakers included architect and planner Jonathan Barnett, FAIA, AICP; Richard Farson, president, Western Behavioral Sciences Institute; and Jeri Thomson, secretary of the U.S. Senate.

Farson, a psychologist, spoke of the psychology of security and the paradoxes and unintended consequences of security measures. He said, for example, "The paradox of national success is that our very strength makes us vulnerable—our power, our wealth, our standard of living, our influence, and a complex,

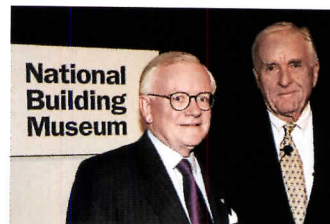

target-rich environment."

Brief responses to the presenters were offered by a number of experts. For a full list of speakers and more about this event, visit www.archrecord.com/wtc JEC

Ground Zero panel discussion

The National Building Museum in Washington, D.C., will host a panel discussion, "From Ground Zero," at 6:30 P.M., Monday, January 28, with key figures that have been working at Ground Zero. Panelists include Daniel A. Cuoco, P.E., president and managing principal of LZA Technology, a division of the Thornton-Tomasetti Group; George J. Tamaro, P.E., partner, Mueser Rutledge Consulting Engineers; and Ralph Johnson, senior vice president, Turner Construction Company. Charles H. Thornton, P.E., chair and managing principal of Thornton-Tomasetti Group, will moderate the discussion. This event is cosponsored by the Associated General Contractors of America and the American Council of Engineering Companies. Visit www.nbm.org for more information.

Forensics engineering expert studying WTC steel to determine precisely how towers failed



Astaneh-Asl studies WTC steel.

Abolhassan Astaneh-Asl, P.E., a forensics expert and structural engineering professor at the University of California at Berkeley, is studying the World Trade Center disaster with the goal of improving skyscraper design. Using a grant from the National Science Foundation, Astaneh-Asl will test damaged steel from several portions of the towers and build a computer model, in conjunction with Lawrence Livermore National

Laboratory in Livermore, California, to simulate the crashes, fires, and collapses. The lab has the computing power needed to recreate the disaster digitally. By varying model parameters such as column design, construction materials, and type of fireproofing, Astaneh-Asl hopes to find ways to harden future buildings against catastrophic failure.

Last September, Astaneh-Asl was part of a team from the American Society of Civil Engineers that convinced the city of New York to delay recycling the WTC steel so that some of it could be studied for clues to the collapses. At a scrapyard in Jersey City he has helped identify the steel pieces to be saved.

The most important structural steel members to study are those severed by the planes and those that sustained the heaviest fire

damage. The severed members will be studied to determine the speed and force of impact. Fire-damaged steel will be examined under an electron microscope for changes to its crystal structure; material scientists can then determine how long fires burned and at what temperature the steel failed.

Astaneh-Asl will also study structural members relatively unaf-

ected by the crash or fires. "There were lots of different types of steel used in the towers—both high- and regular-strength—and we can learn things from pieces that fell hundreds of feet as the buildings collapsed," he explains. Tests can measure the robustness of bolts and connections, for example, and identify the types of steel adequate for various structures. Deborah Snoonian, P.E.

A New World Trade Center: Design Proposals

Co-curated by architectural record, the exhibition "A New World Trade Center: Design Proposals" will be held at the Max Protetch Gallery, 511 West 22nd Street, New York, January 16 through February 16. The exhibition will include sketches, renderings, and multimedia projects by established and emerging architects for the World Trade Center site. An opening reception will be held at the gallery 6–8 p.m., Thursday, January 17. For information, call 212/633-6999 or e-mail info@maxprotetch.com.

LEADERSHIP

YOU TRUST A LEADER

Our customers tell us, "I'm never afraid to make a commitment to my customers on the Sloan faucets I install." We understand the trust within that statement. That's why everything we do, every product Sloan Valve Company manufactures, is engineered to be the best.

Our full line of faucets, for example, delivers unmatched reliability and performance — qualities our customers count on. Sloan Valve pioneered electronics in plumbing, with products that offer superior characteristics that help owners, architects, engineers and designers achieve their professional goals — satisfying **their** customers.

But then, that's what being the leader is all about — isn't it?

For complete information on our faucets and the other products we manufacture, circle the number below or call 1-800-745-0800.



SLOAN®

Sloan Valve Company • 10500 Seymour Ave. • Franklin Park, IL 60131
800-745-0800 • 847-671-4300 • Fax 847-671-6944 • www.sloanvalve.com

CIRCLE 13 ON INQUIRY CARD

Bathroom Foster



Is it Design or is it Architecture?

In any case, it is genuine Foster. Sensational, like all his work. Once again Lord Norman Foster has pushed the boundaries, quite simply. Two adjacent circles inform the geometry of the whole range. To define the bathroom anew. Bathroom_Foster produced by Duravit. Catalog?

888 - Duravit, www.duravit.com



CIRCLE 14 ON INQUIRY CARD

Record News

SPECIAL REPORT

First downtown N.Y.C. building completed post 9/11 opens

The first building completed in Lower Manhattan since the events of September 11, the Millennium Point building, has opened this month. Located five blocks south of Ground Zero on the southern-most parcel of Battery Park City, the 39-story building includes the first new hotel to open in the area since September 11, the Ritz-Carlton Downtown, which begins operation January 29.

Designed by Gary Edward Handel + Associates in collaboration with Polshek Partnership, the \$175 million building includes the 298-room hotel on the lower 12 floors and the Residences at Ritz-Carlton, 113 condominium units, on the upper floors. The building, clad in brick with a glass curtain wall, will also house the new home of the Skyscraper Museum, an exhibition space dedicated to the history of high-rise buildings.



The Millennium Point building.

The hotel was originally scheduled to open October 9, but access to the building was hindered and construction could not be completed in the days after September 11. The building was not damaged, but the exterior had to be cleaned of excessive dust.

While the Ritz-Carlton has fantastic views of New York harbor, the recession, reduced tourism in New York City, and limited accessibility and amenities near Ground Zero will make filling hotel rooms a challenge. But Manfred Timmel, general manager of the new Ritz-Carlton, said there is still a demand for hotel rooms for business clients near Wall Street. The supply of available rooms in the area was diminished when the Marriott at the World Trade Center was destroyed and the Millennium Hilton was closed. JEC

Agency to lead rebuilding of lower Manhattan

An 11-member agency called the Lower Manhattan Redevelopment Corporation has been organized to help rebuild the area of New York City devastated on September 11, as well as revitalize all of Manhattan south of Houston Street. The corporation's responsibilities are vague, but it is likely to expend the federal aid given to New York and have the power to acquire properties for condemnation.

As a subsidiary of the Empire State Development Corporation, New York governor George Pataki has the power to appoint seven of the agency's 11 directors. Pataki named John C. Whitehead, a former chair of both the investment firm Goldman Sachs & Company and the Federal Reserve Bank of New York, as the corporation's chair on November 29. "This is a huge undertaking," Whitehead said of the rebuilding. "We want it to be done right, and we want it to be done well. How quickly it's done is not the primary concern."

Pataki's other appointments were Ed Malloy, president of the Building and Construction Trades

Council of Greater New York; Lewis M. Eisenberg, who has resigned as chair of the board of commissioners of the Port Authority of New York and New Jersey; Roland W. Betts, the lead owner of Chelsea Piers; and Madelyn G. Wils, the chair of Community Board No. 1, which includes the financial district and TriBeCa; Frank G. Zarb, the former chair of Nasdaq; and Deborah C. Wright, the chief executive of Carver Federal Savings Bank in Harlem.

Former New York City mayor Rudolph Giuliani appointed four members to the board: Richard A. Grasso, chair of the New York Stock Exchange; Robert M. Harding, a deputy mayor for economic development and finance; Howard Wilson, the chair of the School Construction Authority; and Paul A. Crotty, a public affairs executive for Verizon Communications. JEC

www For continuous updates on the aftermath of the September 11 attack, visit our special section at:

www.architecturalrecord.com

Experience the Power of One.

DesignOne. The program that combines property, casualty and professional liability insurance for design firms.

DesignOne provides seamless property, casualty, employment practices liability and professional liability coverage into one program for design professionals. One agent or broker. One application process. One business insurance program.

Contact your agent or broker or call 301-961-9885 to learn more about the power of one.

Victor O.

Schinnerer
& Company, Inc.

CNA

www.schinnerer.com

This advertisement is for illustrative purposes and is not a contract. It is intended to provide a general overview of the services and products offered. Only your policy can provide terms, coverages, amounts, conditions and exclusions. CNA is a registered service mark, domain name and trade name of CNA Financial Corporation. This program is underwritten by Continental Casualty Company, a CNA company, and is managed by Victor O. Schinnerer & Company.

CIRCLE 15 ON INQUIRY CARD

**One more reason
America's leading
construction firms
are members of
Associated Builders
and Contractors**



More than 23,000 contractors, suppliers and associated firms make up the ABC team of merit shop construction companies, dedicated to building every project on time, on budget and to the highest measure of quality.

Every year a select number of ABC members meet the exacting standards that allows them to be named Accredited Quality Contractors. AQC companies must be certified annually to retain their status, by demonstrating the highest commitment to safety, employee benefits, training and community relations.

To build with the best, look for AQC and other ABC contractors and suppliers on the Web at findcontractors.com. It's fast, easy and, best of all, free.

To join ABC and find out if you qualify as an AQC company, call toll free 877-22-MERIT, or visit www.abc.org.



BUILDING AMERICA

CIRCLE 18 ON INQUIRY CARD

Record News

Foster proposes daring add-on tower for Hearst

The marriage of early-twenty-first-century Lord Norman Foster and 1920s Joseph Urban and George Post may sound like an architectural oddity, but it has been approved by the New York City Landmarks Preservation Commission. Foster and Partners has designed a 36-story-tower addition for the Hearst Corporation building—a 1928 six-story structure on Eighth Avenue at 57th Street in Manhattan designed by Urban and Post to be the base for a much taller building.

The Hearst Corporation hired Foster based on his tall building experience and his elegant additions to the Reichstag in Berlin and the British Museum in London [MARCH 2001, page 114]. While the existing Hearst building is not a national icon like the Reichstag and the British Museum, the Foster proposal has already generated discourse among New Yorkers regarding the appropriateness of the design. This is Foster's first New York project.

The glass-and-steel Foster tower is set back from the roof edges of the existing masonry building, so the point where old meets new will not be easily seen from street level below. A stainless-steel structural system comprising nine tiers of interlocking four-story triangles will be exposed on the exterior of the Foster addition.

With this tower, Hearst could consolidate all of its publications, now in a number of Manhattan



The planned Foster addition on the Hearst building.

offices, under one roof. Yet, like many publishing companies, Hearst has had a troubled year in the slowed economy. So construction of the tower, which is still pending City Planning Commission approval, is not certain. JEC

Trump shows plans for 78-story Chicago skyscraper by SOM

While Donald Trump is no longer proposing the world's tallest building in Chicago, plans for his first Windy City skyscraper are still ambitious. Drawings of Donald Trump's first Chicago skyscraper were released in mid-December. He plans a 78-story building at 401 N. Wabash on the Chicago River, currently the location of the Chicago Sun-

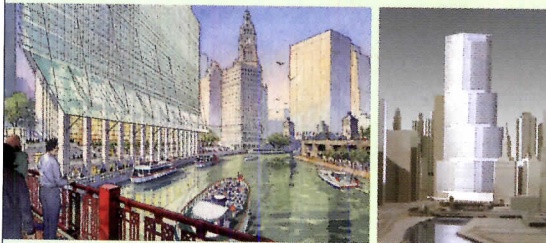

Times headquarters. Skidmore, Owings & Merrill, led by Adrian Smith, FAIA, is designing the building for Trump and Hollinger International, the publisher of the *Sun-Times*. The tower, which will rise 1,073 feet, will include 2.3 million square feet of space, including 1 to 1.6 million square feet of offices and up to 500 high-

end residential units. It will be the fourth tallest building in Chicago, after the Sears Tower, Aon Center, and John Hancock Center. A three-tiered riverfront plaza (above left) with retail will face a promenade along the Chicago River. When Trump initially announced plans last summer to develop the site [SEPTEMBER 2001, page 40], Chicagoans speculated that he was proposing the world's tallest building. The decision to scale back the proposal undoubtedly was influenced by the slowed economy and the events of September 11. Pending city approvals, plans call for construction to start in 2003. JEC

PHOTOGRAPHS: © FOSTER AND PARTNERS



Excellence in Gypsum Board Design & Construction

Call for Entries 2002

**PRAISE, GLORY
& 30 NEW FRIENDS
NAMED BENJAMIN.**

Architects, drywall contractors, and builders or general contractors in the United States and Canada are invited to submit their finest, most innovative gypsum board projects from 2002 for consideration in the Excellence in Gypsum Board Design and Construction awards program. Large or small, residential or non-residential, all innovative designs are eligible to participate.

Projects substantially completed by December 31, 2002, are eligible. One residential and one nonresidential project will be selected as winners. Top awards include \$3,000 for each winning project team. In addition, all qualified entries will be displayed on the Gypsum Association's Web site.

**The first 40
qualified entrants to
submit materials
after January 1, 2002,
will receive
\$250!**



GYPSUM ASSOCIATION CIRCLE 19 ON INQUIRY CARD

To obtain an entry form, visit us online at www.gypsum.org or call 202-289-5440.



Pillsbury Hall, one of the architectural treasures of the University of Minnesota, was completed in 1889 as a home for the teaching of basic sciences. The Romanesque building was designed by noted architects Leroy S. Buffington and Harvey Ellis.

Dates & Events

New & Upcoming Exhibitions

Architect Lebbeus Woods Exhibition, The Storm New York City

January 2–February 1, 2002

Employing the metaphor of a storm, the exhibition illustrates the destructive and transformative effects that war and rapid social change have on the built environment. The installation features a series of complex, three-dimensional tension fields composed of steel cables and dynamic massing. At The Cooper Union. For more information, contact 212/353-4158.

A New World Trade Center: Design Proposals New York City

January 16–February 16, 2002

An exhibition featuring sketches, renderings, and multimedia projects created by established and emerging architects in response to the need to rebuild on the site of the World Trade Center and embrace the future of New York. At the Max Protetch Gallery. For information, call 212/633-6999 or e-mail info@maxprotetch.com.

SFMOMA Experimental Design Award San Francisco

Through February 5, 2002

Featuring the work of this year's recipients, Thom Faulders, Donald Fortescue, and Post Tool Design, the exhibition delves into the breadth of material experimentation taking place among architects and designers in the Bay Area. At the San Francisco Museum of Modern Art. For more information, contact 415/357-4000.

Lectures, Symposia & Conferences

A2B-International Architecture Symposium 02 Basel, Switzerland

January 24–25, 2002

Entitled *mobility : immobility*, this symposium explores the somewhat paradoxical spatial existence of cybercommunications and its influence on the nature of architecture and urbanism. Hosted by Swissbau. Visit www.a-2-b.ch for more information.

Preserving the World's Great Cities: A Monumental Challenge Washington, D.C.

January 30, 2002

Former New York City landmarks commissioner, Anthony M. Tung will explore the growing conflict between preservation and contemporary building pressures. At the National Building Museum.

Contact 202/272-2448.

Business Week/Architectural Record Awards Conference New York City

February 21, 2002

The Fifth annual Business Week/Architectural Record Awards Conference and awards presentation honors buildings based on their architectural excellence and the degree to which they advance the owners' goals. Information on the winners appeared

LONWOOD NATURAL, DESERT DAWN (#460), RESILIENT SHEET FLOORING.

At the foot of inspiration.

LONSEAL
FLOORING

LEAVE AN IMPRESSION

800 832 7111 WWW.LONSEAL.COM

CIRCLE 22 ON INQUIRY CARD

Dates & Events

in the October issue of ARCHITECTURAL RECORD and the November 5 issue of Business Week. At the Rainbow Room. Contact amy_katz@mcgraw-hill.com or call the registration office at 800/371-3238.

Conventions

World of Concrete New Orleans

January 18–20, 2002

One of the largest annual construction trade shows, with more than 1,500 indoor and outdoor exhibits and more than 90 seminars concerning everything from the basics to specialized techniques in concrete design and technology. At the Morial Convention Center. For more info, visit www.worldofconcrete.com.

Restoration & Renovation 2002 Boston

March 21–23, 2002

Now in its ninth year, this conference and trade show gathers exhibitors, speakers, and experts from around the world to address contemporary issues in restoration and renovation of period buildings, interiors, and streetscapes. At the Hynes Convention Center. For more information, contact 800/982-6247 or visit www.restorationandrenovation.com.

Competitions

The NCARB Prize

Deadline: February 1, 2002

In an attempt to bring together the academy with professional practice, the National Council of Architectural Registration Boards offers a grand award of \$25,000 for a fall 2001 term project that demonstrates this integration. For an entry packet, contact 202/879-0535 or Mbourdrezn@ncarb.org.

Material Process: 2001–2002 Young Architects Forum

Deadline: February 20, 2002

The Architectural League of New York is sponsoring this competition, open to architects and designers 10 years or less out of undergraduate or graduate school. Winners receive a \$1,000 cash prize, exhibit their work, and present lectures at the League in New York City during May and June. For more information and to get an entry form, call 212/753-1722 or visit www.archleague.org.

RIBA Competition

Deadline: February 28, 2002

Invited to explore the possibilities of environmental construction, the Government Energy Efficiency Best Practice Programme sponsored by the Royal Institute of British Architects has launched its fourth open ideas competition to promote sustainable architecture. Open internationally to students and architects, first prize is £10,000. Contact 01 13 234 1335.

2002 AIA Architectural Photography Competition

Deadline: March 1, 2002

AIA St. Louis presents the competition, which is open to all architects registered in the U.S., as well as associate members of the AIA and student members of AIAS. The top 14 entries will be exhibited at the 2002 AIA National Convention in Charlotte, N.C. Subject matter must be located in the U.S. Cash prizes will be awarded. For more information, call 314/231-4252 or e-mail bookstore@aia-stlouis.org.

Bus Shelter Competition 2002

Deadline: April 19, 2002

The Bloomington Community Arts Commission, in conjunction with Bloomington Transit, invites proposals for three new public bus shelters to be installed along a major thoroughfare that will be improved as part of a city-wide transportation project in 2002. For information, contact BloomingtonArt@aol.com or call 812/336-0564.



Dorothy 2890-9 Pendant

10930 116th Ave. NE
Kirkland, WA 98033

ARCHITECTURAL
DETAILS

Phone: (425) 822-1292
Fax: (425) 822-1263

www.arch-details.com

CIRCLE 23 ON INQUIRY CARD



the ultimate cable system
Arakawa

no set screws

Arakawa Hanging Systems supplies quick-release cable grippers for hanging art, signage or shelves, stair balustrades, or suspending light fixtures.

With the Arakawa Gripper system, your displays are secure and locked in place but quickly adjustable to modify displays at will. The mechanical grip fastens to the cable, eliminating set screws and damaged cable.

Visit us today.

www.arakawagrip.com

Arakawa Hanging Systems 1.888.ARAKAWA
1020 SE Harrison Street Portland, OR 97214
phone: 503.236.0440 fax: 503.236.0427

CIRCLE 24 ON INQUIRY CARD

For and about the new generation of architects

archrecord2

FOR THE EMERGING ARCHITECT

This month's archrecord2 is all about sound and architecture. In the building at right, Sarah Wigglesworth, a London architect, insulated the occupants from the thunder of the passing Great North Eastern Railway on its way to Scotland. And in Northern California, one band member looks around his house, a 1960s Joseph Eichler creation, and he hears music. And on the Web, you'll find a special Work feature. Just be sure to whistle while you read it.

DESIGN

Sarah Wigglesworth Architects

Sarah Wigglesworth dislikes stylistic labels for architects. She doesn't think that an architect's work needs to be pigeonholed or limited to being "high-tech" or "green." The best solution to a particular building problem, in her opinion, may lie in a combination of approaches.

"What's the best kind of insulation you can get for your money?" she asks, not entirely hypothetically. "Well, straw. What's the best kind of glazing?" she asks, by way of contrast. "Well, it's got to be very high-tech glass."

This adaptability displays itself in Wigglesworth's most important project to date, 9/10 Stock Orchard Street, a combination residence and office for Wigglesworth and her partner, Jeremy Till. Indeed, Stock Orchard Street uses such energy-efficient materials as straw bales and recycled concrete, but contrasts them with slick, clean lines in other parts of the structure. All of these solutions address specific building problems, as well. For instance, a wall that faces the main rail line between London and Scotland is covered in concrete-filled bags, which dampen the sound of the trains that rush by every ten minutes.

Stock Orchard Street began as a project when Wigglesworth decided to take control of her career and expand beyond the usual small residential projects that London architecture affords.

"I'm not well-connected, and I don't know lots of millionaires, and I haven't won any competitions," Wigglesworth said. "So that's how it all started, really."

And "it" has finally started in earnest for Wigglesworth, though she had to pare her staff down considerably during work on Stock Orchard Street.

"It became so all-consuming that I had to let all my staff go in order that I could focus on the project," she said. "It was taking so long and not taking any sums in that we couldn't afford to keep the practice going. At one point we were working at the building site and living there as well."

But now, with that project more or less complete and gaining some attention in the U.K. and beyond, the investment of time and money in Stock Orchard Street



9/10 Stock Orchard Street,
London, 2001

Sarah Wigglesworth Architects. A combination of a house and the architects' offices, the building employs unorthodox materials such as concrete-filled sandbags, straw bales, and quilted cloth.

(continued from previous page) is paying off. And while the firm's direction from here on may not be entirely clear, Wigglesworth is bursting with ideas.

"One thing people say about Stock Orchard Street is that it has too many ideas in it, which I readily acknowledge," she says. "Any one of those ideas is something you could take as the basis of another project and run with."

And those projects are no longer just the typical residential renovations: She is working on a school, a project for a dance company, and a display for the Chelsea Flower Show. Again, Wigglesworth's adaptability serves her well.

"We don't really mind what sort of project we do," she says, "as long as it has an interesting brief to it." Kevin Lerner

Go to architecturalrecord.com/archrecord2 for more on Sara Wigglesworth, and to submit your own projects.



**Writer's Retreat,
London, 1999**

*Sarah Wigglesworth Architects.
Made from prefabricated
parts, this summerhouse
serves as a writer's workspace.*

LIVE

Orange Peels and Eichlers

Joseph Eichler built nearly 11,000 tract homes in Northern California between 1949 and the early 1970s that came to personify the spirit of California living at the time. The Eichler homes, mostly single-story houses with flat roofs, floor-to-ceiling glass, radiant-heated floors, and atrium gardens, were modest and modern, appealing to the parents of the Baby Boom Generation. Today, thanks to both nostalgia and skyrocketing home prices in Silicon Valley, the Eichlers appeal to a whole new generation of homeowners. That generation includes Allen Clapp, leader of the band the Orange Peels (www.theorangepeels.com).

The band's warm, 1960s-pop-influenced songs (think Beach Boys) are a perfect soundtrack for



life in an Eichler house. The Orange Peels are (photo, clockwise from top right) Allen Clapp (with glasses), Jill Pries, Larry Winther, Bob Vickers, and John Moremen.

Both in his music and his house, Clapp is living the Eichler lifestyle. "There's a simple, elegant geometry in Eichler homes, and our songs reflect that," he says. "There's an optimism, too. Eichler improved quality of life, and, as a band, we're trying to do the same thing."



Clapp grew up in an Eichler house in Foster City, California. "It formed my opinion of what a house should be, and little did I realize that not everyone grew up in a house like this," he said. "I just

always had this fascination with buildings that looked like my house."

Clapp remained interested in Eichlers, and, in 1999, he and his wife bought a 1,500-square-foot vintage 1961 Eichler (above). The Orange Peels recorded their second album, *So Far*, in Clapp's garage, and plans to record the next album in the house. JEC

To hear Orange Peels songs, visit architecturalrecord.com/archrecord2

On the Web, architecturalrecord2 presents a series of articles about how emerging architects shape their careers. The first installment, focusing on Web sites, can be found at architecturalrecord.com/archrecord2, along with our monthly forum.

LACMA makes radical conservative choice with Koolhaas

Correspondent's File

By John E. Czarnecki, Assoc. AIA

A simple, elegant design by Rem Koolhaas for the Los Angeles County Museum of Art (LACMA) may go beyond LACMA's need for additional space—it may in fact help to redefine the museum.

LACMA selected Rem Koolhaas's firm, Office for Metropolitan Architecture (OMA), on December 6 in an architectural competition for its \$200 million renovation and expansion. A selection was expected to be made in late September, but the events of September 11 delayed the decision. In November, the museum narrowed its field of finalist architects from five to two: Koolhaas and Jean Nouvel. The finalists, each of whom received \$200,000 to prepare schematic designs, included Daniel Libeskind, Steven Holl, and Thom Mayne of Morphosis. Construction will begin in 2004, at the earliest.

Radical and conservative

On one hand, Koolhaas's design is the most radical of the five finalists' because his scheme calls for the most demolition. In fact, he proposes tearing down most of the existing buildings on the LACMA campus and constructing a single, rectangular, three-level building with a translucent roof. He will fundamentally redesign the museum.

"[Koolhaas] knocks down our old buildings and on top of that he builds a twenty-first-century museum built for adaptability and changing technologies," LACMA president and director Andrea Rich told RECORD. "It physically represents optimism and faith in the future."

The new museum would be built above existing administrative and curatorial offices that will be preserved below grade. On top of this "Pompeian base," the ground-level plaza will have lobbies, special exhibition space, theaters, shops, and restaurants. Grand staircases will provide access from the parking structure, Wilshire Boulevard, and Hancock Park. LACMA's permanent collection—with departments for American, Asian, Latin American, European, Modern, and Contemporary art—would be on the top floor, arranged chronologically.

The Koolhaas design is also the most fiscally conservative of the five because about 85 percent of the budget will be put into new construction, and exhibition space could potentially be doubled under one roof. The other four schemes each required at least 50 percent of the budget to go toward existing building renovation. According to estimates by cost consultants Davis Langdon Adamson, Koolhaas's plan will cost approximately \$187 million and Nouvel's scheme, which would keep all existing buildings, would be \$230 million.

LACMA's Wilshire Boulevard campus is an amalgam of structures that began in 1965 with the original three—Ahmanson Building, Hammer Building, and Bing Theatre—by Los Angeles architect William L. Pereira. A plan by Mies van der Rohe, favored by then director Richard Fargo Brown, was rejected by museum trustees. An addition to the Ahmanson Building was built in 1983, and the Anderson Building by

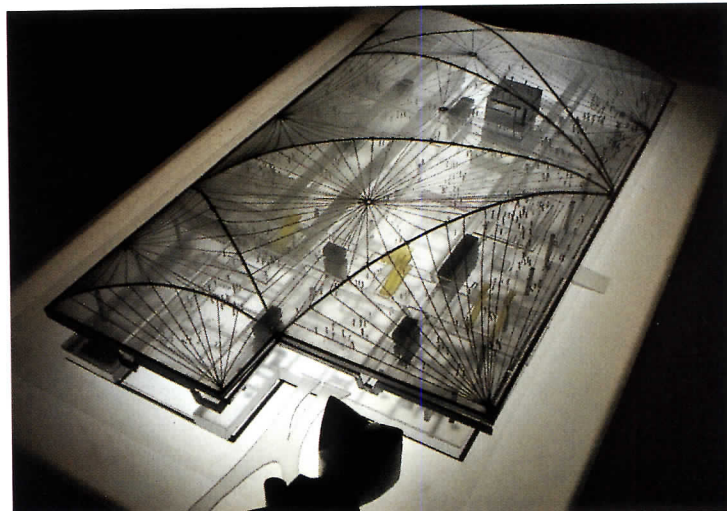

The Koolhaas design (above and right) includes most museum uses under a translucent plastic roof. Nouvel's scheme (below) proposed existing building renovation with new construction tying it together.

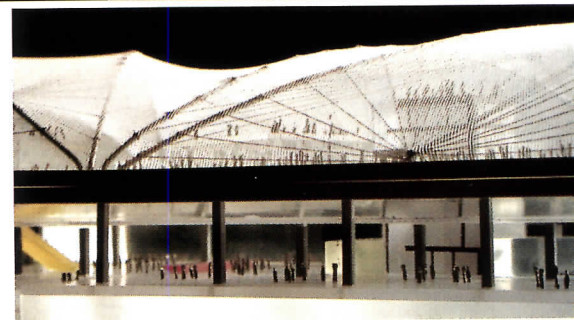

DEPARTMENTS

Correspondent's File

Hardy Holzman Pfeiffer was added in 1986. The Japanese Pavilion, designed by the late Bruce Goff with design development by Bart Prince, was completed in 1988. LACMA West opened in 1994 one block to the west in the former May department store 1940 Moderne building.

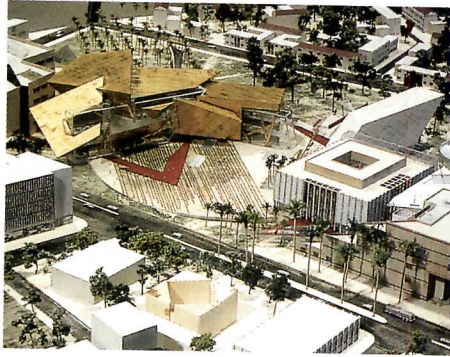

When LACMA initiated this architect-selection process, it planned to demolish the Ahmanson Building only. Koolhaas nearly wipes the slate clean with plans for demolition of all LACMA buildings except LACMA West, the Japanese Pavilion, and the parking structure. The Bing Theatre, with its walls removed, would be transformed into an open-air amphitheater.

Rather than opting for one additional building on a patchwork museum campus, LACMA is declar-

ing with the selection of the Koolhaas design that its moment to redefine itself is *now*. Selecting Koolhaas has broad implications for LACMA. "It's the singularly most important choice for the museum since it opened," Rich said. "To bring someone like Koolhaas to L.A. is a great civic contribution to the city."

Evolving L.A.

LACMA follows a number of Los Angeles museums that have had

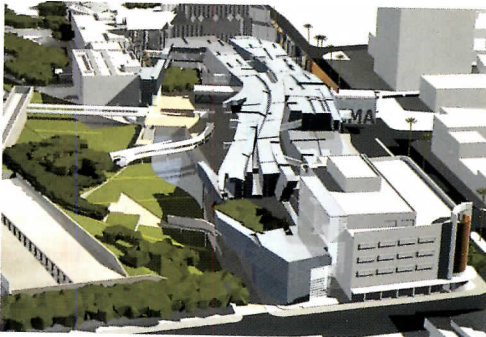
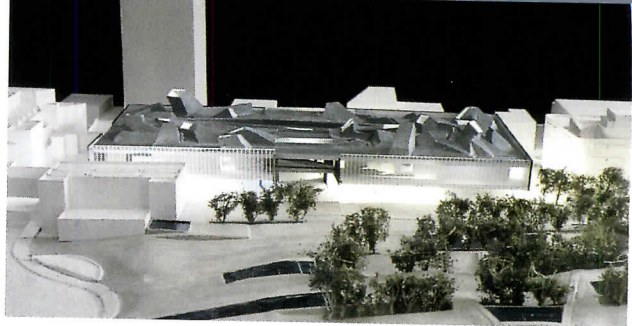

Proposals by Steven Holl Architects (top), Thom Mayne of Morphosis (left), and Daniel Libeskind (far left). The models and drawings of the five finalists' schemes are now exhibited at LACMA.

major construction projects in the past decade, including the Getty Center. Rich says Koolhaas understands Los Angeles's evolving socioeconomic diversity and how a museum must adapt to fluid demographics. "L.A. has become this incredibly mobile culture. It's one of the great diverse and dynamic cities in the world," Rich said. "This is a

moment to stop and take stock of the city and our collections."

A December 12 *Los Angeles Times* editorial declared that LACMA, together with the Getty Center, Disney Hall, and Rafael Moneo's downtown cathedral, ends the "timidity" in L.A. architecture: "Finally, the United States' second-largest city has confidence." ■



innovation - inside the box

The arrival of the Pilkington **Profilit**™ system has been dramatic with the specification, construction and completion of the system within key landmark projects. The **Profilit**™ system's dynamic use of light, created by combining alternative glass finishes with various light transmitting/insulating materials, produces the ideal glass solution for interior applications.

- Blue Cross/Blue Shield - Minneapolis, MN.
- NOVA Chemicals - Pittsburgh, PA.
- Architectural Testing Inc. - York, PA.

The **Profilit**™ system can be simply curved to create elegant glass screens, while the system's sound insulation properties provide practical benefits for its use.

Minimal framework, complete adaptability and simple design/installation processes augment the innovative features of the **Profilit**™ system.

Pilkington Profilit™

ESTABLISHED 1873
WESTCROWNS INC.

www.westcrowns.com t: 910 579 4441 e: admin@westcrowns.com

CIRCLE 29 ON INQUIRY CARD



Riff on Rem: Sorkin's take on multinational style

Critique

By Michael Sorkin

Woke up to the Sunday *Times* to find the architecture critic again unhinged by the object of his affections. This time, a gushing review of Rem Koolhaas's boutique for Prada on Broadway, which opened to the full Hollywood: klieg lights, limos, blocked streets, and paparazzi. The *Times* well-timed coverage (only 10 shopping days until Christmas) was bolstered by a sidebar hyping another overweight book from OMA, this one about Prada, a classic merchandising tie-in. (You've seen the movie, now get the action figure at Burger King.) The book includes lists of key concepts ("shops should not be identical"), pictures of handbags and of cardboard study models, larded with images of the master, photogenically craggy and dressed in clerical black.

I understand Prada to be an upmarket Tommy (Hilfiger, that is, whose hideous retro boutique recently opened on the other side of SoHo), an amplification of traditional shapes and styles, refinements. Prada's corporate culture is likewise geared to the shopping theory of creativity. Another tie-in piece in the *Times* chronicled the company's recent rapid expansion: "Over the course of its buying spree, Prada acquired controlling interest in Jil Sander, Helmut Lang, Church's shoes, Azzedine Alaïa, Carshoe and

Michael Sorkin is the director of the graduate program in urban design at the City College of New York and practices architecture. He alternates each month with Robert Campbell in writing the Critique column.

the Genny Group, along with a sizeable chunk of Fendi."

The architectural haberdashery of the shop (which occupies much of the former space, and is twinned with the remnant of, the downtown Guggenheim) similarly compiles brands within the brand—a boutique of received forms—from the Dan Graham light boxes to the Venturiesque supergraphic wallpaper to the Portmanoid glass elevator, the SITE-like objects hung from the ceiling, and the Diller + Scofidio video cams in the dressing rooms, the disco Mylar on the ceiling, the pulsing techno, the personnel dressed in security gray, whispering urgently into their mouthpieces. This conflation of shopping with invention is the *philosophy* embedded in both the shop and its massive apology. The store becomes museum and vice versa. Fabulous.

The main architectural move is sectional, a wooden wave that dips from the first floor to the basement and back, providing seating and a display surface for shoes. The wave is the Koolhaasian portmanteau metaphor and his logo for multinationalism, his site. The architect's a surfer, the cool individualist who rides but does not pretend to tame the massive hydraulics of the system. Architecture makes multinational culture look good, all the while compiling a massive documentation of its nightmarish qualities just to keep critical distance.

What we have here is the

post-Organization Man, Madison Avenue approach to architecture, spinning the creative wheels to make the sale. In a 1991 book, *What's the Big Idea? How to Win with Outrageous Ideas*, George Lois, legendary 60s adman writes, "Advertising should stun momentarily ... it should seem to be outrageous. In that swift interval

method was co-optation: The legendary ads of the period took on the rebellious, teasing style of the counterculture, snoot cocked at the same corporations whose products they were promoting. Discarding the buttoned-down look, the ad business wore flowered shirts and ponytails, smoked pot in their boardrooms.

The Koolhaasian project



Koolhaas's Prada boutique is a conflation of shopping with invention.

between the initial shock and the realization that what you are showing is not as outrageous as it seems, you capture the audience."

The 60s were a watershed for the ad business and the formative era for Koolhaas. Hip ad people broke the mold of traditional advertising, with its stodgy formats and endless mock social-scientific and statistical research, with new "creative" approaches. The working

merges both 50s and 60s Madison Avenue styles: from the 50s, the authority of "objective" statistical information, the conflation of marketing and taste, with its barse-ackwards formulas of legitimation. From the 60s, radical chic.

Advertising is the crèche of postmodernity and its professionalized ambivalences, the birthplace of the multinational style. Rem becomes Rem ©. OMA becomes

AMO. The idea of resistance, of friction, is lost in the go-with-the-flow. For the post-Andy generation, the subject matter of art can only be anxiety and ambivalence, and Prada drips with it. Rem is our dark Seinfeld, producer of our *Truman Show*.

When Rem first began his Harvard operation, he called it the "Project on What Used to Be the City" (in a massive loss of nerve, it is now rebranded the "Harvard Project on the City"). This nominalist dodge was surely intended both to signal a fascination with the "post-urban" forms of globalization and its degraded universalism, and to put some distance between himself and the more prescriptive styles of contemporary architectural debate (eyes rolled at anyone still flogging the dead horse of humane urbanity).

The reticence is a commonplace: Our legacy from utopian Modernist urbanism is postmodern urban despair—suspicion and dystopia, and a fascination with weirdness. Modernity is the Taliban, something we can all oppose. Rem's fascination with this urban *other* may spring from formative years in colonial Indonesia: The writing presents us with the Conradian gloom of the colonizer with a conscience, helpless before the horror.

In this portrait of urban hyperbole, suspicion attaches to any optimism for the future. The association of optimism and totalitarianism is foundational Koolhaas: Called the most gifted architectural polemicist since Le Corbusier, the comparison is apposite, if complicated. Koolhaas uses the epithet "optimism" to jeer at the Corbusian fantasy of power and to reveal his own deepist value: pessimism. The writing exudes it, colorfully acid descriptions of onslaught globalization and its weird generic architectures, couched in the prosody of enthusiasm. Backed by corporate organizational diagrams, charts of travel schedules, and a thousand neat hierarchies, the sellout becomes the marker of the ingenuity

of the critique: embodying the contradiction escapes it. Architecture is performance art.

The Godardian tone of the writing—flat, ironic, Johnny Halliday voice-over as he drives through the *Alphavillian* night—disclaims optimism and mocks totalitarianism. Koolhaas treats urbanization like nature, a huge sweep of forces, rules without agency, the landscape of his bitter sublime.

He describes Lagos, the Pearl River Delta, Atlanta with stylishness and insight. The prose is honed and coolly enthusiast, a deadpan Tom Wolfe. But what actually is his position on the city? He writes, "If there is to be a new urbanism, it will not be based on the twin fantasies of order and omnipotence, it will be the staging of uncertainty, it will no longer be concerned with the arrangement of more or less permanent objects but with the irrigation of territories with potential."

"Staged uncertainty" sure sounds like the 60s to me. "More or less permanent" recalls the first-dono-harm techno fantasies that yielded such product as equipotential space, support structures, mega-structures, flexible modules, user-change—the last gasp of Modernist urban science fiction and its precybernetic technical fix. A massively noncommittal space could liberate everyone: By predicting nothing, it would accommodate everything. The city would be a series of laminations that serve its shopping subjects by smoothing the flow of traffic, allowing efficient circulation between a narrowed set of architectural certainties produced by the wisdom of the market.

After working through such post-urban paradigms as bigness, sprawl, hyperdevelopment, and retail, Rem's Harvard (the Prada of universities) research project has turned its attention to the techniques of Roman city building, investigating especially its style of code making. This revision is produced by the generic city,

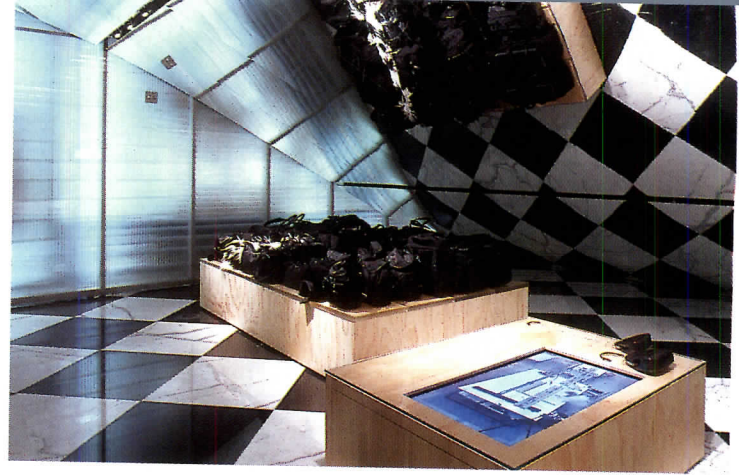

An amplification of traditional shapes and styles, the Prada store's design echoes Prada's corporate culture, geared to the shopping theory of creativity.

which must inescapably turn to type for the means of its own inhabitation. Built up of standard components, the generic requires a basic gene pool of building types that can take on a variety of recombinant forms.

For Koolhaas, historicism stands in for prescription. The Village Green, the Constructivist archive, Coney Island, Vegas, and Ancient Rome are ideal post-Modern enthusiasms: all understood at a distance. One as easily imagines Robert Venturi playing craps as Rem Koolhaas riding a roller coaster. Having fun is not the point. The professional objects of Rem's sly veneration—John Portman, John Jerde, Wallace Harrison, etc.—are all big American men representing big

The remorseless, addictive celebrity and rapier prose obscure an old-fashioned whine of alienation and a complete refusal of risk. Although he has helped open interesting territories for analysis, Koolhaas's project excludes any idea of subjectivity beyond hedonism or slavery, and any optimism for anything but the bottom line. With world-weary resignation before corporate "nature," the voluminous oversimplification, the campiness, the foggy disdain for the political, the ironic combination of criticism with celebration, all mark the larger failure to ever tell us what he really wants (so uncool).

But there must be at least one relevant urbanism somewhere between hysteria and totalization,

FOR THE POST-ANDY GENERATION, THE SUBJECT MATTER OF ART CAN ONLY BE ANXIETY AND AMBIVALENCE.

American business, druids of a practice in which innovation is largely technical and organizational.

There's a hint of shame behind this nostalgia, the taste that dare not speak its name. Koolhaas clearly adores the actuality of postwar Modernism, the repetitive blocks of the Albany Mall or downtown Stockholm, the thin curtain wall of Lever House, the '64 World's Fair. I can understand this: I grew up on Vallingby and Scandinavian Modern. It's like liking Vanilla. Ditto the thin columns, strip windows, and lifted volume of the Villa Savoie and the compulsive repetition of the Ville Radieuse. Rem's projects are darkly traditional, ironic sequels, Mies III.

perhaps in places to which we've turned a blind eye. The neo-liberal, economic version of rationality is soulless and converts our affections to commodities. The asphyxiating environment, the grossly uneven distribution of resources, the repression of the regimes—Singaporean, Chinese, Nigerian—that run these fascinating cities, the lived lives behind the defensive walls of the compounds in Lagos or in the jerry-built apartments at the edge of the Chinese town that are replacing traditional bustling neighborhoods, the sheer stupidity of the culture of consumption, are not to be desired. A useful urbanism needs to take a stand about what is. ■

Ando's work teaches us not to judge a package by its wrapping

Exhibitions

By Mildred Schmertz, FAIA

Tadao Ando: Architect. *Saint Louis Art Museum, St. Louis, Mo. (October 6–December 30); Mass MoCA, North Adams, Mass. (spring 2002). Curated by Cara McCarty, Grace L. Brumbaugh, and Richard E. Brumbaugh.*

Tadao Ando is an architect's architect, long admired by members of the profession but little known to the general public. Just awarded the AIA's 2002 Gold Medal, Ando had already earned the Pritzker Architecture Prize in 1995 and the Royal Gold Medal of the Royal Institute of British Architects in 1997. His work has appeared in major architectural exhibitions, both here and abroad, and is faithfully covered by the architectural press. But few Westerners have visited his buildings, because most of them are in remote locations in Japan. With the opening late last year of the Pulitzer Foundation for the Arts in St. Louis, however, many more people will now have the chance to experience Ando's architecture firsthand.

The Pulitzer project is the architect's first public building completed in the U.S., after a private house in Chicago [RECORD, April 1999, page 132] and a gallery at the Art Institute of Chicago [RECORD, September 1992, page 86].

In a commendable collaboration, the Saint Louis Art Museum opened an exhibition of Ando's work early last October, to complement

RECORD's former editor Mildred Schmertz is a contributing writer for Architectural Digest.

the debut of the Pulitzer building. The exhibition moves this spring to Mass MoCA in North Adams, Massachusetts.

The show presents 15 projects, including the Pulitzer building. Designed by Ando himself, it is subtle and slow to unfold. Like much of Ando's work, it doesn't give everything away at once. Cara McCarty, the museum's curator of decorative arts and design, notes that exhibitions of architecture—which usually rely on photographs, drawings, and models—can only suggest space, form, and materials. Because few people in St. Louis were familiar with Ando, McCarty saw an opportunity to educate. "We hoped to help make the Pulitzer building comprehensible to laymen by placing it in the context of Ando's body of significant work," she says. The nature of Ando's work—the way he distills his architecture into fundamental forms—helped make McCarty's intent clear. "Since we intend to teach, he is the perfect architect to focus on," she explains, "because his work is about the pure elements of architecture—site, nature, walls, uses of light."

More U.S. work to come

In addition to the Pulitzer building, the exhibition shows two yet-to-be-completed projects in the United States: the Modern Art Museum in Fort Worth, Texas (which is adjacent to Louis Kahn's Kimball Art Museum and will open later this year), and the competition-winning design for an Alexander Calder museum in Philadelphia. It also includes the

Fabrica complex, a project for Benetton outside of Venice, which combines a renovated seventeenth-century Palladian villa and a mostly underground new structure [RECORD, January 2001, page 80]. And for those who remember Ando's beautiful little Japanese churches of the late 80s, all three are included: the Chapel on Mt. Rokko; the Church on the Water on the island of Hokkaido; and the Church of the Light in Osaka. Two early houses are shown, the Azuma House (1976) and the Koshino House (1984), as well as Time's Shopping Center in Tokyo (1984).

The decision to exhibit eight museums in a total of 15 projects provides the intended context for the new Pulitzer building. But had the show been bigger, it might have included more of Ando's many spare, unadorned, but geometrically ingenious concrete houses, as well as his two splendid exhibition buildings: the Main Pavilion for the Tennoji Fair in Osaka (1987) and the Japan Pavilion at Expo '92 in Seville, for which he explored new themes. That said, all the selected projects were displayed simply, without crowding, in the old-fashioned way—photographs, drawings, and models—no videos, films, or sound. Visitors first see a dramatically charged installation piece, set in a

generous space just beyond the entry. It consists of a softly lit wall suspended above a void spanning a pebble-filled pool. It was designed by Ando to symbolize the fundamentals of his architecture: light, wall, texture, reflection.

Visitors to the Pulitzer Foundation for the Arts who have

The uninflected exterior of the Pulitzer Foundation for the Arts (bottom) offers no clue of features inside—like a water court (below).

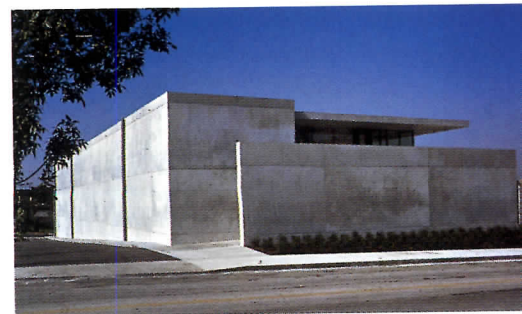

Exhibitions

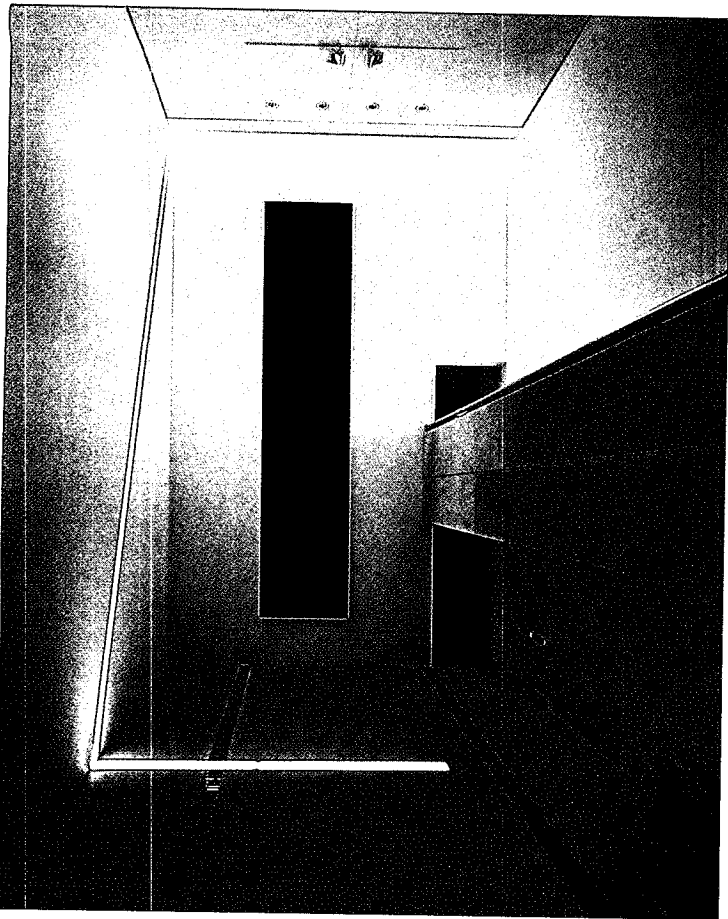

Ellsworth Kelly's *Blue Black* hangs in the Pulitzer Foundation's main gallery.

already seen the museum exhibition may have learned that the genuine power of Ando's architecture is experienced inside, rather than outside his buildings. The exterior facades of the foundation building, deemed "bunkerlike" by many, consist of bare concrete walls that offer no clue as to what may be going on within. This cool demeanor reveals the truth about the building's function—that it is more private than public. (Visiting hours are on Wednesdays and Saturdays only, reservations are required, and a maximum of 50 people are allowed in at one time). This restriction on public access by a nonprofit institution receiving tax benefits has angered some alert citizens. The foundation, established by art historian and collector Emily Rauh Pulitzer, the widow of publishing magnate Joseph Pulitzer, Jr., exhibits art on loan from the

immense and distinguished private collection of the Pulitzers and is primarily a study center for students of art and architecture.

Playing a Japanese game

Ando's building houses the foundation's art galleries, offices, and research facilities. The site—in the neglected Grand Center district of St. Louis—is flat, and the building fills it, with no room for landscape. The uninflected entrance facade (try to find the door) abuts the sidewalk, and the parking lot pulls up directly to the facade around the corner from the entrance. An empty lot next door adds to the forlorn look of the area, but it will be the home in 2003 of the Forum of Contemporary Art designed by Brad Cloepfil of Allied Works Architecture in Portland, Oregon. The Pulitzer building, understated and underplayed from

without, represents Ando at the height of his game, and a very Japanese game it is.

Anyone who visits famous temples, gardens, or houses in Japan finds that some of them don't look like much from the street. Once inside, though, one discovers the multileveled, ingeniously structured enclosures, the beautifully proportioned open space, the carefully created vistas of water and sky, and the objects of art well placed in their surroundings. It is an experience all the more powerful because it comes as an unforgettable surprise. And just such a surprise is Ando's gift to St. Louis.

The foundation building consists of two narrow, parallel, rectangular boxes, equal in width but different in height. A reflecting pool (called the water court) runs between the two structures and shares the same width as each of them. The building is bordered by the street, the parking lot, an exterior court to be shared by the Forum of Contemporary Art next door, and an undeveloped site at the rear. On the main floor, the lower box contains an entrance gallery and executive office space that overlooks a roof garden and the lower court. Another gallery overlooks the water court, and the main gallery occupies the higher wing.

The lower floor is primarily office and storage space, with two small galleries reached by a splendidly proportioned ceremonial stair descending from the main gallery.

For the opening, Emily Pulitzer chose works limited in number, but select in quality. Monet, Maillol, Picasso, Braque, and Giacometti are among the masters represented, and the show includes contemporary works by Warhol, Lichtenstein, Rothko, and others. The water court has a single inhabitant—*Torso*, a bronze created in 1957 by Jean Arp. On the far end wall of the main gallery, at

the foot of the ceremonial stair, hangs *Blue Black*, a painting on a pair of joined honeycomb aluminum panels, which Ellsworth Kelly created specifically for the space. Outdoors, a series of stairs and ramps punctuated by terraces descends to the paved court, dominated by Richard Serra's weathering steel sculpture *Joe*. Named by the artist in honor of the late Joseph Pulitzer, Jr., the work is the first of Serra's torqued spiral series.

Staying true to old themes

Kelly and Serra, both of whom had visited Ando's work in Japan, influenced Pulitzer in her selection of the architect. Her goal was to have an architectural masterpiece built, and she has succeeded brilliantly. A bunker perhaps, but Ando is nevertheless at his best here. His client apparently did not invite him to explore new themes, or if she did, he didn't oblige. Instead, he has remained true to the lifetime disciplines of work—pure geometry, light, sky, and nature made abstract. Does his design relate to the context of Grand Center in St. Louis? Of course not, because there is no there there. The Pulitzer Foundation building is the first to provide context, and one may hope that the builders who follow pay attention. ■

The Church of the Light outside of Osaka is one of Ando's little churches from the 1980s.

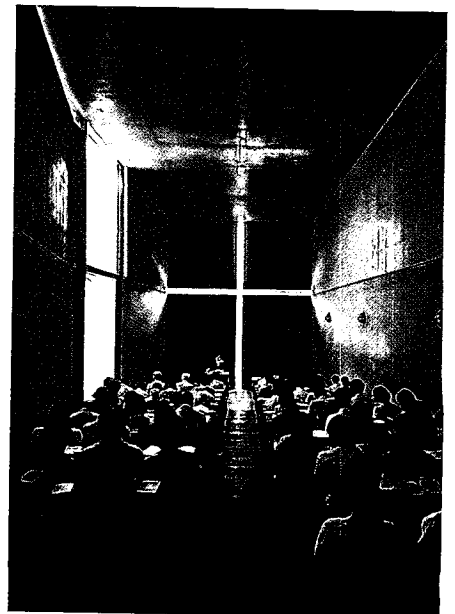

Snapshot



By James S. Russell, AIA

Only rarely do architects play any role in highway-bridge design in America, and the IJburg Bridge, at the edge of Amsterdam, shows what we're missing. The city of Amsterdam could have done what most American cities would do—pull the standard girders and deck out of the civil-engineering bridge-building manual. After all, the 792-foot-span wouldn't tax engineering design or modern construction techniques. But Amsterdam saw the bridge as more than a vehicular conduit (indeed, the deck is divided into separate carriageways for autos, trams, bicycles, and pedestrians). Amsterdam asked architect Nicholas Grimshaw & Partners to design a symbolic gateway to the vast new urban development it is building on eight new man-made islands in the IJmeer, the vast inland lake created by Dutch engineering from what was once an inlet to the sea. (The architect worked with WS Atkins and IBA, the engineering office of the City of Amsterdam.) Although tiny by this nation's historic reclamation standards, the new islands add up to 1,100 acres and may house as many as 45,000 people at buildout, perhaps 10 or 15 years from now. Sales offices have been

Lacy struts that promise a new city's greatness



Snapshot



located to offer enticing views of the bridge, and not just because of the appealing undulations of its steel box-girder arches. With most preconstruction infrastructure still being installed, the bridge is for now the only structure that rises above the vast sandy plains covered with construction equipment. Perhaps someone did a cost analysis that said if we spend X guilders more to build a nice bridge rather than Y guilders to drop in a standard eyesore bridge, it will pay back in a Z-guilder sales premium. I doubt such an analysis was undertaken. The city actually understood that the bridge helps this brand-new place develop a memorable identity; it puts something attractive in peoples' views rather than something they would prefer to screen out. Of course it couldn't have happened if the designers had not come up with this rather suave bit of expressive engineering. They did not tack on some architecture; they elegantly reinterpreted the standard ingredients of the arch bridge. The arches slope nicely inward; the tubular braces interleave intriguingly. The concrete abutments have been subtly carved. That little droop between the arches is a winning touch, as is the small space left between the carriageways so that users are aware they're on a bridge, not an airport runway. Each nicety cost something, but each will pay back handsomely for a very long time. ■

The center arch rises in the gap between the carriageway decks, acting as a kind of backbone to the inward-tilted outer arches. Arches and deck segments were prefabricated and craned into place.



Apartments and condos aren't buildings.
They're homes that just happen to be
really, really close together.

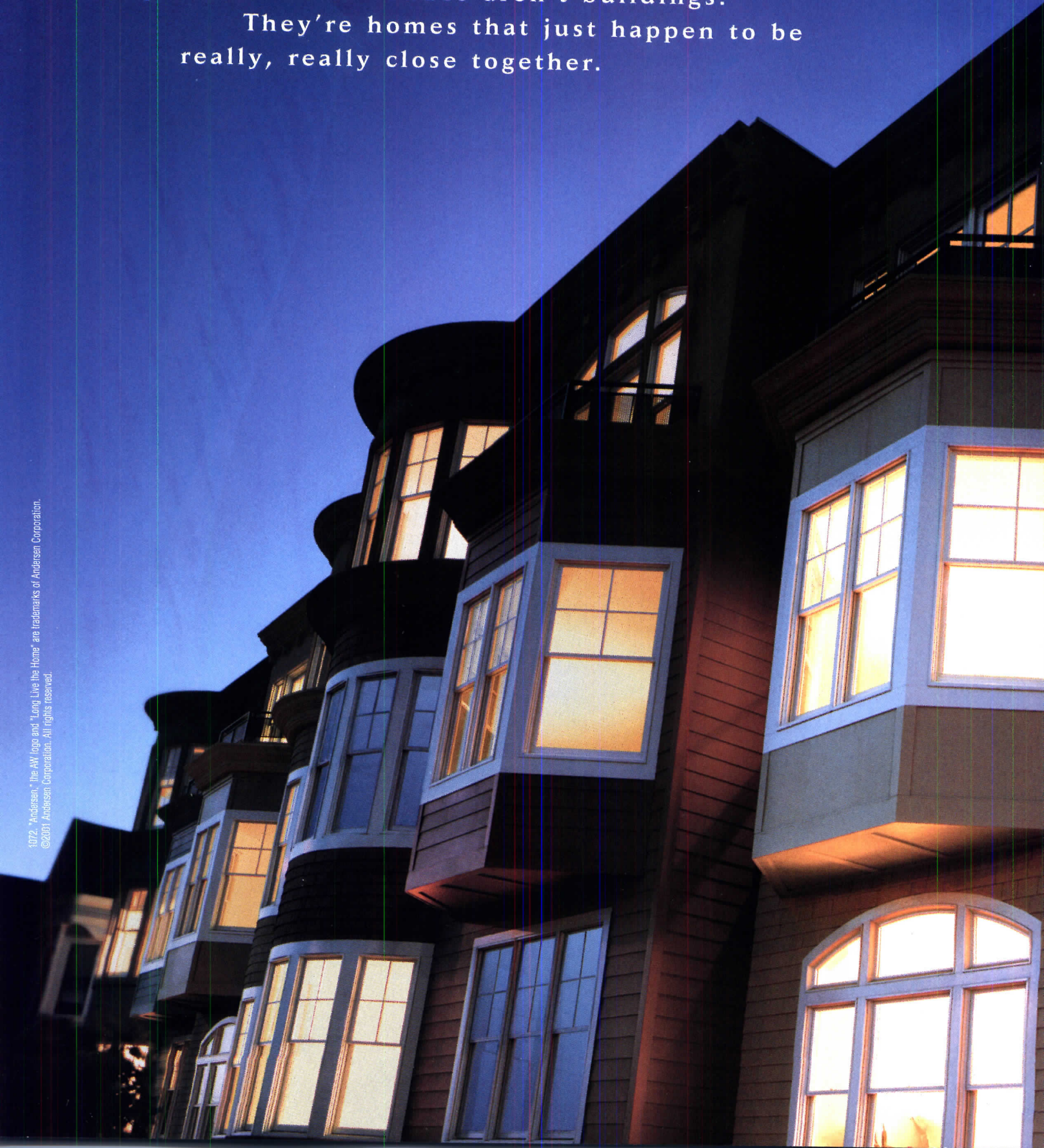

*Laurel Heights Condominiums
Sternberg Benjamin Architects Inc., San Francisco, CA*

For projects requiring the warmth, character or true feeling of home, nothing performs like Andersen® windows. The fine detailing of our real wood interiors adds richness and a classic look to any application. With over 200,000 size, shape and style combinations, you have the choices and options you need to bring your visions to life. Plus, we have all of the project support and services to see any job through to completion. For information on the Andersen portfolio of 400 Series and 200 Series products, call 1-800-426-4261, ref. #3991.

Or visit andersenwindows.com.

LONG LIVE THE HOME™



CIRCLE 36 ON INQUIRY CARD

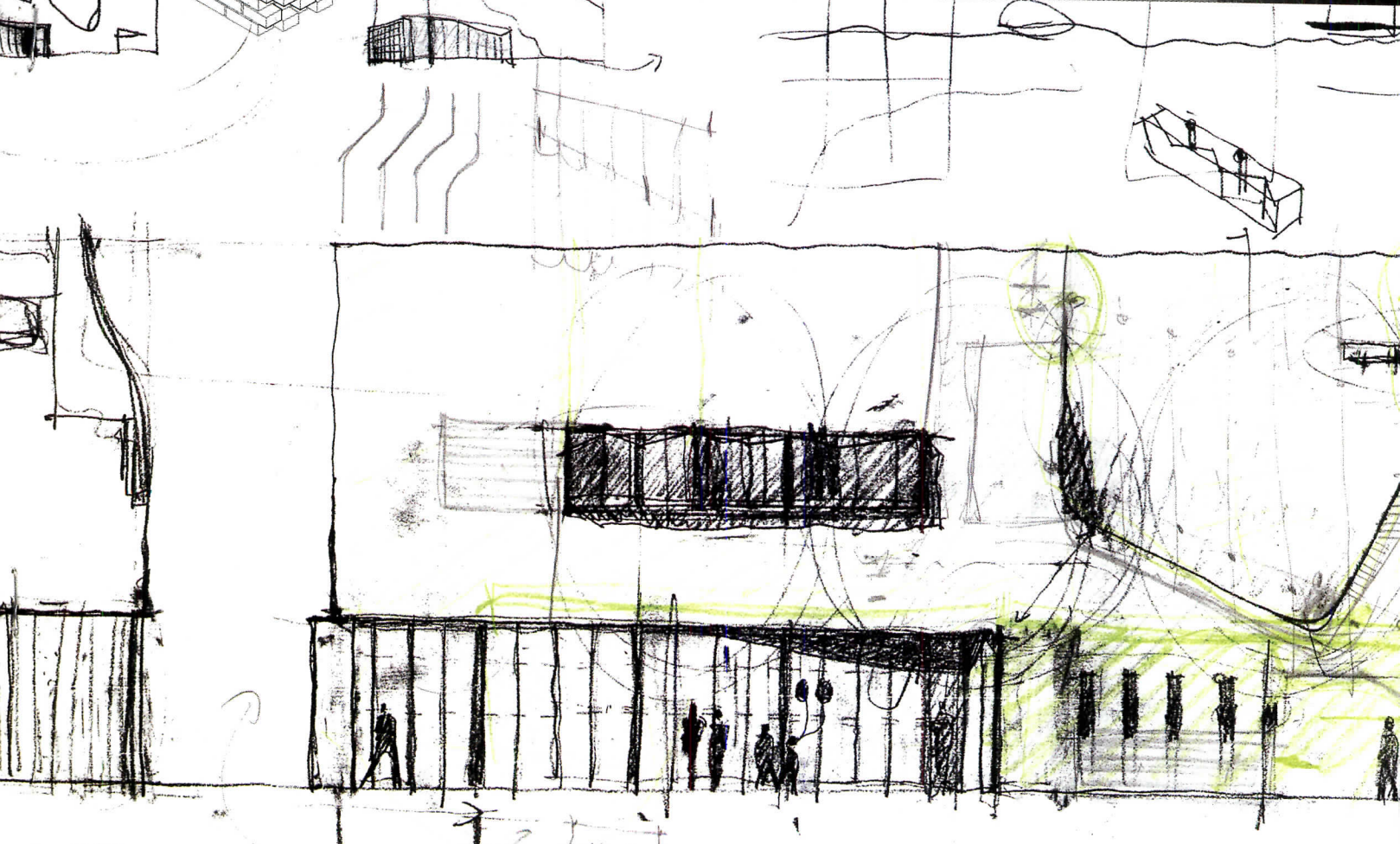
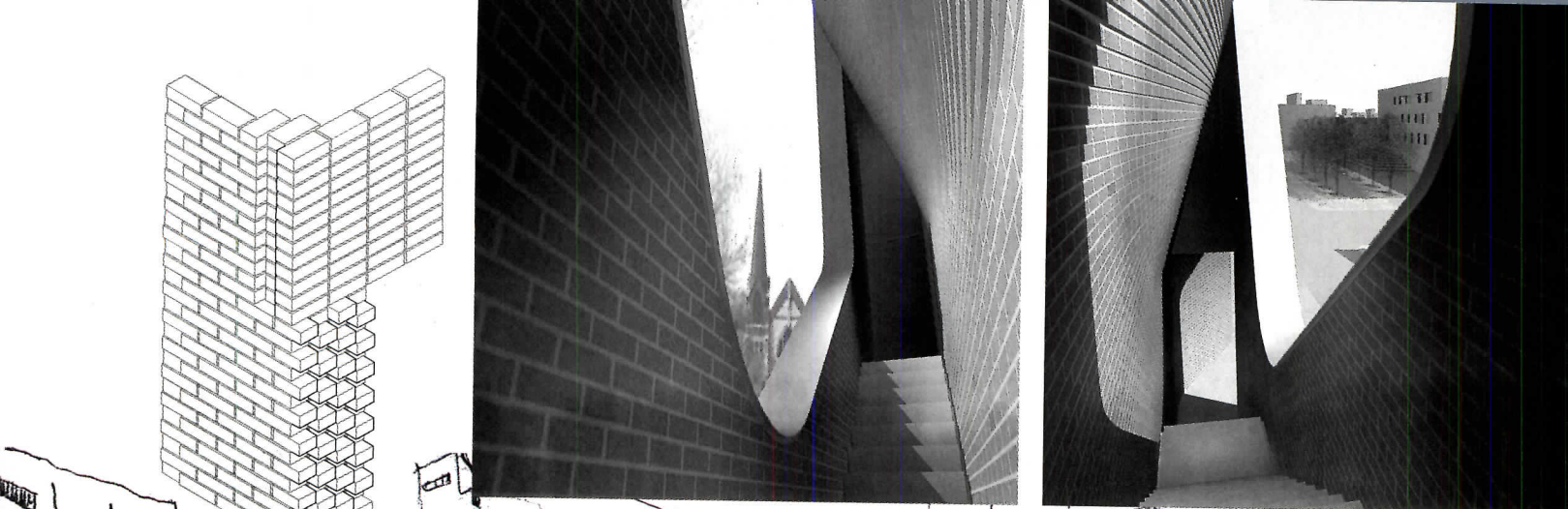

FIRST FLOOR PLAN

BASIC DIM

- LONG
- SHORT SKYLIGHT

In Office dA's project for the Witte Art Center (above), a hybrid perspective (top) is created by the computer to show the intersection of three planes. The scratchlike section fragments and notations are done to examine the wrapping of the surface around the stair.

Fx

Drawing: The Creative Link

Architectural schools shouldn't jettison courses in drawing, as an analysis of the work of several innovative architects shows

By Sophia A. Gruzdys

Has the incorporation of digital technology into the creative process redefined the way architecture is taught? Five years ago the future of architectural education seemed clear. The “paperless studio” was the way to go. To be sure, schools continue to devote space exclusively to this course of study, but today students and professors are beginning to reassess the advantages of drawing and thinking by hand.

In the age of form•Z and Maya computer programs, the awareness that hand drawing helps architects to think and to create is being revived. The most innovative architects, those who do work through digital processes, still rely on hand-drawn representation. Because the computer does not discriminate the information it receives, there is an even greater need for hand drawings and diagrams to sort out ideas.

The computer is tempting: It bypasses the old techniques of drawing—two-dimensional orthographic projections of plan, section, and elevation—to allow the architect to work directly on three-dimensional models. By linking the architect's initial ideas as sketched in the computer to programs like Rhino and then to actual architectural form through CAD/CAM software, digital technology promotes speed, precision, and instantaneous results that are seductively economic and efficient. For this reason, the computer process has been called by Dana Cuff and others “the smart link” [RECORD, September 2001, p. 200].

However, in practice, the act of drawing with pen and pencil has the obvious advantage of bringing the hand, eye, and brain of the architect together to promote, at the very least, a keener sense of proportion and scale. And, as the late Robin Evans pointed out, “For any material object to obtain freedom, its handler has to lose control of it.” He is talking about creativity with a capital C. The process of searching, grappling, and pushing the boundaries of any medium is important to the creative process because it separates ideas caught in conventions from ideas that have been set free. One can lose control in both drawing and digital design, but with drawing, the subject becomes intimately familiar as an unmediated extension of oneself. Drawing is not just representation; it helps the architect to think ideas through, allowing their independence from the tools that mold them.

Drawing is essential in the teaching of architectural design because it brings the student into the entire design process from the beginning, not just at the end stage. The computer's speed allows students to explore alternatives quickly, but drawing encourages students to develop patience in

Sophia Gruzdys is an architect who practices in New York and teaches drawing and design at Yale University.

Around 1300, Giotto developed a proto-perspective to render space in paintings such as *The Crib at Greccio* in San Francesco, Assisi.

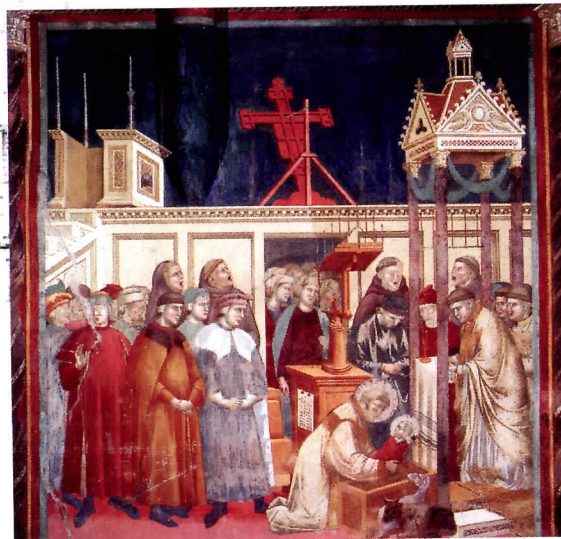
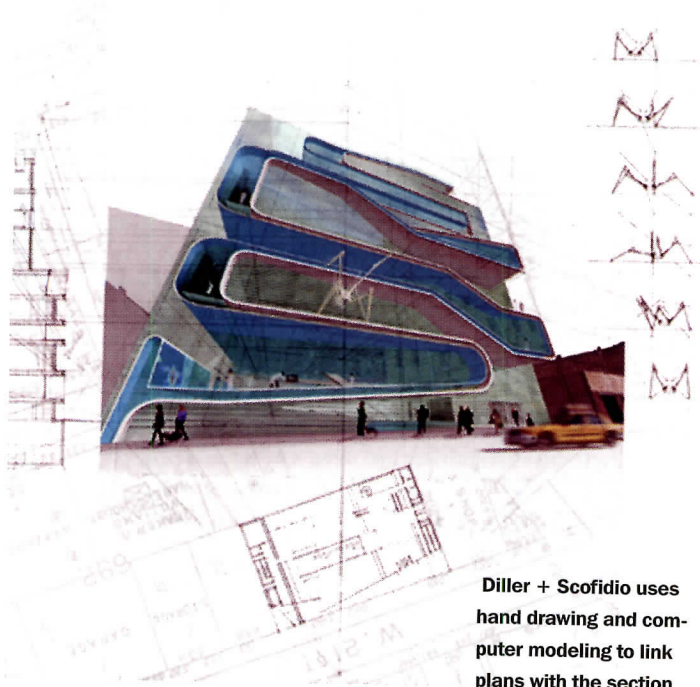
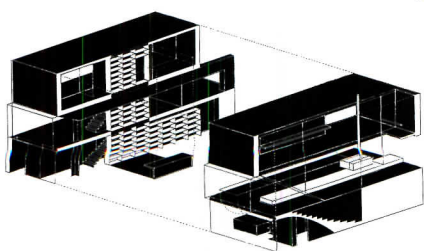
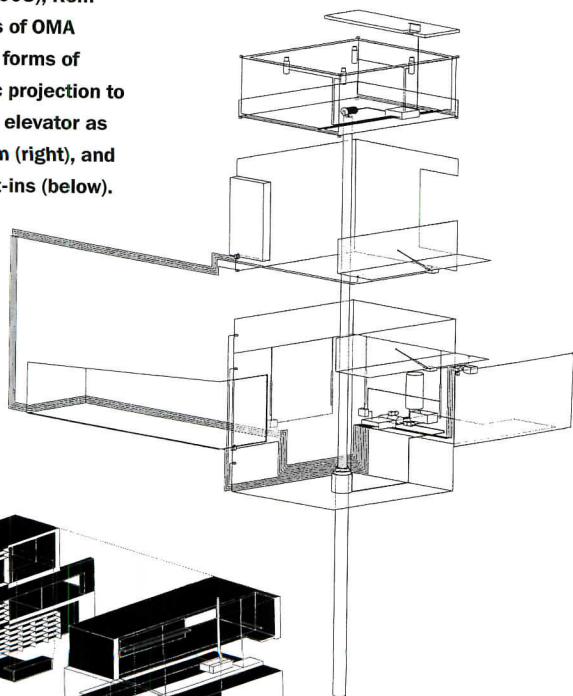

IMAGE © CORBIS



Diller + Scofidio uses hand drawing and computer modeling to link plans with the section in its competition design for the Eyebeam Atelier, in New York City.

For the Bordeaux House (1998), Rem Koolhaas of OMA relied on forms of isometric projection to show the elevator as a diagram (right), and with built-ins (below).



Steven Holl sticks to drawing and watercolor to develop a diagrammatic section for the Knut Hamsun Museum in Norway (right).

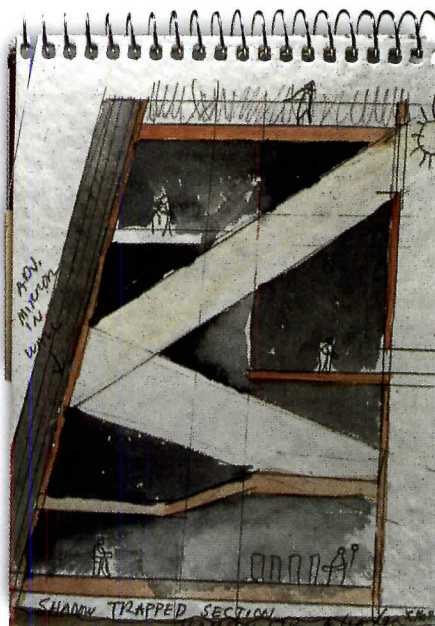

Frank Gehry's sketch (below) for the New York Times tower competition (2000) shows a freedom in uncertainty.

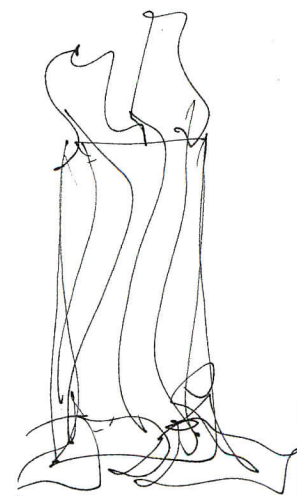

creative work. At Columbia University's Graduate School of Architecture, Planning and Preservation, students are taught drawing in order to understand and follow more closely the functions of the computer. At Yale's School of Architecture, analytical freehand drawing is taught to explicate and analyze architectural form; while at Harvard's Design School, both perceptual freehand drawing and rigorous, hard lined, hard-core descriptive geometry are equally important.

A number of inventive architects today rely on drawing by hand, even when they are known for their use of sophisticated computer technology. Frank Gehry moves from the sketch at the beginning of the process to the CATIA software at the end. Gehry is not alone. Other architects employ all sorts of drawing types, including perspective, orthographic, and parallel drawing projections, to promote a further understanding of their work through the tools of geometry.

For Office dA in Boston, the perspective serves as a tool of perception, while performing a syntactic function to position three planes—plan, section, and elevation—in relation to one another. In its Witte Arts Center project in Greenbay, Wisconsin, principals Monica Ponce de Leon and Nader Tehrani designed a promenade that threads in and out of three facades, one of which contains a stair that slips through the building. Here the brick facade literally wraps the stair in this scheme where the material is being pushed to its geometric limits. This interest in material is also seen in Mies van der Rohe's famous drawings of the Brick Country House (1923), where the turning of the corner and the jointing of the brick are investigated, using perspective as an analytical tool. CAD/CAM has added an entirely new dimension to fabrication technology, but the fascination with geometry and its underlying armature precedes the exploration in the computer. There is not a single, unique logic to the development in Office dA's work. All these tools serve to "thicken the plot," says Tehrani.

Quite different from Office dA's drawings are those of Steven Holl. More than most highly published architects today, Holl seems to rely on drawing by hand to create and represent his ideas. One can surmise that he really isn't interested in the computer to promote the sensory characteristics of his work. Like Le Corbusier, Holl develops the kinesthetic aspect of the architectural promenade in his design, using drawing to work out the diagram and sketch the experiential quality of moving through a building. In this regard, Holl's success with built work may be traced to his devotion to drawing as the embodiment of an authentic thought, analogous to our interest in

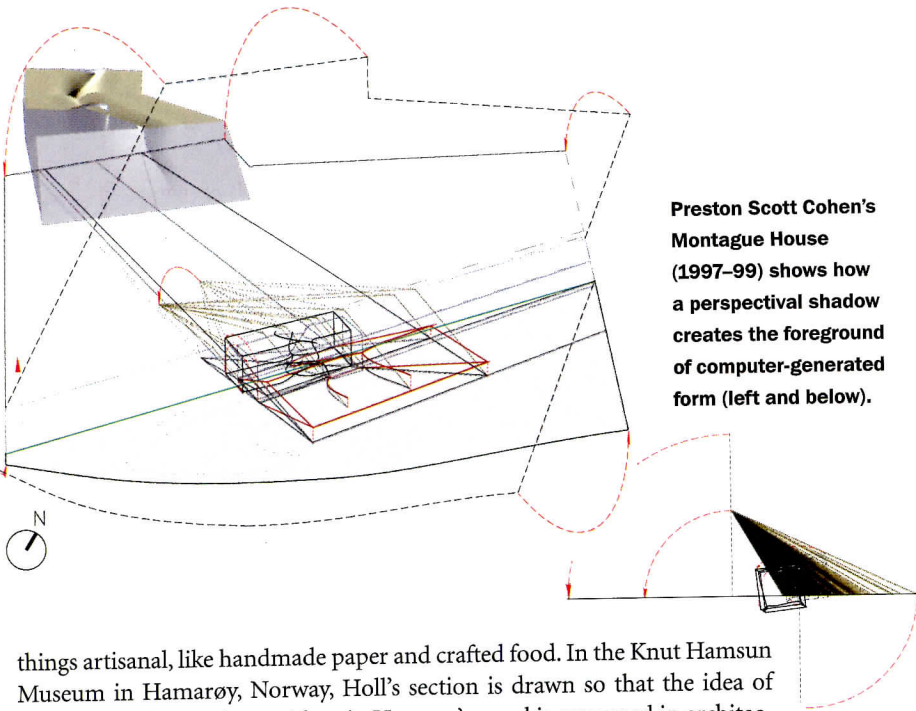

Preston Scott Cohen's Montague House (1997-99) shows how a perspectival shadow creates the foreground of computer-generated form (left and below).

things artisanal, like handmade paper and crafted food. In the Knut Hamsun Museum in Hamarøy, Norway, Holl's section is drawn so that the idea of episodic, nonlinear time evident in Hamsun's novel is expressed in architecture as a play of light.

The architectural firm of Diller + Scofidio enlists projective drawing techniques to clarify its own ideas about form and experience. As Liz Diller explains, the projects become a back-and-forth between hand drawing, computer modeling, and the construction of physical models. The drawing strategy of linking a plan, for example, to a section, which might have been extracted from a perspective, helps sort out the architectural decisions of the building. Here the computer is not a generative device, but a tool to create a simulacrum of the real and extend an idea that has been "thought through" by hand. As seen in their competition design for the Eyebeam Atelier, a gallery in New York City, the drawing strategy specifies details and decisions along the promenade.

For his part, Rem Koolhaas has kept the isometric alive. Different from an axonometric projection, the isometric construction expresses a point of view in relation to the subject. Peter Eisenman used it in the late 1960s as an extension of his interest in formal and compositional ambiguities. Koolhaas's isometric for the elevator of his Bordeaux House (1998) demonstrates the economy of means by which he uses drawings to express his ideas. Because the elevator was designed so that the handicapped owner could reach all parts of the house, it is fitting that the isometric, whose point of view is not neutral, represents this most significant aspect of the architectural concept.

Clearly, both drawings by hand and mouse must be taught in our architecture schools, not as antithetical representations, but as integrated elements of a creative process. For example, Preston Scott Cohen's drawn knowledge of seventeenth- and eighteenth-century parallel and perspective projective techniques enables him to break new ground in inventing form with the computer. In the Montague House (1997-99), the terminal line, derived from the specifics of the site, shapes the primary body of the house, while the perspective projection onto the site creates the protective garden foreground. Here, his decision to search just beyond the limits of this drawing system helped him lose control in order to find form. This process requires patience, a patience that allows one to take the time to "craft" an architectural solution. Ultimately, our minds synthesize the respective value of both drawn and digital thought to determine how architecture is to be imagined, conceived, and made. ■

For more information about architectural education, including a comprehensive chart with demographic information about NAAB accredited architecture programs in the U.S. go to www.architecturalrecord.com.

Going Out On a Line: A brief Q&A about historic moments in drawing

1. Who used perspective first? In the first century B.C., Vitruvius, in Book I, described perspective as a "shaded image of the front and the retreating sides, and the correspondence of all lines to the center of a circle." Around 1300, Giotto used what you might call proto-perspective in the projection of spaces to give a sense of the third dimension in paintings like *The Crib at Greccio*, in San Francesco, Assisi. Alberti, in his *Della Pittura* of 1435, spelled out the mechanics of perspective as demonstrated by Brunelleschi's optical experiments with the Baptistery in Florence of 1420.

2. Who was the first architect to use the plan, section, and elevation? Plans, sections, and elevations (orthographic projections) were first employed by Raphael in the design of Villa Madama (1517-21) in Rome, for Pope Clement VII. The full potential of orthographic projection was realized by Gaspard Monge, a French military engineer, who, in his *Géométrie Descriptive* of 1799, positioned parallel projections of the object on planes perpendicular to one another.

3. When were axonometric drawings developed? Proto-axonometric drawings appeared in depictions of military fortifications, as in Jacques Perret's 1601 treatise *Des Fortifications*. Then, in 1873, axonometric (parallel) projection was developed by the French engineer Auguste Choisy. Although axonometric drawing had its origins in perspective, the increased distance between the viewer and the object renders the form more universal and abstract. The technique was seized upon by avant-garde types such as El Lissitzky, Theo van Doesburg, and Le Corbusier.

4. What about isometric drawings? In 1820, the isometric form of parallel projection was systematized by a British engineer and mathematician, Sir William Farish, in an attempt to make the complex drawings of industrial machinery more readable. This type of drawing, in which the three faces are positioned at obtuse and acute angles to one another, allow a spatial reading of the structure, where planes and their edge lengths can be measured precisely. In the 1930s, the isometric became quite popular when Boeing used it to explain orthographic projects to untrained workers. S.G.

Jacques Perret's *Des Fortifications* (1601).

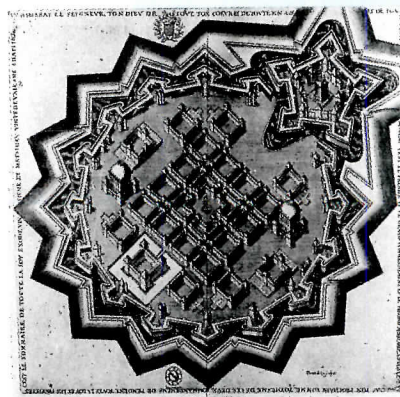

For more history, see Alberto Perez-Gomez and Louise Pelletier's *Architectural Representation and the Perspective Hinge* (1997) and Martin Kemp's *The Science of Art* (1992).

Create



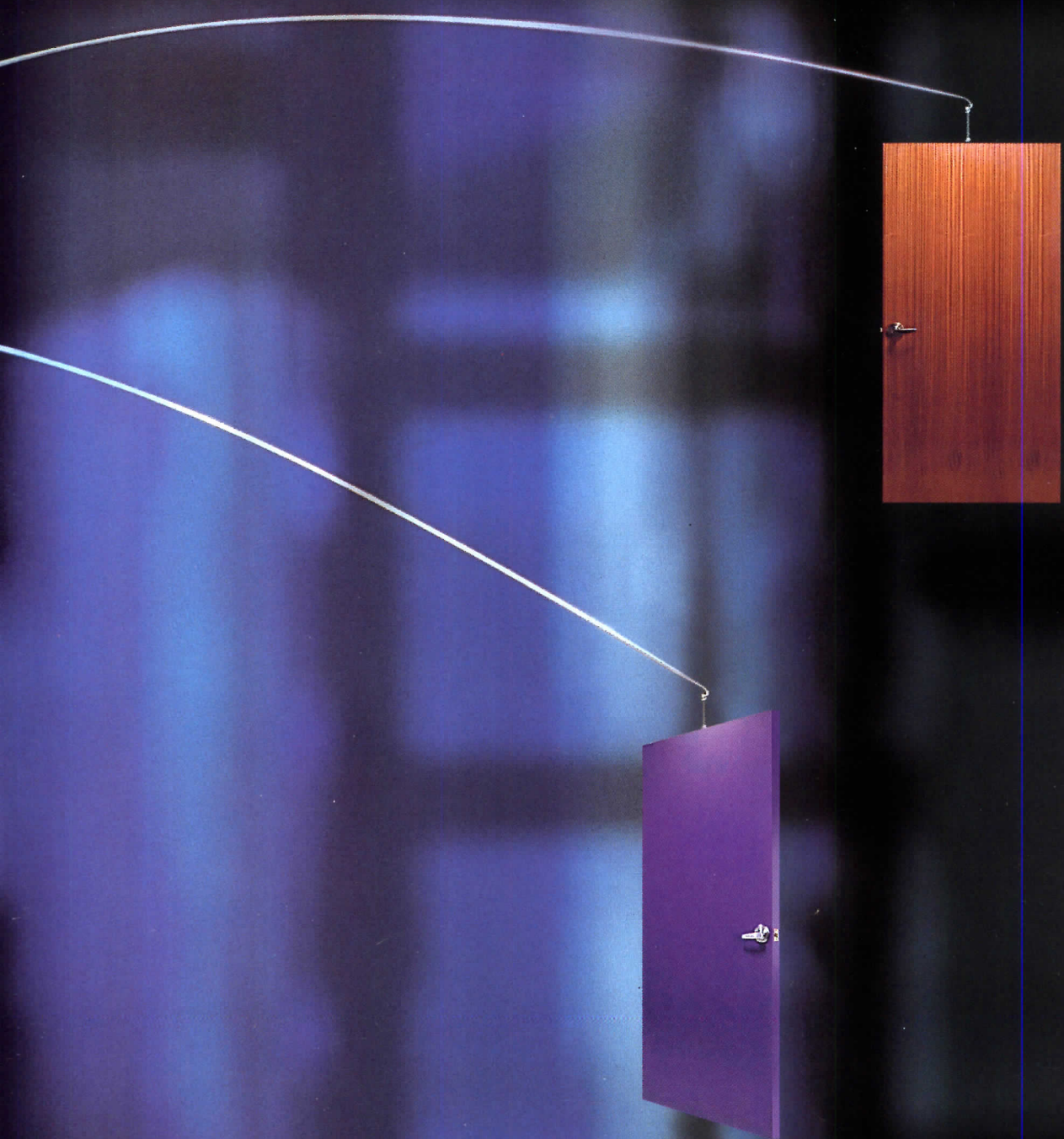

Visualize. Innovate with exquisite, rich veneers. Indulge a flight of fancy with colorful and dazzling laminates. Doors crafted with edge-before-face construction and a factory finish that's as durable as it is beautiful. With VT, the design possibilities are as great as your imagination.

Call 1-800-827-1615 ext. 210 or visit www.vtindustries.com/doors

CIRCLE 37 ON INQUIRY CARD

VT Architectural
INDUSTRIES Wood Doors



The Space Needle was a symbol of high tech – in 1962. Today, this classic landmark gets a 21st century makeover with an all-new Pavilion featuring some seriously high-tech glass: Solarban® 60 Solar Control Low-E Glass from PPG. Resembling a transparent nautilus encircling the base of the Space Needle, the Pavilion

is a two-story glass structure that replaces the former retail, ticketing and lobby facilities. Transparency was key. So the architect chose PPG Solarban 60 glass because it is specifically engineered to control solar heat gain and minimize cooling costs, yet does it with a clear, uncoated look. Solarban 60 glass doesn't make outstanding design suffer for efficiency. In fact, a standard one-inch insulating glass unit of Solarban 60/clear glass blocks approximately 60% of the

LOOKS ARE STILL EVERYTHING.

Call now for details on new Solarban® 80 glass: 1-800-377-5267

SEATTLE SPACE NEEDLE: Seattle, Washington | ARCHITECT: Callison Architecture, Inc. | OWNER/DEVELOPER: Space Needle Corporation
PRODUCT: Solarban® 60 Glass | GLASS FABRICATOR: Northwestern Industries, Inc. | GLAZING CONTRACTOR: All New Glass, and Evergreen House, Inc.



Photography: copyright © Callison Architecture/Chris Eden
Solarban, the PPG logo and the "See It's PPG" logo are trademarks of PPG Industries, Inc.

CIRCLE 38 ON INQUIRY CARD



total solar energy providing comfort and energy savings in the summertime. And Solarban 60 glass delivers a U-Value of 0.29, a figure that keeps visitors warmer in cold weather.

Solarban 60 glass is available through PPG Certified Fabricators. So whether you're planning a classic retrofit or a breakthrough new construction project, call the PPG Solutions Hotline today to locate your nearest PPG Certified Fabricator at 800-377-5267. Or visit our website today.



Glass Technology
Since 1883

www.ppgglass.com

Design Intelligence and the New Economy

It may look as if the landscape changed after 9/11, but features of the new economy are alive and shaping architectural practice

By Michael Speaks

The past year brought numerous and seemingly definitive condemnations of the new economy and the heady future it promised to all who understood it and lived by its rules. Then came September 11, dealing what remained of the optimism about the new economy a decisive blow from which it may never recover.

Yet its fundamental features, as enumerated by Kevin Kelly in his influential *New Rules for the New Economy* (1998), were not altered by the catastrophic events of September. According to Kelly, "This new economy has three distinguishing characteristics: It is global. It favors intangible things—ideas, information, and relationships. And it is intensely inter-

Michael Speaks, a RECORD contributing editor, wrote "How the new Economy is Transforming Theory and Practice" in December, 2000. He is the director of the Metropolitan Research and Design Postgraduate Degree program at the Southern California Institute of Architecture in Los Angeles and has a Ph.D. in literature from Duke University.

linked. These three attributes produce a new type of marketplace and society, one that is rooted in ubiquitous electronic networks."

The relevance of all this for architecture may not be obvious, but it should be. During the 1990s, architecture underwent fundamental changes, many of which followed the contours of the new economy and the technological, political, and organizational transformations it prompted. One of the most significant changes was the rise of what Amsterdam-based architects Ben van Berkel and Caroline Bos call the "network studio." On the occasion of the reorganization of their own office under the moniker UN Studio (United Network Studio), Van Berkel and Bos published *MOVE* (1999), a three-volume monograph in which they announced the emergence of a new kind of virtual architecture studio, which, they wrote, "extends existing forms of cooperation with clients, investors, users, and technical consultants to include design engineers, finance people, management gurus, process specialists, designers, and stylists." The successful completion of unimaginably complex projects such as their Erasmus Bridge in Rotterdam, detailed in *MOVE*, is a testament to the efficacy of a new kind of network practice.

Enabled by new information and communication technologies, network practices become communities that are more powerful than any single studio or office. Networks, Kelly suggests in *New Rules*, allow for a gathering and redistribution of information so that "as the number of nodes in a network increases arithmetically, the value of the network increases exponentially." And when network links to network, the possibilities for innovation multiply exponentially, as well.

The new architectural practice

Not limited to established firms like UN Studio, network practices proliferated in the 1990s, reflecting the need for small, innovative studios to

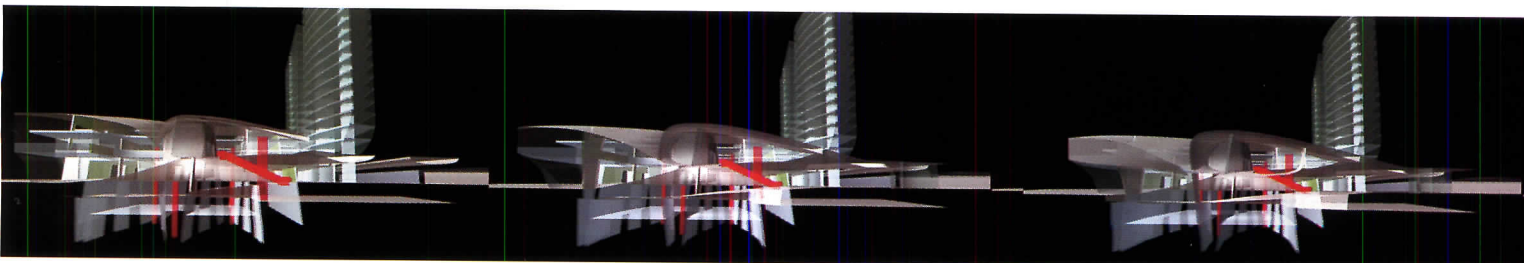

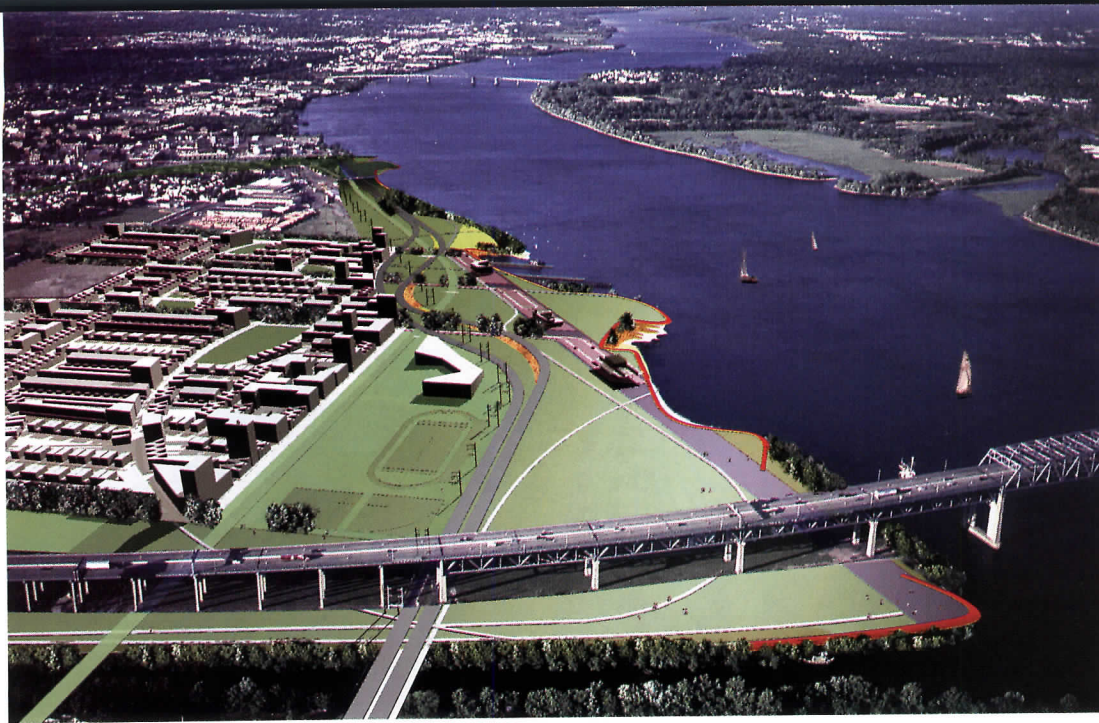

The North Delaware Riverfront Study by Field Operations—Stan Allen/James Corner of Philadelphia and New York—for the Bridesburg section of Philadelphia (2001).

create working partnerships that bridged geographical divides. The Korean Presbyterian Church of New York [RECORD, November 2000, page 78] was designed and built as a collaboration among Greg Lynn (Los Angeles), Douglas Garafalo (Chicago), and Michael McInturf (Cincinnati), architects with small offices in three geographically distant cities. Taking advantage of electronic imaging and new communication technologies, they were able to complete a large, complex project in a distant city, which none could have managed alone. The rise of network practices such as O.C.E.A.N., founded in London, with members scattered around the world, and the New York and Philadelphia-based Field Operations, a collaboration between architect/theorist Stan Allen and landscape architect James Corner, also reflected the need to expand research and development possibilities that have been luxuries to most firms.

Research was essential for many of these new offices. Dutch firms like MVRDV transformed “datascaping”—the literal transformation of data (economic, building codes, etc.)—into a new kind of design protocol. Meanwhile, Crimson and MAX.1, also from Holland, developed new urban-planning strategies based on what they called “orgware,” a middle ground between the software of plans and the hardware of architecture. Research also became the focus of many new programs in schools of architecture, including at Harvard Graduate School of Design’s “Project for the City,” the Berlage Institute in Rotterdam, the Design Research Laboratory (DRL) at the Architectural Association in London, and the Metropolitan Research and Design Program at SCI-Arc in Los Angeles.

This interest in research in architectural schools was accompanied in many cases by a parallel development in which the object of the research was no longer simply an academic thesis required for a degree, but it aimed instead on discovering opportunities for architects to exploit, both

commercially and socially. DRL head Patrick Shumacher boldly states, “Questions concerning design product and process can only be addressed within an academic framework that understands architecture as a research-based business rather than a medium of artistic expression.”

Following Kelly’s assertion that the new economy favors intangible things, knowledge-based architecture consultancies like AMO, an offshoot of Rem Koolhaas’s Office for Metropolitan Architecture (OMA), also emerged in the 1990s [RECORD July 2000, page 92]. AMO was formed when principals Rem Koolhaas and Dan Wood, then project architect for OMA’s abandoned Universal Studios Project in Los Angeles, discovered that their ideas and research into the identity, organizational structure, and corporate culture of Universal was potentially more valuable than any “investment in the physical.” As AMO principal Jeffrey Inaba explained recently, relying on an extensive and loosely organized network of curators, philosophers, editors, and designers, AMO offers clients such as Prada, Condé Nast, and Harvard University “cultural intelligence with a decided point of view.”

Appeal for the Big Guys

The formation of Gensler Consulting in the late 1990s signaled that some large firms understood better than anyone the growing importance of “intangible things.” Created by the merger of Gensler’s strategic-planning and information-service practices, Gensler Consulting sought to develop new business competencies. As Gensler COO David Gensler noted in a recent conversation, “It is built upon the customer-oriented approach that was part of the original vision of the firm’s founders.” Seeking the next level of innovation in an already successful “business to design” approach, Gensler Consulting was able to transform knowledge gained from what it calls “client intimacy” into new lines of nontraditional design services. “To stay abreast of changing conditions,” says Loree Goffigon, Gensler’s firmwide head of consulting, “we must understand all aspects of a client’s business needs, including not only its spatial and environmental needs, but also its technology, communications, organizational, and cultural needs.” These new, knowledge-based services include workplace transformation, information solutions, and real estate facilities strategy, among others.

Young firms join in

An interest in this kind of integrated approach led Gregg Pasquarelli and his partners at SHoP, a young and growing firm founded in the mid-

A proposal by Ben van Berkel and Caroline Bos of UN Studio in Amsterdam for a transit station in Arnhem, the Netherlands, (1996).

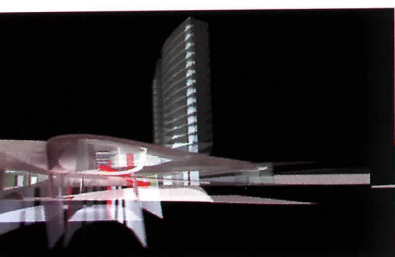

addressing what theory would come after the exhaustion of “theory.” But focusing on a theory of practice rather than on newly emerging forms of practice suggests a failure to recognize the important shift in the relationship between thinking and doing that occurred in architecture in the 1990s. Rather than turn Pragmatism into a theory meant to influence practice, the goal should have been to emphasize thinking as doing—the promise extended by Pragmatism in the early 20th century and readdressed by managerial thinkers in the 1990s. Management pioneer Peter Drucker has pointed out that the transformation of modern capitalism

THE CATASTROPHIC EVENTS OF 9/11 ARE CONSISTENT WITH, NOT CONTRARY TO, THE NEW MARKETPLACE.

into a world system was enabled by a fundamental change whereby knowledge was no longer centrally concerned with *being* (philosophical questions about what is), but with *doing*. Knowledge was applied to tools in the first, industrial period of capitalism, the period in which American Pragmatism emerged. But, Drucker suggests, a second phase of this transformation occurred after World War II in which knowledge is applied not only to tools but also to intangible things—ideas, information, and relationships. This transformation ushered in the management revolution and signaled the emergence of “the knowledge society,” as Drucker terms it, of which the new economy is only the most recent incarnation.

Network effects

Given all that we know about the global network of the alleged September 11 perpetrators—about the complex, interlinked cellular networks of finance, training, and communication that supported them; about the intangible things, the fear and uncertainty, left in their wake—it has turned out that the catastrophic events of September are consistent with, and not contrary to, the new marketplace and the society of ubiquitous electronic networks predicted by Kelly. Oxford financial historian Niall

Ferguson made just this point recently when he suggested that we may look back from the year 2011 to discover that September 11 will have had little impact on, and indeed conforms with, trends already underway, including the globalization of terrorism, the financial downturn, and the emergence of a new form of imperialism.

Taking a more pessimistic view of what they prefer to call the “society of control,” Michael Hardt and Antonio Negri, authors of *Empire* (2000), the highly acclaimed neo-Marxist study of globalization and politics, presciently forecast in their book a new supercapitalist world in which all forms of centralized power and authority will be decentralized, resulting in a complex global network of control (“empire”). Struggle for dominance, for market share in this new world order, they suggest, will no longer be among superpowers, nation states, or even large corporations, but among competing networks of cells that recognize no fixed boundaries.

Whether “society of control” or benign “knowledge society,” the challenge facing architecture post-September 11 is not to develop more pragmatic theories of practice. Nor is it to worry about what object will fill the gaping hole left in all our lives when the towers came down. No, the challenge for architecture is to develop forms of practice able to survive and prosper in the fiercely competitive global marketplace where intangible things like brands, experience, identity, terror, fear, and even access, as Jeremy Rifkin tells us in *The Age of Access* (2000), are becoming increasingly important. In order to live up to this challenge, architecture will have to evolve new forms of adaptive design intelligence that will enable it to add value and achieve competitive advantage. This is precisely what the innovative practices mentioned above offer architecture. But it is unclear whether or not architecture will understand or accept them. What does seem certain, however, is that if architecture remains fixated on form and abstract ideas, on flesh and word, as Colin Rowe famously put it, and their combination to create new styles, it will surely lose out to more supple forms of design practice. This is as true for the network we call architecture as it is for the individual, cellular nodes that comprise it. ■

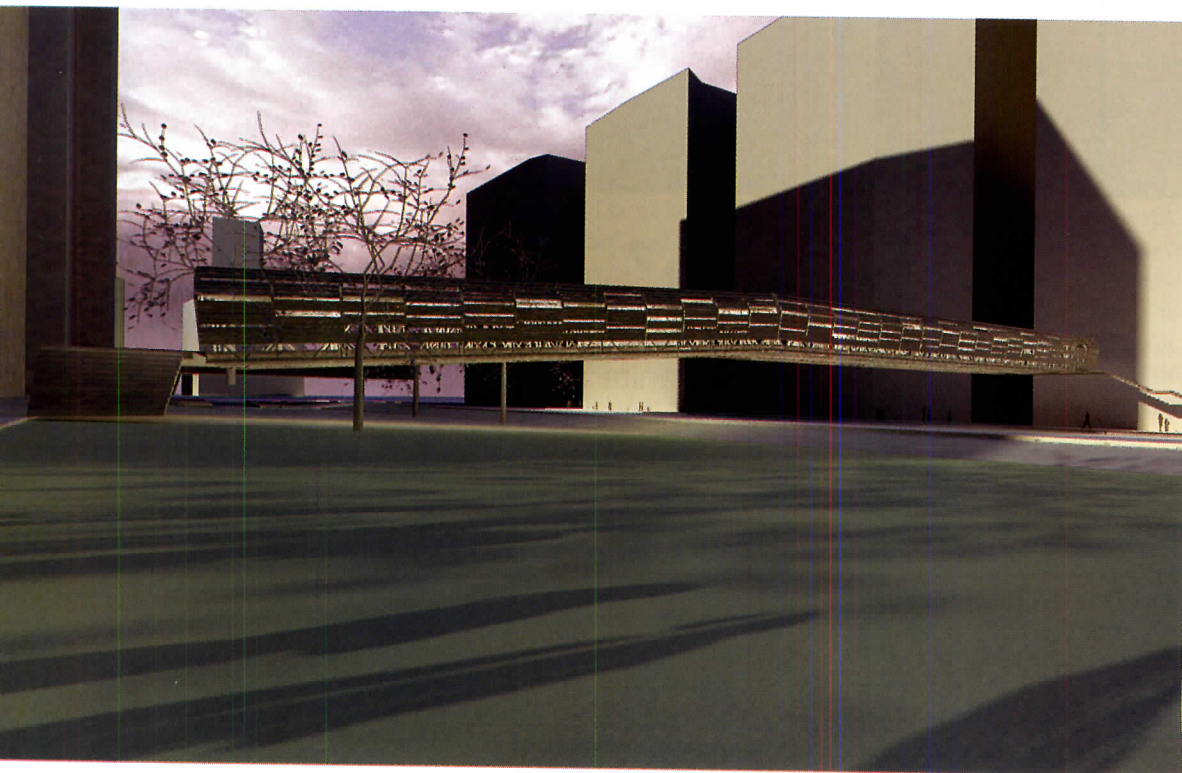

Proposal by SHoP/Sharples, Holden Pasquarelli of New York for temporary pedestrian bridge, Lower Manhattan (2001).

Not Anymore.



And no sprinklers required.

Imagine – glass fire doors in a 2 hour corridor. Technical Glass Products' unique system combines Pilkington Pyrostop® glass with Fireframes® by Forster to offer you transparent wall units and full-vision doors. Listed by U.L., the system carries fire ratings up to 2 hours and provides a barrier to flames, smoke and heat.

Call today to find out more about this revolutionary system.

1-888-397-FIRE

www.fireglass.com

CIRCLE 41 ON INQUIRY CARD



TGP

Technical Glass Products

ONE SOURCE. MANY SOLUTIONS.

Morphosis's graduate student housing
at the **UNIVERSITY OF TORONTO** combines
Modernist housing typologies with a brash
energy to signal its gateway status



A glazed corridor and steel cantilevered sign dominate the major facade of the Graduate House on Spadina Avenue, marking the edge of the University of Toronto campus.

By Suzanne Stephens

With the limited opportunities architects have to produce housing, it is not too surprising that Los Angeles architect Thom Mayne would seize the chance to design a 434-bedroom residential complex for graduate students at the University of Toronto. He and his firm, Morphosis, entered a limited competition with Toronto architect Stephen Teeple and, happily, won. The bad news was the budget: \$85 (\$53 American) per square foot for the 230,000-square-foot structure. As Mayne points out, “A parking garage is \$55 [American] per square foot.”

However, in spite of the constraints, Mayne was able to rework two housing typologies popular with early Modernists—the perimeter block and the skip-stop plan—and give them literally a new twist. Sited at the edge of the university campus, the large, rectilinear structure combines these planning concepts with materials, symbolic expression, and formal considerations in a strong, compelling statement. The planning types are combined and altered by a series of moves that involve cranking portions of the mass off the orthogonal grid to create openings and fissures and then layering these masses with perforated metal screens, aluminum-coated steel panels, glass window walls, and precast planks. On top of that, a walkway and a sign element that juts out over the side street proclaim the housing as a gateway to the University of Toronto campus.

The .79-acre site for the graduate student complex fronts a large four-lane street (not including tracks for the tram). With this assortment of slablike apartment buildings and old houses turned into commercial use, Mayne placed the dwelling units around the edges of an interior open court, under which sit two levels of parking for 158 cars. “The object building wasn’t going to work there, so we went to perimeter block housing to give it a massing, height, and horizontality,” says Mayne, pointing out how that horizontality is reinforced by the sign jutting out over the street.

To keep the massing low for the community yet provide the density needed for the university’s requirements, Mayne made the west-facing portion stretching along the main thoroughfare seven stories high, while the portion along the other side of the court, facing east, rises to 10 stories. Here the block is composed of duplexes arranged in a skip-stop, double-loaded plan, with living rooms on one floor and bedrooms either above or below. With this stacking, hallways with elevators need only occur on the first, third, sixth, and ninth floors.

The skip-stop plan, developed in the mid-1920s, brings to mind

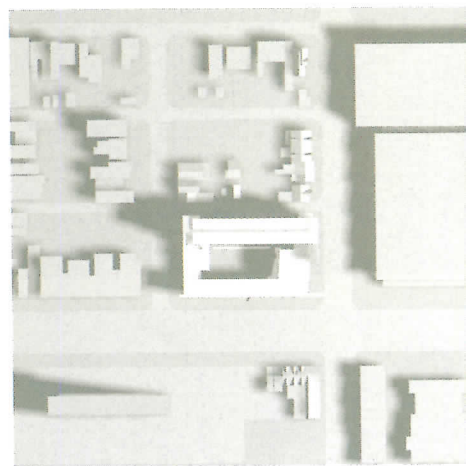

Project: Graduate House, University of Toronto, Toronto, Ontario
Design architect: Morphosis—Thom Mayne, principal; Kim Groves, project architect; Stephen Slaughter, Brandon Welling, design team
Executive architect: Teeple Architects—Stephen Teeple, principal; Chris Radigan, project manager;

Bernard Jin, Rob Knight, Tom Arban, design team

Client: Michael Marrus, dean of School of Graduate Studies

Engineers: Yolles Partnership, (structural); Carincini Burt Rogers (electrical); Keen Engineering (mechanical)

Contractor: Axor Construction



The materials and treatment of each facade vary: On the low-scale, north end (above), a mustard-tinted stucco coats the concrete shear wall, and aluminum shingles cover an abstract gable element. The ribbed concrete planks of the west facade are integrally painted a gray-brown.

Josep Lluís Sert’s Peabody Terrace Married Student Housing at Harvard (1965), where, incidentally, Mayne lived as a student at the Graduate School of Design. Nevertheless, he disavows too much willed (or nostalgic) intent in turning to this part. “It took about 45 minutes to decide to do the skip-stop,” he says. “We weren’t thinking about reviving the plan—it just seemed doing floor-through units with a lot of natural light was the right move. And reducing the number of corridors was more efficient.”

The seven-story portion of the housing facing the main street is devoted to single-loaded corridors and suites: On the second through fifth floors the corridor runs along the inner-court side of the building, while on the sixth and seventh floors it switches to the road side. Here it becomes a large “human cornice,” according to the architects, which cantilevers over the side street by virtue of a double-height truss construction. Because of the glazed bar of ceramic frit, where *University of Toronto* is spelled out in clear glass, this west facade becomes the major enclilada—seen by all, sign and circulation are one.

However, the active west elevation is not the entrance facade; instead, the entrance is located on the short end, facing south. The southwest corner rotates away from the orthogonal plan so that the space created by the rupture reads more clearly as an entrance. All facades are treated differently: Because of the polyglot neighborhood, it made sense

The entrance to the student housing on Harbord Street is partially framed by a perforated corrugated aluminum screen. A fissure of space created by the rotation of the block away from the orthogonal grid emphasizes the transition from the outdoors to the interior.



for each facade to relate to the scale of its particular micro-context. Therefore, the short end of the north side of the block is treated as a more intimate, abstracted version of a house, albeit with aluminum-coated steel shingles and a gable element. What would normally be the back side, the elevation facing east toward the rest of the university campus becomes a window wall masked with a filigree of perforated metal. Attached to vertical fins of a standard aluminum and glass window system, the screens create a shimmering effect and partially reveal the elongated fenestration.

The use of materials and massing may seem brash or overly muscular at first glance, but a closer look reveals a sensitivity in the architect's use of proportion and scale. There are some drawbacks to be sure: Some apartments, in which bedrooms range from 118 to 270 square feet, have more light, space, and windows than others. Some of the fenestration on the east facade is masked over; however stunning this scrim, it may not be preferable to uninterrupted views. The dark brownish-gray pigmentation of the ribbed concrete facade on the



street and on the court's stuccoed base seen in contrast with the grid of light precast concrete panels looks stark on a gray, wintry day. The courtyard, which has a pool running around the periphery, with an elevated "pier" diagonally crossing through the center, is drained in the winter. The result is rather bleak, particularly since there is so little planting (one tree!) in the courtyard itself. Nevertheless, the balance of formal strategies, materials, and planning types is well thought out. The poured-in-place concrete shear wall and slab construction, much of which is exposed inside, bring a tough, lean, but calm sense to the whole. Even the interior halls and public spaces benefit from ample natural lighting and modulation of the ceiling plane. In taking on the problem of budget housing for a university, Mayne has shown that early Modernist housing typologies can yield an architectural richness today. ■

Sources

Precast concrete panels: *Global Precast*

Steel truss: *Torsteel*

Perforated corrugated anodized aluminum: *Vicwest*

Window wall and curtain wall: *Allan Windows*

Paints and stains: *Sherwin Williams*

Plastic glazing: *CPI*

Acoustical ceilings: *Armstrong*

Plastic laminate: *Formica*

Resilient flooring: *Marmoleum by Forbo*

WWW For more information on the people and products involved in this project, go to Projects at www.architecturalrecord.com





Many of the 121 residential units overlook the interior courtyard (above). The open space is dramatized by an elevated pierlike element with plantings and elongated pools around the edges. Precast concrete panels on the inner walls of the court bounce daylight into the units.

Along the street, the building needed to stand out without being obtrusive. The solution was to set the library back from the street, where it lines up with houses on adjacent blocks, then thrust the entrance forward in a bold wedge.

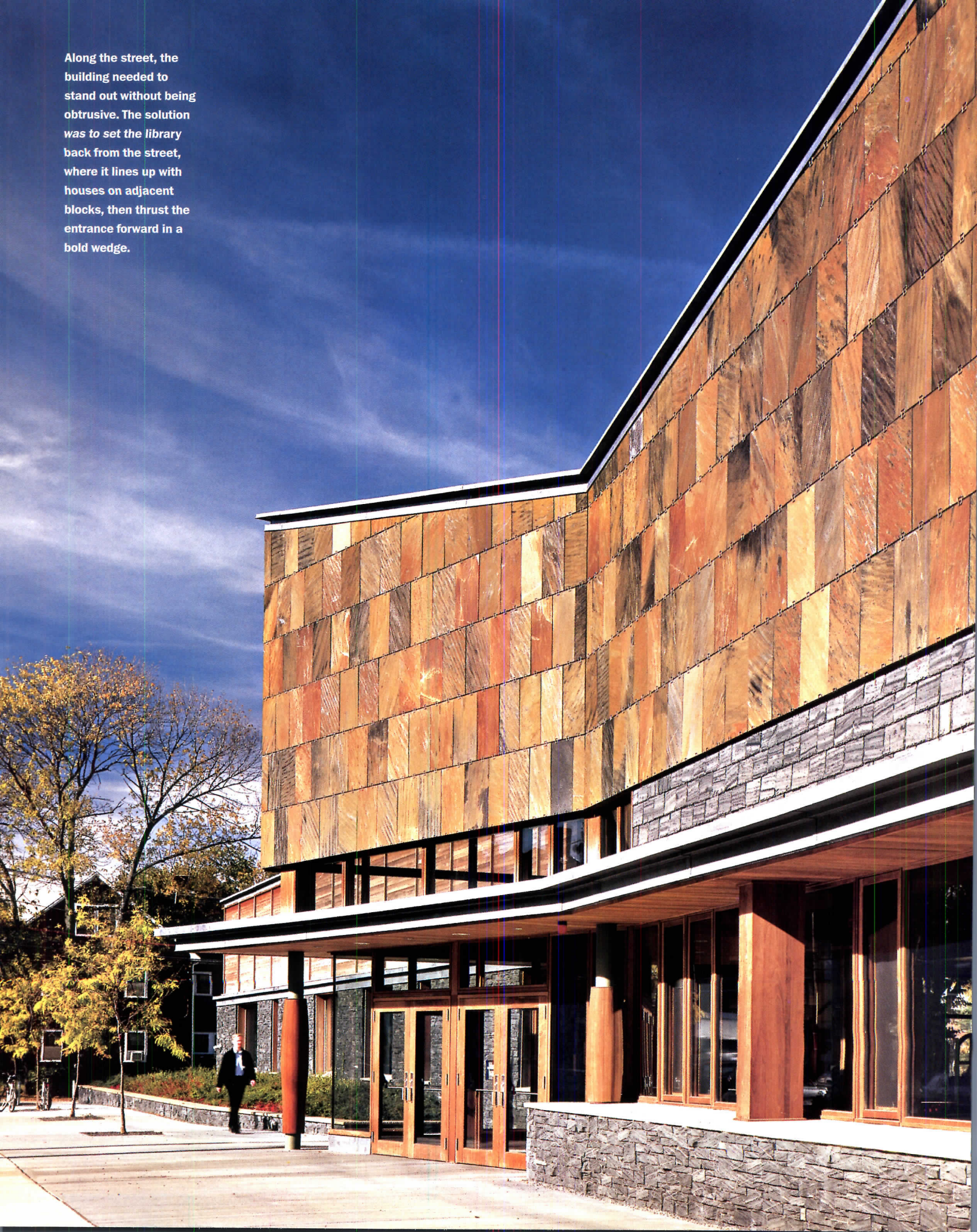

At the new **ALLSTON LIBRARY**, **Machado and Silveti** pleases the public with a casual, stylish building that's more a community center than a place for books

By **Robert Campbell, FAIA**

At the new branch of the Boston Public Library in the Allston neighborhood, the winter light seems to flow uninterrupted from the sidewalk to the Amelanchier trees in the inner courtyard garden. This is a building that opens itself with trust to the street and the world.

Public buildings today, as everyone knows, are designed by collaboration—not only of architects with civic administrators, but also with neighborhood residents (and sometimes other advocacy groups). In Allston, the architects were the Boston firm of Machado and Silveti (Jorge Silveti chairs the architecture program at Harvard's Graduate School of Design). For a long time, Machado and Silveti were stylists whose work was more often published than built. In the Allston library and other recent works, they've learned to please the public without sacrificing their integrity.

Neighbors were worried they would get a building that would overscale the modest wood-frame residential streetscape. They also didn't want anything that would look too (gasp) modern. The architects responded with a building that fits comfortably into its surroundings but doesn't look shy or old-fashioned (although there's a whiff of a fifties "Danish Modern" aesthetic). For efficiency, the library is a one-story plan, but it asserts a civic presence by rising to a double-height interior volume along the street. There it looks like a two-story building, because the architects have divided the facade into tiers: a lower level of rough blue-gray Vermont slate, and an upper tier of smooth Norwegian slate panels of a variegated copper color. The library thus reminds one of the Boston two-family houses that put on a sweater of maybe asphalt shingles upstairs, with perhaps stone veneer below. It's contextual in a way that is simultaneously amused and respectful.

Along the street, the design problem was to make the building

Contributing editor Robert Campbell, FAIA, is the Pulitzer Prize-winning architecture critic for The Boston Globe.



Architect: Machado and Silveti Associates—Jorge Silveti, principal in charge; Rodolfo Machado, consulting principal; Timothy D. Love, project director; Matthew T. Oudens, project architect; Michael Le Blanc, Gregory G. Canaras, design team

Client: The City of Boston, Department of Neighborhood

Development for the Boston Public Library

Consultants: Lim Associates (structural); TMP Consulting Engineers (mechanical/electrical); Robert W. Sullivan (plumbing)

Size: 20,000 square feet

Cost: \$6.3 million

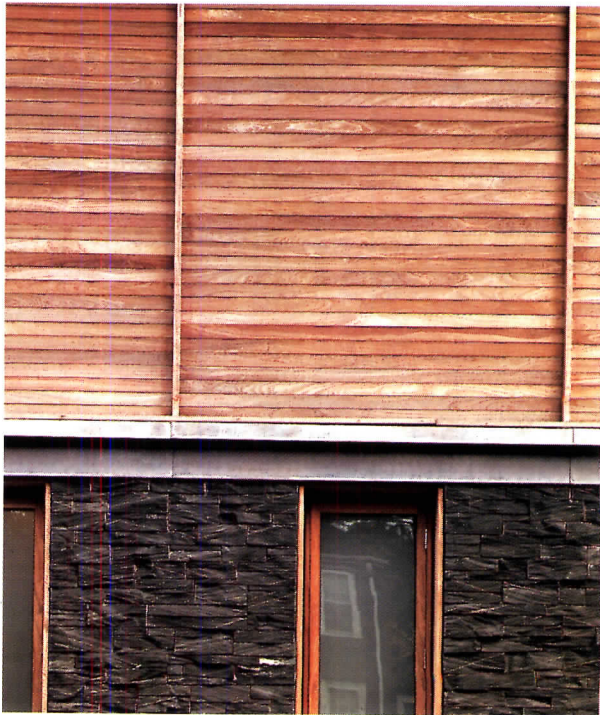
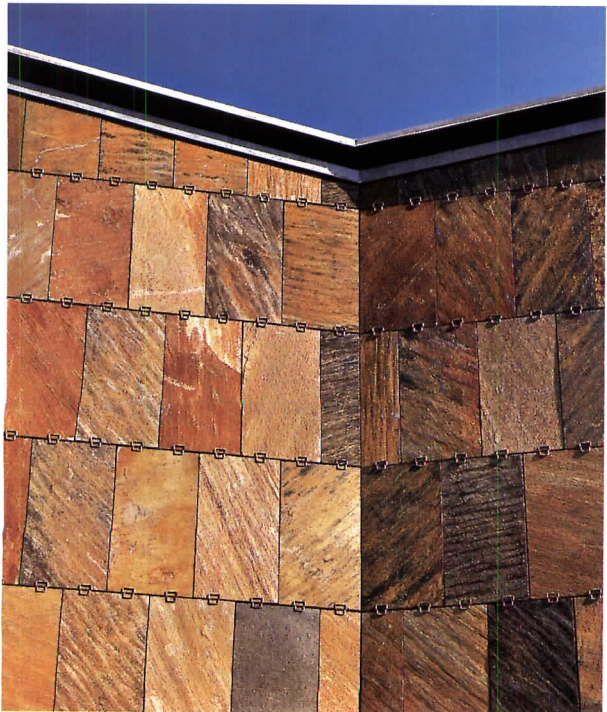

The library looks like a two-story building because the architects divided the facade into tiers (above). They went to great lengths to avoid a uniform institutional ambience by varying materials (left). On the main facade, besides the two kinds of slate used in upper and lower registers, there's yet a third slate in the form of hanging shingles (far left).

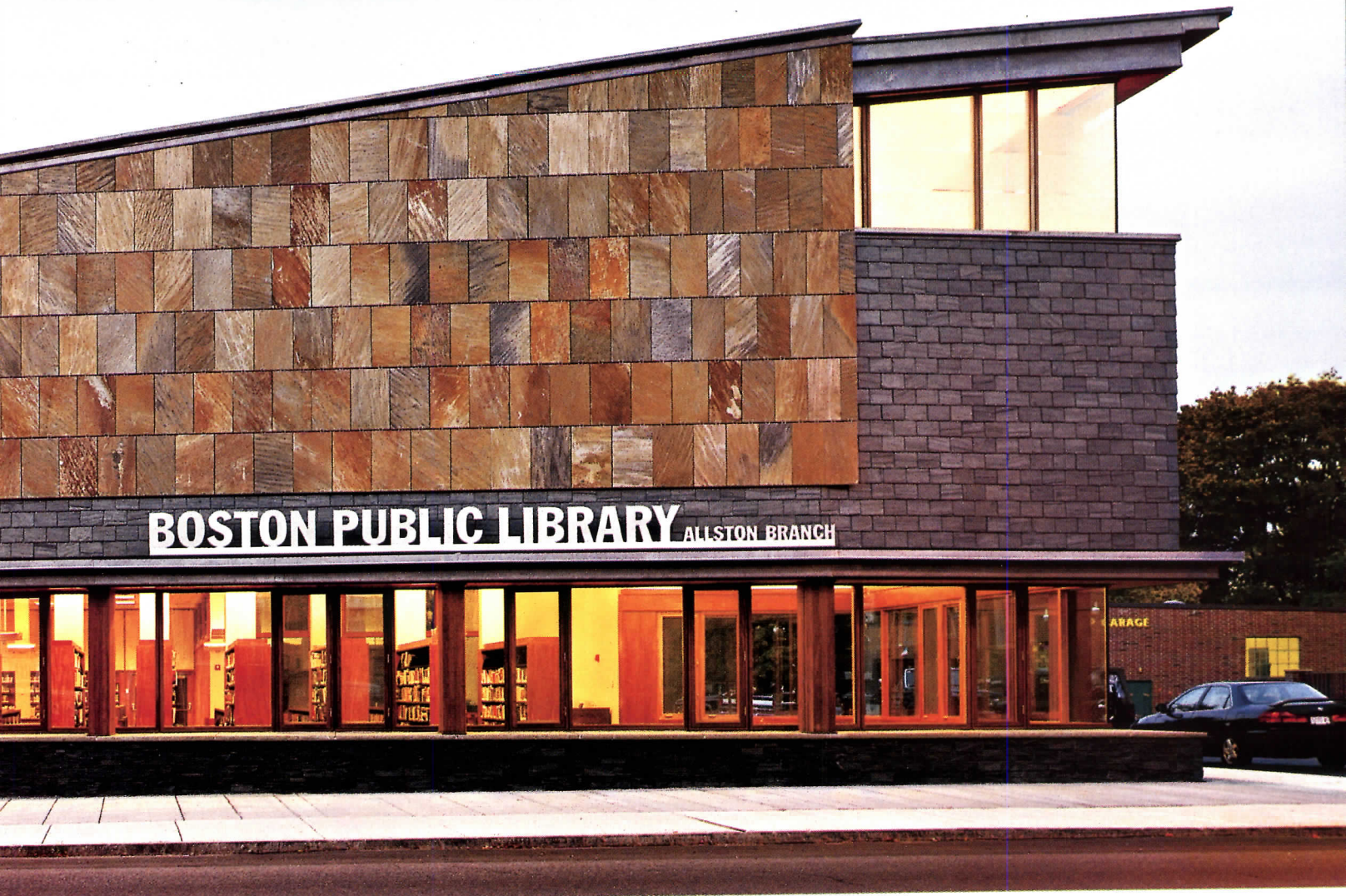

stand out without being obtrusive. The solution was to set the library back from the street, where it lines up with houses on adjacent blocks, then thrust the entrance forward in a bold wedge you can't miss when you drive by.

The clear, simple plan is four stripes, all parallel to the street. First comes the street-front building, containing the books, the reading rooms, and the staff, lining the sidewalk with windows that open a welcoming view of the interior. Second is a stripe of mostly open-air garden courtyards, including a children's reading garden beneath a fairytale-size, 75-year-old copper beech, painstakingly protected during construction. Next is another stripe of building, containing meeting rooms and backup spaces. Finally comes an outdoor stripe of parking.

Architecture buffs will quickly spot the influence of Alvar Aalto in many of the materials and details: the cork floors, the wood jackets on the steel columns. The architects go to great lengths to avoid a uniform institutional ambience by continually changing materials. On the main facade, besides the two kinds of slate on upper and lower tiers, there's yet a third slate in the form of hanging shingles. And there is unfinished mahogany that should bleach and weather in a Kahnian manner. Around the courtyard, walls are sheathed in lead-coated copper. Cabinets and furniture are made of walnut and mahogany. On the floor, the usual cork is varied with oak, bluestone, and vinyl tile. Sometimes the mix of so many materials feels fussy, like a display of samples you might see in a manufacturer's showroom. But it works to keep things casual. The Allston

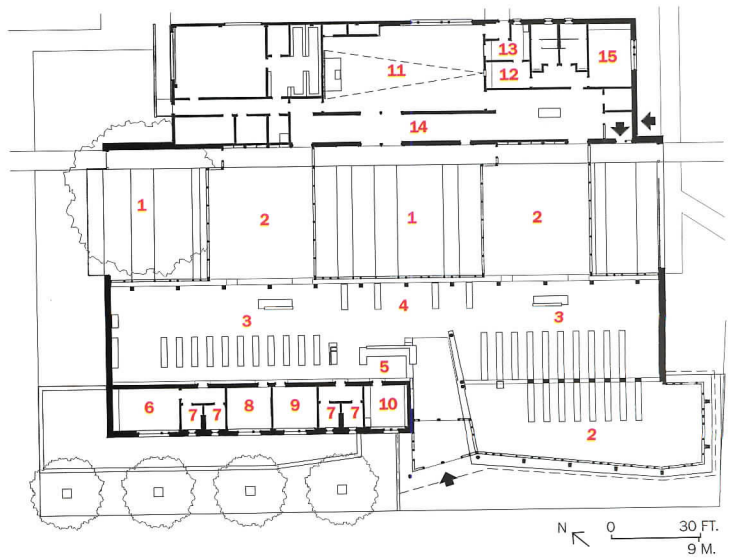

- | | | |
|---------------------------|---------------|---------------------|
| 1. Reading gardens | 6. Lounge | 11. Community room |
| 2. Reading rooms | 7. Bathrooms | 12. Projection room |
| 3. Stacks | 8. Study room | 13. Kitchen |
| 4. Audio-visual/reference | 9. Office | 14. Gallery |
| 5. Circulation desk | 10. Workroom | 15. Conference room |



library isn't a suit, it's dress-down Friday. "It was necessary to counter the antimodernist feeling in the neighborhood with texture," says Silveti. "We wanted materials that would gain a patina with age." The honey locust trees along the sidewalk are another layer of softening patina.

What's puzzling about the library is that there are so few books. There is shelf space for only 37,000 volumes. The paucity of books is an index of the way libraries are changing. They are, increasingly, community centers, art galleries, children's story nooks, gardens, computer banks,

The winter light seems to flow uninterrupted from the sidewalk to the Amelanchier trees in the inner courtyard garden (above), which includes a children's reading garden beneath a fairy-tale-size, 75-year-old copper beech (left).

video swaps, coffee bars, bulletin boards, meeting rooms—anything but book stacks. It's all healthy and democratic and good for community and social life, of course. But maybe there could be lots of books, too.

That's not the architects' problem. As a building, Allston is a triumph of what you might call the architecture of democracy. The collage of many materials becomes a symbol of the pluralism of the design process. The cowboy and the farmer can be friends, the old song says. Here, read the architect and the neighborhood.

Harvard University deserves credit for friendship, too. It donated the land, as an early diplomatic step in making acquaintance with a neighborhood into which it plans to expand in a major way. The Allston library is a winner on all counts. ■

Sources

Exterior cladding: Vermont Structural Slate (*slate shingles and panels*)

Wood windows and doors: Duratherm Window Corporation (*Jarrah exterior—unfinished; African mahogany interior—clear finish*)

Seating: Phister (*lounge seats*); Knoll Studio (*leather chairs and sofas*);

Agati (*"white collection" side chairs and armchairs*); Herman Miller (*"Aeron" chairs*)

Reception furniture, desks, carrels: Huston and Company

WWW For more information on the people and products involved in this project, go to Projects at www.architecturalrecord.com

The front of the building contains the books and reading rooms, which line the sidewalk with windows that allow a welcoming view of the interior.



The ETFE panels, as large as 36 feet across, give Eden its deceiving scale. The peaked tents of the visitor center (left in construction photo, opposite) overlook the gardens below.



With domes that bubble out of Cornwall's ruined landscape, **Nicholas Grimshaw & Partners** gives the **EDEN PROJECT** a sci-fi twist



By James S. Russell, AIA

Only a few years ago, the site of the Eden Project was a 37-acre open-pit mine giving up its last truckloads of china clay. Nowadays, while parking in one of the many lots sliced into the edge of the pit, you get no hint of the site's past nor its remarkable transformation. The sense of the place is tightly orchestrated as you reach the visitor center, under an entrance passage roofed by a fabric tent tautly stretched to a rammed-earth wall. There, driftwood-art wooden horses greet visitors, gesturing them toward waiting lines roped in garden hoses and buckets.

This somewhat dissonant combination of suave eco-design and ingratiating cuteness still fails to prepare you for what is to come. Only from outside the center does the project's Ozlike expanse appear, fully spread. There, giant bubbles of improbable lightness, which appear to have seeped out of the old pit walls, preside serenely over a scene of hive-like activity: Little rubber-wheeled trains haul swarms of visitors in and out of the 200-foot-deep pit amidst colorful stripes of planting festooned with tents, flags, and artworks.

For all its amusement-park trappings, the Eden Project is a botanical garden with an agenda—to tell the story of how people rely on plants for the necessities and amenities of everyday life, and thereby to

inspire a greater concern for the natural world. It was the brainchild of Tim Smit, a composer and record producer who figured out that the unique climate of Cornwall, lying in the warming embrace of the Gulf Stream at Britain's far southwest tip, could support a major botanical attraction. In the early 1990s, he turned an overgrown jungle on a neglected Cornwall estate into a successful garden attraction, The Lost Gardens of Heligan. Anyone who adds "lost" to the name of a garden clearly has a showman's instinct, and a Barnumesque spirit permeates the Eden Project. (The name, for that matter, combines a whiff of Ian Fleming with a Biblical-scale ambition.)

The visitor can't escape a relentlessly ingratiating tone, akin to that of a children's television show (as in, "a symbol of hope—in action").

Project: *The Eden Project, St. Austell, England*

Architect: *Nicholas Grimshaw & Partners—Andrew Whalley, AIA, Jolyon Brewis, David Kirkland, Michael Pawlyn, Perry Hooper, Bill Horgan*

Engineers: *Anthony Hunt Associates (structural); Arup (mechanical and facade); Land Use Consultants (landscape)*

Project manager: *Davis Langdon Management*

Contractor: *McAlpine Joint Venture*



Even the sky's not the limit at the Eden Project

Buckminster Fuller would be impressed. At the Eden Project, several interlocking structures push geodesic dome technology beyond what Fuller could accomplish in his own time, but certainly not beyond what he could have imagined. At Eden, domes cover 323,000 square feet of tropical rain forest and can accommodate trees that soar to 160 feet in height, making the project the largest self-supporting structure in the world.

FOILTEC, headquartered in Germany with offices in the U.S. and London (www.foiltecna.com), engineered the domes using its unique Texlon Transparent Roof System of relatively thin tubular

steel frames that are infilled with hexagonal-shaped pillows made of DYNEON ETFE (ethyltetrafluoroethylene) film. Although the domes appear too light and fragile for their function, FOILTEC designed them to withstand a wind suction load of 45 pounds per square foot and a snow load of 65 pounds per square foot.

The pillows are made from three layers of ETFE. The interior layer is .1 mm thick, and the middle and outer layers are .2 mm. ETFE has excellent chemical and electrical properties, superior resistance to abrasion and tear, and a seemingly indefinite life expectancy. Twenty years after it

was introduced commercially, ETFE film shows no sign of decomposing from either air pollution or high levels of UV radiation.

Highly efficient thermal insulation is provided by air between the layers of foil, which is supplied by an external air handler. However, this system is not related to the structure. An interruption of air supply will affect the insulating properties but not the structural integrity. Unlike glass, ETFE film is self-cleaning. All exterior dirt is washed off by rainfall.

The Eden Project is an anomaly in size only. It's a glimpse into the future of space-making that Bucky Fuller dreamed of. *Sara Hart*



A sod-roofed café (right) linking the two biomes spills into the outdoor “biome.” The pit shelters the domes from extremes

of cold (opposite); the project hopes to replace gas-fired heaters with wood-fired ones fueled by Eden-grown biomass.

What’s remarkable is how an architecture overtly expressive of technological prowess and industrial technology not only works with Smit’s vision, it makes it work better.

Domes make dreams come true

The success of Smit’s Heligan project convinced him that the region could support something much larger and more ambitious. He discovered the quarry near the village of St. Austell that would become Eden’s site. In its eroded sides and lumpy bottom dotted with pools of fetid, standing water, he saw something “very bold and primal.”

Smit assembled a team in 1995 to compete for government Millennium grants (proceeds from the national lottery), proposing a private, limited-profit company to run Eden. Envisioning a twenty-first-century version of the crystalline botanical halls at Kew Gardens, he chose Nicholas Grimshaw & Partners on the basis of the glass-and-metal bravura at Waterloo Station, in London [June 1994, page 90].

It took three applications and more than two years before the funding was assembled, but there was a silver lining: “The long funding process allowed more time to figure out the scheme,” said Andrew Whalley, Grimshaw’s partner in charge of the project. The firm had enormous expertise at its disposal thanks to the design/build arrangement adopted for the project. Eden united the contractor, McAlpine Joint Venture, and Grimshaw with Davis Langdon (a project management firm) and Anthony Hunt Associates, the structural engineers that had helped Grimshaw realize Waterloo.

Smit’s original scheme envisioned three enclosed biomes, rep-



resenting the tropics, the temperate Mediterranean, and the desert. Grimshaw’s earliest proposal for the site simply adapted the undulating

A STRUCTURE OF INTERLOCKING GEODESIC DOMES ADAPTED WELL TO THE UNDULATING TOPOGRAPHY.

glass vault of Waterloo, with its spidery trusses, to the bumpy topography of the clay pit. But the large trusses would have been costly to fabricate, since each had unique span and end conditions and was difficult to transport. The scheme, says Whalley, “somehow seemed Victorian—that we hadn’t really pushed the envelope.”

In the meantime, ethyltetrafluoroethylene (ETFE) foil, with its

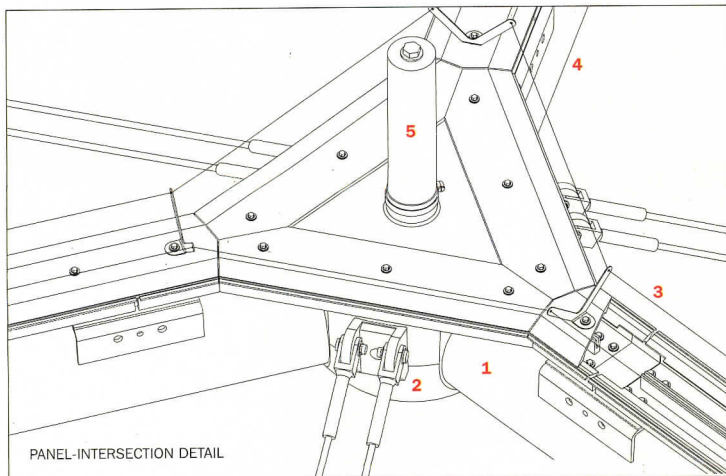

- 1. Glazing support tube
- 2. Connection node
- 3. Foil-pillow clamping system
- 4. Inflation tubes (not shown)
- 5. Fastening post (for maintenance work)



Mero, a space-frame fabricator, suggested adding a layer of triangulated struts under the hexagonal panel's chords (temperate biome, opposite). This eased construction

because the panels could be erected in sections and remain self-supporting. Unit heaters augment natural ventilation (below). Inside the tropical biome (bottom).



ideal transparency, thermal qualities, and ability to span large distances (page 96) seemed the glazing material of choice. "We asked ourselves how to devise a structure that was true to the properties of this material," explained Whalley, deciding to define the geometry "as a series of interlocking spheres." A geodesic structure did not require a flat base, so the panels could be sliced where they met grade to allow the dome to clamber up and over ground irregularities. The interlocking of the domes provided additional strength.

The team found other ways to innovate. Topsoil for planting was manufactured on-site from excavated soils and other waste. The water that perpetually seeps from surrounding land into the pit is recycled for irrigation.

That's edutainment?

The spectacle of the domes in construction drew crowds long before the first shrub was planted, creating enormous anticipation. The domes are undeniably spectacular—worth gawking at. In such large structures, the architect and engineers have teased out the simple delight of soap bubbles. And yet there's nothing ingratiating or prettified about the matte-gray struts or the plasticlike ETFE skin. Whalley cannot explain the architecture's extraordinary appeal except in the problem-solving methodology the firm professes. "We're motivated by the issues that face us, rather than an aesthetic idea or visual philosophy," he says.

The domes evoke as well the guilty pleasure of a cheap sci-fi movie: You tend to look over your shoulder to see if they've multiplied since you last looked—which they will. Work is underway on the third biome and an education center, thanks to crowds that topped 1.5 million

AS IN A SCI-FI MOVIE, YOU TEND TO LOOK OVER YOUR SHOULDER TO SEE IF THE DOMES ARE MULTIPLYING. THEY WILL.

in the first eight months, double the 750,000 projected for the entire first year. Not even the terror attacks of autumn or the sinking economy have dampened enthusiasm.

But Smit has work to do. Recognizing that the plants have yet to mature and that Eden has been handling very large crowds, the visitor experience, disappointingly, lacks both a guiding exhibition aesthetic and a clear educational vision. For example, Smit's horticulture and museum-display teams installed sprayed-cement watercourses that neither recognize their own artificiality nor do much to imitate the real thing. Bamboo-pole handrails and "petroglyphs" scribed in a Gunite "cliff" evoke gift-shop ethnography. Educational information was relatively skimpy during a visit last August; it was comprised primarily of such stage-set tricks as a ship's prow that opens to reveal the products the jungle offers us.

It's clear that Smit's gutsiness and marketing savvy have made possible the kind of visitor magnet Cornwall's stumbling savvy economy has long needed. The cutesy edutainment now on offer will pale quickly, however. His interpretive team will probably have to aim higher, aspiring to the state of the art represented by the best museums, zoos, and botanical gardens. Luckily, he's got a work of architecture that shows the way. ■

Sources

Biome structure: Mero
ETFE: Foiltec/Vector Special Projects
Architectural glass: SCS; Allan Roofing (roof glazing)
Roofs: Asphaltic Company; Douglas Flat Roofing (green roof); Clyde Canvas

(tents); Prater Roofing (standing seam)
Rammed earth wall: Insitu

WWW For more information on the people and products involved in this project, go to Projects at www.architecturalrecord.com





Oversize graphics by the design firm 2x4 and large panels of Cor-Ten steel help the small "jewel box" gallery call attention to the museum.

Rem Koolhaas plugs the **GUGGENHEIM AND HERMITAGE MUSEUMS** into the high-voltage setting of the Las Vegas strip

By Clifford A. Pearson

Rem Koolhaas loves to mix it up. His put-up-your-dukes writings and polymorphous architecture invite confrontation—in both the positive and negative sense of the word. He wants you to argue with him. He revels in juxtaposition and crossed paths. Since publishing his first book, *Delirious New York*, in 1978, he has extolled the virtues of high density and recombinant urban patterns. For Koolhaas, architecture is a contact sport.

Las Vegas would seem to be an ideal place for him to work. Where else can you stroll from a giant glass pyramid to an exploding volcano, watch pirates battle a British frigate every half hour, and drop a few grand at the roulette wheel or an Armani boutique? If Koolhaas is going to talk about the joys of crazy-quilt places, let's see if he can design for a city where New York New York is down the block from Paris Las Vegas and Mandalay Bay.

His test has come with a pair of exhibition spaces for the Guggenheim Museum that opened in October. Inserted within the mock-historic fabric of the Venetian—a two-year-old, themed-to-the-nines casino hotel encrusted with faux-Renaissance murals, cast-gypsum pilasters, and urethane-coated-foam cornices and capitals—the two art halls directly engage the twin worlds of theming and entertainment architecture. No discreet separation or polite distance was possible here: High culture meets low-brow America head-on.

Koolhaas could have addressed this mixed context with a wink and a nudge, ironically alerting the cognoscenti not to take it all too seriously. To his credit, he refused the sly way out. Instead of condescending to the neo-Italian surroundings, he treated them no less seriously than the cast-iron buildings in New York's SoHo district, where he recently designed a Prada store. To Koolhaas, Vegas is no less "real" than those now-beloved SoHo buildings, which also imitate historical styles and were

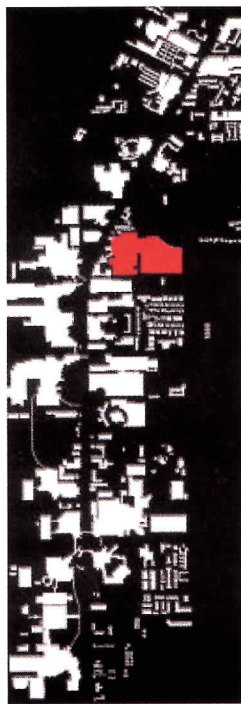

Although the Venetian stands on Las Vegas Boulevard (above), the Rialto Bridge blocks most drivers' view of the Guggenheim (top right).



once widely criticized for doing so in cheap and inappropriate materials. "Vegas isn't fake. It has schools, firehouses, citizens," he replies when asked about authenticity in a town that boasts museums to Liberace and Elvis.

Although designed and built at the same time and attached to the same casino hotel, the two art spaces posed different sets of challenges. The smaller but more visible component is the Hermitage Guggenheim, a joint venture with the State Hermitage Museum of St. Petersburg, Russia. Grafted onto the front of the hotel and nicknamed "the jewel box," the 7,660-square-foot Hermitage Guggenheim had to negotiate a radical shift in scale and style from the 3,036-room, \$1.6 billion Venetian complex to those of a small art gallery. Meanwhile, its big sister, the 63,700-square-foot Guggenheim Las Vegas, hides behind the hotel and must establish its own identity without having any public outdoor presence. Called the "big box," this 70-foot-tall space is currently playing host to *The Art of the Motorcycle*, the popular show that opened at the original Guggenheim in New York in 1998. Both installations—in New York and Vegas—were by Frank Gehry.

As their nicknames tell us, both of the Guggenheims in Vegas are essentially boxes. Neither is a tour-de-force of architectural invention—not surprising, considering they were designed and built in just 14

Project: *Guggenheim Las Vegas, Exhibition Hall and Hermitage Guggenheim Gallery*

Clients: *Venetian Casino Resort—James Beyer, AIA, vice president of design; Guggenheim Museum—Thomas Krens, director*

Design architect: *Office for Metropolitan Architecture—Rem*

Koolhaas, principal; Joshua Ramus, Christian Bandi, project team

Architect of record: *TSA of Nevada—W. Easley Hamner, FAIA, principal; Christopher Leary, AIA, Kriss Pettersen, AIA, Mark Zwagerman, AIA, Dan Thomas, Brad Bartholomew, David Curtis*

General contractor: *Taylor Int'l.*

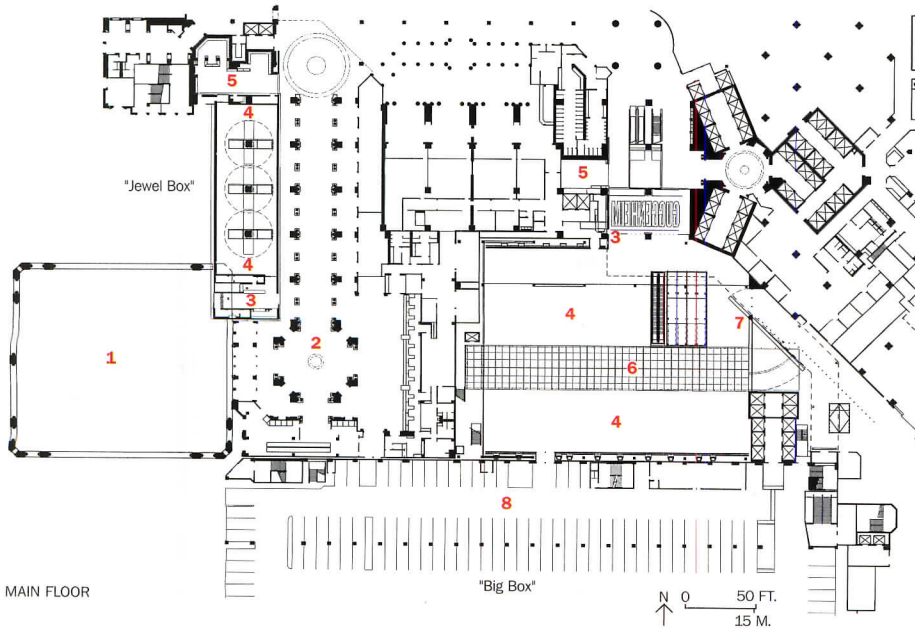

Visitors enter the HermitageGuggenheim from a barrel-vaulted corridor in the Venetian hotel (opposite, bottom). Six-inch strips of glazing above and below the perimeter walls let day-

light slide inside the gallery (above and opposite, top) and offer narrow glimpses of a pebble border outside and the Venetian's grand luxe. Admission to the museum is \$15.

1. Hotel porte-cochère
2. Hotel lobby
3. Museum reception
4. Gallery
5. Museum shop
6. Trench
7. "Mega-door"
8. Garage

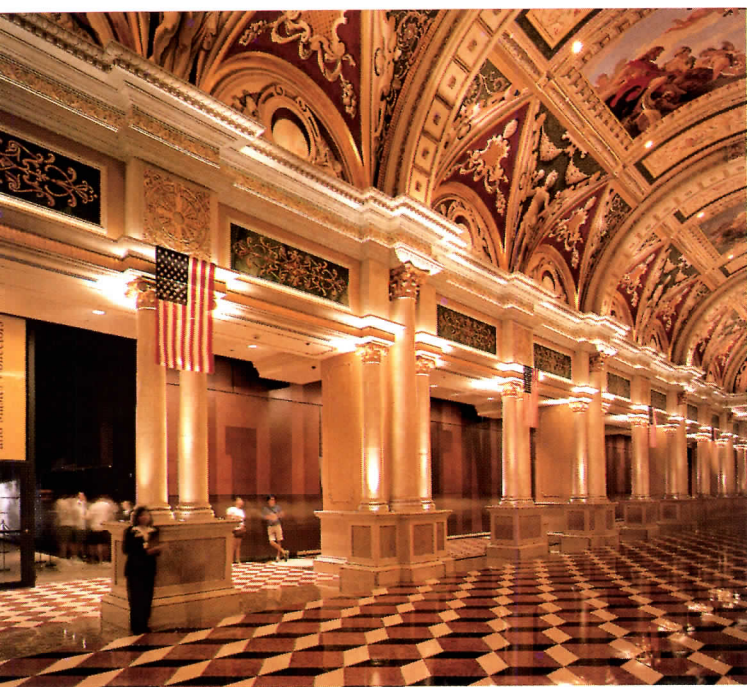

months. Instead of flash, they provide sensible solutions to sticky questions of scale, identity, and context. Comparing the Vegas projects with the one in Bilbao, Thomas Krens, director of the Guggenheim, says he purposely took an opposite approach. “Bilbao was a gritty, industrial city, so we needed an exuberant building. In Vegas, which was already exuberant, we wanted an industrial building.”

Koolhaas’s strategy in Vegas was straightforward—simply apply a new layer of architecture onto an existing canvas and let the differences become part of the story. By using Cor-Ten steel for the Hermitage Guggenheim (both inside and out) and shaping the museum as a sturdy rectangle, the architect gives it the presence to stand up to the hulking Venetian hotel without having to scream for attention. Narrow strips of glass above and below the Cor-Ten walls set both the exterior and interior facades afloat, gently separating the museum from its glitzier host. “We built a strongbox of Cor-Ten, so the museum retains its autonomy and the art retains its aura,” explains Koolhaas.

Treated with chemicals to speed up the rusting process and then finished with a clear sealer to prevent any rust flakes from affecting the artwork, the Cor-Ten has the look of rich leather. For such a hard-edge material, the steel here seems remarkably soft, giving the museum’s interiors the feeling of a luxuriously padded box. Inspired by the velvet-covered walls on which paintings are hung at the Hermitage in St.

THROUGH THE ROOF

Koolhaas originally wanted the roof of the Guggenheim's "big box" to open and expose the museum directly to the sky. Concerns over cooling the large space and protecting artwork inside, however, killed the idea. So the architects designed a fixed skylight and clerestory glazing to maintain a climate-controlled environment. But the roof does open—with hydraulic lifts moving a pair of 125-foot-long, 36-foot-wide flaps from a horizontal position to 10 degrees beyond vertical. Although not installed at the time the museum opened in October 2001, metal panels imprinted with an image of the Sistine Chapel ceiling will be attached to the roof. Until the metal panels are in place, a fabric screen reproduction of the Michelangelo painting serves as a substitute (right). Since the exhibition hall has no outdoor entrance and little presence from the outside, Koolhaas treated the roof as its public facade visible from hundreds of hotel rooms (above). Putting it in motion helps it grab attention.

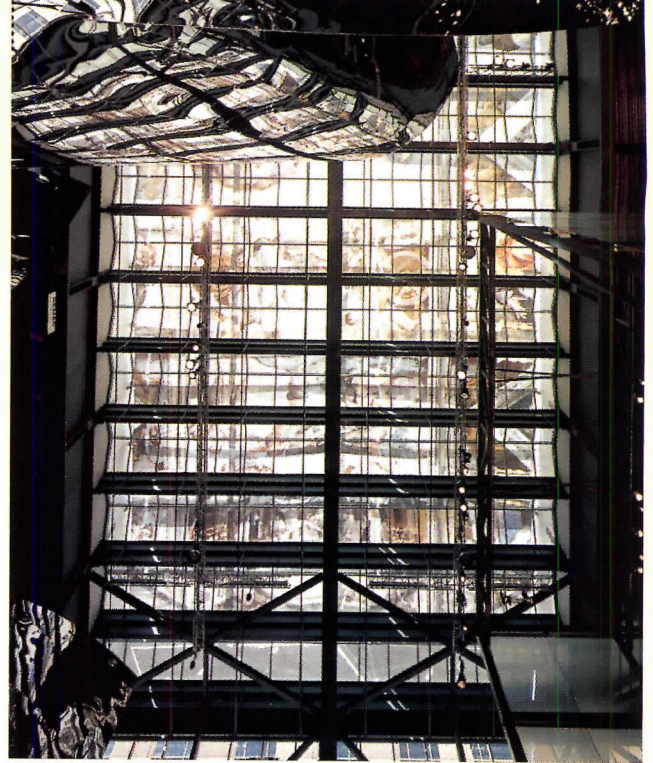
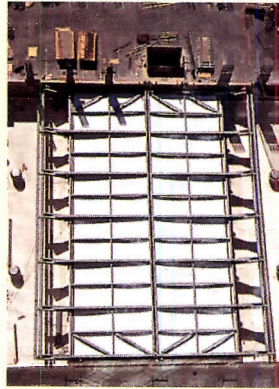

Like the roof mural, the stairs leading down to the "trench" provide a splash of color in an industrial-type setting.



Frank Gehry's installation of a show on motorcycles takes full advantage of the "trench" and the great volume of the exhibition hall in the "big box."

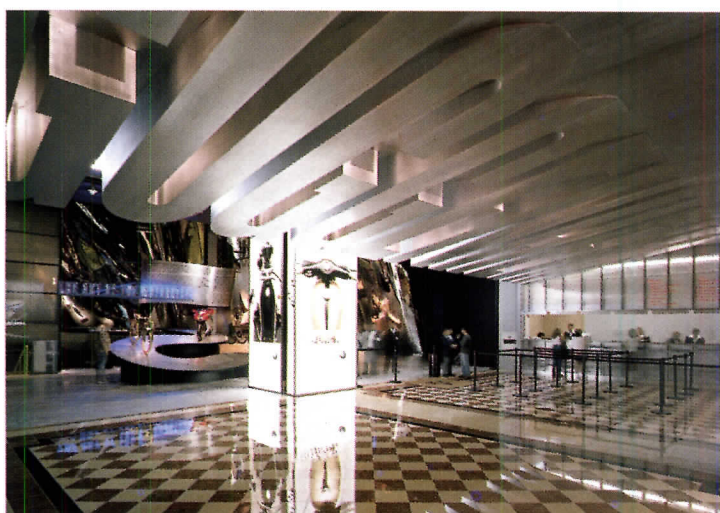

Tucked behind the casino floor, the entry to the Guggenheim Las Vegas (left) announces a radical shift in style. In the gallery spaces (above), an industrial aesthetic keeps the feeling informal.

foot-by-30-foot “trench” that serves as a lower level for displaying art. Metal grates and glass floor panels can cover all or part of the trench to add floor space to the main level while retaining views to below. Koolhaas used concrete floors, gray steel, and mirrored surfaces to establish a neutral backdrop for displaying art, but injected a few moments of color: a lime-green stair down to the trench, a mustard-yellow gallery off the trench, and orange-and-black chevrons on the mega-door. The result is

a giant container for art, a brash kind of place where there’s no need to worry about keeping your voice down or being dressed properly.

“In the past, entertainment had no need for architecture and architecture had no desire to entertain,” says Koolhaas. Referring to the two Guggenheims in Las Vegas, he states, “An entirely new architecture has been generated here. It’s high and low. It creates a continuous field where separations are no longer necessary or possible.” Okay, he overstates his case. The project may not really break new ground architecturally, but it has the right amount of swagger and elan to feel just right for Vegas. And not many star architects could pull that off. ■

Sources

Structural steel (for “big box”):

SME Steel Fabricators

Operable roof shutter components:

Hamilton Engineering

Clerestory glass: *Medco*

Skylight glass: *Alpen*

Acoustical ceilings: *Ceilings Plus*

Structural steel and Cor-Ten panels (for “jewel box”): *Vegas Steel*

Rotating wall mechanism: *Ederer*

Cor-Ten finishing: *Mark Quinlan*

and Zahner Architectural Metals

Wood ceilings, floors, cabinets:

Northwestern Architectural Woodwork

WWW For more information on the people and products involved in this project, go to *Projects at www.architecturalrecord.com*

Petersburg, Koolhaas helped develop an innovative system of powerful magnets that hold Picassos, Cézannes, and Renoirs in place directly on the richly hued metal walls.

The architects also proved to be imaginative working with the existing building’s giant structural members, turning three 4-foot-square columns into masts from which Cor-Ten partitions are hung like giant metal sails. Indeed, the three partitions can each rotate 90 degrees to change the spatial configuration of the gallery.

While the Hermitage Guggenheim provides an intimate setting for paintings and sculpture, the Guggenheim Las Vegas offers a grandly scaled space (210 feet long, 160 feet wide, and 70 feet high) for displaying large contemporary art (think Serra or Whiteread or Twombly). A steel-frame structure set between the hotel and a 9-story parking garage, the “big box” features a few movable parts: a crane that runs along a steel roof beam and can hoist a 35-ton sculpture, a 70-foot-by-70-foot “mega-door” that pivots open, and a pair of metal roof panels 125 feet long and 36 feet wide that will be printed with a facsimile of the Sistine Chapel ceiling and can adjust the amount of daylight above a fixed skylight. (When the museum opened in October, the panels hadn’t been imprinted yet, so a fabric scrim with the image was used as a temporary device.)

Slicing through the middle of the gallery’s main floor is a 210-

Frank Gehry's design for the motorcycle show employs a dazzling variety of reflective and translucent materials. Metal-link curtains alternate with curving walls clad in sheets of stainless steel to create separate display areas.

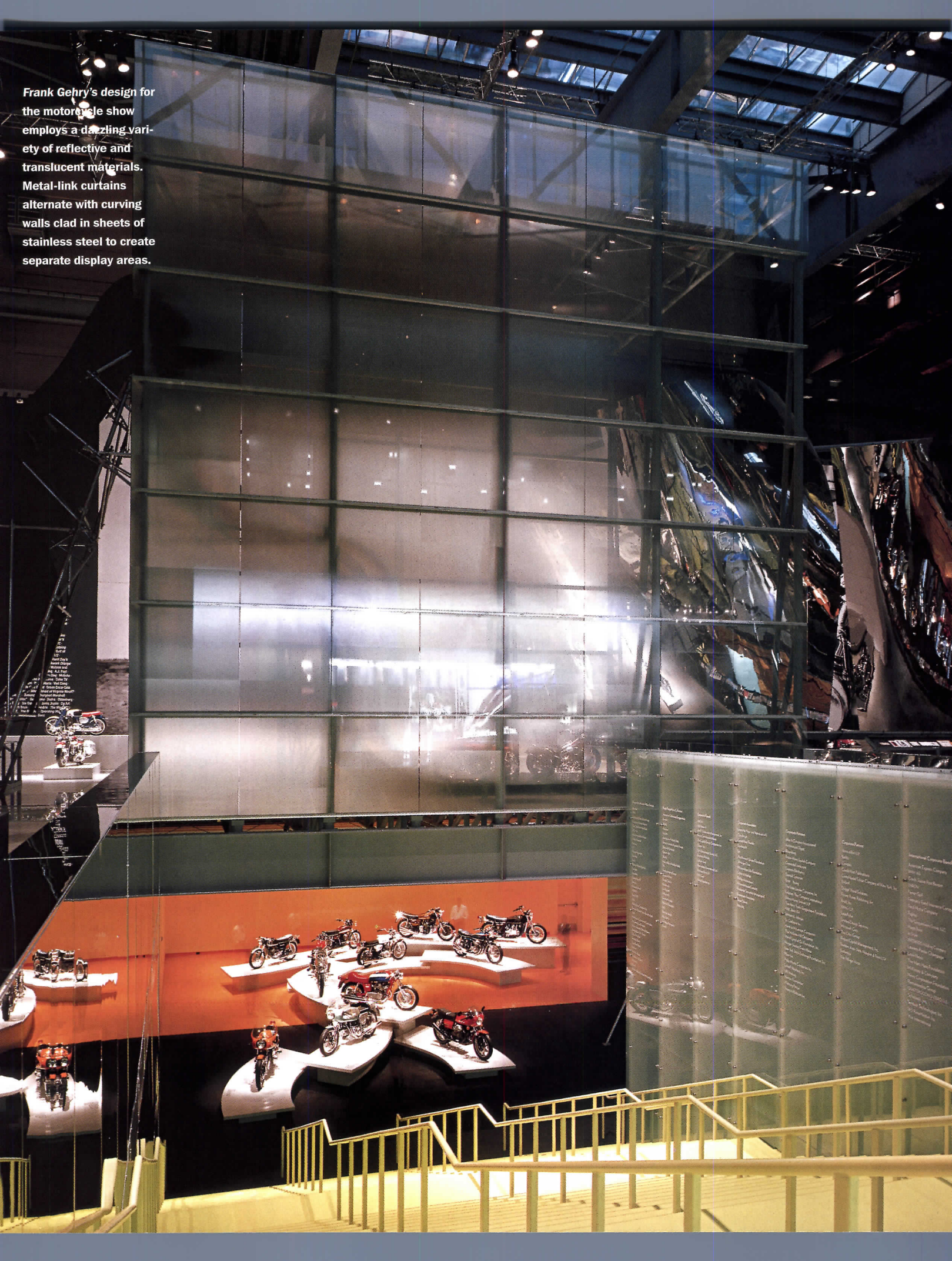



Vulcraft 176-foot longspan double-pitched steel joists with arched bottom chords and 3" acoustical deck span the Carleton College Recreation Center.

TRANSPORTATION

Bullet Train Bailout

A NEW GENERATION OF HIGH-TECH PASSENGER TRAINS MAY RESCUE BELEAGUERED AIRLINES, OPENING A NEW ERA OF INTERMODAL-TRANSPORTATION-FACILITY DESIGN.



1.

New York City

Skidmore Owings & Merrill's Terminal 4 anticipates evolving security concerns in an architectural environment of reassurance.



2.

Frankfurt, Germany

Bothe Richter Tehrani gives space-age form to a roadway-straddling, high-speed, air-to-rail station.



3.

Portland, Oregon

Zimmer Gunsul Frasca's glass-covered departure-curb canopy welcomes passengers to an expanded Portland International Airport.

By James S. Russell, AIA

When travel plunged after last September's terror attacks, the government pledged billions in loan guarantees, but these may not be enough to bail out airlines that were already suffering from slackening demand. Air travel's savior, ironically, may prove to be an old competitor—passenger rail.

With fewer flights and longer and more invasive security procedures, short-haul flights have lost a considerable amount of their appeal, especially for business travelers hoping for one-day turnarounds for meetings or conferences. Suddenly, networking major airports with rail service between major cities, especially if it can reach speeds comparable to the best French, German, and Japanese trains, has moved much higher on the agenda of airport authorities, politicians, and even airlines.

Skeptics tend to describe rail as a nineteenth-century technology that has little to offer the personal-mobility-obsessed twenty-first. But new technology is transforming train and track design, making it possible to move trains faster on existing rights of way, while attaining record speeds in dedicated corridors with emerging traction technologies like magnetic levitation.

While a few lovingly restored golden-age gems still serve intercity rail passengers, Amtrak often delivers passengers to humble prefab huts in forsaken parts of town. Outside the U.S., where high-speed trains and multimodal transportation options are better established, architects and engineers are collaborating on spectacularly innovative multimodal centers. The diaphanous glass enclosure designed by Paul Andreu at Paris's Charles de Gaulle [RECORD, January 1996, page 76] anticipated Bothe Richter Tehrani's bubbled high-speed rail station at Frankfurt Airport (page 120). Santiago Calatrava gave romantically winglike form to Satolas Station, the high-speed airport rail station near Lyon [RECORD, July 2000, page 85].

Commuter-rail access is becoming more common in America, however: Chicago (O'Hare); San Francisco; Atlanta; Washington; Philadelphia; Cleveland; and Portland, Oregon, have, or are planning, local rail connections. But cities elsewhere tend to make more of them in terms of design, and to exploit their potential in terms of economic development. In projects like the 15-minute Heathrow Express to Paddington Station or the 45-minute Stansted Express to Oxford Street Station—both serving London—the airport rail stations offer an impressive and easy-to-navigate welcome, while their in-town destinations augment conventional visitor services with retail, commercial, and entertainment venues intended to revitalize once-dreary precincts. Hiroshi Hara's Kyoto Station (1997), a dizzying, multilevel circus of space frames and escala-

For additional transportation projects, go to Building Types Study at architecturalrecord.com. The monthly expanded Web BTS features project descriptions, photographs, drawings, statistics, and links to people and products.

tors, is now that city's largest commercial development. Offices and retail make up a large part of Von Gerkan Marg & Partners's megastation rising in Berlin. Developers have spotted the potential of Skidmore, Owings & Merrill's plans to revitalize New York's Penn Station [RECORD, March 2000, page 68] and intend to erect up to 20 million square feet of offices, hotels, and sports facilities nearby. (These and many other projects can be viewed at *Modern Trains and Splendid Stations*, an exhibition at the Art Institute of Chicago, through July, or in the catalog by Martha Thorne.)

Unclogging airports

Here's why the outlook for intercity rail is brightening in the U.S.: If you have to arrive two hours ahead of your hour-long flight's departure, and then drive for half an hour or so on either end, suddenly Amtrak's fastest trains become time competitive, and fares can be lower because trains are cheaper to run.

But there are other reasons that airports nationwide are connecting themselves to rail. "Getting people to the airport is the number one design issue," says Robert Davidson, the chief architect at the Port Authority of New York and New Jersey. He was speaking not just of the general urban traffic congestion that strangles cities and airports everywhere, but the curbside congestion generated by passenger drop-offs (see Portland's solution, page 124), and the huge sums airports spend on parking and parking structures. The Authority runs the New York area's three major airports and has just opened a station that links Newark Airport's three terminals by monorail to the northeast rail corridor that serves both long-distance travelers and commuters (opposite).

According to Matthew Coogan, a transportation consultant in White River Junction, Vermont, who has made airport access a specialty, "Zurich is increasing airside gate capacity by about 50 percent, but they are not increasing curb capacity at all." The growth in passengers will be entirely taken up by a vast underground train station designed by



French railway's SNCF architects designed the Arbois TGV Station as a low-lying gateway to the Aix-en-Provence region.

Nicholas Grimshaw & Partners.

But rail-to-air connections also looked promising before September 11 because replacing takeoffs and landings at overcrowded airports with train service can be much less expensive for airports and airlines alike. For airlines, short-haul flights are hard on airplanes and often unprofitable. So Continental Airlines now supplies passengers from Amtrak's northeast corridor—Philadelphia, for instance, 80 miles south—to its long-haul Newark flights. "Relying more on rail for close-proximity flying frees up slots for the long-haul flights that customers demand," explains David Kinzelman, who is director of alliances at Continental Airlines. In 2003, city and suburban commuters on the Long Island Railroad will be able to reach traffic-strangled JFK Airport through a new AirTrain connection—already built into the new Terminal 4 (page 114).

Right now, Newark is the only American airport to have direct intercity and commuter-rail access, but Baltimore-Washington has long had a van connection to Amtrak's northeast corridor. It will probably be upgraded with a new light-rail connection. T.F. Greene, in Providence, is also working with Amtrak on a rail-to-air stop that could help make it Boston's second airport. Similarly, Milwaukee seeks to become the long-dreamed-of third "Chicago" airport via Amtrak. Other candidate cities for intercity and local commuter rail include Burbank, California; Miami and Orlando, Florida; and Seattle. "It absolutely makes sense to replace as much of the short-haul air movement with the efficiency of rail," says Coogan. He says the terror attacks of September 11, which shut airports nationwide for three days, showed how little redundancy the nation's transportation system has. "A project like Newark gives passengers more options," he says. "You put yourself in a better position to deal with uncertainty and unplanned events," including weather delays or traffic-control snafus.

How fast? How far?

Many analysts see air-rail connections as an untapped market that makes high-speed rail a dream that should no longer be deferred in America. "Intercity rail, if fully embraced and



Light-filled glazed stairways and new platform roofs, designed by Otak, greet commuters on the Puget Sound region's new commuter-rail system at Seattle's King Street Station, which is shared with Amtrak.

developed, will be effective in reducing airway and highway congestion, especially if it focuses on the development of markets from 300 to 600 miles apart,” says Warren Flateau, a spokesman for the Federal Railroad Administration. He says 40 percent of all air trips fall in this category. The competitiveness of rail depends not just on top speed, but whether equipment can travel at high speed over a long distance. The 125 mph sustained speeds on Amtrak’s popular 230-mile New York-to-Washington service are the fastest in the nation, but they are competitive with air only because roadways and airports are so congested and air-shuttle service (halved since September 11) is so costly. Cities much more than 300 miles apart can’t be thought viable, say experts, without the best Japanese or French rail technology now available, allowing speeds of from 150 to nearly 200 mph.

The ideal candidates are large metropolitan areas, at least one of which has a major hub airport, and a few other high-volume corridors. Suggested city pairs include Los Angeles to San Diego and Las Vegas; Chicago to Detroit; Detroit to Indianapolis, Cleveland, Columbus, Ohio, and Pittsburgh; Dallas/Fort Worth to Houston; Seattle to Portland, Oregon; St. Louis to Kansas City, Missouri; Orlando to Tampa and Miami, Florida.

Smaller cities along these trunk corridors, many of which suffer from poor air connections, could also benefit. Coogan says he’s advised Continental to solicit Newark business by rail from Bridgeport and Stamford—two of the largest Connecticut cities that must otherwise access airports via dozens of miles of congested I-95.

But there are a number of reasons that air-to-rail integration has been slow. American government policy treats each travel mode differently, subsidizes each in different ways, and lacks an overarching strategy about what each mode should do or how they should work together. In most countries, moving people from planes and cars to rail is an explicit policy, supported by subsidy allocations. But most rails in America are in private hands, while cities tend to own airports, and states build and own highways. Freight-rail networks have hardly expanded in decades, for example, even as business has grown, because private railroads can’t match vast state and federal investments in competing roads. Indeed,



Travelers using New Jersey Transit or Amtrak can access Newark International Airport’s three terminals via monorail at this new station designed by the Port Authority of New York and New Jersey.

freight-line business is growing for the same reason as passenger utilization: Roads are too congested. But commuter-rail agencies want to run more trains on the same tracks that freight companies want to run more trains on, and conflicts are growing.

And then there’s Amtrak. Defenders of Amtrak cite inadequate funding and Congressional meddling for the national rail agency’s poor performance. Others say it’s incapable of making high-speed rail work. “Lots of people want high-speed trains, but they don’t want Amtrak,” says Joseph Vranich, a consultant who has worked for the agency and served on

“GETTING PEOPLE TO THE AIRPORT IS THE NUMBER ONE FACILITY DESIGN ISSUE.” —ROBERT DAVIDSON, PANYNJ

a council intended to reform it. In *Derailed: What Went Wrong and What to Do About America’s Passenger Trains* (St. Martin’s Press, 1997), Vranich has compiled a 258-page indictment of 30 years of Amtrak’s management mistakes and broken promises.

Amtrak may be in for a restructuring, which may pave the way for a true high-speed rail network, but it’s one the General Accounting Office recently estimated will cost between \$50 and \$70 billion. It’s a lot of money, to be sure, but a fraction of what airline bailouts and security upgrades are likely to cost.

While the high-speed rail debate can be relegated to the realm of politics, perhaps it shouldn’t be. Today, there’s no clear concept of how multimodalism could work or how high-speed passenger rail fits in. A strikingly integrated vision was offered by Warren Manning, a landscape architect, that contains many of the elements transportation analysts would like to see: a nationwide system of commercial highways with dedicated freightways that feed a parallel freight-rail trunk-line system; of recreational roads that follow the nation’s geography; of high-tech means to switch between modes. Manning proposed his scheme in 1923. (For more, see Keller Easterling’s *Organization Space: Landscapes, Highways, and Houses in America*, MIT Press, 1999.) Maybe we need more Mannings now. ■



A jaunty, stainless-steel hat salutes passengers at the Expo Station on Singapore’s new city-to-airport rail line. The architect is Foster and Partners.

JFK Terminal 4

Queens, New York

I

SOM REPLACES ITS 1957 BUILDING WITH AN INTERNATIONAL TERMINAL BETTER SUITED TO THE EXIGENCIES OF TWENTY-FIRST-CENTURY AIR TRAVEL.

By Sarah Amelar

Architect: Skidmore, Owings & Merrill—David Childs, FAIA, Marilyn Taylor, FAIA, Anthony Vacchione, AIA, Carl Galisto, AIA, partners; Peter Ruggiero, AIA, senior designer; Paul Auguste, Robert Chicas, project managers; Frank Mrakovcic, Scott Yocom, Tatiana Kasnar, senior technical coordinators; Frank Ruggiero, field architect

Owner: JFK International Air Terminal (JFK/IAT)

Client: JFK/IAT: a joint venture of Schiphol Amsterdam, LCOR, and Lehman Brothers

Public partner: The Port Authority of New York and New Jersey

Interior designer: Jacquelyn Suozzi, Mary Delaney

Retail design: Communication Arts

Engineers: Arup (structural and MEP for main terminal); TAMS Consultants (MEP concourses); Arup/TAMS Consultants (civil)

Consultants: Judith Heinz Landscape Architecture (landscape); Susan Brady Lighting Design (lighting); Arup (acoustical and IT); Wendy Feuer (art); BNP (baggage)

General Contractor: Morse Diesel International

Size: 1,520,000 square feet

Cost: \$1.4 billion

WWW

For more transportation projects and more information on the people and products involved in this project, go to Building Types Study at www.architecturalrecord.com

Program

New York City's Idlewild Airport, later rechristened John F. Kennedy (JFK) International, embraced a romantic view of air travel. Built in the 1950's, and one of the first major commercial airports, it offered a vision of pavilionlike terminals set along a ring road in a scenic parkland. Its architectural language—epitomized by Eero Saarinen's sculptural TWA terminal and Skidmore Owings & Merrill (SOM)'s International Style International Arrivals Building—celebrated the Modern moment, but the designs naively failed to anticipate the industry's booming transformations. And so, by 1996, when SOM was commissioned to revisit its original JFK site and address the demands of late-twentieth- and early twenty-first-century air travel, its 1957 Arrivals Building had largely outlived its usefulness.

The growth from 100- to 400-passenger planes; the evolving security requirements first prompted by 1970s hijackings; and the huge increases in air traffic stimulated by airline deregulation had all compromised the logic and wayfinding clarity of SOM's 1957 scheme. No longer could a departing passenger see the airfield—the immediate destination—from a curbside entry point. Caught in a rabbit warren of checkpoints and windowless passageways, this terminal's fin-de-millennium traveler was often separated visually from the planes.

SOM had expanded the building modestly in the 1960s, but the terminal, like many of its era, embodied the notion that The Future had indeed arrived—and therefore it offered limited flexibility, with no clear plan for change or expansion.

The determination to replace it first emerged in the early 1980s with a master plan by I.M. Pei & Partners that essentially proposed to remake the airport. When that ambitious project was later scrapped, the Port Authority of New York and New Jersey, the government agency that operates JFK, chose a novel privatization method: Schiphol Amsterdam, operators of the Netherlands' major airport; LCOR, a developer; and Lehman Brothers, investment bankers, jointly formed a design-build-operate-manage consortium, called a DBOM, with the Port Authority as its public partner.

Engaged to design the new building, SOM was faced with the proviso of keeping the terminal—even as a composite of old and new—operational throughout the demolition and construction periods. The architect's challenge also included: 1) providing for flexibility and potential expansion; 2) increasing the number of contact gates from 14 to 16; 3) integrating a future light-rail system (to transport passengers from New York City and elsewhere in the airport) into the building; 4) introducing a 100,000-square-foot retail court and routing

passengers through it; 5) reestablishing clear circulation with a strong sense of the whole.

Staging the project to minimize passenger inconvenience and streamline construction efficiency was “a complex puzzle,” recalls the project's senior designer, Peter Ruggiero, AIA. To complicate matters, the siting was essentially dictated by the existing footprint, which could not be extended on the airfield side.

Solution

The architects, in effect, performed the old trick of yanking out the tablecloth from under the place settings. The carefully orchestrated three-and-a-half-year process involved building a loop of two roads, dedicated to the construction site and, later, to the terminal traffic; erecting a metal shed beside the old building to serve as a temporary arrivals hall; and demolishing existing elements in phases.

For the grand design gesture and spatial strategy, SOM partner Marilyn Taylor, FAIA, brought in lessons learned from Eero Saarinen's 1962 Dulles Airport, which SOM expanded in the early '90s. At Dulles, the continuous sweep of a catenary roof and open lines of sight to the tarmac “give a constant sense of where you've been and where you're going,” observes Ruggiero. Also, that terminal's modular structural system anticipated expansion. In a similar way, SOM, working closely with ARUP

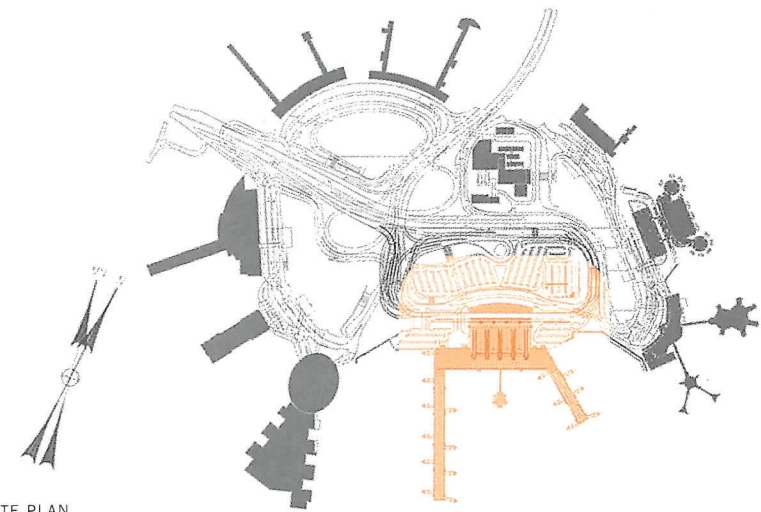

TE PLAN



At curbside (below), the arrivals area projects out beyond the departures hall and elevated road, allowing daylight into

the lower level. The departures hall's great curving roof is silhouetted against the skyline. The earlier control tower is by I.M. Pei.



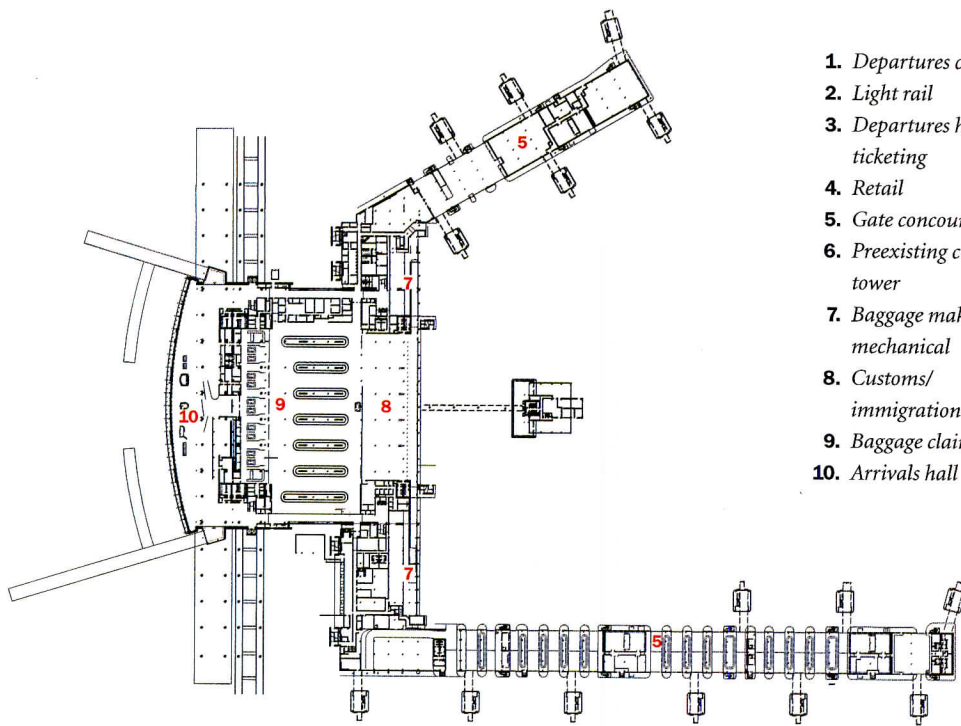

ARRIVAL LEVEL

1. Departures curb
2. Light rail
3. Departures hall/
ticketing
4. Retail
5. Gate concourse
6. Preexisting control
tower
7. Baggage make-up/
mechanical
8. Customs/
immigration
9. Baggage claim
10. Arrivals hall

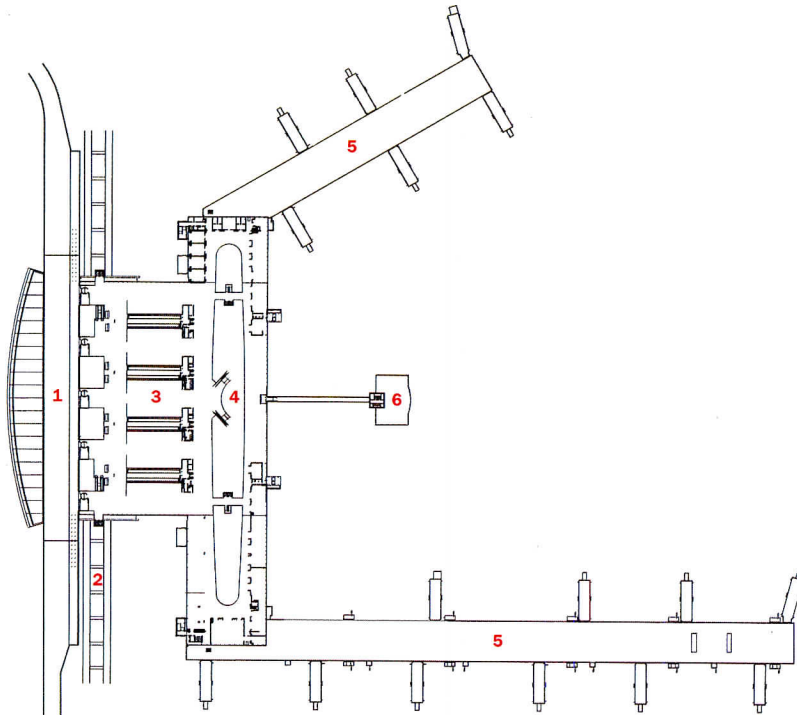

DEPARTURE LEVEL

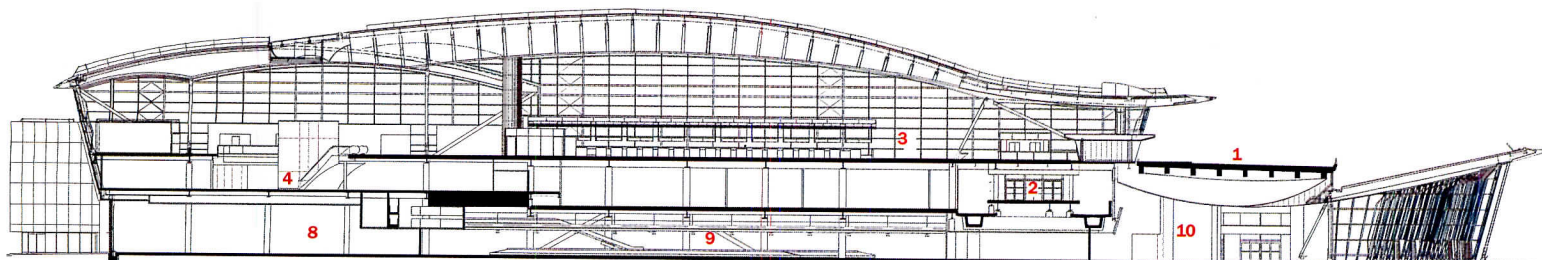

SECTION

engineers, created a great arcing roof as the terminal's iconic form. Lined in sheet aluminum, it recalls the taut, lightweight quality and articulated flaps of an airplane wing. It is supported by a modular, braced-frame structure erected perpendicular to the curbfront. Soaring over the departures hall and retail areas, the roof's 230-foot-span trusses extend several feet beyond the old terminal's arrival hall, allowing for complete structural independence between the existing building and the new one.

By fully glazing the curbside and airside facades, the architects restored immediacy between entry point and airfield.

Because selling space has become an integral and essential part of the program—and cash flow—of contemporary terminals, SOM provided 100,000 square feet for a retail zone, designed by Communications Arts. To avoid obstructing views to the airfield, the architects sank the retail space one level below the departures hall, but left it open to the great roof. SOM and ARUP also devised an open tripod column, instead of a bulkier member, to support the trusses. (With moveable joints, these tripods allow the roof to flex with snow and wind loads.) Reinforcing wayfinding, skylights mark major intersections and lines of circulation.

Generous spatial allotments between ticketing kiosks have accommodated the heightened security and longer check-ins prompted by last fall's terror attacks. Planned well before September 11, the terminal and concourse entry zones similarly allow for added screening points and devices.

"But on the arrivals level, as on the departures level," says Taylor, "we wanted the experience to be



Skylights in the roof (far left) reinforce major lines of circulation. The food court, one flight below the departures level, is open to the bowed, unifying roof (left). The truss, formed by a series of tripod supports, meets the roof with moveable joints that flex with snow and wind loads.





The arts program includes a newly restored Calder mobile (above and opposite, bottom) that was commissioned for the original 1957 terminal, and a sequential piece by Diller + Scofidio in the “sterile” arrivals corridor (right).



dignified, welcoming, and exciting—instead of the more typical American way of bringing arriving passengers through endless corridors, only to emerge at a curb on the underside of an elevated road.” On the curbside, the architects projected the arrivals area out from under the departures roadway, taking advantage of the fact that international arrivals—with immigration and customs, in addition to baggage—typically demand more space than the corresponding departures. Open to daylight and views, the curved and canted facade of the arrivals hall is fully glazed—as are the exterior walls of the the gate concourses that look out onto the airfield.

The interior is also enlivened by an arts program, including a sequential piece by architects Diller + Scofidio that unfurls a visual narrative as travelers proceed along a “sterile” (controlled) corridor from arrival gates to immigration. An Alexander Calder mobile—evoking loft and motion—from the 1957 terminal was restored and placed prominently in the new departures hall.

Commentary

The departures hall successfully brings back the exhilaration and elegance of early air terminals. It also gives clarity and continuity to the journey from curb to gate.

Clearly, SOM had to make tough decisions about how to allot the budget and what to emphasize. The gate concourses and much of the arrivals level are less remarkable than the departures hall. Beige plastic-laminate wall panels lining many arrivals zones are a bit drab, as are the utilitarian, relatively low-ceilinged gate concourses. “But,” explains Ruggiero, “the character of the gate areas is quite intentional. Americans tend to go right to the gates and often stay there—but Schiphol’s mandate was to get the passengers to spend time in the retail area.”

The bottom line: The terminal of the twenty-first century must be economically viable in ways never imagined in earlier eras—but, as SOM has shown, it can still celebrate the original spirit of air travel. ■



SOM did not design the food court itself (left) but carved out the space for it. The great headhouse roof (below) follows an expandable module, as do the check-in kiosks beneath it.



ICE Station Frankfurt, Germany

2

BOTHE RICHTER TEHRANI GIVES SPACE-AGE FORM TO A ROADWAY-STRADDLING HIGH-SPEED AIR-RAIL STATION.

By James S. Russell, AIA

Architect: *Bothe Richter Tehrani—Jens Bothe, partner in charge; Berthold Staber, Christian Feck, Lutz Gnosa, Frank Görge, Michael Horn, Wolfgang Labsch-Boga, Katja Pahl, Ali Pakrooh, Monika Pfretzshner, Claudia Springmeier, Peer Weiss, Christopher Wilford, Arndt Woelke, Katrin Koulouri, Irene Manhardt, Ulf Schröder, Jürgen Wilhem, design team*

Client: *Deutsche Bahn, AG*

Engineers: *Dr. Ing. Binnewies (structural); HL-Technik (mechanical)*

Developer: *Deutsche Bahn*

Size: *380,000 square feet*

Completion date: *1999*

Sources

Glass and glass-support system for station roof: *MERO Systems; Seele GmbH & Co.; Josef Gartner & Co.; Magnus Müller*

Elevators and enclosures: *Otis*

Lighting: *SELUX; NORKA; BEGA; Siteco; WILA; Zumtobel Staff*

Furniture: *architect designed, manufactured by Signature Stadtmobilia; System De Lucci*

WWW

For more transportation projects and more information on the people and products involved in this project, go to Building Types Study at www.architecturalrecord.com

Program

Architect Bothe Richter Tehrani (BRT) found itself with a particularly unenviable site for a high-speed rail station at the edge of Frankfurt airport: a thin strip of land between a major freeway and highway ramps serving the airport, separated from the main terminal complex by a hotel and office-building development constructed years before (site plan, opposite). Deutsche Bahn (the national railroad) hoped to finance the project in part by adding income-producing uses, but they were scheduled for a subsequent phase. Still, BRT's station had to be built as a platform for the addition of about 180,000 square feet of undetermined uses without disturbing train or station operations.

The station is part of what transportation consultant Matthew Coogan calls the most aggressive air-rail integration strategy he has yet seen. Frankfurt, one of Europe's largest gateway airports, would rather use its limited capacity to serve large long-haul planes than small planes making short hops. Once the high-speed system is completed, Lufthansa has agreed to drop all its short-haul flights from Dusseldorf and Cologne (and eventually other destinations) in favor of trains.

Solution

The 212-foot-long, four-track station has been sized to eventually serve nine million passengers annually.

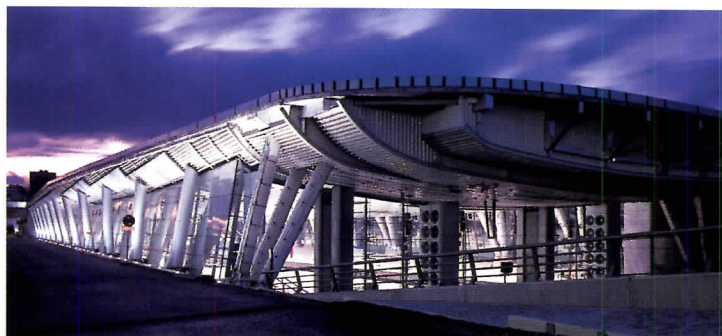

The two rows of splayed, paired columns at platform level are beefy enough to hold up the later addition of commercial space as well as massive trusses largely concealed within the metal cladding of the hull-shaped ticketing level. By spanning the full width of tracks, the trusses leave the platforms column free.

The column pairs are spaced relatively far apart along the long sides of the station, because "the main goal was always to have daylight on the platform level," said Jens

Bothe, the architect's partner in charge. The designers also carved a large oval opening to let upper-level daylight down to the center of the platform level.

The architect "enclosed" the platform level with glass along the long sides and a curtain of air that trains pass through at the short sides. This minimally air-conditions the train platform—a first in Germany—introducing an airport-quality passenger experience. The glazing also reduces noise from the

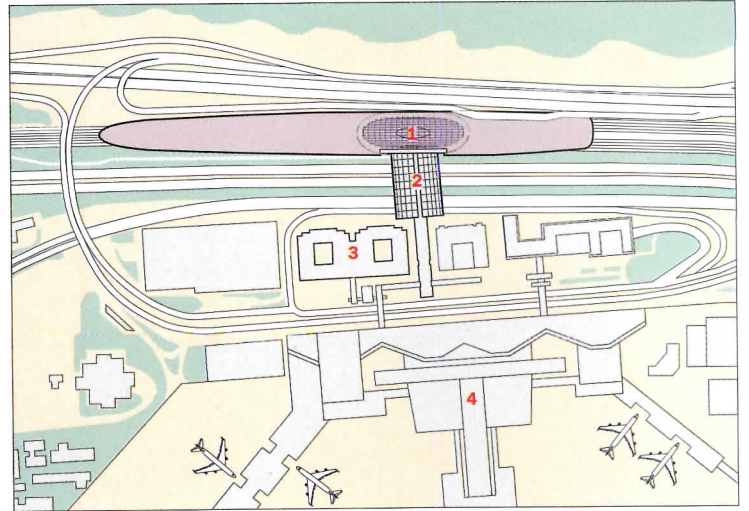

An oval, metal-clad section of the station spans a highway with ticketing and retail (opposite, top). Beefy pairs of columns (above and opposite,

bottom) support massive trusses so that the platform can be column free. The oval opening draws daylight from the glass roof above.

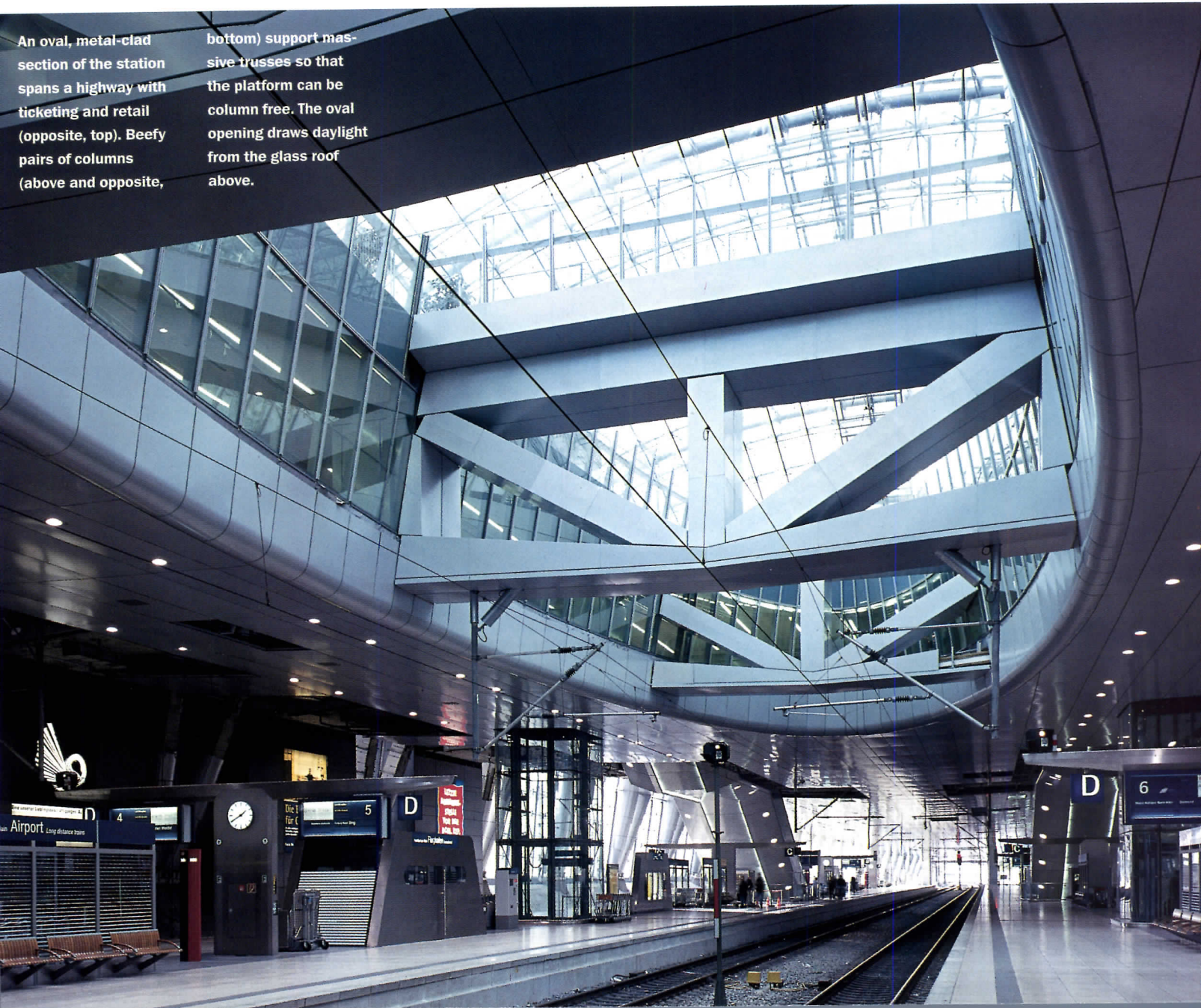

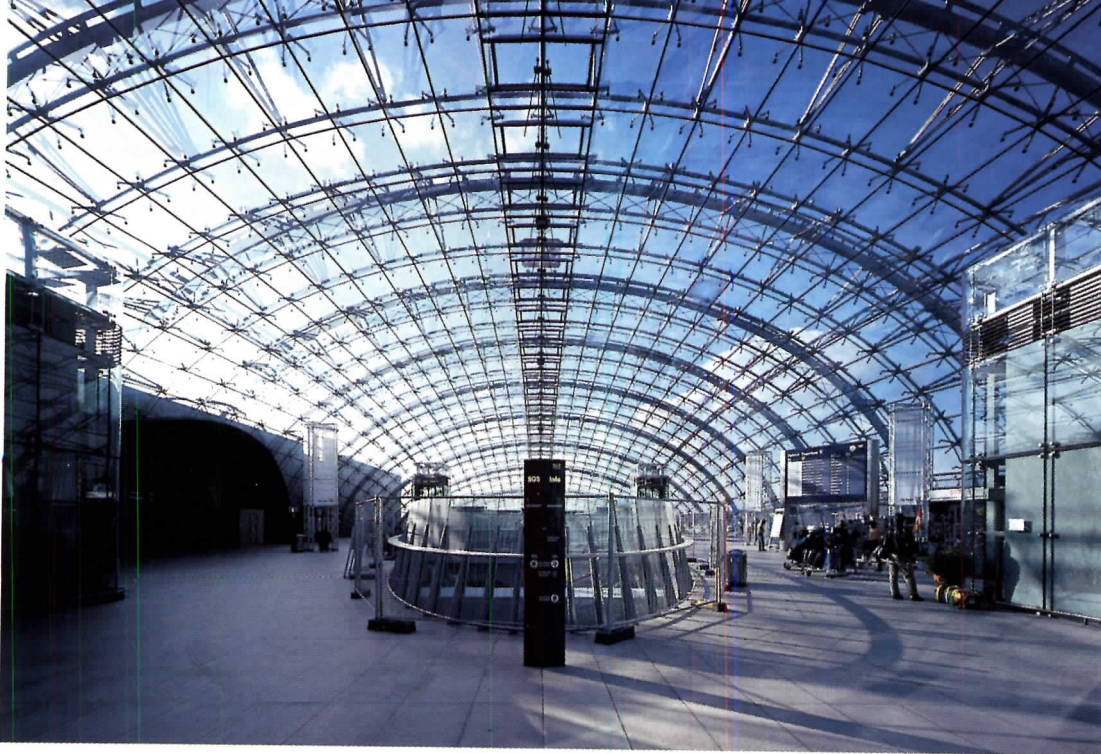

surrounding motorways.

As passengers rise to the ticketing level, they find themselves in a veil-like bubble of glass. The two-layered glass panels are specially treated to offer shading and reduce solar-heat gain. A ribbon of clear glass at the highest point of the vault contains some operable units to vent accumulated hot air. Unconditioned fresh air is supplied at the base. Bothe says the temperature of the space rises no more than 2.5 degrees Celsius above that of the outside on hot days.

BRT's bubble will disappear once the second phase is constructed, replaced by a domed skylight within a long seven- to nine-story extrusion that Bothe likens to a submarine.

A curved, metal-clad bridge conveys train users across the highway and accommodates a ticketing hall and some retail space. It leads through the commercial complex to another bridge, which plugs the facility into the main terminal.

Commentary

Joseph Vranich, a high-speed rail advocate and longtime critic of Amtrak, divides American rail proponents into two camps, the incrementalists and the visionaries. Frankfurt's ICE Station is clearly in the visionary mode. The 136-mile Cologne-to-Frankfurt trip takes about 55 minutes on the new trains, an average speed of close to 150 mph. (On Amtrak's fastest route, devised in the incrementalist mode, a similar distance—Philadelphia to Washington, D.C.—takes about an hour and 50 minutes.)

But the vision of the Deutsche Bahn leaders who commissioned the project, Heinz Durr and Martin Lepper, extended beyond getting the tracks in place. Marching down the highway median like a city-block-size centipede, the Frankfurt station speaks to the excitement travel may one day elicit again. Rising from the airy platform to the dramatic, light-bathed bubble offers passengers a visceral yet reassuring experience—one that's rare in air travel today. ■



Tubular ribs frame the ticketing-level bubble (above) from the exterior (right), supporting armatures that attach glass by bolt-through connections.



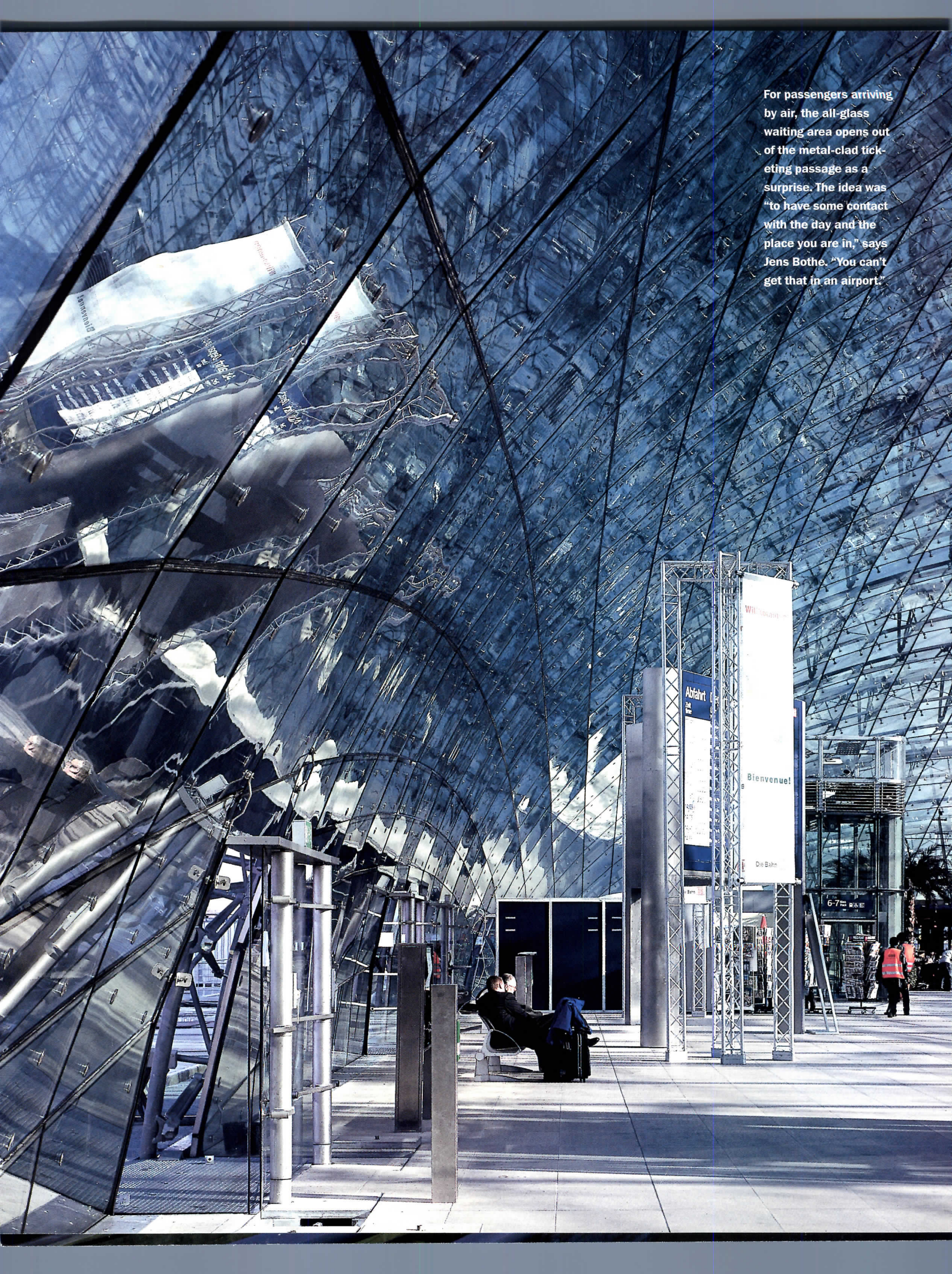

For passengers arriving by air, the all-glass waiting area opens out of the metal-clad ticketing passage as a surprise. The idea was "to have some contact with the day and the place you are in," says Jens Bothe. "You can't get that in an airport."

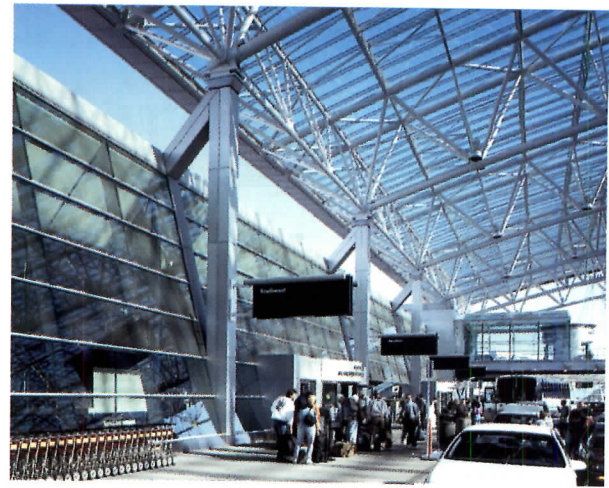
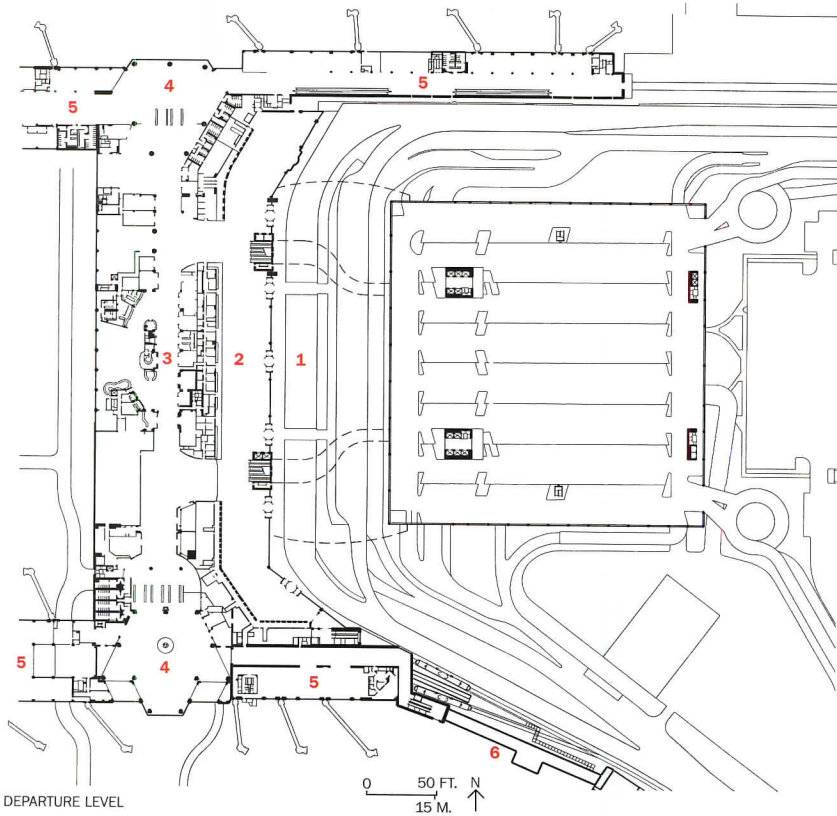

1. Drop-off
2. Ticket lobby
3. Retail
4. Concourse lobby
5. Concourse

The glass facade of the extended terminal echoes the slope of the canopy (above and below), which allows the interior to borrow light and a lacy network of shadows.



Above the curb, clusters of steel rods suspend two new pedestrian bridges that curve to align the circulation cores in the garage and terminal.

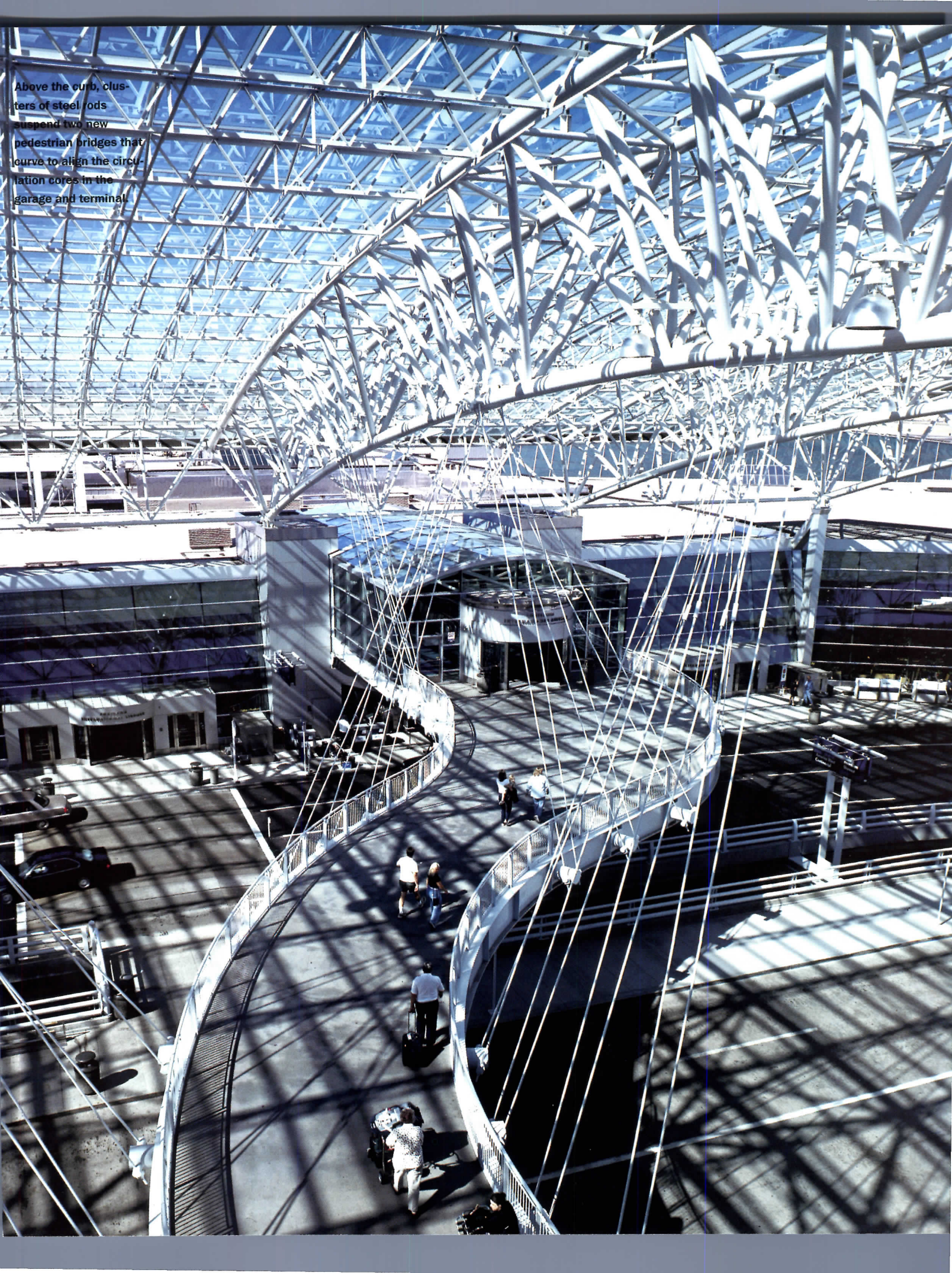

While strip skylights (below) draw daylight into the concourses, works by artist Larry Kirkland offer lively distraction. Striped poles (near right) are festooned with emblems of the region, and a tapering tower (far right) supports flight-information screens.



way to get people to use the outbound lanes was to protect them from rain, so we added a glass canopy," says Frasca. The 120,000-square-foot glass-and-steel structure also has created a "front porch"—the airport's new signature.

Under the canopy, circulation is segregated vertically, with arrivals and baggage at grade and enplaning traffic at a ticketing level one story up. The architects pushed the front wall of the terminal out 25 feet to create more room for circulation and ticket queuing inside. The existing garage grew four stories and was extended toward the terminal so that it could anchor the canopy. (Depending on how evolving security regulations play out, public use of spaces closest to the terminal building may be prohibited.)

Commentary

Unlike the generic spaces found in most airports, Portland's fosters a sense of place without relying on tired regional emblems or sacrificing legibility. The long concourses are punctuated with rows of tropical fig trees, and zippers of skylights make the most of natural light in an overcast climate. The Oregon Marketplace, in the main concession area, features local cuisine and specialty shops, offering the kind of local flavor that counts. Spaces within the airport are differentiated to provide visual relief as well as landmarks for wayfinding. Mid-concourse concession areas become indoor piazzas surrounded by coffee bars, newsstands, and art installations.

Rather than rely on hackneyed flight-related symbolism, ZGF's handling of the roof's three-point truss system is elegantly straightforward. It makes a bright spot out of the drop-off curbs—typically throwaway spaces promising a grim travel experience. Making the most of its greenhouse potential, oversize trellises on the face of the garage are heavily planted with Portland's official flower so pedestrians on the skybridges pass through blooming arbors into the City of Roses. ■



New Ways to Build Better, Faster, Cheaper

ARCHITECTS STEVE KIERAN AND JAMES TIMBERLAKE USE TECHNOLOGY TRANSFER TO REWRITE THE LAWS OF CONVENTIONAL WISDOM IN DESIGN AND CONSTRUCTION.

By Sara Hart

What is technology transfer? The term has been around for 30 years in the automotive and aerospace industries and, more recently, in university research quarters. In the broadest terms, technology transfer is the passing along of information, prototypes, processes, and inventions from one specialized industrial sector to another for the purpose of commercialization and dissemination to a larger consumer base.

Actually, technology transfer is an industry in and of itself. Most universities and their faculty benefit from royalties received when they license their inventions to manufacturers of everything from medical devices to home furnishings. At the Marshall Space Flight Center's Technology Transfer Department (www.nasasolutions.com), the National Aeronautics and Space Administration (NASA) has an entire program devoted to finding commercial applications for its inventions and innovations and publishes a journal called *Spinoff* (www.sti.nasa.gov/tto), which reports annually on those NASA technologies that have been successfully transferred to the private sector. The built environment has benefited a great deal from aerospace inventions, although most architects would be hard-pressed to name any. (See sidebar, page 138).

Historically, the architectural profession has been the passive recipient of innovation, because new methods and materials have flowed in only one direction: from inventor to manufacturer to designer. The profession's apparent indifference to innovation in other fields and the

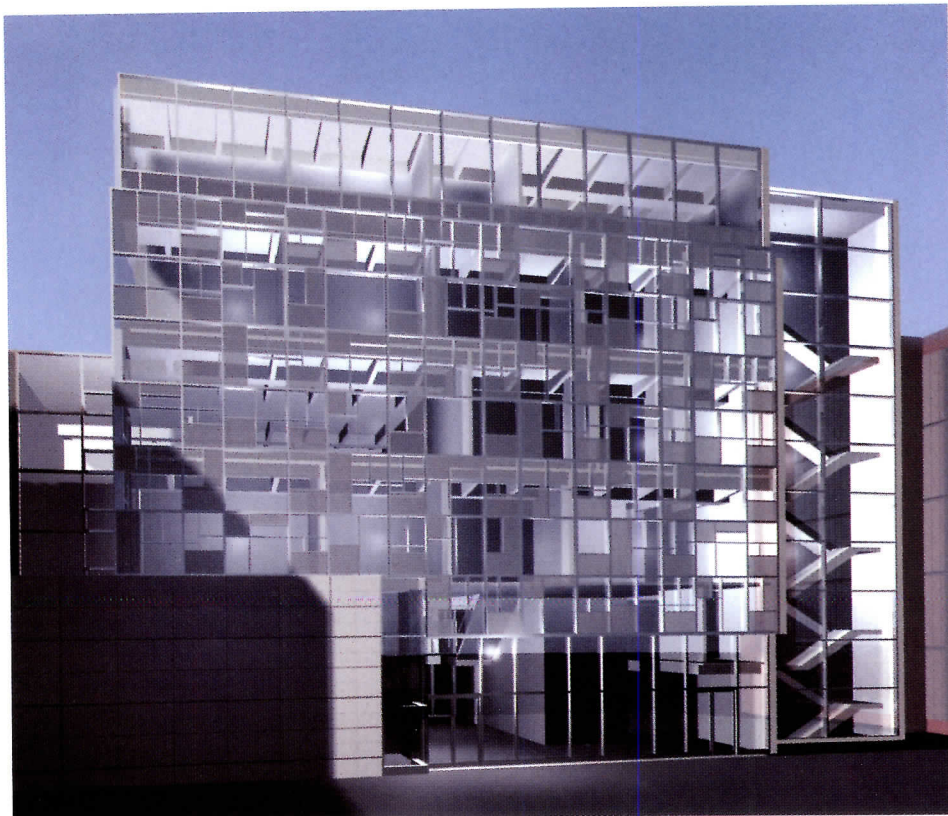

The facade for the Melvin and Claire Levine Hall at the University of Pennsylvania is a factory-made, pressure-equalized, double-glazed unit.

decentralized nature of the design and construction industries has hindered architects creatively and kept builders lagging decades behind other industries that manufacture products as well as provide services. Yet, there is recent evidence that practicing architects and even architecture students ["Weird Science in a New Age of Industry," *RECORD*, April 2001, p.163] are getting their hands dirty, at least figuratively, in the newly hip fields of materials science and product development. Specifically, two Philadelphia architects have embarked on an ambitious project to prove that buildings can be built faster, cheaper, and better by borrowing not just the materials but the processes from other industries. In their case, the role model is the automotive industry.

Architects with a mission

At the 2001 American Institute of Architects (AIA) National Convention in Denver, the College of Fellows of the AIA awarded its first Latrobe Fellowship to Philadelphia architects Stephen Kieran, FAIA, and James Timberlake, FAIA. The grant, named for the architect Benjamin Henry Latrobe, is awarded biennially for research leading to significant advances in the profession of architecture. As recipients of the inaugural award of \$50,000, the architects immediately aimed their research at the restrictive

CONTINUING EDUCATION



Use the following learning objectives to focus your study while reading this month's *ARCHITECTURAL RECORD*/AIA Continuing Education article. To receive credit, turn to page 138 and follow the instructions.

LEARNING OBJECTIVES

After reading this article, you should be able to:

1. Describe how technology transfer works.
2. Explain how technology transfer can benefit architecture.
3. Describe unitized construction.

WWW For this story and more continuing education, as well as links to sources, white papers, and products, go to www.architecturalrecord.com

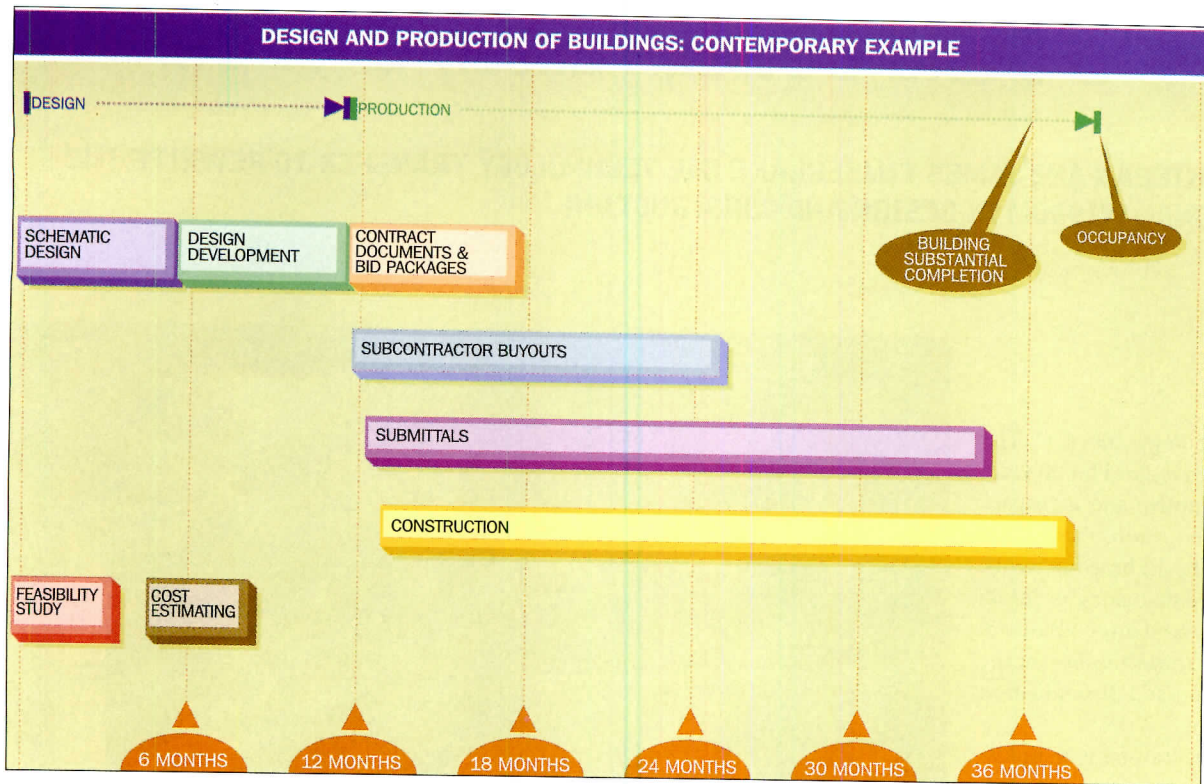

This chart (left) describes the linear process that governs the design and construction of most buildings. Almost all systems are constructed piece by piece in the field. By contrast, in a modular assembly system used by the automotive and aerospace industries (opposite, top), manufacturers use outsourced suppliers to assemble entire modules and deliver them to the factory (or building site) ready to be installed.

The front facade of Levine Hall at the University of Pennsylvania is a ventilated curtain wall system made up of factory-built panels (right and below). The panels arrive on-site fully glazed and finished. Installation is both fast and accurate.

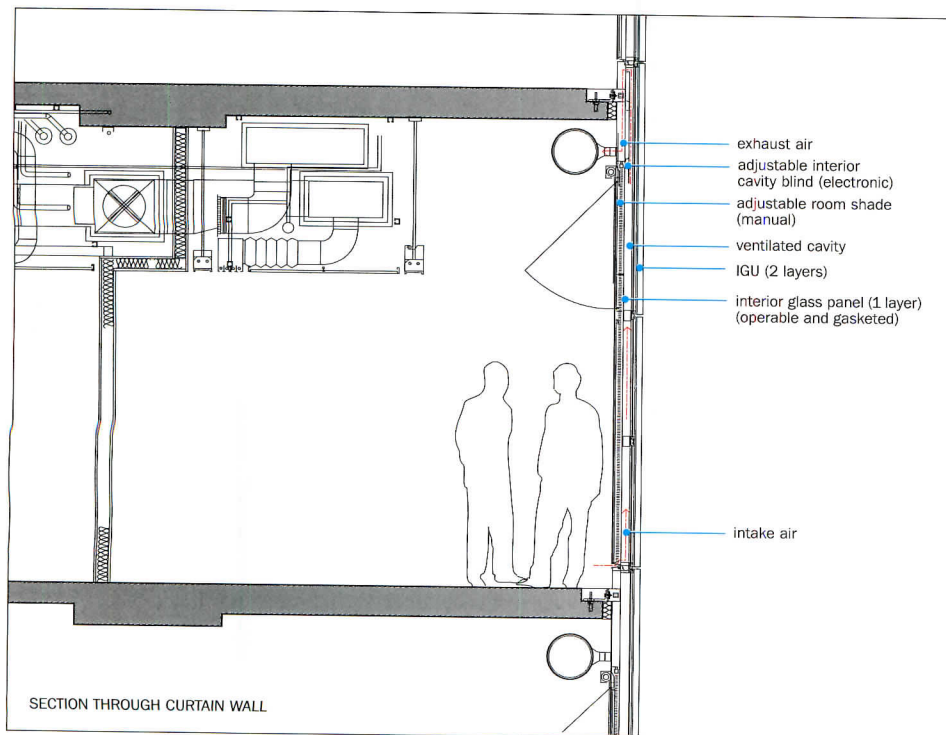
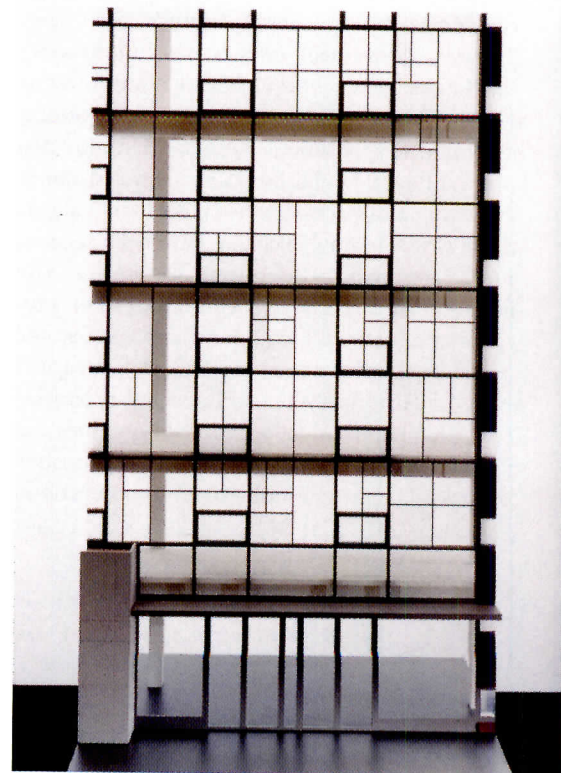

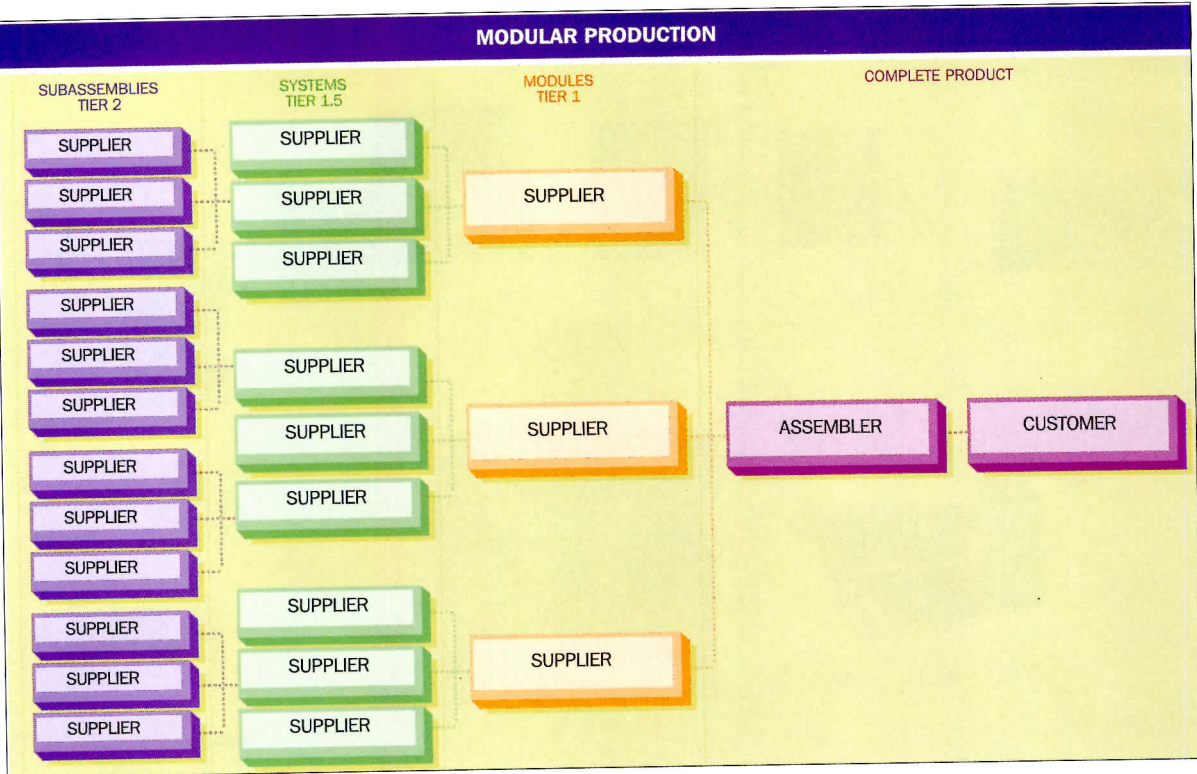

For the curtain wall at Levine Hall, Kieran Timberlake Architects chose a modular assembly system. In this particular case, the customer is the university; the assembler is the contractor; the Tier 1 supplier is Permasteelisa, the curtain-wall fabricator; Tier 1.5 suppliers provide the glass, the low-e coatings, and the aluminum extrusions; Tier 2 suppliers provide the interior and exterior coatings, blinds, hardware, and electronic controllers.

paradigms that have segregated the four major disciplines critical to the construction process—architecture, construction, materials science, and product engineering. One existing paradigm states that although innovation occurs within each discipline, historically there has been very little collaboration among them. Kieran and Timberlake envision a new model in which all four disciplines share a “collective intelligence.”

Since Henry Ford began mass production of the Model-T in 1907, his repetitive and fast assembly-line method has been improved on and mechanized, but the principle remained unchanged until recently. Timberlake, an automobile enthusiast who has researched the industry exhaustively, says that in the mid-1990s market forces pressured American automobile manufacturers to build cars faster and

SAVVY CLIENTS ARE LESS ACCEPTING OF THE CONVENTIONAL WISDOM THAT STATES THAT IT TAKES THREE TO FIVE YEARS TO PRODUCE A SUBSTANTIAL NEW BUILDING.

cheaper and, at the same time, to make them better. In short, with the extensive use of computer technology, the automotive industry responded with a modular system of production, whereby the role of suppliers changed from merely delivering parts to the factories to assembling collections of parts—such as doors, dashboards, and HVAC units—off-site and delivering them ready for installation on the assembly line. (See the chart on page 134)

This is no small innovation. Not only has this modular-assembly system produced better quality and allowed for customization, it has reduced the time from concept to release from 58 months a decade ago to 38 months today, and it has reduced labor costs by a third.

What does this have to do with constructing buildings? Plenty, according to Kieran and Timberlake, who have found parallels

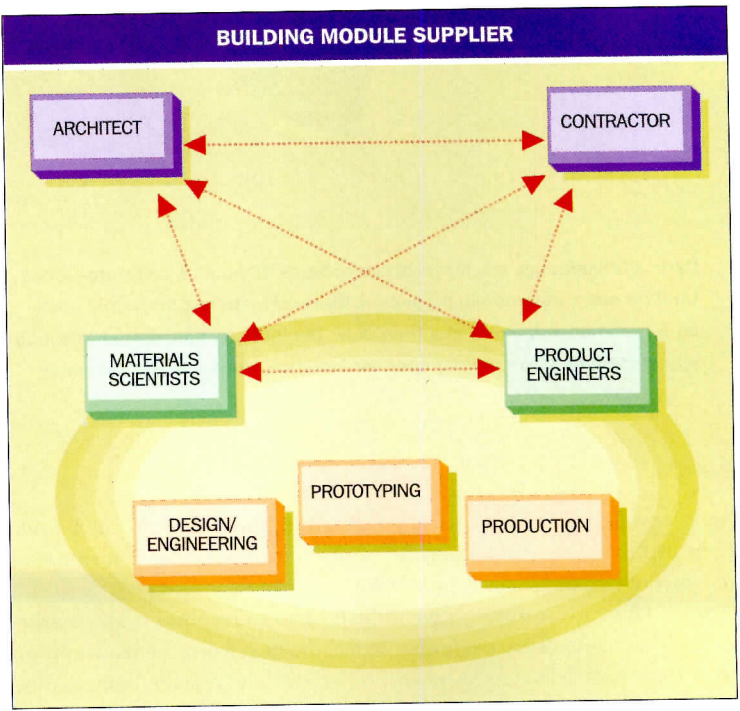

to the production of automobiles in the design and construction of buildings. In their Latrobe Fellowship proposal (www.latrobefellowship.com), they list the attributes shared by cars and buildings: “affordability, weather-tight construction, economical operation, durability over a reasonable period of time without major repairs, integrated mechanical and electrical systems, and an acceptable level of safety.” Building codes, site restrictions, and building-department approvals notwithstanding, the comparison is still convincing when one considers that buildings don’t have to travel safely at 60 miles per

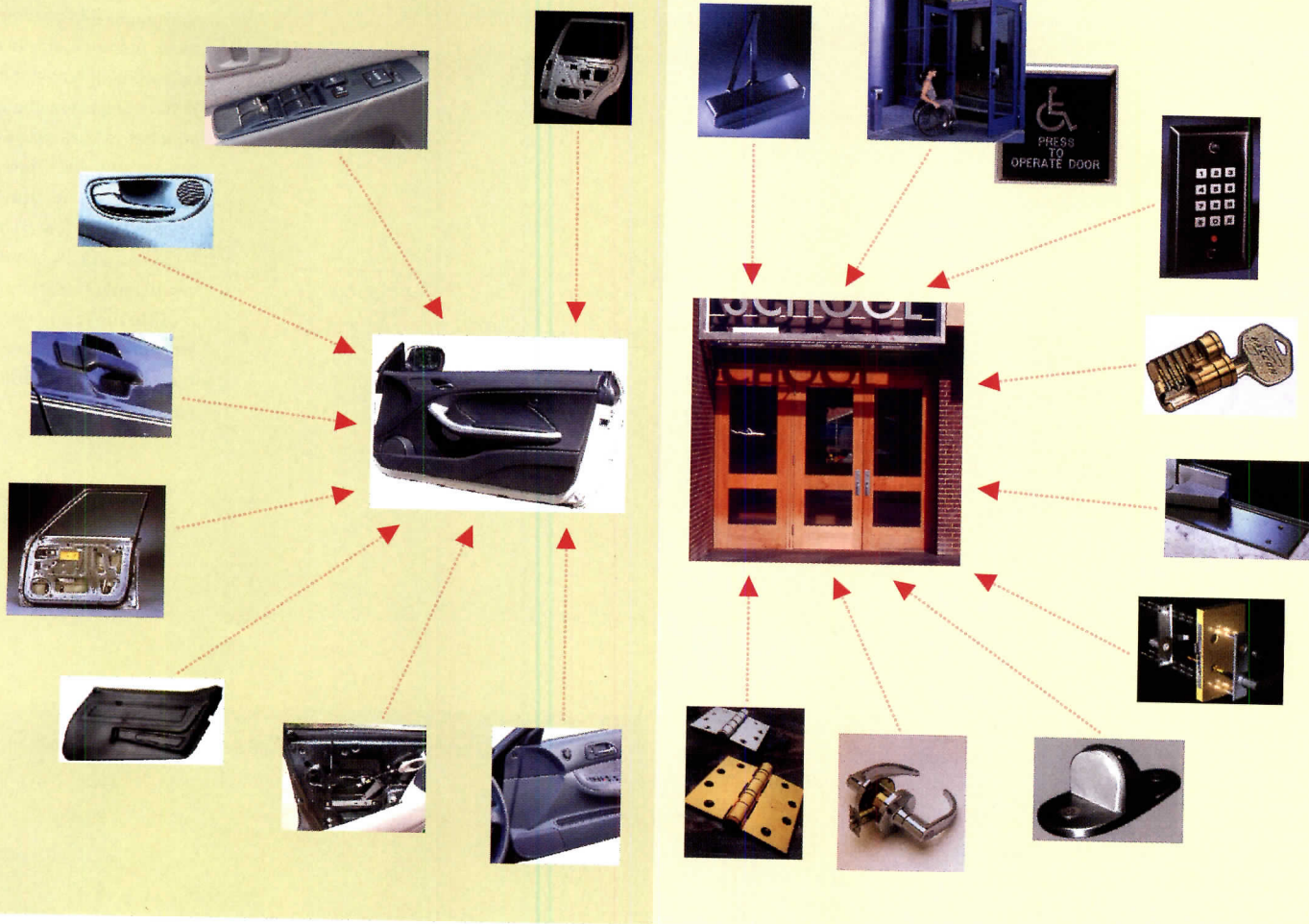

Cars, like buildings, are made of components of smaller, separate pieces. Until recently, automobile production involved installing individual parts on an assembly line one at a time. Now, the industry has shifted to a modular system in which the car door, for instance, arrives at the assembly

line outfitted with all its elements and ready to be plugged into the car body. Kieran and Timberlake's research suggests that building-door assemblies are programmatically similar to car doors and could be more efficiently produced by a module supplier off-site.

hour, and they don't have to be produced in quantities of 25,000 units to be profitable. And, like the automotive industry, a high percentage of the cost of construction is field labor.

Just as the automotive industry had to respond to the market or perish, architects are beginning to feel the heat from clients who want their buildings delivered faster without additional costs or compromise

KIERAN AND TIMBERLAKE ENVISION A NEW MODEL IN WHICH ALL DISCIPLINES SHARE A "COLLECTIVE INTELLIGENCE."

in quality. In the age of rapid production in almost every other industry, savvy clients are less accepting of the conventional wisdom that states that it takes three to five years to produce a substantial new building. They are also wary of the long-standing equation that quality times scope equals cost times time. In other words, they don't buy the concept

that complex, well-constructed buildings cost more money and take considerably longer to build.

Research into reality

Kieran and Timberlake's research is solid and their conclusions logical. Buildings, like cars, are made of components, which, in turn, are made of many smaller elements. If a car door can arrive at the factory completely outfitted with steel exterior, fabric interior, locks, speakers, glass, and controls, then why can't a building door arrive at the construction site with its hardware, automatic or mechanical closer, weather seals, security apparatus, exit light, alarm, and signage assembled? The same is true of other building elements, especially if they are considered systems, or in the language of Kieran and Timberlake, "modular building assemblies." To date, the architects have taken their research from a theoretical framework to a real building—the Melvin and Claire Levine Hall at the University of Pennsylvania. Currently under construction and expected to be com-



Tate & Snyder Architects, Henderson, NV

AIRPORTS TAKE OFF WITH WIDECK®

Boston, MA Fort Wayne, IN Las Vegas, NV Mascoutah, IL Midland, TX Newark, NJ Pittsburgh, PA San Francisco, CA

Long-Span Roof and Floor Deck Ceiling Systems

Millions of travelers experience Wideck in these airport terminals, where it provides:

- Long-spans from 10 to 45 feet
- Three Appearance Options
- Roof or Floor Deck
- Acoustical control
- Light Reflectivity

Specify an Epic Wideck Long-Span Roof and Floor Deck Ceiling System to create a unique visually open building design on your next project.

WIDECK EPA

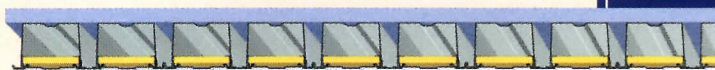

WIDECK WHFA



SUPER WIDECK SWA



EPIC®
METALS CORPORATION

11 Talbot Avenue, Rankin, PA 15104
CIRCLE 46 ON INQUIRY CARD

412-351-3913 phone

412-351-2018 fax

info@epicmetals.com

www.epicmetals.com

CURRENT MODEL

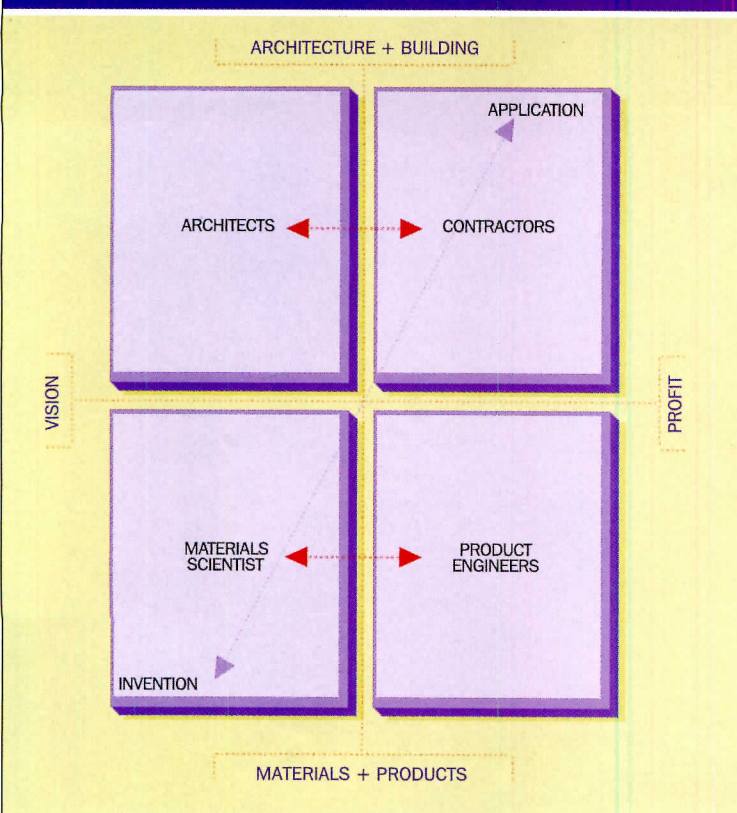

The diagram on the left shows how even in a design-build or fast-track project, the design and construction process is still achieved laterally. In their research, Kieran and Timberlake argue that there is a need for a more fluid process with more direct contributions from product

FUTURE

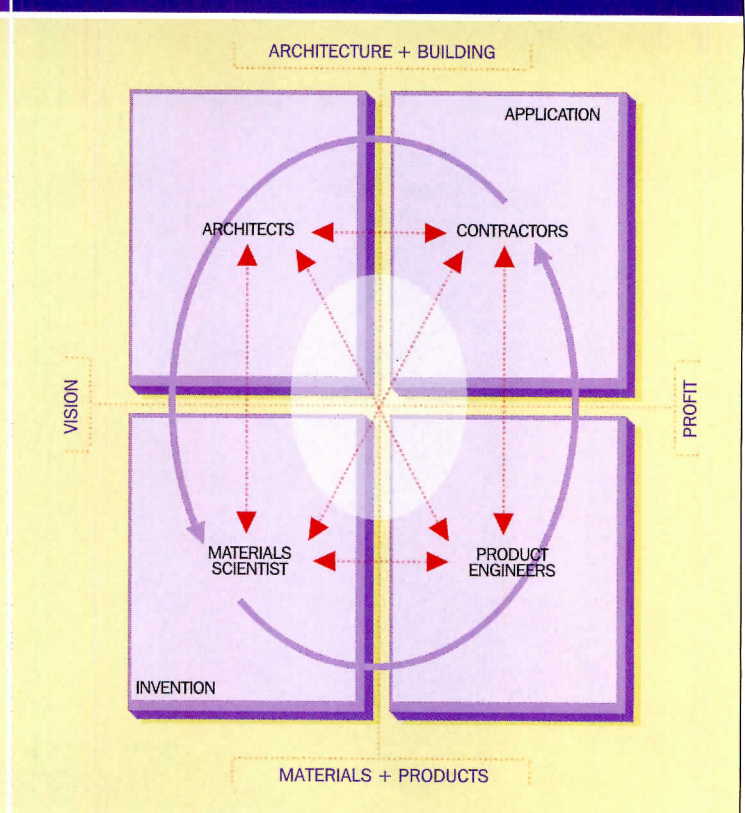

engineers, suppliers, and even materials scientists. The diagram on the right shows a more integrated design model in which the old equation of "quality times scope equals cost times time" would no longer be the operative paradigm.

pleted this spring, the 40,000-square-foot glazed pavilion will contain offices, laboratories, meeting rooms, and an auditorium for the School of Engineering and Applied Sciences.

While the structure and the floor plates are a conventional post-tensioned concrete system, the architects conceived the curtain wall as a modular building assembly. Their search for a fabricator who could achieve this led them out of the U.S. to the Permasteelisa Company in Veneto, Italy. (Permasteelisa fabricated the modular tita-

THE CURTAIN WALL IS COMPRISED OF PANELS THAT ARE ASSEMBLED IN THE FACTORY FROM SEPARATE COMPONENTS.

nium panels for Frank Gehry's Guggenheim Museum in Bilbao and the double-glazed curtain wall at Galeries Lafayette in Berlin by Jean Nouvel.) Like a car door, the Permasteelisa curtain wall is comprised of panels that are assembled in the factory of separate components—in this case, an external, pressure-equalized, double-glazed unit; an internal, single-glazed unit; and a mechanically ventilated cavity with continual air flow supplied by room air from an inlet at the base that exits through an outlet at the head of the glazing frame. Because fabrication in a controlled environment can be extremely precise and yield small tolerances, coordination of concrete pours, inserts, and attach-

ments with the base building is critical. Yet, the curtain wall drives the coordination. Permasteelisa provides full-scale shop drawings that show every component the company is providing as well as details of how the panels will interface with the structure. When completed, the panels will be shipped to Philadelphia and anchored to the structure.

Project architect Richard Maimon, AIA, identifies the curtain wall as "unitized construction" to differentiate it from the conventional "stick-built." "Unitized construction allows more work to be done at the shop, offering a higher level of quality and precision. Unitized, modularized, or componentized construction is a direct transfer from the automobile, aerospace, and shipbuilding industries," explains Maimon. The higher level of quality means that the joints are tighter, which means the risk of moisture penetration is lower, which, in turn, means reduced liability for the architect and contractor. The curtain wall at Levine Hall will have only four field joints, as opposed to dozens had it been stick-built, giving the architect reason to anticipate a short punch list.

The economic value of unitized construction must be reckoned in terms of first costs versus long-term costs. "When clients, such as institutions, weigh the value of the system over the life span of the building, unitized systems come out ahead," explains Timberlake. From an operational and energy-use perspective, the client can expect a 15 to 20 percent savings over the life of the building.

Tile & Stone Waterproofing & Anti-Fracture INSURANCE

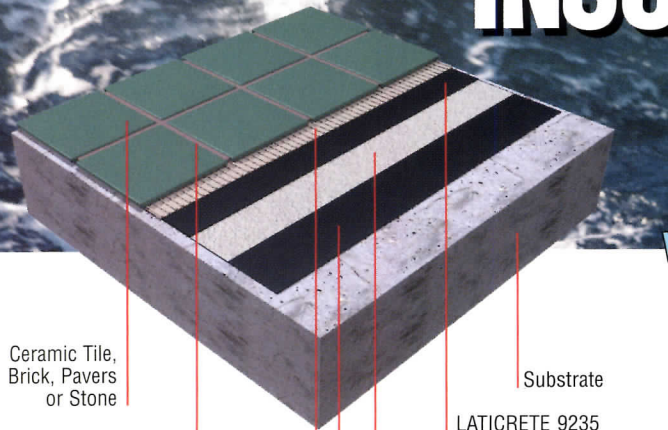

Ceramic Tile,
Brick, Pavers
or Stone

LATAPOXY® SP-100
Stainless Epoxy Grout

Substrate

LATICRETE 9235
Waterproofing Membrane

LATICRETE Reinforcing Fabric

LATICRETE 9235
Waterproofing Membrane Liquid

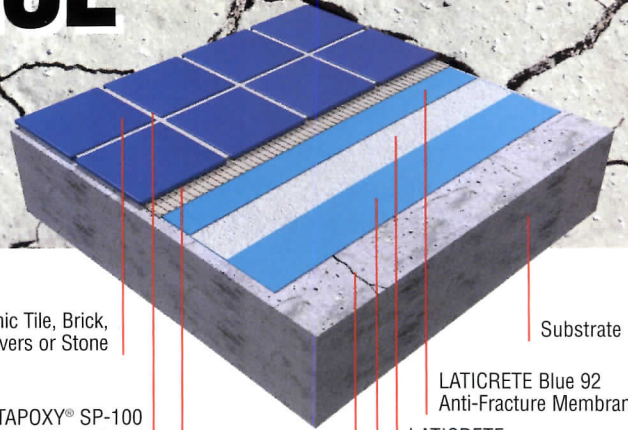

Ceramic Tile, Brick,
Pavers or Stone

LATAPOXY® SP-100
Stainless Epoxy Grout

Substrate

LATICRETE Blue 92
Anti-Fracture Membrane

LATICRETE
Reinforcing Fabric

LATICRETE Blue 92
Anti-Fracture Membrane

Non-Structural
Crack

A LATICRETE® Floor N'
Wall Thin-Set Mortar with
LATICRETE 333 Super
Flexible Additive

LATICRETE® 9235 Waterproofing Membrane "The Architects' Choice for RISK FREE Installations"

- Guaranteed not to leak or crack*
- Dual purpose – for waterproofing and anti-fracture applications
- IAPMO, ICBO approvals
- Meets rigid DIN standard for anti-fracture membranes
- Full fabric application
- Extra Heavy-Duty Floor Service Rating
- Approved for continuous submersion in pools and fountains

LATICRETE Blue 92 Anti-Fracture Membrane "When you only need anti-fracture protection"

- Guaranteed against cracking*
- Easy to install liquid applies like paint
- Full fabric application
- Meets rigid DIN standard for anti-fracture membranes
- Extra Heavy-Duty Floor Service Rating

*See DS700.12 Hassle Free Lifetime Warranty for Additional Details.



**Globally proven.
Professionally endorsed.**

LATICRETE INTERNATIONAL, INC.

1 LATICRETE PARK NORTH • BETHANY, CT 06524-3423 USA
TEL: (203) 393-0010 • (800) 243-4788
FAX: (203) 393-1684 • FAX ON DEMAND: (800) 359-3297
www.laticrete.com • support@laticrete.com

LATICRETE MIDDLE EAST

TEL: (971) 4-286-2627 FAX: (971) 4-286-2123

LATICRETE ASIA PACIFIC

TEL: (65) 262-4237 FAX: (65) 262-3701

LATICRETE EUROPE

TEL: (39) 0585-856-159 FAX: (39) 0585-856-160

LATICRETE LATIN AMERICA

TEL: (203) 393-0010, EXT. 218 FAX: (203) 393-1684

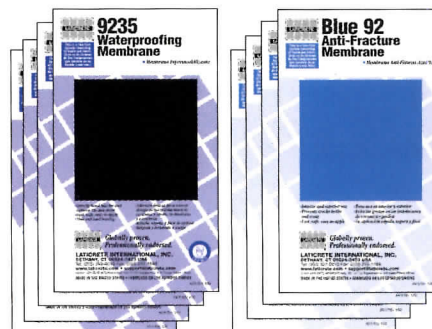

**For an actual
sample of these
membranes
absolutely
FREE call
800-243-4788,
Ext. 265.**

Please specify 9235 or
Blue 92 Swatch Card.

Brave new world of building

There's nothing like a successful project in the real world to turn hypothesis into fact and validate one's research. Levine Hall is only one, relatively small success story for technology transfer and an integrated approach to design, but Kieran and Timberlake's research will no doubt yield more. To verify the proper direction of their research, they are organizing a symposium this fall through the auspices of the Graduate School of Fine Arts at the University of Pennsylvania, where they also conduct a Master's Research Laboratory.

FROM AN OPERATIONAL AND ENERGY-USE PERSPECTIVE, THE CLIENT CAN EXPECT A 15 TO 20 PERCENT SAVINGS OVER THE LIFE OF THE BUILDING.

The revelation alone that the automotive and aerospace industries have successfully exploited developments in information technology, computer-aided design (CAD), and fabrication techniques to provide more scope or higher quality in less time and for less money should, at the very least, inspire the architecture profession to critique its self-imposed boundaries. As Timberlake acknowledges, "We have to start thinking like everybody else." ■

Spinoffs from NASA for architects

Fabric Structures. During the Apollo program, NASA searched for a durable, noncombustible material for space suits that was also thin, lightweight, and flexible. At the time, Owens-Corning was developing a glass-fiber yarn, which it wove into a fabric and then coated with Teflon for strength, durability, and hydrophobicity (the ability to repel moisture). A heavier version is now used to cover shopping malls and stadiums. Space-based fabric reduces lighting needs, and its reflectivity lowers cooling costs. **Flat Cable.** To make aircraft and spacecraft more compact, NASA devised space-saving, weight-shaving measures. One such measure is the use of extremely thin flat wires known as flat conductor cable (FCC). Only as thick as a credit card, FCC dramatically reduces the space occupied by the many miles of power lines in aerospace vehicles. A consortium of manufacturers pooled their resources to develop complete FCC systems, which encompass not only the cable but the sheathing, connectors, tools, and other equipment needed to facilitate FCC use by designers and builders.

Source: "The Best of NASA's Spinoffs," from Spinoff magazine (vesuvius.jsc.nasa.gov/er/seh/spinoff.html#BEST)



AIA/ARCHITECTURAL RECORD CONTINUING EDUCATION

INSTRUCTIONS

- ◆ Read the article "New Ways to Build Better, Faster, Cheaper" using the learning objectives provided.
- ◆ Complete the questions below, then fill in your answers (page 178).
- ◆ Fill out and submit the AIA/CES education reporting form (page 178) or download the form at www.architecturalrecord.com to receive one AIA learning unit.

QUESTIONS

1. Which of these attributes is shared by cars and buildings?
 - a. building department approvals
 - b. travels safely at 60 mph
 - c. integrated mechanical and electrical systems
 - d. produced in quantities of 25,000 units to be profitable
2. Savvy architectural clients expect which of their buildings?
 - a. they will take 3 to 5 years to produce
 - b. cost times time equals quality
 - c. faster delivery without additional costs
 - d. complex, well-constructed buildings take longer to build
3. Unitized construction is a direct transfer from which industry?
 - a. aerospace
 - b. automobile
 - c. shipbuilding
 - d. all of the above
4. Unitized construction of a curtain wall versus stick-built would result in which?
 - a. more field joints
 - b. fewer field joints
 - c. looser joints
 - d. higher operational energy use
5. The economic value of unitized construction is recognized in which?
 - a. lower initial costs
 - b. lower retooling costs
 - c. lower life-span costs
 - d. lower maintenance costs
6. In the Levine Hall glazed pavilion, which is not true of the curtain-wall construction?
 - a. the curtain wall is made of components
 - b. the concrete pours and attachments drive the coordination
 - c. the curtain wall drives the coordination
 - d. fabrication is precise
7. Which is an example of technology transfer?
 - a. when aerospace technology is published in scientific journals
 - b. universities paying royalties for automotive research
 - c. licensing of medical devices for use in hospitals
 - d. passing information from one specialized industry to another for use by a larger commercial base
8. The goal of Kieran and Timberlake was which?
 - a. to segregate the four disciplines of architecture, construction, materials science, and product engineering
 - b. to have the four disciplines achieve a collective intelligence
 - c. to develop innovation within each discipline separately
 - d. to develop research only in the discipline of architecture
9. In order to produce cars faster and cheaper, the automobile industry did which?
 - a. sped up the assembly line
 - b. hired more workers
 - c. used a modular system of production
 - d. changed suppliers
10. Fabrics developed for space suits offer which for building use?
 - a. high strength with light weight
 - b. increased energy consumption
 - c. increased lighting needs
 - d. heavier weight than steel

Digital Architect

From atelier to e-telier: virtual design studios

By Jerry Laiserin, FAIA

The design studio, as physical place and pedagogical method, is the core of architectural education. Ateliers clustered around rue Napoleon in Paris defined the *École des Beaux Arts*. The Carnegie Endowment report on architectural education, published in 1996, identified a comparably central role for studios in schools today. From programs, schemes, and *parti* to desk crits, pin-ups, and charrettes—language and behavior learned in the studio establish the profession's cultural framework.

Advances in CAD and visualization, combined with technologies to communicate images, data, and “live” action, now enable virtual dimensions of studio experience. Students no longer need gather at the same time and place to tackle the same design problem. Critics can comment over the network or by e-mail, and distinguished jurors can make virtual visits without being in the same room as the pin-up—if there is a pin-up (or a room).

Virtual design studios (VDS) have the potential to favor collaboration over competition, diversify student experiences, and redistribute the intellectual resources of architectural education across geographic and socioeconomic

Contributing editor Jerry Laiserin, FAIA, provides strategic consulting services to architects and their technology providers.

www For more information on technology for architects, including reviews, vendor lists, and links, go to Digital Architect at www.architecturalrecord.com

divisions. The catch is predicting whether VDS will isolate students from a sense of place and materiality, or if it will provide future architects the tools to reconcile communication environments and physical space.

With a little help from my friends

While shuttling between Harvard and MIT on Boston's MTA Red Line subway during the 1980s, William J. Mitchell, FRAIA, now dean of architecture and urban planning at MIT, mused that the network linking the two schools' computer systems served as an “electronic Red Line.” By the early 1990s, former students, collaborators, and admirers of Mitchell began establishing transcontinental and transoceanic “Red Lines,” inventing the ground rules for electronically mediated studios as they went along. From 1995 to 1997, a watershed in VDS evolution occurred in the academy, with publication of experiences in overlapping studios among the universities of Sydney, Tasmania, and Queensland in Australia; University of British Columbia (UBC); Hong Kong (UHK), Kumamoto, and Kyoto universities in Japan; MIT; the National University of Singapore; Washington University in St. Louis; and the Technical University (ETH) of Zurich, among others.

In 1997, Mary Lou Maher, Simeon Simoff, and Anna Cicognani wrote a landmark paper and subsequent monograph, *Understanding Virtual Design Studios* (Springer-Verlag, 1999), on VDS experiences at the Key Centre for Design Computing,

Faculty of Architecture, University of Sydney. According to Dr. Simoff, who's now at the University of Technology Sydney, VDS makes “the location of designers irrelevant ... because the workspace of the studio is distributed across the net. Designers are able to enter

be synchronous, implying “the simultaneous presence and participation of all designers involved in the collaboration,” or asynchronous, in which “designers may work at different times, often on different parts of the design, and do not require the simultaneous presence of all team

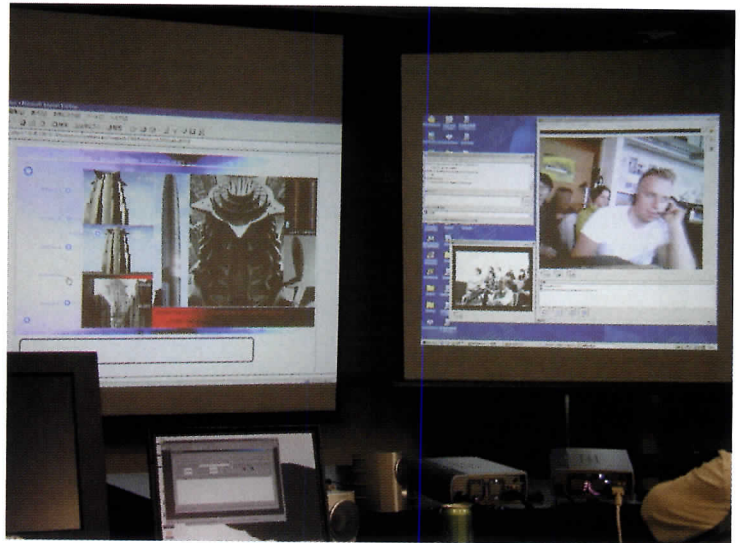

Architecture student Tom Carajevski at the University of British Columbia presents his design proposal to a critic at Kumamoto University in Japan.

the studio for interactive and non-interactive sessions connecting to the World Wide Web, multimedia mailers, and/or connecting to a video conferencing session.”

The design collaboration may be single-task, in which each participant “has his own view over the whole design problem, and the shared conception is developed by the ‘superposition’ of the views of all participants,” or multiple-task, in which “the design problem is divided among the participants in a way that each person is responsible for a particular portion of the design.”

Similarly, communication may

members.” Asynchronous communication has modest technical needs—typically e-mail and file transfer protocol (FTP)—while synchronous communication imposes high bandwidth and technology requirements for video conferencing, shared electronic whiteboards, and specialized groupware.

Simoff observes that an ideal shared design representation for VDS “would incorporate the designers' goals, descriptions, reasoning paths in their design steps, partial solutions to the design task, design communications, and information exchange.” But he notes that no

Digital Architect

CAD system or interoperability scheme among CAD systems currently supports all these data. Therefore, the typical VDS employs an informal hypermedia approach, presenting information as text, tables, images, 3D models, animated images, and Web links to other information.

When implementing these principles, Nancy Yen-Wen Cheng, AIA, who taught at UHK during the mid-1990s when VDS took root there, favors structuring well-defined tasks and interactions "because of the difficulty of a true artistic collaboration between people who have never met." In local projects at the University of Oregon, where she now teaches, Cheng observes, "Where students can supplement mediated communication with face-to-face talk, they see their contributions become part of a useful repository." In remote projects, such as a recent collaboration with the University of Stuttgart, "students see that though their distant peers may have different values and approaches to design, many fundamental aspects of the design process are unchanged around the world. The enlarged pool of students involved [in a VDS] allows us to identify different models of excellence. While face-to-face interaction is more direct for conveying complex

aspects of architecture and urban design, even through the haze of the mediated connection we get to glimpse a wider world."

At UBC, Dr. Jerzy Wojtowicz has been involved in VDS technology since its inception and finds it "no longer a big deal." In a recent collaboration between UBC and Kumamoto University, remote faculty critiqued student work synchronously—via Microsoft NetMeeting, Cornell University's CUseeMe, and Moro Lab's Group Work CAD (GW-CAD, developed by Professor Mitsuo Morozumi at Kumamoto)—and asynchronously with design software from Advrent (Art•lantis), Adobe (Photoshop, Flash), Alias | Wavefront (Maya), Autodesk (AutoCAD), auto•des•sys (form•Z), Graphisoft (ArchiCAD), and Nemetschek (VectorWorks).

Wish you were here

The Las Americas VDS spans Texas A&M and universities in Mexico, Argentina, and Chile, and combines lessons learned from other VDS with some new twists. Like Cheng, "Aggie" assistant professor Guillermo Vásquez de Velasco believes the cross-cultural nature of VDS promotes questioning "the hundreds of default design decisions that our students make during a semester. People with different

backgrounds will do things differently, and it is from that diversity of experiences that the students can learn that every decision in the design process is an opportunity waiting to be used. The virtual design studio also is important as we train our students for a global marketplace." Like Wojtowicz's students at UBC, Texas A&M students can use VDS-specific tools, including "electronic pin-up" programs that allow the same Photoshop image files to be plotted out for real pin-ups and published simultaneously in HTML format for virtual pin-ups on the Web, without duplicate effort.

Dr. Vásquez de Velasco's innovation in VDS is the Infinity Room (see illustrations below), which creates the illusion that studios hundreds or thousands of miles apart are just opposite halves of the same room. This logical extension of VDS technology into the realm of simulation or telepresence increases psychological engagement in the same way as "dissolving the fourth wall" does in the theater.

Toward a virtual architecture

Media guru Marshall McLuhan once noted that new media take their initial content from the media they replace. The first motion pictures were filmed stage plays; the first television broadcasts were radio programs with pictures. But new media eventually develop their own

forms, processes, and content—an evolutionary phase that VDS technology is just now entering.

Jim Davidson, AIA, taught at UBC during the school's mid-1990s VDS work, moved on to the epicenter of virtual reality research at the University of Washington's Human Interface Technology Lab, and then moved on to Microsoft and independent consultancy D'Art, Inc. In response to "the nonphysical, placeless, and nontemporal character of the medium of collaboration," Davidson believes VDS is essential to "helping students understand when our communications—verbal, written, or graphic—are media-dependent and when they are not."

Some of the most advanced exploration of media dependence in design communication and its implications for architectural form and program has been ongoing at ETH in Zurich, initially under the direction of Gerhard Schmitt and now under Maia Engeli. ETH defines its use of VDS technology as a platform for creating a new hybrid of virtual and physical architecture for 2010 and beyond—an architecture as much about chips, sensors, and adaptive building behavior as about commodity, firmness, and delight. The role of the studio thus will come full circle: As the hand-rendered communication media of the original ateliers shaped the architecture of the Beaux Arts age, the virtual media of the e-telier will shape a new architecture of the digital age. ■



The Infinity Room

Mexico Texas A&M University

The Infinity Room involves building studios in different locations (plan, right) equipped with floor-to-ceiling rear-projection screens, computers, and video equipment to create life-size images.

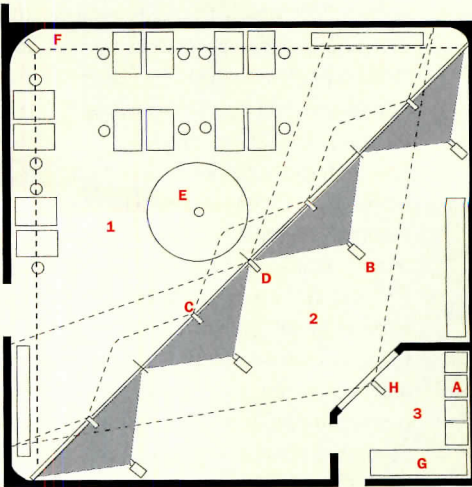

- 1. Studio
- 2. Equipment room
- 3. Control room
- A. Computers for image compression
- B. Video projectors
- C. Wide-angle camera
- D. Main studio camera
- E. Ceiling camera
- F. Feedback camera
- G. Audio/VCR
- H. Future location of main camera

LIGHTING

New architectural lighting master classes: terrific learning situation for architects

There are dozens, perhaps even hundreds, of opportunities to learn about lighting every year. I don't often take the trouble of plugging most of them, because they are about technology: lamps, ballasts, fixtures—basically, hardware and “the numbers.” Those topics are important

and they have their place, but most design professionals who do not specialize in lighting per se are looking for something different. They're not interested in finding out how to usurp the place of their lighting consultants. Rather, they want to learn how to complement them better and to create architecture that provides opportune settings for high-quality lighting. Now there is a new chance to learn: in the Architectural Lighting Master Classes at John Jay College in New York City, which will be offered February 21 and 22. The classes are being produced by Sonny Sonnenfeld, who has been putting on the Broadway Lighting Master Classes for several years. The courses are being coordinated by Paul Gregory of Focus Lighting, New York City, and Jonathan Spiers of Jonathan Spiers Associates, Edinburgh, Scotland. Both designers have had projects in the RECORD Lighting section. Paul's lighting of the Toys “R” Us flagship store (photo, left) appears in this issue. The faculty will also include Howard Brandston, perhaps best known for his masterful lighting of the Statue of Liberty; Ken Billington, a theatrical lighting designer with over 80 Broadway and 50 Off-Broadway shows to his credit; and Dr. Alan Lewis, who has written about physiological optics, lighting and vision performance, ergonomics, and color vision, among other vision-related topics. Together they will present two days of classes covering creativity and inspiration; maintaining the competitive edge; coordinating architectural and lighting design; tools of the trade and how to use them; and presentation techniques. AIA members receive 16 learning units for attending both sessions and a tuition discount. Details can be obtained by sending an e-mail to e.almc_nyc@hotmail.com or calling the Architectural Lighting Master Classes at 212/769-2751. *Charles Linn, AIA*



149 Creative uses
150 Nordic Light Hotel, Stockholm
Ljusarkitektur P&O

158 Toys “R” Us, New York City
Focus Lighting
163 Lighting resources

The base of the hotel's guest-room tower is illuminated with compact fluorescents, adding to its floating appearance (right). Theatrical luminaires graze the glass wall of the facade (below), with clear and translucent sections emitting a varied glow.



Adapting the boutique hotel aesthetic to Stockholm, designers wash interiors with a paint box of light

By William Weathersby, Jr.

In Stockholm, Sweden, two new sister hotels embrace the essential elements of water and light. The adjacent Nordic Sea and Nordic Light hotels anchor a reconfigured civic square, the Vasaplan, which fronts the Central Station rail-transit complex. While the Nordic Sea features a nautical theme—with an oversize lobby aquarium, blue upholstery, and cherry wood surfaces that would seem at home aboard a ship—the Nordic Light presents a spare, abstract landscape whose compass points are harder to plot. Interior planes and materials

Contributing editor William Weathersby, Jr., is a writer based in Westport, Conn. He coordinates lighting coverage for ARCHITECTURAL RECORD.



within a stark palette of black, white, and gray form the backdrop for a changing play of light and color.

“Daily periods of sunlight range from 6 to 19 hours throughout the year here, so Swedes are very attuned to changes in weather and natural light,” says principal lighting designer Kai Piippo of Ljusarkitektur P&Ö. “Within the Nordic Light, we wanted to use electric illumination to abstractly evoke the many facets of this mercurial Scandinavian quality of light.” Patterns projected upon the walls of the public spaces—including sunbursts, streaks from a rainbow, and flames of fire—slowly change throughout the day to recast the ambience of public spaces, enveloping guests with an atmospheric glow.

While the 367-room Nordic Sea was carved from an existing police station, the Nordic Light adaptively reuses part of an existing office building, long the site of a regional Mercedes corporate headquarters. A new six-floor wing housing 175 hotel guest rooms was added atop the three-story base of the building. Collaborating with interior designers Jan Söder and Lars Phil (who for many years worked, respectively, as a photographer and art director), Piippo mapped out an extensive lighting plan that employs fixtures incorporating theatrical, architectural, and art-glass modes. “The interior surfaces and Modernist furnishings are rather aus-

PLAYING OFF BLACK-AND-WHITE PLANES, COLORFUL ILLUMINATION DEFINES SPACE AND MOOD. THE FACES OF GUESTS GLOW.

tere, in direct contrast to the more traditional Nordic Sea,” Piippo says. “Light is a major component leading guests through the space and affecting their perception of the surroundings.”

On the ground floor, the glass-wall facade allows daylight to flood the entrance from morning until dusk on sunny days. Sections of the window wall are treated with a translucent film to reduce glare along the reception area while veiling the view from the street. At the onset of darkness, a light show accompanied by music begins at the entrance and proceeds for several minutes. Theatrical fixtures fitted with color washes graze the front doors and glass wall of the facade. The light effects continue to change slowly over one hour, then the cycle repeats. “The key is in the gradual change of color and intensity,” Piippo says. “We didn’t want to blast patrons directly with light, but we wanted them to slowly become aware that the room is always taking on a new mood.”

Project: Nordic Light Hotel,
Stockholm

Owners: JM; Ejnar Söder; Hans
Mellström

Architect: FFNS Arkitekter—Per
Wigow, principal architect

Interior architect: Hotell och

Restaurangprojekturing

Interior designer: soder.phil—Lars
Phil, Jan Söder, principals

Lighting designer: Ljusarkitektur
P&Ö—Kai Piippo, principal lighting
designer

Signage designer: Christin Browall



“With white walls and a white marble floor, the lobby is like a light box of effects,” says Kai Piippo. Sun and starburst patterns in the reception area and dining room (above and left) are projected with architectural fixtures that adapt theatrical techniques.

The hotel staff members behind the reception desk are backlit with ceiling-mounted, low-voltage incandescents that give off a color temperature approximating sunlight. The registration console is edged with fluorescents at its base to subtly uplight patrons.

A sculptural chandelier in the center of the lobby showcases the classic craftsmanship of Swedish art glass. Piippo worked with artist Anna Ehrner to design a formation of stalactitelike spikes enlivening a recessed dome. Each rod encases a fiber-optic element that changes color as part of a choreographed light program. Each season, Piippo reprograms the effect to alter the mix of colors. “The glass rods have been fired with a component of alabaster to vary the quality of translucency,” Piippo says. Though not meant to literally evoke ice formations, he notes, they add a

poetic punctuation of Nordic culture to the room. (Piippo indeed knows how to illuminate actual ice, as the longtime lighting designer of the annual Ice Hotel in Sweden’s Arctic Circle).

The lobby’s white walls and curtains function as surfaces upon which to project light. Piippo says he likes to think of them as “movie screens that capture archetypal images composed of light.” Rather than theatrical fixtures, he specified architectural luminaires that house 50-watt, low-voltage halogen lamps fitted with pattern projectors. Eight ceiling-mounted luminaires focus narrow beams of light upon the walls and can be synchronized to pulse or slowly fade. The lighting design of the hotel lobby is changed once a month, with custom lighting projections arranged for special events.

BRUCK

L I G H T I N G S Y S T E M S



ORION Series

The LED lamps from Bruck, with 100,000 hours of life and high resistance to shock and vibration, virtually eliminate maintenance while reducing heat and energy cost by 90%. Available in green, blue, red, amber and white.

ORION E26: Replaces medium base incandescent lamps and enhances visibility.

ORION MR 16: Upgrades standard MR16 for visual display lighting.

ORION AL: Withstands stepping, spilling and most high traffic area conditions.

Product Briefs

▼ Tilt-turn architectural windows

Rehau's 4500 series tilt-turn architectural window design offers a multichambered window system engineered to exceed current window test standards. A European-engineered dual sealing system forms a barrier against the elements, with an uninterrupted inner compression seal around the entire window. The design provides for inward or outward opening casement windows, in addition to enabling configuration of awning, hopper, or picture windows. 800/247-9445. Rehau, Leesburg, Va. **CIRCLE 234**



▲ Laser distance-measuring tools

Disto handheld laser meters provide fast measurements of distance, area,

and volume, indoors or outdoors, with an accuracy of up to 1.5 mm at range of up to 100 meters. With Disto, one person can capture hundreds of measurements in a matter of minutes, with point-and-click operation, even in locations that are inaccessible or blocked by obstructions. The products are available in four models, ranging from the lower-cost Disto lite with basic features, to the high performance Disto pro⁴. 770/447-6361. Leica Geosystems, Norcross, Ga. **CIRCLE 235**

► Air-pressure sensor

The Dietz Model FE190 Forced Entry Sensor will detect the breaking or opening of a window or door without requiring the installation of individual sensors. It will also detect if forced entry is made through a hole in the ceiling, wall, or floor by the resulting drop in air pressure. 888/866-5641. The Henry G. Dietz, Long Island City, N.Y. **CIRCLE 236**

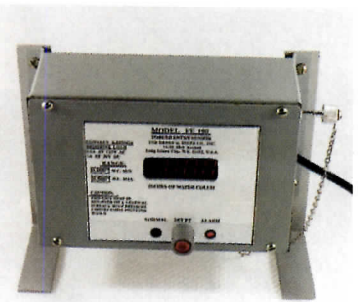

For more information, circle item numbers on Reader Service Card or go to www.architecturalrecord.com Advertisers & Products info.

A Landmark Resource

Pioneers of American Landscape Design

CHARLES A. BIRNBAUM, FASLA | ROBIN KARSON



McGraw-Hill
486 pages
0-07-1344209
\$59.95 (Hardcover)

NATIONAL PARK SERVICE HISTORIC LANDSCAPE INITIATIVE
LIBRARY OF AMERICAN LANDSCAPE HISTORY
CATALOG OF LANDSCAPE RECORDS IN THE UNITED STATES AT WAVE HILL
THE CULTURAL LANDSCAPE FOUNDATION

From George Washington to James Rose, this handsome encyclopedia offers 160 short biographies of seminal figures who changed the face of America.

Available online and at bookstores everywhere.



corrugated glass

Tempered Panels to 48"x118"

Joel Berman Glass Studios

www.jbermanglass.com
US + Canada 1 888 505 GLASS
UK 00 800 505 45277

PHOTO: STEPHEN NYIRAH, NYROTC.COM

CIRCLE 65 ON INQUIRY CARD

Product Literature

Let's get this party started

Luraline Products has introduced a new brochure showcasing the Confetti line of its Designer Series of lighting fixtures.

The 10-page brochure includes complete specification details as well as an ordering guide for assistance in selecting from Confetti's available configurations, finish options, and enhancements. 800/940-6588. Luraline Products, Opa Locka, Fl. **CIRCLE 237**

Outdoor lighting

Hallbrook Series outdoor luminaires from Holophane are detailed in new literature from the company. Applications include urban boulevards, town squares, commercial shopping districts, parks, and college campuses. 740/345-9631. Holophane, Newark, Ohio. **CIRCLE 238**

Door offerings

Two brochures from VT Industries' architectural wood door division are now available. The first describes the features and benefits of VT's SolidStyle wood veneer doors and PermaClad decorative laminate wood doors. The second brochure focuses on the PermaGuard factory finish system and VT Color Choices. 800/827-1615,

NEW SITES FOR CYBERSURFING

Wood Products Council site represents manufacturers of lumber, engineered



wood, architectural millwork, and wood composite panels. www.woodinfo.com

Kohler's renovated site features an interactive bathroom design area and design tips. www.kohler.com

Newly redesigned site for Lighting Services' track, accent, display, and fiber-optic lighting systems. www.lightingservicesinc.com

ext. 210 or 304. VT Industries, Holstein, Iowa. **CIRCLE 239**

Green software

The *EBN Archives* is an archive of all issues of the *Environmental Building News* monthly newsletter from 1992 through the end of 2000 on a single CD-ROM. The *Green Building Advisor* is an interactive software tool that helps users identify strategies for improving the environmental performance of projects. 800/861-0954. BuildingGreen, Brattleboro, Vt. **CIRCLE 240**



For more information, circle item numbers on Reader Service Card or go to www.architecturalrecord.com Advertisers & Products info.

Modern Masters of Architectural Timbers

The G.R. Plume Company sets the standard for integrating the beauty of natural wood into today's architecture. Our masterful architectural timbers grace distinctive homes and businesses around the world. We provide beautiful and ingenious solutions, insightful collaborations, and a thorough understanding of wood and its applications. Our twenty years of creative and technical woodworking expertise can help you realize your architectural vision. For more information, call (360) 384-2800.



THE
G.R. PLUME COMPANY
ARCHITECTURAL TIMBER DIVISION

Product Literature

World-famous names

Furniture and accessories by designers such as Philippe Starck, Marcel Breuer, Alberto Meda, and Michael Graves are featured in a new 100-page catalog from Oriac Design. 866/GO-Oriac. Oriac Design Group, Newton, Mass. **CIRCLE 241**

Renewing concrete

The Sealtight Concrete Renewal Systems Brochure provides photography and descriptions for seven typical renewal system application areas for general purpose or structural repairs and restoration. 800/342-5976. W.R. Meadows, Hampshire, Ill. **CIRCLE 242**

Waterjet cutting services

Precision H₂O, an ultra-high-pressure waterjet-cutting company, has produced a new brochure showcasing its specialized services. The piece explains the waterjet process and highlights several installations incorporating natural stone, ceramic tile, and resilient materials. 800/425-2098. Precision H₂O, Spokane, Wash. **CIRCLE 243**

Southern Pine flooring guide

The newest publication from the Southern Pine Council, *A Guide to*

Southern Pine Flooring, contains all the facts pertaining to proper installation, finishing, and maintenance of a high-quality Southern Pine floor. The 20-page brochure explains the intricacies of Southern Pine flooring grade, patterns, and manufacturing. Extensive text and instructive illustrations cover the installation and finishing processes. A special section of the booklet is devoted to pressure-treated Southern Pine porch flooring. 504/443-4464. Southern Pine Council, Kenner, La. **CIRCLE 244**

Roofing guide/safety tips

The National Roofing Contractors Association (NRCA) offers the 2001-02 *Low-slope Roofing Materials Guide*. The guide is a comprehensive report on commercial, industrial, and institutional low-slope roof coverings, rigid insulation board, fasteners, and cements and coating products currently available in the U.S. market. Detailed descriptions of the manufacturer's roofing materials are included. The NRCA also offers *From Shop to Rooftop: Sheet Metal Safety Tips*, a videotape program and workbook that addresses aspects of sheet metal safety. 800/323-9545. NRCA, Rosemont, Ill. **CIRCLE 245**

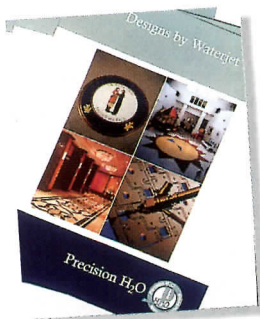

For more information, circle item numbers on Reader Service Card or go to www.architecturalrecord.com Advertisers & Products info.



For a complete catalog
call Canterbury International
800-935-7111
www.canterburyintl.com
canterburyinc@earthlink.net

Millennium Park
bronze clock
dedicated by
Alliance for
Downtown New York
to David Rockefeller

CIRCLE 67 ON INQUIRY CARD





Program title: **New Ways to Build Better, Faster, Cheaper, Architectural Record (01/02, page 131)**

AIA/CES Credit: This article will earn you one AIA/CES LU hour of health safety welfare credit. (Valid for credit through January 2004)

Directions: Select one answer for each question in the exam and completely circle appropriate letter. A minimum score of 70% is required to earn credit.

- | | | | | | | | |
|------|---|---|---|-------|---|---|---|
| 1. a | b | c | d | 6. a | b | c | d |
| 2. a | b | c | d | 7. a | b | c | d |
| 3. a | b | c | d | 8. a | b | c | d |
| 4. a | b | c | d | 9. a | b | c | d |
| 5. a | b | c | d | 10. a | b | c | d |

Last Name _____ First Name _____ Middle Initial or Name _____

Firm Name _____

Address _____ City _____ State _____ Zip _____

Tel _____ Fax _____ E-mail _____

AIA ID Number _____ Completion date (M/D/Y): _____

Check one: \$10 Payment enclosed (make check payable to *Architectural Record* and mail to: Architectural Record/Continuing Education Certificate, PO Box 682, Hightstown, NJ 08520-0682.)

Charge my: Visa Mastercard American Express Card# _____

Signature _____ Exp. Date _____

Check below:

- To register for AIA/CES credits:** answer the test questions and send the completed form with questions answered to above address.
- For Certificate of Completion:** which is required by certain states, answer test questions, fill out form above, and mail to above address. Your test will be scored. Those who pass with a score of 70% or higher will receive a certificate of completion.

Material resources used: Article: This article addresses issues concerning the health and safety.

I hereby certify that the above information is true and accurate to the best of my knowledge and that I have complied with the AIA Continuing Education Guidelines for the reported period.

Signature _____ Date _____

**Read Architectural Record for Credit
Important Changes to the AIA/Architectural Record Continuing Education Program Beginning January 1, 2002.**

Architects can earn AIA Continuing Education learning units by reading designated articles and sponsored sections in ARCHITECTURAL RECORD and on Architecturalrecord.com, answering test questions on the Continuing Education Reporting Form and submitting forms for processing. Each month Architectural Record Continuing Education articles and sections are listed on the table of contents in the magazine and on the Web site. Most qualify for health, safety, welfare credit. Simply look for the sign. 

In compliance with AIA Continuing Education guidelines, beginning with the January 2002 issue:

1. A separate Continuing Education Reporting Form must be completed for each continuing education article or section. The form's location is stated in each article. The correct answers to the multiple choice test questions must be circled on the Reporting Form along with the applicant's name, AIA number, and other contact information. A \$10 processing fee payable by check or credit card must accompany each Continuing Education Reporting Form.
2. Beginning with the January 2002 issue, Reporting Forms will be mailed to the Architectural Record Continuing Education processing center address listed on the Reporting Form. All Continuing Education registrations will be forwarded to the AIA/CES records office at the University of Oklahoma for inclusion on AIA Continuing Education transcripts. (The date the AIA/CES records office ascribes to the LUs will be the last day of the month in which they receive notification from the provider that the LU credit has been earned.)
3. Certificates of completion: To comply with state licensing mandatory continuing education issues, RECORD has established a system to provide certificates of completion to participants who request this documentation. A passing score of 70% on the test answers is required for successful completion. You may request a certificate on each reporting form. We've changed our format to closely align with state licensing requirements.
4. AIA/CES-approved magazine articles and sections that are more than two years old can only be self-reported as part of a self-designed research project, not for HSW credit. Contact the AIA records office in Oklahoma for self-reporting: 800-605-8229. Articles and sections published within two years of this issue must use the AIA/CES Reporting Form in those issues and/or follow the instructions on the Web site.

If you have questions regarding the AIA/Architectural Record Continuing Education Program, e-mail AReditorial@mcgraw-hill.com.

RECRUIT TOP TALENT

WITH ARCHITECTURAL RECORD AND
ARCHITECTURALRECORD.COM

Reach 275,000+ active architectural professionals at all stages of their careers. Recruit nationally and internationally. Combine Print and Online advertising to fill key positions quickly and effectively:

- Promote your firm as a great place to work in the magazine and on architecturalrecord.com
- List your available jobs in the magazine or on Architecturalrecord.com
- Create an online job fair customized for your firm
- Drive traffic to your own website with your ad in the magazine or with links from Architecturalrecord.com

FOR RECRUITING RESULTS, CALL ALLY WINGATE
AT 1-800-484-4042, EXT. 3042.

Power, Functionality & Attention to Detail

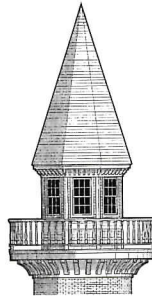

...Abundant 2D Tools; Easy to Learn and Use...
...Powerful and Useful...

Cadalyst Magazine, October 1996

Call (800) 247-2032 for Free Working Demo

FLATLAND 6... Serious Two Dimensional Drafting for Building Design Professionals

Ashcraft Architectural Computer Graphics
220 Glen Street, Glens Falls, NY 12801 (518) 798-4631 (800) 247-2032

Circle 199 on Inquiry Card

Cut Cost by 50%

NET ENABLED CAD SERVICES
ON-LINE ARCHITECTURAL DRAFTING
AND STEEL DETAILING

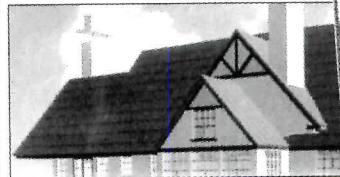

Free Trial
Already undertaking work on behalf of USA Architects/Detailing bureaus
References on Request

Advance Informatics

e-mail: sanjaya@vsnl.com

www.cadinformatics.com

Tel : 888-342-8257 Fax : 800-886-2664

Studio 4d Inc. Computer Rendering & Animation

- Unsurpassed Photo-realistic Illustrations
- Virtual Tours & Animations
- Day, Dusk or Night Renderings

Studio 4d is your key source for exceptional illustrations and animations! View our extensive portfolio online at:

588.532.1099 www.3drenderingstudio.com

To Reply To Box Numbered Ads:

Address separate envelopes for each reply to:

Box number from ad
Architectural Record

Post Office Box 1962
Cumming, GA 30028



COMPLETE PREPARATION FOR THE REGISTRATION EXAM

Architectural License Seminars

Web: www.alsOnline.com

Tel: (310) 208-7112

E-mail: alsOnline@earthlink.net

Fax: (310) 824-7028



U.S. General Services Administration

DESIGN COMPETITION

NEW UNITED STATES COURTHOUSE ROCKFORD, ILLINOIS

The U.S. General Services Administration is pleased to announce a Design Excellence Competition for the selection of an Architect/Engineer Team to design the new United States Courthouse in downtown Rockford, Illinois. The building will be approximately 13,000 gross square meters (140,000 gross square feet) including 33 indoor parking spaces. The estimated construction cost range is \$30,000,000-\$40,000,000. The design competition will be comprised of three stages with the finalists expressing their vision of the courthouse in a blind competition. The design will be judged by an independent jury of nationally recognized professionals.

For submittal information go to www.fedbizopps.gov or cdnet.gpo.gov. For additional clarification contact Camdon Hindes at 312-353-5984 or camdon.hindes@gsa.gov

CIRCLE 70 ON INQUIRY CARD

TURNING GRAY CONCRETE Green

These microscopic, glassy spheres are fly ash – and at ISG Resources, we sell millions of tons of them every year.

Produced by burning coal at electric power plants, fly ash might be destined for disposal in a landfill. But when added to concrete, fly ash makes concrete easier to work with, stronger and more durable.

Fly ash also allows concrete producers to reduce the amount of cement that they use. That means less energy is consumed to manufacture cement and there are less greenhouse gas emissions from the process – almost a ton of CO₂ saved for every ton of cement that's not produced. In addition to concrete, fly ash is used in mortars, stuccos and a variety of other building materials.

That's an improvement worth specifying.

ISG RESOURCES

1.888.236.6236

www.isgresources.com

Contact ISG for free technical literature and information on how fly ash use benefits the environment.

AIA/CES Registered Provider



CIRCLE 71 ON INQUIRY CARD



Topher Delaney: Healing the world, one garden at a time

Interviewed by Elizabeth Harrison Kubany

*After she was diagnosed with breast cancer, Topher Delaney, a San Francisco-based artist and landscape designer, made a pact with God. If she survived, she swore she would devote her work to helping others heal. Now, almost a dozen years later, Delaney has created a specialty in the design of healing gardens for hospitals and sanctuaries for residential and business clients. A new book, *Ten Landscapes* (Rockport, 2001), displays some of Delaney's residential projects, which, like her institutional work, is as colorful, upbeat, and unorthodox as the artist herself.*

Q: *What is your work about?* Everything I do, whether for a hospital, a business, or a residence, is about comfort, healing, and faith. When I was beginning my career, landscape design appealed to me as a form of sculpture and as a way of showing my commitment to the environment. It seemed to be the perfect combination of art and civic responsibility. What I have realized along the way is the tremendous power gardens can have on people's psyches. My work, it seems, is always a series of programmatic responses to complex emotional issues. *For example?* I designed a roof garden for the Bank of America building in San Francisco. The company was struggling with personnel issues because they have many employees who work more than one job and are always exhausted as a result. They have many computer programmers who never see the light of day. So we made an active environment using recycled materials, with generous benches where people sleep during their breaks. It is like a private sanctuary for every employee.

Sanctuary does seem like a better word than garden or landscape for what you create. The word garden, from the German *garten*, originally meant enclosure. So if you think about this in a metaphorical way, a garden should be more than just a pretty object. It should be like an embrace.

The issues of people suffering from cancer are something you can relate to all too well, it seems. Being in a hospital is a terrifying process because you lose control over your own body. When you have a cancer, it is a long-term proposition. For months, sometimes years, there are significant, invasive courses of treatment. I created a garden at the Marin Cancer Institute where I used the source plants for the different pharmaceuticals employed to treat cancer. For instance, the plant *catharanthus roseus* is used to make Vinblastine Sulfate and Podophyllin is made from *phodophyllum peltatum*. We created a booklet with a descriptive narrative that people can use to educate themselves while enjoying the spaces. In the act of learning about their treatment, people regain some sense of control over their destinies.

What are you working on now? I just returned from New York. I've designed a memorial for those who died on September 11;

not for the site of the World Trade Center, specifically, but for all of Lower Manhattan below Canal Street. The idea is to present the family members with an index of species of trees that currently thrive in Manhattan and to let them choose the kind of tree they'd like to memorialize their loved one. Each tree would have a plaque with the name of the person who perished and his or her age and hometown, or some other text. This would celebrate the memory of those killed, and also be a gift of hope to the city. A tree is a wonderful symbol of the future.

Photograph courtesy SEAM/Topher Delaney

SMALL STAFF. TIGHT BUDGET. ONE PROGRAM.

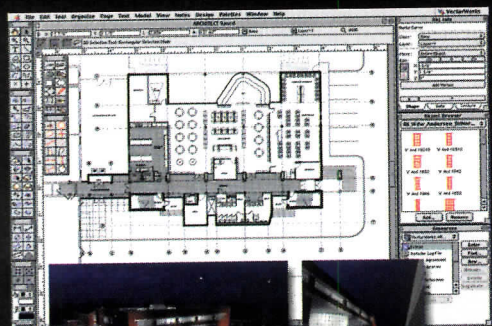
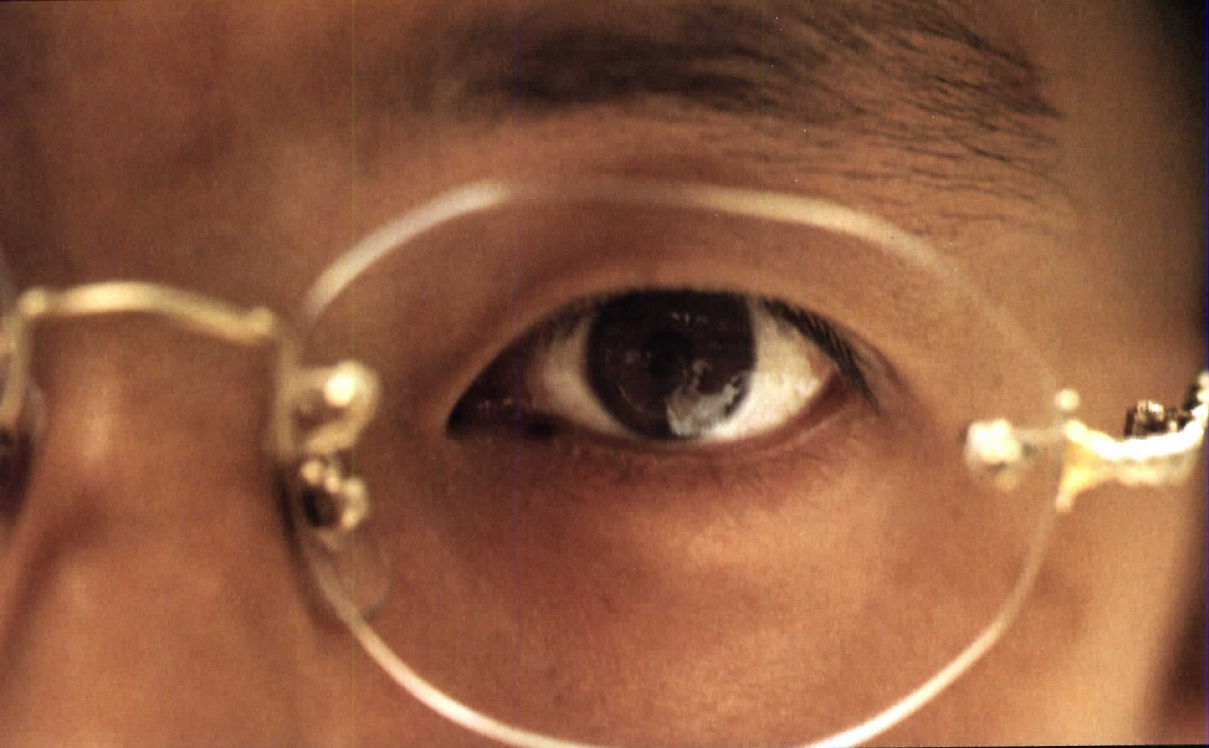

Total integration of 2D and 3D

- ▶ EASY TO LEARN, EASY TO USE
- ▶ TOTAL INTEGRATION OF 2D AND 3D
- ▶ AUTOMATIC TRACKING OF COSTS AND MATERIALS
- ▶ POWERFUL, YET AFFORDABLE CAD TECHNOLOGY

The best CAD program doesn't have to be the most expensive. Top architects rely on VectorWorks ARCHITECT to create and present their designs. At a fraction of the cost of other CAD programs, ARCHITECT can take your designs to places you never thought they could go.

To learn more, call 888-646-4223 and speak with one of our knowledgeable sales representatives today. Ask for a free evaluation CD and find out for yourself why VectorWorks ARCHITECT is the easiest, most cost-effective way to design.

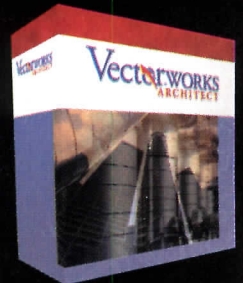

VectorWORKS[®] 9 ARCHITECT

888.646.4223 | www.nemetschek.net

CIRCLE 72 ON INQUIRY CARD

VectorWorks. Freedom to do more.
A product of Nemetschek North America

5:01 pm

Your client expects to see their new ceiling design at tomorrow's presentation.

5:27 pm

Thanks to Design Wizard, you can bring your best five.

Now, exceeding your clients' expectations is easy as 1-2-3. You can draw, render and specify ceiling designs faster and easier than ever before. After you draw your ceilings, this free AutoCAD plug-in renders USG's products three dimensionally in the completed space. It ensures the designs are executable and then creates electronic specifications for each. Finally you can design multiple, innovative ceilings for every space, using any curve, color and texture your imagination demands. Design Wizard is free at usg.com or call 1-800-USG-4YOU.

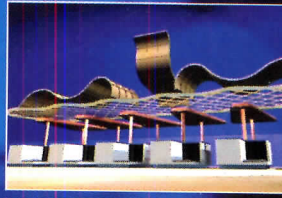
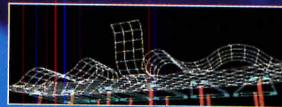

**Ceilings
Substrates
Drywall
Systems**

USG

Working for You

Limit one per person.

Products manufactured by United States Gypsum Co. and USG Interiors, Inc. ©2001 USG Corporation