

ARCHITECTURAL
TECHNOLOGY
SPRING 1984 THE AMERICAN INSTITUTE OF ARCHITECTS

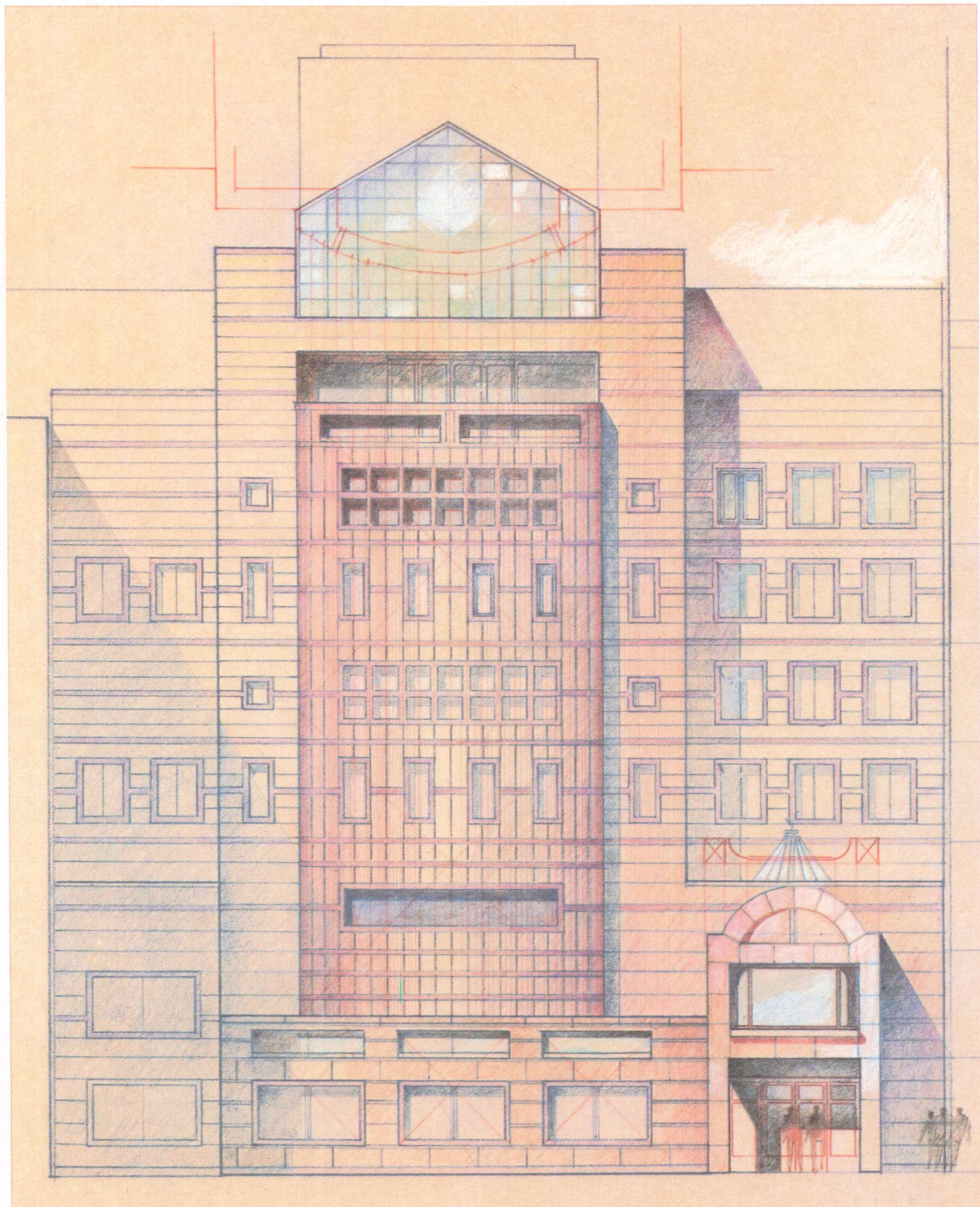

DESIGNING IN THE AFTERMATH:
PORTLAND'S BOB FRASCA

Our rates outshine the others.

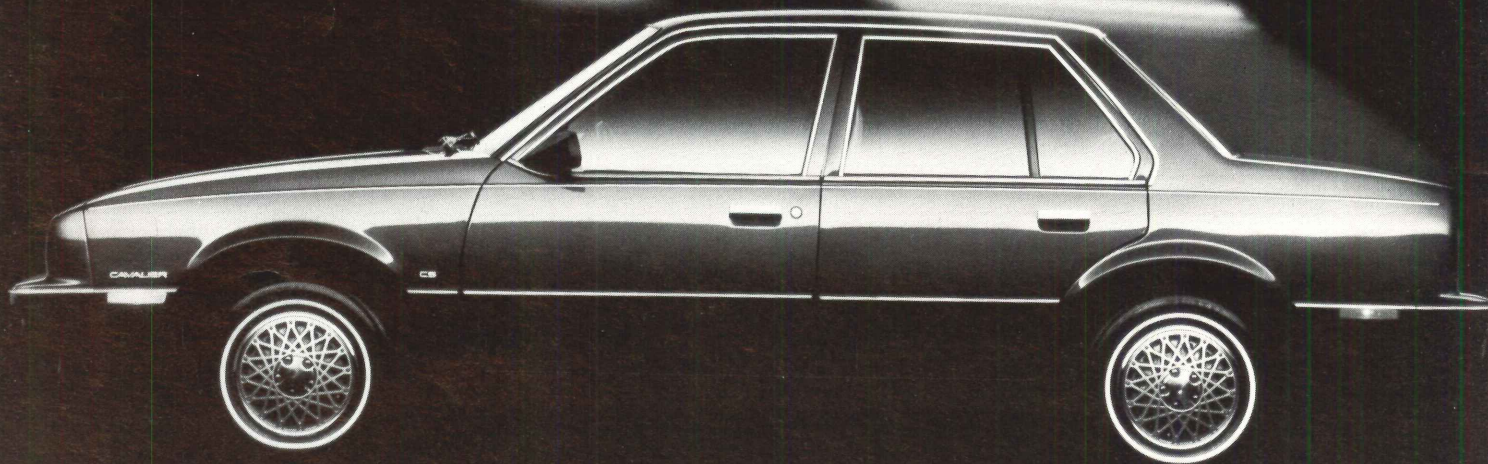

We feature GM cars
like this Chevrolet Cavalier.

National's new AIA rates are less costly by design.

National Car Rental is now a recognized supplier for the AIA. And for good reason: you'll be farther ahead per dollar with National. In their true perspective, you'll see our low daily AIA rates cost you less than the "other guys" in most major U.S. locations—especially when you compare our low rates to the other car rental companies' "discounts." And you can depend on National for top-quality cars and efficient, friendly service every time. We give you National attention® . . . and that's the truth.

National Car Rental®

For reservation or details, contact your travel consultant,
or call National toll-free at 800-CAR-RENT.SM



ARCHITECTURAL
TECHNOLOGY
 THE AMERICAN INSTITUTE OF ARCHITECTS

SPRING 1984

DESIGN ◆ PRACTICE ◆ MANAGEMENT ◆ REVIEW ◆ REPORT

The American Institute of Architects: Officers

George M. Notter, Jr., FAIA, *President*
 R. Bruce Patty, FAIA, *First Vice President*
 Gaines B. Hall, FAIA, *Vice President*
 Theodore F. Mariani, FAIA, *Vice President*
 Robert J. von Dohlen, FAIA, *Vice President*
 Harry Harmon, FAIA, *Secretary*
 Henry W. Schirmer, FAIA, *Treasurer*

Directors (Year indicates expiration of term)

Harry C. Hallenbeck, FAIA ('84), *California*
 Paul R. Neel, FAIA ('86), *California*
 Robert A. Odermatt, FAIA ('86), *California*
 William E. Patnaude, FAIA ('85), *California*
 John R. Birge, AIA ('85), *Central States*
 Larry K. Edmondson, AIA ('84), *Central States*
 Henry G. Meier, FAIA ('85), *East Central States*
 Howard Byron Bochiardy, FAIA ('85), *Florida/Caribbean*
 Ted Pappas, FAIA ('84), *Florida/Caribbean*
 Robert V.M. Harrison, FAIA ('84), *Gulf States*
 William W. Herrin, Jr., AIA ('86), *Gulf States*
 Donald J. Hackl, FAIA ('84), *Illinois*
 Almon J. Durkee, FAIA ('86), *Michigan*
 Samuel A. Anderson, III, AIA ('84), *Middle Atlantic*
 Leon Bridges, AIA ('86), *Middle Atlantic*
 Kenneth John Filarski, AIA ('85), *New England*
 G.W. Terry Rankine, FAIA ('86), *New England*
 Kenneth D. Wheeler, FAIA ('86), *New Jersey*
 Laszlo Papp, FAIA ('85), *New York*
 Peter Thomson, AIA ('84), *New York*
 David E. Lawson, AIA ('85), *North Central*
 Ray Crowder, AIA ('86), *Northwest*
 L. Jane Hastings, FAIA ('84), *Northwest*
 A. Nottley Alford, AIA ('85), *Ohio*
 Melvin Brecher, FAIA ('84), *Pennsylvania*
 Elizabeth B. Lee, AIA ('85), *South Atlantic*
 Raymond F. Stainback, Jr., FAIA ('86), *South Atlantic*
 Benjamin E. Brewer, Jr., FAIA ('85), *Texas*
 James E. Clutts, FAIA ('84), *Texas*
 M. Allen McCree, AIA ('86), *Texas*
 Philip Wade Dinsmore, AIA ('84), *Western Mountain*
 William C. Muchow, FAIA ('85), *Western Mountain*
 Robert D. Fox, ex officio, *President, ASC/AIA*
 Sandra M. Stickney, ex officio, *Chairman, ASC/AIA*
 Susan Stamborg, *Public Director*

Headquarters

The American Institute of Architects
 Louis L. Marines, *Executive Vice President/Chief Executive Officer*
 James A. Scheeler, FAIA, *Program Group Executive*
 Fred R. DeLuca, *Group Executive*
 Alan B. Stover, AIA, *General Counsel*
 Susan Allen, *Administrator, Institute Affairs*
 Michael B. Barker, AICP, *Administrator, Design*
 Francis X. Brown, *Administrator, Conventions/Conferences/Special Events*
 Muriel Campaglia, Hon. AIA, *Administrator, Public Relations*
 Joseph Crane, *Administrator, Government Affairs*
 James E. Ellison, AIA, *Administrator, Membership Services*
 Robert T. Packard, AIA, *Administrator, Practice*

AIA Service Corporation

James P. Cramer, *President/Chief Executive Officer*
 Susan Allen, *Assistant Secretary*
 Donald Canty, *Editor in Chief, Architecture*
 Fred R. DeLuca, *Assistant Treasurer*
 Sandra Dresser, *Senior Manager, Personnel*
 David S. Godfrey, *General Manager, AIA Press*
 C. Christopher Kelly, *Senior Manager, Business Management*
 Anna Maria Nunez, *Senior Manager, Marketing Group*
 Ronald J. Panciera, *Senior Manager, Accounting*
 Robert L. Petterson, *Senior Manager, Professional Systems*
 John H. Schruben, FAIA, *Senior Executive Manager, Business Development*

AIA Foundation

Charles R. Ince, Jr., *President*
 Earle Kennett, *Administrator, Research Division*
 Susan Stein, *Administrator, Arts and Education Division*

Magazine Group Publisher:

JAMES P. CRAMER

Managing Editor:

KAREN HAAS SMITH

Senior Editor:

OLIVER R. WITTE

Editorial Assistant:

AMY E. GRAY

Creative Director:

THOMAS L. MURPHY

Copy Editor:

SYLVIA S. CUTLER

Contributing Editors:

DOUGLAS E. GORDON, WILLIAM D. HOOPER, JR., AIA
 JOHN R. HOKE, JR., AIA

Art Direction:

MICHAEL DAVID BROWN, KATHLEEN WILMES HERRING,
 CARY HATCH, PETER LINCOLN DUNNIGAN,
 BARBARA RAAB—MDB COMMUNICATIONS

Senior Editorial Advisor:

ROBERT T. PACKARD, AIA

Editorial Advisors:

MICHAEL B. BARKER, JAMES E. ELLISON, AIA

Associate Publisher:

DAVID S. GODFREY

Midwest Sales Manager:

JOHN WILLIAM ROBERTS

Production Manager:

EDWARD L. KELSEY

Marketing Director:

ANNA MARIA NUNEZ

Circulation Manager:

SANDRA DUMONT

INSTRUCTIONS TO CONTRIBUTORS

Articles with graphics are invited on any subject relating to architectural technology, practice, and design. Preliminary calls or letters of inquiry are recommended. Address them to Managing Editor, or call (202) 626-7590. Include an outline and a plan for graphics, primarily drawings. All rights to published materials are retained by AIA. Corrections and comments from readers are welcome.

ARCHITECTURAL TECHNOLOGY, publication number ISSN0740-6142, is a magazine of The American Institute of Architects. It is published by the AIA Service Corp. at 1735 New York Ave. N.W., Washington, D.C. 20006, phone (202-626-7300). Copyright ©1984 by The American Institute of Architects. Opinions expressed are not necessarily those of the AIA. Vol. 2, No. 1. Single copies \$8. Eighteen month subscriptions (6 issues) \$36. Contact Circulation Manager (202) 626-7587. National Sales Office, Washington, D.C. (202) 626-7450. Midwest Sales Office, Chicago, Ill. (312) 441-7410.

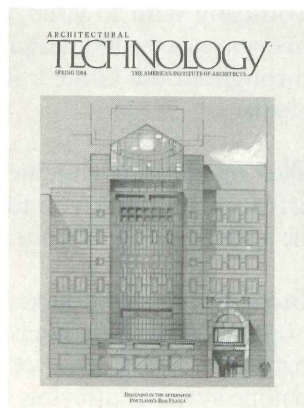

"The hair on my neck stands up when I hear 'post-modern' applied to our work," says Bob Frasca, FAIA, designer of the Institute for Advanced Biomedical Research in Portland, Oregon, shown on the cover. "The institute is not a look backward. It is as modern as a space ship, but it is conditioned by very personal sensibilities about what makes a splendid place to live and think." Story on page 6.

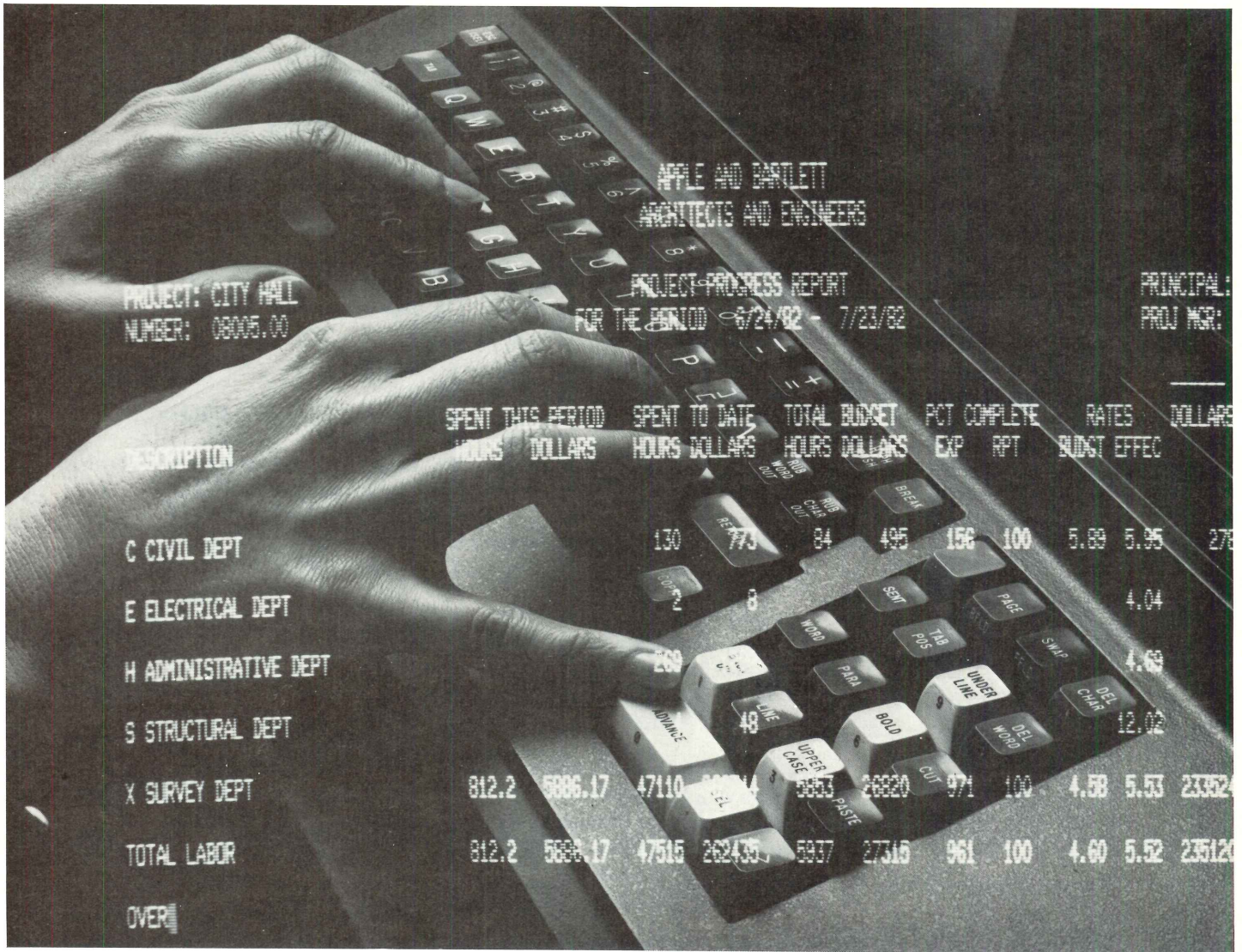

Harper and Shuman and CFMS

Consider the Advantages...

The most comprehensive, fully integrated computer-based financial management system available to architectural and engineering firms.

Created by, and specifically for, design professionals.

Sponsored by AIA and endorsed by NSPE/PEPP

A company with 10 years' experience serving nearly 400 design firms throughout the United States and Canada.

Skilled financial management specialists working with you to meet the specific needs of your firm.

A broad range of products and service options from a national time-sharing service to a variety of standalone systems utilizing in-house equipment from selected microcomputers to DEC/VAX and Prime.

For all the facts on the Harper and Shuman/CFMS advantages, call us today at 617-492-4410.

Harper and Shuman, Inc.
68 Moulton Street
Cambridge, MA 02138
617-492-4410

PRACTICE

- 6 "DON'T CALL IT POST-MODERN" BY ROBERT FRASCA, FAIA
Bob Frasca, designer of the Institute for Advanced Biomedical Research in Portland, Oregon, resists comparisons with Michael Graves' controversial Public Service Building in the same city.
- 10 WIRED FOR CHANGE BY GARY HALL
A comparative cost study of various office power, lighting, electronics and communications systems.
- 27 QUAKE CODES BY CHRISTOPHER ARNOLD, AIA
Seismic codes require architects to configure buildings for earthquake resistance, but give no design guidance. Chris Arnold discusses the codes, and gives solutions to common configuration problems.
- 35 ELECTRIC SUNSHINE
Two articles on solar electric systems, a space age technology about to come down to earth.
- PHOTOVOLTAICS DESIGN AND PROJECT GUIDE BY GEORGE ROYAL
A brief step-by-step guide to designing a residential pv system, with nomographs.
- EXPERTS ANSWER KEY QUESTIONS ABOUT PV SYSTEMS BY PAUL D. MAYCOCK
AND EDWARD N. STIREWALT
Market forecasts and discussion of major design issues.
- 44 ENVIRONMENTAL IMPACT CHART AND CHECKLIST
Two aids for practitioners developed by the AIA Regional Development and Natural Resources Committee.

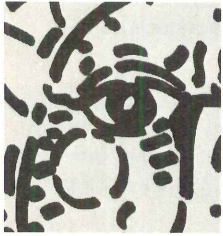

35

MANAGEMENT

- 50 CADD ROUNDTABLE
Fourteen CADD experts talk shop. Edited from the transcript of an AIA roundtable.
- 54 STAYING SMALL SUCCESSFULLY: Marketing is the Key
Highlights of a discussion of marketing issues at an AIA small firms roundtable.
- 58 OWNERSHIP TRANSITION: Agreeing on Price, Financing the Deal, and Making it Legal
The second of two articles on Ownership Transition by a group of knowledgeable practitioners, consultants, and attorneys.

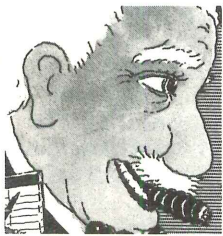

58

REVIEW

- 66 PRODUCTS
"HIGH TECH" ELEVATORS BY BARBARA GOLTER HELLER, AIA
- 69 BOOKS
- 70 SOFTWARE
COMPUTER-ASSISTED SCHEDULING FOR ARCHITECTS BY ROBERT J. KRAWCZYK

REPORT

- 76 MANAGEMENT
COMPUTERS
RESEARCH
LAW
DESIGN
CODES & STANDARDS
COMMITTEE NEWS

-
- DEPARTMENTS
- 4 LETTERS TO THE EDITOR
- 5 PERSPECTIVE
- 75 REFERENCES
- 88 LOW TECH

LETTERS TO THE EDITOR

... When I select a professional journal for subscription, I particularly seek useful credible information, inspiration, and direction. Consequently, I subscribe to very few. Most are so "fat" as to make it more convenient to photocopy the occasional worthwhile article from a library copy, or so "thin" as to provide only a starvation diet. TECHNOLOGY is neither "fat" nor "thin"; it is "lean" ... the main articles are long enough to say something substantive and short enough to know when to give further direction via reference listings ...

—*Fredric Lee McLaughlin*
East Lansing, Mich.

As the interesting "Genesis of a Tower" by Helmut Jahn, AIA, concludes, "Technology is not something you do, it's as much a part of the building as color or materials." As the means to the end, TECHNOLOGY should be one of the architect's most important tools ...

—*Scott Ellinwood, AIA*
Scott Ellinwood & Associates
Ventura, Calif.

... less than 10 percent of my time is spent on aesthetics ... it was becoming difficult to take the AIA seriously when, until now, the majority of practical information has been available to us mainly through other sources ... your new publication will be very valuable and ... will also serve to impart credibility to the AIA.

—*Jan Durocher, AIA*
Lewis/Nelson Associates
Bellevue, Wash.

Your initial issue is a strong and promising start though I profess some relief that I found the "E's" inside better mannered than the promiscuous fellow on your front cover ...

—*James Follensbee, AIA*
President, James Follensbee & Associates
Chicago, Ill.

The format was a breath of fresh air, concise, up to date, few ads, timely. A great supplement to "Architecture." Keep up the good work!

—*Thomas Gray, FAIA*
President, Wittenberg, Delony & Davidson, Inc.
Little Rock, Ark.

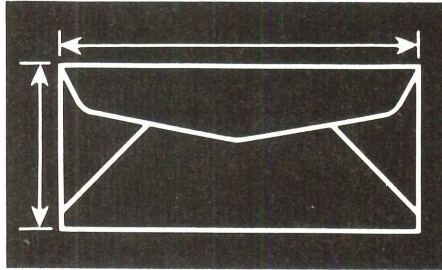

As an educator with a modest income and very limited opportunities to practice, I, and others in similar situations, have an ongoing internal debate relative to the benefits received through my membership in the AIA ... I had decided to resign my AIA membership this year ... then the first issue of ARCHITECTURAL TECHNOLOGY arrived and I changed my decision ...

—*D.W. Menzies, AIA*
Assoc. Professor, Dept. of Architecture
Washington State University
Fullman, Wash.

Just a short note of thanks for such a splendid new publication. All of us here feel you are fulfilling a much needed niche in the information network, and you certainly pulled it off with panache ...

—*Norton Wright*
Vice President, O'Donnell Wicklund
Pigozzi Architects, Inc.
Northbrook, Ill.

When I received the magazine, I had several quick reactions: Nice cover. My God, not another mailing from AIA! AIA must have too much money, or too many people, or both. Why don't they put all this boring technical and managerial stuff in four pages at the back of "Architecture" every month? Then ... I decided to re-read the magazine ... I believe the magazine can achieve the objectives clearly stated in the editorial, and that those objectives are of considerable value to the profession. I will look forward to future issues.

—*Robert Little, FAIA*
Robert A. Little Design & Architecture
Cleveland, Ohio

ADVICE AND DISSENT

On page 82 of your article entitled "The Pros and Cons of Prefab Panels," there appears to be an error concerning the installed cost of EIS panels. As I read the article, a typical cost range for an installed panel would vary between \$54 and \$135 per square foot. Perhaps this was not what

was intended. I look forward to future issues, and hope you will favor your readers with an index to previous articles, perhaps published in your year-end issue ...

—*David Henderson, AIA*
Wellborn Henderson Associates
Little Rock, Ark.

Author's Response: The correct sentence should read, "A typical cost range for an installed panel is \$6 to \$15 per pound per square foot, with most panels at \$9 per square foot."

Also, the name of the President of the Metal Lath/Steel Framing Association was misspelled. Our apologies to Frederick Marino, who is not Frederick Moreno.

The last sentence of your cover letter introducing our prospective new journal states "help us to help you." But between the covers is a product that itself desperately needs help ... A handsome cover, a dull name, a rational, but unimaginative graphic style, and a share of typos are features that can be forgiven, but ... the homogenous editorial approach that makes everything read like a promotional inflation of MEMO serves no one ... A journal that intends to be a professional reference but reads like a second rate airline magazine will get the respect of the latter ... As practicing architects, most of us have some respect for the integrity of the structural designer, for the integrity of the mechanical designer, and indeed for the integrity of the architectural designer. Why can't we produce a technical journal that not only expresses our respect for these integrities, but in fact is based on integrity?

—*Jeffrey Cook, AIA*
Professor of Architecture, Arizona State University
Tempe, Ariz.

It's nice to see that someone at the AIA is finally giving consideration to technical and management problems. However, I found the level of writing in each of the articles to be too basic—suitable reading for my architecture students. When is the AIA going to start providing technical information to its membership which can be immediately integrated into their practice?

—*James Canestaro, AIA*
Blacksburg, Va.

PERSPECTIVE

THINK OF US AS AN "IDEA BRIDGE"

ISOMETIMES HEAR IT SAID THAT ARCHITECTS LOOK BUT SELDOM read. Our experience indicates that architects read, but they are highly selective about what they read.

To read is to think. In this profession, there is much to think about. Change is continual, and there are always new opportunities.

ARCHITECTURAL TECHNOLOGY magazine was developed to provide AIA members with vital technical and practice management information needed in a changing profession. In short, to serve as an "idea bridge."

The responses to the reader survey that accompanied our premier issue helped us understand more precisely the information needs of the profession. The high number of responses gave us statistically valid information with a 5 percent margin of error and a 99 percent confidence interval.

AIA members confirmed that they are interested in receiving a publication addressing technical and management issues.

Ninety percent of the survey respondents said that keeping up-to-date on technical information was very important or extremely important to their work, and about 67 percent ranked practice management information as very important or extremely important.

The reaction to our pilot issue was consistently positive. Over 90 percent of the AIA members responding found the editorial content, overall design format, illustrations, and editorial style to be good, very good, or excellent. Eighty-five percent judged the format "just right" and over three-fourths indicated that ARCHITECTURAL TECHNOLOGY'S topic coverage was "just right"—neither too superficial nor too detailed.

Almost forty percent of the respondents spent 30 to 60 minutes reading the publication. About a third spent even more time—one to two hours—and 11 percent spent more than two hours. Ninety-five percent said that they planned to retain ARCHITECTURAL TECHNOLOGY for future reference.

We are gratified that AIA members have responded so well to our first issue. You, the readers, have helped us by answering key questions. Now here are the answers to several questions members often ask me about the magazine:

How much does ARCHITECTURAL TECHNOLOGY cost?

Each AIA member pays about \$4.65 through member dues to receive the magazine in 1984. The tentative business plan calls for members to pay \$9.50 of their dues for four issues a year in the future. Is it worth it? Robert Broshar, FAIA, one of the magazine's founders, summed it up well when he said "ARCHITECTURAL TECHNOLOGY is an exercise in cost-efficiency because it consolidates and focuses the AIA's technical and management information."

We have engaged an independent research analyst to tell us more about the value the members place on ARCHITECTURAL TECHNOLOGY and how it can be a more valuable resource.

What is the magazine's relationship to ARCHITECTURE magazine?

Since we also publish ARCHITECTURE, consideration was given to combining the content of ARCHITECTURAL TECHNOLOGY with that of ARCHITECTURE. However, our market research and journalistic judgment clearly indicated the wisdom of maintaining two very different publications.

Don Canty, editor-in-chief of ARCHITECTURE, summed it up well when he said, "ARCHITECTURE is about architecture as art and profession, and its end products in relation to the real world. ARCHITECTURAL TECHNOLOGY is about architecture as business and building science."

ARCHITECTURE is a monthly with beautiful color photography and creative journalism. ARCHITECTURAL TECHNOLOGY is a quarterly with straightforward coverage of technical and business management issues, illustrated primarily with black-and-white drawings.

We think there is a need for both publications.

Isn't the scope of the magazine too broad? Aren't you trying to be all things to all people?

We believe the magazine cannot focus on management and technical issues without also addressing design. In the words of former Institute Vice President Leroy Bean, AIA, "design ties it all together and gives the other elements meaning. In a nutshell, the magazine is a design, practice, and management review."

What's ahead for ARCHITECTURAL TECHNOLOGY?

Perhaps the best source of technical and practice management wisdom is the "reflective architect." We will be searching for and even coaxing those who can provide original observations, fresh approaches to new practice management issues, and interesting interpretations of experience to contribute ideas to the magazine. The AIA committees, conferences and roundtables provide a rich baseline of information. However, those most reluctant to speak out sometimes have the most to contribute.

Think of ARCHITECTURAL TECHNOLOGY as an idea bridge!

PRACTICE

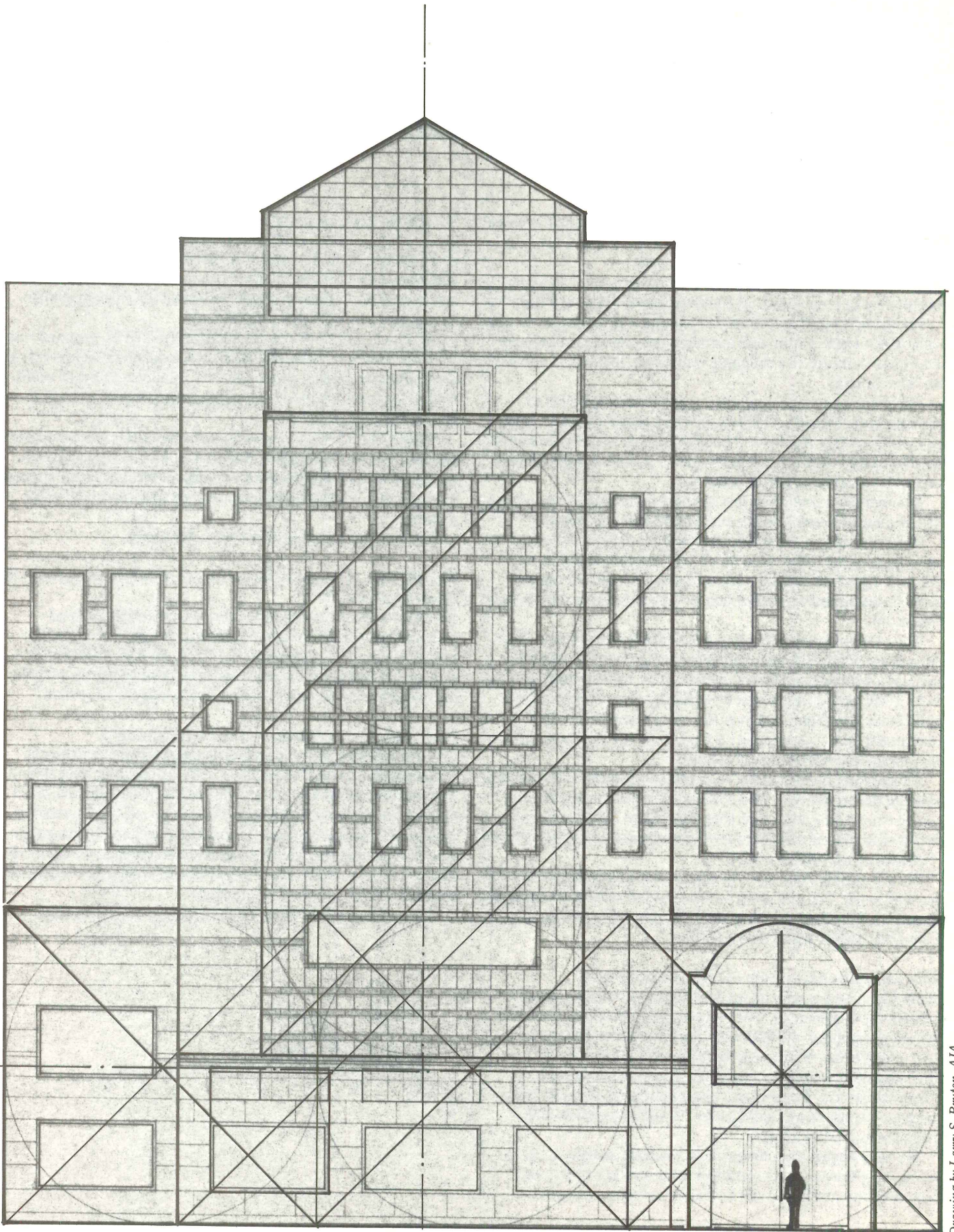

Drawing by Larry S. Bruton, AIA

“DON'T CALL IT POST-MODERN”

BY ROBERT J. FRASCA, FAIA

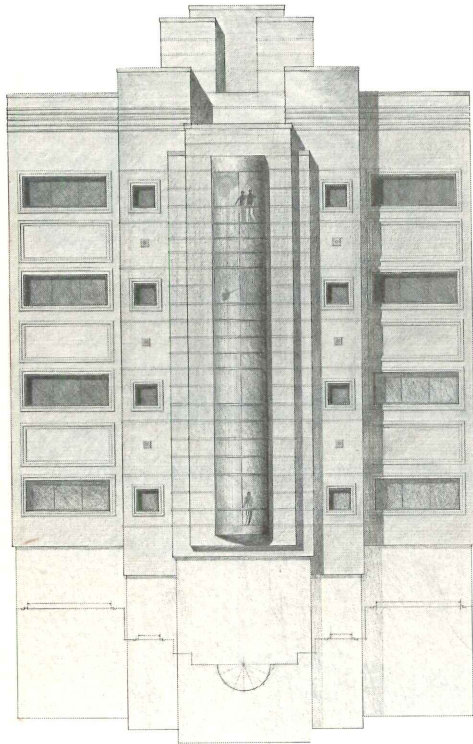

ABOVE: The north elevation, really the back of the institute, will overlook Portland from its Acropolis-like setting. A glass enclosed stairway will take advantage of the view. Mechanical shafts cap the building.

LEFT: The south elevation will be clad in pink terra cotta, making the surface seem to glow. The slender center section is pulled out and curved. Meeting rooms are on this side of the building.

BELOW: The institute (top) is squeezed on a 90 by 130 foot precipice that slopes 45 degrees to the back. Construction will begin in the summer and cost \$15.5 million for the 90,000 square feet.

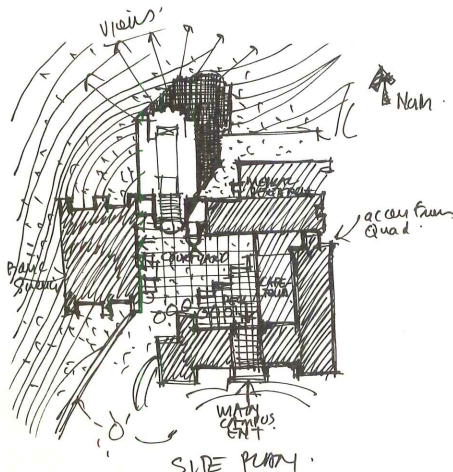

What happens to a good architectural firm in a medium-sized city when a powerfully influential work by an outsider rises on its turf? To find out, we turned to Portland, Oregon, site of the high temple of post-modernism, Michael Graves' Public Service Building, and home of Zimmer Gunsel Frasca, a 70 person design firm. Drawings are by Frasca, unless otherwise noted. — O. W.

THE CLIENT, THE Oregon Health Sciences University, wanted a world-class building that would stimulate world-class medical research. Tours of research labs at Brandeis, MIT, UCLA, Cal Tech, Salk and Scripps taught us how to satisfy the scientific needs.

But research is more than modern labs, and we became impressed with scientific results achieved in rather old facilities at Oxford and Cambridge in England. Their spaces, light, ceiling and materials were conducive to thought and satisfied important human needs. We also learned that the best science takes place if researchers interact.

Architecture contributes to good research if it solves technical needs in a humanistic way. Both are given equal significance, although different forms, in this building.

The south and north elevations (left page and upper left) are different because they express different uses. Further, the offset entry, variety of windows and greenhouse on the south elevation do not appear in the original sketches because the reasons for them had not emerged. In fact, the proportional study was an afterthought, proving only that aesthetic sensibilities applied to an evolving program can still produce classically good architecture.

Original architecture develops from unrelenting attention to technical and functional requirements, not from a stylistic predilection. The hair on my neck stands up when I hear “post-modern” applied to our work. The institute is not a look backward. It is as modern as a space ship, but it is conditioned by very personal sensibilities about what makes a splendid place to live and think.



View from Courtyard

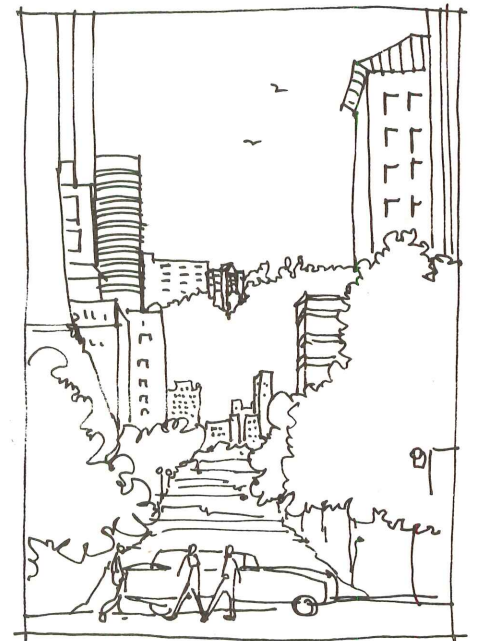

View of Brandeis from Downtown.

Integrating scientific and human needs

In designing a medical research building the architect must provide two environments: flexible laboratories with complex electrical, air, plumbing and waste services; and meeting areas where researchers can talk with each other and with visitors in groups of varying sizes.

Louis Kahn, in designing the Salk Institute, considered labs and meeting places totally different spaces. He separated them. We move them together so the scientists can move easily from one to the other. The section shown on the opposite page became the central planning concept.

The mechanical requirements for the labs provide the solution for the human needs. I don't know which came first. No way can I identify where technical and architectural problems begin and end.

The 18 foot floor to floor height, enabled us to create on the south side of the building spaces we call Oxbridge, where people can think, meet and exchange ideas. The area suggests Oxford and Cambridge university gothic: two-story libraries with mezzanines—comfortable places with operable wood windows, shutters and residential materials.

Researchers are pulled toward the Oxbridge spaces because they are adjacent to services such as elevators and restrooms.

To stimulate interaction between scientists on different floors, the meeting rooms are half way between lab levels off open stairways.

The lab level (upper right) shows how the labs surround the support space. Thus the windowless support space can get the climate control that science requires and the labs can have the windows and daylighting that scientists require.

A super-clean environment is provided in the lab section with positive air flow, frequent air changes and bio-hazard exhaust fans. Isolation with walls is not necessary to prevent contamination. Note also that the forms on top of the building derive from mechanical and research requirements. The axon view shows air movement through the building.

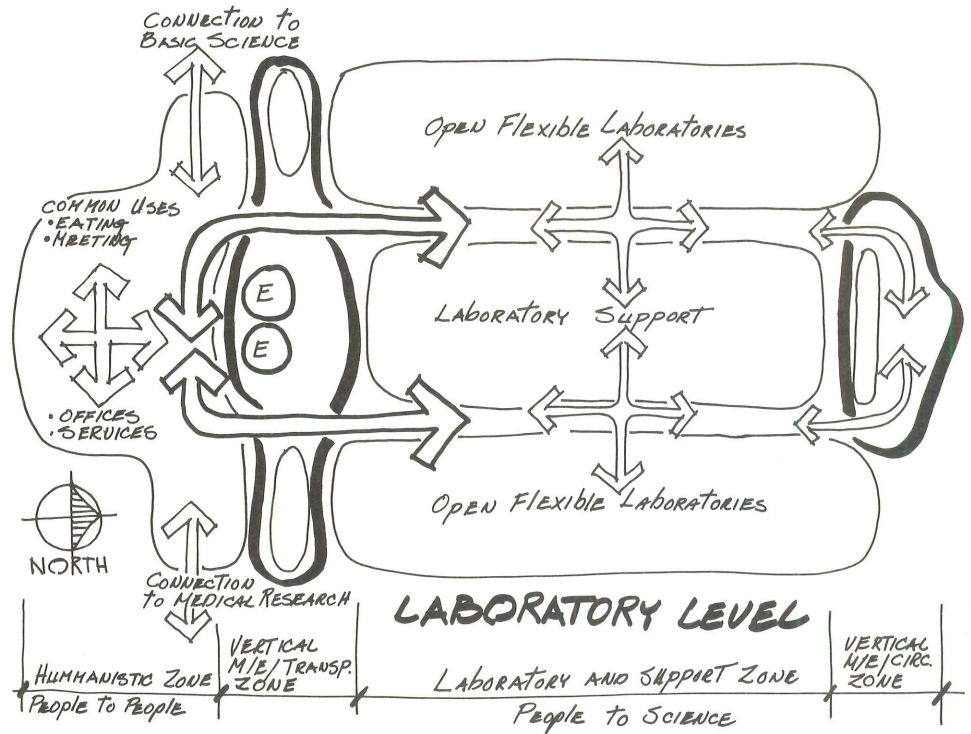

Drawing by Larry S. Bruton, AIA

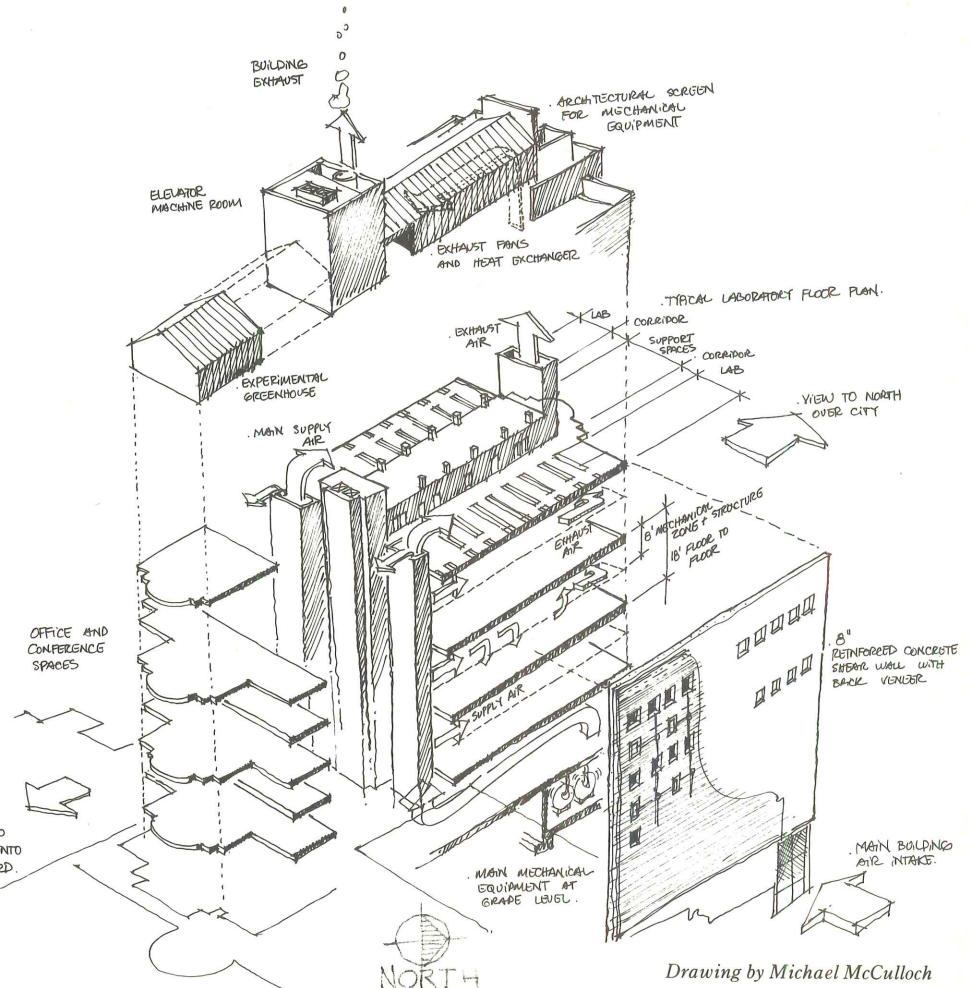

Drawing by Michael McCulloch

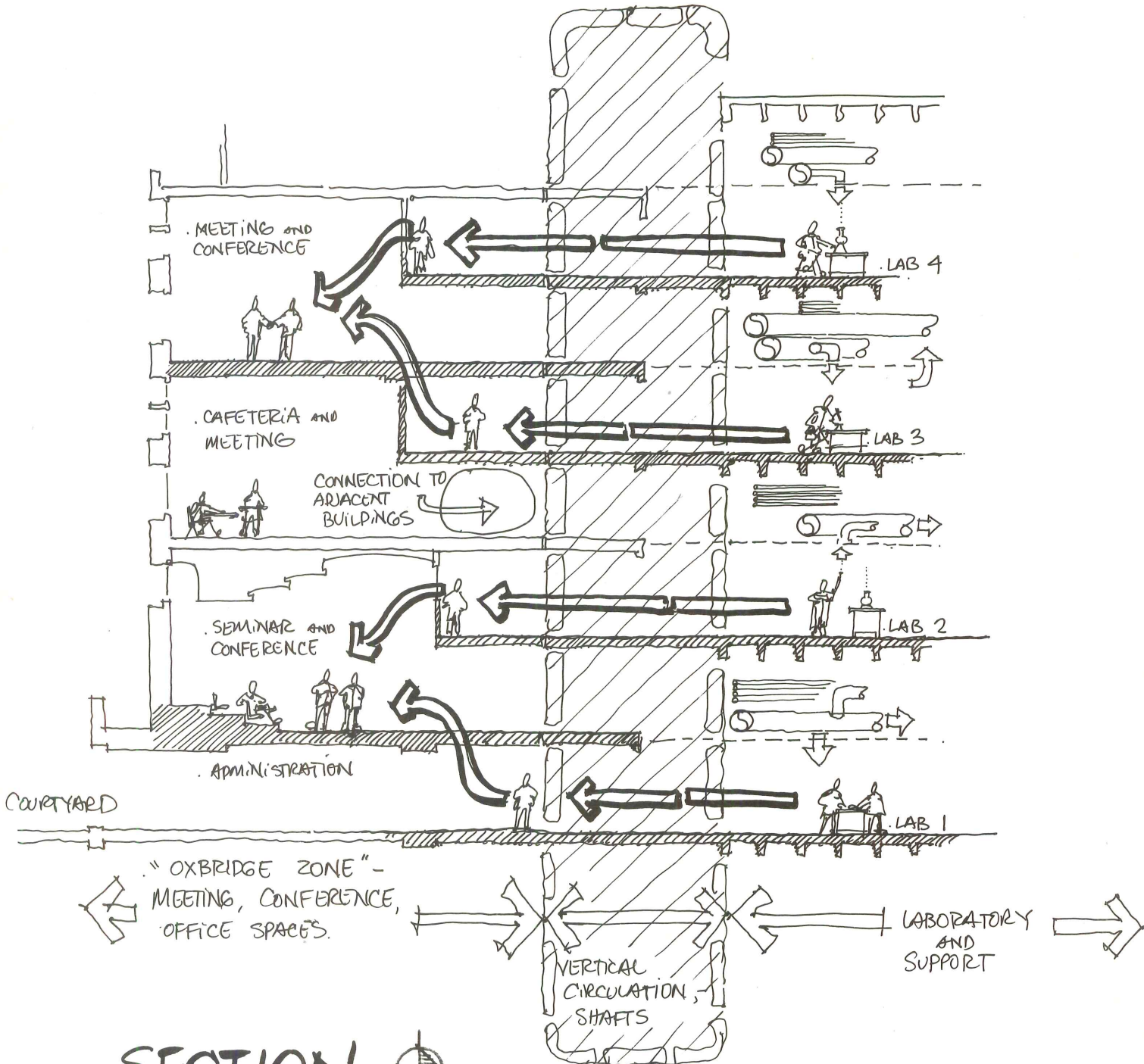

SECTION  NORTH

RELATIONSHIP OF "OXBRIDGE" AND LABORATORY SPACES

Drawing by Michael McCulloch

DESIGN TEAM

- Architects*—Zimmer Gunsul Frasca: Bob Frasca, Brooks Gunsul, Jack Cornwall, Larry Bruton and Michael McCulloch.
- Mechanical/Electrical Engineers*—Bouillion, Christofferson & Schairer: James Jenkins, partner in charge.
- Structural Engineers*—Kpff Consulting Engineers: Grant Davis, partner in charge.
- Laboratory Consultants*—Earl L. Walls Associates: Uli Lindner, associate in charge.

*The design process:
evolution and discovery*

The design process, by nature, is one of discovery. You learn a little about one aspect of a building and it teaches you something about another, and the design is modified to accommodate it. Often, these aspects involve an interplay between technical and human issues.

The early drawings of the south facade are easy to criticize as one-dimensional. They are based on superficial architectural notions—like a supergraphic in which historical and visual allusions substitute for the expression of interior function.

I'm not sure what post-modernism is, but in contrast to modernism, this building blends technology with human needs.

The first drawing (this page, upper left) is formal enough to be a Baroque church. The portholes allude to forms found on other campus buildings. The pediment was based on the incorrect assumption that the entire mechanical system would sit on top of the building.

Good things happen in the next drawing (this page, upper right) when we begin to differentiate between kinds of space inside. The lecture room appears on the second level. The floor-to-floors become more realistic and the building becomes taller and thinner.

The small sketches (center) deal with the emergence of a need for a greenhouse and a director's suite below. The greenhouse provides the building with a crystal-line crown.

But how to present it? The sketch (this page, lower left) has figures like parapets. Its medieval look finally seemed simply eccentric and dropped out.

The last sketch (this page, lower right) resolves the greenhouse treatment and its relationship with the balcony outside the director's suite. This is also the first drawing that avoids splitting the administrative space by setting the entry to the side. The plan view studies (opposite page) make the need obvious. This drawing also concludes the studies of sun shading for the windows.

The facade sketches (opposite page) study how to use our exterior material, terra cotta. The lower sketch shows the terra cotta reading vertically in the center and horizontally on the wings.

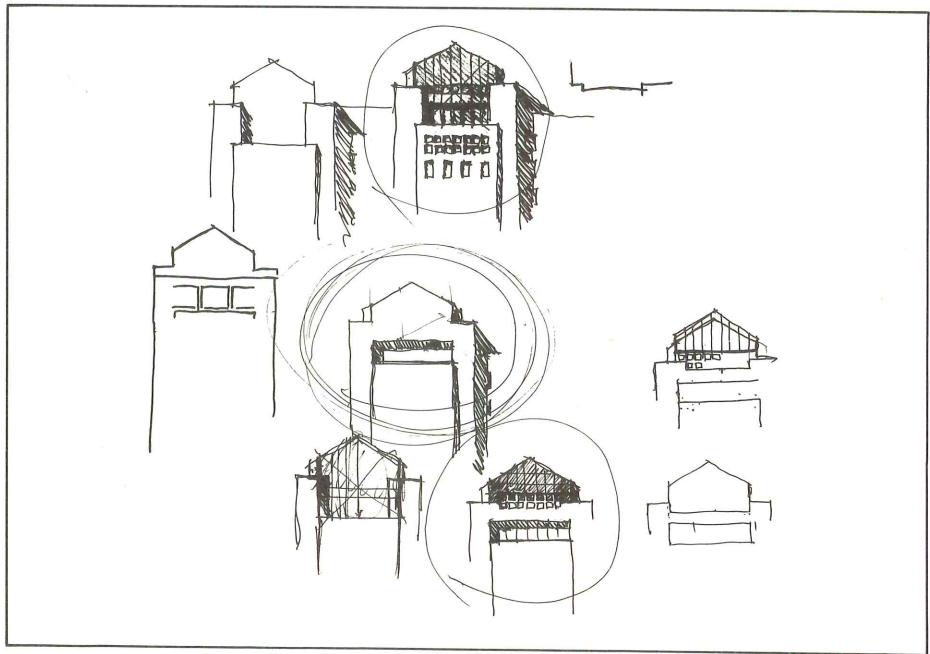
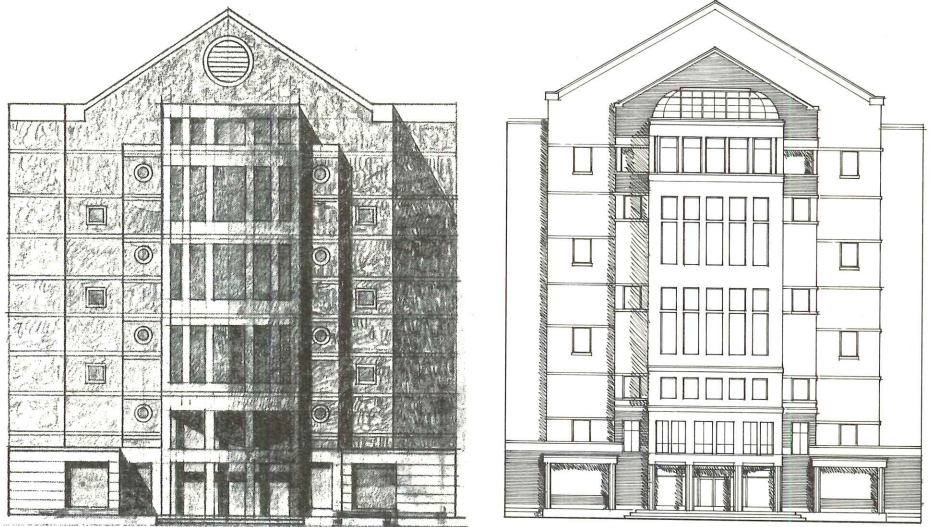

PRACTICE

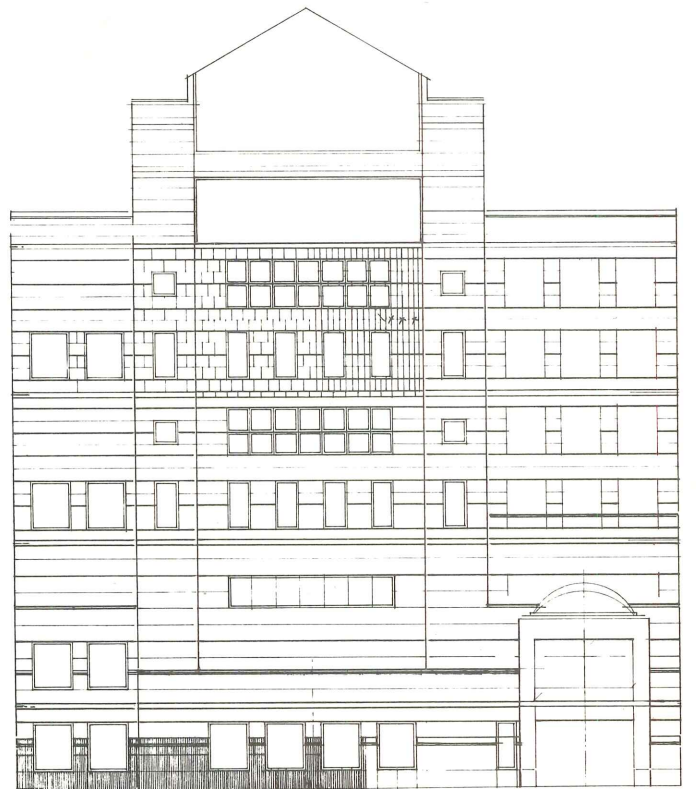
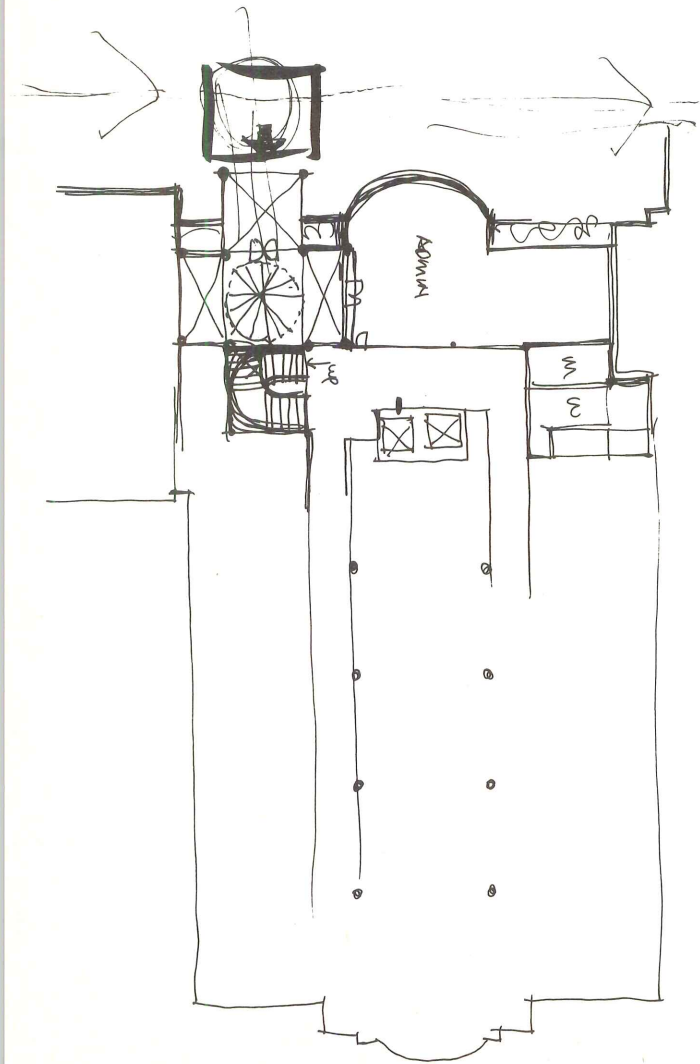
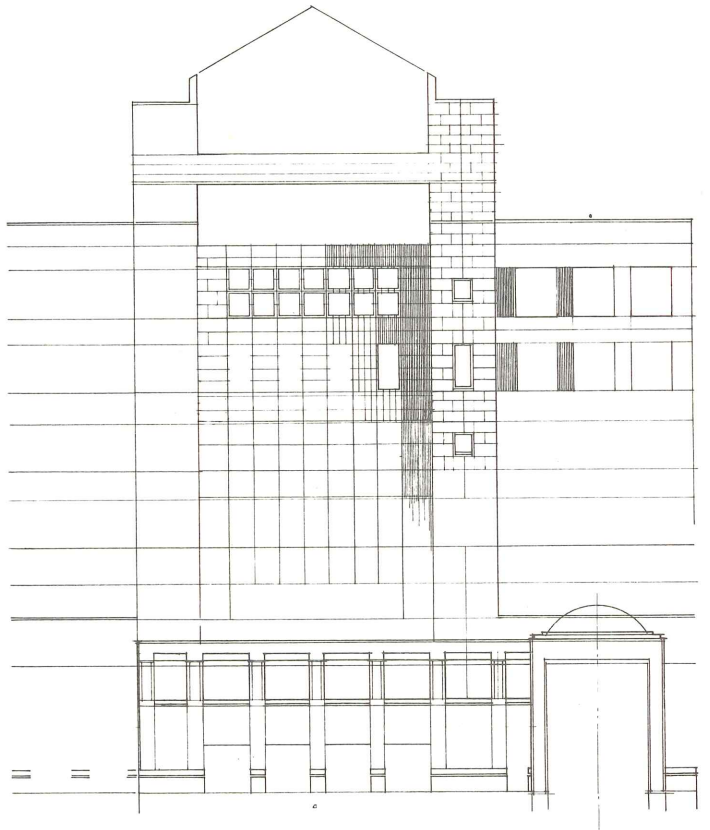
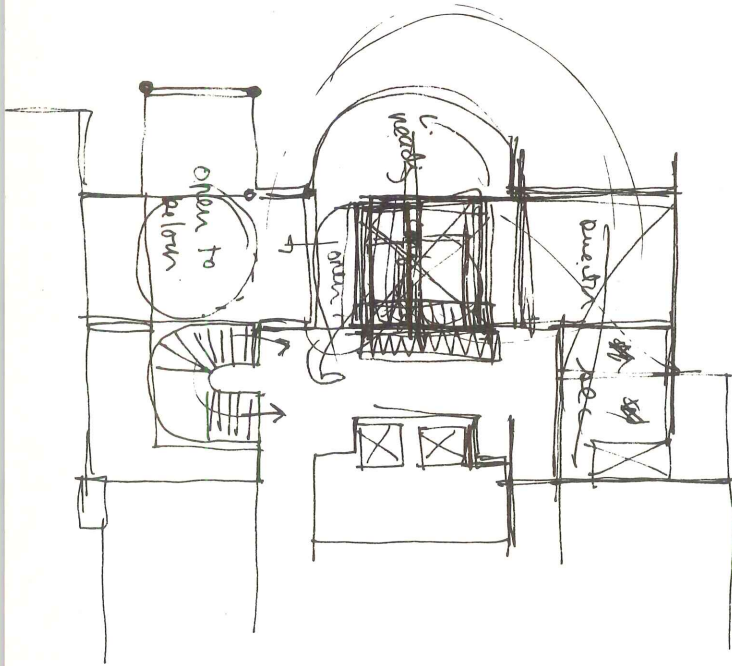

Rediscovering terra cotta: a glowing recommendation

Terra cotta was chosen as the exterior material for the south face of the institute primarily because it has the unique quality of glowing in the typically overcast Portland light.

It is an attractive treatment for the south facade, which is seen close-up from the rather intimate courtyard.

Terra cotta also accommodates the variety of window shapes to condition natural light and avoid excessive heat gain on this unairconditioned side of the building. Further, terra cotta offers total color flexibility, unlike any other material. Controlling the shades of pink we wanted, and maintaining their consistency is much easier than with, say, stone.

But using it properly required a lot of learning and rediscovery. It was important to us to use the material honestly and effectively, but not to ask more than it could deliver. Terra cotta is an extruded, glazed clay — lighter and more versatile than stone. The optimum size is about 18 by 24 inches. Much larger sizes risk warping when the clay is cooked; smaller sizes take longer to install. Economy is achieved by sticking to standard forms and limiting custom formed pieces.

From the basic extrusion form (opposite page, upper left), a series of panels are to be sawed or knocked apart along dotted lines or scorings. Note the use of Panel a and Panel b pieces in the window frame drawing (opposite page, lower left).

The window frame drawing also shows how terra cotta pieces serve as both form and finish surface for reinforcing bars. The upper surface is glazed and sloped so water runs off cleanly.

From the manufacturer, we learned that we could get reveals at the edges of the material, as shown in the typical exterior wall cladding (right). Thus we could have concealed joints on at least half the joinings. We wanted to minimize the joint lines because they often bleed and the grout gets dirty.

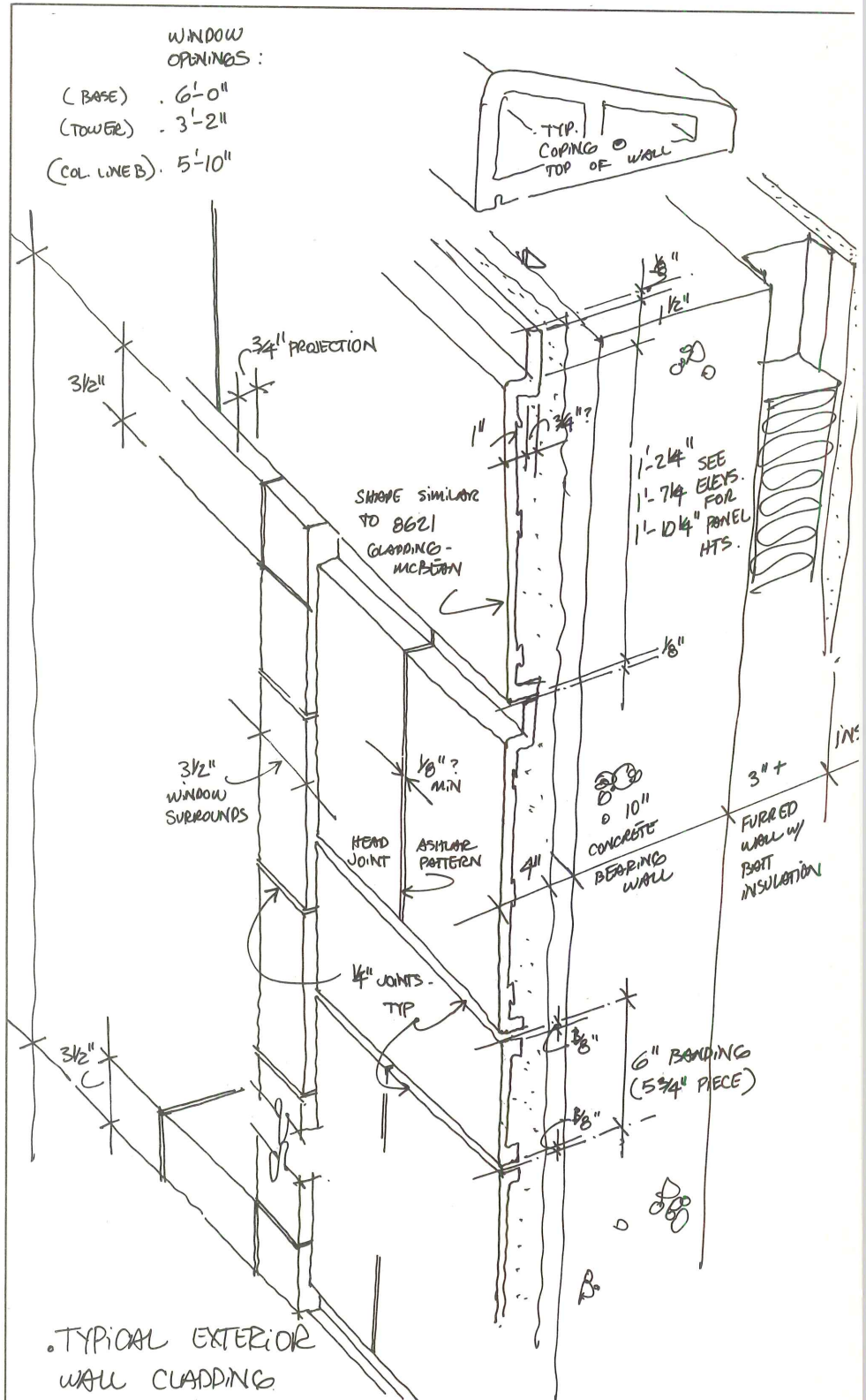

. TYPICAL EXTERIOR
WALL CLADDING

· I.A.B.R. 8063.03 NO SCALE
 · ZGF ARCHITECTS.
 · 2.14.84.

Drawings by Michael McCulloch

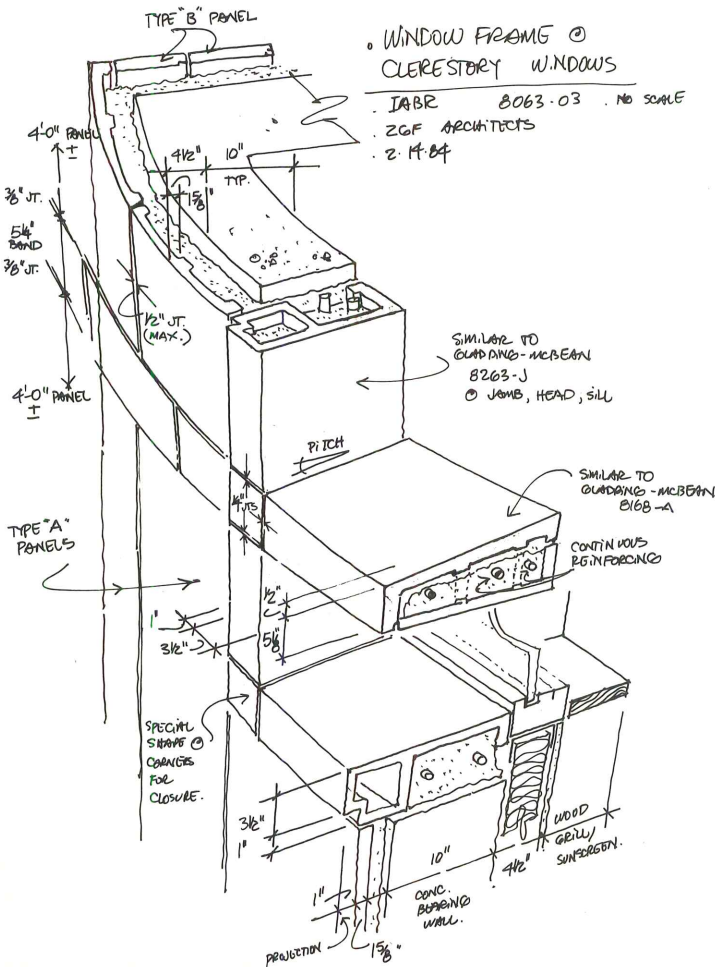
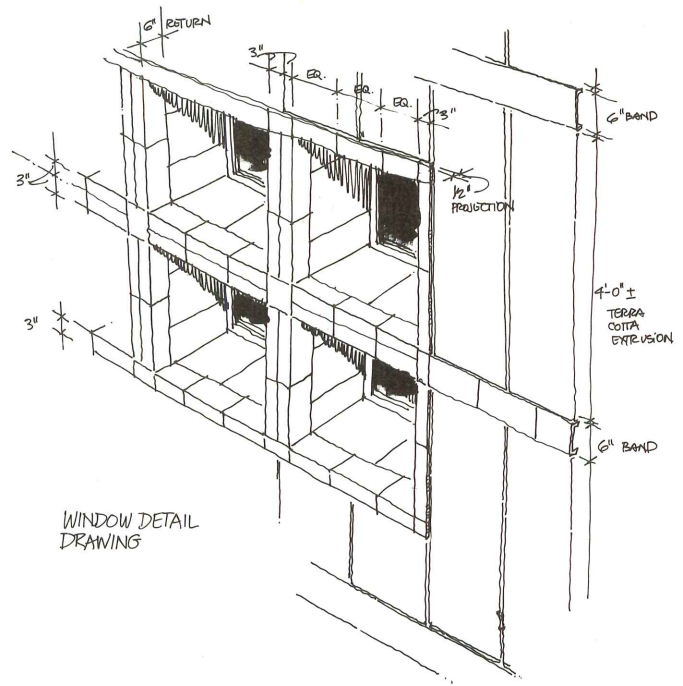
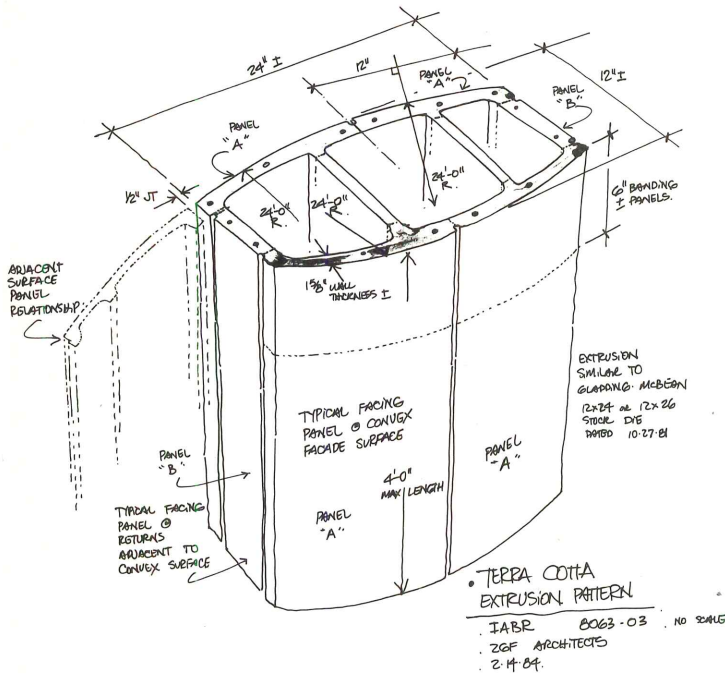

LESSONS LEARNED IN TERRA COTTA

- Perhaps the most important thing to learn about terra cotta is how it is extruded. It is easily scored and broken or cut apart later, and it can be curved, although only in one direction. Our early drawings treated the terra cotta as if it were available only in flat pieces, like tile. Any shape that can be extruded and cut off is permissible, but the dominant line will be in one direction. The direction of the extrusion generally establishes the joint pattern.
- Although terra cotta, being clay, is quite flexible, custom molds cost about \$3,000 each. The manufacturer has hundreds of stock molds of proven effectiveness. We made maximum use of them.
- Our first drawings with terra cotta displayed no sense of optimum scale. The ideal size is about 18 by 24 inches. Larger pieces tend to warp when they are cooked. Smaller pieces not only mean higher installation cost but also more mortar joints. We used eight typical extrusions and eight custom shapes.
- A visit to the plant was invaluable. We toured Gladding, McBean & Co., Lincoln, Calif., one of the last manufacturers on the West Coast. Plant manager Tom Sawyer loaned us magazines from the 1920s and 1930s when terra cotta was in vogue and helped us rediscover what has almost become a lost art. We sent our drawings to him and incorporated his suggestions.
- Don't try to make terra cotta look like stone or as if it were a bearing surface. Larger pieces at the bottom and smaller ones at the top would be inappropriate.
- Terra cotta is light, can be formed as desired, takes virtually any pigment and when glazed forms a hard (if thin) surface that's impervious to weather.

WIRED FOR CHANGE

Planning for changes in office power, lighting, electronics and communications systems

BY GARY HALL

THE OFFICE OF the future is arriving faster than the building of today can support it. Work stations are overflowing with computers, disk drives, modems, printers, plotters, digitizers, VDTs, communication equipment, lighting sources and other personal and professional electronic gear.

This unplanned proliferation presents office designers with a problem that affects aesthetics, costs, safety and productivity.

The most visible signs of trouble are the wires and cables draped behind desks, under foot, across aisles and through ceilings, walls and floors. Less visible are the floor outlet boxes often left in awkward locations when open office furniture is moved.

The solution is easier to state than to implement: Wire and cable management must be treated as a single issue crossing architectural, structural, electrical and interior design disciplines. No longer is it acceptable to deal separately with power, lighting, electronics and communications (PLEC). PLEC is an integrated life-support concept, the same as HVAC.

Open office plans and portable furniture and partitions will not assure flexibility and mobility if the building itself cannot accommodate change. Inadequate provision for PLEC distribution through the building and delivery to the work station means that even minor changes in office layout will require extensive and costly rewiring.

Designers often complain that initial costs for an adequate PLEC system would be too high and, in any case, relocation costs can be passed on to the tenant. These assumptions are often not entirely true. In some cases, the building team has simply failed to analyze the PLEC options.

Gary A. Hall is director of electrical engineering and a vice president of Hammel Green and Abrahamson, an A/E firm in Minneapolis.

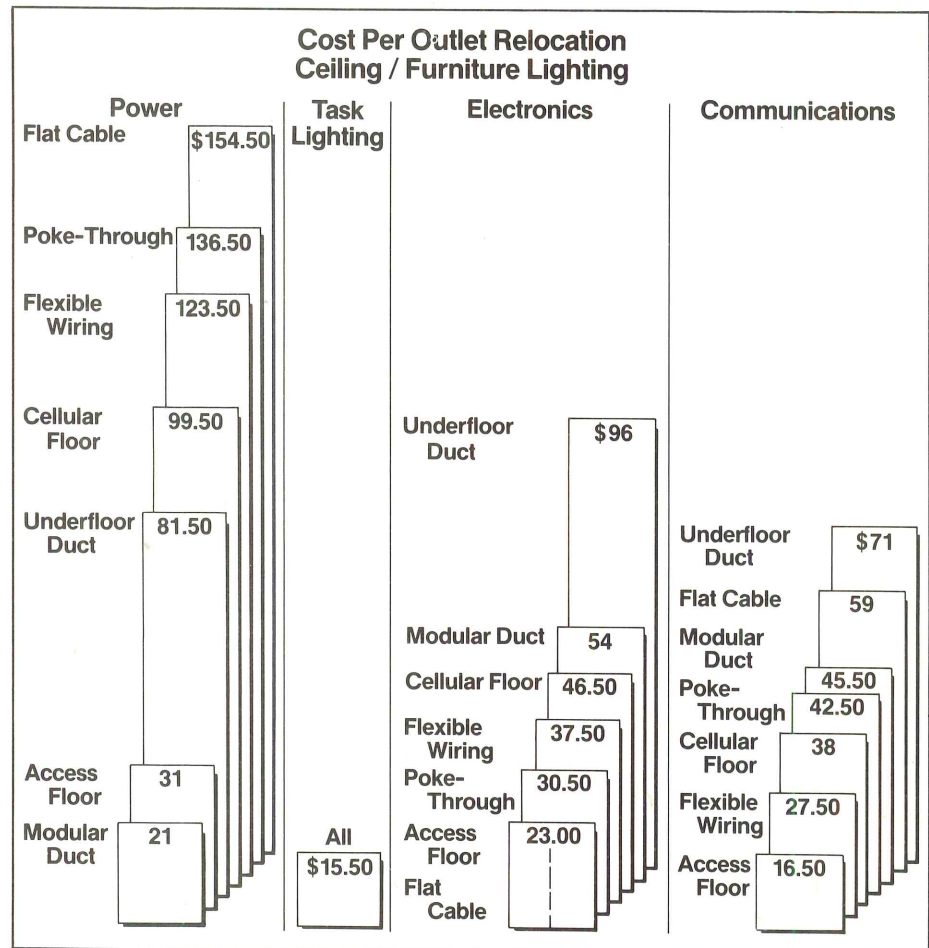

Analysis has been difficult because of the lack of a systematic way to compare PLEC services. Although the AIA and the Construction Products Manufacturers Council have been cooperating for five years in PLEC education, it is not possible to choose a single product that integrates power, lighting, electronics (the cabling that links computers) and communication. Thus systems must be combined to permit a fair analysis of cost and function.

To facilitate comparison, a decision-making model was developed by our firm, Hammel Green and Abrahamson of Minneapolis. It puts the seven generic systems for PLEC delivery on the same footing.

None of the seven, listed at the left and right on these pages and illustrated on following pages, can be specified as a single system; all must be supplemented with one or more services to equalize them. For example, flat cable provides power, furniture lighting and communications; electronics service is limited and it must be supplemented with either hardwire conduit or flexible wiring to provide ceiling lighting.

For cost comparison, systems are viewed as equal where PLEC capability is functionally equal.

HGA's model analyzes costs for installation, additional outlets and relocation of 20

**Share of Market
PLEC Systems
Owner Occupied Offices**

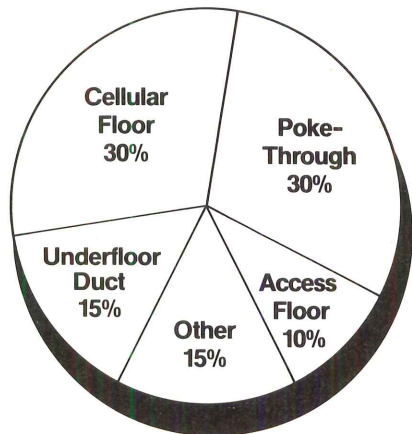

Source:
Hammel Green and Abrahamson

percent of the work stations annually. Costs were compared separately for three lighting techniques: ceiling lighting, furniture lighting and a combination of ambient ceiling lighting and task furniture lighting.

For each of the 21 combinations of wiring systems and lighting techniques, HGA prepared one-eighth inch scale plans and specifications from which a Minneapolis contractor, Sterling Electric, did an itemized take-off. Costs assumed delivery in the fourth quarter of 1984 and 7 percent inflation. Material prices reflect discount selling prices, 6 percent sales tax and 5 percent profit. Labor was figured at \$28 an hour plus 10 percent overhead and profit. Labor to install lighting fixtures was included, but not the cost of the fixtures. Cost penalties applied to some systems are described on following pages.

Program assumptions included construction of an owner-occupied commercial office building with an area per floor of 24,000 square feet gross, 22,500 square feet net and 18,900 square feet in open plan. The structure could be either steel or concrete, but floors were required to have a two-hour fire rating.

Work station density averaged one for 120 square feet, making 188 work stations, each designed with power outlets, a computer and a phone.

Major conclusions include:

- All the systems except underfloor duct are close enough in price to leave room for analysis based on considerations other than cost. Since the study was

completed, HGA has specified most of the wire management options studied here, sometimes more than one in the same building.

- All seven PLEC systems are least expensive over five years with ceiling lighting. They are most expensive with furniture lighting. For example, the life-cycle cost of poke-through is \$3.02 a square foot with ceiling lighting and \$4.85 a square foot with furniture lighting. Costs are incurred to re-locate lighting sources in furniture; fixtures need not be moved in offices lighted solely from the ceiling. If the only consideration is first cost, rankings vary with lighting technique, making early coordination among designers especially important. Combined furniture and ceiling lighting was chosen for the chart at the lower right because it is the most common for open offices.
 - The choice of lighting technique does not make a great deal of difference in the rankings of most PLEC systems on the basis of life-cycle costs. The most significant exception is with modular plug-in duct, which comes in third (\$5.38 a square foot) with combined ceiling/furniture lighting, second with ceiling lighting, and becomes the least expensive option, at \$5.41 a square foot over five years, with furniture lighting.
- The point is that the A/E must take the lead in developing a method of PLEC analysis so that appropriate and timely

decisions can be made in the best interest of the owner or tenant. Specific cost rankings will depend on the owner, building and local costs. Further repositioning also may be expected as the technology of wire management develops. Cellular floor systems are improving. Flat cable and access floor are likely to gain market share. Even poke-through has become more efficient with the development of a single outlet through which all PLEC service can pass.

The following pages summarize HGA's analysis of seven PLEC systems for costs, capabilities, limitations, unique requirements and lighting options.

COST VS. FLEXIBILITY

Because the installation cost for poke-through is so low, it is often assumed that its relocation cost is high. And conversely, because the relocation cost of access floor is so low, its first cost is assumed to be huge.

Happily, the HGA study of seven PLEC wire management systems confirms the low costs, but not the opposite extreme. The conclusion is that designers might consider poke-through for more than speculative offices and access floor for more than computer rooms.

POKE-THROUGH

Poke-through, for example, turned out to be the least expensive PLEC system, both initially and over five years of office change, under ceiling and ceiling/furniture

**PLEC Life Cycle Costs
Ceiling / Furniture Lighting
Cost Per Square Foot**

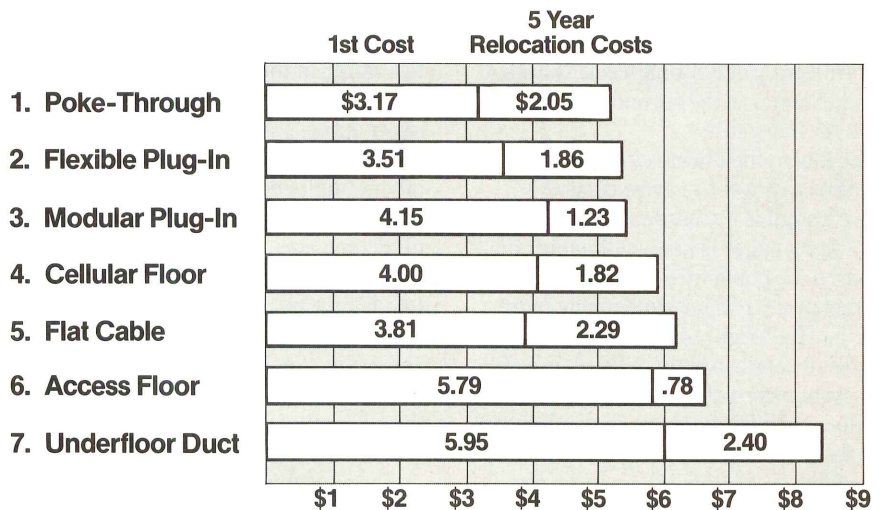

Poke-through and access have lowest five-year cost

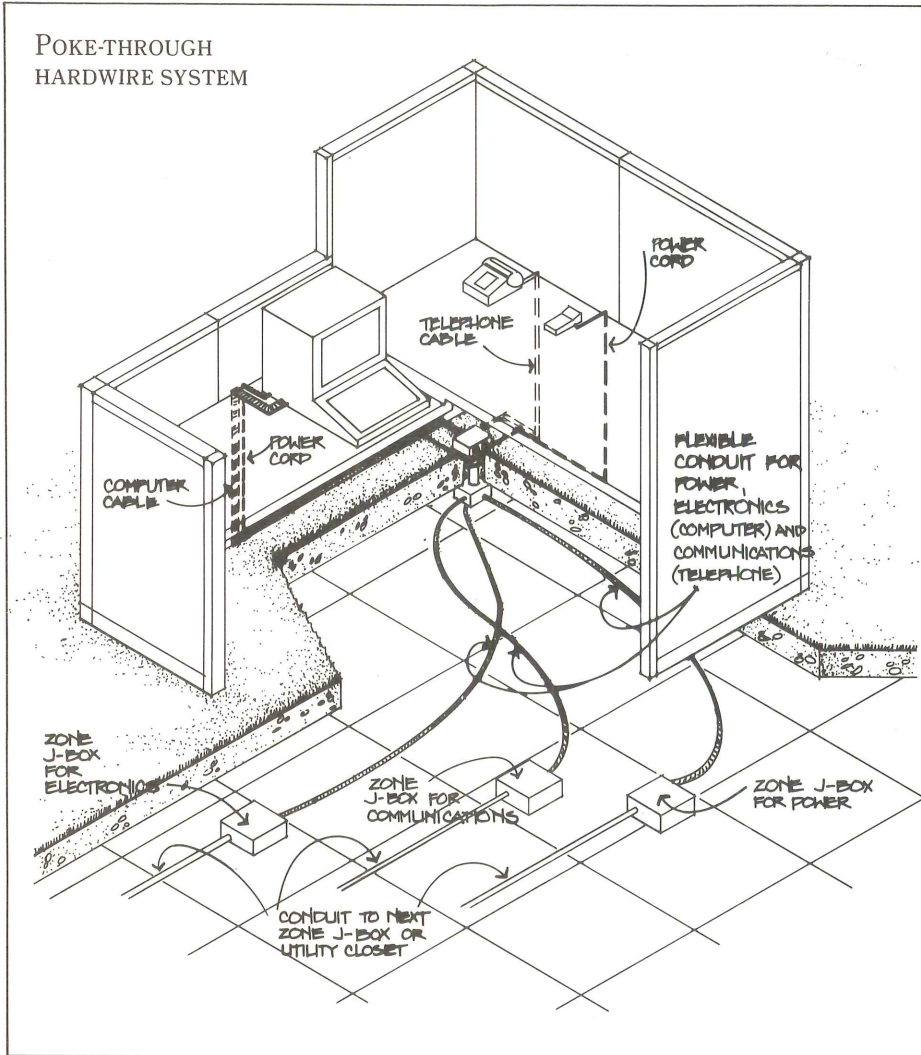

about four inches above the floor, must be placed where it is accessible but not in the way. The major limitation is mobility. All changes, including relocation and expansion, require an electrician. Rules on the number of holes permitted in the floor must be strictly observed in order to maintain the fire rating of the floor.

Here is an example of how HGA calculated poke-through installation and life-cycle costs under ceiling/furniture lighting:

	First Costs	
Materials		\$ 31,533
Labor		44,532
Subtotal		\$ 76,065
	Relocation Costs Per Work Station	
Power	\$	135.50
Lighting		15.50
Electronics		30.50
Communication		42.50
Subtotal	\$	225
Times 38 stations moved		8,550
Second year, 7% inflation	+	9,149
Third year, 7% inflation	+	9,798
Fourth year, 7% inflation	+	10,474
Fifth year, 7% inflation	+	11,207
Subtotal		49,178
Plus first costs		76,065
Total costs		\$125,243
Divide by 24,000 sq. ft.		
Life Cycle Cost/sq. ft.		\$5.22

lighting. With all lighting delivered from the furniture, poke-through cost the least to install and was the second-least expensive over five years.

The key to the lower relocation costs (and thus to lower life-cycle costs) for poke-through is the assumption that the building manager is knowledgeable and prepared to shop hard for a reasonable contract price. It is possible to pay more than the HGA figures, but not necessary.

Poke-through, strictly defined, is a delivery system consisting of a fire-rated fitting and floor outlet assembly. The outlets are installed either by core drilling the concrete floor slab (the method assumed for this analysis) or by activating preset sleeves

installed within the slab. To maintain the fire rating of the concrete floor, outlets are limited to one per 65 square feet. A carpet-saver option improves floor aesthetics when outlets are abandoned. Poke-through usually is employed with a traditional hardwire distribution system employing conduit and junction boxes.

Conduit distributes all PLEC services for all lighting options and it forms the delivery system for lighting with ceiling and ceiling/furniture lighting. Otherwise, the HGA analysis assumes that poke-through outlets deliver the PLEC services to the work station.

The system provides adequate flexibility, although the outlet, which stands

ACCESS FLOOR

Although it's true that access floor is expensive to install, it loses to underfloor duct by only about 75 cents a square foot with ceiling and ceiling/furniture lighting, and turns out to be 37 cents a square foot less expensive than underfloor duct with furniture lighting. With most other PLEC systems, it ranges from 73 cents to \$1.98 a square foot more expensive, depending on the system and lighting technique.

The first-cost premium for access floor can hardly be disregarded, but it still falls far short of typical "guesstimates."

On the other hand, claims that access floor makes wiring changes so easy that they can be done by janitors or secretaries at virtually no cost are difficult to apply to

most owners. The HGA analysis makes the same relocation cost assumption for access floor as for poke-through—that a knowledgeable owner will shop hard for contract services. If the owner is prepared to make another assumption, the A/E can take it into account.

A/Es should also ascertain how often the owner is likely to reorganize and how much of the office is likely to be involved. It would take a much faster rate of change or a much longer life cycle than this analysis assumes to recover the difference between the first cost of poke-through and access floor.

Access floor, also called raised floor, consists of metal panels supported on pedestals 4 to 12 inches above the structural floor. The panels, usually 2 by 2 feet, can be removed to give convenient access to the floor plenum. Panels are covered with carpet squares or tile. Outlets, usually flush with the floor, are installed in panel cutouts where required.

Both distribution and delivery of PLEC services are provided through the floor plenum. Power may be enclosed in hard-wire or flexible conduit, but electronics and communication can be installed without raceways when the floor is not used as an open plenum for HVAC.

Because access floor does not provide for ceiling lighting, supplementary hard-wire or flexible conduit is required in the ceiling plenum. Task lighting can be provided to the furniture from the same system used for power delivery. Electronics and communication are delivered normally through the floor plenum.

A loss-of-space penalty is often assessed against access floor because some A/Es assume that the floor-to-floor distance must be increased. The penalty was not applied in this analysis because it might not be required. In reaching a decision on a specific building, the A/E should consider floor slab depth, beam depth, HVAC duct requirements, recessed light fixtures and raceways, ceiling structure and floor-to-ceiling height.

For example, if six inches are required for lighting fixtures and raceways in the ceiling plenum, and ceiling lighting is eliminated in favor of furniture lighting, the six

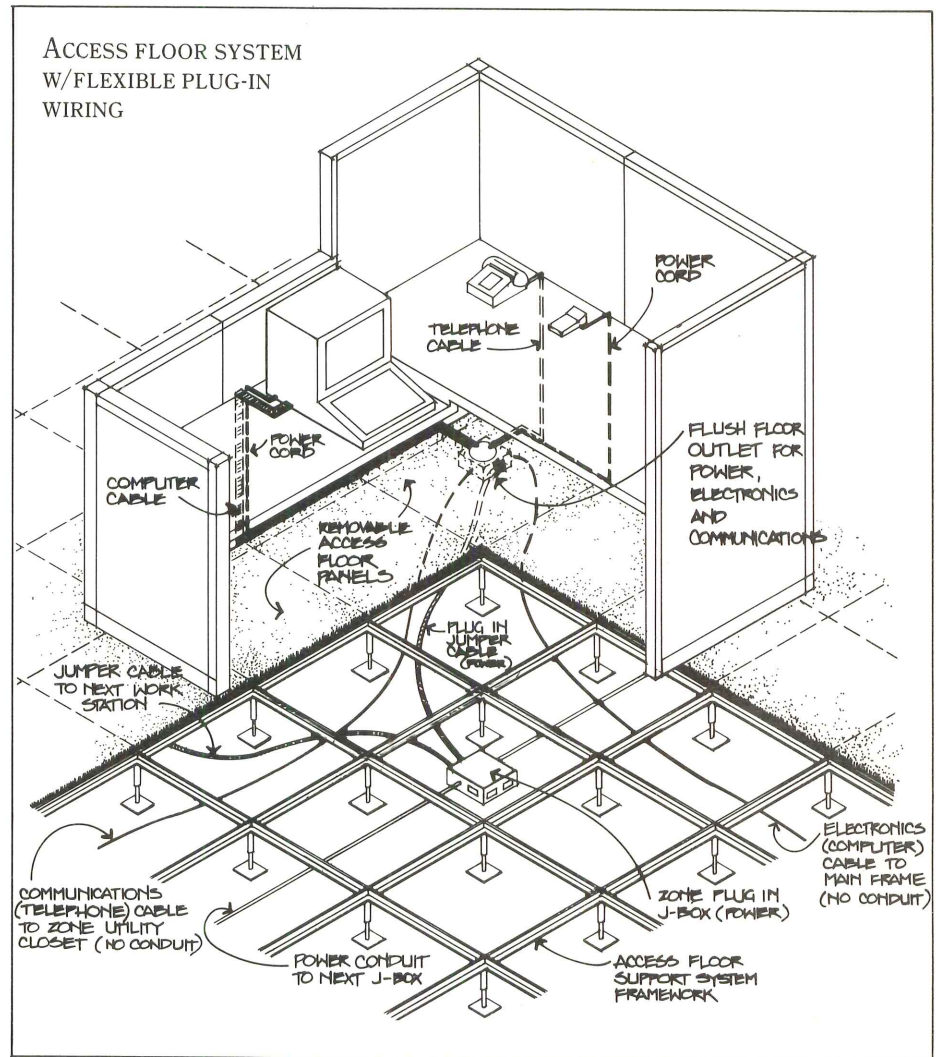

inches can be transferred to the floor plenum without a loss of floor-to-ceiling space.

Further, if HVAC ducts in the ceiling plenum require a 12-inch depth and the duct system is moved into an access floor of the same depth, the building height is not affected.

Finally, the ideal floor-to-ceiling height might be 9 feet, but 8 feet 6 inches could be acceptable given the improved PLEC flexibility.

Access floor sometimes is given a credit because it permits economies in concrete floor slab finishing. Again, the credit was not allowed because of variables unique to a specific building design.

The advantages of access floor include:

- Total flexibility in the placement of outlets. Thus furniture with built-in wire management capability is not needed, regardless of lighting technique.
- Virtually unlimited capacity to expand PLEC services. Changes can be made simply by removing floor panels and reconnecting service. The floor below is not disturbed, overhead ladder work is eliminated and labor hours are reduced.
- Plenum space can be used for HVAC.
- Factory installation of carpet squares might be less expensive than field installation of the squares.

Access floor limitations include the need to plan for adequate floor loading. Older access floors had a wobbly feeling. Some

Plug-in systems: best of two worlds

newer ones are designed with concrete panel fill and are intended to be screwed down, but they still don't provide as solid a feel as walking on concrete.

MODULAR PLUG-IN DUCT

The hallmarks of modular plug-in duct and flexible plug-in wiring are their flexibility (meaning that they can provide PLEC service precisely where it's wanted) and their mobility (ease of relocation) due in part to their use of plugs to make connections. Both are designed for use in ceiling plenums, although flexible plug-in wiring also can be used in access floor (as illustrated in the drawing on the previous page). And both are among the life-cycle cost leaders.

But the similarities pretty much end there. Their aesthetics are different and so are other important characteristics.

Modular plug-in duct uses power poles (metal channels) to deliver PLEC services from the ceiling to the work station. The drawing on page 21 shows the system with ceiling lighting. With furniture lighting, all four PLEC services would be delivered through the pole.

Architects and interior designers often object to power poles on aesthetic grounds. Vertical elements extending above the partitions can be unsightly. To minimize the number of poles, HGA designed one power pole to serve an average of five work stations. PLEC service is distributed from the power pole to the work place with a

technique called furniture wire management. The furniture manufacturer installs a prewired metal raceway as an integral part of the furniture and partitions. The extra cost for furniture wire management has been included.

Modular duct also can be used in combination with floor poke-through outlets to serve work stations on the floor above the ceiling plenum. A separate metal duct distributes electronics and communications service.

Modular duct shines brightest with furniture lighting, because the power poles can take full advantage of wired furniture. Although it leads the pack neither in installation costs nor in relocation costs, it does well enough in both to make its overall costs the lowest. Here's how it compares per square foot:

	Install	Reloc.	Total
Modular duct	\$3.82	\$1.59	\$5.41
Poke-through	3.55	2.39	5.94
Flexible wiring	3.83	2.21	6.04
Flat cable	3.76	2.65	6.41
Access Floor	5.62	1.42	7.04
Cellular floor	4.88	2.17	7.05
Underfloor duct	5.99	2.75	8.74

What this means is that modular plug-in duct deserves more consideration from building designers, especially in situations where all lighting is supplied through the furniture.

FLEXIBLE PLUG-IN WIRING

The fascination of flexible plug-in wiring is that its advantages resemble its disadvantages. It is fast and easy to install—in fact, so fast and easy that it is susceptible to misapplication by unqualified workers. Light fixtures and floor outlets can be unplugged and relocated safely without an electrician.

Flexible plug-in wiring gets its name from the conduit, which is easily bent or twisted. The inexpensive and widely available components include plug-in receptacles for power and lighting circuits, distribution and junction boxes, adapter assemblies, reversing cable assemblies and switching modules. Cable sets should be coordinated with the lighting fixture supplier to provide matching light fixture receptacles.

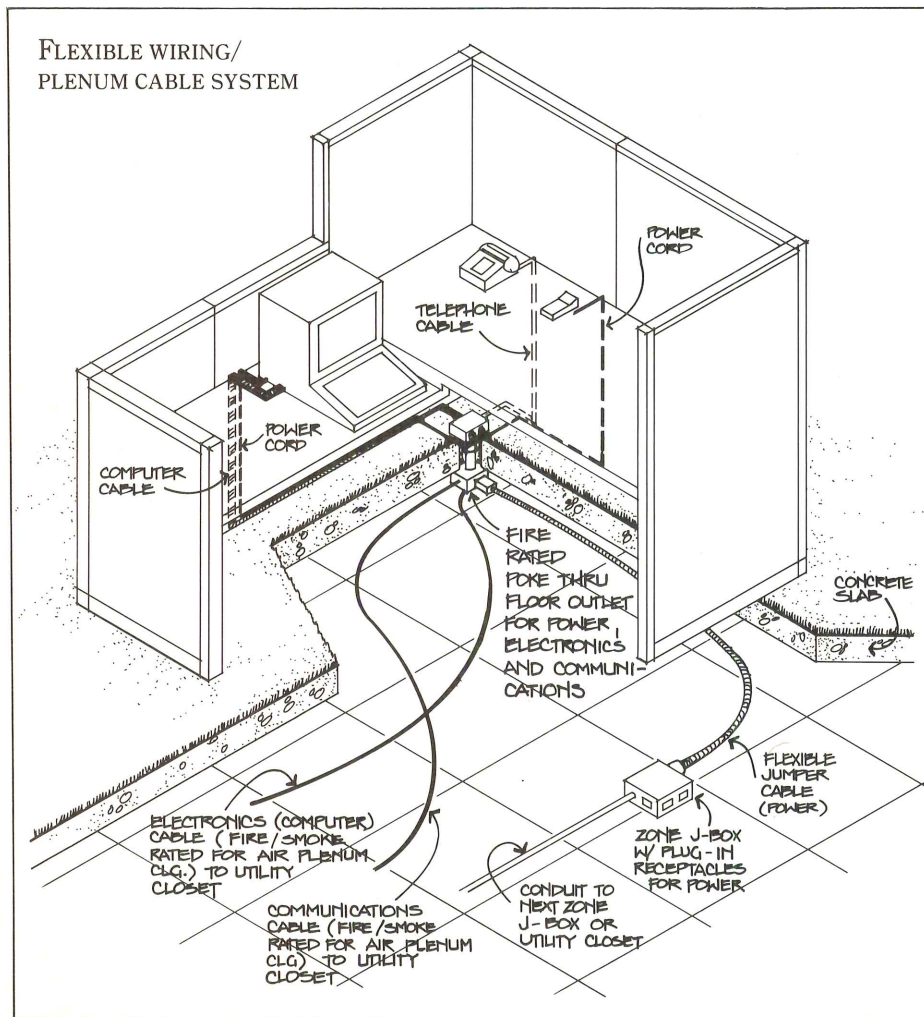

All components are sold as factory-wired assemblies for convenient field installation and connection. Lighting fixtures are pre-wired with appropriate plugs to connect to prewired cable sets. Floor power outlets, wall outlets and power poles can be field-connected with prewired flexible cable sets.

The use of flexible wiring is limited to power and lighting. Electronics and communications must be supplied through an access floor, enclosed raceway system or plenum cable. In this analysis, plenum cable from the ceiling was taken to the floor above and delivered with poke-through pedestals.

The most serious limitation of flexible wiring is the temptation to keep stringing the plug sets together, which is why they are often called jumper cables. A frequent consequence is circuit overloading and excessive voltage drop, or tripping of the circuit breaker. By this time, finding the overloaded circuit and redistributing the plug sets can be a major project.

To avoid problems, owners who select flexible wiring systems should plan to monitor circuit identification, lengths of circuit runs and circuit loads.

Even though electronics and communications must be provided by other means, the cost to install power and lighting with flexible wiring is so low that the total system ranked second least expensive with both ceiling and combined ceiling/furniture lighting.

The Achilles heel of flexible wiring is the cost of relocating power outlets. Modular plug-in duct is the leader because its cost can be divided among the average of five work stations served from each power pole; with no comparable advantage, flexible wiring comes out far behind. Here are the costs, which remain the same regardless of lighting technique:

Cost per power outlet relocation

Modular duct	\$ 21.00
Access floor	31.00
Underfloor duct	81.50
Cellular floor	99.50
Flexible wiring	123.50
Poke-through	136.50
Flat cable	154.50

Despite its limitations, flexible plug-in wiring has impressive advantages. It is a viable alternative for owners who are prepared to monitor its application during reorganizations.

CELLULAR FLOOR

Cellular floor and underfloor duct, as their names imply, are floor systems, but they don't have much else in common.

The two systems were developed for quite different buildings. Cellular floor is

intended for steel frame construction. Underfloor duct may be used in either steel or concrete structures, but the concrete floor slab must be thicker than cellular floor requires.

Cellular floor consists of structural steel decking that is an integral part of the composite floor slab and distributes PLEC services as well. A metal channel, called a trench header, connects the individual cells and is installed flush with the finished floor slab.

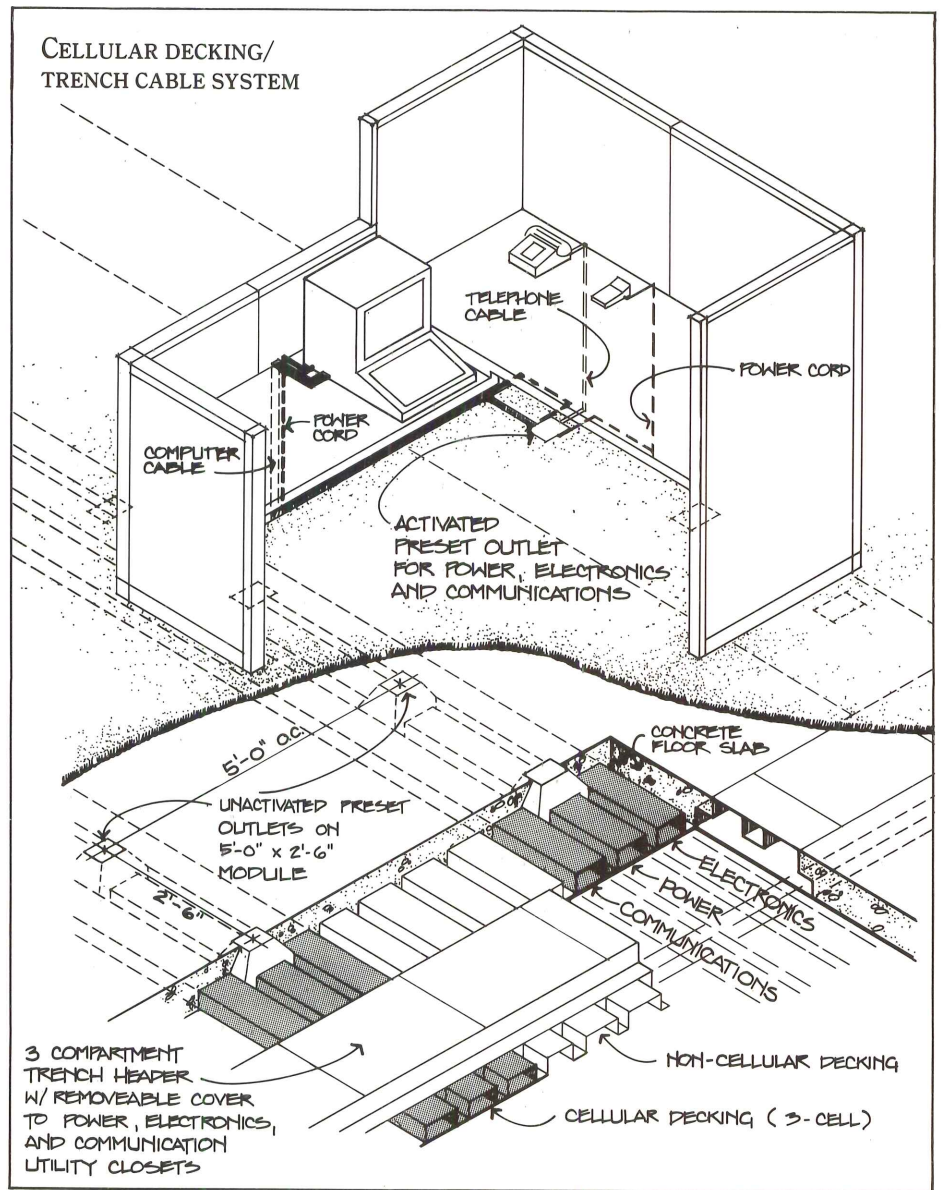

One winner, one loser in PLEC floor systems

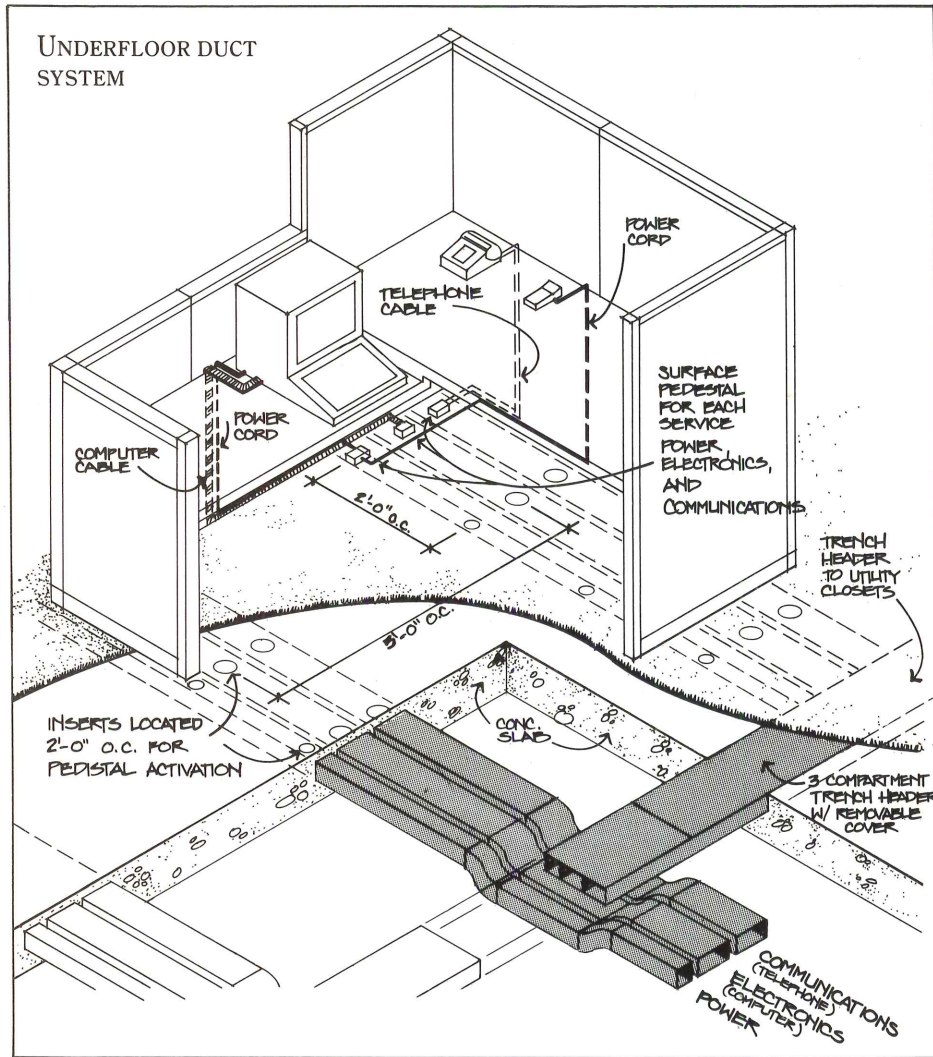

Note on the drawing that the raceways for power (including power for lighting), electronics and communications are fixed at five feet on center. Outlets are preset on a specific module, preferably 2 feet 6 inches by 5 feet. This effectively limits delivery of PLEC service to where the outlets occur on the module. Outlets installed in the preset box may be either recessed or flush with the finished floor. When work stations are moved, the outlets in use are closed, re-covered with carpet or tile, and other preset outlets are activated.

The system provides for complete power, electronics and communication service. It does not accommodate ceiling lighting systems, but it does provide wir-

ing for ambient and task lighting that is integrated with the furniture. Ceiling lighting requires the addition of supplemental hardware or flexible conduit.

Comparing costs of cellular and noncellular decking can be tricky because the difference shows up in the cost of general construction and not in electrical construction. Cellular systems require spraying a fireproofing material on the bottom of the electrified steel deck to enable it to attain a two-hour fire rating. The cost of this fireproofing has been included in the installation cost of cellular floor.

Because outlets from the trench header can be installed either flush with the surface of the floor or recessed, no pedes-

tals stick up above the carpet or tile. Systems that provide capacity for two duplex receptacles per activated outlet, and electronics or communications, are more economical and reduce the number of activated floor outlets.

Preset outlets should be installed as close as possible to increase the probability that the outlet will fall in a convenient location within the work station module. The outlets are quick and inexpensive to activate and unused outlets need not be removed when they are no longer in use. The preset cover merely is left in place and the carpet lies over the cover plate.

Although it is possible to set an outlet wherever it is wanted, the procedure is much less convenient and more expensive than using the presets.

The degree of flexibility with cellular floor depends on the module spacing of the presets and cells. HGA recommends a small module to avoid the consequences of outlets in the foot space of desks or in aisles.

With furniture-source lighting, integral furniture wire management should be specified because more power connections are required than cellular decking, by itself, can support conveniently. Also, it's easier to control the exact location of task (and even ambient) lighting sources through a furniture system. Details of connections between preset outlets and furniture wire management must be controlled between system manufacturers.

Because the preset inserts are so easy to activate and de-activate, cellular decking is among the leaders in relocation cost. It ranks third least expensive with all three lighting techniques. Only access floor and modular plug-in duct do better. Installation costs only 85 cents a square foot more than the least expensive system for ceiling and ceiling/furniture lighting. Under furniture lighting, the need for the more expensive wired furniture pushes the cost up somewhat.

UNDERFLOOR DUCT

The disadvantages of underfloor duct are easier to state than its advantages.

It is among the most expensive PLEC

systems to install and the most expensive to relocate. It comes in last in every cost category, except first cost with ceiling and ceiling/furniture lighting (access floor is the most expensive), and relocation of power outlets, where it falls in the middle.

Further, underfloor duct requires more structural coordination and more awkward pedestals than other systems. And the way outlets are abandoned poses a problem in floor aesthetics. The greatest opportunity offered by underfloor duct is for its own modernization.

Nevertheless, because the system continues to be specified, its characteristics, design application and considerations for use are worth examining.

Underfloor duct consists of enclosed metal raceways in a concrete floor slab.

The drawing on the opposite page shows how the three raceways are used to carry wire and cable. The drawing assumes that the ceiling is the source of lighting.

Note how a three-compartment trench header, with a removable cover, connects the raceways. Outlet inserts on 2 foot centers are installed by the factory on the raceways and set just below the surface of the slab. Raceways are typically five feet on center. The drawing shows a system module 2 by 5 feet, but it can be modified to match that of the work station.

Preset inserts are tapped for installation of pedestal outlets. Each work station requires the activation of three inserts, each with its own pedestal for PLEC service. Underfloor duct does not provide ceiling lighting. It requires the addition of

supplementary hard wire or flexible conduit. The system will adapt to furniture wire management to power ambient and task furniture lighting. The extra costs are included in the study.

Afterset inserts can be installed in the duct where two-foot spacing is not appropriate, but this requires drilling the concrete floor and installation of an insert hub before the pedestal is installed.

Because separate pedestals must be used for power, lighting and communication, it is especially important to provide an ample number of reset outlets to avoid pedestals occurring in inopportune locations.

Floor pedestals must be removed by an electrician when they are abandoned. Metal abandoning plates tend to accumulate over the years and become unsightly.

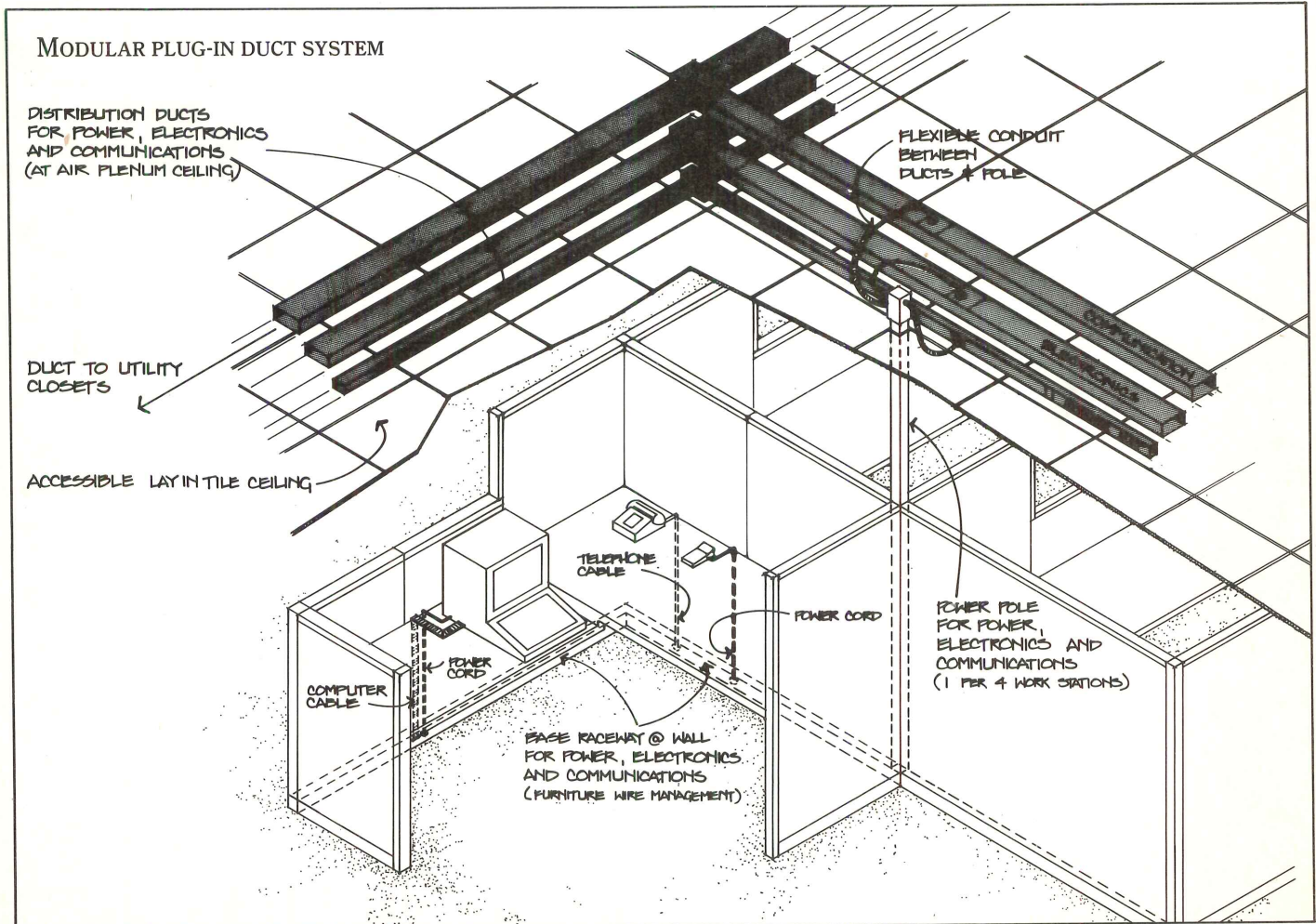

Counting the costs of flat cable

The duct system can be tailored to suit most capacity requirements and floor structures. This analysis was based on a two-level trench header duct installed in a single pour of concrete to minimize cost. All floor duct systems require coordination with the structural design of the building, but the single pour is more difficult to manage than two pours.

FLAT CABLE

Flat cable is the newest PLEC system. For specialized applications such as renovation it offers unique capabilities and low costs compared to the alternatives.

The drawing below shows how flat cable

is installed directly on a smooth structural floor and covered with carpet tile. The chart, right, shows how HGA summarized information from cost estimates prepared by the electrical contractor. Similar charts were prepared for the other six PLEC systems included in the analysis.

The basis of the system is a flat, flexible conductor cable about thirty thousandths of an inch thick. Unlike the traditional round wire, it need not be enclosed in conduit or raceways.

Flat cable consists of one, two or three circuits of 20 and 30 ampere flat copper conductors placed edge-to-edge and enclosed by an insulating material. The cable

is taped to the floor. To protect the cable from damage, a plastic shield is installed on the bottom and a metallic shield on top before covering it with the carpet tiles as required by the National Electrical Code.

The system supplies normal power and communications. Electronics service can also be provided, but it is limited by problems of cable compatibility with some computers. Like cellular decking and underfloor duct, it does not provide ceiling lighting, but it will support wired furniture.

Effective design with flat cable requires that its unique characteristics be taken into account.

Premium-grade carpet tiles must be specified to conceal the cable and to lay flat without gluing. The extra cost, compared to roll goods, amounts to about 40 cents a square foot. The premium was not included in the cost because of the variables involved.

For effective power distribution, cable with three 20-ampere circuits should be selected. Single circuit cable should be used only to deliver power from the distribution cable to the work station outlet.

Flat cable may be installed under moveable partitions but not under fixed walls. The inability to use the system under non-moveable partitions might limit remodeling plans for closed offices.

Because flat cable provides complete flexibility in placement of floor outlets, it eliminates the need for furniture wire management.

Mobility is limited because the cross-over of power, electronics and telephone cables creates complications.

The building code permits cable to be abandoned below the carpet but an accumulation of unused cable could be undesirable.

The permissible lengths of flat cable are limited by phone companies and computer manufacturers. Check with them for the latest information.

Each transition from hardwire to flat cable requires an accessible transition box. Its location presents an aesthetic problem that should be considered early in the design process.

Flat cable requires pedestal outlets at the work station, but they present much less of

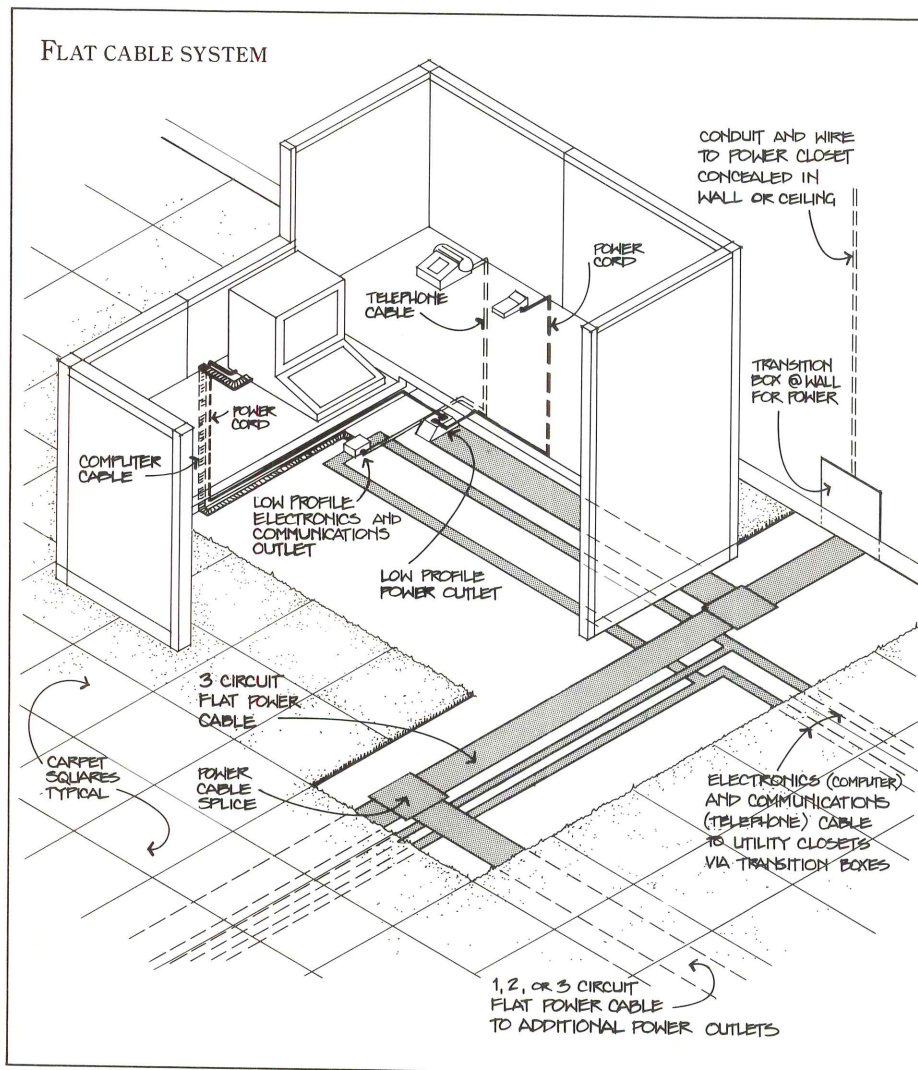

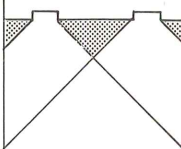
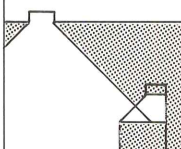
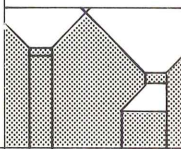
Flat Cable Cost and Equalization Summary											
Lighting Technique		Power		Lighting		Electronics		Communication		Costs	
		Dist.	Deliv.	Dist.	Deliv.	Dist.	Deliv.	Dist.	Deliv.	Total	Sq. Ft.
Ceiling		Flat Cable	Surface Floor Outlet	Conduit & Wire	Conduit & Wire	Flat Cable	Surf. Floor Outlet	Flat Cable	Surface Floor Outlet		
	Material Cost	\$26,009		\$ 983		\$14,048		\$ 9,066		\$50,106	
	Labor Cost	\$ 8,246		\$ 7,982		\$11,329		\$10,211		\$37,768	
	Sq. Ft. Cost	\$ 1.43		\$.37		\$ 1.06		\$.80			\$3.66
Unit Cost	Relocation	\$154.50		Not required		\$ 23.00		\$ 59.00		\$236.50	\$2.15
	Addition	\$159.00		N/A		\$ 63.50		\$ 62.50		\$285.00	
Ceiling and Furniture		Flat Cable	Surface Floor Outlet	Conduit & Wire	Conduit & Wire	Flat Cable	Surf. Floor Outlet	Flat Cable	Surface Floor Outlet		
	Material Cost	\$26,009		\$ 1,762		\$14,048		\$ 9,066		\$50,885	
	Labor Cost	\$ 8,246		\$10,653		\$11,329		\$10,211		\$40,439	
	Sq. Ft. Cost	\$ 1.43		\$.52		\$ 1.06		\$.80			\$3.81
Unit Cost	Relocation	\$154.50		\$ 15.50		\$ 23.00		\$ 59.00		\$252.00	\$2.29
	Addition	\$159.00		\$ 15.50		\$ 63.50		\$ 62.50		\$300.50	
Furniture		Flat Cable	Surface Floor Outlet	Flat Cable	Surface Floor Outlet	Flat Cable	Surf. Floor Outlet	Flat Cable	Surface Floor Outlet		
	Material Cost		\$26,970			\$14,048		\$11,577		\$52,595	
	Labor Cost		\$15,182			\$11,329		\$11,018		\$37,529	
	Sq. Ft. Cost		\$ 1.76			\$ 1.06		\$.94			\$3.76
Unit Cost	Relocation	\$154.00		\$ 54.00		\$ 23.00		\$ 59.00		\$290.50	\$2.65
	Addition	\$159.00		\$ 54.00		\$ 63.50		\$ 62.50		\$339.00	

an intrusion than the monuments used with poke-through or underfloor duct. Instead of sticking up four inches or more, the low profile outlets for flat cable protrude only 1 1/8 inch above the carpet. The drawing shows how transitions are made from wall power to flat cable and from flat cable to outlets.

On the chart, note the extremes in labor and material costs for power and lighting. The cost for power outlet relocation is the

highest of any PLEC system. Here's how they compare:

	Power Outlets Costs
Modular duct	\$ 21.00
Access floor	31.00
Underfloor duct	81.50
Cellular deck	99.50
Flexible wiring	123.50
Poke-through	136.50
Flat cable	154.50

The reason reflects the cost of the cable itself. When an outlet is relocated, the owner must buy an additional length of cable and tap off an existing section. A typical splice is shown at the bottom of the drawing.

HGA's analysis shows that the cost of relocating power outlets is the most variable of any of the PLEC services and the most expensive.

Manufacturers rebut PLEC study

Editor's note: The HGA study was shown to manufacturers of PLEC products. Written responses were received from H.H. Robertson Co. (Pittsburgh), which makes cellular decking, underfloor duct and access floor; Donn Corp. (Westlake, Ohio), best known for access floor; and Walker (Parkersburg, W. Va.), manufacturer of products in virtually every PLEC category.

H.H. Robertson Co.:

C.H. NORRIS, JR., P.E.
Product Manager, Structural/Electrical Systems

The study is very thorough from a descriptive standpoint. However, the costs are somewhat out of perspective.

1. In most cases, lighting systems do not play a major role in determining which PLEC system is utilized.
2. All buildings require fire ratings. This can be achieved with or without fireproofing; the costs involved would be similar for any PLEC system and are part of the structural considerations.
3. Preliminary planning for PLEC in the "design stages" will become increasingly more important due to the electronics and communications explosion. Letting the tenants of buildings fend for themselves will no longer be tolerated.
4. I would recommend that poke-through and flexible plug-in duct be combined. Whether poke-through uses jumper cables or standard hardwire, it is still poke-through.
5. All systems except flat cable describe both distribution and delivery of PLEC. Flat cable is just the delivery system and must be fed through a distribution system of hardwire conduit or other method. Both costs must be included in the study.

The chart on the opposite page ranks each system in three areas. The numbers represent rough cost per square foot, not including wire. There is very little total first cost difference between the lowest three systems, and little between the next two, with access floor being much higher. Access floor (first cost of move in) includes junction box system within floor plenum.

Relocation costs represent the rough cost per change, not including wire.

HALL REPLIES:

1. Lighting was included in the study because it is an integral part of the PLEC concept. To exclude it would invalidate the study for users who ask: "If we use task/ambient lighting, won't the cost be increased for floor distribution system wiring?" or "Flexible plug-in wiring is designed to reduce labor cost for installation of lighting; why aren't those costs reflected in the study?" I find that PLEC floor system suppliers tend to have little interest in the lighting portion of PLEC. However, to compare ceiling and floor systems properly, the effect of lighting on PLEC needs to be included.
2. Costs for fireproofing unique to a PLEC system should be included.
3. I could not agree more.
4. The poke-through method was evaluated using both hardwire and flexible plug-in cables to analyze the differences between the two.
5. Flat cable was evaluated like all other systems. Power was designed using multiple three-circuit flat cable from electrical closets with branch circuit panels. Thus flat cable provides the method of distribution for each branch circuit.
6. The intent of the study was not to settle "once and for all" the cost battle waged by competing manufacturers. Rather, the intent was to establish an analysis method as a framework for PLEC system selection. Many of the cost figures presented by the manufacturer did not consider an integrated PLEC system. The costs therefore were incomplete. Some only represented the unwired components. A/Es who want specific analysis must *not* rely only on data produced by manufacturers or generalized studies.

Donn Corp.

JOHN S. GABRIEL, AIA
Manager, Value Engineering Floor Division

Donn submitted only the cost chart that appears on the opposite page. Hall did not reply.

Walker:

WILLIAM L. JOHNSMEYER
Vice President, Marketing and Sales

The data presented do not accurately reflect the true costs of underfloor duct or the relative costs compared to other systems.

1. The material costs are the result of rough budget figures. After talking with our agent who supplied these figures, we found that his costs were 27 percent high.
2. The system presented in the article is our most expensive. A single level system with header duct and junction box feed results in 21 percent material savings. Our material costs are further reduced for activations, relocations and additions by the use of our Source II flush service fitting. This eliminates the requirement for three surface-mounted pedestals at one work station.
3. Next, the installation labor costs are grossly overstated. Through an extensive survey of electrical contractors, we have determined that the installed costs for a three-duct system on five-foot centers would average about \$1.23 a square foot, compared to the reported \$2.35, assuming a \$28 per hour labor rate.
4. The relocation and activation costs are also unrealistically high. Our surveys show that a service fitting can be deactivated and a new service added for \$40. For three services, this would total \$120, a far cry from the reported figures of \$248 and \$260.
5. A poke-through requires core drilling at night, due to noise and inconvenience, so we're talking about overtime rates. You might have to add a run of conduit; not so with duct. You have a more difficult work area with poke-throughs because you have to work two floors (feed and pull) and the floor-below work is on a ladder.
6. Underfloor duct costs are overstated by at least \$2.10 a square foot. Relocation and activation costs are overstated by at least \$120.

**ANALYSIS OF PLEC SQUARE FOOT COSTS
BY H.H. ROBERTSON**

<i>First Cost-Bldg. Shell</i>		<i>First Cost-Move In</i>		<i>Total First Cost</i>	
Access floor	\$5.00	Poke-through	\$1.60	Access floor	\$6.25
Underfloor duct	3.00	Flat cable	1.35	Power poles	3.20
Cellular floor	2.10	Power poles	1.20	Underfloor duct	3.15
Power poles	2.00	Underfloor duct	1.10	Flat cable	2.60
Flat cable	1.25	Access floor	1.25	Cellular floor	2.50
Poke-through	.80	Cellular floor	.40	Poke-through	2.40

**ANALYSIS OF PLEC SQUARE FOOT COSTS
BY DONN CORP.**

Access floor	\$4.50	Poke-through	\$2.00	Access floor	\$5.00
Poles	2.50	Flat cable	1.75	Underfloor duct	2.90
Underfloor duct	2.50	Poles	1.25	Poles	3.75
Cellular floor	1.90	Access floor	.50	Flat cable	2.35
Flat cable	.60	Underfloor duct	.40	Poke-through	2.50
Poke-through	.50	Cellular	.30	Cellular	2.20

RELOCATION COSTS

Donn Est.

	<i>Pwr.</i>	<i>Tel.</i>	<i>Elec.</i>	<i>Total</i>	<i>Robertson Est.</i>
Poke-through	\$250	Inc.	\$100	\$350	\$250
Poles	100	Inc.	Inc.	100	150
Underfloor duct	50	Inc.	20	70	80
Flat cable	60	30	30	120	100
Cellular deck	50	Inc.	Inc.	50	50
Access floor	25	10	10	45	40

7. Attached is literature from the Portland Cement Association. It indicates a tremendous life cycle cost advantage for underfloor duct.

8. Attached is a second brochure from the Building Industry Consulting Service. It indicates that underfloor duct offers lowest life-cycle costs. One reason for the different conclusion is the rate at which work stations are relocated. Gary Hall said once every five years. The Bell System has records that say the average office telephone is relocated every two years.

9. [Walker also offered the following comments regarding its new Walkercell, to be introduced this spring.]

The cellular raceway portion of steel cellular floors has been gaining acceptance in reinforced concrete construction. It has increasingly been substituted for underfloor duct systems. Primary reasons included an aesthetically preferred recessed fitting,

greater perceived capacity in the raceways and sometimes lower up-front material costs.

Although these systems have had success, acceptance has not been overwhelming. Limiting factors include the susceptibility to damage, additional concrete needed and high installation costs. Because most cellular raceway systems first served as structural floor deck and were only later adapted to raceway systems, further refinements are needed.

To overcome these disadvantages, Walkercell provides up to three times the capacity in single level header systems. It can feed the distribution cells to capacity, while the distribution cells offer 20 percent to 33 percent more distribution capacity for telephone and data. The recessed service fittings have 50 percent more capacity for plugging in receptacles and electronics devices and provide adequate recessed housing for transition for flat cable. "After-the-pour" adjustment features ensure a flat

floor, minimizing carpet wear.

Following Gary Hall's logic, the system allows for a 30 percent to 35 percent decrease in life-cycle costs by reducing material costs, installation labor and activation and relocation expense. Also, three pedestal service fittings have been replaced by one recessed fitting and the need to deactivate abandoned fittings has been eliminated. Thus activation and relocation costs are lower.

The costs (below) follow the Hall format limited to the ceiling lighting scenario:

Cellular raceway cost summary

Cost per square foot	\$ 3.57
Activate power outlet	99.50
Relocate lighting fixture	Not req.
Relocate electronics outlet	46.40
Relocate communications outlet	38.00
5 year reloc. cost/sq. ft.	1.68
Life cycle cost/sq. ft.	5.25

A preview of new cellular systems

HALL REPLIES:

1. Repricing brings these material costs in line with bid costs and now reflect costs obtained from other sources. These costs are about 19 percent less than previously indicated. Prices in the study have been adjusted.
2. The system is compared on an equal basis with other systems. Although floor duct systems of lesser capacity are available, the trench header three-duct system was selected because it met the design criteria. While the Source II flush service fitting is excellent for a two-duct system, it cannot provide the three-duct activation at a single location to serve the work station. Parameters set for this analysis required power, communications and electronics to be activated at each location. In addition, Source II presets would have added to the initial cost because they need to be installed on the selected module prior to pouring concrete.
3. Repricing of labor for floor duct is \$44,128 or \$1.84 a square foot. Figures

quoted by Walker may be correct for an empty system, but our analysis is based on a fully wired system.

4. Costs provided in this study reflect the contractor's real experience on several projects.
5. Poke-through costs reflect actual costs based on experience. These installations occur without premium rates. The core drilling occurs before business hours in the early morning.
6. As floor duct manufacturers move to underfloor cell systems and compete with cellular decking, they are in fact recognizing the shortcomings of the labor intensive floor duct.
7. Our PLEC analysis for our building and design would not agree with those findings.
8. The study represents only the telecommunication portion of PLEC. The issue here is the experience of the building owner. That relocation frequency should be used by the A/E.

9. Robertson's system is essentially similar in that both adapt cellular decking for concrete buildings and slab floors that don't have another floor below. It's a definite improvement over underfloor duct, but not over traditional cellular decking, except that it's more adaptable to a concrete structure. I don't like the junction box header concept. It doesn't permit full access along the header, as with the trench duct. This means more labor to activate PLEC services during relocations.

The drawing shows the new Walker cellular raceway system to be introduced this spring. It consists of a steel duct partitioned into three cells and connected by a header duct, itself divided into three compartments. Transitions from header to distribution cells are made through a junction box that maintains isolation of power service. Wires are pulled through the raceways at junction box access hatches and at recessed service fitting boxes.

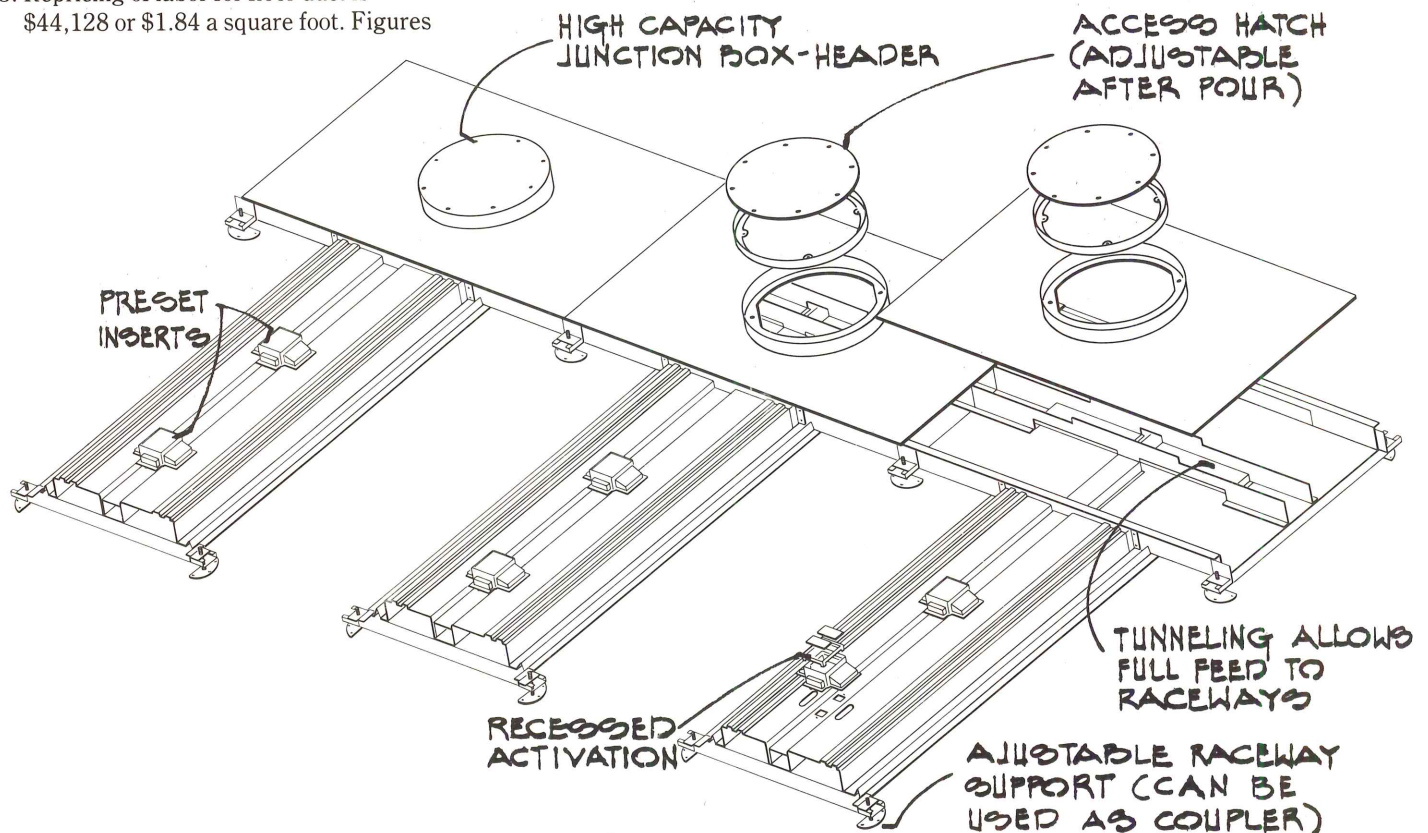

QUAKE CODES

BY CHRISTOPHER ARNOLD, AIA

Building codes must surely be among the least readable literature in the world. The structure and content of a building code is similar to that of a book on childbirth that consists of a listing of all the things in recorded history that have gone wrong, together with an ad hoc method for their solution. To this could be added a random and obscure categorization of types of women by height, occupation, weight and chemical composition, but nothing about the reproductive process, the stages of the embryo, and the miracle of birth.

This is a fair analogy because in origin and development, building codes consist of accretions of isolated problems together with their solutions—and by now, many of the problems and solutions are hopelessly outdated. There is nothing about the building as an entity, and how it is designed and built. There is no philosophical basis for the code, only a set of unrelated commands. This is one reason codes rarely deal with innovation, whether of material or design.

The code, of course, is not intended to be read as a novel, or even as a textbook, but to be referred to. Even so, building codes are boring, and architects read them only under duress and for a short time. I feel this way about building codes, and know as little about them as possible. (One keeps handy the phone numbers of those who are knowledgeable.)

On the other hand, I think the philosophy of building codes is very interesting because it tells us much about the way the building community goes about its business, with all its uncertainties and irrationalities.

Earthquake codes are particularly interesting, and their shortcomings are particularly ominous.

—C.A.

THE DEVELOPMENT OF A BUILDING CODE TO RESPOND TO earthquake problems is comparatively recent. Although San Francisco was rebuilt after the 1906 earthquake under a city code intended to deal both with wind and earthquake forces, the Uniform Building Code did not contain a section applicable to seismic design until 1927. This followed the damaging earthquake of 1925 in Santa Barbara.

QUAKE CODES ASSUME RISK

There is a fundamental difference between earthquake codes and those related to vertical loads. We can be quite precise as to the magnitude of vertical loads. We then apply rather substantial safety factors to them, so that in vertical load design it is necessary to make a very serious mistake in the building design in order to get into a dangerous situation, because the loads the

building can withstand are much greater than those that will occur. The risk is very small of something going wrong.

The earthquake code is quite different, because the basis of the seismic load is that during a severe earthquake, a building encounters forces many times greater than those for which it has been designed.

This is shown in Figure 1, in which the response to ground motion of a structure is plotted for different periods related to increasing accelerations. Seismic forces are inertial—they are the product of mass times acceleration—and this figure shows that the capacity established by the code is several times below the possible response of the building at high accelerations.

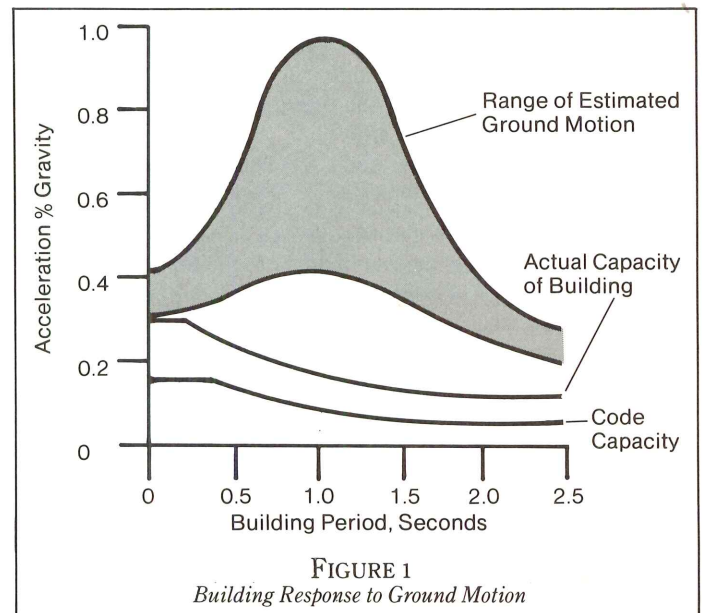

FIGURE 1
Building Response to Ground Motion

The reason the code is set up this way is primarily economic: if you were to design a building to withstand, without distortion, the maximum forces that it might encounter under a severe earthquake, plus the kind of safety factors that we normally use in vertical loads, the building would be extraordinarily expensive and one could hardly walk through it for the amount of structure that would be in it.

So we back off. Instead, we rely on the strength of non-calculated components, like partitions, which will tend to support the building and reduce its motion even though the structure may be loaded beyond its theoretical capacity. We also rely on the property of ductility—the ability of materials like steel to distort

Christopher Arnold, AIA, is the president of Building Systems Development Inc., a San Mateo, Calif., firm specializing in architectural planning research and analysis.

QUAKE CODES

considerably without breaking, and in so doing dissipate the energy of the earthquake. The building may be damaged—perhaps severely—but remains safe.

This feature of the seismic code—that it explicitly permits considerable damage, particularly in architectural components such as lighting fixtures, ceilings and partitions—is little known. Again, this is a quite different characteristic compared to vertical load provisions: when you move a grand piano into your living room, you do not expect the floor to bend, the ceiling below to fracture, and partitions to be crushed.

ARCHITECTS AND SEISMIC SAFETY

As prime controllers of configuration, architects are playing a major role in seismic design. Our first ideas on configuration—our first schematic conceptions, perhaps even before there is any engineering discussion—are of great significance.

Despite its fundamental impact on seismic activity, the configuration issue was not mentioned in the codes until the 1973 edition of the Uniform Building Code.

The code design forces are derived from “uniform buildings and conditions.” In fact the code forces are derived from a simple rectangular building, in which each floor is assumed to be the same size, the column or wall spacing the same on each floor, and the floor-to-floor heights all the same.

The code now presents the issue with only a very general comment. It says that in structures...

“... which have highly irregular shapes, large differences in lateral resistances or stiffness between adjacent stories, or other unusual structural features, the distribution of the lateral forces shall be determined considering the dynamic character of the structure.”

There is a statement in the commentary to the Structural Engineers Association of California “Blue Book,” upon which the Uniform Building Code is based, explaining certain aspects of the seismic code. Since 1973, the Blue Book commentary has stated:

“Due to the infinite variations of irregularities in configuration that can exist the impracticality of establishing definite parameters and rational rules for the application of this Section are readily apparent. These minimum standards “the code” have, in general, been written for uniform buildings and conditions. The subsequent applications of these minimum standards to unusual buildings or conditions has, in many instances, led to an unrealistic evaluation.”

So this is saying that if you design an irregular building, the chances are that the code forces that you establish are “unrealistic.”

That is a strong and ominous statement.

It throws the problem right back to the judgment of the architect or engineer. At the same time, it gives no help or guidance as to how to make those judgments. Perhaps more guidance will be provided in future codes, but it is clear that architects will continue to need at least basic knowledge of the effects of building configuration on seismic safety, because structural engineers cannot possibly make an unsafe configuration safe.

Some basic guidelines for solving configuration issues are presented in this article.

ATC-3: A CONTROVERSIAL ATTEMPT TO STANDARDIZE AND UPDATE CODES

There are a number of seismic codes extant today, and the Uniform Building Code tends to be the basis for most of them. Some years ago, a group consisting primarily of structural engineers and researchers decided that it would be a good idea to develop an up-to-date basis for a national code which, upon adoption, could be applied anywhere in the country, to any type of building, by any private or public agency.

Funded by the National Science Foundation, a non-profit California group called the Applied Technology Council (ATC) began, with the National Bureau of Standards, to develop this basis for a national code.

In 1978, ATC produced a document called Tentative Provisions for the Development of Seismic Regulations for Building, generally known as ATC-3, which tries not only to standardize the code situation for seismic design, but also to improve the basis upon which current codes are written. Though not a seismic code, its whole format is that of a code, and it could in fact be adopted and used as a code.

“... if you design an irregular building, the chances are that the code forces that you establish are ‘unrealistic’...” That is a strong and ominous statement.

ATC-3 has been revised several times and is currently being used as the basis for a number of “trial designs”—hypothetical buildings designed according to both ATC-3 and to prevailing codes—in a number of U.S. cities to assess economic impact.

The Building Seismic Safety Council (BSSC), comprising a number of building community organizations, including the AIA, is acting as overall manager of this enterprise. It will be about a year before the trial design phase is complete.

Then, after review and revision, the document will become available for adoption by federal agencies or by any private community or agency. In fact, though, ATC-3 is already becoming quite influential, and bits and pieces of it are now being adopted. Some of the new elements in ATC-3 include:

- Incorporation of more realistic ground motion intensities for many more parts of the country than have previously been considered.
- Consideration of the effects of distant earthquakes on long period buildings (very tall buildings which may suffer a great deal of motion from an earthquake that may occur some distance away).

- Development of revised coefficients relating to different kinds of structures and different kinds of framing systems.
- Classification of building-use groups into hazard exposure groups, ranging from such emergency-related buildings as hospitals and police stations to buildings of lesser importance.

ATC-3 has its critics, of course. The fact that it applies seismic design principles to the entire United States is quite controversial. Initially, many Eastern and Midwestern engineers and building officials considered ATC-3 an attempt to spread California practices to the rest of the country.

Another more subtle argument sees ATC-3 as part of an effort to emphasize that earthquakes are not only a California problem but a national threat. The origin of this hypothesis apparently lies in the fact that much earthquake research—conducted predominantly in university engineering departments—is funded by the National Science Foundation, which is subject to Congressional review; hence, to ensure funding, it is necessary to stress the threat of earthquakes in such states as South Carolina, Massachusetts, Utah, Missouri and New York.

While there may be an element of truth in this political argument, the fact remains that buildings now constructed in the above states do stand a substantial chance of suffering a damaging earthquake. Professor Otto Nuttli of St. Louis University says that there is a 50 percent chance that an earthquake of Richter Magnitude 7.5—large enough to cause serious damage—will occur in the central United States within the next 20 years. These are unfavorable odds, indicating that designing against earthquake forces is a reasonable professional precaution.

Another argument for rational design against lateral forces is simply that it results in a better quality building that will deteriorate less in its lifetime from such familiar problems as differential settlement and thermal stress.

ATC-3 has also met with criticism from some of the building materials interests. The masonry industry is concerned that new requirements for reinforcing may make its material less competitive. Other industries, including the concrete industry, are concerned primarily with the complications caused by changes in design and construction practice.

Use of an ATC-3 based code will require many design practice changes. The document outlines a 13-step process for use in the design and detailing of buildings. All these procedures would be new to engineers and architects. Preliminary reports of the trial design exercise administered by BSSC have indicated concern about the level of seismic design knowledge displayed by some of the engineers contracted to perform on the hypothetical buildings, and about the increase in time and cost of the design work.

To the extent that ATC-3 encourages improved design standards, however, it can only be to the ultimate benefit of the building community. It is, in fact, a commentary on the parochial nature of our design education and professions that such a pervasive influence as lateral force design should be seen as something only of local concern, not as part of the common knowledge of every competent professional.

A list of recent books on seismic design appears in the References on page 75.

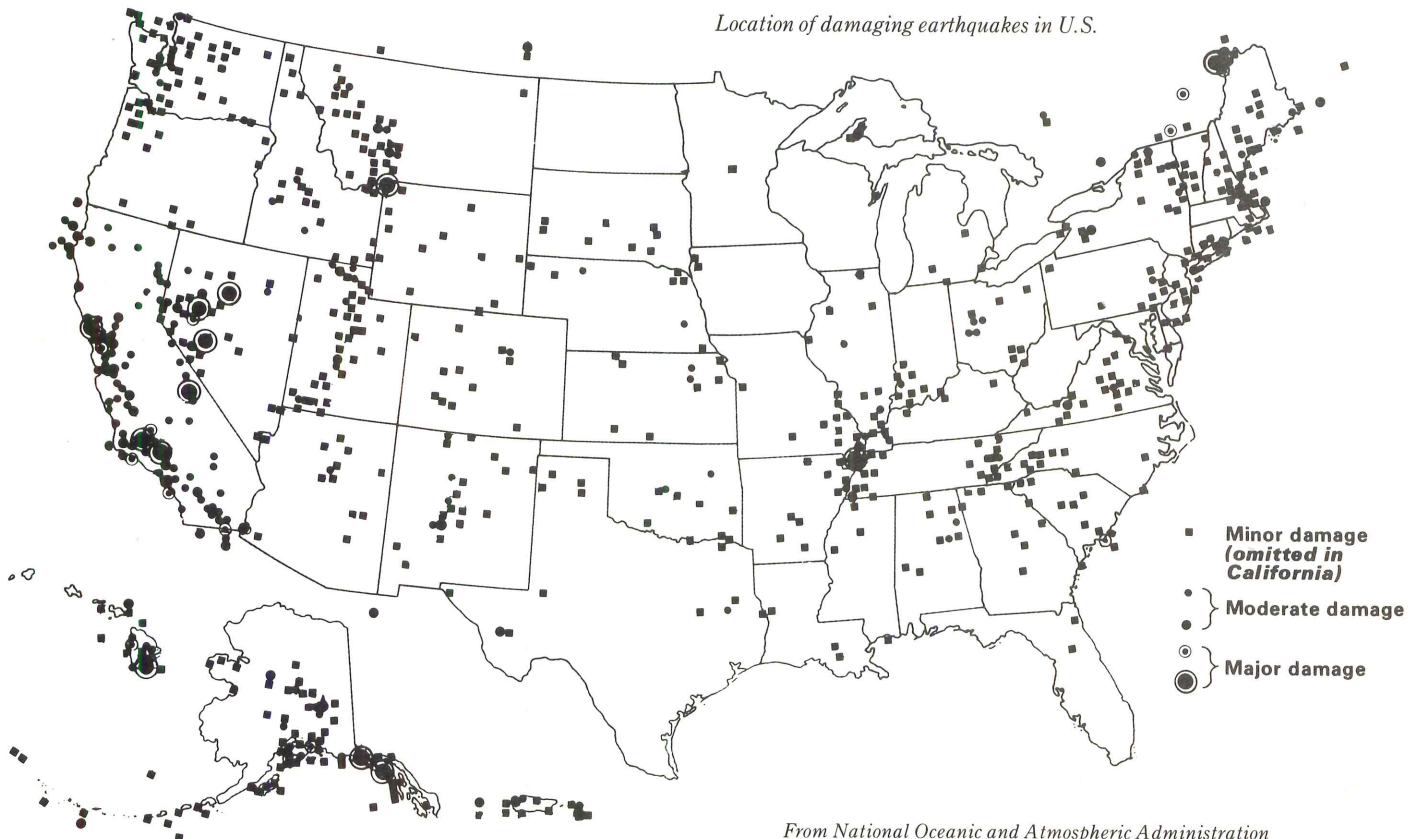

QUAKE CODES

Christopher Arnold has identified the irregularities in building configuration that may significantly affect seismic performance. Some problem configurations are depicted here, with their solutions.

Variations in simple configurations such as those shown in Figures 2, 3, and 4 can be serious enough to cause collapse. In these cases, the plan of the building appears simple and symmetrical, but variations in perimeter strength and stiffness, or of internal layout, may create major torsional problems.

The re-entrant corner group, shown in Figure 5, may suffer serious damage in extreme cases—i.e. in a high building, with long and narrow wings—such as a hospital or residential complex on a tight urban site. The decision as to which solution to use depends on the size, mass,

and proportions of the building. Separation is always a good seismic solution, but presents difficult and expensive problems of architectural detailing.

The configurations shown in Figures 6 and 7 affect the vertical load-carrying members. These designs are particularly hazardous when they occur in older buildings—for example reinforced concrete buildings constructed prior to the revision of building codes after the San Fernando earthquake of 1971. Such buildings may not have enough ductility to prevent serious damage or collapse.

The Imperial County Administration Building shown on page 32 is an example of a building that conformed to the 1967 code yet suffered irreparable damage due to a soft first story and discontinuous shear walls. The building constructed to replace

it (page 33) illustrates sound seismic design.

The “weak-column-strong-beam” layout shown in Figure 8 has also often resulted in serious damage or collapse.

Figures 9, 10, and 11 illustrate the seismic problems that can be presented by extreme building dimensions. Figure 9 depicts an extreme height-depth ratio, which is common in restricted sites. Figure 10 shows an extreme plan area, which is common in warehouses, industrial buildings, and shopping centers. Figure 11 shows an extreme elevation length-depth ratio (aspect ratio), common in older schools and multi-story residential buildings.

If buildings are constructed too close together (not shown), pounding from ground motion may create extensive damage, although collapse is unlikely.

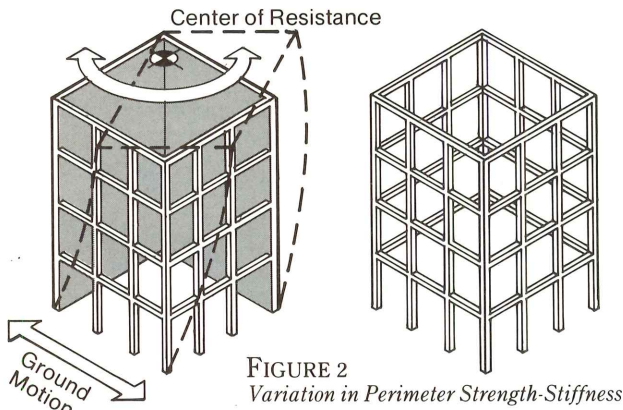

FIGURE 2
Variation in Perimeter Strength-Stiffness

Problem: Torsion caused by extreme variation in strength and stiffness

Solution: use frames and light-weight walls

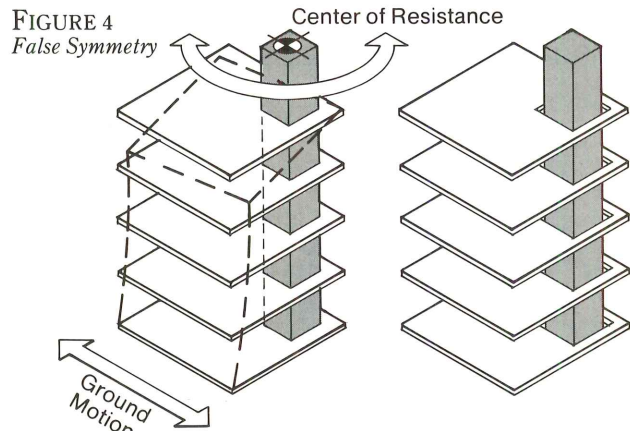

FIGURE 4
False Symmetry

Problem: Torsion caused by stiff asymmetric core

Solution: Disconnect core (as shown) or use frame with non-structural core walls

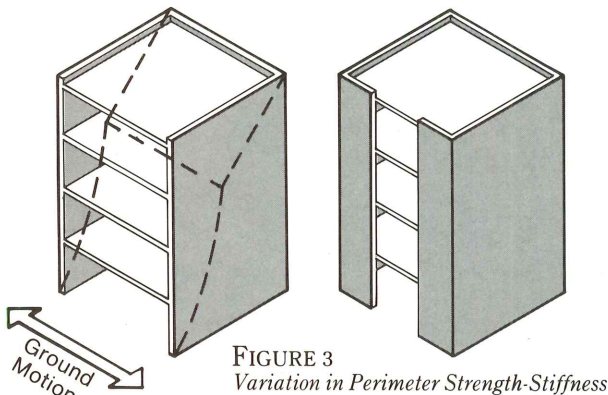

FIGURE 3
Variation in Perimeter Strength-Stiffness

Problem: Torsion caused by extreme variation in strength and stiffness

Solution: Add shear wall at or near open front

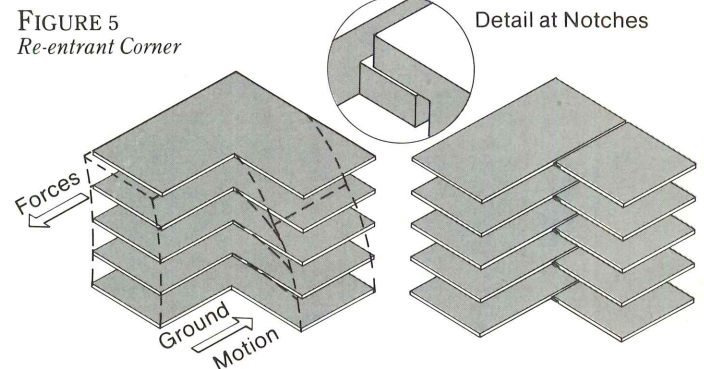

FIGURE 5
Re-entrant Corner

Problem: Torsion, and stress concentration at notches

Solution: Seismic joint (as shown) or uniform box

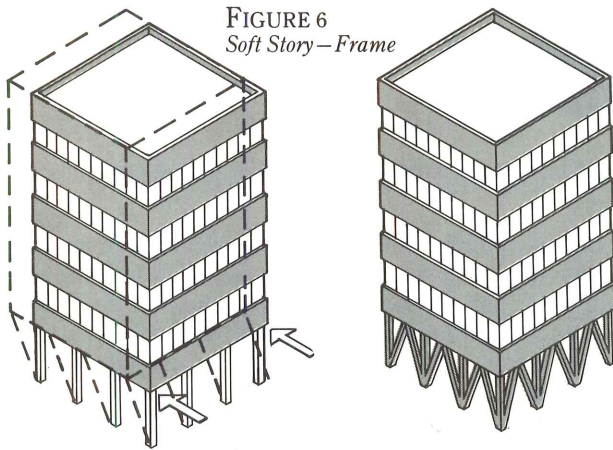

FIGURE 6
Soft Story-Frame

Problem: Abrupt change of stiffness at point of discontinuity

Solution: Add bracing (as shown) or add columns

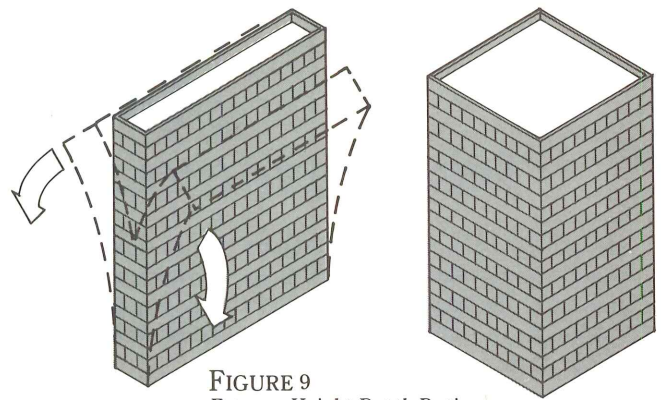

FIGURE 9
Extreme Height-Depth Ratio

Problem: High overturning forces, large drift causing non-structural damage

Solution: Revise proportion (as shown) or special structural system.

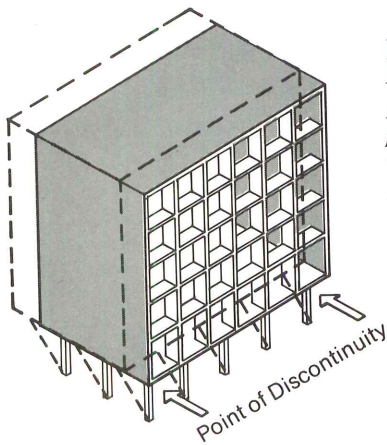

FIGURE 7
Discontinuous Shear Wall
Problem: Discontinuities in load path and stress concentration for most heavily loaded elements
Solution: None

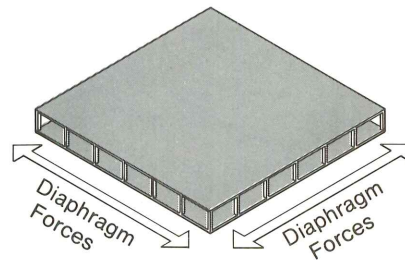
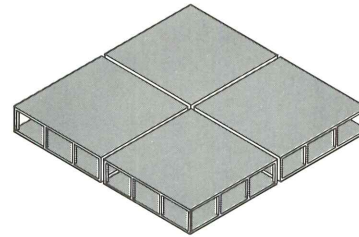

FIGURE 10
Extreme Plan Area
Problem: Build-up of large diaphragm forces



Solution: Subdivide building by seismic joints

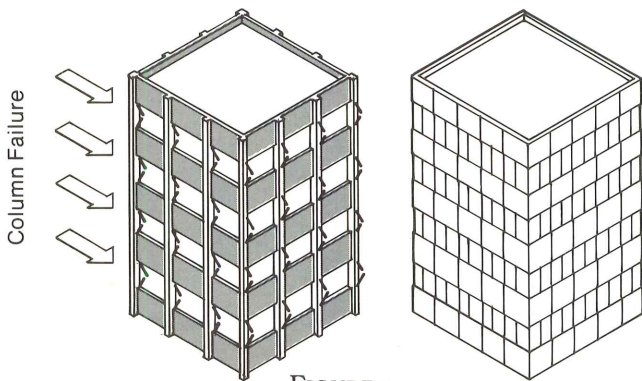

FIGURE 8
Weak Column-Strong Beam

Problem: Column Failure occurs before beam. Short column must try to accommodate story height displacement

Solution: Use light weight curtain wall with frame (as shown). Disconnect spandrel from column.

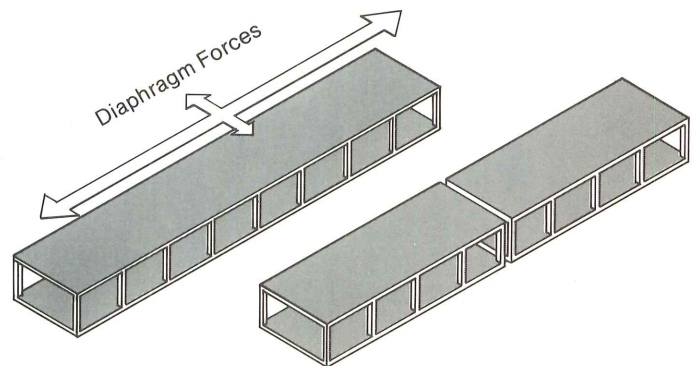

FIGURE 11
Extreme Elevation Length-Depth Ratio

Problem: Build-up of large lateral forces in perimeter; big difference in resistance of two axes

Solution: Subdivide building by seismic joints.

QUAKE CODES

DESIGNED TO CODE, BUILDING DEMOLISHED BY QUAKE

In October 1979, a small earthquake (registering 6.4 on the Richter scale), rolled through the Imperial Valley of Southern California. The largest building in the valley, a six-story concrete-frame county administration building, was damaged sufficiently to require complete demolition.

Following investigation by the Office of the State Architect, the Seismic Safety Commission, the California Board of Architectural Examiners, and Blaylock & Willis structural engineers (San Diego), it was determined that the building met the 1967 Uniform Building Code when it was completed in 1972. The building configuration was a major factor contributing to the structural failure.

The major problem with the configuration was the open first floor, which permitted occupants to come and go freely from a nearby park. Since the shear wall on *column line e* (see illustration) was 31 feet from the east facade of the building, it prevented transfer of the diaphragm loads from the upper floors to the foundation.

The apparently small design variation between the two ends of the building resulted in a dramatic difference in performance. The west shear wall was located on *column line a*, six feet from the facade, which enabled it to transfer the upper loads to the foundation.

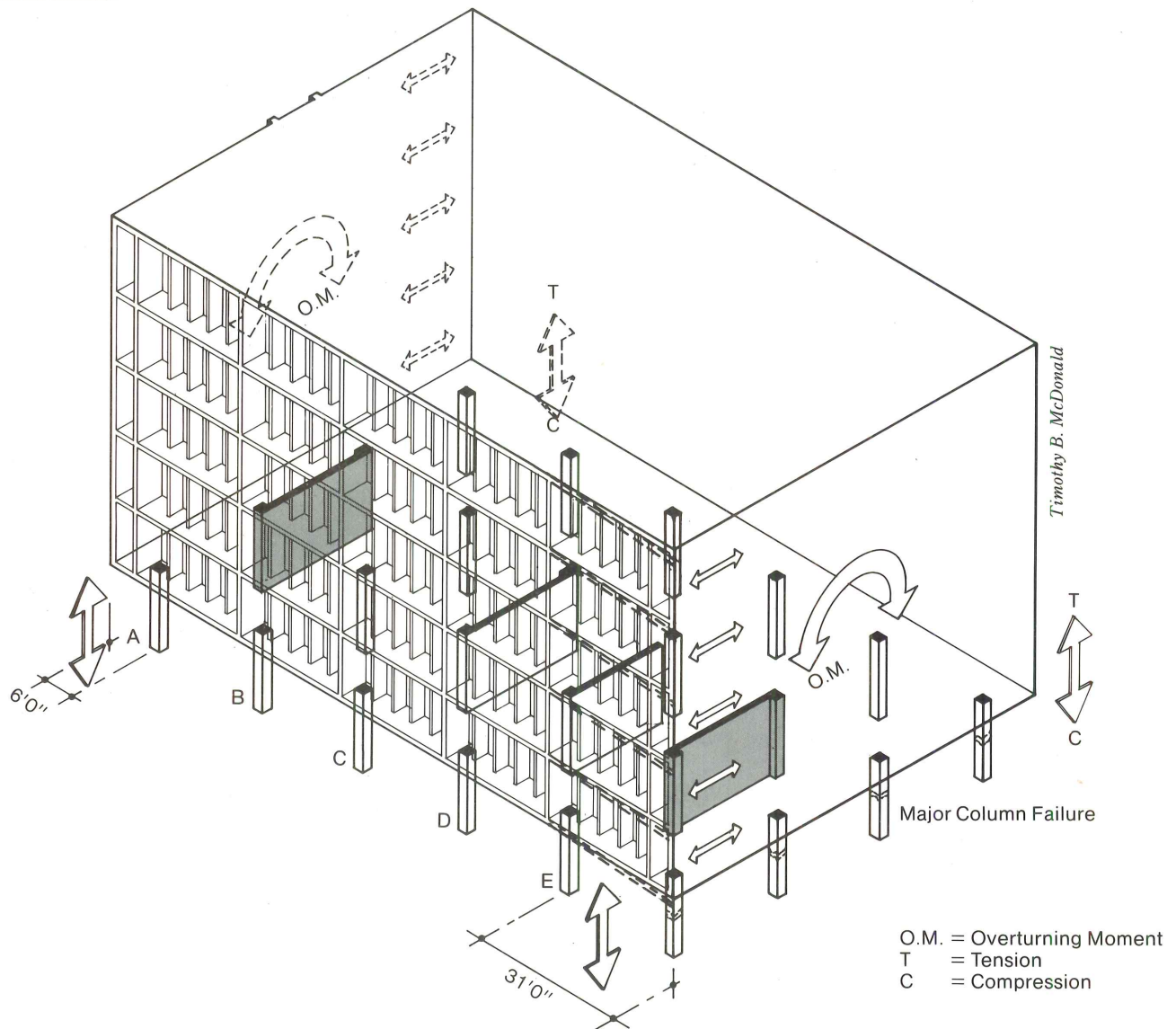

NEW IMPERIAL COUNTY ADMINISTRATION BUILDING AVOIDS MISTAKES OF PREDECESSOR

The new Imperial County Administration Building, designed by The Blurock Partnership (Newport Beach) with associate architect Terence Whittington (El Centro), avoids the configuration mistakes of its predecessor.

Completed in late 1982, the two-story building is spread out over a larger ground area to create the same amount of interior space as contained in the original building.

As if to provide reassurance, the earthquake bracing on the simple rectangular lightweight steel-frame structure forms a visible feature of the facade. Eight braced frames carry lateral forces from the metal deck diaphragms. The braced frames are almost uniformly distributed throughout the building, reducing possible torsion caused by earthquake forces.

A secondary moment-resisting frame was incorporated on the interior column lines. End plates connect the end of the beams to the strong axis of the columns. The other end of the beam was pinned, which simplified erection because the moment frames were prefabricated in the shop and bolted

together in the field, cutting the high cost of on-site welding.

Exterior walls are made of lightweight insulated composite building panels with numerous engineered joints that can absorb ground movement stresses. The frame and wall system avoids the use of unnecessarily heavy materials that would increase stresses. Mechanical equipment is located in an enclosure on the ground rather than on the roof.

Structural engineers Blaylock-Willis (San Diego) designed the building to withstand high lateral forces of .72 g, somewhat in excess of the .21 g required under the Uniform Building Code. This was accomplished at a moderate cost, with the cost of the structural system estimated at 20 percent of the total cost of the building.

Project Manager Robert I. Hench, AIA, not only provided a safe building for an area where earthquakes occur several times a year, but incorporated daylighting, shading, and energy-conserving mechanical systems to keep energy costs down in the desert climate. □

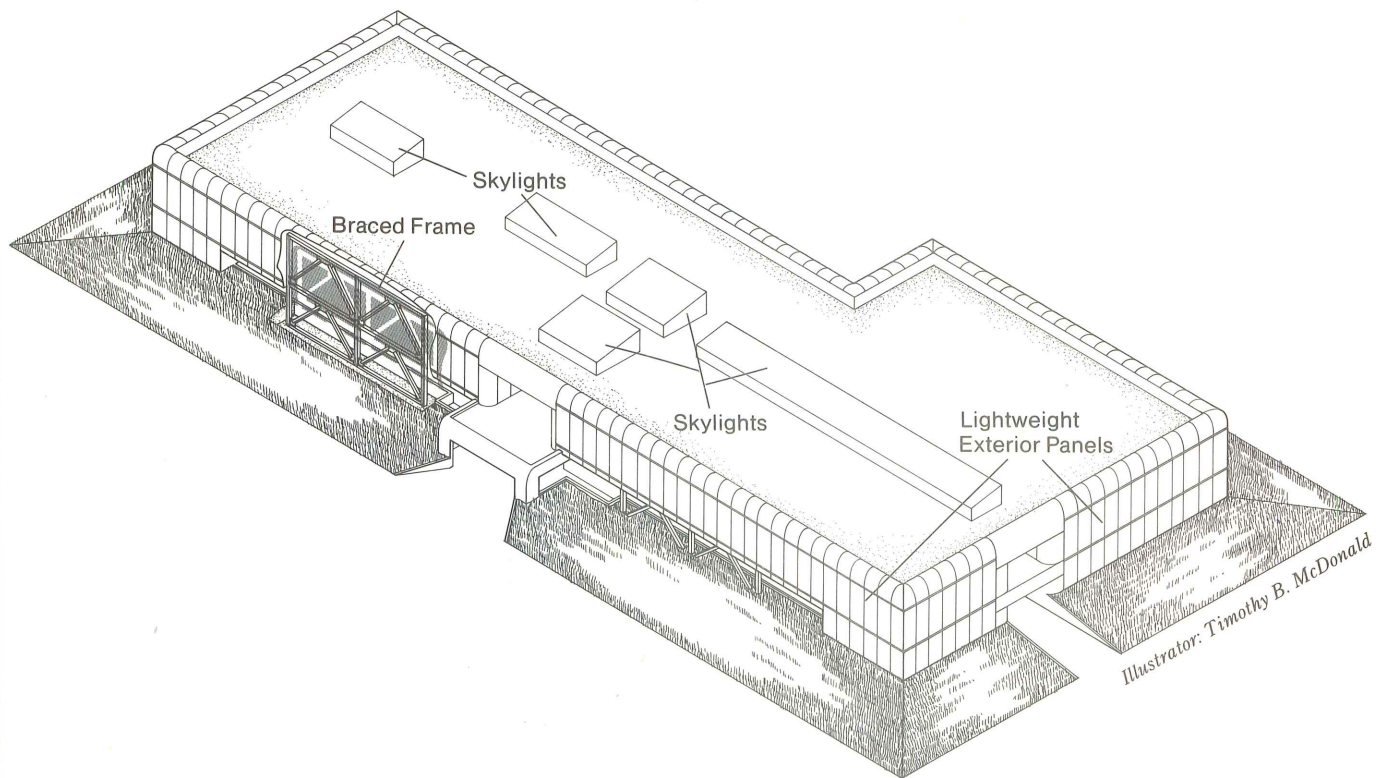

The Blurock Partnership, Architects

Cut your specifying time in half.

MASTERSPEC® 2 for Architects. Prepared by professional specifiers and reviewed by an AIA Committee of experts. This is the system designed for your needs.

It raises your specs to the highest standard of practice and follows the CSI format. It means the end of long hours of repetitive research and technical writing.

And it protects you from "errors and

omissions" and contractors' substitutions.

It's updated quarterly, so you're always current with the latest standards and technology.

Available in hard copy with the option for addition of computer diskettes.

Cut out the coupon and cut your specifying time in half.

Or call Leonard Bain, AIA, toll free, at 800-424-5080.

Cut here.

MASTERSPEC 2

From PSAE Div., AIA/SC,
1735 New York Avenue, N.W.,
Washington, D.C. 20006

Name _____

Title _____ Firm _____

No. of employees _____ Phone _____

Address _____

City _____ State _____ Zip _____

AIA

SAT



Electric Sunshine

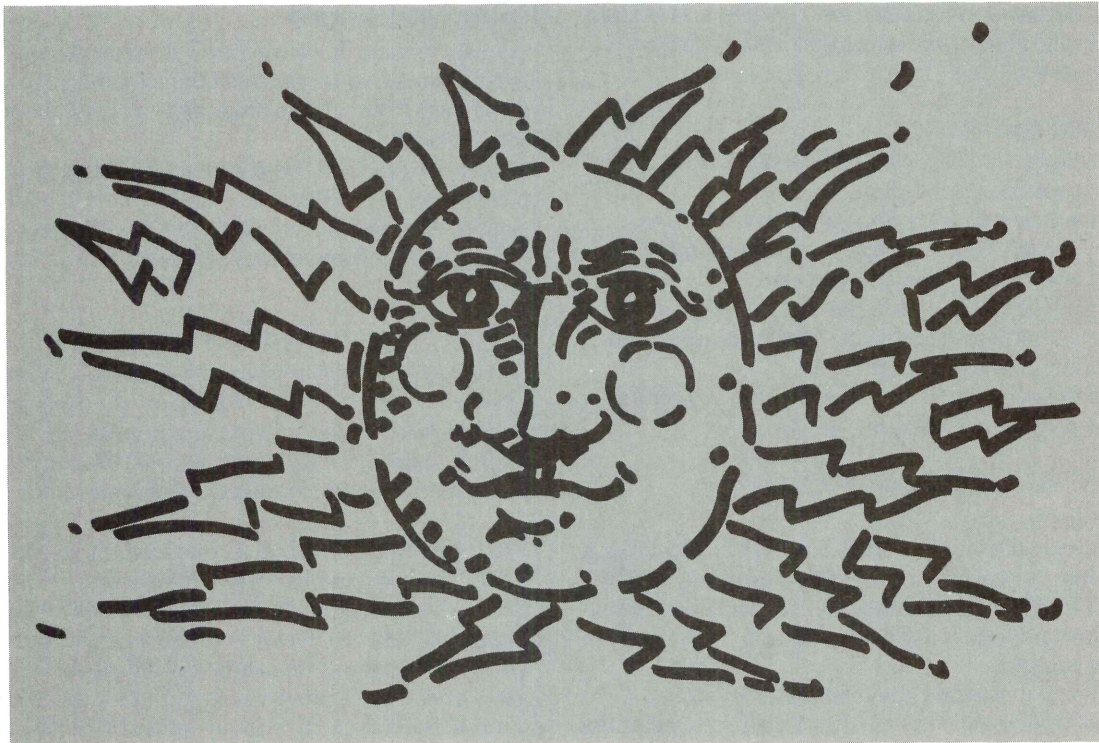

Electric Sunshine travels 93 million miles, and it's a free ride.

Photovoltaic cells are a space-age technology about to come down to earth. Roughly 5,000 U.S. homes and 15 commercial buildings are presently equipped with pv systems. Because costs are coming down, consultant Paul D. Maycock estimates that thousands of pv-powered houses and hundreds of commercial and industrial buildings will be constructed annually in the U.S. by 1990.

George Royal, a program director at the AIA Foundation, has written a brief design and project guide to introduce architects to this emerging technology. Maycock and his associate, Edward N. Stirewalt, have written answers to questions architects often ask about pv technology and the market for pv systems. Maycock was director of DOE's Photovoltaic Division from 1978 to 1981, and is now president of Photovoltaic Energy Systems, Alexandria, Va.

PHOTOVOLTAICS DESIGN AND PROJECT GUIDE

BY GEORGE ROYAL
PROGRAM DIRECTOR, AIA FOUNDATION



UTILITY INTERCONNECTION, REGULATION, SAFETY, FINANCING, insurance, and liability are issues that need to be resolved prior to system design.

UTILITY INTERCONNECTION

Designers should get in touch with the local utility at the onset to determine its requirements for interconnection.

Federal law (the Public Utilities Regulatory Policies Act) requires utility companies to interconnect with PV systems and to purchase excess electricity at reasonable rates.

Interconnection policies vary according to the utility's interconnection experience and their assessment of the risks associated with equipment failure or replacement.

A summary of the important points to be covered in a contract with a utility company is presented on page 38.

LAND USE, DESIGN AND CONSTRUCTION REGULATIONS

Local land use and building code officials should be consulted at the onset to determine local policies. Utility companies typically require that a grid-connected PV system satisfy land use requirements, design standards and construction regulations as a prerequisite for interconnection.

The 1984 National Electrical Code contains a new section (Article 690, Solar Photovoltaic Systems) that minimizes regulatory conflicts. A summary of the new code is presented on page 38.

Solar access law is also being developed in many jurisdictions to overcome conflicts with local land use regulations.

SAFETY PROBLEMS ARE AVOIDABLE

PV systems cannot be "turned off" and will generate some electrical voltage in the presence of any level of illumination, including moonlight. Installers use opaque covers to prevent electrical generation during installation. The covers are removed only when the panels are finally wired together. Electricians are aware of the safety procedures needed, which are outlined in the National Electrical Code. It is important to carefully instruct non-trained employees that may be on the roof helping to mount the systems.

Utilities require that grid-connected systems automatically disconnect from the utility when the utility lines are down. This prevents the PV system from generating electricity into the line while utility employees are repairing trunk circuits. Utilities also require locked disconnect boxes outside the house for use by their repair people.

Electrical grounding and isolation of components according to good engineering practice will minimize shock hazards.

FINANCING ISSUES

Clients seeking financing for PV systems should deal with lenders who are willing to credit them for the projected energy cost savings. The savings projections will most likely be provided by the designer.

Surveys by the U.S. Department of Housing and Urban Development have shown that many lenders are willing to consider loans for solar equipment in this way, so clients should be advised to try a different lender if they run into resistance from the first one they try.

LIABILITY AND INSURANCE ISSUES

A survey of insurance companies indicates that coverage for PV systems is available and rates are about the same as for conventional systems, as long as "good engineering practices" are followed. Professional liability insurance for designers and casualty and liability insurance for clients are recommended.

COST EFFECTIVENESS AND DESIGN FEASIBILITY

Using the nomographs presented with this article designers can quickly obtain rough estimates of the cost-effectiveness of a proposed system and the area needed for the collector array.

Since solar energy is an inherently diffuse power source, large surface areas are required to collect it. A flat-plate PV system, for example, requires about 100 square feet of collector area to generate a peak output of one kilowatt at noon on sunny days (assuming a 10 percent overall system efficiency). The array size is a key parameter in system design because it determines the peak output of the system and also many of the requirements for subsystems.

ECONOMIC TRADEOFF ANALYSIS

Designers need not be too concerned about accommodating the exact "optimum" array area. Usually there is a range of collector areas that can produce PV systems that are cost effective. The best size for the system depends on the type of collector, the location, the electric loads, PV system costs, utility electricity prices, the utility's sell-back rate, the client's financial situation, and other variables. In the future, standard-sized package systems may be developed for specific building types or applications.

For now, designers need to perform an economic trade-off analysis to determine the collection area needed for utility-connected systems. Because the utility can always provide back-up power, it is not necessary to provide enough PV-generated power to meet the total electricity demand. Oversizing the collector array will produce more energy than can normally be consumed on-site. Undersizing the system will make it impossible to save enough

Photovoltaic (PV) systems convert sunlight into electricity. Most systems interconnect with the utility company grid so the utility company can supply electricity to the house when loads exceed PV system generation, and excess electricity can be sold to the utility.

A typical residential utility-interconnected PV system with a roof-mounted photovoltaic array is shown in Figure 1. It consists of three subsystems:

- Array Subsystem: a mechanically and electrically integrated assembly of photovoltaic modules designed to provide a specified amount of DC electrical power under specified operating considerations.
- Power Conditioning and Control Subsystem: operates as a current source, inverting the DC array output to AC, and acts in parallel with the utility to supply power to building loads.
- Power Conditioning and Control Subsystem: operates as a current source, inverting the DC array output to AC, and acts in parallel with the utility to supply power to the building.

The PV array converts solar radiation to DC electricity for input to the power conditioner. In the illustration the array wiring is shown running through a conduit to a fused outdoor electrical disconnection switch. Although current overloads are not likely to be produced by the PV array, fusing may become a code requirement to protect the power conditioning unit from extreme currents in the array wiring such as those induced by a close lightning flash.

The earth ground wire coming from a metallic frame for the array eliminates the shock hazard potential due to static charge buildup or an electrical fault between the solar cell and the frame.

The array wiring is protected from lightning-induced high voltage by surge arrestors located in the array circuit panel board inside the residence. A manual disconnection switch is also provided to insure isolation of the PV array when required during power inverter maintenance or repair.

The power conditioner converts the DC current from the array to residence-compatible AC, and also contains the system controls. The inverter executes the following functions: automatic start-up (morning), automatic shut-down (evening), and array voltage control. When electrical loads are not satisfied by the PV system, auxiliary power is drawn from the utility grid. When PV system output exceeds electrical loads, that excess power is fed back to the utility. The control must provide for automatic disconnection from the utility lines in the event of power loss—a safety feature to protect those working on downed lines.

Since the system allows two-way power flow to the local utility, ratcheted kilowatt-hour meters are provided to record the flow of energy to and from the utility.

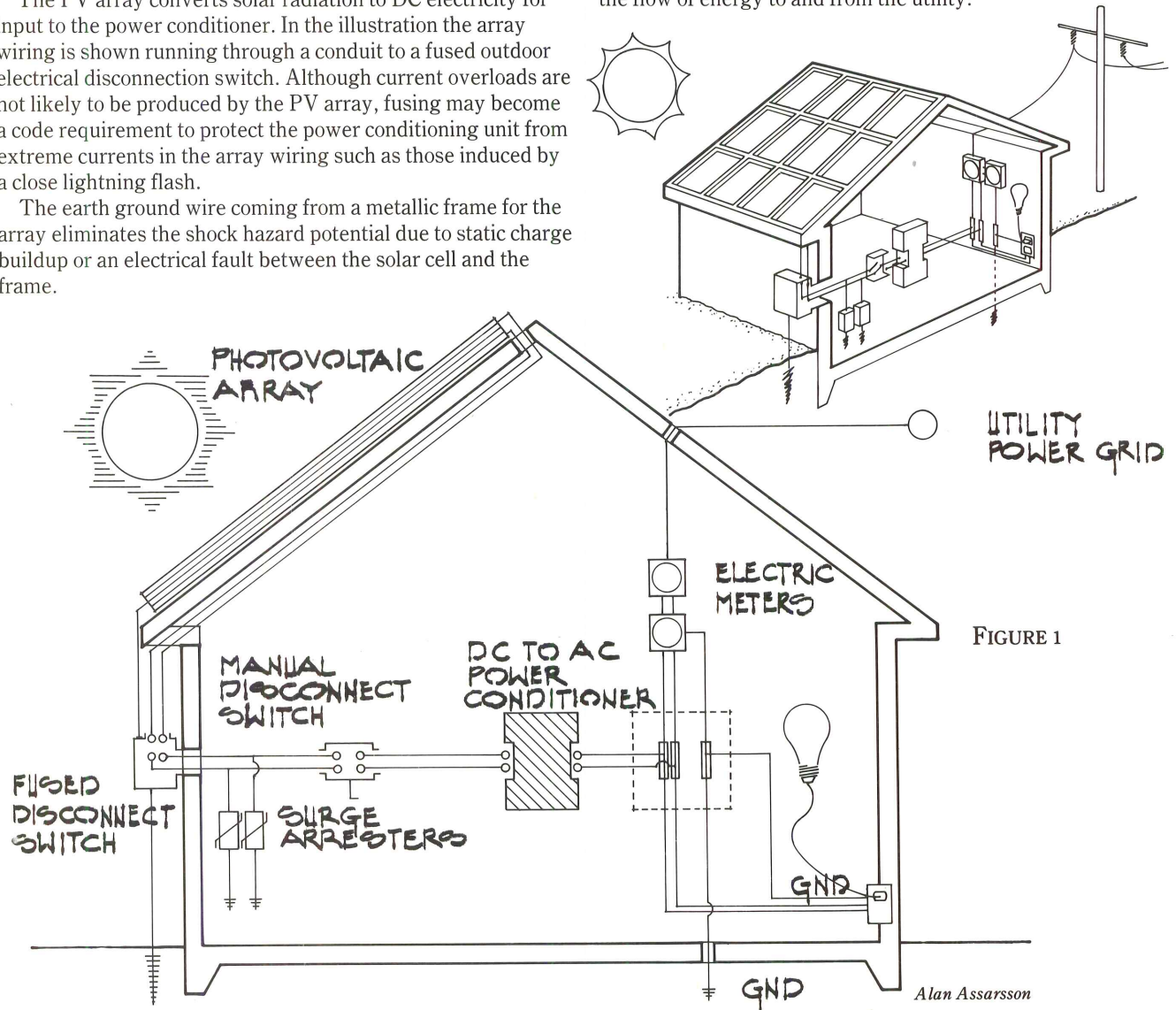

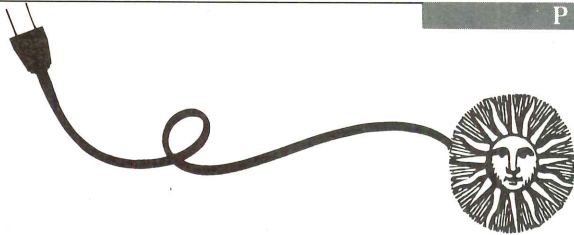

energy to offset the initial fixed costs of the system, and many of the initial costs are independent of the array size.

The available area, especially for roof-mounted systems, often

dictates the maximum array size. In estimating the available area for horizontal mounting surfaces, the designer must also account for spacing between PV modules to prevent shading. □

UTILITY COMPANY CONTRACTS

The utility and the PV system owner/operator usually sign a "Small Power Production Generation Agreement on an As-Available Basis" to establish utility-interactive service.

The utility agrees to provide service to the customer, and to permit the customer to operate a small power production generator that meets the FERC criteria for a "qualifying facility." The agreement allows the PV system to generate all or part of the customer's electrical requirements, or to supply its total generated output to the utility. Such agreements typically contain the following provisions:

- **Terms and Conditions:** Rates, charges, service, obligations and governing law applying to the agreement.
- **Design and Operation Guidelines:** Design requirements and operating procedures for both the utility and the PV system owner/operator.
- **Payment Schedule:** Prices available to qualifying facilities, the daily and seasonal peak time periods, and the conditions for payment.
- **Plant Schematic:** A diagram showing the PV system, interconnection equipment, and associated protection equipment for the utility company.
- **Interconnection Equipment Schedule:** List of utility interconnection and line extension facilities necessary to connect the utility system and the PV system.

NATIONAL ELECTRICAL CODE

The 1984 edition of the National Electrical Code published by the National Fire Protection Association includes a new section on Solar Photovoltaic Systems (Article 690).

The section applies to both stand-alone systems and those that interconnect with a utility, and systems with or without electrical storage capacity. System array circuit(s), power conditioning unit(s), electrical storage and storage subsystem controller(s) are covered. The code establishes PV system classifications, criteria for safety, wiring methods and conductor sizes—thus eliminating conflicts with other NEC provisions. The following major topics are addressed:

- **Circuit Requirements:** Voltage ratings, fixture and access restrictions, ratings for overcurrent devices, and components and equipment requiring overcurrent protection.
- **Disconnection Means:** Requires conductors to be disconnectable using fuses, switches, or circuit breakers; requires disconnection of the array or portions of the array.
- **Wiring Methods:** Permissible wiring systems, such as single conductor cable. Specification of component interconnections, connectors, and junction box access.
- **Grounding:** Requirements for grounding, such as conductor size and recommended location.
- **Marking:** Labeling and identification requirements to ensure safe and reliable installation, operation, and maintenance.
- **Connection To Other Sources:** Establishes the point of interconnection between the utility and the PV system, identifies unbalanced equipment interconnections and specifies requirements for PV system disconnections in the event of loss of utility voltage.

ESTIMATING COST-EFFECTIVENESS

STEP 1: ESTIMATE PV SYSTEM PERFORMANCE

- Estimate Average Daily Insolation (kWh/m²d). The map shown here gives the daily mean direct normal solar radiation for a particular location.
- Estimate Average System Efficiency PV system efficiency is usually assumed to be about 10 percent, based on nominal estimates for typical equipment.
- Determine System Output (kWh/m²d)
- Estimate Utilization Factor The utilization factor depends on the match between load and PV output, but can be estimated as 0.8, assuming "good" design.

STEP 2: ESTIMATE PV SYSTEM COST

- Estimate Alternate Electricity Cost (\$/kWh) An electric energy cost should be estimated based on average daytime \$/kWh energy charges, but not fixed on-demand charges that the PV system does not offset.
- Determine Annual Fuel Savings (\$/m²y)
- Estimate Installed System Costs (\$/m²) The installed PV system cost should be adjusted for available tax credits. For example, federal tax credits alone can be as much as 40 percent of the installed cost for homeowners and 25 percent of equipment costs for businesses. Depreciation should also be included.

STEP 3: ESTIMATE RATE OF RETURN ON INVESTMENT

- Determine Simple Payback (years)
- Estimate Time Horizon (years). The useful life of the PV system is usually 20 to 30 years.
- Estimate Energy Escalation Rate (percent per year) It is important to estimate an annual electricity escalation rate, since electricity costs will probably increase over time.
- Determine rate of return on investment.

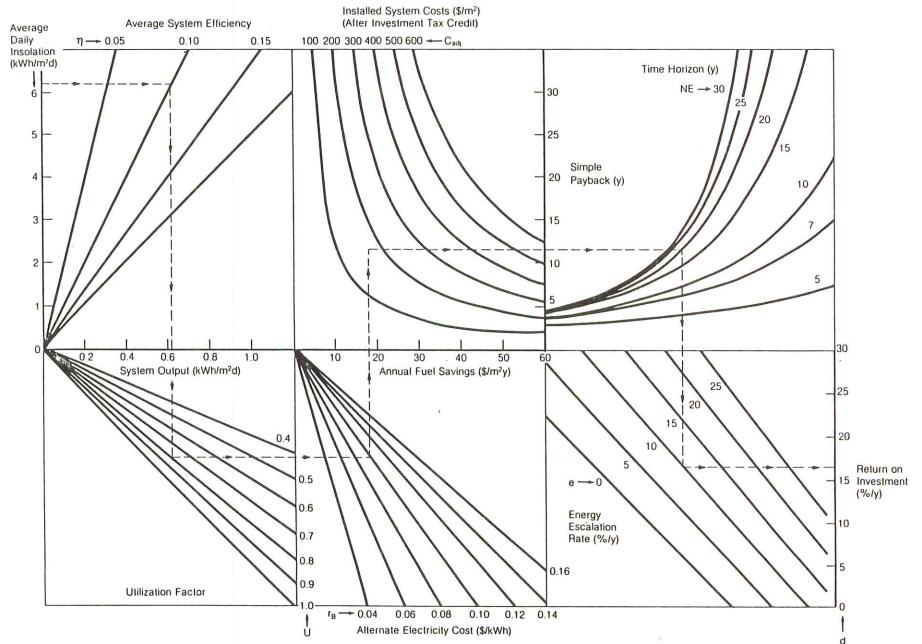

Economic Feasibility Nomograph

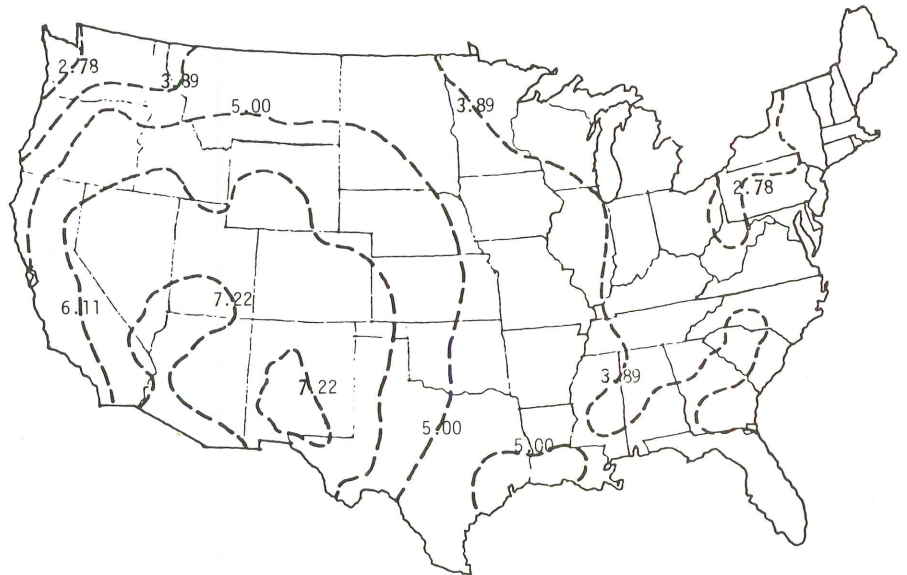

Average Daily Insolation

ESTIMATING PV COLLECTOR AREA



STEP 1: ESTIMATE THE DIRECT FRACTION

- Estimate Utilization Factor**
 The utilization factor characterizes how efficiently the energy output of the PV array is utilized for on-site loads. A utilization factor of 0.8 is generally a suitable value for feasibility analysis. In general, the utilization factor is defined as:

$$UF = DF + [(1-DF) \times SBR]$$
 Where:
 UF = the utilization factor
 DF = the direct fraction of the PV energy — the percent of the PV output that is supplied directly to the building load
 $(1 - DF) =$ the excess of sell-back fraction
 SBR = the sell-back ratio; ratio of sell-back rate to purchased electricity rate

- Estimate Sell-Back Electricity Price Ratio (SBR)**
 The sell-back ratio will generally be less than one, since utilities are not able to use the excess energy (a varying, time-dependent power source) as effectively as their own generation. On the other hand, the sell-back ratio should be larger than 0. Utilities are currently required to pay for on-site generation at "avoided cost" — the amount it would have cost the utility to generate the same amount of new power.
- Determine the Direct Fraction**
 The direct fraction is that fraction of the PV system output that directly displaces on-site loads.

STEP 2: ESTIMATE THE SOLAR/LOAD RATIO

- Estimate Solar Fraction Coefficients**
 The solar fraction coefficients measure the match between load shape and PV output profile, and depend on solar radiation, the season, collector type and load characteristics. For this preliminary feasibility analysis, typical values are shown in the accompanying table.
- Determine Solar/Load Ratio**
 The solar load ratio is the ratio of day-time electric energy consumption to PV system output.

- Estimate Electricity Consumption (kWh/d)**
 The daytime (8 a.m. to 5 p.m. solar time) electricity consumption for the building should be estimated.
- Determine the Collector Array Area (m²)**
 It should be emphasized that the array area calculated is not necessarily the economically optimum array area. Rather, it is an economically feasible array area consistent with the utilization factor previously chosen. Optimization of the array area requires a more careful analysis of fixed costs (system costs which do not vary with size) and proportional costs (system costs that do vary with size), and should be based on seasonal performance estimates.

STEP 3: CALCULATE ARRAY AREA

- Estimate Average Daily Insolation (kWh/m²d)**
 The solar radiation map gives estimated daily insolation for various regions.
- Estimate Average System Efficiency**
 The PV system efficiency is the fraction of available insolation that is converted to AC electrical output energy, and should include the effects of shading losses (0 to 15 percent for flat-plate collectors, depending on obstructions and row spacing), PV module conversion efficiency (currently about 12 percent for good flat-plate modules with circular cells, 14 percent with closely packed rectangular cells), electrical wiring losses (2 to 3 percent), and power conditioning losses (10 percent). A reasonable value for feasibility analysis is 10 percent overall efficiency.

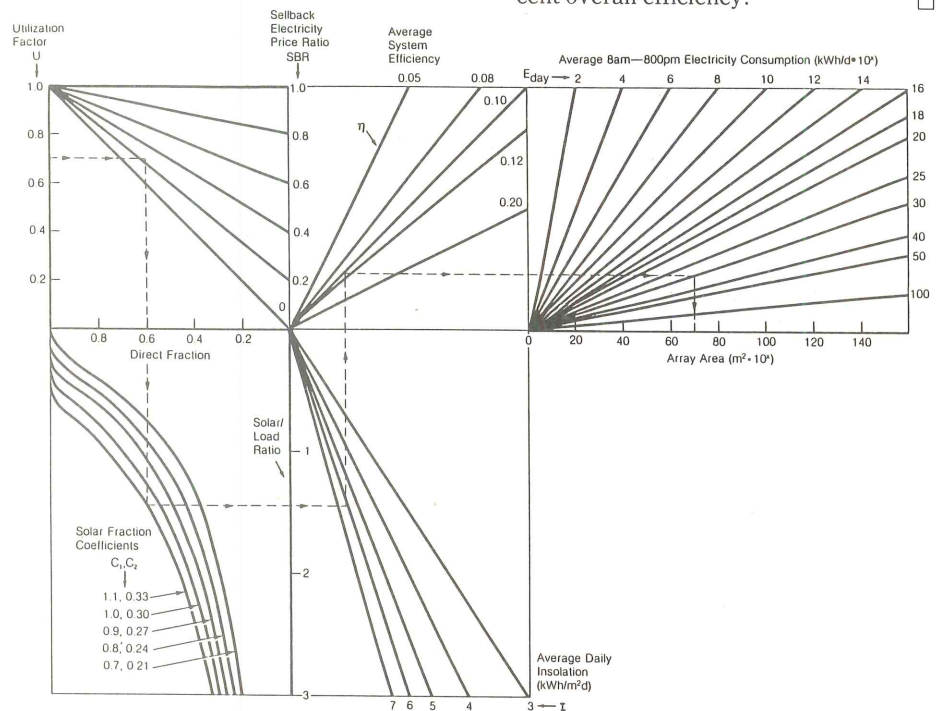

Array Area Nomograph

Load Shape	Annual Clearness Index	Coefficients	
		C ₁	C ₂
Residential	>0.5	1.1	0.33
	≤0.5	1.0	0.31
Commercial	>0.5	1.1	0.32
	≤0.5	1.0	0.30

Typical Solar Fraction Coefficients

EXPERTS ANSWER KEY QUESTIONS ABOUT PV SYSTEMS

By PAUL D. MAYCOCK AND EDWARD N. STIREWALT

GEORGE ROYAL HAS PRESENTED A CLEAR OVERVIEW OF PHOTO-voltaics. We will attempt to answer several key questions that are important to the architectural profession.

What's the difference among the PV modules now offered by U.S. manufacturers?

The three dominant manufacturers in the U.S. — ARCO Solar, United Energy Corporation, and Solarex — each sell a different type of module.

ARCO Solar, which sold 8 of the 15 megawatts shipped in the U.S. last year, sells only single crystal silicon modules. These are made from semiconductor-grade silicon through a manufacturing process that pulls a large ingot from a crucible of molten silicon, and then slices the ingot into wafers. Impurities are then added to each wafer to enhance its performance as a solar cell. Metal is added to the top and bottom of each wafer to collect electricity.

Exxon's Solar Power Corp., which recently went out of business, also produced single crystal cells, shipping just 0.4 megawatts last year. Another small single crystal manufacturer, Photowatt, sold out in December 1983. Other small manufacturers, including Solec, Solenergy, and Sollos offer single crystal modules.

United Energy Corp. shipped 4 megawatts of concentrator modules last year, which are used for central generation systems. The concentrators focus the sunlight onto a silicon solar cell by using a Fresnel lens. The UEC concentrator modules use a unique two-axis tracking system that tracks the north-south path of the sun by shaft rotation around one axis. Tracking east-west variation in the sun's path is achieved by floating the entire collector on a small circular pond of water. The solar cells are four feet away from the water, and the floatation of the entire mass on water saves structural costs.

Most purchasers of the 2.5 kilowatt modules have been investors interested in tax shelters. The investors buy a module that produces metered electricity for an alcohol production plant in Barstow, Calif.

Solarex, recently acquired by AMOCO Oil Co., sells cast semicrystalline modules, which use less expensive metallurgical-grade silicon in place of semiconductor grade. Since the grain boundaries in metallurgical-grade silicon are so large, wafers cut from cast metallurgical-grade silicon cubes are called polycrystalline or semicrystalline. Cells are produced by adding impurities and metal to the wafers. Solarex shipped 1.5 megawatts in 1983.

Mobile Solar Corp. is developing a new approach to cell manufacturing called the ribbon process, in which a vertical ribbon of silicon is pulled from a carbon die set in a bath of molten silicon. This eliminates the time and waste associated with slicing an ingot or cast cube. Long ribbons produced through this process are cut into shorter ribbons before impurities and metals are added.

A new, less expensive type of cell, amorphous silicon, is expected to be available on the market in late 1984. The amorphous silicon cell uses three very thin film layers of silicon to accomplish solar energy conversion. The films, which are deposited from pure gas vapors or plasmas, convert solar energy at an 11-12 percent efficiency rate, compared to the 6-7 percent efficiencies of existing products. The reduced use of silicon and the increased process efficiency of manufacture are expected to reduce module cost by 90 percent.

Amorphous silicon research and pilot production are underway at several U.S. companies, including Energy Conversion Devices in Troy, Mich.; Chronar Corp. in Trenton, N.J.; ARCO Solar in Woodland Hills, Calif.; Solarex/RCA in Newton, Pa., and Spire Corp. in Bedford, Mass.

What is the cost of a typical residential installation using these various types of modules?

All the module types that are currently on the market cost about

PV MODULES PURCHASED IN U.S. (megawatt power)

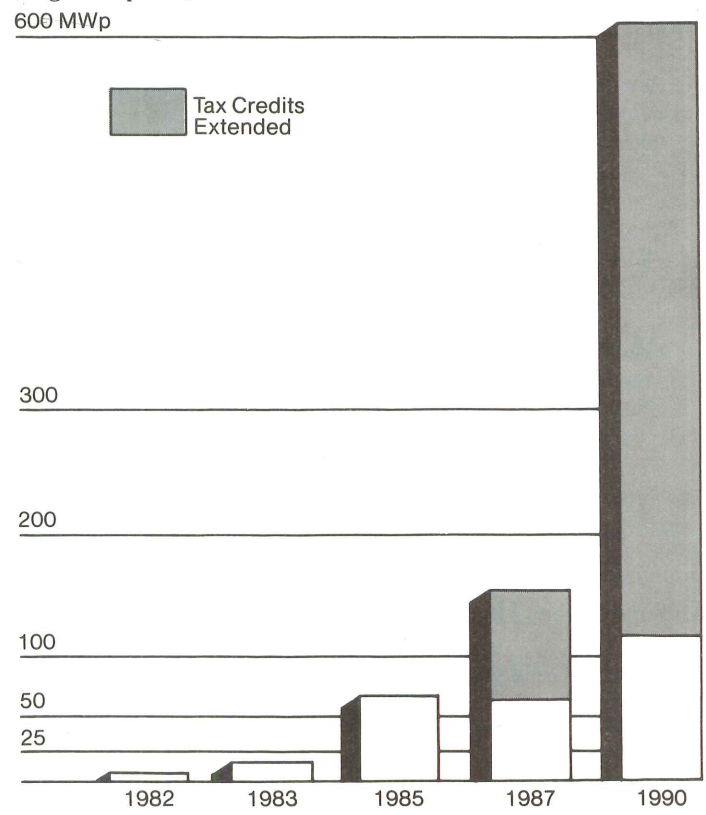

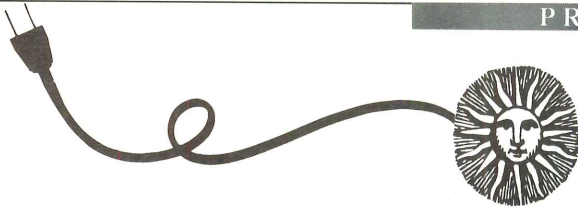

the same. For a relatively small residence having a 100 square meter south-facing roof, total pre-tax installed system cost would be about \$40,000. For clients who can afford them, PV systems are an obvious choice for building sites that are located where utility grid service is not available.

What tax credits are available?

The existing federal tax credits, due to expire at the end of 1985, offer a 40 percent credit on expenditures for residential PV systems, to a maximum credit of \$4,000. Businesses can claim a 15 percent energy tax credit for equipment, plus the regular 10 percent investment tax credit. A number of bills are currently pending in Congress that would extend or expand these credits. In addition, many states offer tax credits for investments in PV equipment. Some states allow "double dipping"—claiming credit on both state and federal income taxes.

What will the market for PV systems look like in five or six years?

Assuming extension of the current federal tax credits, it is realistic to believe that a few thousand PV-powered houses, several hundred industrial/commercial projects, and 10 or so central power station projects will be started each year in the U.S.

These projections are based on a U.S. market of 100 megawatts in 1990 (compared to 15.7 in 1983), which we think is a conservative estimate. U.S. demand could be as high as 600 megawatts annually by 1990 if the tax credits are extended. The international market will be at least five times as large as the domestic market and offer further opportunities for U.S. design firms.

Are costs expected to decrease significantly during this time period?

The market will grow primarily because the installed costs of PV systems will decrease significantly due to the development of amorphous silicon and other technical advances. We forecast PV modules will drop from the \$6/Watt 1984 factory price to \$2/Watt by 1990. Installed systems will decrease from the current \$10-15/Watt to \$3-5/Watt by 1990.

What are the principal design factors that affect the performance of a PV roof?

The way a PV module is integrated into a roof has a dramatic impact on performance.

The electrical output from a PV module decreases about 0.2 percent for every degree Centigrade that the module operates above 25 degrees Centigrade. The modules must be mounted in a way that will permit air circulation around the modules to keep them cool.

Figure 2 shows four mounting techniques for roof-mounted systems.

The rack-mounted technique is often used on flat surfaces. The racks give PV modules maximum exposure to cooling winds, but present aesthetic problems. Racks are usually set back so the equipment cannot be seen from the street, as with other roof-mounted HVAC equipment.

The stand-off mounting technique places the modules parallel to the roof, but permits air circulation between the roof and the modules. This can also provide adequate cooling.

Roof-integrated systems use the modules as the roofing material, replacing the wooden and felt deck. The back side of the module is exposed to the attic space. This rear exposure allows for easy interconnection, easy maintenance, and simple removal of the modules from the inside. Systems of this type have demonstrated very good performance, but require attention to detail regarding rain-proofing. Many designers have found that standard sealing techniques work well.

The direct mount technique—placing the module directly against the roof-wood substrate and/or the roofing material—carries the greatest risk of overheating.

The Florida Solar Energy Center is currently performance testing various mounting and sealing techniques on both wood-frame and masonry instrumented test houses. This work is funded by the U.S. Department of Energy.

What about the angle of the roof in relation to the sun?

The design of the building should largely determine the roof slope. Angling the modules so they face due south with a slope equal to the latitude permits optimum performance, but a slope that varies 15 degrees in either direction will decrease annual performance by 10 percent or less. So if aesthetics or other design considerations demand a slope 15 degrees below or above the altitude, the architect is encouraged to set the roof slope within this range.

In hot climates where the air-conditioning load is heavy, the slope of the roof should be more horizontal to capture the more direct summer sun. The opposite is true in climates where winter demand is greater.

Large industrial systems and central stations use "tracking panels" that move so they are aimed directly at the sun about 10 hours a day, which can increase performance by more than 40 percent on an annual basis.

The ARCO Solar 6 megawatt facility at San Luis Obispo, Calif., and the 1 megawatt facility at the Lugo Power Station near Hesperia, Calif., both use 2-axis tracking flat plate panels. One of these pedestal-mounted units is approximately 100 square meters in area, which is about the same size as a typical roof-mounted residential system.

Stand-alone, ground-mounted tracking systems can be appropriate for commercial, industrial, and institutional complexes where there is adequate space and land is not expensive.

What about wind loading and hail?

If properly anchored to withstand the wind loads specified in the codes for a particular region, rack-mounted and parallel-mounted systems present no special wind-related problems. PV panels are covered with tempered glass and designed to withstand 2 inch-diameter hail stones at terminal velocity.

Do the modules have to be kept clean?

In a typical climate with an inch of rain or more each month, the cleaning action of the rain is enough to keep the modules performing at their design output. In very dusty climates with hardly any rain, dust can degrade the output of the system by as much as 15 percent.

DIRECT MOUNT

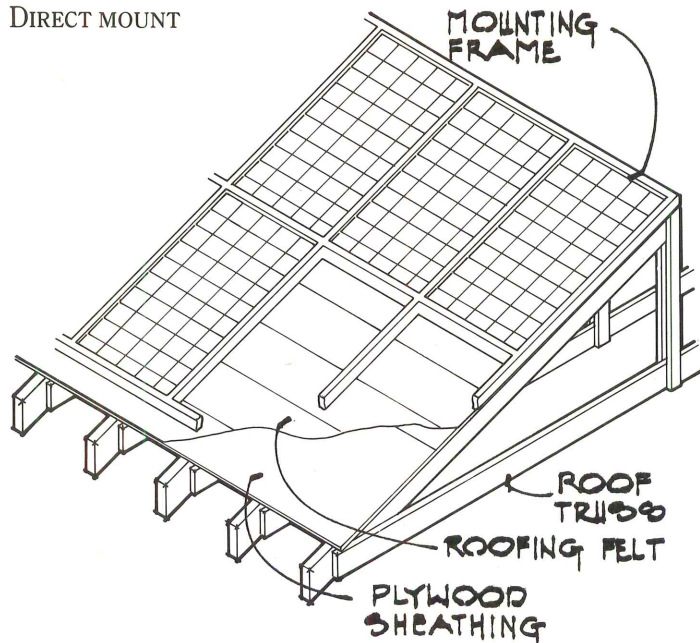

RACK MOUNT

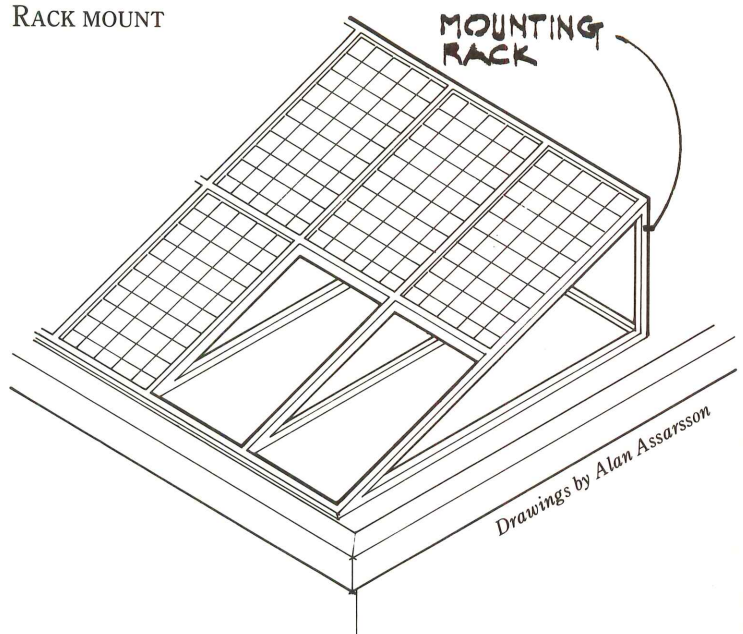

INTEGRAL MOUNT

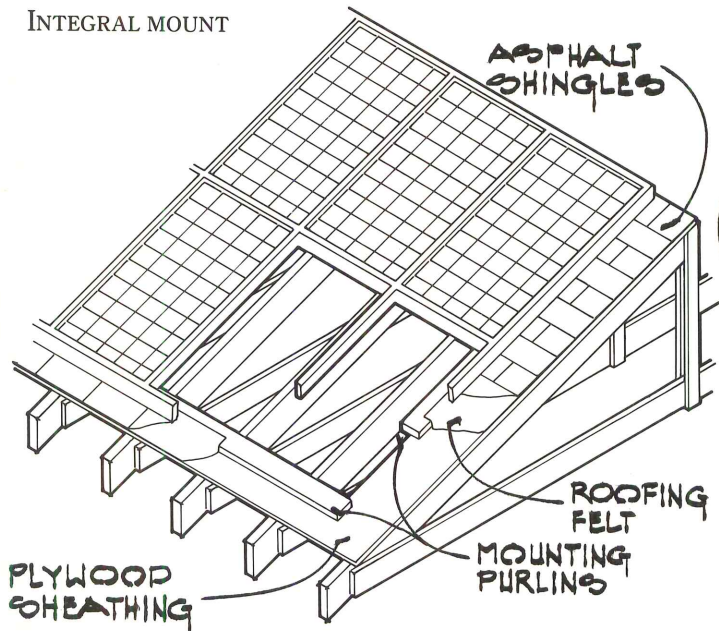

STANDOFF MOUNT

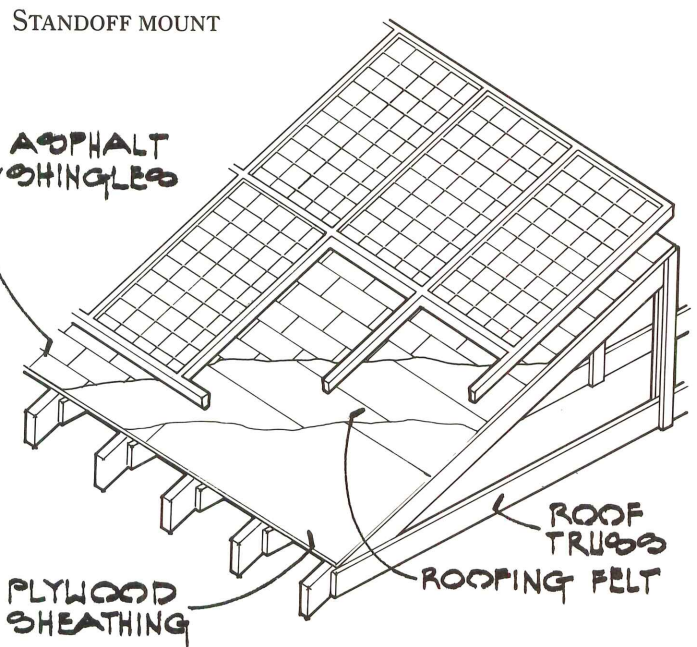

FIGURE 2

How about other maintenance?

A well designed PV roof system should require virtually no maintenance. Most manufacturers provide a five-year, 90 percent performance warranty on the modules. The power conditioners, which convert the direct current of the modules to DC power, have not been used long enough to ascertain their reliability. We recommend estimating a service rate of one call or less per year when budgeting for lifetime costs of a PV system.

Can PV roofs be aesthetically pleasing?

The first modules on the market looked like a collage of large dark blue circles on a white background. Many persons found this

to be aesthetically disturbing.

Now architects can choose among black, blue, and dark brownish-red colored modules in various shapes, and select anodized aluminum flashings to match or contrast with the modules.

Conclusion

Widespread use of PV systems will help reduce air pollution, save expensive fossil fuels, and expand our economic base by creating a variety of new jobs in manufacturing, selling and servicing. Architects can play a major role in making it happen! □

ENVIRONMENTAL IMPACT CHART AND CHECKLIST

BY THE AIA REGIONAL DEVELOPMENT
AND NATURAL RESOURCES COMMITTEE

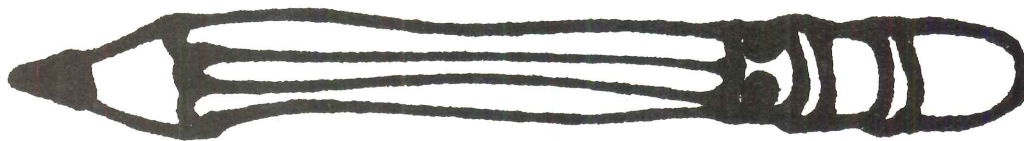

INTRODUCTION AND BACKGROUND

THE ENVIRONMENTAL IMPACT CHART IS AN EFFORT TO suggest in general terms those factors of the physical environment most commonly examined in the architectural design process. The Chart is a simplification of materials readily available from many sources and is derived from work in environmental impact evaluation and assessment.

The environment—geology, biology, and climate—are all modified when we build, and we must decide whether the modifications are positive or negative, and how we can mitigate or minimize the negative impacts. When we value a view or want to eliminate a particular landscape feature, we allow our visual and perceptual values to affect the impact of design on the environment, so these were also included in the Chart.

The Ecological and Environmental Checklist has been modified from a more elaborate ranking format. The simplified format assumes that architects are sensitive to the environment and capable of professional judgements regarding the positive or negative consequences of development. The Checklist allows users to quickly determine whether a particular location exhibits any special environmental characteristics that might not be immediately evident, or whether a particular project might have an unusual impact upon those environmental characteristics.

The items listed were derived from a review of all the possible impacts of a construction project. A specification sequence was prepared, and the actions that are likely to have environmental impacts were condensed to the Checklist items. Some may not apply in any given case, and others can be added by users as they are identified. The Checklist was used in two professional offices and modified as a result.

The traditional design approach examines how the environment will affect our buildings. It is important, however, to also use the Chart and Checklist to determine the impact of construction

work on the ecology and environment. These aids are intended to draw attention to the ways in which we affect the world around us in our professional work.

—Peter Coltman

LIMITATIONS ON USE OF THE CHECKLIST

The Checklist will identify when a decision concerning ecological changes is required. The architect must judge the relative importance of the impacts identified within the context of the site and its surroundings.

A project with 90 percent site coverage may have an overwhelming ecological impact; a tool shed on a one-acre woodlot may exert a minimal impact relative to intensity. Hundreds of tool sheds over hundreds of acres, however, exert a large total impact. There is a small, but cumulative ecological modification.

A building will have different ecological consequences on differing sites. A single Checklist identifying a wide variety of environmental features cannot deal specifically with each and every use or condition. It is a guide upon which additional knowledge and insight can be built. The list itself can be expanded or reorganized depending on the procedures preferred by its users or the conditions apparent on the site.

This Checklist was prepared by the Regional Development and Natural Resources Committee, with Peter Coltman, associate professor of Architecture and Planning, University of Texas at Austin, directing the project. Other committee members contributed substantially. Special thanks are extended to Richard Stein, AIA (The Stein Partnership, New York, N. Y.), who provided editorial direction and steered the work through text modifications; and Herschel Elarth, FAIA (Professor Emeritus of Architecture, Virginia Polytechnic Institute State University, Blacksburg, Va.), and Zigurds Grigalls, AIA (Stetson-Dale, Utica, N. Y.), who tested the Checklist on actual projects.

ENVIRONMENTAL IMPACT CHART

A catalog of factors to be considered as development decisions are made.

A. CLIMATE

FACTOR	POSSIBLE IMPACTS FROM ARCHITECTURAL ACTIONS
<p>PRECIPITATION: Seasonal pattern, intensity, maximum storm, lightning, drought periods, snow, hail, frost</p>	<p>POSITIVE— Control rate of run-off. Impound water for other areas. NEGATIVE— Increased run-off, reduced soakage into sub-surface, altered watertable, waterlogging, erosion, sedimentation, stream and aquifer pollution.</p>
<p>AIR MOVEMENT: Seasonal pattern, speeds, direction, calm periods, hurricane, tornado</p>	<p>POSITIVE— Control rate of air movement for cooling and purging. NEGATIVE— Wind tunnels, exposure to extremes, interruption of direction, leeward eddies, whirlwinds, blocking breeze on leeward side, interruption of adiabatic movement, inversions</p>
<p>TEMPERATURES: Seasonal pattern, maximum/minimum comfort, freezing periods, permafrost</p>	<p>POSITIVE— Use of thermal mass for storage to reduce temperature extremes. NEGATIVE— Increased reflection, reradiation, ice-prone shadow areas, energy demand increased.</p>
<p>SUNLIGHT, RADIANT HEAT: Seasonal variation, altitude angle, reflection, glare, cloud periods</p>	<p>POSITIVE— Orientation and glazing for passive solar heating and cooling, reducing need for conventional fuels. NEGATIVE— Excessive heat gain or loss, vegetation in shadow areas, visually uncomfortable reflection.</p>
<p>RELATIVE HUMIDITY: Seasonal variation, maximum/minimum comfort levels</p>	<p>NEGATIVE— Increased moisture output, condensation from emissions.</p>
<p>SOUNDS: Seasonal variation, intensity, storms, animal and insect life, lightning</p>	<p>NEGATIVE— Sounds of rain, hail, thunder, running water and wind may dictate some site decisions.</p>
<p>AIR QUALITY:</p>	<p>NEGATIVE— Change through loss of green plants and photo-synthesis. Reduction of oxygen, production of carbon dioxide, sulfur, other gases. Contribution to acid rain.</p>

B. BIOTA: VEGETATION AND WILDLIFE

FACTOR	POSSIBLE IMPACTS FROM ARCHITECTURAL ACTIONS
<p>TREES AND BRUSH: Types, quality, density, height, resource potential</p>	<p>POSITIVE— Introduce trees, brush to enhance conditions. Orchards, timber forests, construction lumber. Provide shade. Provide visual delight. NEGATIVE— Increase surface temperatures, erosion, reduce quality, number of specimens, imported species, invasion species, alter ecological domain/relationships, affect soil and sub-surface stability, affect regeneration.</p>
<p>GROUND COVER: Grasses, shrubs, vines, flowers, food crops, biomass, hazards (e.g. poison ivy)</p>	<p>as above</p>
<p>WILDLIFE: Types, habitat and migration patterns, complexity of domain, hazards, (e.g. dangerous animals)</p>	<p>NEGATIVE— Retreat of species, loss of habitat, nesting, etc., invasion species, destruction of wildlife trails.</p>
<p>INSECTS: Types, density, role in ecological stability, hazardous types (e.g. anopheles mosquito), beneficial types (e.g. praying mantis, bees), hazardous forms (e.g. malaria)</p>	<p>POSITIVE— Reverse of below by planned intervention. NEGATIVE— Increase in hazardous types, decrease in beneficial types. Possible increase in, or control of, nuisance.</p>
<p>FUNGI: Types, density, habitats, hazardous types (e.g. amanita), beneficial types (e.g. morels)</p>	<p>see above</p>
<p>DOMESTICATED ANIMALS: Cultivated herds, individual animals, work animals, pets</p>	<p>POSITIVE— Fertilization for soil NEGATIVE Odors, sounds, destruction of vegetation</p>
<p>HUMAN BEINGS: Manipulators of biota, part of biota, reference for such phrases as "quality of life"</p>	<p>POSITIVE— Enhancement of quality of life, creation of environments that permit sustainable life for increasing populations. NEGATIVE— Curtailed richness and variety of life.</p>

ENVIRONMENTAL IMPACT CHART

C. GEOLOGY

FACTOR	POSSIBLE IMPACTS FROM ARCHITECTURAL ACTIONS
SOILS Type (engineering qualities, depth, permeability, shrink/swell, chemicals, fertility, corrosivity), slope stability, resource potential	POSITIVE— Improvement in soil quality and productivity. NEGATIVE— Washing out nutrients, polluting water bodies and systems, loss of topsoil, erosion, sedimentation, alteration in permeability, reduced fertility, corrosion of construction materials, lost resources.
ROCK TYPES: Depth of rock strata, depth of bedrock, stability, permeability, resource potential	POSITIVE— Opportunity for creating new useable sites by rehabilitation after surface mining or other activities. NEGATIVE— Stability reduced, settlement possible, greater dispersal of groundwater, impact on local wells, pumping, corrosion of construction materials, resources lost.
HYDROLOGY: Surface patterns, standing water, marsh, bog, watertable seasonal fluctuation, flow of groundwater, rights to water, chemical, organic content	POSITIVE— Reclamation of desert areas for productive use through redistribution of water resources. Divert flow, create "dry" areas, alter run-off patterns, reduce/increase groundwater available. NEGATIVE— Add pollution to aquifers through leaching of harmful waters (toxic and radioactive). Vegetation dies off, water resources lost.
TOPOGRAPHY: Definition of watersheds, slope angles, direction, stability, complexity of surface	POSITIVE— Create new usable land, allow access roads. Reduce erosion. NEGATIVE— Erosion, sedimentation, surface temperature increase, reduce stability.
UNUSUAL FEATURES: Bog, swamp, high shrink/swell collapsing soils, slope stability, sink-holes, flood areas, steep slopes, bluffs, volcano, earthquake, rare minerals or water type, paleological and archaeological features	NEGATIVE— Disturbance of fragile ecology, reduction, damage, chemical degradation, patterns, loss of unique areas, etc.

D. VISUAL AND PERCEPTUAL VALUES

FACTOR	POSSIBLE IMPACTS FROM ARCHITECTURAL ACTIONS
ACTIVITIES AND USES: Historic, archeological/paleological, current uses, proposed uses	POSITIVE— Affects values used in design and how to benefit from them: Visibility of roads, utility lines, buildings, vegetation. NEGATIVE— Loss of natural conditions and landscape values.
VISUAL: Sight lines to development, sight lines from development, concealment of developments in natural environment	POSITIVE— Views created by development. Views to be exploited. Focal points and panoramas. Approach to scale, height, density, mass, color, modulation. Texture of design and landscapes. Approach taken regarding appropriateness in the given ecological array.
SPECIAL FEATURES: Landmarks, unique quality biological and geological, representative quality, visual qualities	POSITIVE— Efforts to preserve fragile and unique areas.
SOUND: Animate: animals, bugs, insects, people. Inanimate: water, wind, rain, trees, lightning	POSITIVE— Exploit natural sounds for environmental character—birds and other animals, wind, water, rain, etc., create "atmosphere" of places.

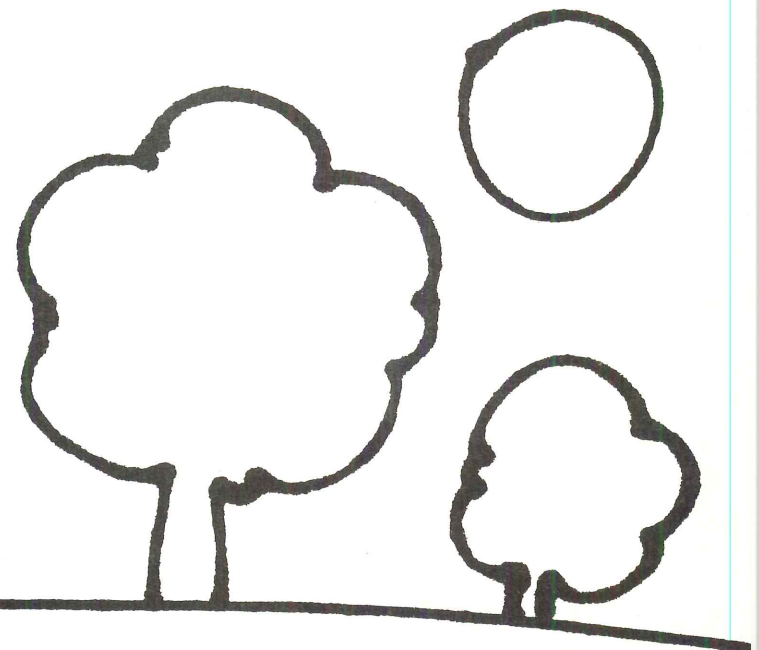

ECOLOGICAL AND ENVIRONMENTAL CHECKLIST

This Checklist may be clipped from the magazine.

A. Design Stage

1. IDENTIFYING RESOURCES AND CONDITIONS ON SITE.	Yes	No
a. Building over mineral or other resources.	___	___
b. Building over prime agricultural lands.	___	___
c. Loss of site for ecologically more appropriate uses.	___	___
d. Destruction of unique features.	___	___
e. Destruction of rare biotic environment.	___	___
f. Adverse impact or modification of visual quality.	___	___
g. Destruction of historic, archeological, or natural heritage.	___	___
h. Cause relocation of existing utilities.	___	___
i. Location and type of previous uses, structural remains, hazards.	___	___
j. Location of flood prone areas, fault zones, unstable slopes, etc.	___	___
k. Test boring and pits for:		
1) Soil analysis	___	___
2) Seepage, percolation tests	___	___
3) Watertable location and variation	___	___
4) Foundation stability	___	___
5) Depth of bedrock	___	___
6) Previous uses	___	___

B. Construction Stage

1. EXISTING VEGETATION	Yes	No
a. Remove and stabilize	___	___
b. Remove and replace with new	___	___
c. Remove and hard-surface	___	___
d. Protect and retain	___	___
2. EXISTING CONTOURS		
a. Remain as is	___	___
b. Modify:		
1) Diversion of natural water courses	___	___
2) Erosion potential	___	___
3) Downstream impact	___	___
4) Watershed impact	___	___
5) Visual impact	___	___
6) Maintenance problem	___	___
7) Other, depending on site conditions	___	___
3. BELOW GROUND DISTURBANCE		
a. Watertable modification	___	___
b. Subterranean	___	___
c. Settlement due to new fill	___	___
d. Other, depending on site conditions	___	___
4. EXISTING ECOSYSTEMS		
a. Displaced on-site	___	___
b. Modified	___	___
c. Eliminated	___	___
5. OFF-SITE DISTURBANCE		
a. Due to underground work	___	___
b. Due to surface work	___	___
c. Due to above surface structures	___	___
1) Visual	___	___
2) Solar	___	___
3) Wind	___	___

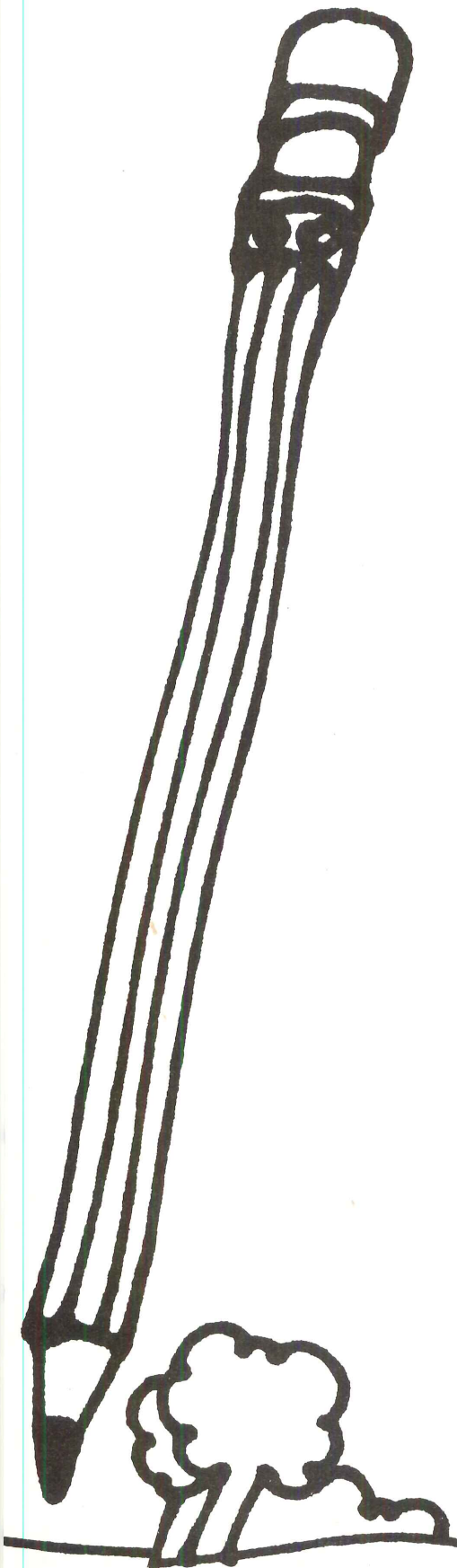

continued on page 48

B. Construction Stage

6. TEMPORARY IMPACTS	Yes	No
a. Due to blasting or dust	___	___
b. Due to defoliating or cutting	___	___
c. Due to vibration	___	___
d. Due to access routes	___	___
e. Due to surface water control	___	___
f. Due to runoff: mud, water	___	___
g. Due to waste disposal: burning, burying, stockpiling	___	___
h. Due to construction materials: waste, spillage, storage	___	___
i. Due to machinery: bulldozers, cranes, trucks.	___	___

C. Other Environmental Concerns

1. VISUAL AND PERCEIVED VALUE ON SITE	Yes	No
a. Improving surrounding environment	___	___
b. Reducing surrounding visual quality	___	___
c. Modifying natural or built surroundings	___	___
2. RESOURCE CONSUMPTION DURING PROCESS		
a. High level of non-renewable resources consumed.	___	___
b. Average level of non-renewable resources consumed.	___	___
c. Low level of non-renewable resources consumed.	___	___
d. High level of renewable resources consumed.	___	___
e. Average level of renewable resources consumed.	___	___
f. Low level of renewable resources consumed.	___	___
g. Energy-efficient construction processes used.	___	___
3. MODIFICATION OF EXISTING SITE FEATURES		
a. Diversion of streams and waterways.	___	___
b. Controlled discharge of existing waterways.	___	___
c. Unique or scenic features eliminated or modified.	___	___
d. Erosion and/or sedimentation potential.	___	___
e. Historic and/or archeological deformation.	___	___
f. Atmospheric modifications due to construction or later use.	___	___
e. EXISTING BUILDING IN USE.		
a. Shading of desirable exposure.	___	___
b. Wind pattern modification.	___	___
c. Watershed deterioration or alteration	___	___
d. Subterranean implications, stability and hydrology	___	___
e. Retreat of wildlife species	___	___
f. Pollution from on-site activities, air and water	___	___
g. Other modification: noise, dust, light, vehicles	___	___

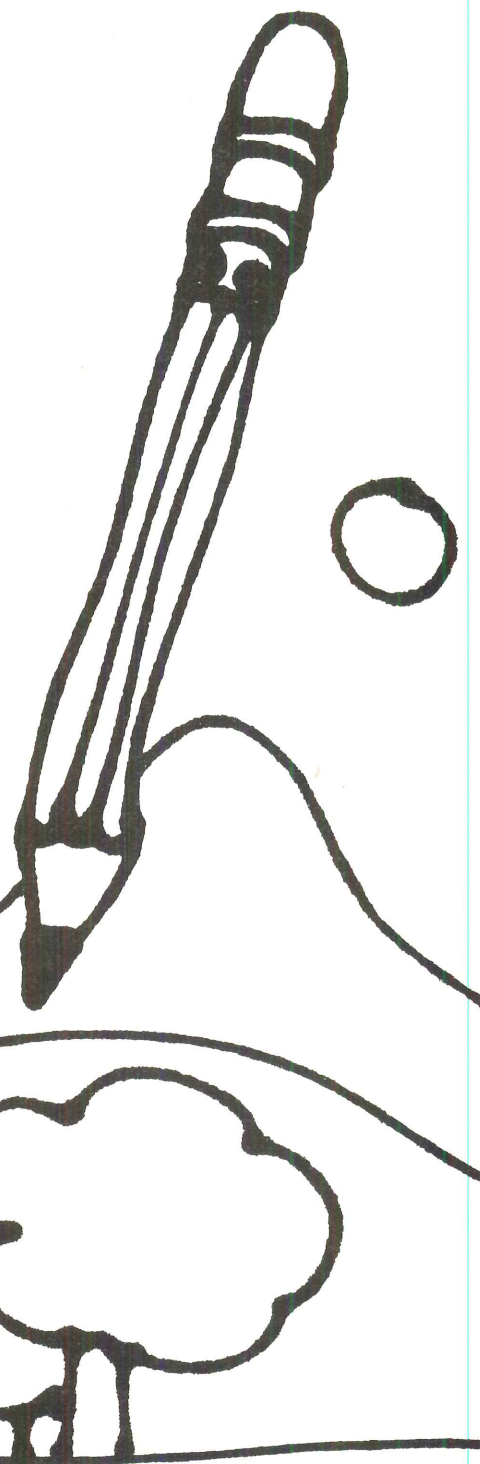

Don't Miss It...

A/E SYSTEMS '84

Bringing It All Together In Baltimore

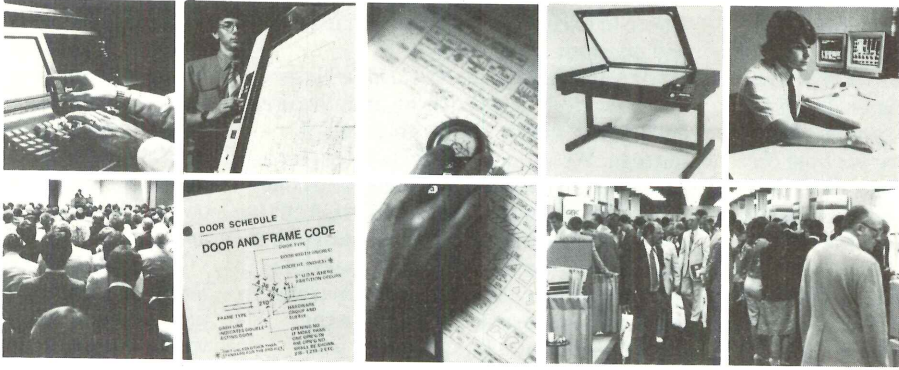

June 4-7, 1984 Baltimore Convention Center

A/E SYSTEMS '84 is the one annual event where architects, engineers, interior designers and facility managers can actually see and learn about computer graphics, mini- and microcomputers, reprographics and management systems. Everything to make the practice more effective—all in one place at one time. Here are the highlights:

- 19 three-hour tutorials on such topics as "Low-Cost CADD for Architects and Engineers" and "Advanced Small Computer Applications."
- 65 one-hour seminars on such topics as "Computerizing Your Office on a Shoestring Budget" and "Integrated Graphic Systems Management."
- Six concurrent conferences sponsored by the major professional societies.
- More than 50 publications and professional societies actively supporting the show.
- No business meetings or outside social events to distract the attendees.
- 200 exhibitors in 650 booths—larger than any other show for design professionals.
- More than 50 CADD vendors including all five with the highest share of the A/E market: Intergraph, Computer-*vision*, IBM, Auto-trol and Calma.
- All key reprographics vendors and every major computer hardware and software firm serving the design profession.
- Better than 12,000 attendees expected, up from 8,200 in Dallas last year.

All at the 5th International Conference on Automation and Reprographics in Professional Design Firms.

A/E SYSTEMS '84 Don't miss it! You won't be disappointed.

FOR MORE INFORMATION
Fill out the coupon at right and you will receive complete information on A/E SYSTEMS '84, including conference details, list of exhibitors, registration and housing forms. Check off the box and we will send you **complimentary** passes to attend the 650-booth exhibit (a \$20 value). Or call (203) 666-6097 for quicker service.

<input type="checkbox"/> Yes, send me information on A/E SYSTEMS '84
Name _____
Firm _____
Address _____
City _____ State _____ Zip _____
Phone _____
<input type="checkbox"/> Also send me _____ complimentary tickets to the 650-booth exhibit (a \$20 value).
Mail coupon to: A/E SYSTEMS '84 P. O. Box 11318, Newington, CT 06111

N

CADD ROUNDTABLE

FOURTEEN CADD EXPERTS SHARE INFORMATION

Fourteen experts from architectural firms, universities, and the computer industry gathered at the AIA in November 1983 to share their experiences with Computer-Aided Design and Drafting (CADD) systems. The following article presents excerpts from the roundtable transcript, available from the AIA Bookstore for \$12.36 prepaid (includes shipping and handling). Order #M649.



RANDALL VOSBECK, FAIA, VVCR Inc. (Alexandria, Va.): The purpose of this session is to make AIA more responsive to our profession with regard to CADD, to investigate the marketplace, and to

explore the perceived development of CADD systems throughout our profession. I think it would be desirable to begin with each member of the panel explaining what CADD system he has installed, how long he has owned it and why he selected it.

CHARLES ATWOOD, Hellmuth, Obata & Kassabaum, Inc. (HOK) (St. Louis): We hired a CADD design group about four years ago, but we made a decision about CADD and graphics only about two years ago. [Our system] covers a range of business graphics, facility programming, computer-aided drafting, etc. We have probably spent close to a million at this point, and we expect to spend another [million] just in this next year, expanding our capability out of St. Louis, and into our regional offices.

JOSEPH BROWN, AIA, Everett I. Brown Co. (Indianapolis): We've been in CADD a little over five years. We have Intergraph, Centertone and, recently, Arrigoni with 30 stations. About 25 of them have been operating for about four years on a three-shift basis. The capital investment is some-

where in excess of \$3 million in hardware and purchased software.

CHARLES DAVIS, AIA, Davis Associates (Chicago): Our firm is an architectural and interior design firm with a staff of thirteen. We've had a CADD system for a little over a year and have invested about \$250,000. We put off getting into CADD as long as possible [but] were looking for a way to increase the value of our services, to improve the responsiveness of our designs to client needs, and improve the accuracy of documents. Also, we were looking to open up some new services.

CHARLES EASTMAN, Formetek Industries (Pittsburgh): About a year ago I took a leave of absence from Carnegie Mellon University to found a company called Formetek Technologies [which sells software].

STEVE GATSCHE, AIA, Geddes Brechar Qualls Cunningham Architects (Philadelphia): We do not have CADD yet but are like thousands of other firms that have started to automate. Our structural engineering group uses a time-sharing system, but we have grave concerns about the potential risks of CADD.

DONALD GREENBERG, Cornell University, (Ithaca): We are not looking to obtain a CADD system; we try to teach computer-aided design within the engineering college.

DAVID JORDANI, AIA, Ellerbe Associates, Inc. (Bloomington): We've been involved in CADD for about three years. We have an Auto-trol system and we do a lot of work on an IBM main-frame—almost all of our design analysis, specifications. We have invested somewhere under \$2 million just in the hardware, [and probably] a million a year supporting the people to maintain and develop those systems. We think CADD is very important to the future; it's the way the profession is going to move.

DAVID MACDONALD, AIA, Gibbs & Hill, Inc. (New York): We've been involved in CADD for 10 years and have designed our own system using an IBM 3033 mainframe in our New York headquarters. Our capital investment was in the millions. We have done very, very large jobs completely on CADD. I think the days of draftsmen are over.

WILLIAM MITCHELL, University of Southern California (Los Angeles): In addition to my work at UCLA, I'm involved with a computer-aided design group that plans the process of selecting equipment and organizes firms for integrating CADD into their activity.

GERALD PFEFFER, AIA, The CRS Group, Inc. (Houston): We brought in a turnkey CADD system in 1977 and now have 56 work stations, most by Intergraph. In addition, we have about 300 work stations attached to different mini-computer systems in our 27 offices. We spend millions each year to support and advance the technology. I believe that, even if our clients were not demanding CADD at every turn, we would still be doing it, because it's the only investment we know of that can simultaneously help us improve both the quality of the work and the productivity of our people.

DOUGLAS STOKER, AIA, Skidmore, Owings & Merrill (Chicago): [With us] CADD began as a graphics entity in 1976, [although] we have been using computers in-house for 21 years and have spent more than a million, less than a billion. We have 14 VAXs and about 70 work stations. It's one of the tools we use in the trade that we're in.

ERIC TEICHOLZ, Graphic Systems, Inc. (Cambridge): My firm has two CADD systems with two more arriving. I'm usually paid to either write software or evaluate it.

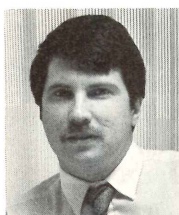

Atwood



Brown



Davis

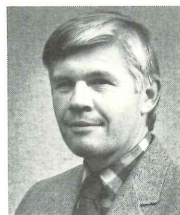

Eastman



Gatschet



Greenberg

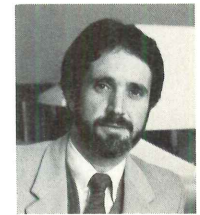

Jordani



MacDonald



Mitchell



Pfeffer



Stoker



Teicholz

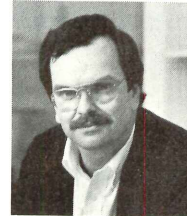

Thompson

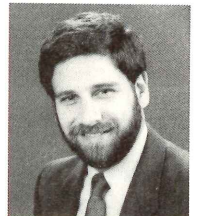

Wolfberg

DAVID THOMPSON, AIA, *RTKL Associates, Inc. (Baltimore)*: In 1977 we brought in our first computer for civil and structural [work] and began developing an in-house CADD system on that. A year ago we brought in an Intergraph CADD system with five stations running out of VAX. In addition, we have a Dynamic 3-D display processor. Investment is in excess of a million. The purpose of getting into CADD was to increase productivity and give better service to our clients.

DAVID WOLFBERG, AIA, *Wolfberg/Alvarea/Taracido & Associates (Miami)*: We have been in CADD for about four years. We have both Auto-Trol and Intergraph and have developed an interface between them. The capital investment is probably in excess of a million dollars. We have 14 stations in two offices. From the standpoint of business and growth, CADD is perhaps the finest marketing tool that an architectural firm will ever find.

VOSBECK: How is a CADD system used in the office, how much for design,

how much for production work?

PFEFFER: We are an integrated firm, so I think the answer is 10 percent in architecture, 25-30 percent in engineering and as much as 50 percent in interior architecture. Of the interior work, 50 percent of that is in the design category.

DAVIS: Every drawing we make is on the CADD system. The person making designs is the person who must use the system to record those decisions. If we're doing an office building, one of the first things we'll look at is various structural systems and the impact on the design. It's very easy to make that kind of drawing with CADD.

VOSBECK: Are we headed towards more design decision-making with CADD?

STOKER: I think definitely it's the efficient way of using a tool.

JORDANI: We think the machine can definitely handle the quantitative design process.

EASTMAN: Generating design alterna-

tives is something that computers have been very poor at. It's a little better at giving feedback on a design that you generate.

TEICHOLZ: The integration of the traditional CADD vendors of 2-D and 3-D data bases is fairly awkward right now. There are no good 3-D systems that can handle anything near the complexity of architectural buildings. Until the next generation of data bases, I don't think there are going to be any 3-D design tools on the market that are useful to an architect.

VOSBECK: What led you into CADD? How is it managed?

ATWOOD: The initiative at HOK came right from the Office of the Chairman. We did a lot of planning and re-evaluation, making a five-year forecast of costs.

JORDANI: We started out with a CADD group responsible for development of the system and production of the documents. Then we realized that we had implemented a drafting pool in a firm that never had one. Now the CADD group develops systems

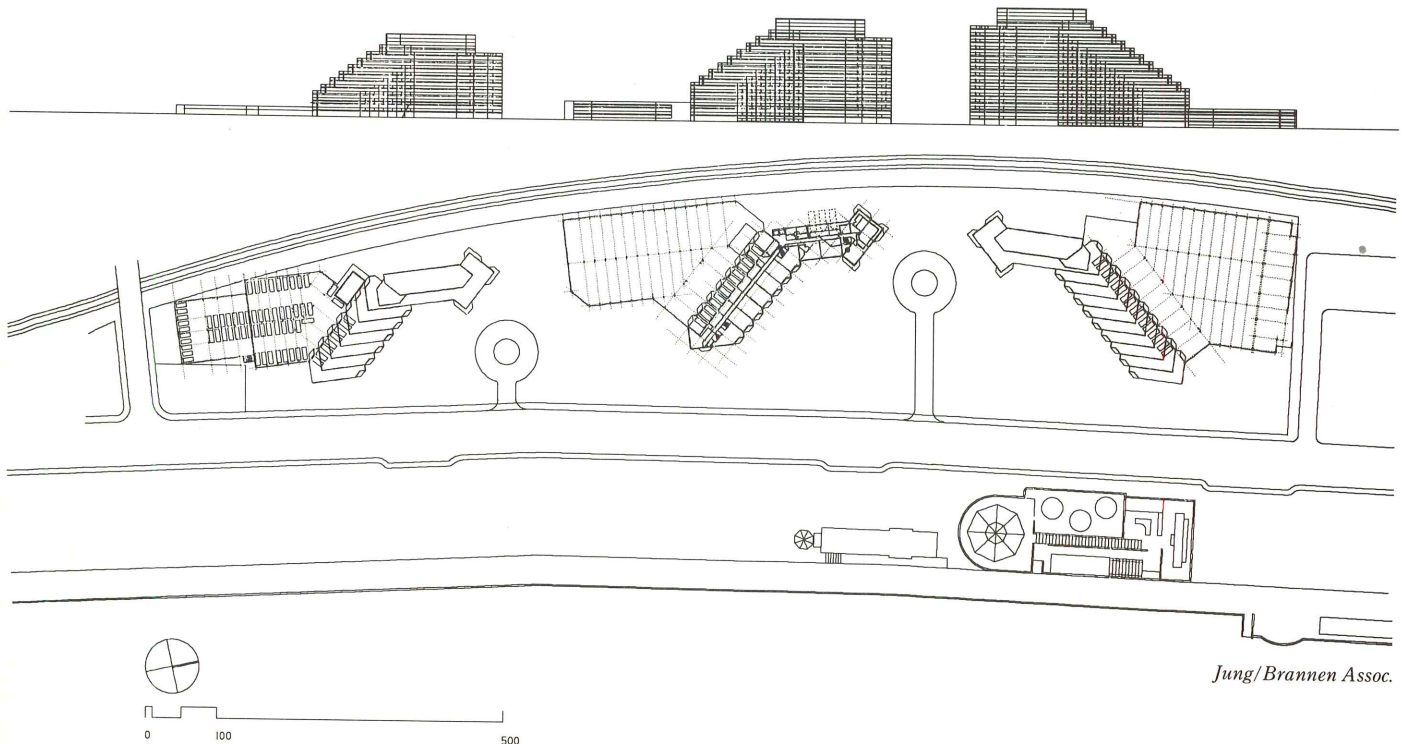

Jung/Brannen Assoc.

Brown: "look at the used market . . . you know the equipment works."

and provides consulting resources for each project. But the people who actually use the computer to do the design work are resident in the department.

PFEFFER: We have hardware and software supported by a central group, but the operators are decentralized.

DAVIS: In our firm the people who write programs for CADD are architects who also work on projects. We don't have a specialized group doing computer work.

VOSBECK: How is a project charged for computer time?

STOKER: Graphics are charged by a "wall clock basis" per hour. For engineering and other kinds of runs, it's an internal mechanism that the computer itself figures out.

BROWN: When we're negotiating a fee, most of our clients are very receptive to paying a separate price for the computer work station. Two clients, in fact, are putting remote stations in their offices to reduce the number of meetings.

DAVIS: If we can get the clients to pay for it, we charge the project the cost of the CADD which basically is marked up like staff time, so the direct cost of the CADD goes to the project and the effectiveness of the system rests with the project.

VOSBECK: What about single vs. double shifts?

JORDANI: We're trying to run a single-shift operation. We'd like to run two, but we don't see design professionals wanting to work two shifts.

THOMPSON: We found to get the kind of payback we want we have to change to shifts. Our last shift in the evening consists of draftsmen from engineering studios. The first two shifts are engineering designers and architects. We didn't justify the cost of the system on running shifts, but found that because we had only five work stations we needed multiple shifts.

BROWN: We have run three shifts 24 hours a day, many times seven days a week, for about four years now. The day shift has our best quality people on the graphic system. The late night and early morning shifts are strictly draftsmen. The evening shift is in between. CADD on a three-shift operation is very, very cost effective for us.

VOSBECK: How are decisions made as to which projects go on CADD?

THOMPSON: We have 18 principals and five work stations, so we can't have all projects on CADD. We put each principal

in turn in charge of production. To determine which projects go on CADD, we consider how many phases of the job we can do, if we're only doing design development and not CD's, if we're in a joint venture. If we don't have all disciplines on the system, it's a check against that project going on. But if it's not a highly repetitive job—a hospital, hotel—then it's definitely on the system.

STOKER: It depends on the client. If we've got a client turning projects on and off, it just kills us to have terminals tied up.

VOSBECK: What is involved in training people to use CADD?

BROWN: When we got into the design business, we sent four people for training. Since then we have trained 60 or 70 people internally. The training is strictly related to the type of work the person is going to do.

PFEFFER: We do training in-house, but we keep going back to vendors for advanced applications.

MACDONALD: To train an operator takes from three to six months. The best operators are usually architectural graduates or interior design graduates with five or six years of experience. I usually put a seasoned designer with an operator and let them work together.

JORDANI: Our cost of training runs \$3,000 plus, but that doesn't include the time a person is pulled out of production and not generating revenue.

THOMPSON: The month before a project goes on the system, we give a project manager, project architect and project engineer training in how the system is set up, the standards being used, how to find their drawings. If they want to review their work, they can call up their drawings and not bother the person working on the system. And we take the firm principals through the same training so they know what the system is capable of and won't oversell or undersell our capabilities.

VOSBECK: Are computer vendors being responsive to the architectural marketplace?

TEICHOLZ: CADD traditionally has been for the large firm with expenditures in millions of dollars, full work stations that cost \$40,000 to \$600,000. Now there are something like 75 vendors that sell CADD systems for under \$100,000 that are complete. My perception of the market is that architects for the first time are actually purchasing rather than looking at systems.

EASTMAN: Work stations in the \$20,000-\$30,000 price range are available today. But that doesn't include software.

WOLFBERG: I still think the market is very confused. I still am not convinced that a profession that shows an average of less than 10 percent profit on gross fees can afford to spend even \$50,000 per terminal. We have to develop terminals that are less expensive, that maybe have less flash and dazzle, and that do the daily things that architects and engineers have to do.

VOSBECK: What advice can you give any group in the selection process?

WOLFBERG: I think you really have to look at what the limitations of the system are. The only thing you can do is get into it and be ahead of the game.

STOKER: Don't waste a lot of time with this.

PFEFFER: If you achieve a two-to-one productivity rate, it's a break-even situation.

WOLFBERG: A number of smaller firms might [form a] joint venture.

BROWN: My advice is look at the used market. It's a market where you know the equipment works.

WOLFBERG: I really feel that a firm is better off going in with a used system with eight stations than a state-of-the-art system with two stations.

STOKER: You're better off buying more terminals with less money than the ultimate system that does everything in 25,000 colors.

MITCHELL: You can build up a system in \$50,000 to \$60,000 increments rather than investing several hundred thousand dollars to get started and then add work stations.

TEICHOLZ: I have a client who spent three years deliberating whether to get a CADD system. After buying the system, within two weeks they got a corporate "top 500" client that they never would have gotten without it.

EASTMAN: One thing a computer provides is an opportunity to capture new segments of design services. [A colleague] is using computers, not for design and drafting, but for energy analysis, and has won numerous awards in that field. One of the important benefits of CADD is not the technical details but the organization of management. I think we're going to see a very wide variation and I don't think there's any one answer. □

CADD ENABLES FIRM TO FAST-TRACK DESIGN FOR TIGHT SITE

Working with the dual constraints of time and site, Jung/Brannen Assoc. (Boston) used its CADD system to quickly produce schematic designs for a housing development competition in Revere, Mass.

Rose Associates, a developer, commissioned Jung/Brannen less than two weeks before the submission deadline for the two-staged competition. Basic parameters were decided early — the number of units, average unit size, cost and rent per square foot, etc.

The established programmatic requirements, guidelines and restrictions resulting from an earlier Environmental Impact Statement were the dominant determinants of form.

Because the spaghetti-shaped nine-acre site was narrow, the designers could not pencil-sketch the design and be confident it would fit the site.

"That's where the computer was indispensable," recalls E. Crawley Cooper, director of computer operations/application. "We were working within two-inch tolerances! It was a real

shoehorn job. We really couldn't have designed a workable scheme on that site without the computer."

On the basis of the first submittal, Jung/Brannen and Rose Associates made the short list of two and were then asked for a second submittal. In two weeks, the project was completely redesigned to respond to jury comments emphasizing the need for stronger cascading forms. According to Cooper, the computer enabled fast production of quality presentation drawings from conceptual sketches without intermediate drawing stages. The CADD produced the drawings about three times faster than would have otherwise been possible.

During both stages of the competition the design team used the computer to manipulate project massing. The building was analyzed in three dimensions, and modified without building a study model.

The Oceanfront Development project will move ahead when final financing is arranged. □

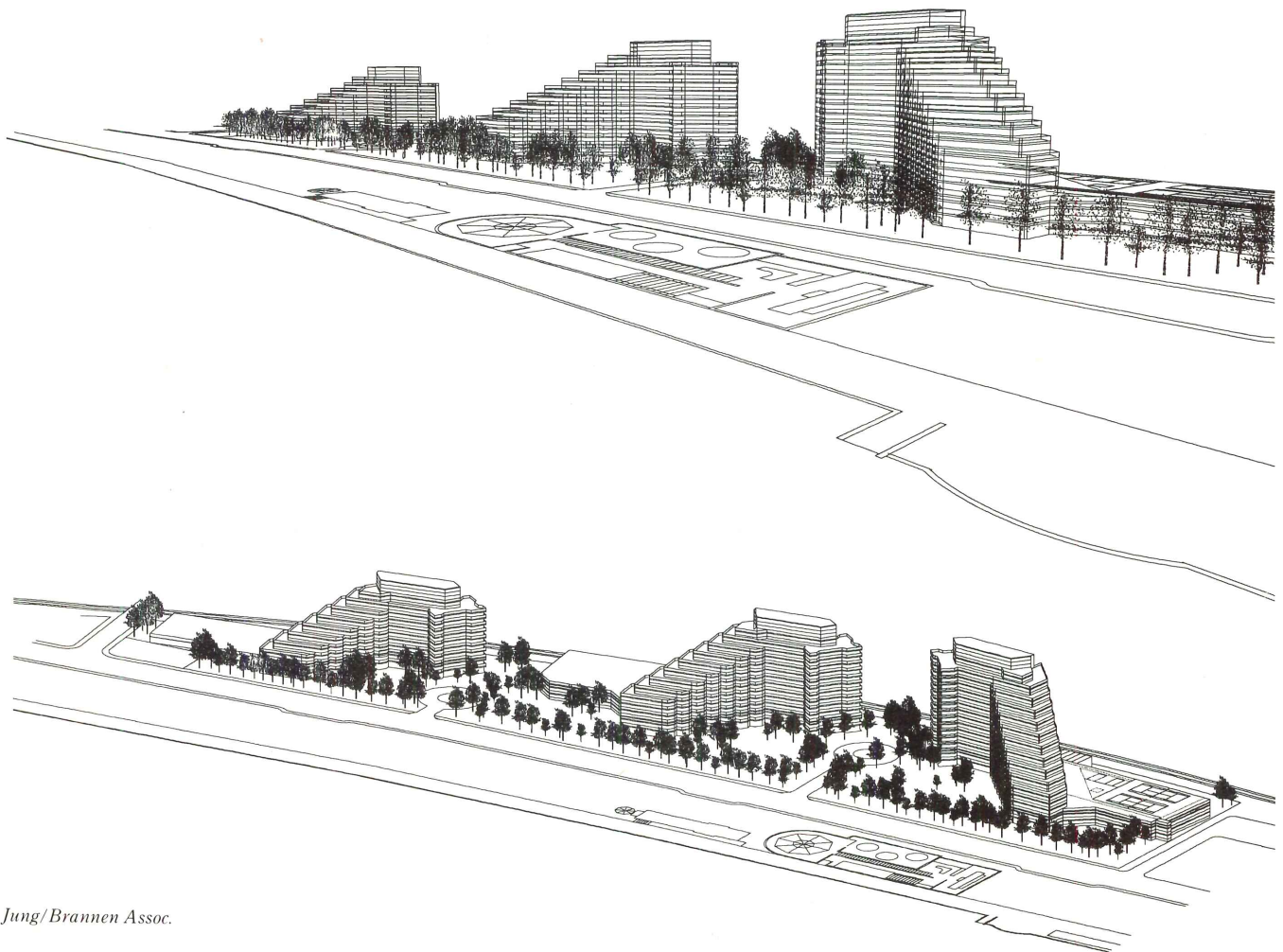

Jung/Brannen Assoc.

STAYING SMALL SUCCESSFULLY

YOU HAVE TO SELL YOURSELF

Small firms do not win big contracts easily, frequently experience cash flow problems, and require principals to work long hours, take short vacations, and deal with administrative matters when they'd rather be designing. Despite the drawbacks, many successful architects are willing to forego impressive titles, larger salaries, and plush offices to run their own show. The chance to be independent and to produce quality work motivates them to start small, stay small, or switch to small.

But staying small successfully takes a lot more than design skill. It takes business acumen. The AIA Practice Management Committee asked principals of 20 small firms to share their secrets at a one-and-a-half-day meeting at the Institute in June of 1983. The secret of success, more often than not, was good marketing.

SMALL FIRMS WITH MARKETING SOPHISTICATION DO NOT HAVE to lose the plum jobs to large competitors. In the last two years T. Girard Lee, of Bagley Soule Lee (Chevy Chase, Md.), a five-person firm, has successfully completed two projects worth more than \$20 million each—a luxury condominium and a 14-story office building. He attributes the firm's success to its team of top-level talent that can push a large project through. But he says the trick is convincing the client that the small firm does have sufficiently diversified resources. If a mid-level corporate executive has the responsibility of selecting the architect, he'll often opt for the big-name firm as a safe choice. However if a small firm architect is able to deal directly with a corporate CEO, he can often win the job, Lee maintains.

SELL YOURSELF

A small firm principal can impress a CEO by emphasizing that he or she will actually execute the project, Thomas Ashley (Ashley Humphries & Partners, McAllen Tex.) pointed out.

"You are selling your personality; you are selling your design idea; you are selling yourself," said Do H. Chung (Yankee Planning, Stamford, Conn.).

DEFINE MARKETING NICHE

To develop a marketing strategy a firm must have a clear idea of what it wants to design and for whom. A generalist must sell to a wide variety of client types, usually within a specific geographic area. But a firm that specializes in one or two building types—schools, hospitals, office buildings, retail outlets—has a more narrowly defined market niche, and possibly a wider geographic market area.

Kenneth Kornberg (Kornberg Associates, Del Mar, Calif.) has concentrated on the design of laboratories for institutional, corporate, and government clients. As a result, his projects "have been selling themselves. All my marketing has been specifically word-of-mouth from one project to the next."

Similarly, several years ago John Jelliffe, (Pecok Jelliffe & Randall, Indianapolis, Ind.) selected three diverse markets that "looked like comers:—libraries, jails and churches." One principal

at the firm does marketing, seminar speaking, and other activities to build the firm's reputation. "You have to pick your market," he advised, "and then become an expert in those markets so you can sell yourself."

Another tactic is to focus marketing efforts on a limited number of clients who are likely to generate a high volume of new projects.

"Instead of going after the general market—sending brochures and newsletters—I'd rather go after some developers," said Do Chung. He started doing business with a developer six years ago who has generated more than \$300 million in work, with prospects for another 15 years of steady commissions ahead. He believes that concentrating on "one or two clients and giving them a good deal" is a better strategy than "chasing all over."

Most small firms that service a general clientele in one metropolitan area or region have to fight a tendency to "chase all over." Marketing this kind of practice requires planning and organization.

In most architecture firms, large or small, one principal plays the key role in developing new business and closing deals. It is his or her job to make the outside contacts and go after jobs that need the talents of his associates.

In small firms, leaving all the marketing to one person—who usually wants to do some design work, too—can be asking too much. A number of attendees commented that meetings with clients are often handled by two principals, the top partner and the one who will be in charge of the project.

CONSIDER A MARKETING SPECIALIST

Another solution is to hire a marketing specialist to perform routine selling tasks. For example, William Howell of William Howell & Associates, a 10-person firm in Atlanta, recently hired a full-time marketing vice-president who is an architect. The advantage to Howell is that it frees him as a principal to do other things.

"As soon as the marketing man has made the right contact, he takes me along with him to make a dual presentation. Then I back away from the project so he can follow through."

This marketing professional was hired from a large architecture firm when Howell was trying to diversify out of a narrowly specialized area; the new vice-president's experience in a wide variety of fields is expected to aid this effort.

Irwin & Associates of Huntington Beach, Calif., retains an outside marketing firm with experience working with architectural, engineering, and contracting firms. The consultants receive three percent of the architecture firm's commission; as this three percent fee is drawn against a \$1,000 monthly minimum (or \$12,000 a year), the consultant is not paid until the architects receive their commission.

A marketing specialist is most useful for an architecture firm that is required to make many "cold calls" and follow up numerous leads to generate the desired level of business. Most architects agree that the firm's principal must be involved in formal presen-

*"You are selling your personality;
you are selling your
design idea; you are
selling yourself."*

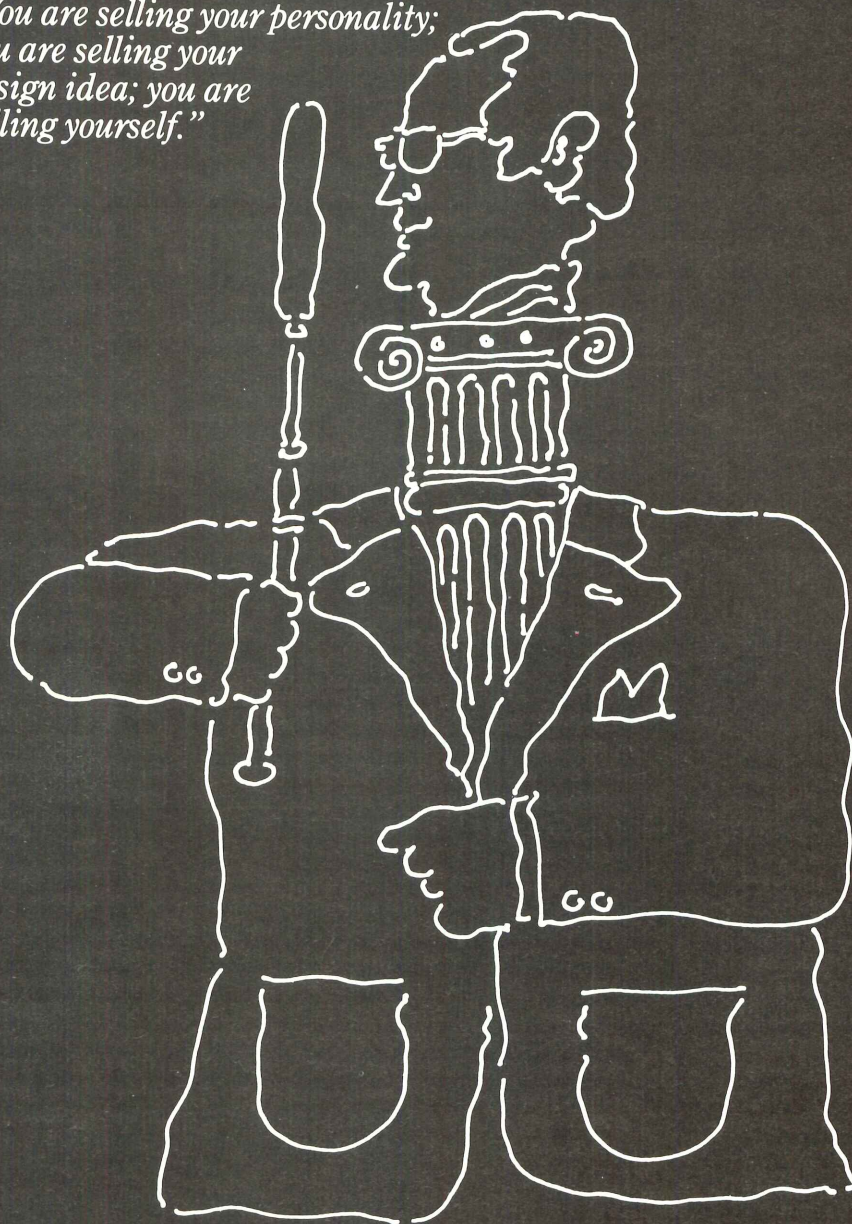

tations and deal closings. But the "bird dog" work can often be handled by a marketer, allowing a practicing architect time to manage the business or follow through and complete design work.

The marketing vice president for Robert Haig Associates (East Providence, R.I.) had obtained two jobs from his cold-call efforts within a few months of the time he was hired.

"He 'just happened' to walk in when some developers were working on the conversion of a store in a shopping mall and were just then thinking about architects. They contacted us and like us," Haig said.

BROKERS, SURVEYORS GOOD SOURCES FOR LEADS

"Just walking in" at the right time requires more than luck. It results from making contact with many individuals and organiza-

tions that can steer the firm to potential clients.

Real estate brokers generate good leads for Do Chung. "The brokers know what's going on, which sales of land are made, which transactions are happening and who is looking for what," Chung said.

"The first part of any project involves the property," said William Gallo of Architects Chartered, Atlantic City, N.J. "I've gotten some great leads through some of the surveyors."

Lawyers and accountants can provide leads, particularly in small cities where the lawyer who handles the architect's affairs may also be involved in real estate activities.

Engineering consultants can augment an architecture firm's marketing power. Because Gallo's firm is located in coastal New Jersey where environmental issues play an important part in

Image-building is important

building design and construction, he finds it works best to team up with a civil engineer who is called in at the beginning to determine project feasibility. This has worked so successfully that Gallo is now considering hiring a staff civil engineer.

JOINT VENTURES

An architect can joint venture with other professionals to expand his marketable services beyond building design to building management and operation.

The senior principal at Norman J. Davies Architect in Binghamton, N. Y., a firm that specializes in retirement housing, has joined with a geriatric consultant and a CPA to form a consulting firm that manages retirement homes and nursing facilities on a national basis. This exposure has led to contracts for design of new facilities.

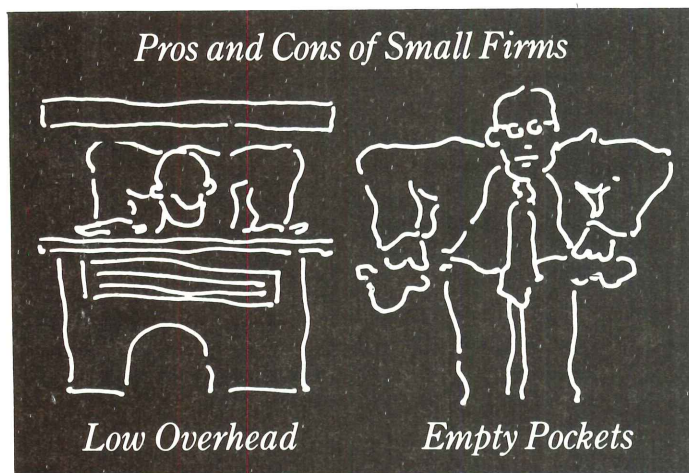

BROCHURE BOOSTS CREDIBILITY

Whether dropping in on the local broker or presenting a proposal to the chairman of the board, an architecture firm needs to project the image of an experienced, reputable business that can manage construction projects. Firm brochures make important first impressions.

"I have found that in quite a few interviews people have seen things in the brochure that they really liked. And they keyed in on that. For a small firm like mine to compete against large firms, I have found that a very slick brochure is important," said Victor H. Wilburn (Victor Wilburn Assoc., Washington, D.C.).

While a specialized firm may be able to use one brochure for all clients, generalists often find that an "assemblage" is more useful.

James Franklin (Franklin Design Group, Chattanooga, Tenn.) has a brochure system consisting of different colored sheets of paper and a computer that "blips out" project descriptions to customize the brochure for that project.

Norman Davies has his brochure material on separate sheets. "If I'm going after a church job," he says, "churches is all I put in

the brochure. I'll let the word processor pump out information on specific projects, and I'll end up with a fairly slick-looking brochure." His product pertains to the needs of the particular client with the project proposal bound in.

Kornberg also has an assemblage system that produces a brochure "specifically aimed at serving the needs of the person reviewing the project" and not "a designer-kind of pretty picture beauty contest." He has found that selection committees want to see data and information related to the project at hand. For a laboratory project, the committee will be more impressed with a picture of a laboratory, he believes, than one of a large hospital that has a laboratory in it. He also includes pictures of specific details in the lab that are likely to catch the client's eye.

Haig finds his assemblage materials can also double as promotional mail pieces. He prints 5,000 brochure covers at one time; 2,000 are used as covers for assemblages and 3,000 are folded in half for mailings.

While an attractive brochure or mailing piece can enhance the image of a firm and help develop business, it does not make an entire marketing program. The brochure serves primarily to help a firm get short-listed, Alan Turley (Horlbeck/Hickman/Schafer & Turley Ltd., Mesa, Ariz.) pointed out.

"If you don't have a brochure, you're suspect immediately as a small firm, and you're not going to get short-listed," Kornberg agreed.

A firm needs to present an attractive brochure to get to first base, but the brochure won't make the home run by itself.

MORE THAN STRAIGHT SELLING

A full marketing program involves more than cold calls and brochures; it requires the development of a positive image for the firm in the community-at-large as well as in professional circles.

One of the best marketing tools, pointed out John Thomson of Irwin & Associates, "is just letting people know that architects exist."

Architects in his area (Huntington Beach, Calif.) are losing business to civil engineers and to builders. To combat this trend, architects have made an effort to speak publicly about quality structures and quality design and the services provided by architects that go into such projects.

Public advocacy work is also a good way for an architecture firm to gain recognition. One firm became involved in a local effort to replace an asphalt recycling plant with a research park, an activity that boosted its standing in the community. Another participated in a program assisting local university students in an urban study project. This developed into contact with a wealthy local foundation.

Civic work is not only worthwhile for its own sake but it also improves the image of the profession and generates jobs. Haig, for example, specializes in educational facilities and has a civic re-roofing service as an offshoot. "Getting in to talk about the leaks," he said, "always brings me a school job."

Participation in association activities can also aid a firm's marketing program. For example, Bruce Dilg (Arcom, Lander, Wyo.) reports that the Wyoming chapter is establishing a member-firm referral service. Using a computer, the group will keep a tally of the building specialties of member firms. This will enable the group to supply lists of architectural firms meeting desired qualifications to firms considering a development project.

Pros and Cons of Small Firms

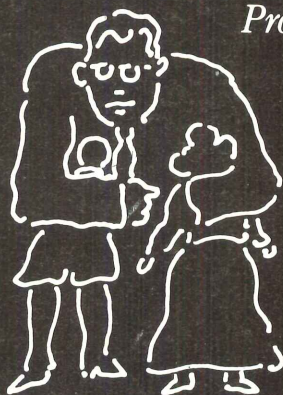

Firm is Family



Tough to Fire Family



You're in Control



You Catch the Blame

SMALL FIRMS SPEND MORE

Marketing requires hard work, time, and money. Hiring an in-house marketing specialist requires an outlay of a minimum of \$17,000 in salary, plus benefits. Engaging a part-time outside rep may run over \$12,000 a year.

While the average architecture firm pays about seven per cent gross for marketing, many architects believe recent financial reports by management consultant Howard Birnberg (Birnberg & Associates, Chicago) that the small firm must spend 8 to 10 per cent of gross to accomplish the same task.

"A small firm has to spend more to be seen in the marketplace," commented James Franklin, facilitator for the session. "If you are small," added James Lynch (James Lynch & Associates, Pendleton, Ore.) "you've just got a smaller tribe to amortize things over."

Any measure of marketing costs, of course, only covers visible expenses such as salaries, mailing, printing and promotional activities. The real cost includes the valuable time the architect devotes to building his or her firm's visibility and reputation.

"Whatever I do is marketing," said William Rump (William H. Rump Architect Inc., Springfield, Ohio), a sole proprietor. At club, church, or association board meetings, "I am always projecting myself, trying to create a favorable image for the profession and myself."

"Marketing," said George Amick (Amick Harrison Architects & Planners, San Francisco) "is the most important thing you can do for your firm."

"You don't need to worry about administration, design, or production," Norman Davies echoed, "if you don't have your market share, you don't need the others." □

**REGIONAL SMALL FIRM
ROUNDTABLES SCHEDULED
FOR JUNE**

Three regional Small Firm Roundtables are scheduled for June 16-22 in Washington, D.C., Kansas City and San Francisco.

Follow-ups to the Staying Small Successfully roundtable held in Washington in 1983, the programs will allow members to exchange information on marketing and practice subjects.

James Franklin of Franklin Design Group, Chattanooga, and Steven Wintner of Gensler and Assoc., San Francisco, will act as facilitators at the meetings.

Practitioners who have fewer than 12 staff members, have been in business more than five years, and have a diversified practice are eligible to attend. (The intent is to bring together practitioners who are small by choice.) Interested firms should submit a brief outline of the firm to William Hooper at AIA Headquarters (202-626-7532).

OWNERSHIP TRANSITION

AGREEING ON PRICE, FINANCING THE DEAL, AND MAKING IT LEGAL

CONTRIBUTORS:
DOUGLAS BEVIS, AIA
WELD COXE, HON. AIA
THOMAS EYERMAN, FAIA
PAUL LURIE, ESQ.
MARC ROTH, ESQ.

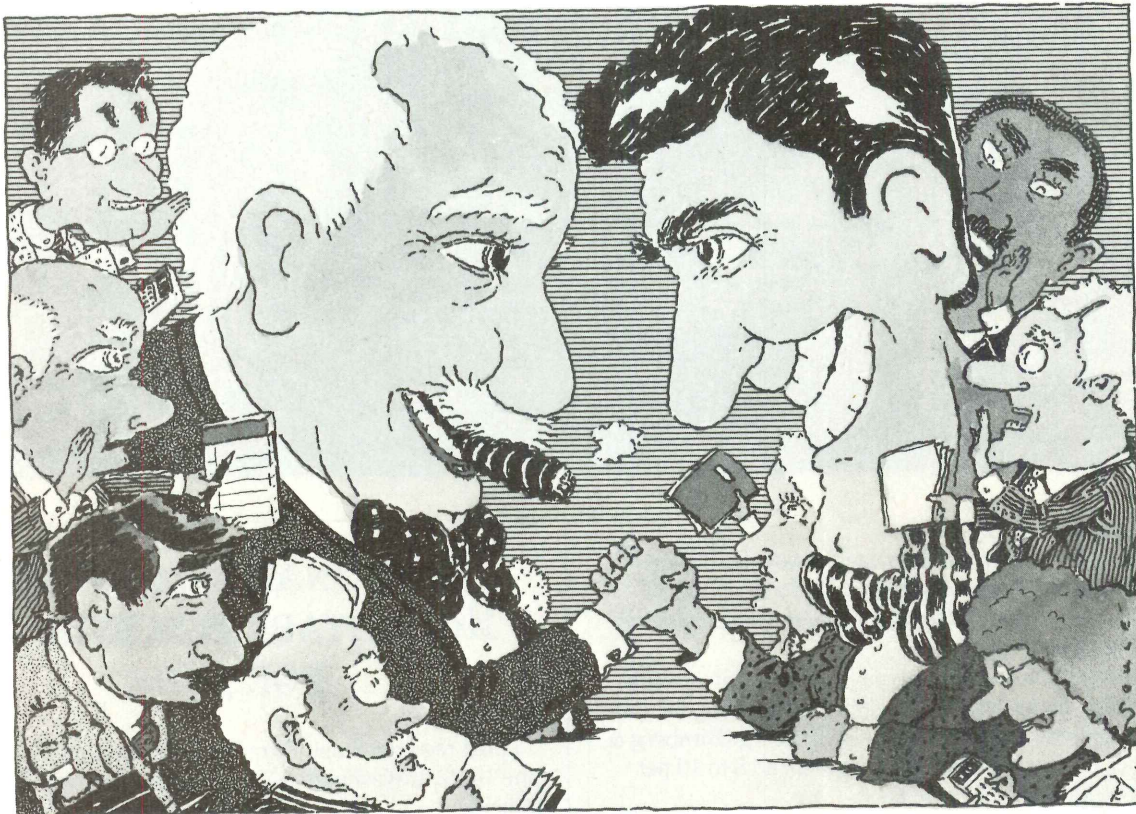

Robert Alan Soule

This is the second of two articles on Ownership Transition drawn from an AIA roundtable held last year. The first article, which appeared in the Fall 1983 issue, covered planning for the management transition, approaches to negotiation, and implementation of the management transfer plan. This article discusses firm valuation, legal, financing, and tax considerations.

Both articles have been reprinted under one cover by AIA Press, and are available from the AIA Bookstore. Send \$5 plus 30 cents for shipping and handling for #M648. Discount available for bulk orders.

AGREERING ON PRICE IS ALMOST ALWAYS THE TOUGHEST part of business negotiations. Fair valuation is an especially slippery concept when it concerns something as intangible as an architectural practice. Each firm is unique, and, unless stock in the firm is publicly traded, there is generally no basis for price

comparison.

The old adage that "Every thing is worth what the purchaser will pay for it" is the operating principle in firm valuation, but it is always difficult for owners and internal buyers to see things that way, because the firm itself will in the end finance much of the price.

Several things can be done to make the climate surrounding valuation discussions more amenable to quick and workable agreements.

- **Establish goals and objectives:** The buyers and the sellers should clarify what they each are trying to get out of the negotiations (the goals), and why (the objectives). Goal clarification, covered in more detail in the previous article, can help the parties resolve, or at least be aware of, underlying conflicts before they begin negotiations.

For example, an owner interested primarily in assuring the continued existence and health of the firm will have different criteria

for economic valuation than one who is willing to admit his or her primary goal is maximum profit from sale. The former may agree that the price will be what people who are well qualified to run the firm will agree to pay; the latter would probably define the price as the best offer, period.

- **Select the team:** The lawyers, accountants, management consultants, bankers, insurance advisors, and personnel consultants working on ownership transition arrangements must be selected carefully for their ability to clearly understand the goals and objectives and the criteria upon which the economic valuation will be based.

- **Plan the strategy:** A plan for the valuation based on the goals and objectives should be developed. The plan will identify the method of valuation chosen and the other factors that will be considered in establishing a fair price.

WHY VALUATION IS SO DIFFICULT

Firms that are not publicly traded are difficult to appraise for many reasons:

- The true earnings of many firms are difficult to establish because earnings are distributed principally through compensation and fringe benefits. This makes analysis of income streams difficult.
- Historical data such as annual income flows can be distorted by unusual market circumstances.
- Many firms may not have the liquid assets available to justify values established by analyzing assets and liabilities based on the accrual method of accounting.
- The founding owners often have an emotional commitment to the firm that inflates their estimates of the value of their interests. If they sell to employees, their authority in the firm can allow them to impose their views.
- Transient factors such as a firm's reputation and good will are often considered in valuation.

THREE METHODS OF FIRM VALUATION

Following are three methods, two based on future worth and one on current worth, that will establish some bench marks for valuation of a firm.

Method 1: Earnings Capitalization

The Earnings Capitalization or Earnings Ratio method of valuation is based on projections for the future worth of the firm. The average annual earnings for the most recent three-to-five-year

period are calculated and multiplied by a reasonable price/earnings ratio.

The annual earnings of a professional service firm should be readily accessible from the firm's accounting statements. The earnings are the income (after partner or principal salaries) generated by the firm, plus any compensation to principals in excess of their reasonable salaries.

The price/earnings ratio, on the other hand, can be very subjective. It is an estimate of the rate of return on investment in the firm. The price/earnings ("PE") ratio would be higher for a stable firm than for one with volatile results, and is almost never used for smaller firms. Where firms are listed on a stock exchange, one can see how investors evaluate the firm's P/E ratio.

Method 2: Discounted Net Cash Flow

This method is also based on the future worth of the firm and depends on three assumptions:

- Cash today is worth more than cash one will receive in the future.
- Future cash flows are reasonably predictable.
- The cost of capital and alternative returns on invested capital are similar. In other words, if one can receive 10 percent on invested capital, one must assume the discount rate will be 10 percent.

For a professional services firm to have a reasonably predictable future cash flow is an accomplishment in itself. Some firms with stable work loads are able to project net cash flows for several years. (Net cash flow = incoming cash - outgoing cash)

$$\text{Discounted Cash Flow Value} = \frac{\text{Total Future Net Cash Flows/year}}{\text{Discount Rate/year}}$$

Combining Methods 1 and 2

It is obvious that one can combine the discounted cash flow and capitalized earnings methods of evaluation.

$$\text{Capitalized Earnings} = \frac{\text{Average Earnings (actual or projected)}}{\text{Rate of Capitalization}}$$

Average earnings may be the actual annual earnings over the last three to five years, or it could be the estimated average annual earnings projected by the firm for the next three to five years.

The rate of capitalization is 100 divided by the price/earnings ratio. Thus, a price/earnings ratio of four would also be a capitalization rate of 25 percent.

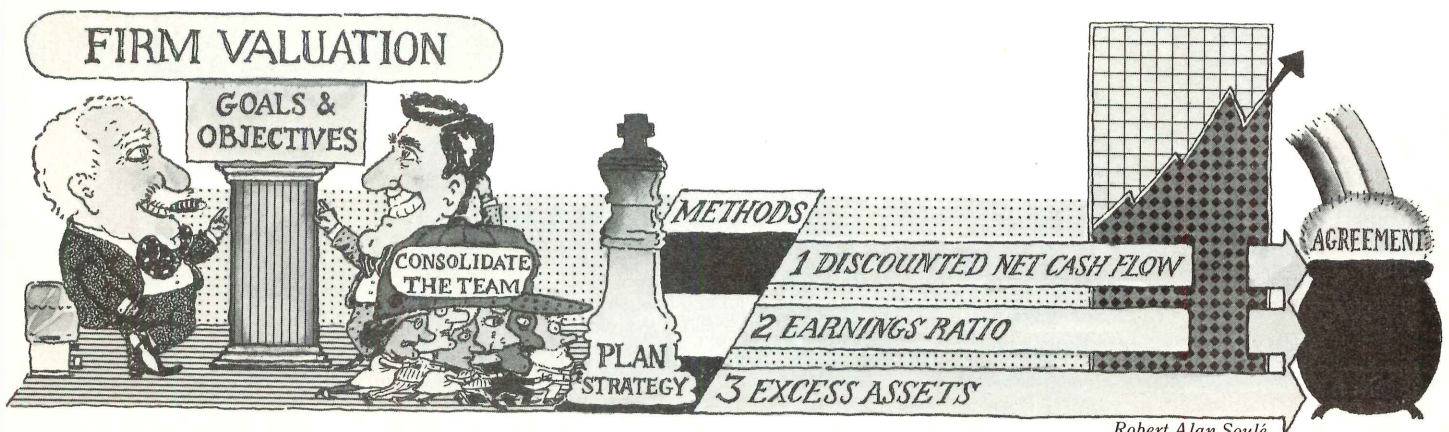

Robert Alan Soule

Value is in the eye of the buyer

Method 3: Excess Assets

The least subjective and most conservative method of valuation is excess assets, based on the current worth of the firm. This is calculated by adding all assets of the firm and subtracting all liabilities. The net result should be the "book value" of the firm.

Although this appears to be an exact and clear-cut method of valuation, it is important to understand that no two accountants will ever yield the same valuation with this method. Careful review of the assets and liabilities is necessary. Particular attention should be brought to "accounts receivable" and "fixed assets"—two areas where subjectivity may arise.

The excess assets formula is based on estimates of the value of the firm if it were liquidated, while the discounted cash flow and earnings capitalization formulas treat the firm as an ongoing business concern. An ongoing concern is inherently more valuable than a liquidated firm.

OTHER FACTORS AFFECTING VALUE

The three valuation methods presented above can establish a framework for discussion of the true value of the firm. The following very subjective factors also have an important impact on the true value of the firm:

- Nature of the business (consulting, design, research, a/e, etc.)
- Economic outlook for the firm in the context of the national economy and forecasts for specific markets
- History of the firm (stable vs. volatile)
- Firm's reputation and expertise (can be ephemeral)
- Major firm projects (some may be particularly desirable or undesirable)
- Key individuals in the firm, their abilities, and plans

METHODS OF PAYMENT

After the firm value has been discussed, and before price negotiations are concluded, it is important to consider how money or its equivalent will be exchanged.

Two basic principles are important here:

- **Fixed Valuation:** The value of the firm should be frozen on the date of ownership transfer. The value may be subject to increases or decreases after that date, by renegotiation, but the benchmark should always be the agreed-upon value on the date of transfer.

- **Equality of Earnings:** If the former owners are to remain active in the firm, their current compensation should be arranged for short-term objectives on the premise that "cash motivates." They should be paid on the basis of fees earned for services rendered. If the current compensation of former owners is based on a share in firm profits, it should be clear that expenses associated with the acquisition or purchase of the firm will not be charged against the former owners' share of the profits.

INCENTIVE COMPENSATION

Ownership transition plans commonly provide for payment to former owners through a base salary plus an incentive compensation. The base salary can be payment toward the principal valuation amount and current activity, while incentive compensation can provide additional payment for current activity.

The size of incentive payments must be based on objective factors. The usual basis is firm profits, excluding expenses associated with the sale of the firm. Some firms use receipts, gross new commissions, and so forth.

To reward sustained growth as preferable to cyclical growth, it is best to base incentive compensation on cumulative results. Firms usually pay a portion of the incentive compensation annually, with deferment of the balance over at least a five-year period.

METHODS OF PAYMENT

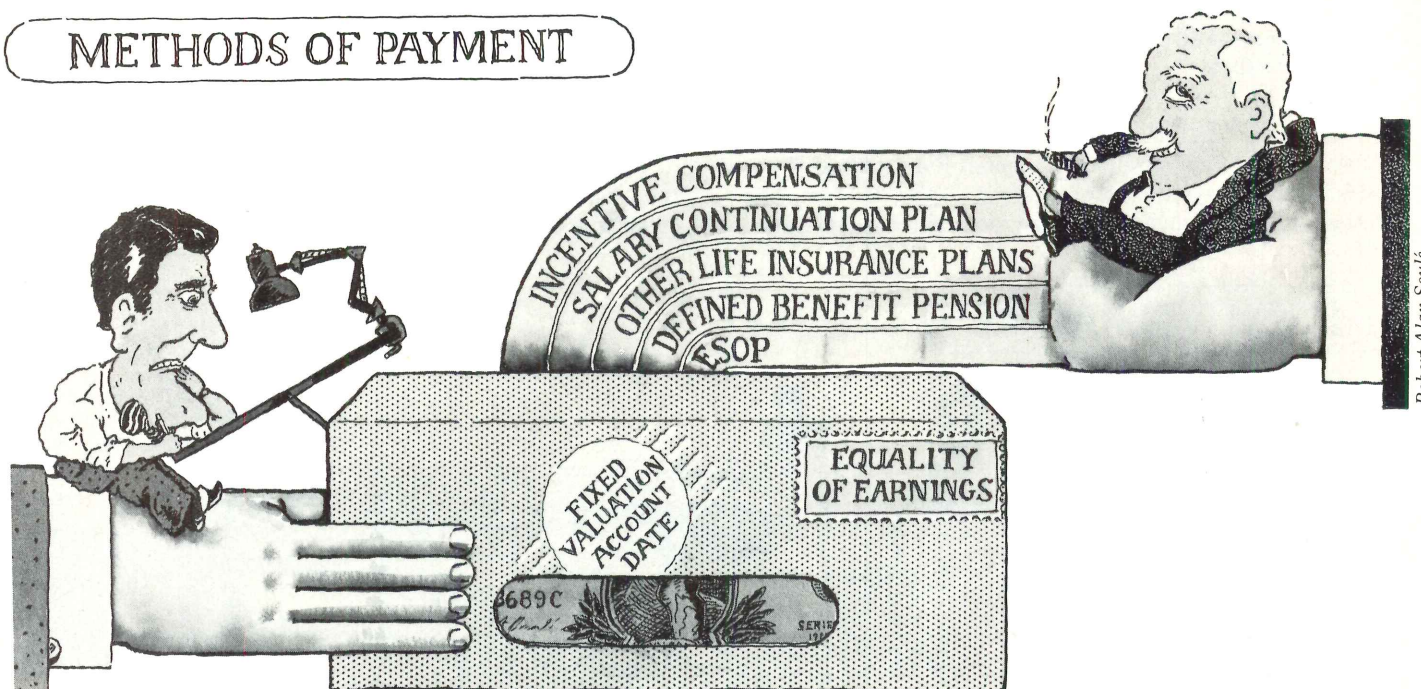

Recruiting the Right Team

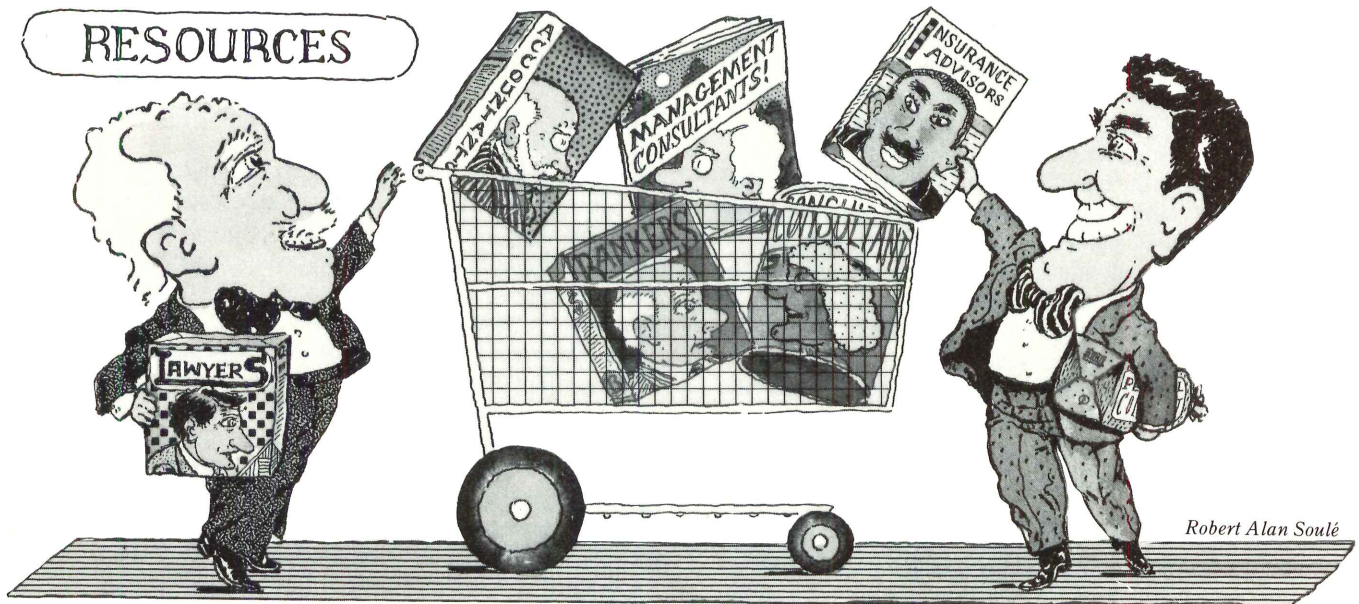

ATTORNEYS

A firm can save time, expense and anxiety by consulting an attorney in the early stages of the transition process. Attorneys will be needed to prepare partnership or corporation documents, buy/sell agreements, and stock issuance papers.

It's important to select an attorney with experience with design firms, and specifically with ownership transfer. This experience can allow the attorneys to counsel the firm on the repercussions and long-term consequences of legal decisions.

An attorney for the firm legally represents the firm's position as an independent entity. The buyers and sellers may want to have their separate interests represented by different attorneys.

ACCOUNTANTS

A detailed and complete financial review is important input for financial decisions involved in ownership transition, including establishment of the firm's worth. Accountants also advise on stock valuation, financial reporting and records.

The financial history provided by an accountant should be adjusted to assure that each year's financial status is evaluated on the same basis. This consistency allows for internal comparisons from year to year, and external comparisons with the performance of other firms.

The transition process may involve a change in the firm's financial approach in the treatment of assets and liabilities. Accountants can help identify alternatives to reduce tax liabilities.

Firm accountants, like attorneys, represent the firm and not the principals or other parties involved in the transition.

INSURANCE ADVISORS

All insurance policies should be re-evaluated during an ownership transition. Insurance agents advise on the extent of

coverage required, identify weaknesses in the present coverage, and regularly review and update the coverage as the firm grows.

BANKERS

The establishment of an ongoing relationship with bankers is important to any architectural practice. Ownership transfers often require outside financing, so a strong and secure line of credit can be especially helpful during ownership transitions. A banker can determine the amount of loan required and the time frame for payback. Bank representatives may be included in meetings where major financial decisions are discussed.

MANAGEMENT CONSULTANTS

Management consultants are sometimes called upon in ownership transitions to analyze the existing firm structure and suggest workable alternatives. They can also advise on valuation and options for managing the transfer of power. Consultants can play an important role by providing an objective and unbiased perspective on the issues. It is best to use a consultant with experience in dealing with ownership transfer and knowledge of architectural practices. Consultants who specialize in human dynamics can identify conflicts that might occur or may already be occurring among the parties, and help resolve them. They can also be a link among the lawyers, accountants, and other members of the team.

PERSONNEL CONSULTANTS

Personnel consultants are sometimes brought in when the principals have not found suitable successors and want to accomplish an ownership transfer quickly. Personnel consultants have the expertise and resources to search for appropriate candidates.

Buy-sell agreements are often incorporated in ownership transition documents

EMPLOYEE STOCK OWNERSHIP PLANS (ESOPs)

ESOPs are stock bonus or profit-sharing plans that invest their assets primarily in the firm's securities and afford tax savings to plan participants. ESOPs can be used as financing vehicles to enable the owners to transfer ownership to employees.

ESOPs must satisfy the qualification requirements of the Internal Revenue Code. The contributions or benefits provided cannot discriminate in favor of employees who are officers, shareholders, or highly compensated individuals. When an ESOP conforms to these, and other, standards, contributions are tax-deductible. As with certain tax-deductible pension funds, distributions from the plan are eligible for favorable tax treatment.

An ESOP can be used to shift ownership in the following way:

1. The firm sets up an ESOP.
2. Key employees purchase a percentage of the owners' stock.
3. The ESOP borrows the valuation amount, less the amount paid in item 2 above.
4. The ESOP buys the remaining stock.
5. The firm annually contributes enough cash to amortize the loan. The contributions are tax-deductible.

ESOPs are normally used to finance less than 50 percent of ownership. The remaining shares are purchased directly from the owners.

In considering ESOPs it is important to recognize that the firm may be required to buy back its stock from participants who receive distributions of stock from the ESOP. This can be very costly.

SALARY CONTINUATION PLANS

In some ownership transition plans the purchasers agree to pay all or a portion of the former owner's salary to his or her estate in the event of death before retirement.

These arrangements can be funded with company-owned insurance on the owner's life. The company receives life insurance benefits tax-free, and is allowed a deduction for salary continuation payments, if in accordance with a prior agreement. Normally payments disbursed in accordance with a salary continuation plan are deducted from principal balance outstanding from the sale.

OTHER LIFE INSURANCE PLANS

There are many types of life insurance plans that can be used to provide benefits to a former owner. The use of life insurance and trusts, particularly Retired Lives Reserves, is beneficial to the firm, but most owners do not want the bulk of their payments tied up until after their death.

PARTNERSHIP AGREEMENTS

In a partnership each partner is personally liable for all the obligations of the business, including those incurred by the other partners. Continuation of the business in the event of the death, retirement, or withdrawal of a partner should also be considered.

BUY-SELL AGREEMENTS

Waiting until events such as death, disability, and retirement occur to determine the price and terms surrounding the liquidation of an equity interest will have the following disadvantages:

Disadvantages to the firm:

- There is no certainty that the ownership interest in question will not become part of a controlling interest sold to outsiders.
- Without an agreed-upon formula for price, the firm cannot effectively plan for funding its obligation to a withdrawing principal.
- Negotiations without formulas and without methods of funding can be protracted and sometimes bitter.

Disadvantages to the principals and their estates:

- Important negotiating leverage is lost once the principal is removed from an active role in the firm.
- If the principal was a minority owner, the firm may feel no strong need to acquire the interest unless on terms favorable to the firm. This can also lead to bitter negotiations.
- Without an agreed-upon formula for price, the principal cannot effectively plan for his or her retirement or estate.
- If the firm has not planned to fund the purchase, it may not be able to pay the price in a way that meets the needs of the principals.
- When the IRS audits estate tax returns, it will normally accept valuation formulas that have been made binding in an agreement signed during life. In the absence of these formulas, IRS may use its own, which could inflate the estate tax. There is no assurance that the amount the firm would be willing to pay would take into account the increased tax obligations of the estate.

For all these reasons, buy-sell agreements are often incorporated into ownership transition documents. These agreements typically define the events giving rise to a transition in firm ownership and establish the price at which equity interests in the firm will be liquidated. Careful thought and planning are the keys to a successful buy-sell agreement.

Most architectural firms are owned by a relatively small number of individuals who are active in the day-to-day affairs of the firm. These firms usually distribute their earnings from compensation and have no viable arrangements for paying a return on investment to passive investors. Principals generally want the right to cash out their investment when they are no longer active in the firm and no longer receiving compensation. They also require assurance that they can withdraw funds immediately should death or disability occur.

In these closely held firms, current management usually doesn't want individuals who are no longer associated with the firm, or their estate representatives, to be able to participate in the affairs of the firm. Therefore, whenever a principal is no longer able to serve the firm, these firms would want to acquire the ownership interest, or they would want the remaining principals to do so if the firm is unable to fund such acquisitions. This situation may occur upon death, serious disability, or departure—voluntary or otherwise—including planned retirement.

If the departure occurs voluntarily because of personal reasons, other than planned retirement, or if the principal is asked to leave for committing an act detrimental to the firm, there is less reason for the firm to provide a favorable market for the liquidation of the

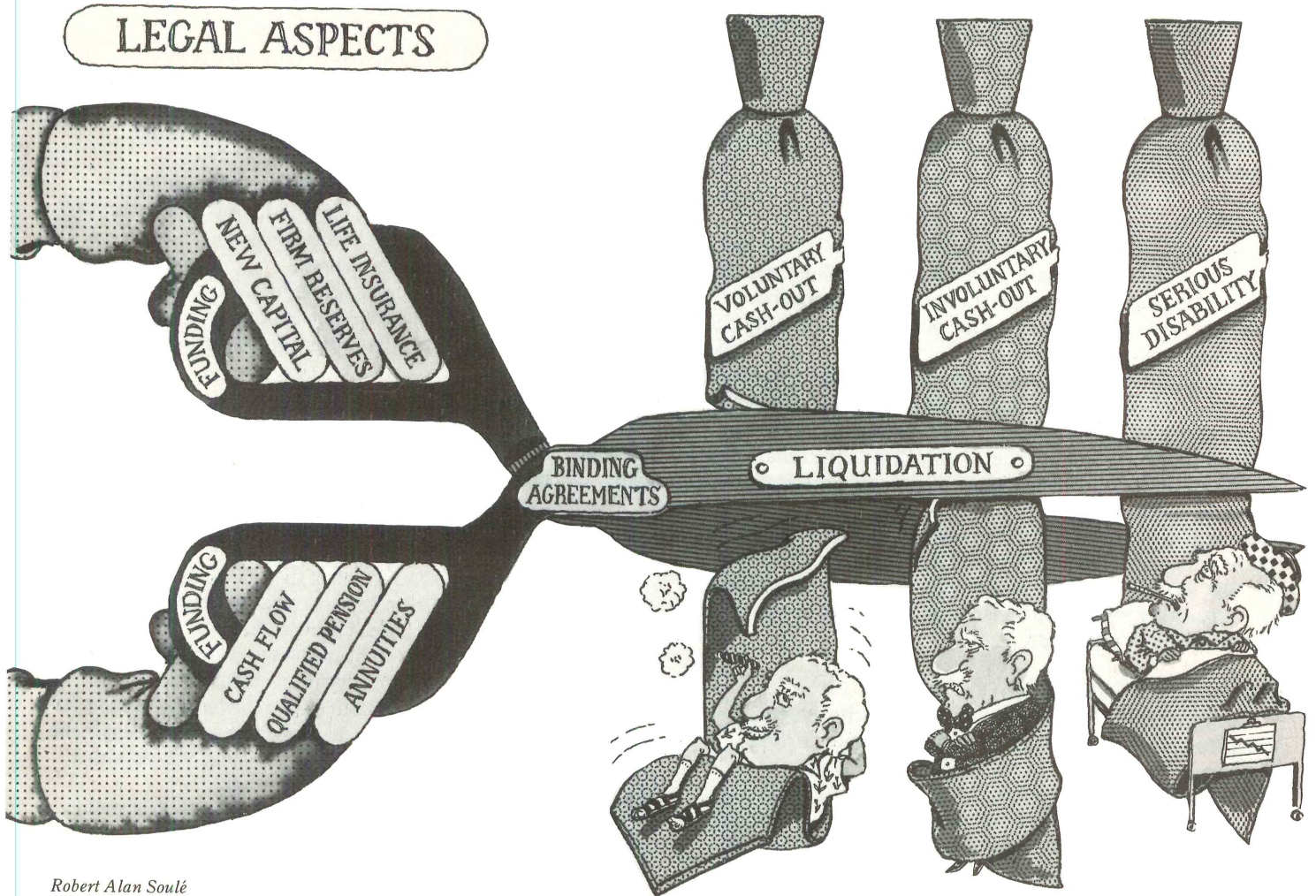

Robert Alan Soule

principal's interest. The firm has good reason to require a penalty for early withdrawal, because if the valuation payment is too attractive, the plan may encourage people to leave the firm and perhaps even to compete with it.

In such situations, the firm may want only an option to purchase the interest rather than a definitive obligation to purchase. Creating this option will give the firm negotiating leverage concerning issues that may not have been addressed totally in the agreements between the parties regarding separation.

Serious disabilities create other problems. Principals who are seriously disabled for an extended time are often required to liquidate their investment in the firm, and firms are typically required to acquire that interest.

It is important that the agreements define "serious disability." A definition of serious disability is usually provided under disability insurance policies covering employees.

In the absence of insurance coverage, disability is usually defined as "the inability to perform normal duties related to the firm." Determination of whether this condition exists may be vested in doctors, whose decisions are made binding on all the parties. The agreement should also define the amount of time that may elapse before the disabled person is required to liquidate.

HOW ARE LIQUIDATIONS FUNDED?

The traditional sources for funding liquidations are:

- Firm reserves. These are the amounts set aside from earnings to cover future contingencies.
- New capital from existing or new principals.
- Cash flow from operations.
- Qualified pension, profit, or ESOP plans.
- Life insurance. The availability of this resource is dependent upon the firm's ability to pay premiums, the insurability of the individuals, and their expectation of working until their final days.
- Annuities purchased from insurance companies.

The funding methods are chosen according to the specific situations involved. The firm must decide how much insurance it wants to buy if it can insure an event, and the level of reserves it needs to establish to cover uninsured events. Agreements regarding uninsured obligations need to allow for flexibility in payment. The firm will want to limit the cash flow expended should multiple liquidations occur during a short period of time.

■ Borrowed funds

If the firm does not have adequate insurance or reserves to pay a fixed obligation, the only alternative is to borrow funds. Usually the money is borrowed from the liquidating principal in the form

Hire a good accountant to unravel the tax entanglements

of an installment obligation loan, although the firm could borrow from a financial institution.

SECURITY

The principals who are selling need provisions covering the contingency that the purchasers default on their obligations. The ability to foreclose and recapture the position being purchased, and/or the personal guarantees of the purchasers are traditional forms of security.

If personal guarantees are not used, the participants may want to consider "operating covenants." These are pledges from the remaining principals to govern the firm in the ordinary course until the obligation is retired. This would protect the sellers from a situation in which the remaining principals attempt to avoid obligations by starting a new firm.

The firm's obligations to principals for their interest in the firm may be either an amount that is fixed at the time the interest is acquired, or variable and contingent on the future success of the firm. Frequently, ownership transition plans have elements of both fixed and variable payments.

FIXED PURCHASE OBLIGATIONS

The formula for determining value and the schedule for payment are stipulated in a plan with a stated or fixed purchase obligation.

Equal consideration should be given to predicting the timing and amount of obligations created by the plan, and identifying sources for repayment. The plan must assure that the firm can pay its obligations in a time frame that will not cripple the firm.

VARIABLE AND CONTINGENT OBLIGATIONS

Because of the problems of predicting the timing and amount of fixed obligations and then funding them, many firms use agreements that contractually require continued compensation and preclude liquidation for a fixed period. They may also make payment contingent on other situations. This contractual obligation may or may not be in addition to an amount necessary to retire the hard or excess asset portion of the investment.

These arrangements have several advantages to the firm:

- If the obligation is contingent, the risk that the firm could not afford payment is reduced.
- Reduction of fixed obligations improves the financial statement of the firm.
- The selling principals have a vested interest in maintaining the viability of the firm.
- The payments can be structured to be tax-deductible to the firm, rather than treated as a reserve account. If the firm is a corporation, tax law problems regarding unreasonable accumulation of reserves and constructive dividends are minimized.

These arrangements have several disadvantages to the principals:

- For tax purposes, the payments are treated as ordinary income, not capital gain. Usually, the principals selling an interest back to the firm are able to treat it as capital gain.
- The payment is usually unsecured.
- The principals are gambling on the future health of the firm. If they leave the firm in good condition but their successors ruin it, they will lose the value that was present on the date of departure.

CORPORATIONS

In both corporations and partnerships, the liquidation of the principal's interest may be made by direct sale to the organization (entity purchase), by sale between the owners (cross-purchase), or by a combination of the two.

Funds reserved for the liquidation of an interest will generally be taken from after-tax dollars.

A properly structured liquidation of the principals' interest in a corporation should yield the same tax consequences whether it is by means of an entity purchase or a cross-purchase.

The selling shareholders, who may be the principals' successors, will realize capital gain income in an amount equal to the difference between the sale price and the adjusted tax basis in the stock (which is most often its original purchase price, except in the instance of a shareholder's death, where the stock will acquire a tax basis equal to its value on the date of death).

Where an entity purchase is involved, it is important to comply with the redemption provisions of the Internal Revenue Code. Under some circumstances, where family members or relatives of

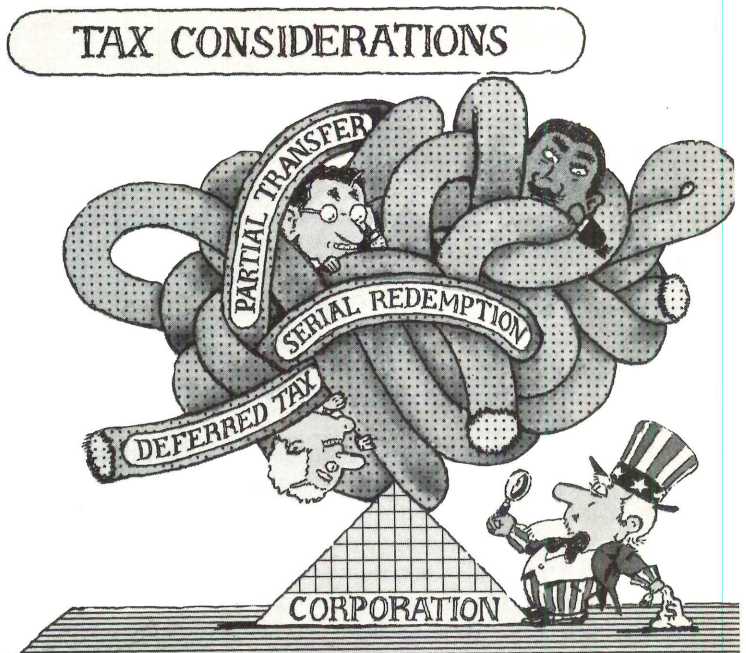

the selling shareholder continue to own stock in the corporation, the redemption of stock by the corporation may be treated as a taxable dividend.

PARTNERSHIPS

Structuring a complete liquidation of a partnership interest depends on the tax situation of each partner.

The selling partners usually prefer a cross-purchase of the partnership interest, since gains on sale (except for portions attributed to ordinary income items such as receivables) will be treated as a capital gain.

The redemption can be structured to generate ordinary income to the seller and a deduction for the partnership if the partnership purchases the interest.

Liquidation of partnership interests should be timed to avoid the bunching of income and deductions.

PARTIAL TRANSFERS

In cases where the principals decide to shift some of the risks and benefits of the business to younger principals without, for the time, liquidating their equity interest, there are other approaches.

“Guaranteed payments” are an accepted way of structuring a partial transfer in a partnership. Guaranteed payments provide a fixed and determinable return to the partners who wish to curtail or reduce their activities, and are calculated on a different basis from partnership income. Such a payment may take into account a fixed percentage return on the principal’s share of the partnership’s assets, as well as a specific rate for services performed by the principals.

Under the Internal Revenue Code, guaranteed payments are treated as income to the recipient and reduce the partnership income otherwise reportable by the remaining partners.

In corporations, a stock recapitalization coupled with an employment contract can achieve results equivalent to guaranteed payments. The contract can provide current compensation for services, and the recapitalization provides a return for the use of capital and freezes the principal’s equity participation in the firm.

The federal income tax treatment of partial transfers in corporations will depend on the form of transaction. The serial redemption by a corporation of the stock interest of a shareholder will constitute a taxable dividend to the principals even though the equity interest in the corporation is reduced, unless the distribution qualifies as a “substantially disproportionate redemption of stock” under the Internal Revenue Code. Cross-purchases between stockholders can alleviate this tax burden, but this will require careful drafting by the corporation’s counsel to avoid still other problems.

A serial liquidation of the interest owned by about-to-be retired partners is a more flexible tax situation. If the partnership purchases a portion of a partnership interest, the selling partners may be able to defer a significant portion of the taxes until the tax basis in the partnership interest has been exhausted. Such would not be the case if the partners sold to the remaining partners instead of to the partnership entity.

SUMMARY: ASSEMBLE THE RIGHT TEAM

This article presents basic guidance regarding the legal, financial, and tax problems involved in an ownership transition. The services of attorneys, accountants, bankers, insurance advisors, and perhaps management and personnel consultants will be required. It will be important to select the right team, and to work closely with them in ironing out the major issues and the myriad of details involved in an ownership transfer. □

Douglas Bevis is chief financial officer for the NBBJ Group in Seattle, Wash.

Weld Coxe is chairman of The Coxe Group, a Philadelphia management consulting firm specializing in the design professions.

Thomas Eyerman is the partner at Skidmore/Owning & Merrill, Chicago, in charge of firm-wide administration and finance.

Paul Lurie is a partner in the Chicago law firm of Fohrman, Lurie, Sklar and Simon.

Marc Roth is an associate attorney with Fohrman, Lurie, Sklar and Simon.

A list of further references on ownership transition appears on page 75.

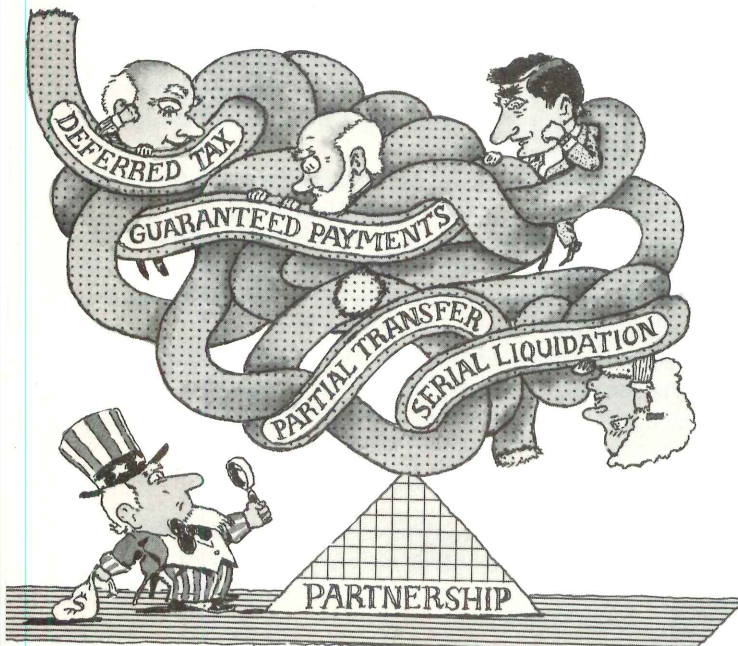

Robert Alan Soule

PRODUCTS

“HIGH-TECH” ELEVATORS

BY BARBARA GOLTER HELLER, AIA

THE “HIGH TECH” REVOLUTION HAS HIT THE ELEVATOR industry. Solid-state power conversion sets are replacing traditional motor-generators. Remote maintenance monitoring is now possible through miniaturized micro-processor control systems. Voice synthesizers read messages to cab occupants to give instructions and enhance passenger comfort.

While there are over 60 elevator companies in the U.S., the six or seven largest companies dominate the domestic market and three—Otis, Dover, and Westinghouse—account for the majority of domestic elevator sales.

There's a new kid on the block, too—Fujitec America, Inc.—an American subsidiary of Fujitec International Group, which is Japan's fifth largest elevator manufacturer.

Fujitec moved its headquarters from Japan to New York City in the early 1980s and recently completed construction of a manufacturing facility in Lebanon, Ohio that will be fully operational at the end of 1984 and capable of producing 3,000 elevators and 600 escalators each year. Fujitec claims the Ohio plant will be the largest elevator manufacturing facility in the world, and plans eventually to construct a 1,000 foot high elevator research tower near the plant. Although Fujitec's U.S. sales are still small, one elevator manufacturer's representative admits that the American companies are worried.

“We see Fujitec and we think Toyota,” he said.

SOLID STATE MOTOR DRIVE

Solid state power conversion eliminates the traditional motor-generator and replaces it with a silicon control rectifier (SCR), which is a solid-state circuit that converts the AC power delivered to the building into the DC power needed to drive the elevator motor. SCR technology has been available and used for 15 years, but the number of SCR units actually installed has increased sharply in the last few years.

Merton Meeker, director of technical marketing for North American Operations of Otis Elevators, estimates that 70-75 percent of gearless elevators and 20 percent of geared elevators are being installed with SCR today. SCR is not cost effective for hydraulic elevators and has not been used for hydraulics to date.

“When we introduced the Elevonic 401,” Meeker says of Otis's newest gearless elevator model, “we anticipated that the use of SCR and traditional power set would be about even, about 50-50. What we've found is that well over 90 percent of the Elevonic systems have been installed with SCR. That's basically due to customer preference.”

The advantage of SCRs are that they are more energy efficient, smaller in size and allow better speed regulation with faster reaction time than traditional motor-generator sets.

Like all other solid-state power circuits, SCR has the disadvantage of creating high frequency harmonics, which means that occasionally transient current, or sudden surges of electricity, are released into the electrical system of the building. While not of particular concern in a standard office building, such an event can wreak havoc with sophisticated electronic equipment.

Lerch Bates and Associates, Inc., headquartered in Denver, Colo., is the largest elevator consulting firm in the country, with offices in over 12 cities. Leonard LeVee, now senior consultant and regional manager with Lerch Bates' Washington, D.C., office, was working for the Veterans Administration when a VA hospital in Topeka, Kan. suddenly experienced a troubling episode.

EKG readings in the cardiac intensive care unit erroneously indicated all 12 patients were having heart attacks at the same time. The cause of the malfunction: transient current from the SCR in the elevator.

All solid-state circuits produce this kind of transient current, also known as “electronic noise,” or “power supply pollution.”

Elevators have been known to malfunction as a result of transient current released by other solid state equipment such as x-ray machines. The pollution of electrical power supply to a building is a problem increasingly confronting building occupants who routinely use powerful solid-state equipment. Main-frame computers are vulnerable to damage and most are fabricated with filters or reactors built into their power lines. Small computers and word processors are not likely to be damaged because they do not draw enough power to be affected.

Transient current from SCR can be minimized by isolating the feeders and incorporating reactors in the SCR line.

Acoustic noise generated by SCR equipment can irritate building tenants. SCR equipment vibrates, as do the feeder lines. The vibration is not continuous, but varies as the elevator starts and stops, which makes the noise more noticeable.

“A feeder line in an office wall can drive someone crazy if the wall is not properly insulated,” says Bob Seymour, senior consultant and regional manager at Lerch Bates' Washington, D.C., office.

Steve Edgett, the head of the elevator consulting staff at Skidmore/Owings & Merrill (SOM) in San Francisco, expresses another concern.

“SCR drive and micro-processor controls become a liability once the installation is located outside of an urban area because service technicians trained in these systems are generally not available in outlying areas,” Edgett said.

Elevator manufacturers themselves are divided in opinion about the benefits of SCR.

Barbara Golter Heller is an independent specifications consultant practicing in Washington, D.C.

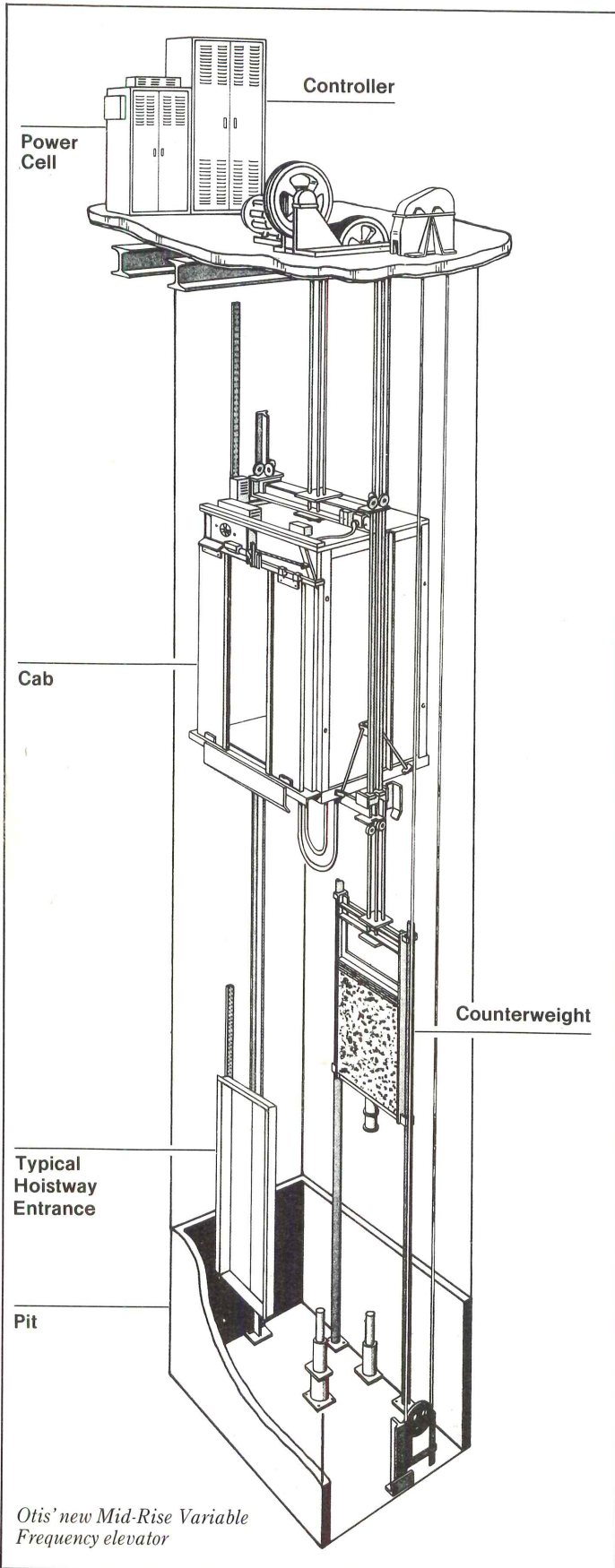

Otis' new Mid-Rise Variable Frequency elevator

Rick Ireland, manager of market planning for Westinghouse says, "It's a good application for gearless, but it's difficult to achieve cost-effectiveness for geared elevators."

But Richard Karll, senior vice president of Montgomery Elevator Company in Moline, Ill., says, "SCR is the standard of the industry now and the state-of-the-art control. You won't see anything else in five years."

MID-RISE VARIABLE FREQUENCY

MRVF, which stands for mid-rise variable frequency, is a new Otis Elevator product. The elevator uses a power transistor inverter, which is a type of solid-state circuit, instead of the SCR used in other elevators. A series of power cells, or batteries, store and feed power to an induction motor.

"By using an induction motor, instead of the specialized elevator motor, we are able to save money, cut down on fabrication time and get a simpler, more reliable motor," says Meeker of Otis.

Otis also claims that the power cells, because they store power, will run a group of elevators for up to four hours during an emergency power loss. MRVF is a geared traction system suitable for a maximum rise of 16 floors.

Otis was the first company to develop this type of power cell elevator and is the only company manufacturing such an elevator in the U.S. Mitsubishi of Japan announced plans to market a similar type of elevator earlier this year, but is currently prohibited from selling elevators in the U.S. under a trade agreement with Westinghouse.

Like other solid-state circuits, the power transistor inverter used by the MRVF can produce transient current. Otis says the transient current is absorbed by the batteries.

Bob Seymour of Lerch Bates has mixed feelings about MRVF.

"It's a shot in the arm to the American elevator industry," he says, "but it's basically unproven. For instance, Otis claims that the battery life is four years. Is that four years from the date of manufacture? Four years under all kinds of environmental conditions? I think it's a good idea, but I wouldn't recommend it openly to one of our clients except in very special applications. I also have questions about the ventilation needed in the machine room. Like all powerful batteries, if you don't get proper ventilation there's a potential for gassing and explosion."

"The MRVF machine room does not require any more ventilation than a conventional machine room," Meeker of Otis responds. "Our batteries are good for four years from the date of installation, and we back that up by including free battery replacement with our standard maintenance contract. We had some early problems with batteries overheating, but this was due to the fact that the power pack was being recharged too hard and too fast. We've now corrected that problem."

MICRO-PROCESSOR CONTROLS

Microprocessor controls are another area of major change. Control systems are computerized and more compact. They can be programmed to accommodate specific user needs with minimal response time, and, perhaps most importantly, to store data about the elevator's performance that can be retrieved at a remote location over the telephone. This capacity allows a manufacturer to monitor installations within a certain geographic area and diagnose problems before the elevator fails completely. It also enables them to isolate elevators that are not functioning.

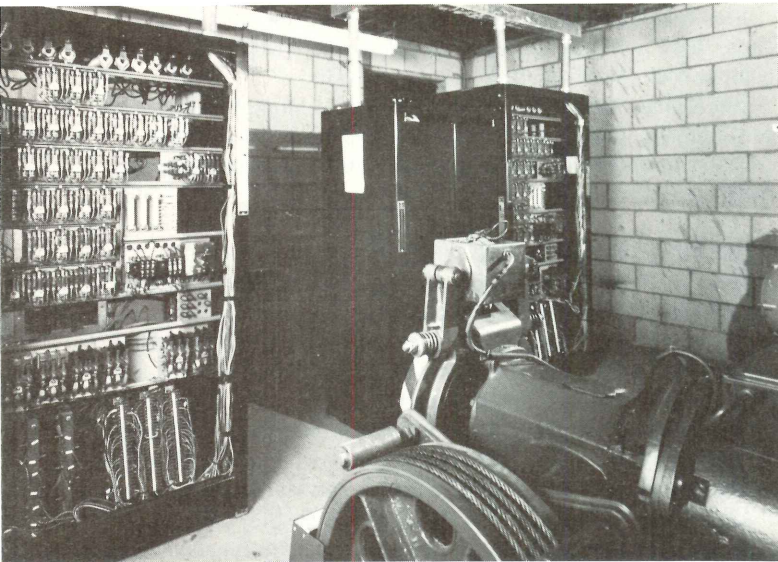

The elevator machine room of the past, illustrated by the photo on the left, was a large cluttered room in which access to the equipment of maintenance purpose was a chronic problem. By contrast, today's elevator machine room (right) may be no larger than the elevator shaft, with easily accessible



controls. Increasingly, elevator maintenance is enhanced by computerized control monitors that store data about each elevator's performance and possible malfunction.

"In a building that has 30 elevators," notes Meeker of Otis Elevator, "it's easy for no one to realize that one elevator isn't functioning at all."

Remote monitoring is also giving manufacturers useful data about elevator performance and allows them to adjust the programming if they perceive that an elevator is being used inefficiently.

One of the leaders in remote service monitoring is U.S. Elevator. Les Heywood, vice president of marketing, estimates that 25 percent of U.S. Elevator's installations have been re-programmed based on data received from remote service monitoring.

New auxiliary controls are also being introduced. Voice synthesizers can be programmed to give emergency instructions, announce the landing being served or transmit messages to building occupants. Digital displays have been developed to display date, time and weather information to elevator occupants and have the capacity to be connected to a news service or to Dow Jones stock market reports.

Fujitec has introduced two very unusual features in the last year.

One, called Eyenic, is a lens that is programmed to react to the infra-red wave length emitted by the human body. This lens is mounted in the ceiling of an elevator lobby, and when it reports that a crowd has gathered, more than one elevator is dispatched to that location without the need for repeated calls. Fujitec will market Eyenic to hotel and convention centers.

Fujitec's other new feature, an elevator security device called Alarmic, is a lens that is installed in the ceiling of the elevator cab that can sense "abnormal signs such as quick and violent motions, sudden presence and swinging of a knife or dangerous implements, flame or smoke, or children playing" according to a sales brochure.

Alarmic reads "wave form variation of electric signals." When a dangerous situation is perceived, the elevator sounds a loud alarm, stops at the nearest landing and opens its doors. It will not operate

again until the alarm is disconnected.

While neither Eyenic or Alarmic have been installed anywhere in the U.S., both have been used in Japan. James Mancuso, regional sales manager in Fujitec's New York City office, reports that Alarmic does not produce a large number of false alarms.

WHAT'S NEXT?

According to Ireland of Westinghouse, "the next step in elevator controls is artificial intelligence. In the future, we'll have elevators that can predict where their calls will be before you push the button." □

DESIGN AIDS

Poor elevator service can waste time, make condominium units harder to sell, and irritate customers and clients. Since elevators are difficult, if not impossible, to modify after installation, it is important for architects to select and design elevators properly. When the price of an elevator consultant isn't in your budget, the following sources of information may help.

"Vertical Transportation Standards," published by the National Elevator Industry, Inc. (NEII) is available for \$12 from: NEII, 600 Third Avenue, New York, N.Y. 10016. It includes standards and design guidelines for elevators, escalators and dumbwaiters.

Elevator manufacturers have traditionally assisted architects with elevator design free of charge. Otis has an elevator planning program that runs on an IBM Personal Computer. The program selects the type, number and rating of elevators for a given building and is advertised as generic. Contact your local Otis representative for more information.

BOOKS

PRODUCTION METHODS IN THE COMPUTER AGE

SYSTEMS GRAPHICS: Break throughs in Drawing Production and Project Management for Architects, Designers, and Engineers. By Fred A. Stitt. McGraw-Hill. \$34.95. 261 pages.

AS THE COMPUTER ERA BLOSSOMS, ARCHITECTURAL PRACTICE and in particular the process of producing architectural drawings are poised to encounter a revolution. The traditional methods of drawing often seem as good, fast, and more satisfying as architectural drafting craftsmanship than the newer alternative methods. Yet the newer production methods, aided by the computer and by refined reproduction techniques, new mylar and polyester media, and new inks and pens, shake the foundations of the traditional drawing process. Stitt's new and useful book, **SYSTEMS GRAPHICS**, describes a series of production techniques that build on the best of contemporary practice to update and refine ways to produce and manage the production of architectural drawings and to prepare for computer oriented practice.

Billed as an architect, writer, editor, publisher, and inventor, Stitt seems eminently qualified to launch these new techniques. He has studied and observed office management and production methods with an eye toward making them more efficient, more responsive to productive practice, and more suitable to the growing potential of the computer.

Stitt's earlier work, entitled **SYSTEMS DRAFTING**, identified the transition stages involved in the shift from traditional production techniques to systems drafting. Systems drafting was defined by the author as "the reduction or elimination of hand drawing in the creation of construction documents." The book described the techniques of systems drafting and gave helpful tips and hints about the use of tools, equipment and materials. **SYSTEMS GRAPHICS**, his current book, elaborates on these techniques and

shows their potential for working together with management techniques in a systematic way to improve the production process.

SYSTEMS GRAPHICS is sensible, clear and engaging. It is a cross between a practice manual and a step by step "how to" guide of production techniques. These production techniques, although not really new, are collected, described and discussed in terms of the whole production process. These techniques are paste-up drafting, overlay drafting, computerized drafting and a construction detail system. The first two techniques are explained with photographs and drawings. The third technique, computerized drafting, is described from the point of view of getting started with computers, selecting the right equipment, and educating the staff. The last technique describes the creation of a system to use details both for reference and for master details to be modified for repeated use. The appendices include two ways to index the detail system as well as useful and extensive checklists for information to be included on working drawings.

SYSTEMS GRAPHICS does not quite present the organized schemata that the title suggests. It is a compilation of information clustered around the previously mentioned production techniques. The book offers a broad picture of production based on the best of current techniques and the author's ideas. This picture is in contrast to the often limited view that can occur in a firm whose practice is comprised of a kind of hand-me-down experience gleaned from apprenticeship. This book could be useful to the principal, project manager and designer-drafter. It is one of only a few books describing production techniques that is concerned with advancing architecture into the computer age—an age that may revolutionize the practice of architecture.

—McCain McMurray, AIA
Director, AIA Practice Publications

HOUSING THE ELDERLY: PROBLEMS AND POTENTIALS

HOUSING FOR A MATURING POPULATION

The Urban Land Institute (in cooperation with the Housing Committee of The American Institute of Architects), 1983, \$35.50. 246 pages.

THE URBAN LAND INSTITUTE AND AIA'S HOUSING Committee performed the research that produced "Housing for a Maturing Population." The timeliness of this subject is dramatized by the fact that people over 75 are proportionately the fastest growing age group in the United States today. Katharine Warner points out in her chapter on demographics that the proportion of the U.S. population age 65 and older has increased from four percent (three million people) in 1900 to 11 percent (25.5 million people) in 1980. By the year 2000, 12 percent of the population, or nearly 32 million people, will be over 65 years of age. The housing needs of this huge and growing population group are challenging when evaluated against the existing housing stock.

HOUSING FOR A MATURE POPULATION succinctly articulates the housing problems of the elderly, and presents research and case studies of examples of successful solutions. Chapter headings are revealing: "Demographics and Housing;" "Applying Research to the Plan and Design of Housing for the Elderly," "Architecture for Long-Term Care," "Tenant Expectations and Design Response," "Retirement Communities," "Present and Future," "Neighborhoods as Housing Environment for Maturing

People," "Designing for Density," "Gentrification and the Elderly," "Aging in Place," "Optimizing the Present Housing Stock," "Use of Existing Large Homes for Shared Living," "Congregate Living: The Boarding House Alternatives," "Structuring for New Housing Choices: Rifle, Colorado," "Rural, Scattered-Site, Government-Assisted Housing," "The Future of Granny Flats," "Industrialized Housing," and "Zoning Responses to a Maturing Population."

Authors include architects who know a great deal about elderly housing: Thomas Byerts, Laszlo Papp, Roger Lewis, Blake Chambliss, Anand Chaturvedi, James Herman, R. Wendel Phillips. Diagrams, illustrations and photographs are used with great effect in the book. The volume lacks an index, which would have been handy for reference.

The AIA Commission on Design and its Committees on Architecture for Health and Housing will continue to work in the area of design for the aging.

In "Housing for a Maturing Population," architects have collaborated with the research and development community under the auspices of The Urban Land Institute and its able Director of Publications, Frank Spink, to reopen the discussion of this critical subject. This book is required reading for anyone who has an interest in the problems and potentials of housing the increasing elderly population of the United States.

—Michael B. Barker
Administrator, AIA Design Dept.

SOFTWARE

COMPUTER-ASSISTED SCHEDULING FOR ARCHITECTS

BY ROBERT J. KRAWCZYK

Critical path project scheduling has long been a contract requirement for many construction projects. Although contractors use it routinely, few architects believed it could help them. But now a new generation of microcomputer software may change that.

Here's what scheduling programs can help an architect do:

- Plan the delivery of design services, including the allocation of resources such as time, money and people.
- Assist in setting time and cost limits.
- Reveal possible scheduling problems.
- Permit testing of various scheduling schemes.
- Track the effect of redistributing resources.
- Keep the manager abreast of the effect of current tasks on future deadlines.

The rub is that no computer will do all those tasks automatically. Project scheduling packages are only computational tools. The architect must specify for each project all the tasks, the relationship between them and their duration.

GETTING STARTED

The most effective way to pick the best program is to first analyze the type of scheduling the office does, the number of tasks to be specified, the information needed for each task in addition to its duration, the preferred type of reports and charts, who will maintain the scheduling data, and how the collection and processing of data will be integrated into the project.

None of the manuals that come with the software offers a good introduction to network scheduling. Novices can get the background they need from one of the books listed in the reference section of this magazine. A brief primer, below, defines some of the terms used in scheduling. To help the new user, all eight packages reviewed here provide a sample project file and all but MicroGantt walk the user through a sample project. Tutorials on scheduling are available with PertMaster, Pro-ject 6, Harvard Project Manager and Milestone. All except Harvard Project Manager provide at least some sample reports. PertMaster puts its sample reports in the brochure; Pro-ject 6 provides only limited examples.

Most of the packages run on the IBM Personal Computer with the PC or CP/M disk operating system. A minimum of 128k RAM and PCDOS is required by MicroPert, PertMaster, Pro-ject 6 and MicroGantt. Project Scheduler requires PCDOS and at least 192k. PertMaster, MicroGantt and Milestone also run on the CP/M operating system with 56k RAM. Milestone supports CP/M-86

with 128k. Purchase of an alternate operating system costs about \$60. PMS-II requires CP/M-86, 56k, plus CBasic language, which costs \$245.

A minimum of 250k disk storage is recommended. Big projects require more storage. Dual diskettes are adequate for most applications. Projects with more than 1,000 activities and multiple resources require a hard disk.

All the packages support the most popular printers (but not plotters) to generate charts and graphs. Most packages support a color monitor but none require it. None produces reports or charts in color.

PROGRAM CAPACITY

To process scheduling data and display results quickly, the size of some scheduling networks has been limited. Small packages permit only overviews or independent sub-networks. They are useful primarily for helping individual managers schedule their own projects. The appropriate size for the network will depend on the scope of work. Scheduling of design services or small construction projects could be handled in a few hundred activities. Larger capacity packages, such as PertMaster, permit complete construction schedules and management aids not available on small packages.

The capacities of PMS-II and Harvard Project Manager are limited only by storage capacity of the computer. The maximum number of activities for each package is shown in a table at the end of this article.

ACTIVITY TYPES

All the packages except Pro-ject 6 track an activity by time or resources. Only Pro-ject 6 and PMS-II do not accept activities as milestones. They play an important part in determining deadlines within the network if coupled with the ability to specify scheduled dates.

An activity can be a previously created network with Harvard Project Manager and MicroGantt. Larger projects can be assembled from subprojects containing a complete set of activities or a common set of activities applied to each project. This is a particularly desirable feature with packages that support a relatively small number of activities.

All but PMS-II describe the scheduling network in the format called activity-on-node, or precedence, PMS-II uses only the older activity-on-arrow method. PertMaster supports both. The choice is not critical. Activity-on-arrow can be easier to understand, but activity-on-node allows more variety in scheduling alternatives.

CALENDAR SPECIFICATIONS

The ability to specify the period of time to be covered may be important. The shortest activity will determine the type of work

Robert J. Krawczyk is a member of the AIA Committee on Computers in Architecture. He is a computer application consultant and teaches CADD at the Illinois Institute of Technology.

PROJECT SCHEDULING PRIMER EXPLAINS TERMS AND CONCEPTS

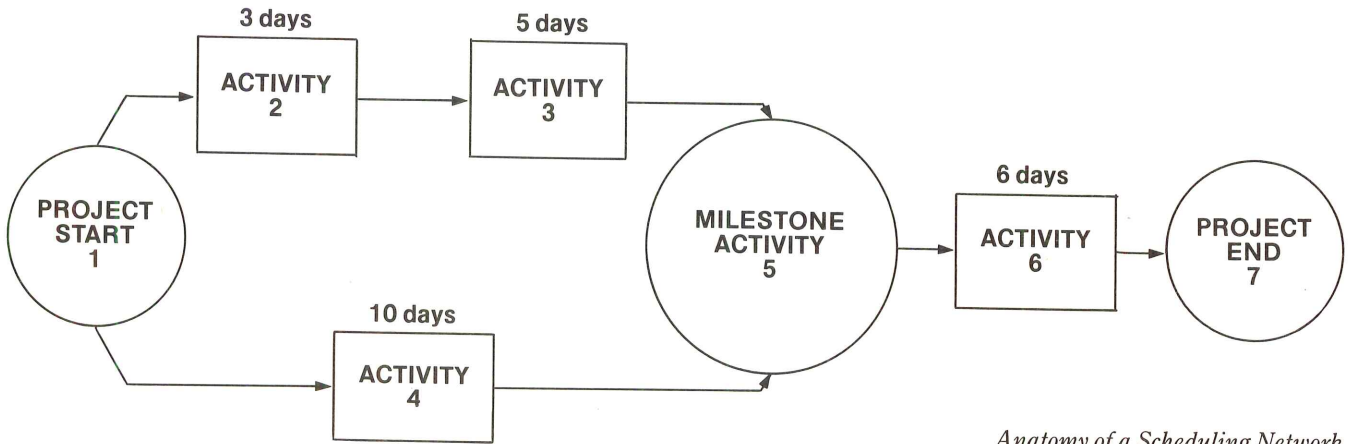

Anatomy of a Scheduling Network

This drawing (above) illustrates an *activity-on-node*, also called precedence, scheduling network. Each box represents an *activity*, i.e. a job or task. An activity has a *duration* and may have *resources* attached to it. Resources specify the quantity or cost of people, material and equipment required for the project. The circles represent *milestones*.

To find the total duration, follow the longest path. Any late activity along the 1-4-5-6-7 path extends the total duration. Thus this path is known as the *critical path*. Activities not on the critical path can be late without affecting the outcome. Their extra time is called *float* or *slack*. Activity 2 can be two days late without making the project late.

All activities shown above have a

finish-to-start relationship. Other relationships can show a lead or lag in scheduling the start or finish of an activity. *Start-to-start* and *finish-to-finish* are illustrated in descending order below.

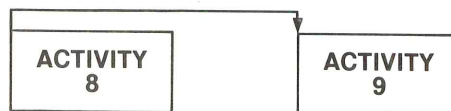

START-TO-START relationship

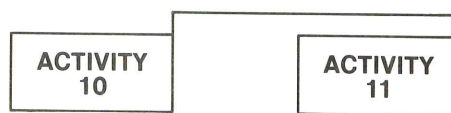

FINISH-TO-FINISH relationship

Activity 9 can start after activity 8 begins. Activity 11 finishes when activity 10 finishes.

Applying a calendar to the network will generate a set of dates, including the scheduled completion date, the *early start* and finish dates, and the *late start* and finish dates. The late dates fix the latest time an activity can start and when it will be finished without having an impact on another activity. These dates are presented along with resource in tabular reports or in time-scaled bar charts, called *Gantt charts*, that display the sequence of activities, their duration and their status. *Status* indicates if the activity is on the critical path, behind schedule, completed, partially completed or just starting.

periods and the time scale on the charts. Milestone and MicroGantt permit the user to choose days, weeks, months, quarters or years. Project Scheduler permits days, weeks or months. The others use days.

All the packages permit the user to set the number of work days in a week, holidays and non-work periods. Work periods are limited to 61 for MicroGantt, 220 for MicroPert and 9,999 for Milestone; Pertmaster sets 120 months, Project 6 sets 256 days and 110 weeks, and Project Scheduler sets no limit. Nonwork periods are limited to 30 days for Project Scheduler, 28 for Project 6 and 12 days for Milestone; no limit is set by MicroPert or PertMaster. MicroGantt's system is somewhat awkward because it requires days off to be specified as non-work activities. Neither work nor nonwork periods are limited by Harvard Project Manager or PMS-II. The best arrangement is to specify days as

the work period and to set no limits on work and non-work periods.

SCHEDULING OPTIONS

Accurate scheduling requires a variety of methods to represent the sequencing of activities. It also requires the ability to report activity completion as the project progresses. The basic finish-to-start relationship, which all the packages support, can be supplemented with other types of relationships. The most important is start-to-start, which only PertMaster and MicroGantt support. Or an activity may begin after the start of a preceding activity, creating an overlap.

The ability to include scheduled dates becomes important if establishment of internal deadlines is required. Scheduled dates also can be used to try a series of completion dates for the entire

SCHEDULING FEATURES COMPARED

	MicroPert	PertMaster	Pro-ject 6	MicroGantt	Harvard Pr. Mgr.	Project Scheduler	PMS-II	Milestone
1. Activities:	220	550 CP/M 1500 PC DOS	150	40/project	limited by disk	210	limited by disk	190
2. Activity types								
Time or resource	■	■		■	■	■	■	■
Time only				■	■	■	■	■
Milestones	■	■		■	■	■		■
Sub-project				■	■			
Multiple starts		■	■					■
Multiple finishes		■	■					■
3. Scheduling options:								
Start-to-start		■		■				
Finish-to-finish		■						
Activities		■	■		■	■	■	
Milestones		■		■	■	■		
Progress reporting								
Percent complete	■				■		■	
Remaining duration		■		■			■	
Completed activities			■			■		■
4. Activity reports								
Scheduling data								
Early start	■	■	■		■	■	■	■
Early finish	■	■	■		■	■	■	■
Late start	■	■	■		■	■	■	■
Late finish	■	■	■		■	■	■	■
Float time		■	■		■	■	■	■
Actual start			■		■		■	
Actual finish			■		■		■	
Events or milestones	■	■						
Sort options								
Activity number	■		■	■	■	■	■	■
Early start	■		■		■		■	
Early finish	■		■		■		■	
Late start	■		■		■		■	
Late finish	■		■		■		■	
Group code	■		■		■		■	
Selective reporting								
By group code	■	■			■		■	
By status			■		■		■	
Logic report	■	■	■			■		■
Logic chart	■				■		■	
5. Resources								
Max per project	none	29	30	no limit	1	24	no limit	9
Max per activity	none	no limit	5	2	1	24	3	9
Dollars		■	■	■	■	■	■	■
People		■	■	■		■	■	■
Manhours				■			■	■
Summary report		■	■	■		■	■	■
Resource report		■						
Activity report				■	■	■	■	■
Histogram		■					■	
Cash flow curve		■					■	
6. Report processing								
On the screen	■	some	■					some
To a disk file		ASCII			DIF	DIF	ASCII	ASCII
Save report specs		■	■					
7. Data updating								
Network on screen				■	■	■		■
On-line help		■			■	■		
What-if processing	■		■		■		■	■
8. Cost	\$300	\$695+	\$199	\$395	\$395	\$285	\$800	\$295
Manual/demo	none		25	25	free	40	50	30/30
Number sold	not avail.	3,000	not avail.	1,000	4,000	2,500	1,295	12,000

Software program features compared

project and see which activities become critical.

Progress is reported in three ways. The most versatile is by remaining duration, since it permits the duration of an activity to be reset continually, even beyond its originally scheduled completion. The four packages incorporating this feature are PertMaster, MicroGantt, PMS-II and Milestone.

The least versatile method of progress reporting is by completed activities. It induces errors if many activities last a long time.

The third method is by percentage of completion. Only PMS-II permits progress reporting by remaining duration, percentage of completion and actual dates.

ACTIVITY REPORTS

Since most networks developed by a design firm are not for the personal use of a project manager, the package should enable the schedule to be communicated to all members of the design team. Essential information includes the early and late start and finish dates and the float time. They form the basis for scheduling individual activities and for determining the impact of changes to the network since the last progress report.

Only MicroGantt fails to provide any of these reports; MicroPert misses only on the float time. All packages provide an activity status report.

The ability to sort data highlights problems and organizes activities in a next-to-do order. Marking activities "critical" or "late" is the usual way to indicate their status.

Selective reporting also can assist in breaking the network into groups of activities for which specific members of the design team have responsibility. The addition of a group code to each activity, defined as responsibility code, can be used for sorting and selective reporting of scheduling data. Such features allow a very large network to be scaled to individual needs.

Some packages summarize the most important dates within the network—the milestones. This helps review progress quickly.

The best way to understand the relationship of activities is the Gantt chart. It is a time-scaled bar chart showing the start and finish of each activity, whether it is on the critical path, and its duration.

All packages produce Gantt charts, but each uses different symbols to represent the data. Some offer the same sorting and selective printing options on the Gantt chart as they offer with the tabular reports. The quality of the chart is important, since it will be the document most often used to present progress on the project. The clearest and best are PertMaster and PMS-II.

The logic report and logic chart present structural aspects of the network. They help find logic errors, keep track of preceding activities in the network, and verify lead or lag relationships. Logic analysis is important in complicated networks that mix activity relationships or require a large number of activities. For smaller networks, the Gantt chart will suffice to verify activity relationships.

Harvard Project Manager is the only package that displays its logic chart on both the screen and the printer. MicroPert and

Milestone also support logic charts, but display them only on the printer. MicroGantt and Milestone support neither logic charts nor reports. Only MicroPert provides both reports and charts.

REPORTING RESOURCES

Resource reports summarize the cost or hours of all resources used on a project, detail the resource used by activity, or generate individual reports by resource type.

All but MicroPert permit least cost to be specified. All except MicroPert and Harvard Project Manager specify staffing. Only MicroGantt and PMS-II permit tracking of cost, staffing and hours. An hourly or daily labor rate can be included to determine the total cost of an activity.

To visualize the use of a resource, a histogram can plot it over time or a cash flow curve can graph the accumulated dollars spent on the project. The series of resource reports and graphs can help the user modify the network when resources are limited. They can also assist in determining future resource requirements, offering a chance to reschedule difficult periods within a project.

REPORT PROCESSING

Some packages can preview reports and charts on the screen. Previewing permits a quick check on the status of an activity or resource, as well as on the format in which the report will appear on paper.

MicroPert and Project 6 offer the most comprehensive screen previews. PertMaster and Milestone permit some reports to be previewed.

An option that could prove valuable soon is the ability to exchange data with other computer programs for further processing. For example, if project scheduling information is filed in a format compatible with a spreadsheet program, then other management reports charts and analysis can be generated. The chart specifies which packages support ASCII or DIF files. ASCII and DIF are text formats, the former primarily for data-base programs and the latter for spreadsheets.

UPDATING THE DATA

The big difference in how these packages handle data updating is whether they show the results of changes as they are posted. The better packages do this on a Gantt chart, which is left on the screen most of the time. Resources also are updated as the activity changes.

This type of feedback is important if the person who is maintaining the scheduling data is also the person who is able to make judgments about the results of the changes. If not, scheduling reports will have to be printed for review before modification.

The four packages that provide this feedback are MicroGantt, Harvard Project Manager, Project Scheduler and Milestone.

"What if" analysis also depends on the ability of the program to display on the screen results of changes. The feature is powerful enough to test different scheduling schemes and see the results quickly. It is available on MicroPert, Project 6, Harvard Project Manager, PMS-II and Milestone.

Brief comparative descriptions of each of the packages reviewed, with the names and addresses of manufacturers, are given on the next page.

PICKING THE RIGHT PACKAGE

MicroPert

Sheppard Software Co.
4750 Clough Creek Road
Redding, Calif. 96002
(916) 222-1553

MicroPert, introduced in 1978, is the oldest package reviewed. It seems to be a first attempt to bring scheduling to micro-computers. It includes all the basic features a novice manager would require, but it is not easy to use. Other faults include the lack of advanced features and reporting options.

PertMaster

Westminster Software
3000 Sand Hill Road
Suite 245, Building 4
Menlo Park, Calif. 94025
(415) 854-1400

PertMaster is an outstanding, no-nonsense solution to project scheduling. All the basic and many of the advanced features are present. The assignment of resources is versatile and should be able to handle both construction and non-construction types of resources. It is the only package that supports histograms and one of only two that generate cash flow charts. It also is the only package that allows a user the choice of network representation—either activity-on-node or on-arrow.

Project Scheduler

Scitor Corp.
Suite 290
710 Lakeway
Sunnyvale, Calif. 94086
(408) 730-0400

Project Scheduler is packed with desirable features. Documentation is complete, screen layouts are quite good and options for non-standard reports are provided. Within its limit of 210 activities, this package would serve well a wide range of scheduling needs. The resource assignments can accept labor and material costs, enabling it to be used for detailed manpower scheduling or overview schedules. This is an unusual and desirable feature that it shares only with PertMaster. The only drawback is that progress reporting accepts only completed activities. The alternative is to keep revising the schedule as the project progresses.

Pro-ject 6

SoftCorp
Suite 244
2340 State Road
Clearwater, Fla. 33575
(813) 799-3984

Pro-ject 6 is best suited for overall scheduling of the major activities of a project. Its greatest strength is its versatility. It permits the user to choose what information will appear in a report. This feature is valuable because standardized reports often present too much or too little detail. Other strengths are its report options, Gantt chart and resource reports. Together, they document clearly the overall project schedule. The weaknesses of this package are its small capacity and its awkward definition of time periods. They limit the types of networks that can be planned. It also reports progress only by completed activity, which is the least desirable method and may be inaccurate for tasks that take weeks or months.

MicroGantt

Westico
25 Van Zant St.
Norwalk, Conn. 06855
(203) 853-6880

This package excels for overall project scheduling where total costs and work effort are uncertain and more important to track than dates. Its usefulness for other purposes is limited by its lack of the more traditional scheduling reports. Two unique features might make this package useful regardless of its limitations. The network consists of composite activities, each limited to 40 tasks. "Packages" of activities can be defined and tied together into a larger network. If the composite activities are standardized, a network can be constructed quickly. Other scheduling packages allow sub-networks as an option; this one requires it. The only drawback is that all the activities must be planned. The other unique feature is the detail to which actual work can be tracked. Users can specify productive hours per week, billable rates, allocation of people per activity and fixed costs per activity.

Harvard Project Manager

Harvard Software
Software Park
Harvard, Mass. 01451
(617) 456-3400

This is the newest, and at first glance, the most impressive of the eight packages.

The packaging, documentation and screen presentation are as good as the best application software on the market. Nevertheless, the most likely use is for small projects or for the personal use of the project manager. The major drawback is the lack of concise, selective reports that document clearly the progress of the schedule. Because activities are not numbered, it's difficult to locate them on a report. One format prints 91 categories of information. The most interesting report, a To-Do List, isn't organized well enough to be easily readable when dealing with more than a hundred activities.

PMS-II

North America Mica
11772 Sorrento Valley Road
San Diego, Calif. 92121
(619) 481-6998

PMS-II is adequate for overall scheduling, but it probably would work best for detailed scheduling and monitoring of time and costs. The logic chart is especially good and should be useful to the experienced project manager. Progress-reporting options are good. General report options are versatile and resource reporting is complete. The documentation explains data file layouts and methods of transferring data to other programs. Another option permits comparison of the initial schedule with actual progress. A companion package, RMS-II (not reviewed), tracks and allocates resources in still more detail.

Milestone

Digital Marketing
2363 Boulevard Circle
Walnut Creek, Calif. 94594
(415) 947-1000

Progress reporting, resource assignments and report options are more than adequate for the small size of project this package can handle. The specification of labor resources is versatile enough to be used for manpower scheduling.

Author's Note: A list of other scheduling software packages, with the names and addresses of manufacturers appears on the opposite page. Thanks to Bertrand Goldberg Associates for the use of their computer systems. — R.K.

REFERENCES

SEISMIC

Arnold, Chris and Reitherman, Robert, *Building Configuration and Seismic Design*, John Wiley and Sons, New York, 1982, 251 pgs. \$39.95.

Blume, John A., Newmark, Nathan M., and Corning, Leo H., *Design of Multistory Reinforced Concrete Buildings for Earthquake Motions*, Portland Cement Association, Skokie, Ill., 1961.

Dowrick, David J., *Earthquake Resistant Design*, John Wiley and Sons, London, 1977.

Pendergast, J.D., and Fisher, W.E., *Seismic Structural Design/Analysis Guidelines for Buildings*, U.S. Army Construction Engineering Research Laboratory, 1977.

PHOTOVOLTAICS

Allen, Patricia A., *A Bibliography of Reports by the Sandia Photovoltaic Projects*, Albuquerque, N.M. Sandia National Laboratories, 1981, \$7.50.

Burt Hill Kosar Rittelmann Associates, Research and Solar Applications Division, *Commercial/Industrial Photovoltaic Module and Array Requirement Study: Final Report*, Springfield Va. National Technical Information Service, 1981.

——— *Residential Photovoltaic Module and Array Requirement Study*, Springfield, Va. National Technical Information Service, 1979.

General Electric Space Division, *Conceptual Design and Systems Analysis of Photovoltaic Systems; Final Report*, 3 vols., Springfield, Va. National Technical Information Service, 1977, \$25.50

Gupta, Yudi, and Young, Stephen K., *Design Handbook for Photovoltaic Power Systems*, Albuquerque, N.M.: Sandia National Laboratories, 1981, \$24.00

Mahone, D.E., et al, *Study of Photovoltaic Residential Retrofits: Volume 1 Executive Summary*, 3 vols., Springfield, Va.: National Technical Information Service: 1982.

Maycock, Paul and Stirewalt, Robert, *Photovoltaics; Sunlight to Electricity in One Step*, Brickhouse Publishing, Andover, Mass., 222 pgs., \$13.00

ENVIRONMENTAL CHECKLIST

Dickert, Thomas G. and Domeny, Katherine R., *Environmental Impact Assessment: Guidelines and Commentary*, University of California at Berkeley, 1974.

Lynch, Kevin and Hack, Gary, *Site Planning*, 3rd ed., M.I.T. Press, Cambridge, Mass., 1983.

Marsh, William, *Environmental Analysis for Land Use and Site Planning*, McGraw Hill, New York, 1978.

McHarg, Ina, *Design With Nature*, Natural History Press, Garden City, 1969.

Rosen, Sherman J., *Manual for Environmental Impact Evaluation*, Prentice Hall, Englewood Cliffs, New Jersey, 1976.

Urban Land Inst. and ASCE, NAHB, *Residential Storm Water Management, Objectives Principles and Design Considerations*, Washington, D.C., 1975.

U.S. Dept. of Agriculture, Soil Cons. Service, *Environmental Do's and Don'ts on Construction Sites*, Misc. Pub. #1291, 1974.

U.S. Geol. Survey, *Nature to be Commanded*, Geol. Survey. Professional Paper 950, Washington, D.C., 1978.

OWNERSHIP TRANSITION

Alberts, William W. and Segall, Joel E., *The Corporate Merger*, University of Chicago Press, Chicago, Ill., 1966, 287 pgs.

Bierman, Harold Jr. and Smidt, Seymour, *The Capital Budgeting Decision*, 4th ed., MacMillan Co., New York, 1971, 420 pgs.

Burke, Frank M. Jr., *Valuing a Business—The Analysis and Appraisal of Closely Held Companies*, Dow Jones-Irwin, Homewood, Ill., 410 pgs., \$42.50

Jean, William H., *Capital Budgeting: The Economic Evaluation of Investment Projects*, International Textbook Co., Scranton, Pa., 1969, 93 pgs.

Jurek, Walter, *How to Determine the Value of a Business*, Quality Services, Inc., Stow, Ohio, 1977.

Martin, Thomas J., *Protecting Your Business*, Holt Rinehart and Winston, New York, 1980, 192 pgs.

——— *Financing The Growing Business*, Holt Rinehart and Winston, New York, 1980, 350 pgs.

——— and Gustafson, Mark R., *Valuing Your Business*, Holt Rinehart and Winston, New York, 1980.

Merrett, A.J., and Sykes, Allen, *The Finance and Analysis of Capital Projects*, John Wiley and Sons, New York, 1963, 544 pgs.

SOFTWARE

Other project scheduling packages include:

Microplanner

Gateway Systems
2271 Union St.
San Francisco, Calif. 94123

Pathfinder

Morgan Computing Co.
10400 N. Central Expressway
Dallas, Texas 75231

VisiSchedule

VisiCorp
2895 Zanker Road
San Jose, Calif. 95134

Jobtrax

Omicron Software
57 Executive Park
Atlanta, Ga. 30329

Demi-Plan

Demi-Software
6 Lee Road
Medfield, Mass. 02052

The Project Manager

Misol, inc.
10317 Lakecreek Parkway
Suite 1, Building H
Austin, Texas 78750

Project Manager

Microsoft
10700 Northrup Way
Bellevue, Wa. 98004

ETI Project Control System

ETI
5848 Executive Drive
Lansing, Mich. 48910

MANAGEMENT

Surveys show A/E firm overhead now exceeds 160%

OVERHEAD COSTS FOR A/E firms currently range from 160 to 170 percent, according to a survey of 74 firms using the Computer-based Financial Management System (CFMS) developed by Harper and Shuman, Inc.

Although the average overhead rate of 165 percent is slightly lower than last year's rate of 169 percent, it is substantially higher than the rate of 100 to 120 percent that prevailed before the advent of automation in the early 1970s, according to Neil Harper of the Cambridge, Mass., consulting firm.

Among the major findings of the survey:

- The median-sized firm employs 42 people. One in 10 staff members is a principal. The ratio of principals and technical staff to non-technical workers is four to one. The ratio for 1982 was three to one. The consultants attributed the improvement to increased workload as the recession ended and to a corresponding increase in technical employment.

- Principals bill their time at a median rate of \$28 an hour (\$56,000 a year), an increase of 5 percent over 1982.

- Payroll taxes, insurance, and other miscellaneous out-of-pocket benefits account for about 19 percent of all office salaries. Average annual paid time off is nearly 26 days a year, 10 percent of total work days.

- The direct personnel expense ratio—the ratio of labor costs plus all benefits to the cost of actual time worked—is 1.33, virtually unchanged since 1981. This ratio shows that for every dollar of time costed to a project, \$.33 is paid for benefits.

- The average overhead rate of 165 percent is slightly lower than last year's rate of 169 percent.

- An analysis of responses to questions about labor costs spent in each phase of a job suggests that pre-design and site analysis, and post-construction and supplemental services should not be provided without additional compensation.

- It takes approximately \$24,000 of capital investment to support each employee, and this amount is likely to rise as design professions increase their use of automation.

- The average technical employee yields \$59,000 in net fees.

- It takes an average of 74 days to collect invoices.

- The average 1983 profit margin of three percent is an improvement over last year's two-and-a-half percent, reflecting an improvement in the economy.

Harper attributed the increase in overhead charges to more accurate reporting, increased marketing cost due to competition, higher capital costs for automation, and a decrease in the costs over which overhead is applied.

Fifty-three CFMS users from every region responded to the survey, the seventh conducted by the consultants. Because the responding firms use a common reporting system, the statistical quality of the results is high, Harper said.

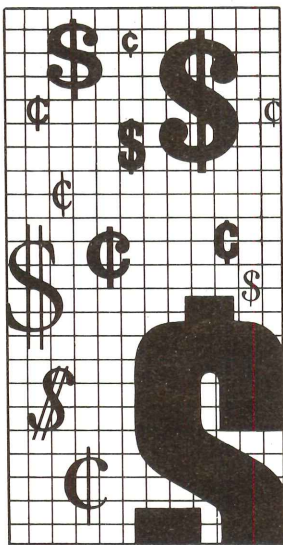

TYPICAL RATIOS OF LABOR COSTS FOR ARCHITECTURAL SERVICES

	MINIMUM	MAXIMUM	AVERAGE	MEDIAN
Predesign	0.02	15.40	5.28	3.54
Site Analysis	0.00	3.98	1.64	1.70
Schematics	0.03	18.60	10.64	10.60
Design Development	9.70	32.52	15.96	13.16
Construction Documents	30.50	52.80	40.99	40.55
Bidding/Negotiation	0.00	6.60	3.09	3.10
Constr. Administration	8.00	43.30	22.13	18.70
Post Construction	0.00	9.00	1.71	0.75
Supplemental Services	0.00	8.80	3.48	2.26
Predesign/Site Analysis	0.58	20.00	6.83	5.30
Schematics/Design Development	8.50	45.00	23.66	24.80
Construction Documents	30.00	54.90	43.24	42.45
Bid/Negotiation	0.30	12.00	4.54	4.60
Constr. Admin./Post Constr.	8.80	41.00	24.88	23.20

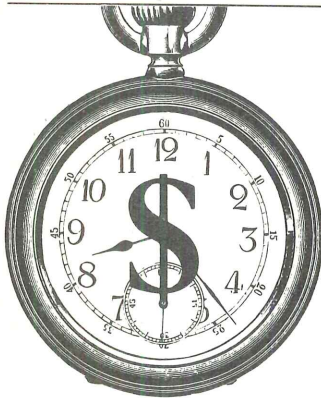

TYPICAL HOURLY RATES OF PAY FOR ARCHITECTURAL FIRM PERSONNEL

(in dollars)	MINIMUM	MAXIMUM	AVERAGE	MEDIAN
Secretaries & Clerical	4.65	10.35	7.39	7.50
Bookkeeping	6.50	18.79	10.33	9.45
Draftsman/Jr Technical	5.20	12.61	8.71	8.50
Architects/Engineers	8.77	21.30	13.07	12.50
Project Managers	10.00	26.21	16.50	16.16
Principals Job Costing	15.86	100.00	32.84	27.80
Principals Annual Bonus	0.00	48.00	12.00	10.38

“Management by Textbook” won’t guarantee success

A survey of 500 architectural firms found that the use of recognized management techniques made “no significant difference” in the success of the practice.

William D. Murry, an architect with the Atlanta firm of Thompson, Ventulett, Stainback and Associates, drew this conclusion from his analysis of a statistically significant 55 percent response to questionnaires sent to firms nationwide ranging in size from 10 to 100 employees. The survey was conducted as part of graduate work at the Georgia Institute of Technology.

The survey asked practitioners whether they used such standard management practices as planning, the communication and review of goals, performance appraisals, marketing, policy manuals, and organizational charts. Only in their use of performance appraisals did the firms classified as “most successful” differ in any statistically significant way from those listed as “least successful.”

Organizations were rated “most success-

ful” if they added employees and increased revenues in 1982, a recession year, and if they had a productivity ratio (gross receipts divided by number of employees) in the top third of all firms returning questionnaires. A firm was considered “least successful” if it lost employees and revenue in 1982 and had a productivity ratio in the bottom third of the responding firms.

If management techniques are not reliable predictors of success, to what can success in the practice of architecture be attributed?

High achievement, Murry says, could be ascribed to such virtually untestable qualities as vision, responsiveness, clarity of purpose, utilization of resources, and quality of leadership.

Murry closes his analysis of the survey, made in collaboration with Atlanta management consultant Kathleen Underwood, with this caveat: “Be wary of global statements extolling management practices as the cause of economic success.”

AIA/SC Plans Regional Buying Directory

A new regional specifying and buying directory for architects and related building industry professionals will be produced by Pactel Publishing, a subsidiary of Pacific Telesis Group, as part of a joint publishing venture with The AIA Service Corporation (AIA/SC).

The directory will be called *MASTERGUIDE: The Specifying and Buying Directory of the American Institute of Architects*. Designed to be a comprehensive reference source for information on building product manufacturers and distributors, the directory is scheduled for publication in the spring of 1985.

The AIA’s new specifying and buying directory will be published annually in four separate regional editions: Northeast, Southeast, Central and West. It will be organized much like a “yellow pages” directory, with listings of manufacturers’ names, addresses and other pertinent information. Data will be structured into more than 700 heading categories familiar to the industry. Also included will be an alphabetical section of manufacturers, a key word index and a product trade name index.

The development of *MASTERGUIDE* has been supported by market research, including focus groups of architects conducted nationwide, and an advisory group of AIA members. The research identified the need for a publication that would complement and enhance coverage already provided by other reference sources. The publication will fulfill a market need which is currently not being satisfied. The *MASTERGUIDE* regional focus will make it more useful than existing national product directories. All qualified manufacturers will be offered a free listing in the guide.

Experts in the directory publishing field, Pactel has produced similar specialized

Practice Commission developing Compensation Action Plan

The AIA Practice Commission is developing an implementation program based on the report developed by the special Architects Economics and Compensation Task Force appointed by former President Robert Broshar in June 1983. The program will be presented to the AIA Board of Directors before the pre-convention meeting in May 1984.

Broshar had asked the task force to investigate the problem of employee compensation and the declining profitability of architectural practice, and to develop a strategy to deal with this crucial issue. The task force presented its report and recommendations at the December 1983 Board of Directors meeting.

continued on page 78

Buying Directory

industry directories. The AIA/SC publication would be the first such directory for the construction industry, however.

AIA members will be sent one regional edition of *MASTERGUIDE* free of charge. The publication will also be distributed to selected commercial contractors, engineers and designers. Additional copies will be made available for purchase from the AIA Service Corporation.

For additional information contact Marianne Bohr, AIA/SC, 1735 New York Ave., N.W., Washington, D.C. 20006, (202) 626-7585.

COMPUTERS

AIA/SC Developing Software Package

A PROTOTYPE OF THE FIRST FULLY integrated family of computer programs for small and medium sized architectural firms is expected to be demonstrated along with *MASTERSPEC* at the AIA Convention in Phoenix May 5-9.

The AIA Service Corporation is currently involved in the research and development of a new computer software package to be marketed as *MASTERWORKS*.

MASTERWORKS is being developed to run in color on widely available microcomputers, such as the IBM XT, Corvus, DEC Rainbow, Wang PC and others. The system comprises five integrated modules: a management/accounting module that incorporates a unique three-dimensional business graphing capability; a sketching module that allows wire frame models to be created in 3D and to be viewed in perspective; two drafting modules—one two-dimensional and the other three-dimensional; and another module that links all the other modules together. The AIA Service Corporation is obtaining a review and evaluation from experts in the field including architects, accountants, and members of the AIA Computers in Architecture Committee, and independent software experts. After *MASTERWORKS* is put through extensive Beta testing, it will be marketed on a nationwide basis.

The AIA Service Corporation has been pursuing the development of integrated user friendly software systems by direction of the AIA/SC Board of Directors in action taken in 1983.

Computer Questions Sought

ARCHITECTURAL TECHNOLOGY will launch a new computer question-and-answer column in the next issue.

Readers with questions relating to computer applications are invited to submit them to the managing editor. Short answers will be published to those questions that seem to be of interest to the greatest number of readers.

RESEARCH

AIA seeks research and design papers

The AIA is seeking papers and exhibits for "Research & Design 85: Architectural Applications of Design and Technology Research," a conference to be held in Los Angeles, February 21-25, 1985. Otis Elevator is providing support for the conference through the AIA Foundation.

"Research & Design 85" is the first in a series of events the AIA will convene to disseminate results in 25 areas of research identified as most pressing by the Architectural Research Council. The Council was established by the AIA Foundation in 1982.

Papers are sought on such subjects as energy; life safety; the design of specialized facilities (such as health care, educational, and correctional facilities); and the effects of environmental trends on the built environment. Exhibits may display innovations in building technology, design manuals, or research in progress.

For submission deadlines and further information, see the call for papers on page 34 or contact Kim Leiker at the AIA Foundation (202-626-7560). The conference program and registration procedures will be available in August, 1984.

Building industry groups set energy research priorities

As part of its efforts to continue a dialogue between the public and private sector on building energy research, the Department of Energy recently met with the American Institute of Architects, the American Society of Heating, Refrigeration, and Air-Conditioning Engineers, the Electric Power Research Institute, the Gas Research Institute, the National Association of Homebuilders Research Foundation and the U.S. House of Representatives

Science and Technology Committee to discuss directions and priorities for research on energy efficient buildings. This meeting, known as Building Energy Research Workshop II, was held February 14-16 in Cockeysville, Md.

Against the backdrop of the recently released FY 1985 DOE budget, the participants, many of whom participated in the first workshop held in Carmel, Calif., reaffirmed their support for whole buildings research—even though DOE has proposed to discontinue this research next year. Criticizing DOE's piecemeal approach to planning its buildings programs, participants pointed out this research can help DOE select research with the highest potential payoff in energy savings. Pointing to the success of DOE's current project on small office buildings, Harrison Fraker, chairman of the AIA Energy Committee, stressed that this analysis, because it demonstrates the effectiveness of alternative energy saving strategies, is of great value to both architects and homebuilders.

Citing their dissatisfaction with DOE's research priorities and a lack of coordination with the private and public sectors, many participants stressed the need for more industry participation in all phases of DOE's research program. Noting that the national laboratories have a significant role in planning the research they execute, participants called upon DOE to establish mechanisms that would solicit input from the building industry on a "regular and coordinated basis."

Regarding technology transfer, the group recommended that DOE use established mechanisms, such as trade and professional associations, as the basis for its technology transfer activities. Although this point has been repeatedly made, DOE, in its FY 1985 buildings conservation programs, proposes spending \$3.5 million on two unproven strategies; an "Energy Efficient Buildings Center"—an exhibit and data center for buildings research—and a fellowship program that would allow university researchers and others to spend time at the national laboratories. At the same time, DOE would like to spend only \$1 million on working with trade and professional associations, like the AIA, NAHB and ASHRAE.

—Mary Ann Eichenberger

LAW

If it's not in writing . . . is it still a contract?

ARCHITECTS ARE SO diversified that they can no longer rely on customs, established fee schedules, or codes of ethics to fix the terms of an agreement between the architect and the owner. Nor can they look to such conventions for enforcement of agreements. A proper contract is vital.

Although more difficult to prove, oral contracts are just as valid as written ones. Express contracts may result from an oral or written agreement. Implied-in-fact contracts are those in which the parties demonstrate their agreement, although there has been no express oral or written statement. Finally, quasi-contracts (not true contracts at all) are implied-in-law agreements based on principles of equity.

To be valid, express agreements usually require that parties intend to contract and come to a meeting of the minds through a bargained-for exchange—an offer and its acceptance. The agreement must identify the parties, define the subject matter, establish the time for performance, and specify the price. And these terms must be stated with “reasonable certainty.”

If a court interprets and enforces the agreement, the result may be quite different depending on whether an essential term is left out totally or is merely indefinite. For example, if no price is stated, a court may imply that a “reasonable” price based on fair market value was intended. However, if price terms are included, but are stated indefinitely, the court likely will find that no contract exists.

An example of imprecise wording would be: “The architect’s basic compensation shall be no more than 8 percent of the construction cost of the project.”

Some flaws in the language of the agreement may be remedied by partial performance of work that shows what was intended by an indefinite term, or by reference to a continued course of dealings between the parties. Custom in the industry may also be of help, but with the wide range of

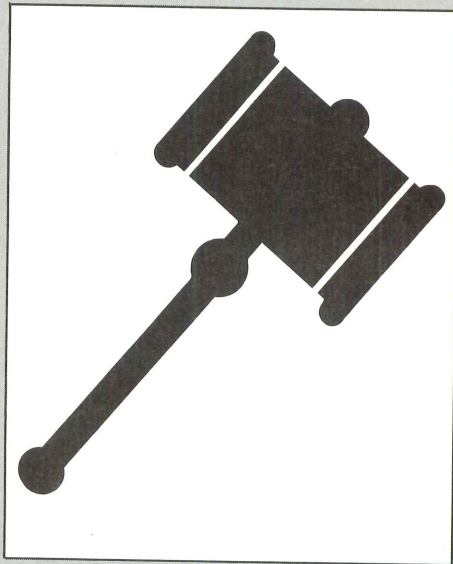

arrangements that are common today, custom may be hard to determine. The safer course is to be definite in the statement of all agreements.

Many legal questions grow out of another common situation. In a typical instance the owner and architect discuss the project, the required services, and the fee and schedule considerations.

Then the architect begins to perform services without written agreement. Perhaps the discussions have been definite and have covered the pertinent points. If so, a valid oral agreement probably exists. Perhaps the salient points have been documented in a letter or a series of letters or memoranda that may comprise a valid written agreement. Perhaps the parties have discussed signing a more formal agreement “on an AIA Document when it is prepared,” or “after my attorney looks at it,” or under other circumstances.

Are the parties presently bound or will they only be bound upon execution of the formal document? A lot depends on the intention of the parties, but other factors are indicative. Do the writings indicate “bargaining” only? Has performance begun? How complicated are the project and the nature of the agreement? How

sketchy is the initial writing? Are detailed, formal agreements common in the industry? The trend today is to find an effective early agreement if possible. However, if analysis indicates that the parties were not to be bound until the formal document was signed, then the early performance by the architect may be on a quasi-contract or “equitable” basis only.

The AIA discourages letter agreements. Such agreements are typically inadequate compared to the published AIA documents. They are unlikely to have covered important issues such as the obligations of the owner (other than to make payments); dispute resolution provisions, allocation of risk (via insurance and otherwise); which expenses—including which consultant’s charges—are reimbursable; who owns the documents; and suspension and termination of services provisions. Certainly it is even less likely that these issues have been discussed and resolved in an oral agreement.

It is not realistic to believe that architects will suddenly begin to withhold services until a formal, comprehensive agreement is executed. That being so, the general principles discussed above may be valuable guides to many architects. To the extent that an agreement is clear and both parties understand and are committed to it, they may be less likely to breach the agreement. There are very few magic words or procedures, but attention to basics will aid in forming valid contracts, and comprehensive, even-handed record-keeping will aid in proving that those contracts exist. Comprehensive records will also help show what the contracts cover and assist with enforcement by third parties if necessary.

— Charles R. Heuer, Esq., AIA

Charles R. Heuer is an architect and attorney with The Architects Collaborative in Cambridge, Mass.

DESIGN

Historic Buildings Survey: Valuable tool for architects

A severe hurricane swept through Mobile, Ala. in 1979, severely damaging the 1858 Greek Revival city hall.

Fortunately, the Historic American Buildings Survey (HABS) had documented the national historic landmark with measured drawings and photographs. Mobile architect Nicholas H. Holmes Jr., FAIA, commissioned to oversee rehabilitation, found the HABS drawings an invaluable resource. The city government moved back in January 1983, and the Alabama Council of Architects/AIA honored the project later that year with an award for excellence.

In 1972, a group of Maine carpenters launched a speculative housing venture using post-and-beam construction techniques from the late 18th and early 19th centuries. They adapted the techniques from measured drawings of timber-frame homes of the period stored in the HABS collection. Library of Congress archivists recall receiving repeated requests for drawings of timber-frame houses in the year following completion of the Maine builders' project.

THESE ARE BUT TWO examples of how practicing architects use documentation from over 17,000 historic structures and sites stored in the HABS archives and the related Historic American Engineering Record Collection. Any practicing architect whose work embraces old buildings may profit from the wealth of material in HABS, as well as the other architectural and engineering materials in the Prints and Photographs Division of the Library of Congress, a resource that is available to the public.

If a HABS-documented building is undergoing restoration, or if only a prototype is needed for a missing piece of ornamentation on an old building, access to these collections could save a lot of work or time, provide appropriate instruction on a "correct" detail, or even inspire a post-modernist creative frenzy.

HABS, which is observing its 50th anniversary, is the only surviving project of the Depression-born Works Project Administration, according to C. Ford Peatross, curator of the HABS collection.

In 1933, the Interior Department's National Park Service hired architects and draftsmen idled by the slump in private construction to measure and record the dimensions of architecturally and historically significant buildings. Then, as now, the AIA advised HABS officials through its Committee on Historic Resources (then called Historic Buildings Committee).

The Library of Congress was made the repository for the measured drawings, photographs and written information produced by the program. After economic recovery, summer interns, many of whom were architecture students, increasingly took over the work of architects and draftsmen. Today, HABS drawings are produced almost exclusively by students. In 1969, in cooperation with the American Society of Civil Engineers, the Park Service founded the companion program, the Historic American Engineering Record (HAER).

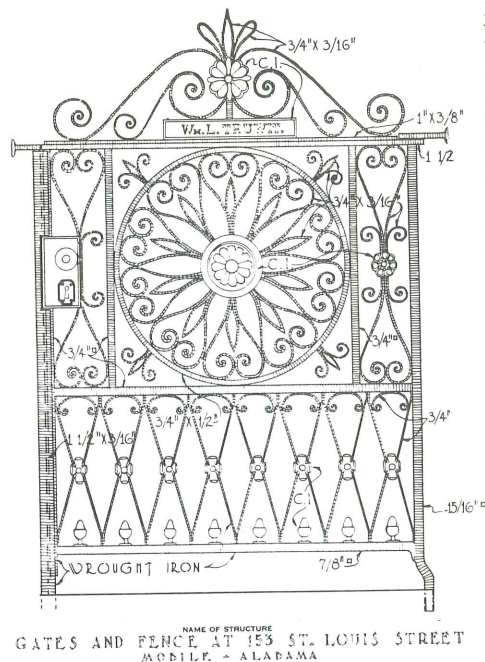

NAME OF STRUCTURE
GATES AND FENCE AT 153 ST. LOUIS STREET
MOBILE - ALABAMA

The HABS and HAER collections are in the Prints and Photographs Division of the Library with four other potentially useful collections of architectural materials: The "American Drawings Collection" contains original drawings by American architects—typically those considered nationally significant—through the 20th century, particularly the early 19th century. The "Pictorial Archives of Early American Architecture" contains 10,000 photographic negatives, principally of pre-1850 buildings of the northeastern United States.

The "Carnegie Survey of the Architecture of the South" totals 8,000 prints and corresponding negatives by photographer

Frances Benjamin Johnston, commissioned between 1930 and 1943, including interior and exterior views. The "Seagram County Court House Archives" has 8,000 photographs and 11,000 negatives of county courthouses taken between 1974 and 1976.

Photocopies of most of the documents and photographs of buildings from all of the collections are available. Full-sized mylar or polyester film reproductions are available for the HABS and HAER drawings. Librarians can provide a current list of reproduction prices and processing times.

The Library of Congress has a list of local libraries and historical societies that have purchased the collection on microfilm. "HABS User Notes," a paper edited by HABS staff architect John A. Burns, AIA, describes the sizes, formats, and degree of accuracy a serious researcher can expect from the drawings.

Since the lists of HABS documents and sites are now in a computer data base, it is conceivable that they may one day be available on some type of software that would permit their display on computer terminals in the drafting room.

"Historic America: Buildings, Structures and Sites," published last November by the Library of Congress to commemorate the 50th anniversary of HABS, provides a good first point of reference for researchers. This volume, on sale for \$29 at the Government Printing Office or Library of Congress Information Center, contains essays on documentation practices edited by Peatross and a checklist of documented sites, alphabetically listed within state and county.

Mary M. Ison, a reference specialist at the library, assists Peatross in responding to inquiries about the HABS collection. Correspondence should be addressed to Library of Congress, Prints and Photographs Division, Madison Building, Room 337, Washington, D.C., 20540. The telephone number is (202) 287-6399.

Inquiries about the HABS computerized lists, which are continuously updated, should be sent to Ellen Boone of the HABS staff at the National Park Service, Washington, D.C. 20240, telephone number (202) 343-9599.

—Richard Van Oskeuls

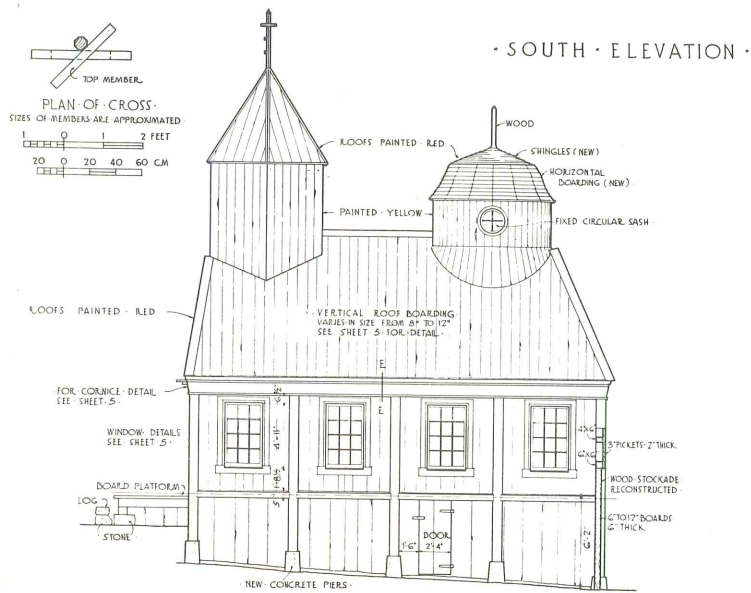
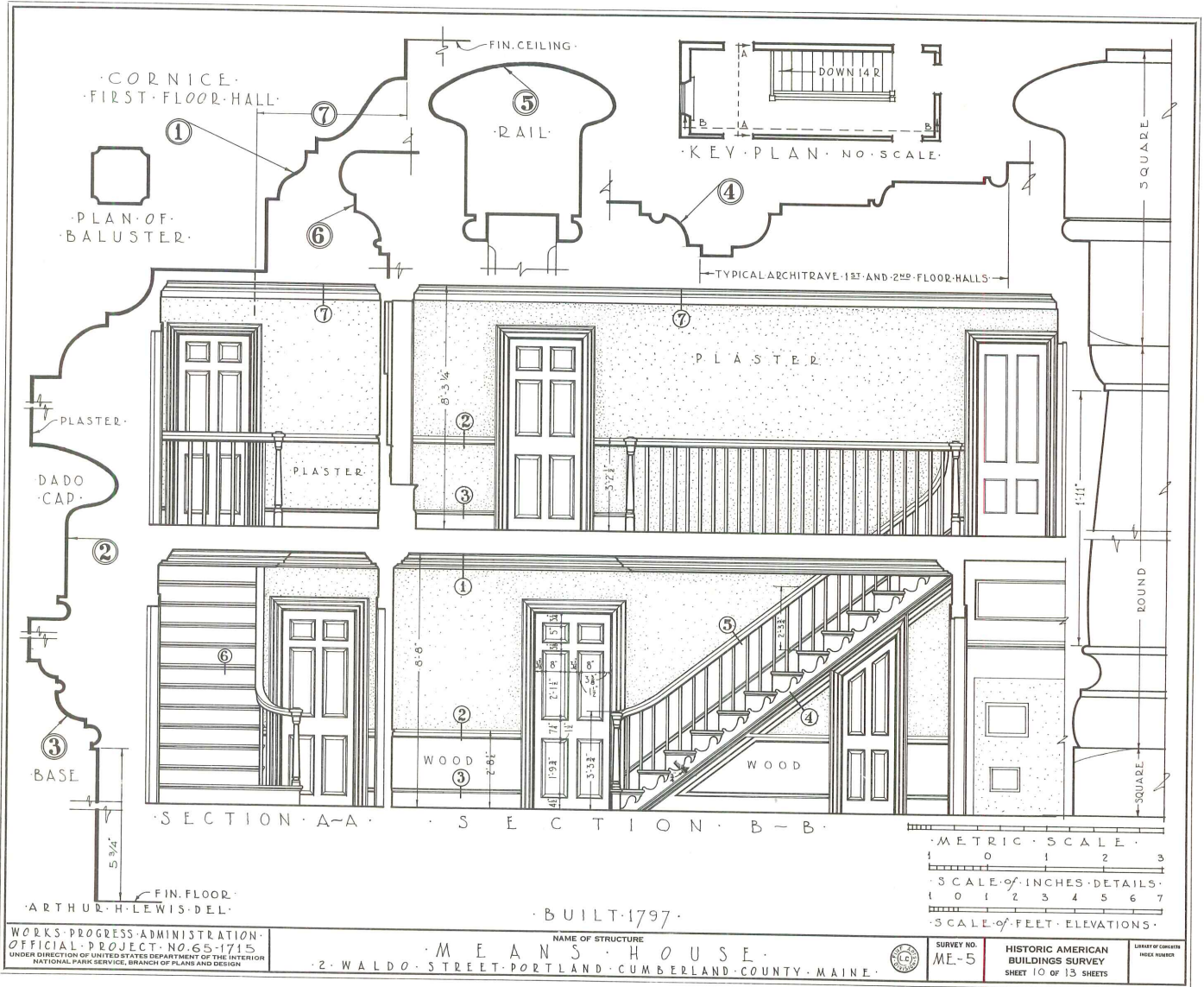

These drawings and the one on the opposite page are from the Historic American Buildings survey collection now stored in the Library of Congress. Architects can use the drawings to check details for restoration or reproduction projects.

CODES & STANDARDS

Codes and Standards Papers

IN RESPONSE TO THE AIA Board of Directors charge to the Codes and Standards Committee to investigate various major codes issues in 1984, the Committee solicited papers on those issues from design-related professionals.

The papers, submitted as part of the Committee's "Technology Talks" conference last October in Chicago, addressed such topics as elevator design in high-rise buildings, fire safety systems, hazardous industrial design, building rehabilitation and code conflicts.

The following stories summarize a selection of the submitted papers. Copies of the papers are available through the AIA Codes and Standards Dept., (202-626-7566).

—Steven Greenhut

Code Consistency

A computerized word index and thesaurus for code interpretation and development is needed to promote consistency among the nation's model building codes, according to architectural researcher M. Stephanie Stubbs of Washington.

Developing a key word index/thesaurus will eventually enable computerized access to design criteria in the codes, Stubbs wrote in a paper titled "Code Consistency for Building Redesign" presented at the Chicago conference. She said such a system could control such problems as rapid turnover of code information, regional variations, and the lack of consistency among code definitions, which presently hinder code consistency.

Stubbs and her associates, Howard Coleman and William Brennehan, are seeking funding for a three-phased program for making codes affecting building redesign more consistent.

Phase I of the program would launch a pilot project in one code jurisdiction. Existing data bases would be examined and a preliminary word index/thesaurus would be developed. The thesaurus would be tested on a project involving an existing building.

A technical review panel comprised of architects, building officials, and others would be selected during Phase I to discuss project findings and future applications.

Phase II of the project would involve indexing all three model codes and the National Fire Protection Association Life Safety 101 Code. During this phase, a system for cross-indexing the codes in a computerized data base, and an access system, would be developed.

Phase III would consist of private sector applications of the project.

The word index/thesaurus could also improve the code education process for architects and building officials, reduce delays in the construction process, encourage development of redesign building standards, and facilitate communication among architects, building officials, owners, and developers, Stubbs said.

3 R's: Rehabilitation-Retrofit-Recertification

Code conflicts in projects involving rehabilitation of historic buildings can be resolved "through a logical approach or through simple communication and coordination with all of the disciplines and professionals involved. . . ."

This is the analysis of interior designer Roger Hoffman, ASID, in his paper, "The Mansion House Project."

According to Hoffman, there is no area in construction where code conflicts are as prevalent as in historic rehabilitation and retrofit. Hoffman's paper focuses on the Mansion House Project which, he said, "is a very representative type of project showing code conflicts."

Originally called the Mansion House Hotel, the wood frame structure was built in Watsonville, Calif. in 1871. In 1913, the hotel was moved to a different site in the same town and the ground floor was divided into several small store fronts.

After resolving a conflict regarding the use of the building's original trim, Hoffman's firm was presented with what he describes as "a classic code conflict."

The Office of Historic Preservation ruled that the facade could not be restored to its 1871 condition, as planned, but had to be restored to look as it did in 1913 after the building was moved. That was a problem because—with glass storefronts that existed in 1913—it was impossible to provide adequate structural support. Also, the local historical association, which had an easement on the property, stated that it had to be restored to its 1871 condition—providing a "Catch 22" situation.

This code conflict, and conflicts regarding the building's balcony and placement of the ductwork, were resolved with negotiations and finally with an appeal to the Interior Department. The building was then

certified and placed on the national register.

According to Hoffman, the project succeeded because of negotiations and the application of logic in the interpretation of the codes.

"Codes really need to be looked at more as standards or guidelines. Then the conflicts can be eliminated and the basic intent of the philosophy and all the codes can be met," Hoffman said.

People in High Tech Workplaces

Modern industrial buildings often pose health and safety hazards to their employees because of insufficient natural light, few openings to the outside world and a disregard for natural air movement, said Marvin J. Malecha, AIA, dean of the California State Polytechnic University School of Environmental Design.

In his paper, "People in the High Technology Workplace," Malecha emphasized the importance—in economic and human terms—of designing buildings that provide a healthier, safer and more stimulating environment for their inhabitants.

The high technology industrial parks that surround American cities are examples of a building type where codes often do not apply or are easily subverted, according to Malecha.

These buildings tend to have poor illumination, environmental controls, signage and organization. Often, they provide noisy work environments that are not designed for human comfort and health. These building problems tend to be a major cause of employee illness and absenteeism, he said.

"While the master builder of medieval times experimented with a single material over time, we are faced with an almost incalculable number of options. As a result modern buildings pose a number of new materials, systems and health problems," said Malecha.

According to Malecha, greater use of synthetic materials, increased size and bulk of buildings and energy conservation methods that limit windows and air circulation all contribute to new health, safety and comfort problems in the workplace.

What is needed to create safe and healthy working environments, concluded Malecha, is "common sense design" and a comprehensive process of building diagnosis and evaluation. This process may also "provide the necessary information base for the legal concerns of regulation, liability, and litigation."

Elevator Design for "Flex-Time"

The current method for analyzing the performance of elevators in high-rise buildings, used for the last 50 years, makes no recognition of changes in individual and corporate work habits or in the technology of elevator control systems.

This is the message of architect Steven D. Edgett of Skidmore, Owings & Merrill (San Francisco) in his paper "Elevator Myths and Realities" presented at the AIA's 1983 Codes and Standards Conference Oct. 7 in Chicago.

According to Edgett, the "up-peak" method for determining the efficiency of elevators in transporting people, while still providing some useful information, is outdated and should be eliminated. The system is used primarily to help architects and builders determine which elevator design should be used to meet the building's needs.

"The up-peak analysis is based on a rather simple calculation which presumes that a constant stream of persons will enter the building during the morning peak traffic period, that these persons will crowd willingly into an elevator car, and that no one is using the elevators for interfloor or down traffic during this period," said Edgett.

The system calls for the calculation of the time it takes an elevator to move a variable number of people to the top of the building and return to the ground floor, taking into consideration the number of elevators, floors and tenants.

Developed at a time when most office employees punched timeclocks and were required to begin work at exactly 9:00 am, the "up-peak" method analyzes the efficiency of a building's elevators solely on the "up-traveling" activity between 8:45 and 9:00 am.

However, with "flex-time" and other changes in the working environment, a more comprehensive review of elevator performance is necessary. "No longer can we assume that the elevator system that satisfies the actual morning traffic will provide acceptable service through the remainder of the day," said Edgett.

Computer systems have been developed that, unlike the up-peak method, calculate elevator use patterns throughout the day and take into consideration average waiting times.

"Given accurate population models and realistic definition of the type of tenancy

expected for the building, computer modeling of elevator systems can give us far more accurate appraisals of the quality of elevator service . . .," said Edgett.

According to Edgett, these new computer methods of analysis have set the stage for elevator systems that are well integrated for the needs of high-rise building occupants.

Codes Director calls for Info Management

The AIA Codes and Standards Committee is doing all that it can to monitor and disseminate regulatory data to architects but — because of the immense volume of information — their efforts are still not enough, according to AIA Codes and Standards Director Joel H. Vicars III.

The committee, with its 100 members and 15 subcommittees, is simply unable to accomplish all that needs to be done, Vicars said. Although increased participation by architects in the committee and in the entire codes and standards process would be very helpful, it would not provide a solution for the entire problem.

The American Society for Testing and Materials (ASTM)—one of the nation's three building standards organizations—holds hundreds of meetings each month concerning standards ranging from hazardous substances to plastic piping systems, and the architectural profession must monitor those activities. More than 350 proposed changes were submitted in 1984 to the Basic Code of the Building Officials and Code Administrators (BOCA)—producers of one of three U.S. model codes.

The architects that participate in the codes committees—being employed full-time—cannot devote enough time to digest all the data available, Vicars said. Also, participating in the process costs time and money. Traveling to the meetings is expensive and the time spent traveling is usually unbillable. These expenses can rarely be afforded by the smaller firms, Vicars said.

According to Vicars, building material and product data needs to be placed in a clearinghouse—like the Architecture and Engineering Performance Information Center (AEPIC) that opened last year at the University of Maryland—to provide codes and standards information to the profession.

Providing architects with data on the products that are used in building design, Vicars said, will give them a better understanding of the materials they are using and the liability involved.

AEPIC to meet at AIA

The Architecture and Engineering Performance Information Center, which collects, analyzes, and disseminates information about the performance of structures, will hold its international meeting May 21 and 22 at AIA headquarters.

Founded in 1982 by the School of Architecture and the College of Engineering at the University of Maryland, the center's goal is to improve the design, construction and performance of buildings and civil structures.

John Loss, AIA, Director of Architecture and Technical Services, said AEPIC will collect and make available computer-based data on all aspects of problems arising in such areas as the building envelope, structure, mechanics, electrical systems, moisture barriers, economics, and environment, as well as thermal, acoustic, visual and behavioral dysfunctions.

While the center's headquarters and national repository are at the University of Maryland, several international repositories also are being developed. The most advanced are in Canada and the United Kingdom.

Before AEPIC, Loss said, "reports of performance failures were filed in . . . isolated storage throughout the world. No centralized source of data on performance was available."

International development of AEPIC should lead to fewer performance failures and confrontations in the courts, improved development of codes and standards, and a reduction in insurance premiums, Loss said.

He said it is reasonable to expect that eventually the normal procedures in the process of design analysis will include a summary of AEPIC data for the building, structure and material types contemplated.

Annual memberships in AEPIC are available for \$100 for individuals and \$1,000 for firms, organizations and corporations. The fee structure is still under review by the advisory board and other categories are being considered.

Access to the center's data will cost an additional \$75 fee for each basic search.

Further information about AEPIC is available from Loss by writing him at AEPIC, 3907 Metzert Rd., University of Maryland, College Park, Maryland, 20742.

—Steven Greenhut

COMMITTEE NEWS

THOMAS A. KAMSTRA, AIA, chairman of the **Regional Development and Natural Resources Committee**, reports that the committee held an environmental policy workshop for architects at Wrightsville Beach near Wilmington, Del., April 12, 13, and 14. The organizer of the workshop was Conrad Wessell, Jr., AIA. Topics included shoreline and offshore develop-

ment, coastal zone management, national parks, acid rain, and toxic waste.

The AIA Foundation announces the appointment of four new members to the **Octagon Committee**, the supervisory committee that advises the professional staff of The Octagon on issues relating to its preservation and operation. Joining the committee are Maureen Quimby, Curator of Collections at the Eleutherian Mills-

Hagley Foundation; Graham Hood, Vice President and Chief Curator at Colonial Williamsburg; Robert Garbee, AIA, an architect with Fauber Garbee (Forest, Va.); and Sophie Burnham of Washington, D.C., a descendant of Col. John Tayloe III, the original owner of The Octagon. Richard L. Dayton, AIA, of Victorine and Samuel Homsey Architects (Wilmington, Del.) will chair the Octagon Committee this year.

Chairman Bruce C. Ream of the **Committee on Architecture for Justice** reports that the committee, recognizing the increase in planning for new criminal justice facilities and the growing number of architects entering this specialized field, has held one meeting and plans another to help practitioners become more knowledgeable about planning such facilities.

The meeting in Salt Lake City Mar. 8 and 9 focused on juvenile justice facilities and featured tours of several institutions in the area, including the new secure detention facility for juveniles. The committee's annual two-day conference, to be held this year in late fall in Savannah, Ga., will concentrate on the planning process involved in criminal justice facilities. Interested architects are invited to attend the seminar in Savannah.

Ream reports that this year the committee intends to update and supplement AIA's "Design Resource File," a publication that helps architects find information on the various topics involved in criminal justice architecture.

For more information about the CAJ Committee and its activities, contact Mike Cohn at (202) 626-7366.

The Professional Development Committee's primary effort in 1983 was designing a five-year plan to provide a historical perspective of the professional development program and chart its direction for the future.

The non-proprietary architect will be the focus of the professional development program in the coming five years, as will development of the Mentor Program, in which senior practitioners work with their younger counterparts in an informal interchange of information.

The Committee on Historic Resources reports that it has completed the publication of a new chapter of the "AIA Handbook of Professional Practice"—chapter C-1, entitled, "Preservation Practice." This year the committee plans to prepare a draft/abstract for another new chapter, "Adaptive Use."

All we offer are the solutions

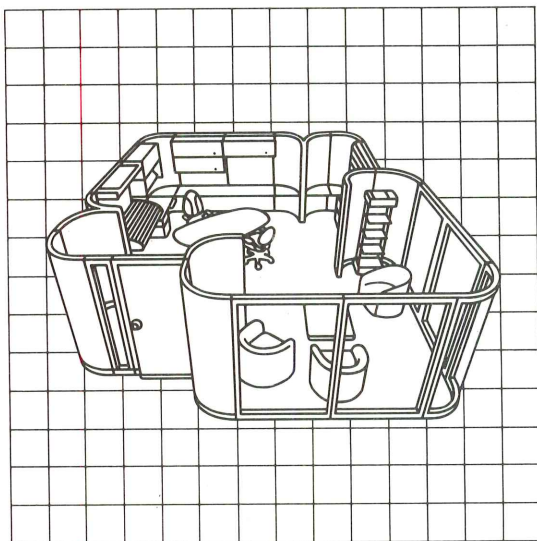

Creative Expression

HAWORTH

See us at the A.I.A.
National Convention in Phoenix
Booths 255-258

INSTANT INTELLIGENCE TEST

FOR PROFIT-MINDED BUSINESS PEOPLE.

Q. How many ways can THE SOURCE, together with ARCHNET and your personal computer, help improve your productivity, save you time, and cut your costs?

Multiple Choice:

- Lets you link your equipment with any other personal computer, terminal or "smart" word processor.
- Delivers electronic mail to and from your desk top, eliminating telephone tag.
- Automatically scans each day's business and other news and activities, and sets aside reports of specific interest to you, for review at your convenience.
- Carries out research quickly and efficiently—using the key words you specify—to search across thousands of current articles and references.
- Brings you continually updated stock and financial market reports and analyses—even tracks the news and price activity for specific stocks in your portfolio.
- Helps you form your own private communications network quickly and inexpensively, to tie together others in your company or profession.
- Lets you check current airline schedules and arrange ticketing; review hotels and restaurants in the city of your choice.
- Enables you to compose and send Mailgram messages right from your desk top terminal.
- Provides unlimited filing plus simple retrieval and transfer of information.
- Gives you mainframe power for financial modeling and business accounting procedures.
- Costs as little as ten cents a minute.

A. All of the above.

If you have a personal computer or terminal or a "smart" word processor and a modem, you're ready to use THE SOURCE, the instant intelligence network, and ARCHNET, the electronic communications and information network of the AIA. Accessible nationwide through THE SOURCE, ARCHNET provides the architect with information on AIA conferences, activities, state and local organizations, and conventions. Subscribers to THE SOURCE and ARCHNET will be able to identify potential business opportunities through ARCHNET's daily recap of Commerce Business Daily.

AIA members receive a **15% discount** on the one-time \$100 regular subscription rate to THE SOURCE.

Call our toll-free number (800) 424-5080 for more information, or mail in the coupon and we will rush you an information package and subscription material.

THE AIA SERVICE CORPORATION

MAIL TO: ARCHNET

SAT

Professional Systems Division
AIA Service Corporation
1735 New York Avenue, N.W.
Washington, DC 20006

Name _____

Title _____

Company _____

Address Business Home _____

City _____ State _____ Zip _____

THE SOURCEsm
AMERICA'S INFORMATION UTILITY

What do these top construction industry logos have in common?



This one.

CPMCM Construction Products Manufacturers Council

The nation's forum of quality construction products manufacturers.

It makes good business sense to join.

The AIA is seeking papers to be presented at **Research & Design 85: Architectural Applications of Design and Technology Research** to be held, 1985, in Los Angeles.

The conference will offer a full spectrum of state-of-the-art findings from architectural technology and design research. Papers and exhibits are invited on: *energy*—diagnostic and simulation techniques, community-scale strategies, daylighting design tools, energy-control strategies; *life safety and codes*—indoor air quality, older buildings, outdated codes, emergency management and building design, fire codes; *building re-design*—case studies of whole-building redesign strategies, component design strategies, programming, operation and control strategies, codes and standards; *design of specialized facilities*—psychological effects of design on special populations, cost estimating, staffing levels, obsolescence and reuse; *environmental trends*—acid rain, world population growth, water conservation.

SELECTION CRITERIA

The Architectural Research Council, with AIA committees and cooperating organizations, will select 100 speakers and up to 50 research- and technology-related exhibits for display at the conference based on:

- significance to architectural practice and design
- effectiveness of dissemination format
- usability in architectural practice
- research methodology

Papers of greatest impact on architectural practice and design will be the focus of conference plenary sessions. Papers and exhibits should present either new knowledge or technology, or existing knowledge that has not been readily available to practicing architects. Exhibits may display building technology innovations, new design manuals, research in progress, or other products significant to architectural practice and design. Computer installations are encouraged.

DEADLINES AND INSTRUCTIONS

Titles of proposed papers or abstracts, along with 300-word statements indicating how the papers or exhibits meet the selection criteria must be postmarked by July 2, 1984. Send abstracts and exhibit statements to: **Research & Design 85** The American Institute of Architects 1735 New York Avenue, N.W. Washington, D.C. 20006. Attn: Kim Leiker (202) 626-7560.



R e s e a r c h



The American Institute of Architects
1735 New York Avenue, N.W.
Washington, D.C. 20006
Attn: Kim Leiker

I intend to submit an abstract. The preliminary title is:

I intend to submit an exhibit proposal. The preliminary title is:

I would like to receive information on:

- the call for papers
- the conference announcement
- the conference proceedings

LOW TECH

VENUSTAS VS FIRMITAS

BY JACK HARTRAY, FAIA

I AM A PART-TIME PHILOSOPHER. EACH morning I review the options offered by life, free will, and the second law of thermodynamics. This gets me out of bed. Then, usually by lunchtime the day takes on its own momentum and I forget about the universal issues.

I confess that I have often treated architectural theory in a similarly utilitarian manner, using it to get past that depressing period when the paper was blank, but hoping that, as I learned more about a project, the constraints of site, program, codes, and construction would begin to shape the design and hide its theoretical origins. I've never liked to see traces of aesthetic dogma in completed buildings. They remind me of paintings with numbers visible under the colors, or the biscuits in which one can taste baking powder.

Recently at a meeting of the Chicago Chapter's Quality Assurance Task Force (every chapter should have one) I was reminded that architectural theory should be thought of as more than a stimulant.

We were comparing our experience with checklists as tools for reviewing construction documents. Most of us had composed a checklist at one time or another, but we didn't use them regularly, because, with time, they tended to become too general.

During the discussion Bernie Babka suggested that we might try writing separate checklists tailored to each project, because we could foresee most of a building's problems by looking pessimistically at the early design sketches. I think Bernie offered this as a joke, but we heard it as a revelation. During the silence that followed I remembered a lawyer telling me about a postmodern house that had leaked at its metaphors. I also recalled my personal list of disasters which had emerged from the gap between aesthetic intent and physical reality. Everyone at the meeting had a similar religious experience.

The Babka method recognizes that conceptual design is an act of optimistic euphoria, but that a pessimistic mind set is needed for successful detailing. The complete architect should, therefore, be a well rounded manic depressive.

The sketch of the Domino house that Corbusier made in 1915 (my rendition is

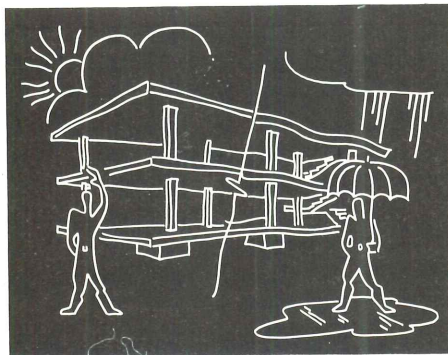

shown) might serve to illustrate this idea. Today it seems strange that flat plate construction could have ever been considered exciting enough to have inspired his drawings. But after four thousand years of bearing walls, beams, and girders the system must have offered the promise of great expressive freedom.

The same sketch, however, if viewed in a less optimistic light, foretells a number of potential problems. Punching shear seems to be waiting to happen at the top of every column. There is no inherent means of resisting horizontal forces, and in an earthquake the whole structure would tend to rotate around the stair.

If portions of the floor slabs are to extend beyond the exterior wall and form balconies, the absence of a step at the transition will create a condition that is impossible to waterproof. (Even today the lack of an adequate bulkhead at this location fulfills the promise made by pioneers of the modern movement to provide an intimate relationship with the great outdoors. Usually the clients are not amused.)

Adding the further difficulties to be expected from plastic flow we can see how the Babka method can result in a fairly complete project checklist, or in serious consideration of a mid-life career change.

But we needn't concentrate on systems as complex as structures to identify technical problems which will grow out of our aesthetic perceptions. My checklist would almost always begin with paving; not the informal roads and walks which meander through the site, but that paving which is critically important to the architectural concept. It is usually an outdoor extension of the ground plane on which the plan has

been organized. It may have an intricate geometry or simple scoring reflecting the structural module. But whatever the pattern it will not lend itself to effective drainage because this kind of paving is usually thought of as being dead flat.

It seems perverse that a species which evolved on the surface of a sphere would have developed a fixation on horizontal planes. It's a fairly recent problem. The Greeks and Romans took civil engineering seriously and we find few puddles in medieval cities. Malaria, after all, was part of their defense system. The program called for the swamp to be kept outside the walls.

Renaissance perspective taught us to see architectural space organized on a ground plane which receded to a vanishing point at the horizon. Photography has reinforced this compelling illusion. Unhappily well drained surfaces do not result in satisfying drawings and photographs. A catch basin in the paving of the Barcelona Pavilion would have been heartbreaking. The ideal Cartesian world in which we conceive our designs is a world without rain.

In the last twenty years there has been a great deal of talk about new spatial perceptions and about environmental issues. But, during this same period, we have traded in our tee squares for parallel rules. The limitations of this new tool have encouraged the transition from perspective to axonometric projections, which obliterate our sense of space while leaving the puddles.

The Babka method recognizes a difference between the design and detailing mentalities, but they should at least be kept within hailing distance. I would like to see architecture reinstated as an outdoor sport. □

Jack Hartray is a partner at Nagle Hartray Associates, Chicago, and teaches at the Illinois Institute of Technology.

The 1984 AIA
National
Convention

May 5-9
1984

American
Architecture
and Its Public

PHOENIX

A R I Z O N A

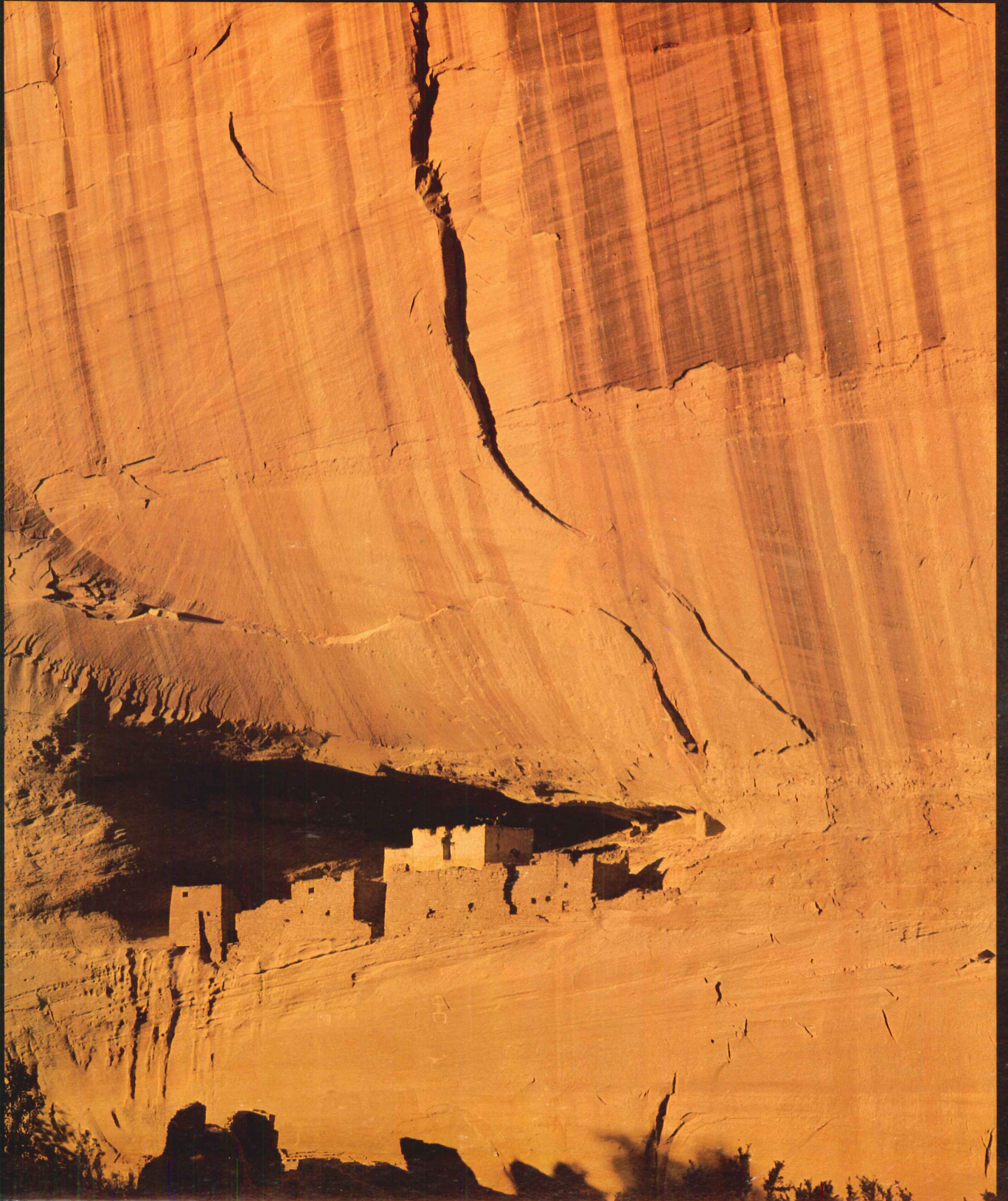

LCN understands the ins and outs of entrance accessibility.

LCN understands your need to provide entrance accessibility for people who are handicapped or frail. To help you solve accessibility problems, we offer a complete line of special purpose door closers. Our Entrance Accessibility brochure contains complete technical details. For your free copy, contact LCN Closers, Princeton, IL 61356; 815/875-3311. Ingersoll-Rand Door Hardware, Mississauga, Ontario, L5E 3B6; 416/278-6128.



AUTO-EQUALIZER® AUTOMATIC DOOR OPERATOR opens door slowly to 90°. Adjustable control holds door open up to 30 seconds.

DELAYED ACTION SMOOTHEE® CLOSER makes safe, convenient passage possible. Adjustable delay holds door open from 15 seconds to one minute, then releases.



4041 SUPER SMOOTHEE® CLOSER permits door to open with a force of less than five pounds to meet many interior barrier-free requirements.

LCN CLOSERS

Part of worldwide Ingersoll-Rand