



BUILDING TYPES STUDY:

**RECORD HOUSES OF 1982**

SEVENTEEN EXCEPTIONAL HOUSES SELECTED FOR  
THE 1982 AWARDS OF EXCELLENCE FOR DESIGN

**ARCHITECTURAL RECORD**

MID-MAY 1982 A MCGRAW-HILL PUBLICATION SIX DOLLARS PER COPY

The complements are all ours: beautifully crafted Armstrong no-wax Solarian® floors. The choice is all yours. A collection of 60 patterns and colors. Each created to complement your carefully planned, uniquely styled custom homes. Solarian floors. They're so nice to come home to. And it's so easy to see why. If you'd like to see more, we'll be glad to send you a 1982 Armstrong Flooring Sweet's catalog — with our compliments. Just write to Armstrong, Dept. 25FAR, P.O. Box 3001, Lancaster, PA 17604.



# COMPLEMENTS *of* THE HOUSE

SOLARIAN FLOORS

**Armstrong**  
so nice  
to come  
home to™

Circle 1 on inquiry card

Floor design copyrighted by Ar

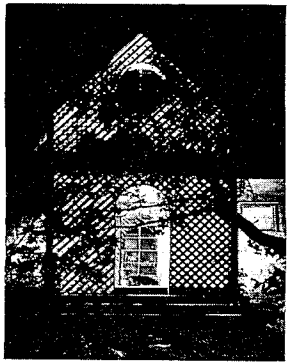

Cover: A remodeled carriage house  
Eastern Long Island, New York  
Architects: Susana Torre, The Architectural Studio  
Photographer: Timothy Hursley

## THE RECORD REPORTS

- 49 Preface  
by Barclay F. Gordon

## ARCHITECTURAL BUSINESS

- 2 Photographers of Record Houses  
2 Entry procedure for Record Houses 1983

## ARCHITECTURAL ENGINEERING

- 124 New literature for house planning  
126 New products for the house  
152 Advertising index  
155 Record Houses reader service inquiry card

## BUILDING TYPES STUDY 576: RECORD HOUSES OF 1982

- 50 **The Allen house**, Longview, Texas  
Architects: The Allen/Buie Partnership
- 54 **The Coxe studio**, Block Island, Rhode Island  
Architects: Venturi, Rauch and Scott Brown
- 58 **Private house**, Eastern Shore, Maryland  
Architect: Hugh Newell Jacobsen
- 64 **The Brague house**, Santa-Fe, New-Mexico  
Architect: Antoine Predock
- 68 **The Boyles house**, Aspen, Colorado  
Architect: Harry Teague
- 72 **The Vang house**, Napa, California  
Architects: Alexander Seidel and Jared Carlin
- 76 **The Peitzke house**, Fire Island, New York  
Architects: Peter Wilson Associates
- 80 **The Eck house**, Newton, Massachusetts  
Architect: Jeremiah Eck
- 84 **The Blum house**, Water Island, New York  
Architects: Roger C. Ferri & Associates
- 88 **The Lohmann house**, Quintana Roo, Mexico  
Architect: George C.T. Woo
- 92 **The McMillan house**, New Jersey  
Architect: Gerald Allen
- 96 **The Lewis house**, Medfield, Massachusetts  
Architect: Don Metz
- 100 **Family lighthouse**, Door County, Wisconsin  
Architects: Nagle, Hartray & Associates, Ltd.
- 104 **The Wells Hill house**, Fairfield County, Connecticut  
Architects: Redroof Design
- 108 **The Chiaraviglio house**, Eastern Long Island, New York  
Architects: Neski Associates
- 112 **A remodeled carriage house**, Eastern Long Island, New York  
Architects: Susana Torre, The Architectural Studio
- 116 **The Viereck house**, Long Island, New York  
Architects: Gwathmey Siegel & Associates

Of particular assistance to the Editor in the preparation of this issue were:

Barclay F. Gordon, editor-in-charge  
Jan White, art direction  
Muriel Cuttrell, illustration  
Charles Mazarakes, art production  
Susan Stein, editorial production  
Lindsay Li, editorial assistant

Introducing the Andersen<sup>®</sup> box bay. Space-savings,  
energy-savings and work-savings...in one beautiful package.

Come  
home to  
quality.



# Come home to Andersen.™

Did you say space-savings?

Yes. The bay's sides are 90° to the wall. This reduces the width of the opening. To as little as 50". Yet a high wide view still comes home.

You're saying less is more?

We're saying this Andersen® box bay is ideal for your space-conscious new designs and your remodeling/restoration projects.

And the energy-saving claim?

Fact not claim. This window is made of naturally insulating wood and uses double-pane insulating glass to reduce conducted heat loss through the glass area by almost 50%, compared to a single-pane window without storms. This energy-efficiency can mean year-round fuel savings for your client.

That alone won't sell them.

Then consider this. Covering the wood core of the window is a layer of thick rigid Perma-Shield® vinyl. The vinyl (available in white or Terratone color) resists installation damage. Ends on-site staining or priming. Saves on maintenance costs because it doesn't need painting.

Nice. But everything sounds good in an ad.

Then check Sweet's File 8.16/An. Or go see your Andersen distributor or dealer. They're in the Yellow Pages under Windows. Tell them we sent you.



**Andersen® Windowalls®**  
ANDERSEN CORPORATION BAYPORT, MINNESOTA 55003



721-0582

**Come home** to more information on the Andersen box bay. Mail coupon to Andersen Corp., Box 12, Bayport, MN 55003.

82126 Copyright © 1982 Andersen Corp., Bayport, MN

Name \_\_\_\_\_ Title \_\_\_\_\_  
Company \_\_\_\_\_ Address \_\_\_\_\_  
City \_\_\_\_\_ State \_\_\_\_\_ Zip \_\_\_\_\_ Phone (\_\_\_\_\_) \_\_\_\_\_  
Area Code

## SINGULARITY

Of concept. Of railing. Clean, simple lines.  
A one-handed sweep. Flowing floor to floor.  
Function maximal. Space minimal. Vertical  
dimension added. Fluidity captured.  
Crystalline pirouette. On center stage.  
The Atlantic Single Helix Staircase.

## STRENGTH

Of visual drama. Of workmanship.  
Of bold materials elegantly joined.  
Nature's oldest form. Circular  
concentration of force. Solidly, gracefully  
seated. Contemporary. Eternal.  
The Atlantic Single Helix Staircase.

## SCALE

Particularly suited to the smaller  
office. Or the larger residence.  
Downscaled in price. Upscaled  
in elegance. Choices. Of size. Of open or  
wrapped sides. Of custom-finished  
fine hardwoods. In accents of stainless  
steel. Of polished brass. Of chrome. Of...?  
The Atlantic Single Helix Staircase.

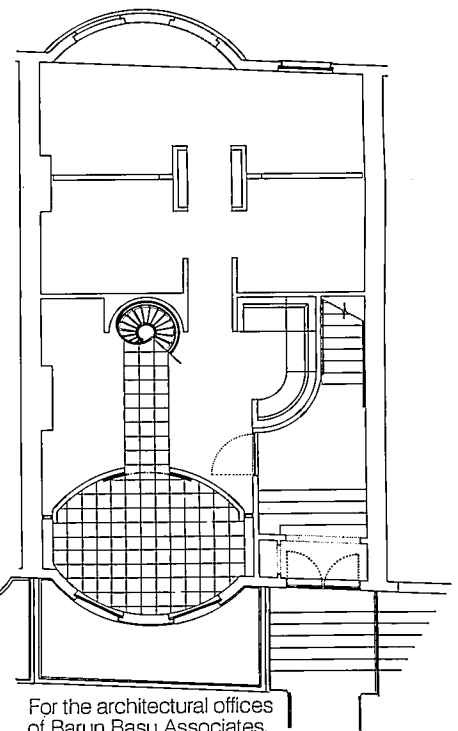

For the architectural offices  
of Barun Basu Associates.

## ATLANTIC

Presentation materials available on request.  
A specifications package with scaled graphics for space  
use planning. Call or write our Design Department direct.  
Atlantic Stairworks, Inc. P.O. Box 244,  
One Charles Street, Newburyport, MA 01950.  
Tel (617) 462-7502; (617) 465-2212.

Circle 4 on inquiry card

# Kroin

Olympia  
Design: Heinz Wirth, 1971

Installation: Lenox Square Mall, Atlanta, GA  
Architect: Greenberg Farrow & Associates

Selected for its unique ability to  
shape custom arrangements  
of curved seating facing inside or out.  
From the Kroin Series  
of Park and Garden Furniture.  
Available in green or white  
synthetic coated steel and wire mesh.

Kroin Architectural Complements  
14 Story Street  
Cambridge, Massachusetts 02138  
Telephone 617 492-4000  
Telex 951650

Represented in:  
Boston, Cincinnati, Denver, Los Angeles,  
Miami, New York City, Philadelphia,  
San Francisco, Seattle, Washington DC



MORE CULTURE FROM DELTA.<sup>®</sup>

# CULTURED ONYX™ HANDLES.

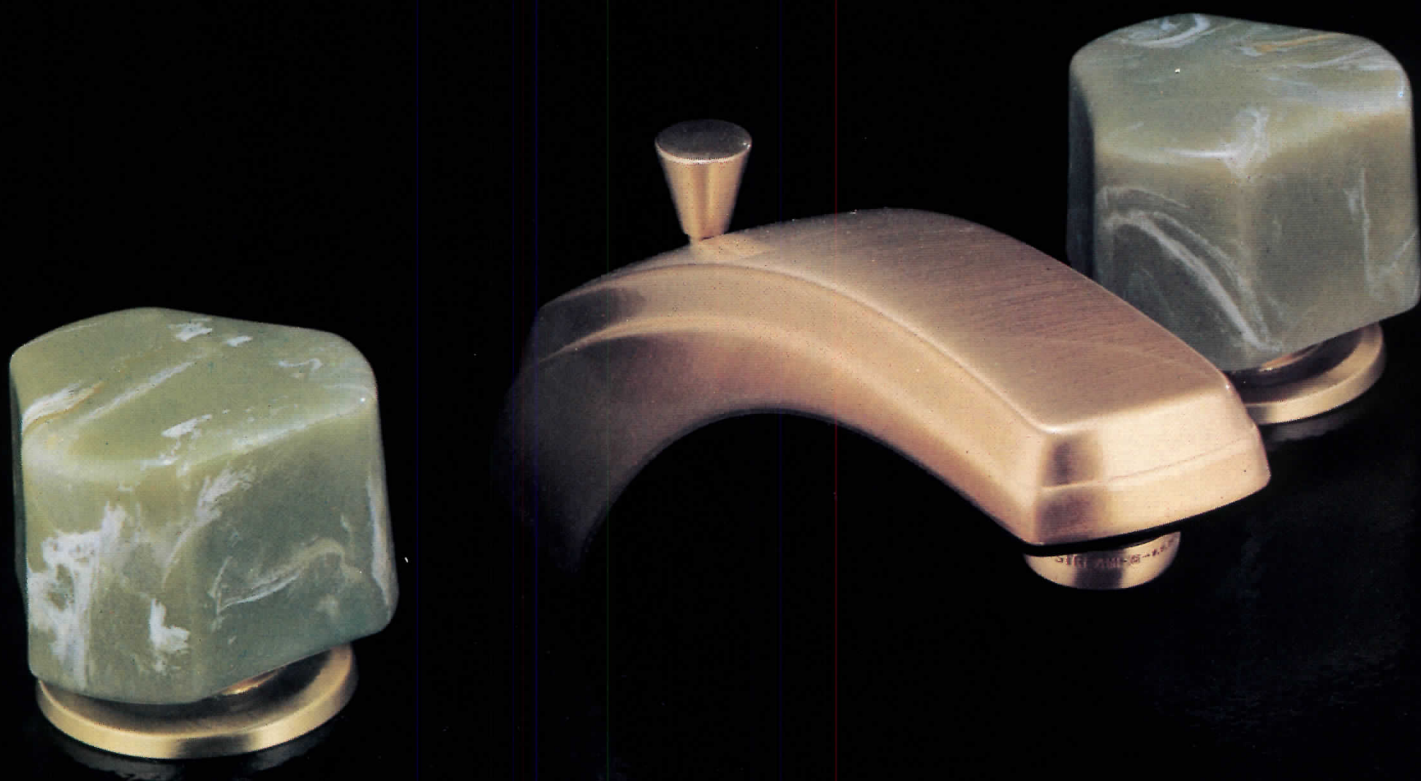

BAJA VERDE

HEATHER

SNOW

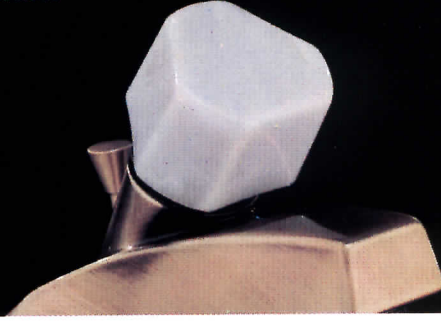
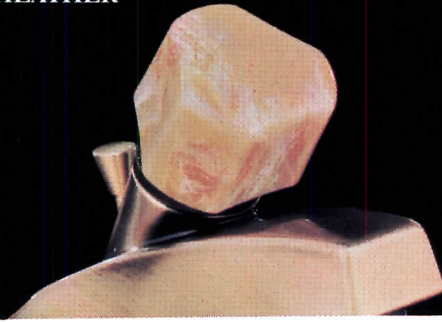
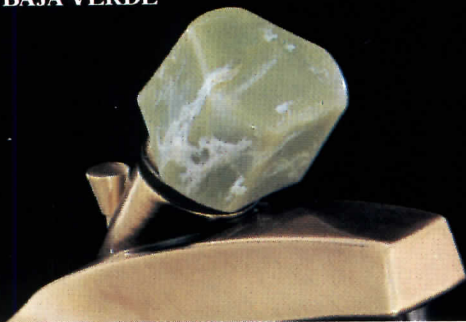

Now, the people who brought you *Cultured Gold*<sup>™\*</sup> have cultured another success for you. *Cultured Onyx*<sup>™†</sup> handles. They're so beautiful, people will want them in their homes. And so profitable, you'll want them in your line.

*Cultured Onyx* handles are available in Baja Verde, Heather or Snow on single- or two-handle

faucets. They're part of the *Delta Award Collection*

So, with the look of *Cultured Onyx* handles on top of *Cultured Gold* (or on top of Antique Brass or chrome), you'll have more ways to bring a touch of culture into people's homes.

\*Simulated gold finish †Simulated onyx

Circle 5 on inquiry card



**WE'RE FIRST BECAUSE WE LAST.**

DELTA FAUCET COMPANY, A DIVISION OF MASCO CORPORATION, 55 E. 111TH STREET, P.O. BOX 40980, INDIANAPOLIS, INDIANA 46280

© COPYRIGHT 1982 MASCO CORPORATION OF INDIANA



# Total system efficiency. Get it with gas heating/cooling.

For space conditioning—whether in a giant structure or the smallest commercial building—it pays to look into the advantages of clean gas energy.

Gas is efficient, economical energy. And new energy-saving equipment makes it even more efficient. Modern integrated heating/cooling systems fueled by gas can provide the operating economies and reliability today's business demands.

And America's large underground gas supplies and potential new sources will mean continued supplies of efficient gas energy in the future.

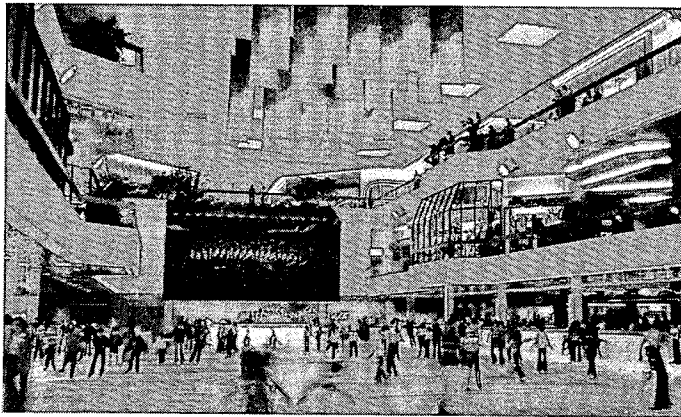

Williams Center Forum, Tulsa, Oklahoma.

Gas: The future belongs to the efficient.   
AMERICAN GAS ASSOCIATION © 1981

Circle 6 on inquiry card

NO. 2 OF A SERIES

**DesignTex. A jump ahead.**



**Du Pont**  
**TEFLON**  
soil & stain repeller

Circle 7 on inquiry card

DESIGN TEX FABRICS INC. 56-08 37th AVENUE, P.O. BOX 7708, WOODSIDE, NY 11377 (212) 335-9000 ATLANTA, BOSTON, CHICAGO, DALLAS, HOUSTON, KANSAS CITY, MIAMI, WASHINGTON, D.C. DESIGN TEX FABRICS WEST 8797 BEVERLY BLVD., LOS ANGELES, CA 90048 (213) 659-9900 DENVER, SAN FRANCISCO, SEATTLE

# ELLISSE™

## BATHE IN THE ROMANCE OF FRANCE.

The mood and motion, the grace and grandeur of French styling take shape in Ellisse, by American-Standard.

Ellisse is a complete ensemble that combines French savoir faire with the American flair for making it right. Enjoy a choice of three striking lavatories, two bath pools (with or without whirlpool systems), a one-piece toilet, and a bidet.

Even the fittings are jewels to grace the total effect. Choose the color that becomes you: we've got it, in Ellisse. Vive la difference from the leader, American-Standard.

Call toll-free for the name and address of a showroom near you, 800/821-7700, ext. 4023. In Missouri, 800/892-7655, ext. 4023.



 **AMERICAN-STANDARD**  
European elegance built to your standards.

Ellisse is a trademark of American Standard Inc. Copyright © 1980 American Standard Inc.

Circle 8 on inquiry card

## The intelligent thinking behind the Gwathmey Siegel desk

Until now, the thinking and talents of Charles Gwathmey and Robert Siegel have been reserved for their individual clients. Now, Gwathmey Siegel have designed a desk and cabinet line for the entire office.

Applying the logic that is characteristic of all their work, the architects have designed a system that, because of its modularity, solves a great many logistical problems for the interior designer.

The Gwathmey Siegel desk and cabinet line offers maximum storage, maximum design continuity and maximum flexibility. And with the Knoll tradition of manufacturing excellence, maximum value.

A variety of sizes and a range of materials assure strong design continuity from the executive suite to the reception desk.

"Opting for the simple thing well done," Gwathmey Siegel, simply stated, have done it very well again.

Knoll International, The Knoll Building  
655 Madison Avenue, NY, NY 10021

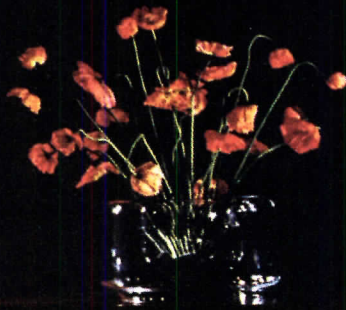

Knoll



WHEN YOU  
SPECIFY LIGHT,  
CONSIDER  
THE SHADE.

KOCH+LOWY INC.  
THE PAST, PRESENT, AND FUTURE  
OF MODERN LIGHTING

940 Third Ave., New York 10022  
Pacific Design Center, 8687 Melrose Ave., Los Angeles, Calif. 90069  
10044 World Trade Center, Dallas, Texas 75258

1245 Merchandise Mart, Chicago, Illinois 60654  
Galleria Design Center, 101 Kansas Street, San Francisco, Calif. 94103  
C423.2 Commerce Wing, Southern Furniture Center, High Point, N.C. 27261

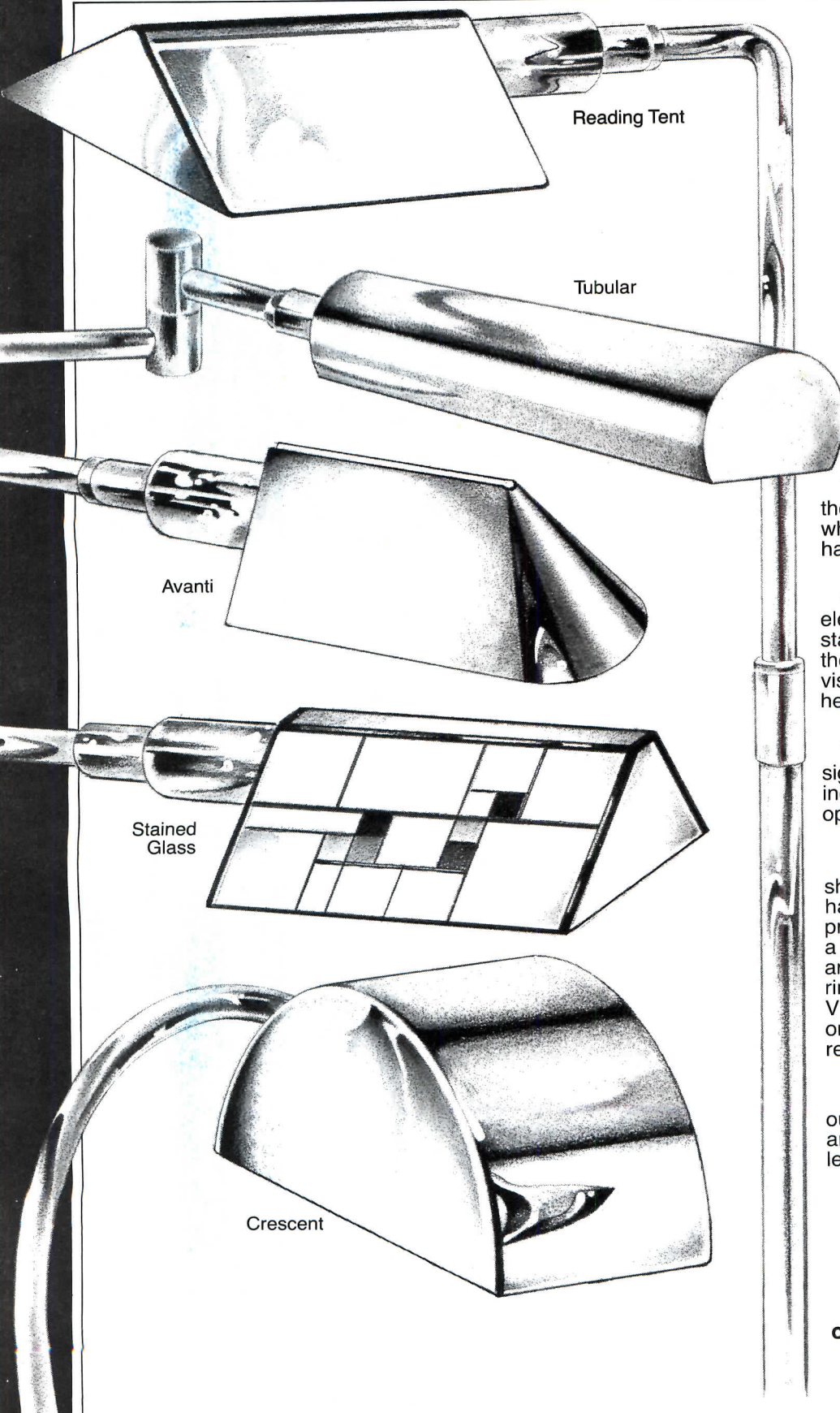

You can tell a lot  
about a lamp by  
examining the shade.

Take our famous **Reading Tent**. Like all our metal shades, it's made of solid brass sections, silver soldered and hand-ground to a perfect fit, then triple-polished and immersed in an acid bath for a flawless finish.

To prevent marring even by fingerprints, the shades are tray-carried to special ovens where protective lacquers are baked to a hard, longlasting beauty.

Combining aesthetics with functional elegance, our new **Avanti** shade takes a standard bulb. A slit of light passes through the top to produce a subtle effect. This visually attractive design also prevents heat buildup.

The newest addition to our line, the signed/numbered **Stained Glass** shade incorporates a design that provides optimal reading light and a work of art.

Our classic **Crescent** and **Tubular** shades, like all Koch+Lowy swivel shades, have a *fully enclosed* solid brass swivel, precisely tooled for a full 360° rotation and, a 90° tilt. They'll never sag, droop or flop, and never need adjustment. Nylon seating rings ensure smooth, noise-free operation. Virtually indestructible, these swivels are one more reason why Koch+Lowy lamps represent a lifetime value.

Consider these shades and examine our full line at Koch+Lowy showrooms around the country, or write under your letterhead for our catalog.

Circle 9 on inquiry card

# The Smart Ones.



## The architect:

Carl Massara, A.I.A., of Carl Massara and Associates, Philadelphia, Pennsylvania, at home with his wife, Emily. "At our firm, we consider economy along with functionalism and aesthetics to produce the optimum building within a given budget. This applies to all we do, from historic restorations to high-rise office buildings."

## The heat pump:

The York Smart One™ heat pump, for those who want the very best in year-round comfort and efficiency. Only the York Smart One has the YORKGUARD® computer module that automatically monitors and controls 19 vital energy-saving functions. For more information, contact your nearby York dealer.

Smart people are switching to York.

**YORK®**  
Heating and Air Conditioning

**BORG WARNER®**

Circle 10 on inquiry card

# An investment in elegance



## Built-in refrigeration for homes of distinction

Sub-Zero is the true built-in refrigeration system designed exclusively for the home. All models feature 24" depth, which enables them to fit flush with all standard base cabinets and affords easy accessibility to all stored items.

All Sub-Zero built-in models are designed to accept exterior panels of virtually any material. This unique feature provides you complete flexibility in kitchen design. You can blend it in or accent your own special kitchen decor.

Models range in size from 24" to 48"

width and up to 31 cubic feet in capacity . . . the largest unit made for the home. The line features side-by-side, over-n-under (freezer on bottom), all refrigerator, and all freezer units. Also available are under-counter and individual ice-making units.

All full size units feature icemaking capabilities and adjustable storage in both refrigerator and freezer.

An outstanding refrigeration system coupled with such innovative manufacturing features as polyurethane insulation (entire unit including doors), magnetically

sealed doors, self venting and automatic defrost assures years of satisfactory performance.

Every Sub-Zero unit is completely test run at the factory for total performance before delivery.

See Sub-Zero on display at leading kitchen dealer and appliance showrooms.



Send for colorful brochure on unique kitchens. Available in Canada. SUB-ZERO FREEZER CO. • P.O. BOX 4130, MADISON, WI 53711 • 608/271-2233

Circle 11 on inquiry card



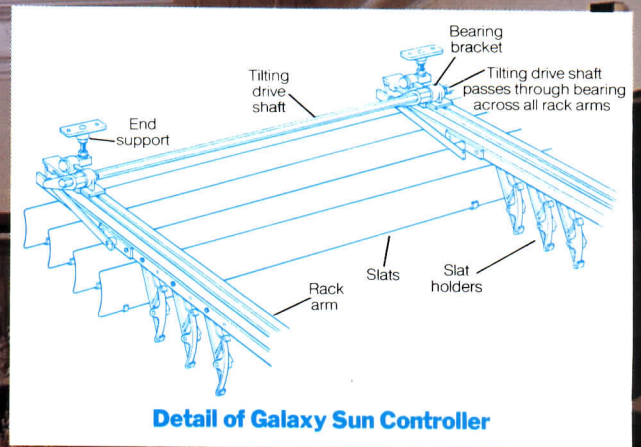

**Detail of Galaxy Sun Controller**

## **Levolor. A beautiful and practical way to control the sun.**

The Galaxy<sup>®</sup> Sun Controller by Levolor redirects the sun's rays exactly where you want them with absolute mechanical precision. Available in a variety of widths and configurations, the systems can be operated manually or motorized. Motorized systems can be controlled by button, computer, clock or light-sensitive apparatus. Because of their unique light control capabilities, Galaxy systems are ultra-efficient as an aid to summer cooling and winter heating. They can be used on hard to reach vertical surfaces, inclined windows, horizontal skylights, and greenhouse glass areas of practically any shape. The perfect economical answer to odd-shaped, special lighting and energy control situations. For details, write: Levolor Lorentzen, Inc., 1280 Wall St. West, Lyndhurst, N.J. 07071.

**LEVOLOR<sup>®</sup>**  
Extending your  
creative options.

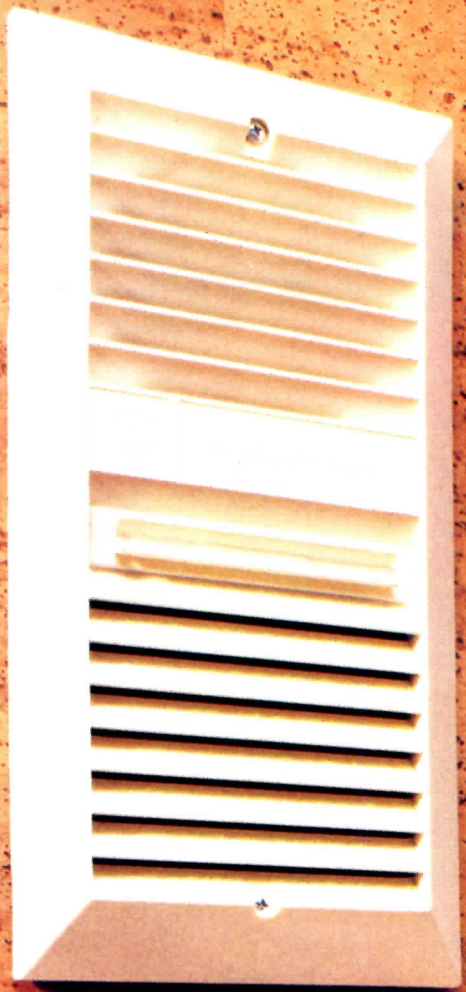

# Indoor air treatment should be as standard as the bathroom sink.

Indoor air, bathroom air in particular, is full of pollutants. Odor is the obvious problem. But there's also dust, tobacco smoke odors, and pollen, just to name a few.

Sticking a fan in the wall and connecting it to ductwork does not solve bathroom air pollution problems. A fan is not air treatment. It is simply air circulation.

## Indoor air should be treated scientifically.

There's only one air treatment system for pollution in bathrooms. The Ecologizer® built-in air treatment system.

The Ecologizer® system with the CA190® advanced scientific formula filtering system continuously removes pollutants from indoor air, including dust, pollen, and odors—even odors caused by harmful bacteria and fungi.

## It's been working construction for a decade.

Hotels, motels, condominiums, apartments, and single family homes have been using this proven air treatment unit in bathrooms, walk-in closets, laundry rooms, and other small spaces for over 10 years.

It's the only system of its kind to meet the National Sanitation Foundation C-10 Criteria for Ductless Air Treatment Devices, Section Five.

## More than built-in clean air.

The Ecologizer® built-in air treatment system cuts down on energy costs by recirculating expensively heated and cooled air. It's easy to install. And it saves per unit construction costs by eliminating ductwork.

The Ecologizer® built-in air treatment system. Setting the standard for indoor air treatment.

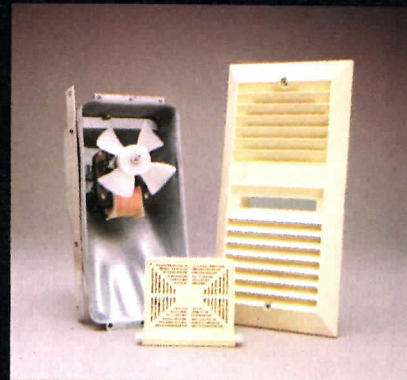

## **ECOLOGIZER®** **BUILT-IN AIR TREATMENT SYSTEM**



Rush-Hampton Industries, Inc.  
Longwood, Florida

Circle 13 on inquiry card

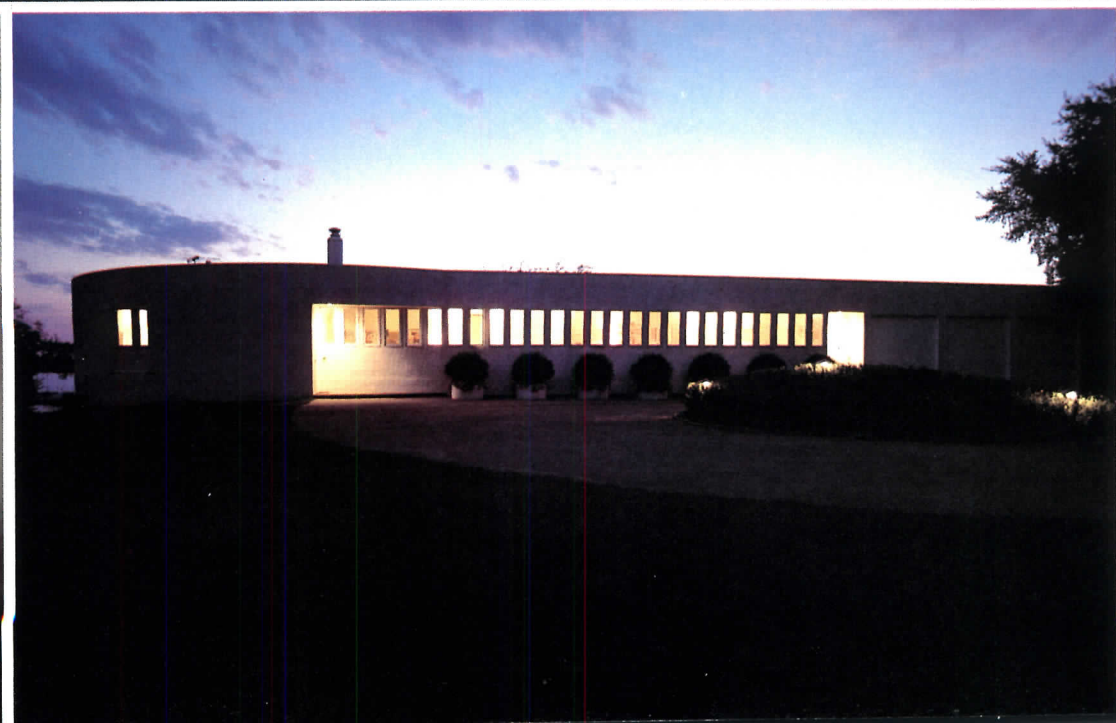
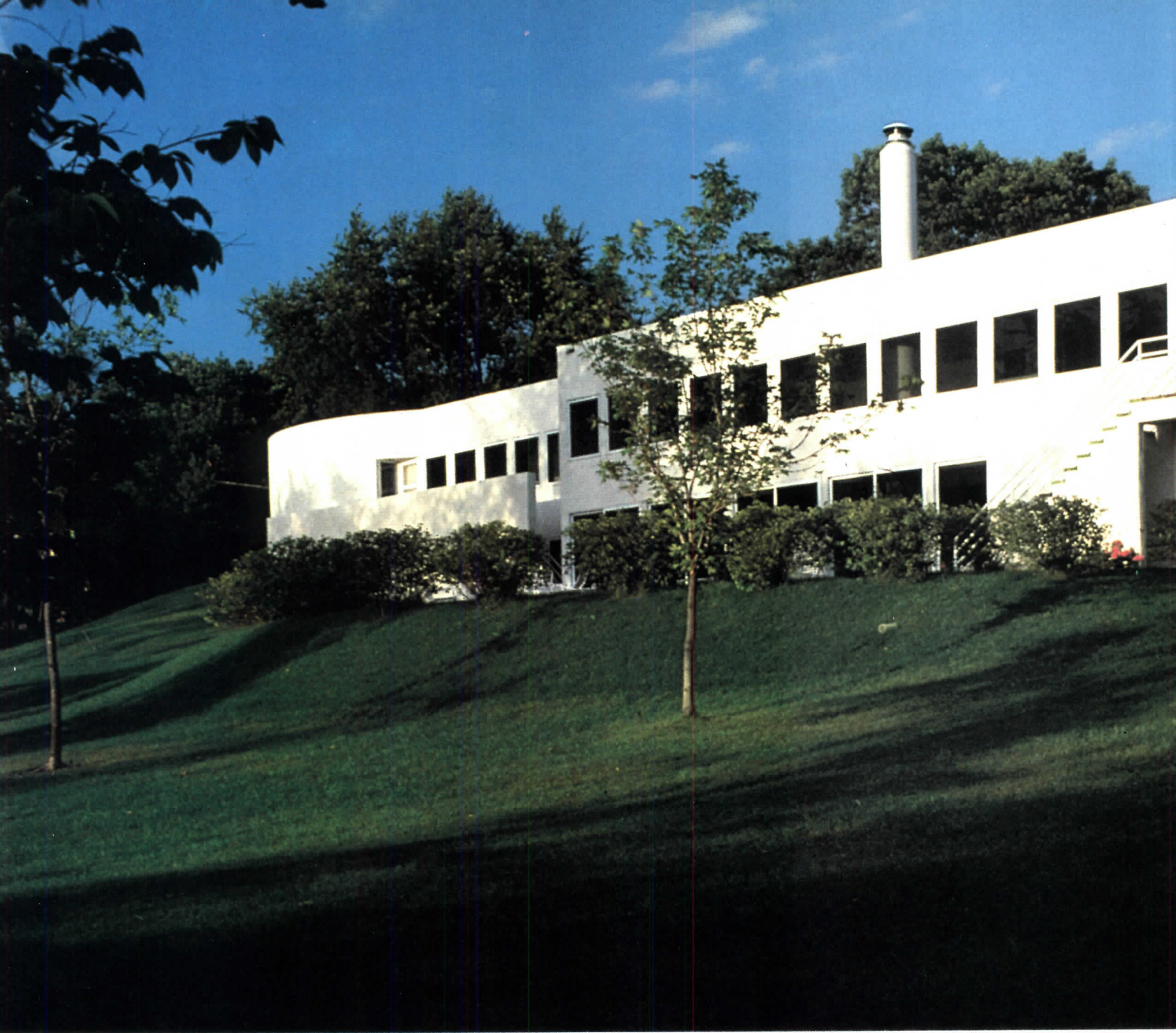



# The fine art of fenestration.

## And the Pella Clad Window System.

Beyond satisfying the needs for light and ventilation, window size and placement is a design element that reaches toward fine art. This idea, beautifully demonstrated in this lakeside home, expresses both the extent of the house from the inside, and the architectural solution to some rather strict site constraints. Local covenants allowed only one story construction as viewed from the street, yet the owners needed generous space for an active family life. And they wanted the house to take full advantage of the magnificent lake view.

The site, which slopes down from the street to the lake, offered a solution: the house is two stories, but banked into the slope to appear as just one story from the street. The strong, linear shape of the house is softened by curved walls at each end which also give the appearance of more space between the house and neighboring buildings. The

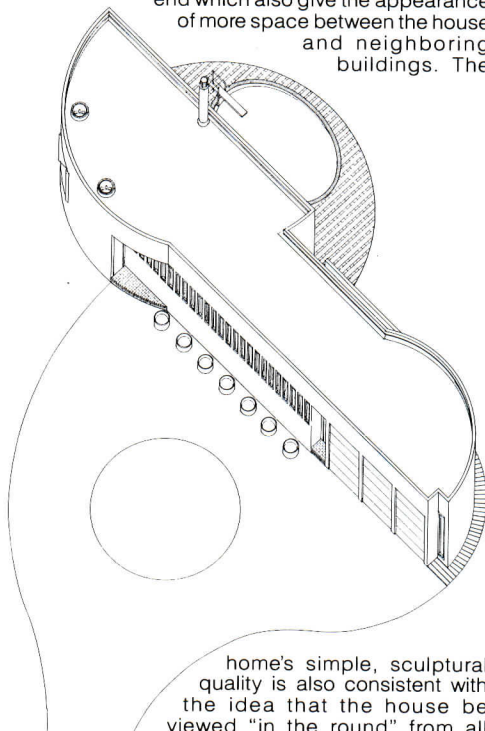

home's simple, sculptural quality is also consistent with the idea that the house be viewed "in the round" from all directions.

The street side of the house is fairly opaque and private. Upon entering, however, the house opens up to a two-story living space that offers generous views of the lake from nearly every corner of the house. In keeping with the scale of the lake-side wall, 8' high Pella Clad Sliding Glass Doors were selected for their correct proportion. Because this wall faces west, the doors and the Pella Clad Fixed Windows were specified with reflective bronze glass.

And, because the lifestyle of the owners includes better things than a lot of home upkeep, the exterior is stucco with low-maintenance Pella Cladding on all casement and fixed windows and sliding glass doors.

**Pella Clad Sliding Glass Doors. Proportioned to meet your design requirements.** Pella offers its Standard Sliding Glass Door in two heights, 6'8" and 8', plus more widths and combinations of fixed and

sliding panels than any other wood door manufacturer. And, where a different look is required, consider the Pella Contemporary French Sliding Glass Door. Both feature sliding panels that roll on ball bearing wheels, exterior cladding, glazing options including reflective glass, and a self-closing screen panel.

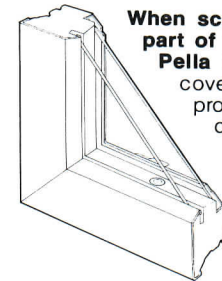

**When scraping and painting isn't part of the program, specify the Pella Clad System.** Completely covering the exterior of Pella products is a sturdy aluminum cladding that's finished in white or dark brown enamel.

This tough coat resists chipping, flaking, peeling, blistering, corrosion, and a host of other plagues. Yet, for all this protection on the outside, all you see inside is real wood ready for stain or paint.

**Air space is one of nature's best insulators. And Pella offers more.**

Among Pella's glazing options is the Double Glass Insulation System that features 1<sup>3</sup>/<sub>16</sub>" of insulating air space between glass panels and produces one of the highest R values in the industry. Plus, Pella's tight weatherstripping reduces air infiltration up to 16 times better than industry standards. This system also offers the choice of reflective glass and the Pella Slimshade® for further environmental control.

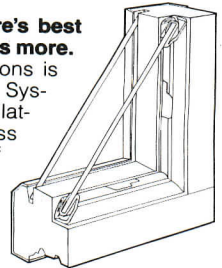

**Pella Clad Skylights. Both fixed and ventilating styles now available.** More

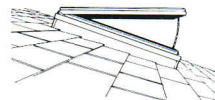

places to put Pella than ever before. If you haven't seen or heard about all that Pella offers for residential and commercial construction — both

new and replacement — send for your free copy of our 1982 catalog. Call Sweet's BUYLINE number or see us in Sweet's General Building File. Or look in the Yellow Pages under "Windows" for the name of your nearest Pella Distributor.

Name \_\_\_\_\_

Firm \_\_\_\_\_

Address \_\_\_\_\_

City \_\_\_\_\_

State \_\_\_\_\_ Zip \_\_\_\_\_

Telephone \_\_\_\_\_

**Mail to:** Pella Windows & Doors, Dept. T30E2, 100 Main St., Pella, Iowa 50219. Also available throughout Canada. This coupon answered within 24 hours. © Rolscreen Co. 1982

## Pella. The significant difference in windows.

Residence, Wayzata, Minnesota 1978 Honor Award, Minnesota Society, AIA

Architect: Frederick Bentz/Milo Thompson/Robert Rietow, Inc., Minneapolis, Minnesota

Contractor: Joe Peterson Construction Co., Minneapolis, Minnesota

Circle 14 on inquiry card



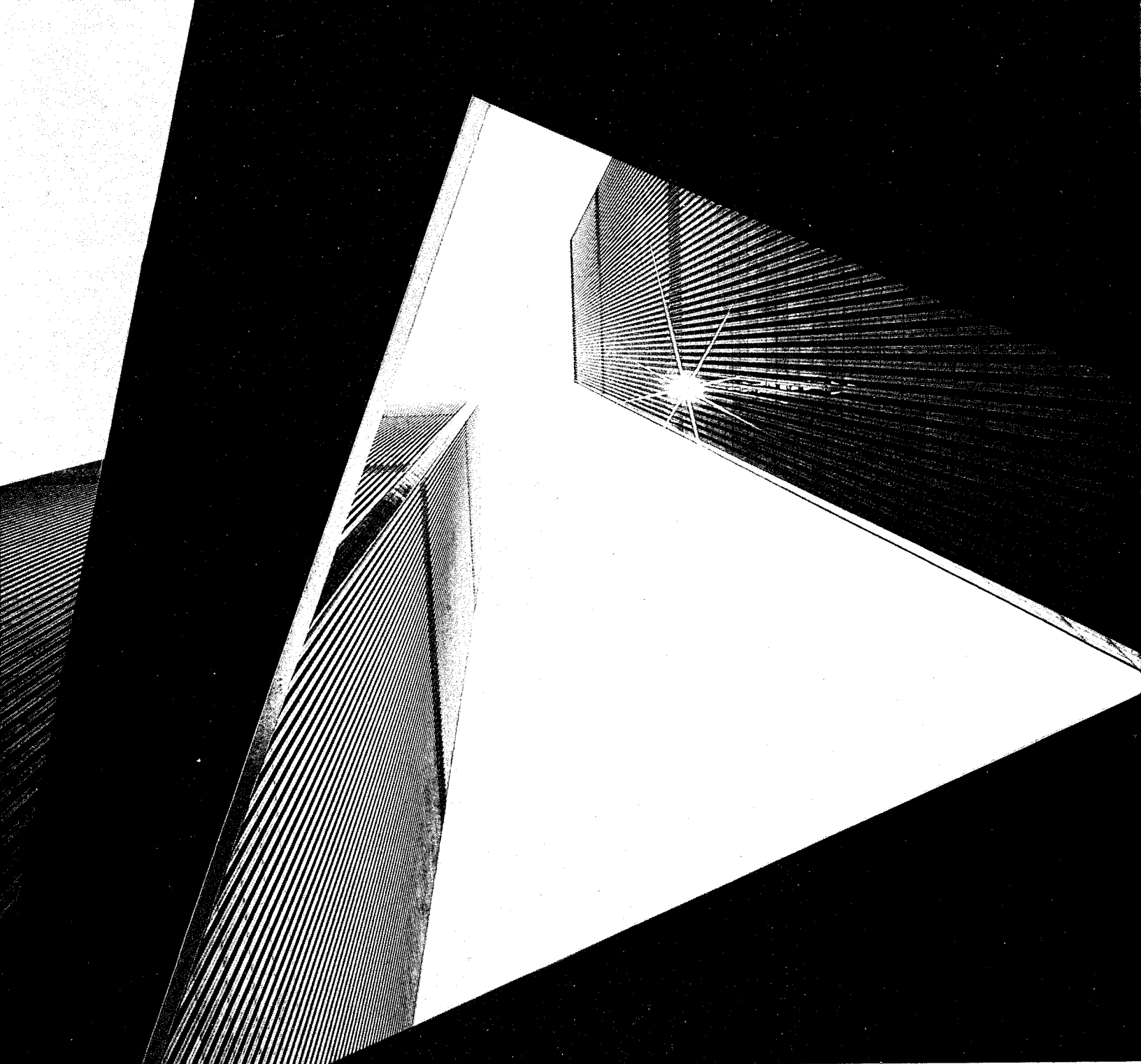

## **A decade after installation the World Trade Center specified a replacement for its pure wool carpet—Pure Wool.**

The first pure wool carpet was there for 10 years. Millions crossed the lobby at the rate of 100,000 a day—36,000,000 a year.

And each passing year validated the original decision to install wool, the natural carpet fiber. The color stayed rich. The pile snapped back. Dirt didn't get ground in. Burns were brushed away. And when stained, wool was easily cleaned.

Evaluate wool on a Life Cycle Costing basis. Because wool is easier to maintain and requires fewer cleanings to retain a higher level of its original appearance, wool carpet costs less.



PURE WOOL PILE

The Standard of Carpet Excellence.

The Wool Bureau, Inc., US Branch of International Wool Secretariat  
360 Lexington Avenue, New York, NY 10017 212/986-6222

# Architects & Engineers E&O. We build more into it. So you get more out of it.

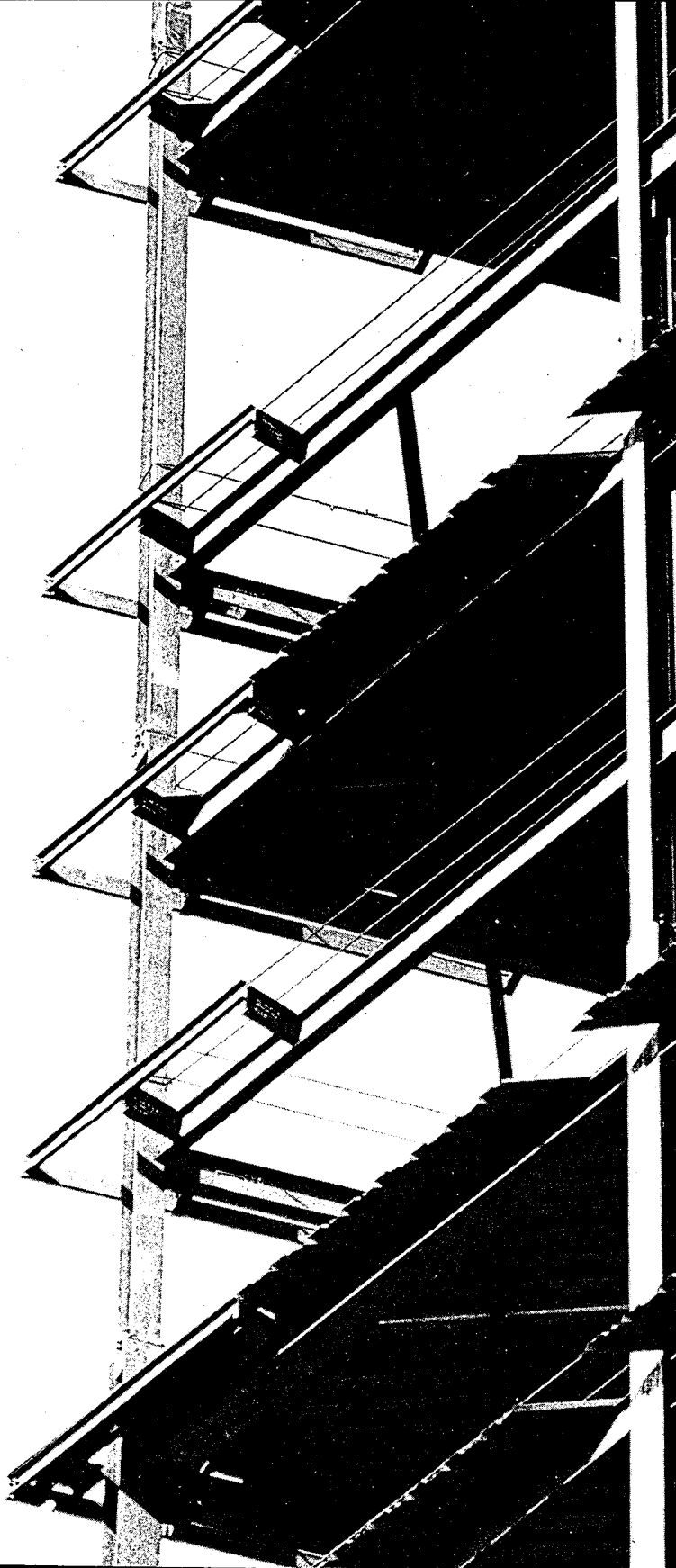

Shand, Morahan & Company has become synonymous with the finest professional liability insurance for architects and engineers available anywhere.

For over a decade we have constantly perfected this coverage to keep it fully responsive to the latest needs and conditions of the industry. Today, our program offers architects, engineers, construction managers and design constructors truly state-of-the-art liability protection.

The program offers a selection of custom options to cover joint ventures, special projects (separate limits or policies are available), equity interests and other individual requirements. Our standard limits range from \$100,000 to \$25 million, and higher if needed. Coverage can apply to projects worldwide.

Written on a Claims Made basis, the Shand, Morahan program includes Prior Acts coverage, with current limits applying. And a special Discovery clause protects against post-policy claims from circumstances that are reported during the policy period. Defense costs are covered in addition to policy limits. And Shand, Morahan's own claims staff, many of whom have working architectural and engineering backgrounds, supervise all claims from start to finish.

For immediate information, contact your insurance agent or broker.

**SM** Shand, Morahan  
& Company, Inc.

*One American Plaza, Evanston IL 60201*

Circle 17 on inquiry card

# Whatever your

## Koh-I-Noor® provides a complete system for maximum efficiency.

### Koh-I-Noor Rapiddraw® System

A System to provide drafters with the capability of producing engineering drawings with optimum reproducible line values. The System is comprised of the Rapidograph® technical pen and Koh-I-Noor or Pelikan ink for use directly on Rapiddraw drafting film. Ink-line drawings on film are virtually indestructible!

- Go directly to microfilming without redraws or touch-ups.
- Take no more time on the average than drafting with graphite.
- Can be revised by erasing ink lines on originals even years after they are drawn.
- And erasures are cleaner and faster than can be accomplished with graphite on paper.
- Ink lines are quickly matched within a drawing, from drawing to drawing, or from originals to blowbacks and other photoreproductions.

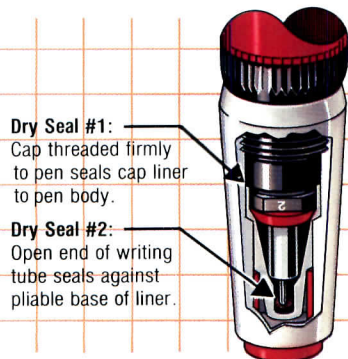

Patented DRY DOUBLE-SEAL™ keeps Rapidograph technical pens ready for instant startup.

The Rapidograph pen was the first technical pen, and because of its precision dependability and performance, it is the most widely used technical pen in the United States and Canada. Contributing to the success of Rapidograph technology is the patented DRY DOUBLE-SEAL™ cap which seals the point tip and pen shoulder when the cap is secured, keeping ink throughout the balanced ink-flow system fluid and clogfree for instant startup and optimum drawing time. No maintenance-plagued gimmicks for sealing or humidifying. Stainless steel, jewel and tungsten carbide points in 13 line widths.

Rapidograph technology pioneered the development of the liquid-ink system for high-speed plotting associated with computer-aided drafting equipment.

### Koh-I-Noor Graphite System

Koh-I-Noor offers the finest woodcased pencils and drawing leads in 17 uniform, precision-graded degrees. Other components of the Koh-I-Noor Graphite System include seven drawing-lead holders (with choices of features), pointers, sharpeners, and erasing materials.

Koh-I-Lar plastic leads and wood-cased pencils in 5 degrees are used on drafting film for cleaner drawings and more opaque lines for photoreproduction. Koh-I-Noor also provides highest quality 100% rag drawing papers and Mylar-based drafting film.





# drafting technique



See the KAD II in action at Systems '82 —  
Koh-I-Noor Booths 211/213

## Liquid-Ink Plotting System

To achieve optimum efficiency with liquid-ink plotting, this Koh-I-Noor System integrates proper rate of ink flow, ink viscosity, point material, and drafting media with the plotting speed required. Koh-I-Noor plotter points are available individually or with complete plotter pens, in stainless steel, jewel or tungsten carbide . . . each in 9 line widths. The System can be customized for your special plotting needs, including custom engineered pens, adaptors and bushings to eliminate costly modifications of your plotter.

Evolving from Rapidograph technology and Koh-I-Noor plotter inks is the Koh-I-Noor KAD II™, an electronically controlled liquid-ink lettering and symbol-generating system for use on the drawing board. The System offers a virtually limitless library of preprogrammed standard or custom lettering styles, symbols and designs for drawings and formats used in engineering, electronics, architecture, cartography or any other professional discipline. KAD II is already saving time and money, and helping to meet deadlines in the drafting and graphics departments of major corporations. Its advantages and cost justification have also placed KAD II in many smaller operations. For more information and a demonstration, contact Koh-I-Noor Customer Service for the KAD II dealers in your area.

## KOH-I-NOOR RAPIDOGRAPH®

Show me more, KOH-I-NOOR! Please send me the free literature I have checked below.

- Rapidograph pens, drawing inks — Catalog A.
- Leads, holders, pencils, pointers — Catalog B.
- Templates, scales, triangles, other drawing aids — Catalog C.
- Compasses, dividers, drawing instruments — Catalog D.
- The Rapiddraw System* manual — K-913.
- Liquid-Ink Plotting brochure — K-1181.
- Kad II brochure — K-1177.
- Please send names of Koh-I-Noor dealers in my area.
- Please have a Koh-I-Noor representative call me at ( \_\_\_\_\_ ) \_\_\_\_\_ to tell me about \_\_\_\_\_

Name \_\_\_\_\_ Title \_\_\_\_\_  
Company \_\_\_\_\_ Phone ( \_\_\_\_\_ ) \_\_\_\_\_  
Address \_\_\_\_\_  
City \_\_\_\_\_ State \_\_\_\_\_ Zip \_\_\_\_\_

KOH-I-NOOR RAPIDOGRAPH, INC. 100 North St., Bloomsbury, NJ 08804 201-479-4124.  
In Canada: 1815 Meyerside Dr., Mississauga, Ont. L5T 1B4 416-671-0696.

AR-5-82

Circle 18 on inquiry card

# Flame Test®

## Flame Test® Fighting fire with flair.

Class 1 rated siding and paneling can be easy-to-install, durable, economical and stylishly beautiful. All at the same time. We know. We're Masonite Corporation and we make a full line of asbestos-free and salt-free hardboard sidings and paneling that beat alternative materials by a mile. Masonite® brand Flame Test® panel and lap sidings are primed and ready to paint or stain. Masonite® brand Flame Test® interior paneling is available in many colors, grain patterns and textures. Both add lasting beauty to any commercial, institutional or multi-family project. But the best thing is that Masonite® brand Flame Test® siding and paneling is available when you need it. The Underwriter's Laboratories, Inc.® Fire Resistance Directory includes our Design Numbers U026, U324, U325, U323, U322, U422, and U421. Write for complete details. (Please note: display at top right corner is a sampling of Flame Test® interior paneling.)



Dept. NBD-AR-5  
P.O. Box 1048, Laurel, MS 39440

Circle 19 on inquiry card



Admiral's Row Condominiums, Hilton Head, S.C.  
Developer: Columbia Management Corporation  
Builder: Coker Builders, Incorporated

**MUST SEE!**

**neocon14**

State-of-the-art  
in modular carpets

The universal  
carpet backing system

**1814 MERCHANDISE  
MART - LEES CARPETS**



## Lees presents the state-of-the-art in carpet tiles

**Most carpet tiles will look good in the carton. If you need to know how they'll perform on the floor, be sure to read the warranty.**

**Guaranteed.** Lees backs its modular carpet system with a comprehensive warranty, written in plain English. No manufacturer of carpet tiles goes as far to guarantee performance satisfaction.

**Construction.** Unibond® back bonds face yarn and backing materials into a single component. Hot-melt thermoplastic resins and flow-on lamination produce modular carpets that are guaranteed against edge ravel and delamination.

**Test data.** Lees tests its modular carpets for smoke generation and flame spread. This important data is published and readily available for review.

**Advanced generation.** As long ago as 1967, Lees made rubber-backed carpet tile for the educational market. Later versions utilized a hard vinyl back. The present Lees carpet tile is an advanced generation product that fits a vastly improved modular carpet system.

**Appearance.** Antron® III nylon pile yarns by DuPont are dirt-resistant and static-protected. Superior appearance retention reduces maintenance costs.

**Coordinates.** Plain and patterned modular carpet fits a system that includes broadloom coordinates in identical construction. Visual flow is continuous, uninterrupted by breaks in surface texture.

**Installation.** Most "loose lay" carpet tiles never get loose laid, but are glued down instead. Why? Ask the installation contractor, the man who would be responsible for the job if anything were to go wrong. Lees provides a fast, clean money-saving pressure sensitive adhesive for use with its modular system.

**Call toll-free.** For test data, specification information, call 800/523-5647. From within Pennsylvania, call collect 215/666-9426. Or write for illustrated brochure.

**Lees. The Contract Carpet Company.**

**Live the life of Lees at work and at home.**

**LEES** carpets

Made better by Burlington  
King of Prussia, PA 19406

Circle 20 on inquiry card

# 40,000 buildings proof-positive Dryvit

40,000 buildings later in the U.S.A. — and many thousands of buildings later in Europe — Dryvit Outsulation® has become the exciting versatile answer to a whole range of today's construction challenges. For some very good reasons, as we shall see.

## More than a wall for diversity of design.

Because it is a 4-component system, Dryvit has built-in design flexibility. The thickness of the insulation board may be varied to create highlights. Aesthetic detail can be introduced by incorporating 3-dimensional shapes. The surface of the 4 basic textures can be subtle or bold. Colors can be patterned for graphic impact. Look at the sculptural effects that The Symonds/Feola Partnership achieved for the Biltmore Fashion Park.



This Phoenix, Arizona, shopping center posed challenges to the architect. Design an addition to a pre-cast concrete plaza. Do it fast. Make it elegant for stores like Gucci's and Saks 5th Ave. The sculptural quality was easy with foam shapes. The match is so marvelous, old and new blend. The time? Far less and 35% less in price than an estimate for pre-cast concrete.

## More than a wall for energy savings.

Putting insulation on the outside was a totally new idea when Outsulation came along. But it's a natural when you understand what happens. Thermal bridges are sealed. Thermal shock is minimized. And that brings about a whole lot of energy efficient benefits that Dryvit is known for.

The dynamics are simple. With interior insulation, cold air infiltrates in winter, heat builds-up in summer. With Dryvit Outsulation, temperature fluctuations within the wall are minimal. Water can't penetrate. Heating and cooling costs plummet — even original HVAC installations can be smaller, for further cost reductions.



Look at EG&G's Willow Creek Office Building in Idaho Falls, Idaho. The architects, Flatow Moore Bryan and Assoc. won a prestigious energy conservation award for this building. The design captures heat generated by the building's occupants and its sodium lighting. Exterior walls of Outsulation were chosen to retain this captured energy.

Result? EG&G has a 280,000 sq. ft. headquarters 3 times the size of its former facility — yet uses 22% less energy.



## More than a wall for residential construction.

This Atlanta, Georgia home, for instance, has the clean sleek look of stucco — but without stucco's cracking tendencies. The color is permanent, maintenance is minimal.

But then, any design, period or architectural embellishment is reproducible with Dryvit. And owners can be confident when they choose to build with it. Our testing program is the most stringent for this type of system. And a network of distributors is on hand for far-reaching technical services.

For beauty and energy-efficiency, Outsulation comes through for the home owner.

210 Clay Avenue  
Henry C. Iggena, Architect,  
Bellemead Development  
Corporation

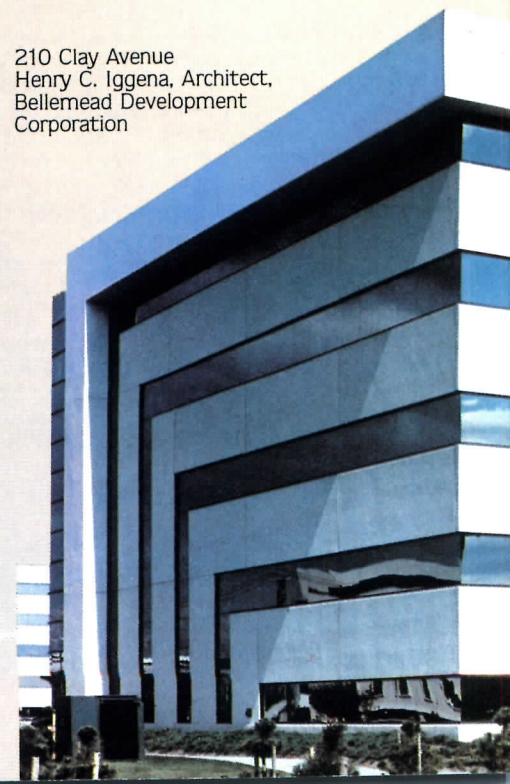

# later in the U.S.A. . . . is more than a wall.

## More than a wall for fast-track efficiency.

In 36 days, Andersen Fabricators, Elmwood Park, New Jersey, completed 100,000 sq. ft. of wall area on the Meadows Office Complex



in Rutherford, New Jersey. Albert Levenelm, Jr., Architect, stated that Dryvit panels were specified for spandrels and columns. Why? Lightness of weight, ease of handling and speed of erection. The panels were fabricated in the Andersen plant and trucked in as needed. This off-site fabrication ability allows year-round construction and keeps downtime at a minimum. Cost-effective, indeed.



## More than a wall for retrofit.

Midland Memorial Hospital in Texas had been adding wings of varying design and material since the 50's. It needed retrofit inside and out. Architects, Flatow Moore Bryan and Assoc. chose Dryvit to enclose the whole building in a clean insulating skin. Both panelized and field applied Dryvit were used for 221,000 sq. ft. of wall area.

Old walls of concrete and brick disappeared under a handsome Dryvit finish. Energy conservation was enhanced by massive Outsulation and window-shading bands incorporated within the System.

Today, Midland Hospital looks like a brand new medical center and energy consumption is expected to be substantially less than before.

## "Panelized walls save time and money . . ."

Henry C. Iggena, Architect, Bellemead Development Corporation



"The building at 210 Clay Ave. in the Meadowlands Corporate Center, Lyndhurst, NJ is actually an identical twin to a nearby building I designed a few years earlier. We employed the Dryvit System of panelization on both.

The design entailed 32,000 sq. ft. of Dryvit panels and went up very quickly. Great economies were realized due to the speed of erection possible with this energy efficient wall system. All panels were in place within a three week time span."

## More colors. 21 in all.

These architecturally pleasing colors are available in all 4 crack-resistant Finishes. Each color is integral with the Finish. All are fade and stain resistant. For more information, write to us stating your interest: new construction or retrofit.



More than a wall; an energy-efficient system.

**dryvit<sup>®</sup>**  
**OUTSULATION<sup>®</sup>**

### DRYVIT SYSTEM, INC.

One Energy Way, P. O. Box 1014  
West Warwick, RI 02893  
(401) 822-4100

Plant locations: West Warwick, RI;  
Tulsa, OK; Columbus, GA

Dryvit is listed in the General Building File of Sweets Catalog under Section 7.13/DR.

Circle 21 on inquiry card

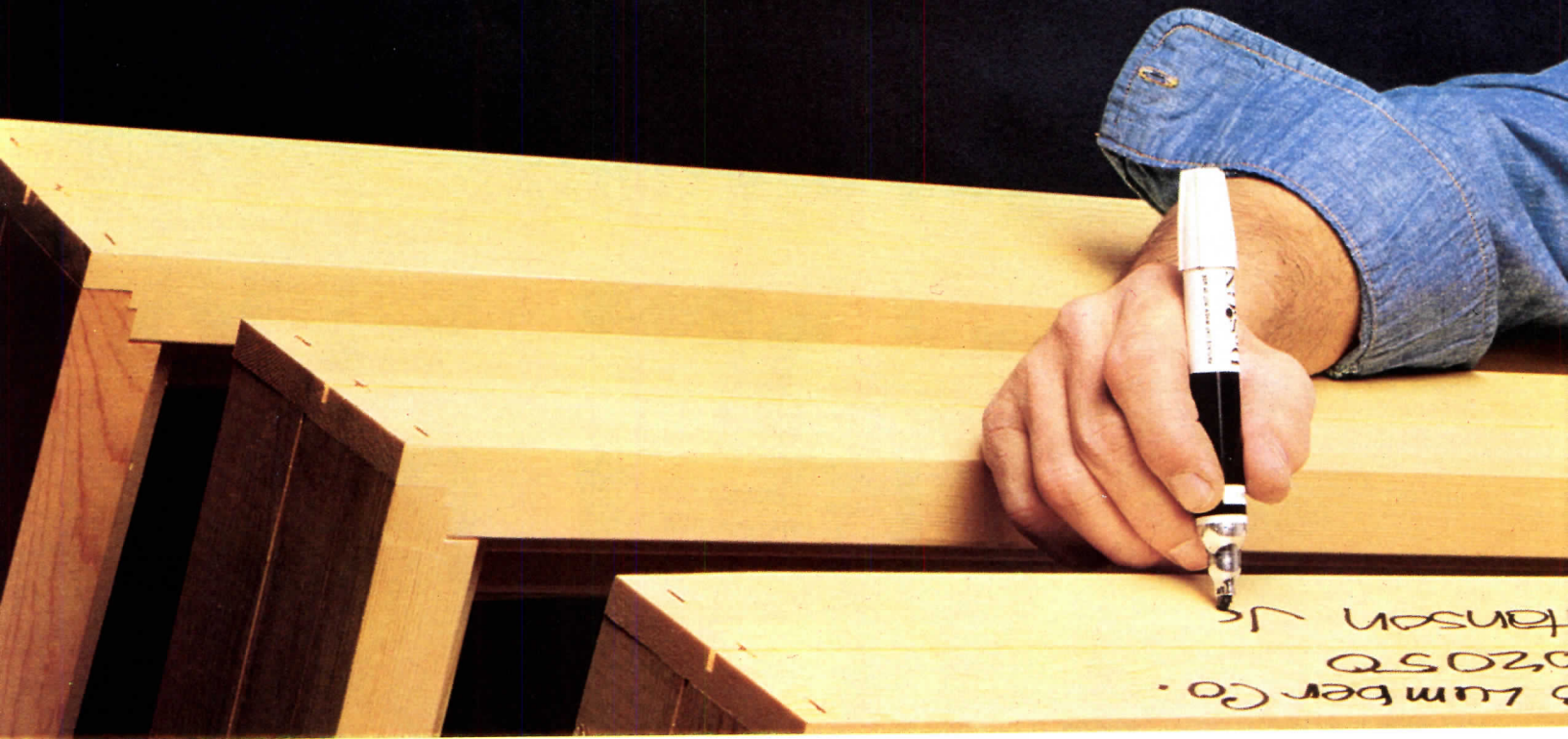

# MARVIN WINDOWS. MADE TO FIT. BECAUSE THEY'RE MADE TO ORDER.

At Marvin, we make nearly a million windows a year. But we still make them one at a time.

Carefully. Meticulously.  
To your specifications.

In fact, when we make a window for you, the first thing we do is put your name on it.

## THEY FIT YOUR PLANS.

While other leading manufacturers make just a few standard sizes, we offer 1,456. And, if you need a size or shape we don't already have, we'll make it 1,457.

We offer windows with true divided lites, prefinishing, special jambs, clads, etc.

And because our windows are made to order, they're easy to install without fooling around with a lot of shims, extenders and the like.



### THEY FIT YOUR CLIMATE.

Maybe because we're located in a place where the temperature can plunge to 30° or 40° below, we've become leaders in well-insulated, energy efficient windows.

Yet, the same things which make Marvin Windows ideal for our climate make them ideal for climates which reach temperatures of 110° above.

All of our windows are made of fine-grained Ponderosa pine. (Wood is still the most attractive material for windows and the best insulator.)

We offer double or triple-glazing for superior protection against heat loss. Our weatherstripping is designed to minimize drafts. And many Marvin windows are double weatherstripped.

In fact, compared to ordinary windows, they can eventually pay for themselves by reducing heating and air conditioning costs.

### THEY FIT YOUR SCHEDULE.

If you're operating on a tight schedule, you'll be happy to know so are we.

From the time we receive



your order to the time your windows leave our factory, it's 10 days or less.

Most of our competitors take up to seven weeks. (We've seen entire buildings built in less time than that.)

### THEY FIT YOUR BUDGET.

With all the advantages we offer, you'd think our windows cost an arm and a leg.

Hardly.

Marvin Windows are virtually the same price as any other brand of quality windows.

So, the next time you're window-shopping look for the name Marvin. Whatever your needs, we've got a window made to order.

For our catalog and more information, send us the coupon or call 1-800-346-5128. In Minnesota call 1-800-542-5037.

Send to: Marvin Windows  
Warroad, MN 56763

Name \_\_\_\_\_  
Address \_\_\_\_\_  
City \_\_\_\_\_  
State \_\_\_\_\_  
Zip \_\_\_\_\_

**MARVIN WINDOWS** 

Circle 22 on inquiry card



The Richlar Plaza. Developer/General Contractor:  
The Richlar Partnership. Architect: Barry Berkus

## THE LOOK.

## GET IT THE EASY WAY.



With ShakerTown Siding, #1 grade cedar shingles and shakes permanently bonded to 8' wood laminated panels. Available in 4 textures in 7" and 14" exposure and 9 victorian style Fancy Cut patterns.

The Richlar Plaza look is a

combination of ShakerTown 8' Colonial Rough Sawn Shingle Texture and victorian style round Fancy Cut Panels.

Get the look you want the easy way with ShakerTown Siding.

Call Joe Hendrickson at 1-800-426-8970.

**ShakerTown Siding**

Box 400, Winlock, Washington 98596 (206) 785-3501

Circle 23 on inquiry card



Grohmix Tub Filler  
with Personal Shower

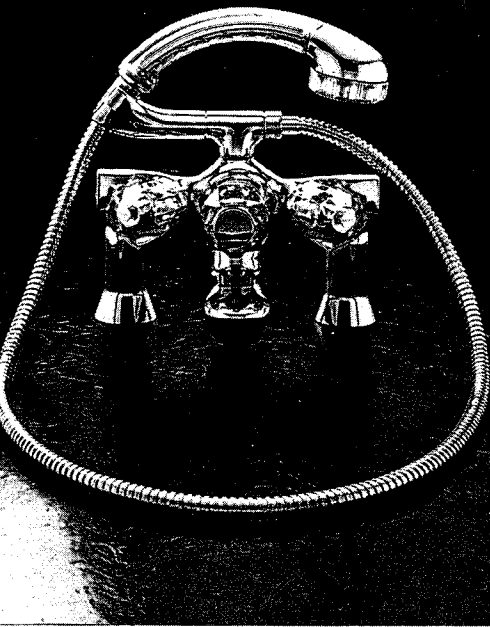

Classic Lav Centerset  
with Escutcheon for 4" Mounting

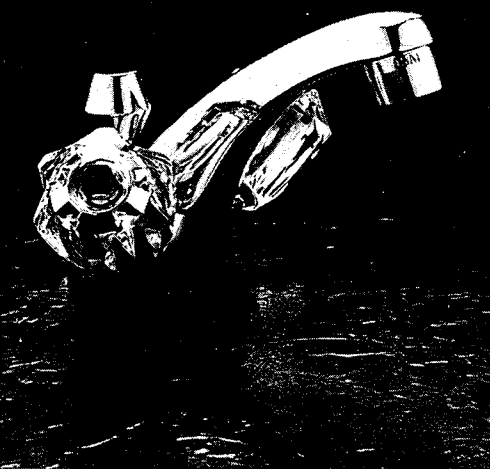

Classic Kitchen Deck  
with Single Basin Tap



# European Originals by GROHE

Grohe of West Germany has a 46-year tradition of excellence for distinctive design, quality and craftsmanship.

If your style is European or Classic Contemporary, choose an original... GROHE.

Available in polished chrome, 23-karat gold, antique, pewter and satin brass finishes, Grohe products enhance every kitchen, bath or spa. Grohe... engineered like no other faucet in the world.

Write or call:  
GROHE AMERICA, INC.  
Subsidiary of ITT  
2677 Coyle Avenue  
Elk Grove Village, IL 60007  
(312) 640-6650

WATER + COMFORT



Circle 29 on inquiry card

Relaxa Personal Shower System

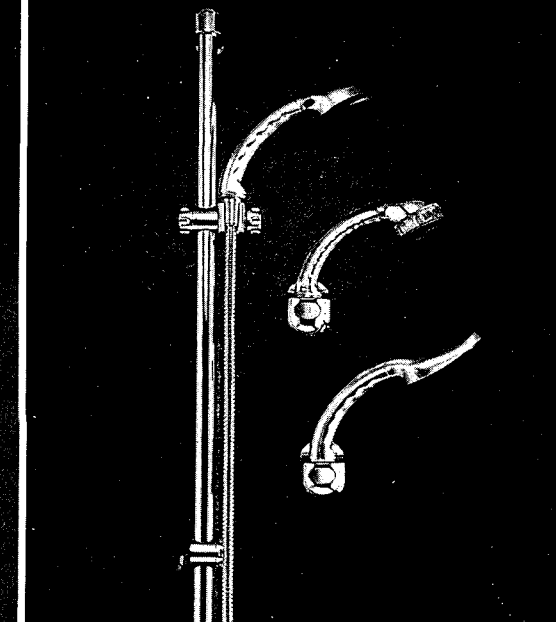

Classic Widespread  
with Swivel Spout

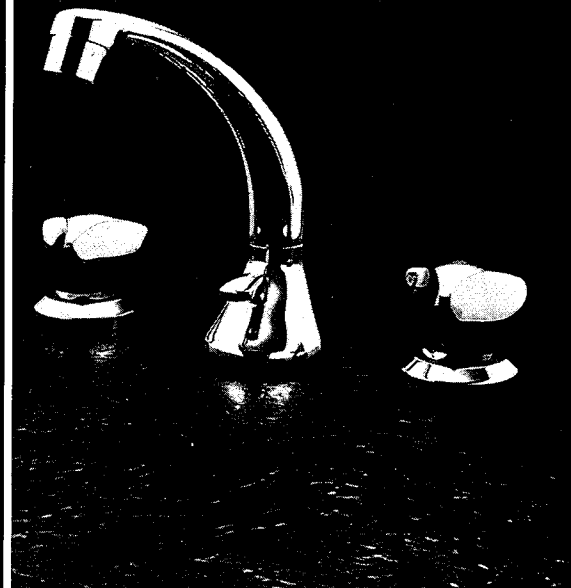

Roman Tub Filler  
with Personal Shower



Euromix Kitchen Deck  
with Hose and Spray





# Naturalite, your single source for skylights.

You are successful because your structures are design oriented and because they work. We became America's largest skylight company for the very same reasons.



Kimbell Museum of Art  
Fort Worth, Texas

You can count on Naturalite to meet your aesthetic requirements. Equally important, Naturalite will gladly assist you from the design phase forward to insure enduring performance.

If you choose, Naturalite will work with you in determining proper illumination levels, taking into account such factors as activities, room sizes, and building orientation.

Naturalite will also help establish energy considerations through a computerized system which simulates local energy interactions. This data can then be interpreted into such facts as energy cost/savings and pay-back projections.

With Naturalite's Illuminometer system, daylight levels can be constantly monitored and artificial

Sombrilla provides shade for southwestern university commons area.



University commons  
sombrilla.

lighting automatically switched on or off, resulting in dramatic energy savings in many cases.

Finally, Naturalite can execute your design in acrylic, glass or polycarbonates. And, we are equipped to install larger custom applications almost anywhere.

See Sweets insert 7.8/Na or contact the factory. Specify Naturalite skylights. The only skylight source you really need.



Residence  
Kansas City, Missouri



Tuesday Morning Company  
Dallas, Texas



J.C. Penney Store  
Abilene, Texas

## NATURALITE®, INC.

3233 West Kingsley Road,  
Garland, Texas 75040  
Box 28636, Dallas, Texas 75228  
(214) 278-1354

FOR INFORMATION CALL:  
Jim Wozniak, V.P. Arch. Design  
(Toll Free) 1-800-527-4018

Circle 30 on inquiry card

# Why is an ICF Kitchen a little bit better?



photo: PETER PAIGE

# ICF

**Boffi**

International Contract Furnishings Inc.

305 E. 63rd St., New York, N.Y. 10021  
Telephone: (212) 750-0900  
Telex: 236073/ Cable: Confurn NY

ICF Kitchen Cabinets  
Model: Glacé  
Designer: Luigi Massoni

ICF/Chicago  
tel: 312/222-0160

ICF/Los Angeles  
tel: 213/659-1387

ICF/Houston  
tel: 713/840-7924

ICF/St. Louis  
tel: 314/241-6457

ICF/Washington D.C.  
tel: 202/298-7941

# Because Luigi Massoni pays attention to details.

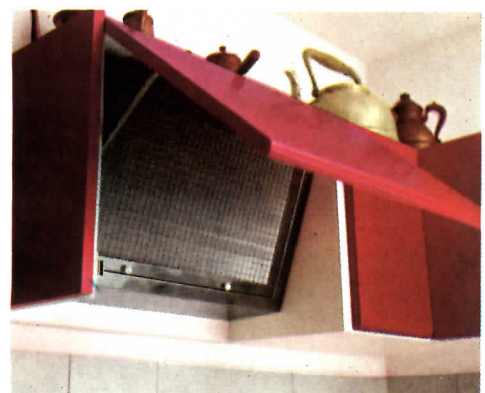
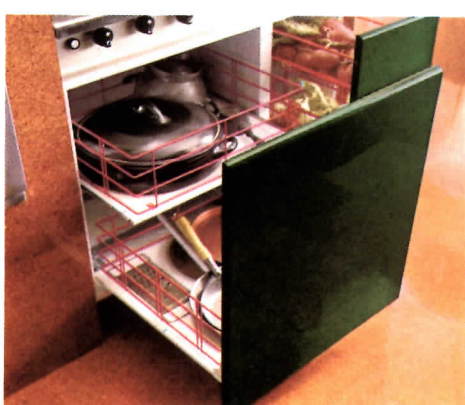

Because, not only is the Glacé kitchen made in several genuine wood veneers, it is also offered in polished high-gloss colors (a finish that requires 43 separate hand operations to achieve).  
 . . . for each size cabinet, there is a wide selection of interior components, to utilize optimum storage space efficiently.

Because there is no visible hardware to detract from a clean-line minimalist design.

. . . the structural panels are  $\frac{3}{4}$ " thick (unlike most others which are  $\frac{5}{8}$ " or less).

. . . the backpanels create an impenetrable barrier against mildew and humidity.

Circle 31 on inquiry card

Because custom-size cabinets are offered to create wall-to-wall, floor-to-ceiling installation.

. . . spare parts are always available to make later changes or to move to a new house.

We hope you'll agree, an ICF Kitchen is not just a little bit better, an ICF Kitchen is the best!





A new freedom of design is made possible for low and mid-rise construction by Inryco Curtain Walls. Sweeping curves, sculptured surfaces, subtle or striking colors, matte or glossy finishes—as you want them.

Send for more information in Catalog 13-1. Write INRYCO, Inc., Suite 4033, P.O. Box 393, Milwaukee, WI 53201.



**Inryco**  
an Inland Steel company

# CURTAIN WALLS BY INRYCO

Circle 32 on inquiry card

A classic statement of good taste, IAC ceramic tile is the ideal surface for contemporary livability. Combining beauty, warmth and easy care, IAC tile provides flexibility in the choice of complementing woods, fabrics and other materials. Another practical side to IAC tile is its durability, hard finish and low moisture absorption . . . making it the preferred surface for heavy traffic areas in both residential and commercial environs. The beauty and practicality of IAC "single-fired vitreous" ceramic tile is the result of a "state of the art" technologically advanced process not used by any other U.S. tile manufacturer. IAC tile is offered in a range of sizes with finishes in neutral, earthtone and solid colors, and is available from independent distributors throughout the United States. For complete information on IAC tile and the name of your nearest IAC distributor, call 1-800-331-3651. You'll also find us in the 1982 Sweet's General Building File.



INTERNATIONAL  
AMERICAN  
CERAMICS, INC.

P.O. Box 6600 · Tulsa, OK 74156  
Call Toll Free: 800-331-3651  
In Oklahoma (918) 428-3851  
Telex: 79-6044

Circle 33 on inquiry card

# BEAUTIFUL, WARM, LIVABLE...IAC CERAMIC TILE!

Residence of Mr. & Mrs. Don Kumin, Cleveland, Ohio.  
Shown is 8x8 Briar. IAC tile is available  
in 4x8, 8x8, 8x12 and 12x12.



it's made in America!





*Texas Commerce Tower, Houston  
Architect: 3DInternational  
Contractor: James Contract Draperies, Inc.*

*U.S. Steel Building, Pittsburgh  
Architect: Harrison & Abramovitz*

*Twin Towers, Arlington, Va.  
Architect: Hellmuth, Obata & Kassabaum, P.C.  
Contractor: Kenfair Manufacturing*

*Capital Bank Plaza, Houston  
Architect: Lloyd Jones Brewer & Associates  
Contractor: Contract Drapery, Inc.*

## **Bali Blinds fill tall orders**

Houston, Pittsburgh, and Arlington, Virginia. Wherever there are tall orders to fill, more and more architects and contractors are selecting Bali Blinds for commercial buildings.

Bali makes it easy. With a responsible bid. Predictable delivery. A quality, fashion blind. And service that does not end once the blinds have been shipped and installed.

So when you have requirements for window coverings, study our brochure in your Sweet's Catalog located under 12.9 mini-blinds. Then select Bali. We fill tall orders.

For more information write: Bali Blind Brochure #8005, Marathon Carey-McFall Company, Loyalsock Avenue, Montoursville, Pennsylvania 17754, (717) 368-2621. A Division of Marathon Manufacturing Company.

 **BALI BLINDS**<sup>®</sup>  
BALI IS BLIND IMAGINATION

Circle 12 on inquiry card

**WE SHOOT FOR MORE THAN  
THE STATE OF THE ART.**



Because there's always the moon. Always that point far beyond the norm to reach for. To perfect, through innovative engineering.

For example. Amarlite's newest products reflect how we squeeze superiority out of the state of the art.

Our new Express Set Glazing System, ESS, is designed for quick and simple installation. Minimum labor, modest cost.

The new, thermally improved Ribbon Window Framing System, NRG, gives extraordinary energy saving performance by restricting heat transfer. And is also designed to minimize labor in installation.

And the new Framing System for Insulated Glass, TWS-II. Its interior insulating capabilities provide remarkable performance against air and water infiltration. And again, labor-saving installation.

The reason Amarlite doesn't sit still is why we're growing. We're never satisfied with new. Only best.

It's your satisfaction we're after.

**AMARLITE<sup>®</sup> Anaconda**  
A unit of ANACONDA ALUMINUM Company



# the sitecraft bench

The beauty of a Sitecraft bench...it's a lot more than skin deep.

2. 12sf in Sweets

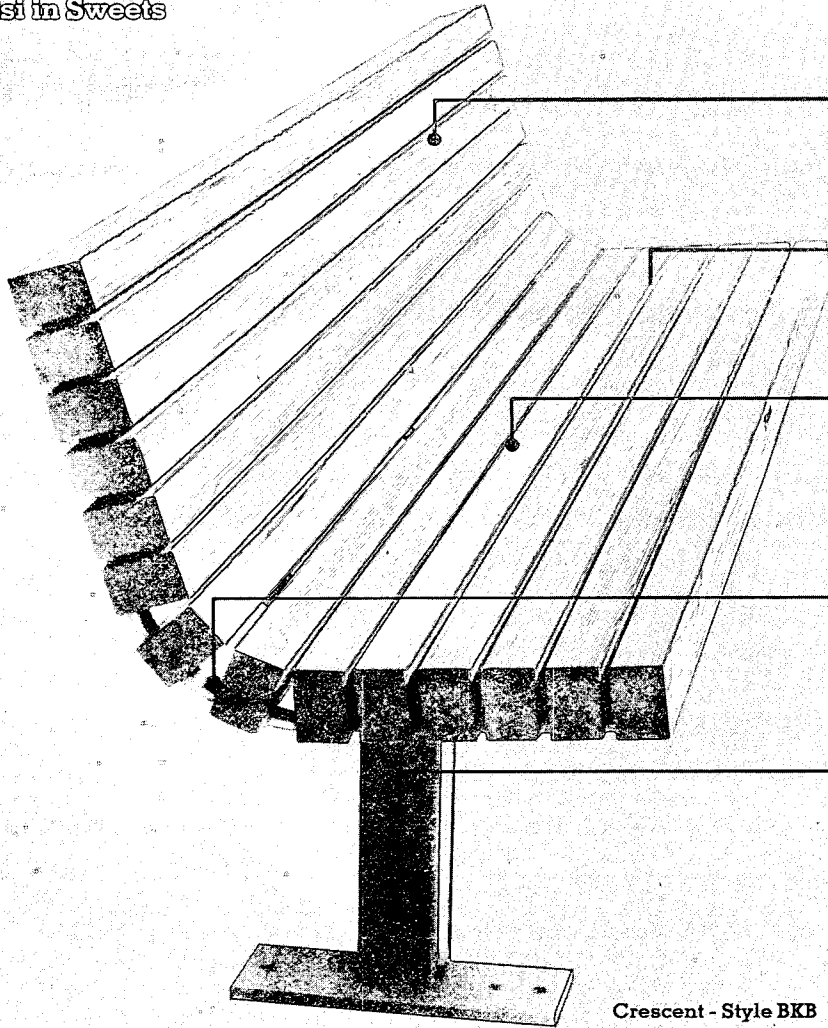

## The Wood...

Clear, all heart California redwood. Nominal two inch dressed to one and three quarter inches thick.

## The Hardware...

Each bench member is attached to the supports and straps with two inch, tamper resistant "one-way" screws.

## The Finish...

All wood surfaces are covered with a clear sealer/preservative especially developed by Sitecraft.

## The Supports...

Two, three inch wide pre-formed steel supports plus a minimum of three, one inch wide auxiliary steel straps. Bronzestone enamel finish.

## The Pedestals...

Three inch square steel tubes designed for surface, subslab or embedded application. Bronzestone enamel finish.

## The Options...

Philippine Mahogany, Oak or Cedar, custom sizes and special finishes.

Crescent - Style BKB

## NINE DIFFERENT STYLES THIRTY EIGHT DIFFERENT SIZES

All Sitecraft benches are shipped fully assembled, finished and ready for installation. For specific prices and shipping information call or write Sitecraft.

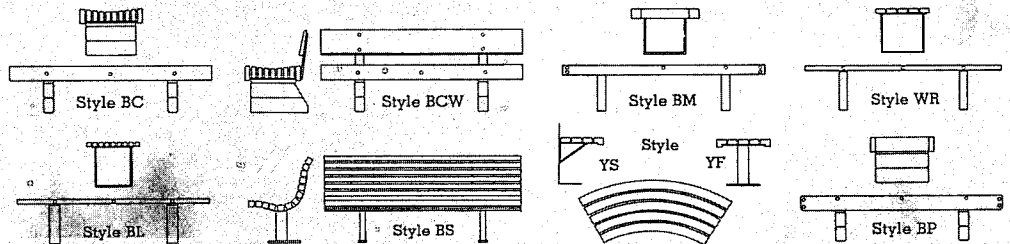

In addition to benches, we offer a complete line of planters, planter benches, receptacles, and site accents including stools, tables and decking. Also, allow us to work with you from the beginning on custom site furnishings. All the necessary design, engineering and wood crafting skills are available to you at Sitecraft.

For a complete color catalog that includes product descriptions, specifications, prices and ordering

information call or write: Sitecraft, 40-25 Crescent Street, Long Island City, New York 11101 (212) 729-4900. For your convenience, call toll free except in New York State 800-221-1448.



Circle 36 on inquiry card

**Jason/Pirelli**

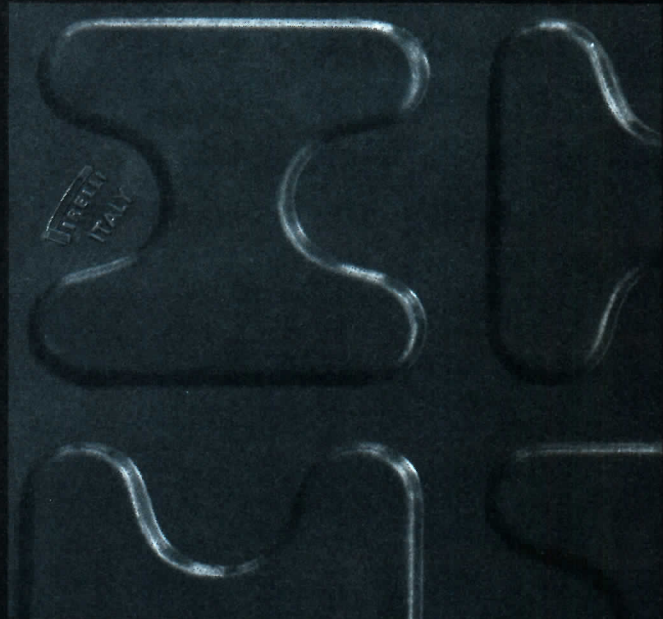
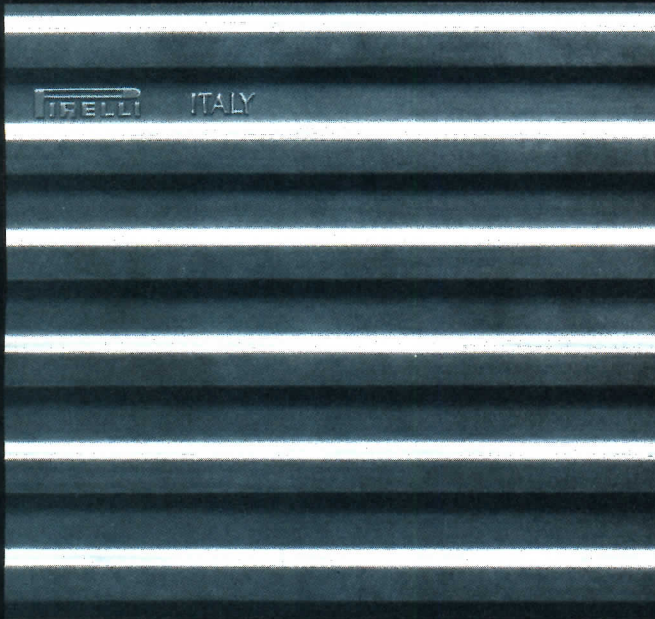
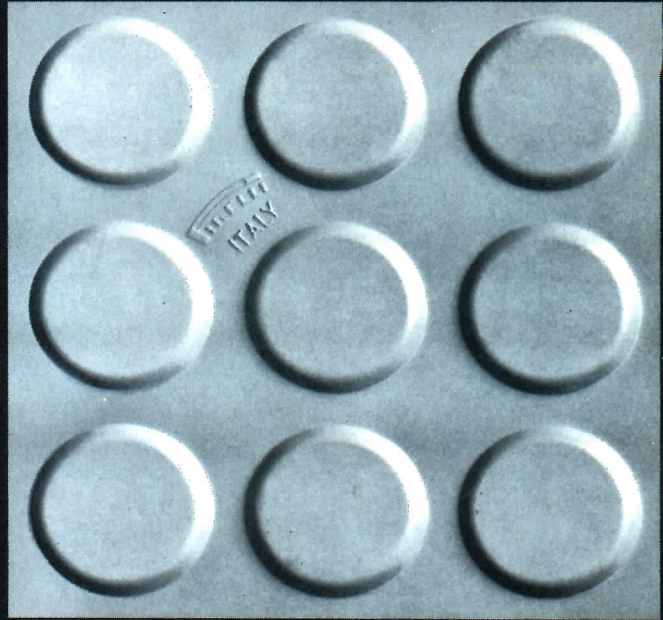
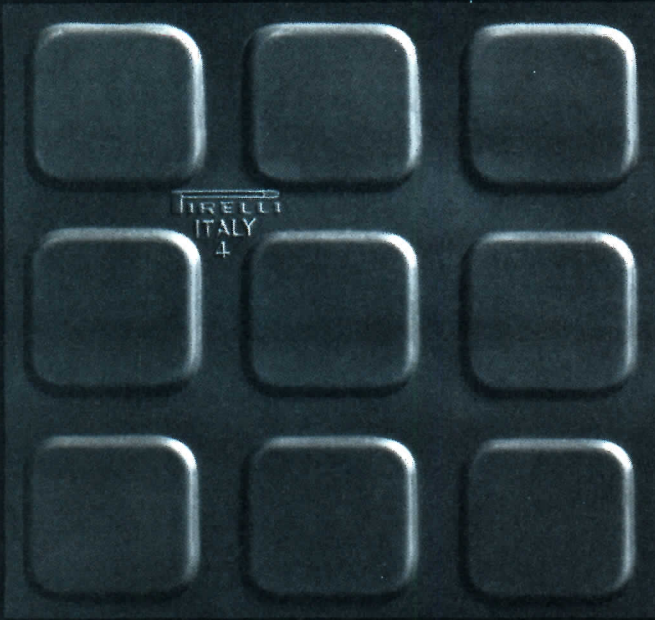

**High Performance—Four on the Floor**

Beauty and durability in four original rubber flooring designs by Pirelli, the reference standard. From Jason Industrial, the industry standard for service and performance.



Jason Industrial, Inc.  
Rubber Flooring Division

340 Kaplan Drive, Box 507  
Fairfield, NJ 07006  
Telephone 201 227 4904

Circle 37 on inquiry card

# When your eye says beauty, but logic demands performance...

Anso IV makes a carpet more beautiful...and keeps it fresh and newer looking far longer. Anso IV dyes deeper than other nylons so colors are sharp and clear. And they stay that way with no spray-on protective coating to dull them. Styling is rich and beautiful, patterns crisply defined, in all lusters, deniers and finishes.

Anso IV actually resists soil, spills and stains others try to hide. Only Anso IV offers built-in, 4th generation protection to make routine care faster and more effective, improve appearance retention, postpone cleaning and reduce maintenance problems and costs. No other contract nylon can match its effectiveness. Don't settle for less than the best!



Project: University of Minnesota-  
Duluth

Carpet Mill: Bigelow-Sanford

Fabric: Pebblepoint

Color: Coffee

Designer: Bill Moser  
Architectural Resources

Dealer: Commers Interiors

Project: Bankers Trust Company  
Headquarters, New York

Carpet Mill: Gulistan

Fabric: New Generation IV

Color: Cedar

Designer: Designer Group  
Bankers Trust Company

**Anso<sup>®</sup> IV**  
ALLIED CORP. NYLON

The 4th generation nylon that  
made all other carpet fibers obsolete.

**ALLIED**  
Corporation

1411 Broadway, New York, NY 10018

Circle 38 on inquiry card

# The busier you are, the better it looks.

Do three things at once—easily! With Elkay's deluxe three-compartment Cuisine Centre.™

Prepare food in one of the extra-deep, stainless steel sink compartments. Drain dishes in the other. And toss scraps into the special disposer compartment.

For even greater convenience, we've added a custom-fitted, hardwood cutting board, and rinsing

basket. And you'll especially appreciate the added luxury of the dual-handle Elkay faucet with swivel aerator, spray, and deck-mounted drain releases.

Make it easy on yourself with the ultimate in kitchen convenience... the Elkay Cuisine Centre.

**Elkay style. Reflected in everything we do.**



MODEL NO. LCR 4322-C

**Over 20 million consumers will see this ad. That's Elkay selling for you!**

# ELKAY®

Send for our new, full-color, 26-page brochure on Elkay sinks, faucets, disposers and accessories. Please enclose 50 cents for handling.

Elkay Manufacturing Co., 2222 Camden Court, Oak Brook, IL 60521

Circle 39 on inquiry card



# RECORD HOUSES

---

## 1982

The seventeen award-winning houses that make up this year's issue are uncommonly, uncompromisingly diverse. Take, for example, the cover house by Susana Torre or the white box by Redroof Design—a box that wears an old barn as an outsized, unbuttoned overcoat (pages 104-107). These are but two of a group that bow to the elegant and often elaborate forms of the past without neglecting the fresh opportunities of the present. The intentionally nostalgic Block Island house by Venturi, Rauch and Scott Brown (pages 54-57) may seem to belong to this group too, at least in spirit. But the Block Island house, unlike the other two, is modeled in forms of the utmost simplicity, forms that in less sensitive hands might have trailed off into insipidity, or worse, into a vacuous period piece. That it escapes both fates, that the house retains its vigor and ends by beguiling us, is a fine tribute to architects long comfortable in the border zone between vernacular building and forms more consciously derived, architects who invest all their designs—like carpenters of old—with a host of personal touches.

But if the mixing of old and new is a recurrent feature of this year's houses, it is by no means the only design theme. The Lewis house by Don Metz (pages 96-99) and the house Jeremiah Eck designed for his family (pages 80-83) are among those that explore the issue of energy conservation, an issue made no less urgent by a temporary glut in oil reserves. One is underground, the other above, but both attack the energy problem practically and without any apparent willingness to sacrifice either comfort or liveability. Peter Wilson's Fire Island house (pages 76-79), a house fairly brimming with metaphor and exuberant imagery, seems to be raising a whole battery of questions—and all at once, but the answers Wilson offers are fun, and point the way toward new kinds of visual enrichment. Houses by Gwathmey Siegel and Associates (pages 116-120) and by Hugh Newell Jacobsen (pages 58-63) seem more familiar for they are executed in design idioms that these architects have long since made their own. But so complete is their mastery of materials and technique, of texture, tone and detail that the designs they have created will repay sympathetic study even by architects moving in very different directions. Whatever these directions, and however varied the means, the goal remains pretty much the same: something fresh, something personal, something better. —*Barclay F. Gordon*

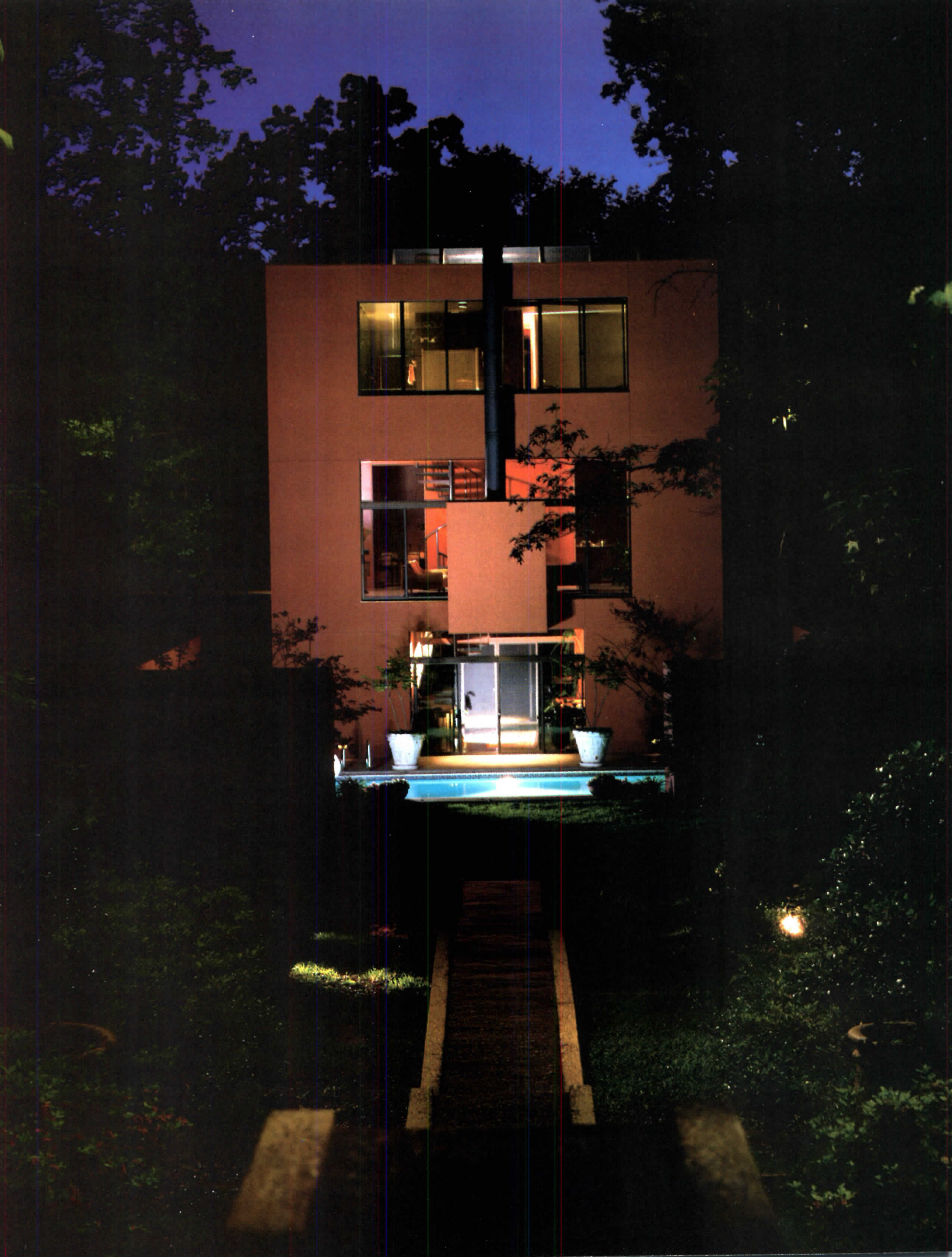

# THE ALLEN HOUSE LONGVIEW, TEXAS BY ALLEN/BUIE

When it became apparent that this narrow, low-lying lot would not find a buyer, architect Robert Allen—whose firm owned and sold the adjoining properties—decided to build on it himself. “You stick your neck out when you do this,” says Allen, “because you know you are making a very personal statement.” But whatever its self-conscious qualities, the house he designed with partner James Buie is shaped by a host of practical concerns, and by an obvious sensitivity to the site’s topographical irregularities.

To preserve as many trees as possible, and to compensate for the lot’s sharply falling contours, Allen designed the house on three levels. The middle level (see plans) contains the main living spaces and it is tied back to street level by a bridge. Three bedrooms occupy the upper level, while the ground floor is given over to a carport and family activity area. All three levels are linked by a circular stair.

Three of the Allens’ four children have grown up and moved out. Sort of. “Trouble is,” says Allen, “they never take anything with them when they go.” The remark, more whimsical than rueful, acknowledged a storage problem familiar to many a household, and fixed its source firmly in a characteristic pattern of American life.

In all other respects, the design is comfortable and satisfying. It meets the owners’ wish for a certain formality, and yet leaves them ample freedom for experiment and individual expression. In some of its particulars—in the garden concept for example—the design reflects the deep impressions left on Allen and his family by a recent visit to the villas and hill towns of northern Italy. The long water cascade (photo lower right) with its intentionally narrowed perspective, the use of uncarpeted marble floors, and the terra-cotta color of the house itself—a color that softens the strict angularity of the volume—were all adapted from an amalgam of impressions carried back across the Atlantic. But melted down and reminted, these forms seem perfectly at ease in this setting, and grace it with a character and distinction unexpected. —B.G.



**Architects:** The Allen/Buie Partnership  
1000 Pegues Place  
Longview, Texas  
**Owners:** Mr. and Mrs. Robert Allen  
**Engineers:**  
Hixson & Harris (structural)  
John J. Guth Associates (mechanical/electrical)  
**Landscape architect:** Joseph Bramlette  
**Contractor:** M. Cline Brown Company  
**Photographer:** Hursley & Lark

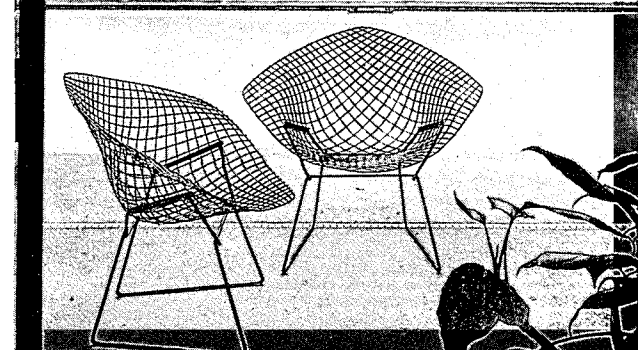
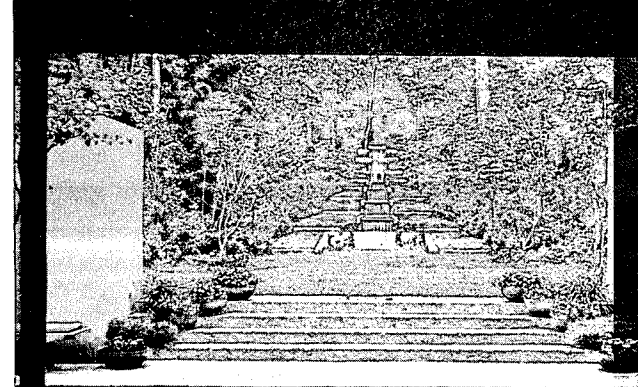
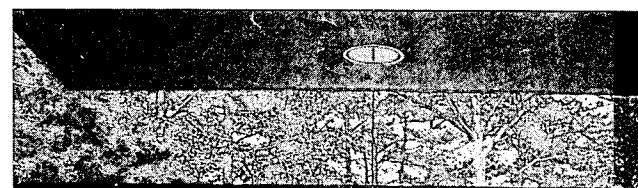
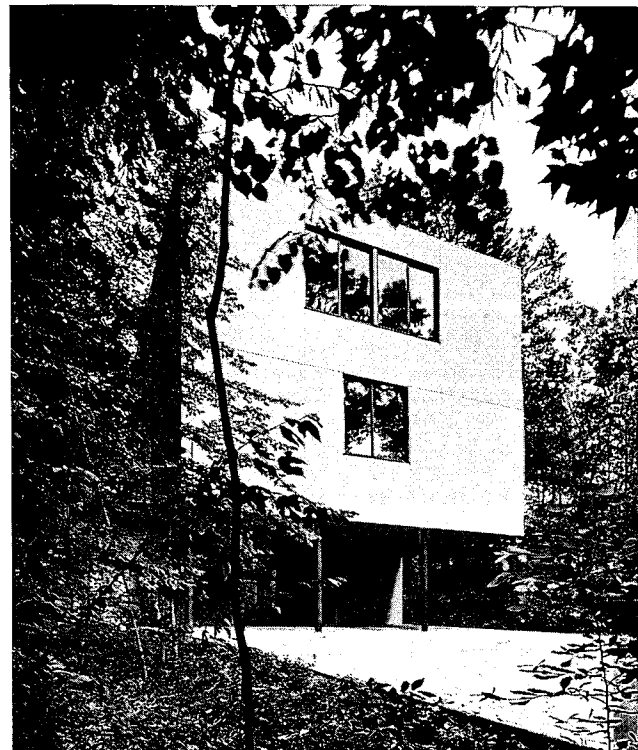
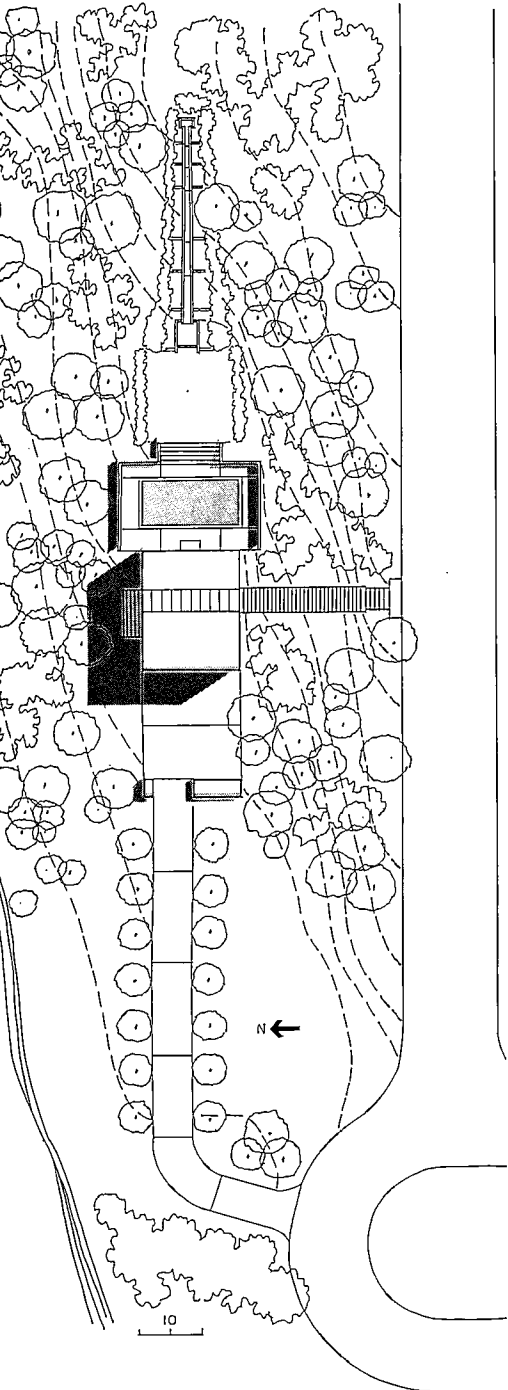



Daylight from the windows is balanced overhead by light from a plastic barrel vault over the circular stair. Photos at left and below show the kitchen and living room respectively. The terra-cotta color is carried from the outside to the interiors where it gives warmth to wall planes and contrasts effectively with the range of finishes and furnishings.

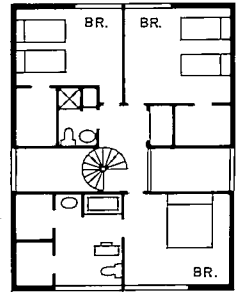

THIRD LEVEL

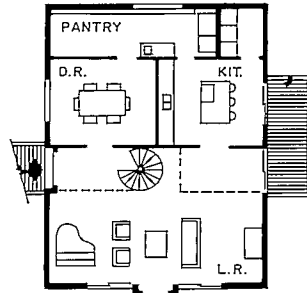

SECOND LEVEL

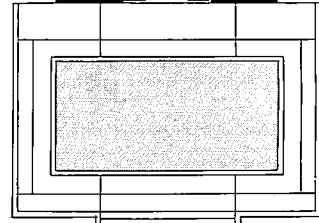
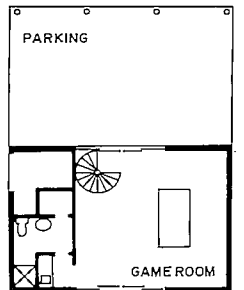

FIRST LEVEL

5

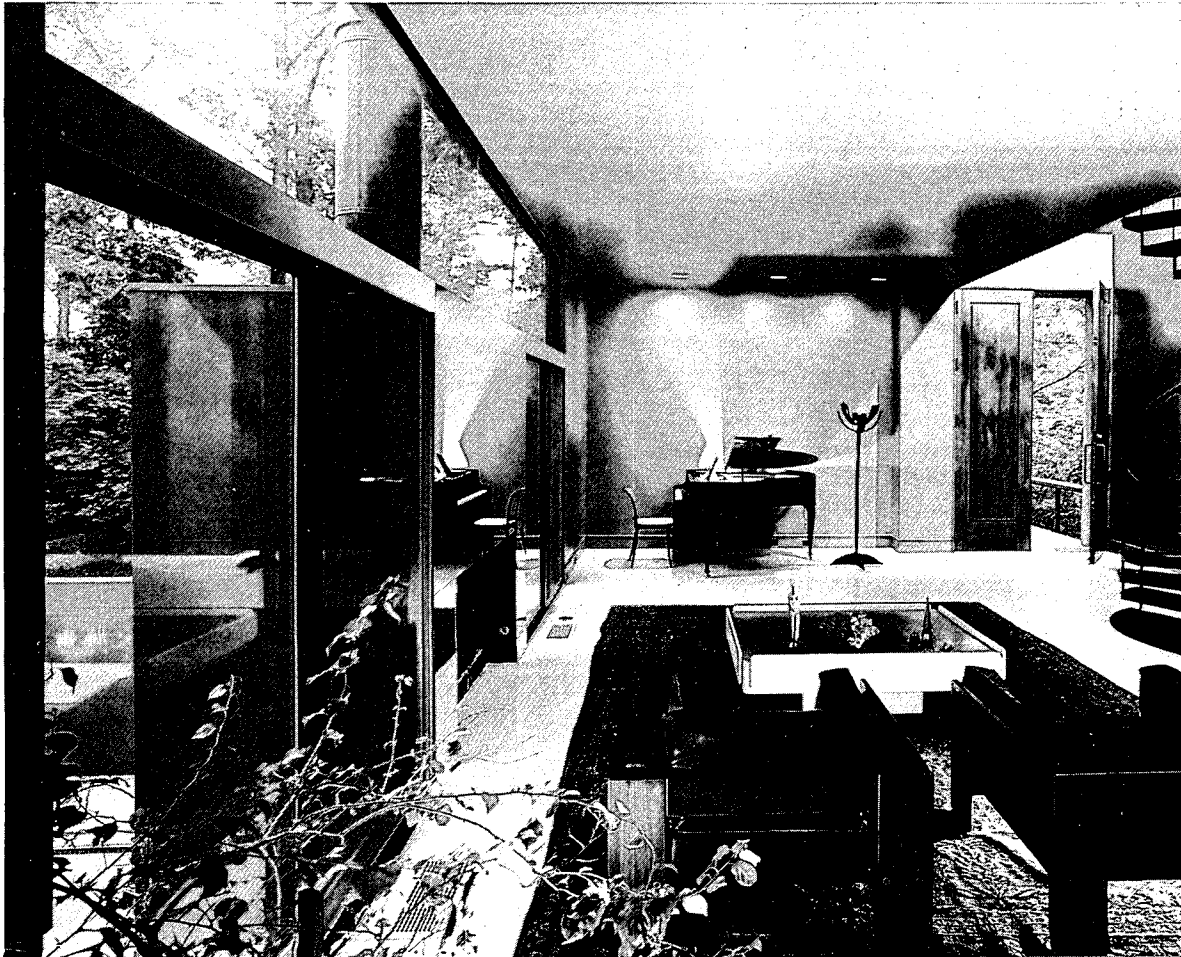



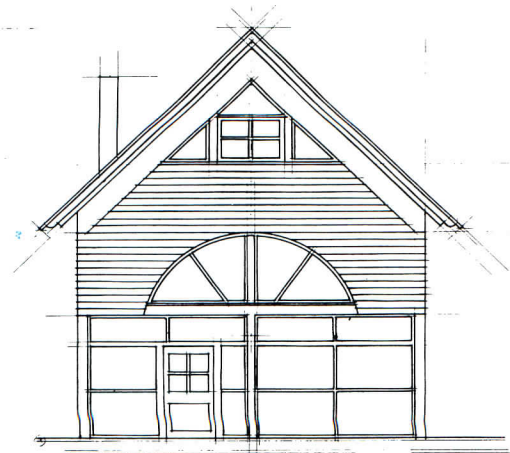
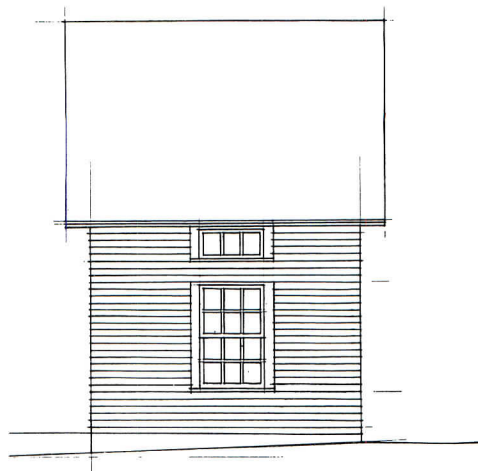

# THE COXE STUDIO BLOCK ISLAND, R.I. BY VENTURI, RAUCH AND SCOTT BROWN

We know these little buildings, sitting alone out in a field. We've seen them before: in an old photograph, in a child's drawing, in other fields. They are a familiar and welcome sight.

Look again. These are not those little buildings.

Initially, they appear as indigenous to the landscape as the stone wall trailing down toward the pond—twin sentinels looking out over the water. For most of us, a "shingle-sheathed box [or two] with gables" will suffice to identify the vernacular; Rhode Island historians, however, will include the "temple" proportions of the facades, and the overscale barge boards, to more accurately pinpoint the "countrified Greek Revival" style endemic to southern New England. But the small house and smaller guest house participate rather than assimilate. They are sophisticated architectural immigrants wearing the local building traditions and materials with the self-confidence and poise of a native.

The windows reveal the other story—the one based on the 11-page program client Weld Coxe submitted to architects Venturi, Rauch and Scott Brown. Since the house was designed from the outside-in, partner Robert Venturi moved, if not heaven and earth, at least walls and floors to accommodate Coxe's enumerated needs and preferences (captions overleaf). The windows register the activity, and the three—not two—floors within. They also provide, by their irregular placement, a magnetic visual charge for the exterior: and by their grand scale, according to Venturi, the little house is made "gracious," not "mean and fussy."

The tension between the general form and the unexpected modifications to that form engages our eye, brings us out of the merely picturesque, invites us in. That play between the familiar and the special is particularly appropriate, considering Coxe's request to "keep it simple, and make it architecture." —C.K.G.

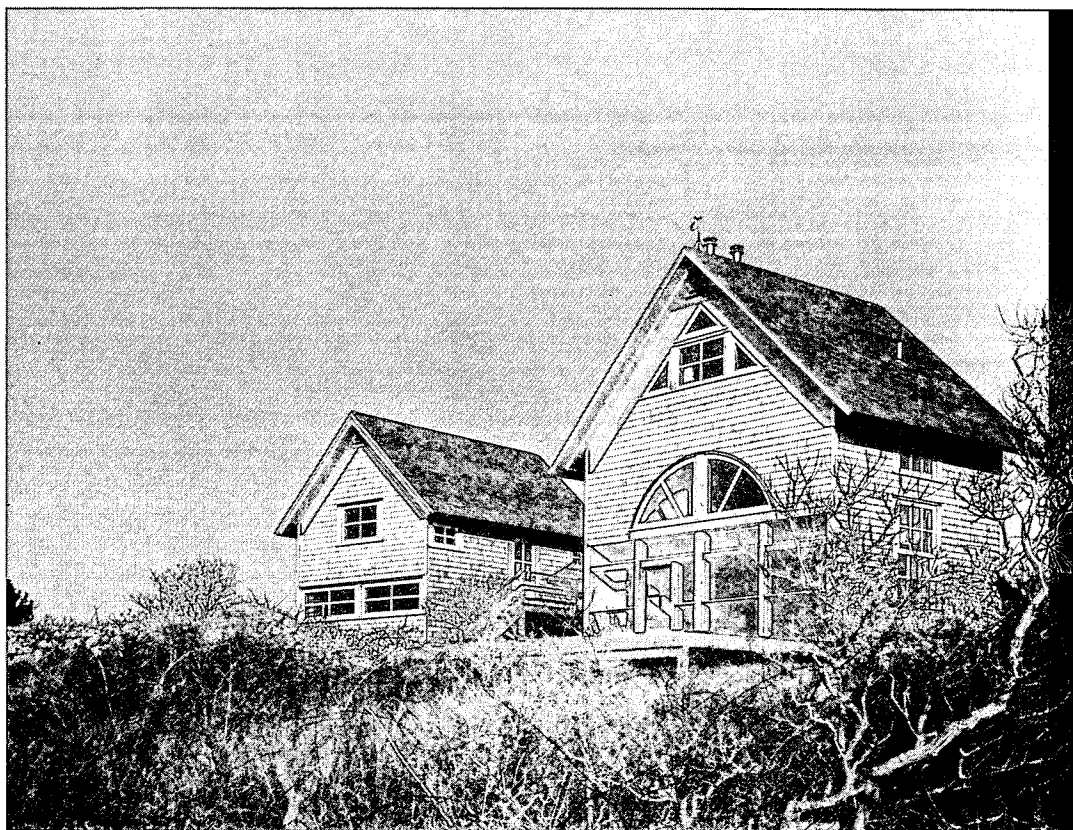

**Architects:** Venturi, Rauch and Scott Brown

4236 Main Street  
Philadelphia, Pennsylvania

Robert Venturi—design  
Frederic Schwartz—project architect

**Owners:** Weld Coxe and Mary Hayden

**Engineers:**

The Keast and Hood Company (structural)

**Consultants:**

Dian Boone (Interiors)  
Total Environmental Action (energy)

**Builder:** Donald M. Coxe

**Photographer:** Thomas Bernard

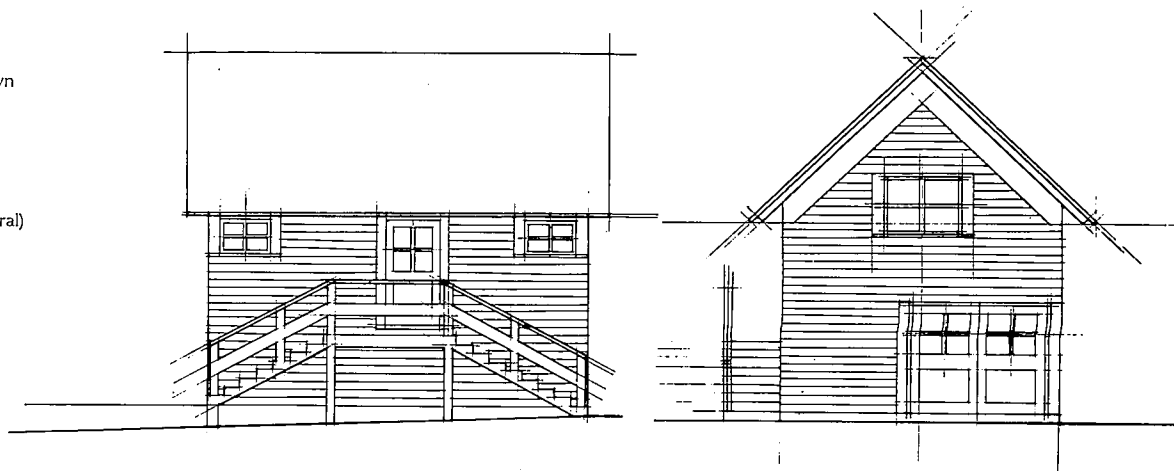

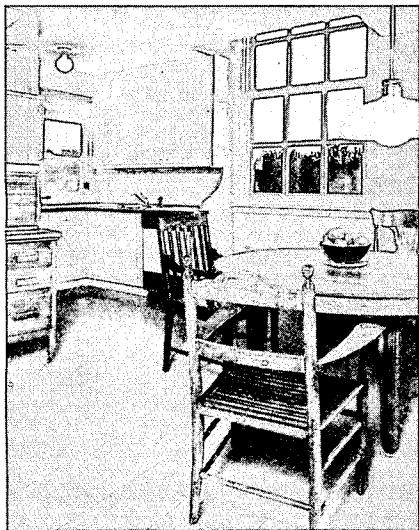
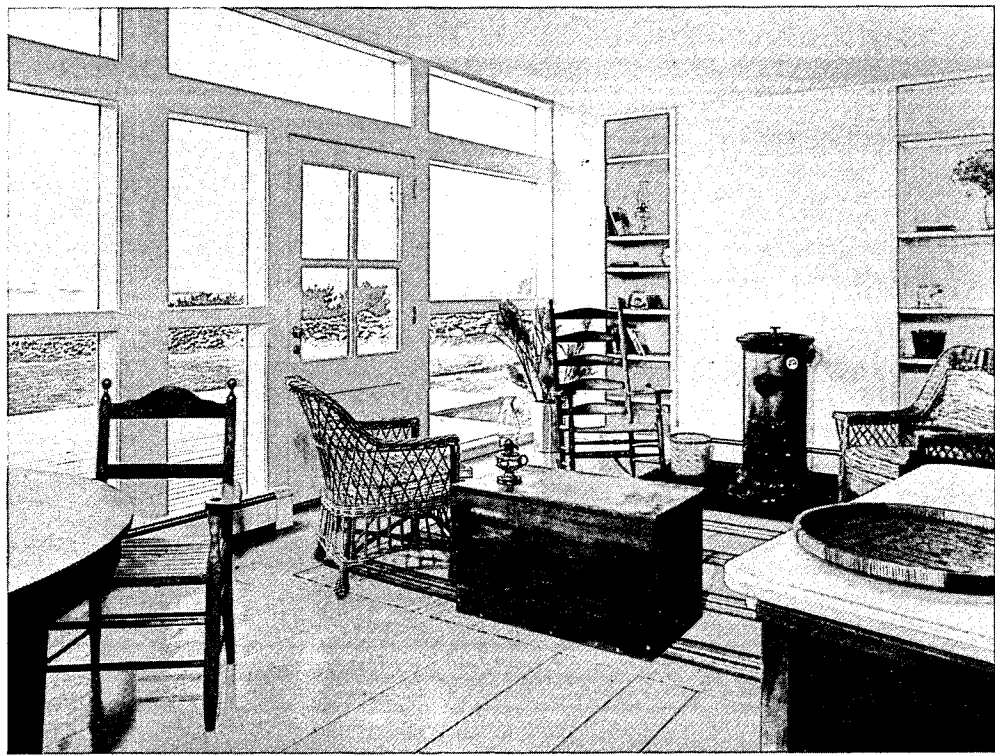

VENTURI, RAUCH AND SCOTT BROWN

Just as the exteriors pay homage to the prevailing architectural climate of Block Island, the interiors show comparable deference to the exhaustive program submitted by client Weld Coxe. In addition to a standard list of functional requirements, Coxe included detailed behavior patterns, preferred views (both out and in), and even the adverse psychological effects of various seating arrangements. The three-room house is tailor-made. The intricate sections (below) illustrate the complex planning gymnastics within the ostensibly simple house—gymnastics duly recorded in the fenestration on the east and west facades (previous page). But even when "historically correct," (as on the north and south facades), Venturi is admittedly "incorrect": note the traditional double-hung window (photo above left)—it's 8-foot-high, a Brobdingnagian dimension for a house that measures 24- by 18½-feet.

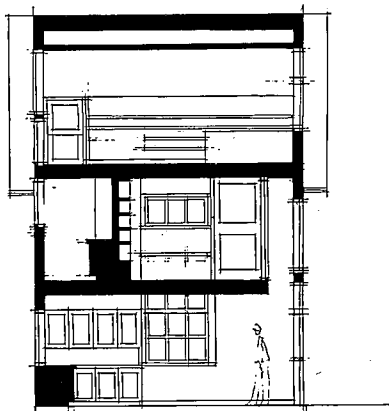
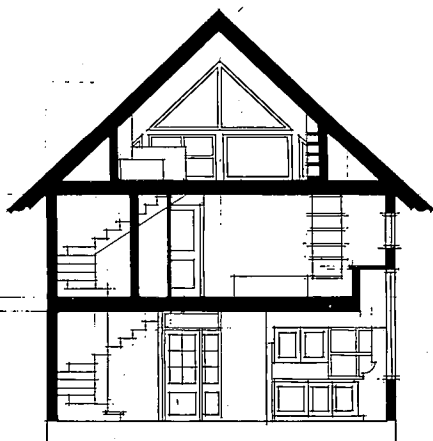
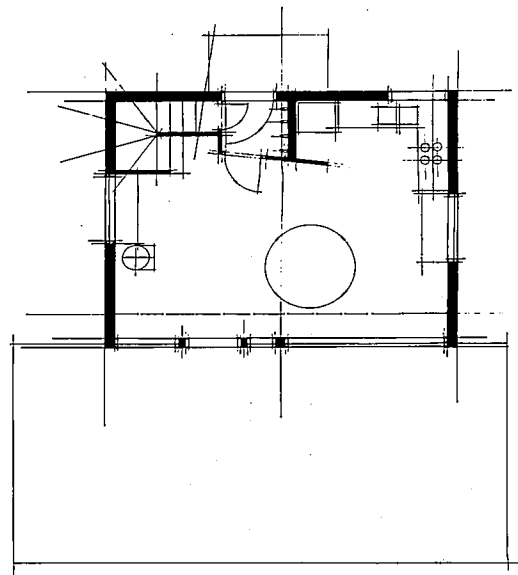
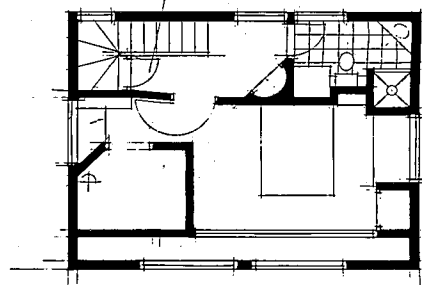
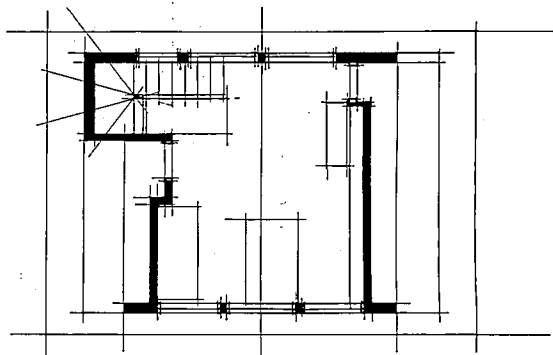





In keeping with the relaxed spirit of Block Island—and the owners' preferences—interiors consultant Dian Boone elected a hodge podge esthetic, re-employing furniture from co-owner Mary Hayden's previous Maine retreat. The beaded-board walls and painted wide-plank floors are especially welcome; similarly, the coal stove, complete with rocking chair. As specified in the program—and by New England tradition—living, dining, and kitchen areas are incorporated into one open ground-floor space; a heavily-glazed vestibule protects that space from blustery winds. While the overscale windows may serve architectural theory for the exteriors, the interiors reap the practical benefits of extra light and more expansive views. The second-floor, mezzanine-style bedroom offers a lunette view of the pond. For construction, Coxe turned to son Donald—an architecture student turned carpenter; according to Venturi, who characterizes the detailing as a "collaborative effort," the choice was a wise one.

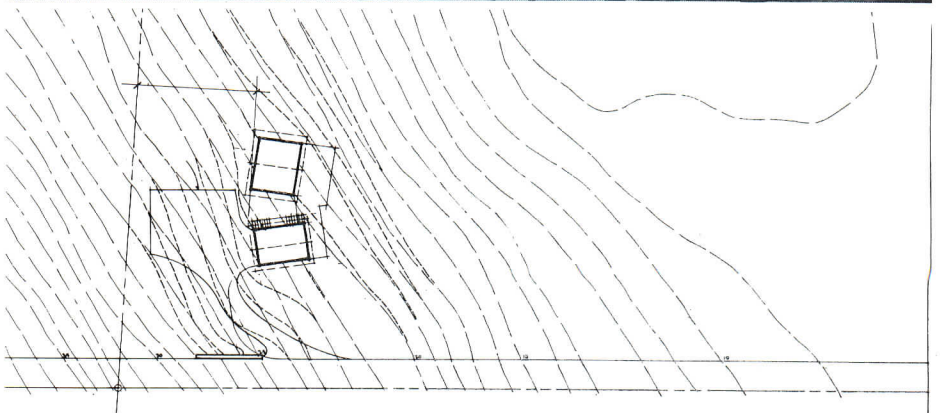
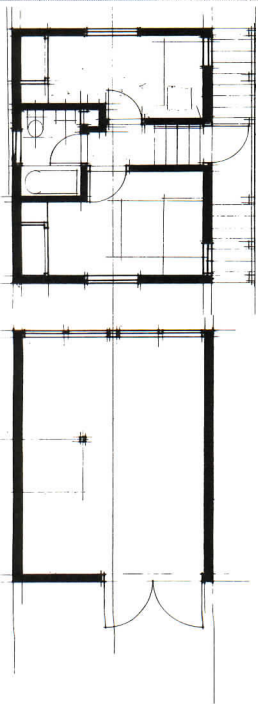
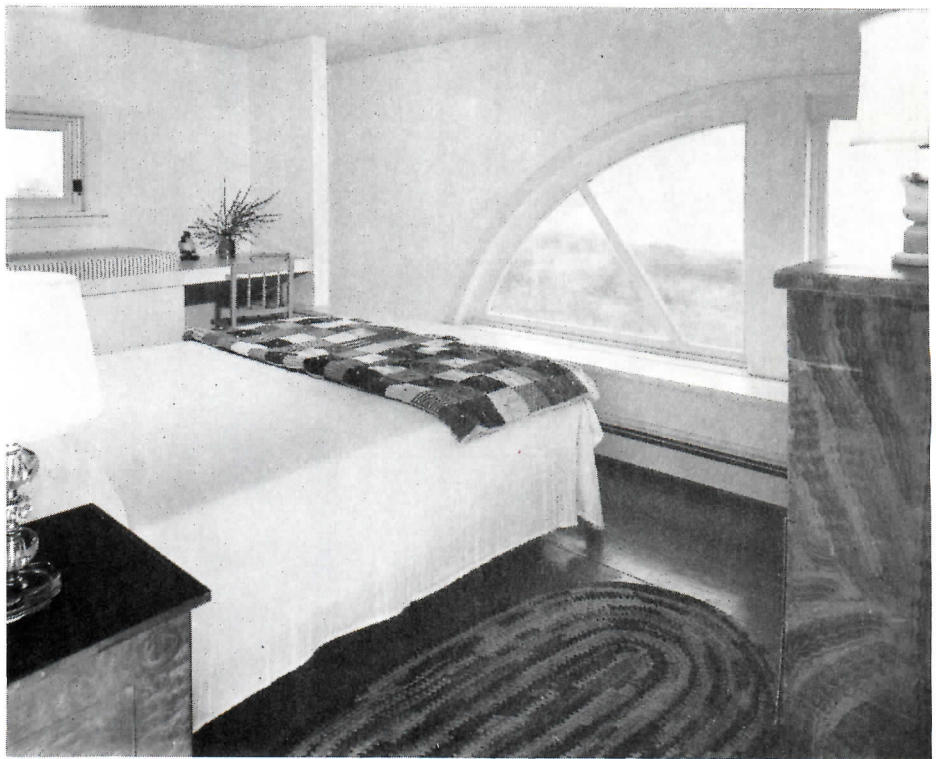



# PRIVATE HOUSE EASTERN SHORE, MARYLAND BY HUGH NEWELL JACOBSEN

Resting quietly on a hummock, as if in an Andrew Wyeth painting, this residence seems the quintessential "house." Jacobsen's career-long interest in abstractions of appropriate contextual and historic allusions again marks his style: the predominant architecture in this rural area of the Eastern Shore of Maryland is Gothic Revival white wood frame.

Shorn of any gingerbread, the basic elements of houses of that period are here—a formal/informal plan and design, multiple gables (each with an oculus), tall chimneys, tall windows, surrounding trellised or glassed-in terraces and porches, and the structure clad in narrow pine clapboards painted white.

But even with all that traditional recall, the simplicity of the forms and elegance of detailing give the house a fresh, timeless quality. It is a big, luxurious house. Jacobsen has given the needed (and very appealing) domestic quality by a minimum of pretension or fad, and by deliberately omitting all evidence of scale—particularly in windows and doors—to visually reduce the actual size of the house in relation to the land. It almost gives the illusion of a one-story house.

Handling of the landscape itself also plays a major design role. The five-foot knoll the house rests on was designed by the architect to abet controlled views of and from the house. As can be seen from the plot plan, an axial focus for the living room at the back of the house (photo top right) through an 800-yard allée was sculpted from the land towards the river view, and the bay beyond, to the south. The axis is continued to create a focus on the building's entry from the approach drive from the north (center right). These are typical Jacobsen touches—simple and direct, yet providing great style and flair.

The plan of the house (see overleaf) continues this axial symmetry and centers on a great (and unexpected) entrance hall. Perhaps it is this deft combination of the comfortably familiar with innovative surprises that gives the house its distinction and appeal. —H.L.S.



*Architect:* Hugh Newell Jacobsen, FAIA  
2529 P Street, Northwest  
Washington, D.C. 20007  
*Charles P. Parker—project architect*  
*Engineers:* Kraas and Mok (structural)  
*Landscape architect:* Lester Collins  
*Contractor:* Harper and Sons, Inc.  
*Photographer:* Bent Rej

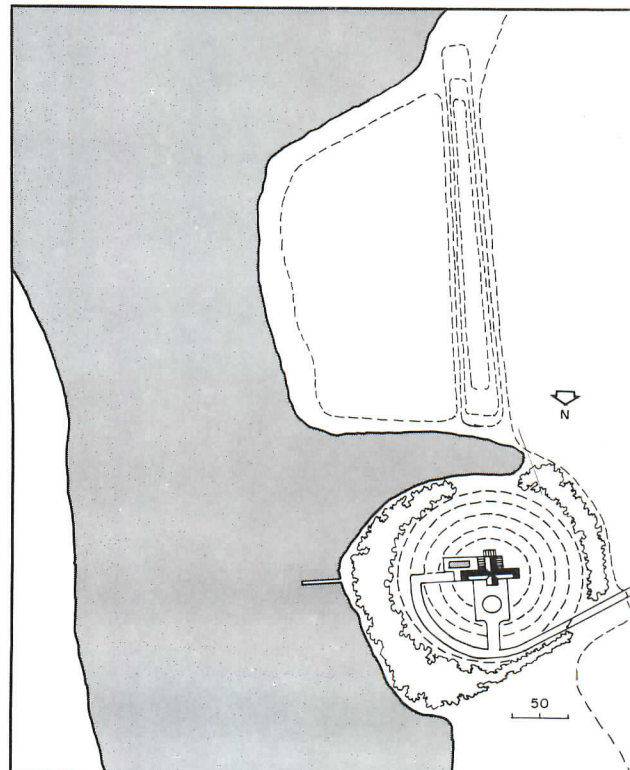



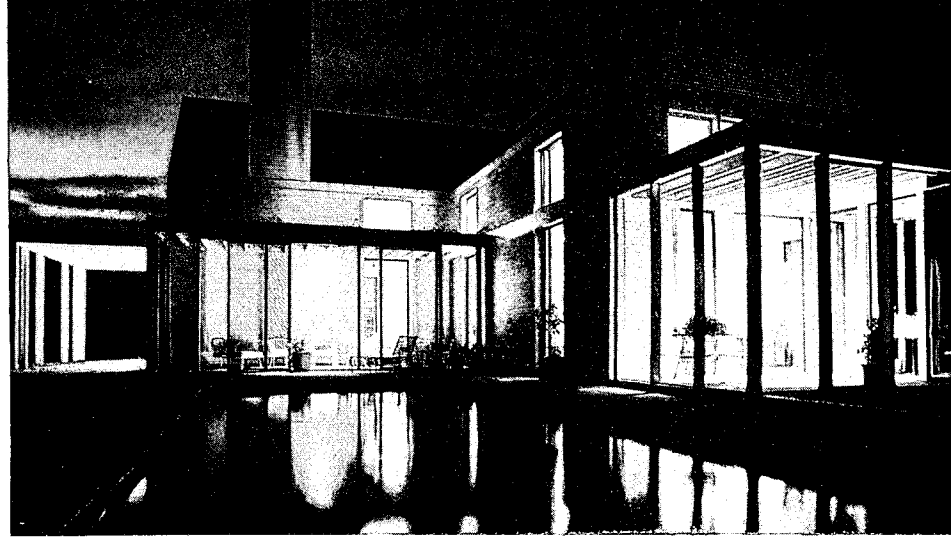
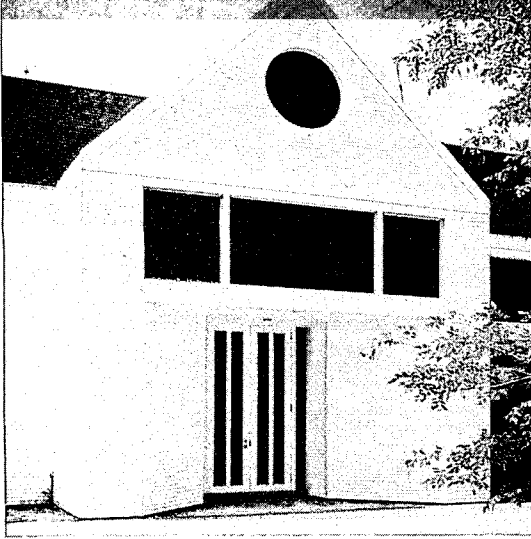

From the recessed enclosure of the entrance (top left), one is quickly riveted by the planned vista through the big living room windows (photo left) to the long corridor of trees and water (below). Lateral views from the house range over well-manicured grounds, and across a swimming pool that is treated almost as a formal reflecting basin (photo above).

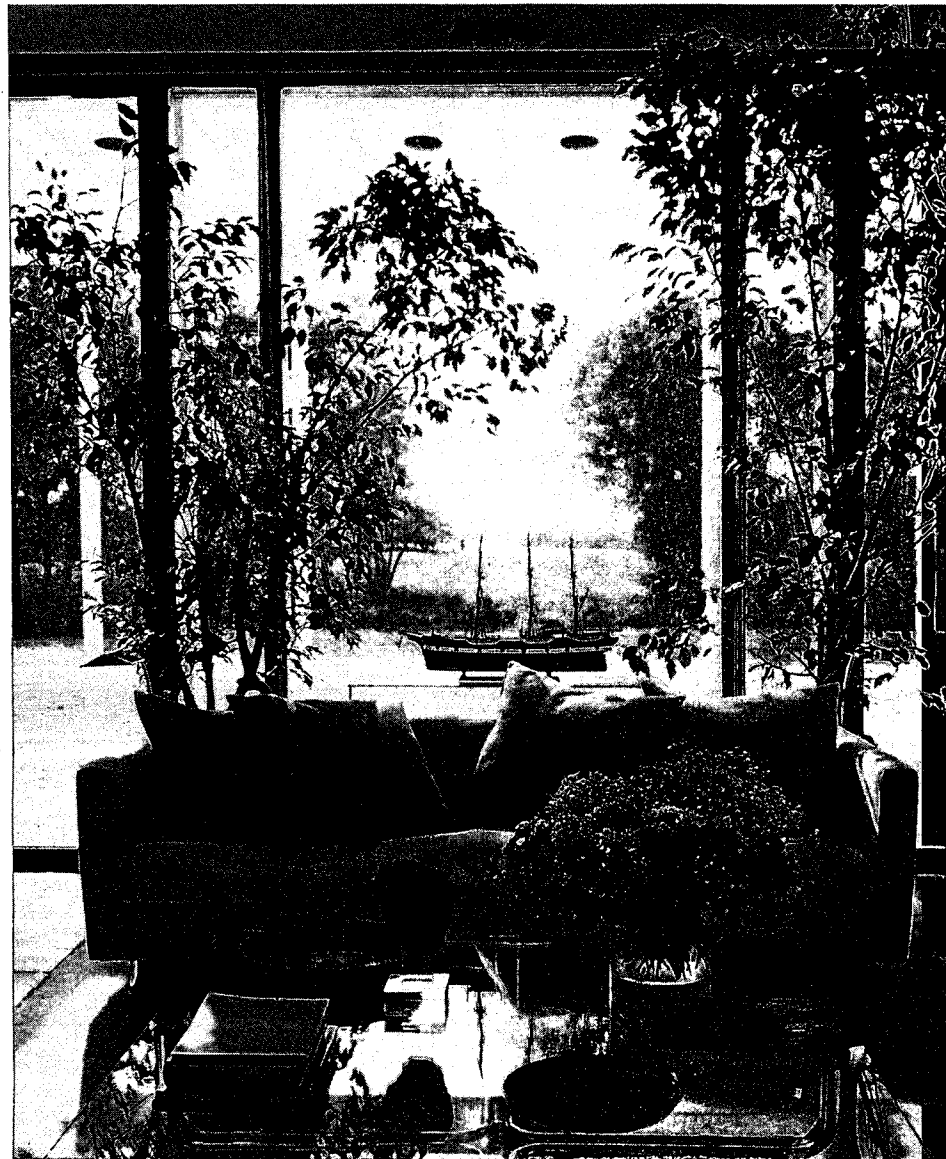
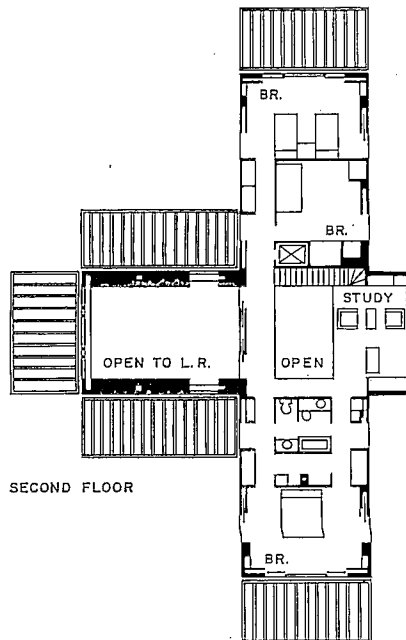
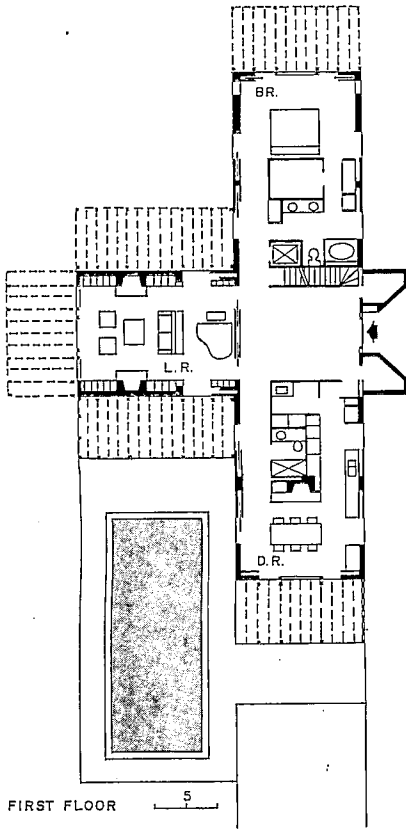



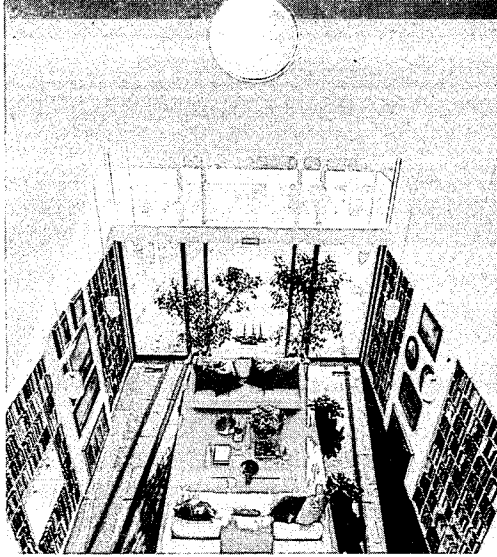
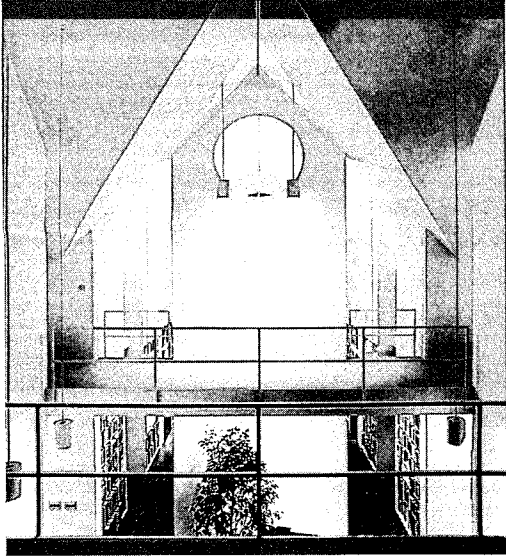

All interiors are very comfortable, lavishly spacious. In the living room (left) and entrance, ceilings reach the full height of the house. The areas can be used together, or separated by sliding pocket-doors. (Most doors and many windows are handled with similar pockets.) Above is a balcony sitting area and a bridge which share the space and views (photos above). The dining room (right) has an elegantly detailed kitchen in an "ell" directly off the room. All walls and ceilings are painted drywall; floors are bluestone. As is typical in all of Jacobsen's work, lighting in all rooms has received very special attention, with a variety of downlights and wall-washers. Bedroom windows (photos below), which appear as single tall units from outside, are floor-to-ceiling on the first level, yet provide generous units on the second. All are gray-tinted and curtained by vertical blinds.

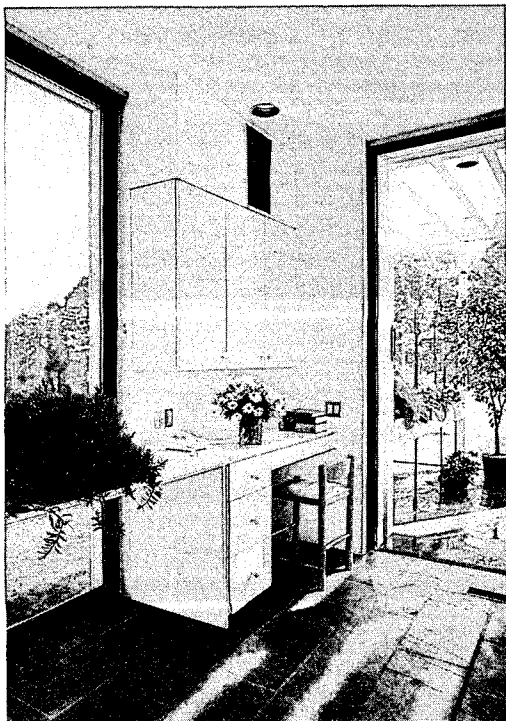

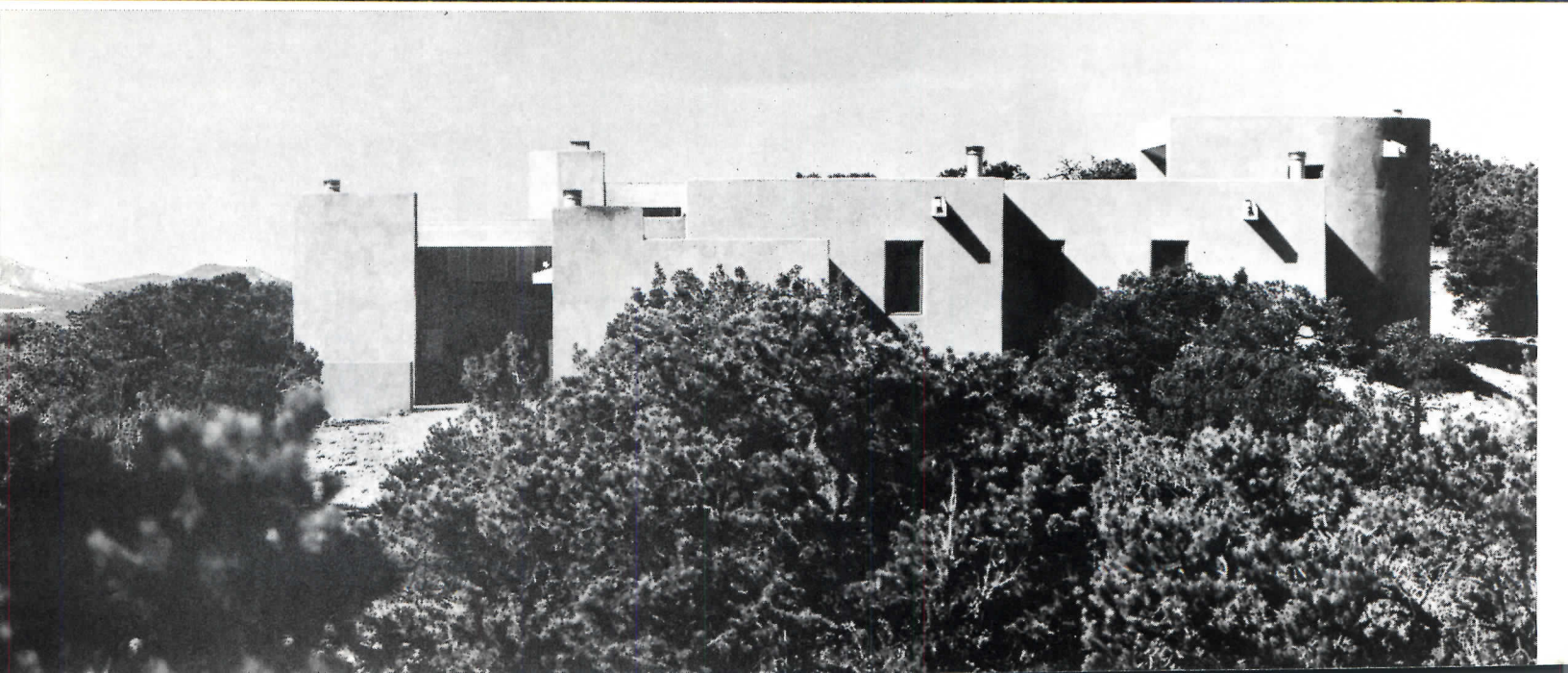





## THE BRAGUE HOUSE SANTA FE, NEW MEXICO BY ANTOINE PREDOCK

Low annual rainfall together with broad seasonal and diurnal temperature extremes are two of the elemental forces that have shaped this desert site, forces that any designer who builds on this high tableland outside Santa Fe must inevitably take into account. Other shaping forces include a blistering noonday sun and an occasional high wind that can blow this thin desert carpet all over the place. These worst-case conditions do not make the site inhospitable. Far from it. But they do suggest a sort of defensive design that Predock has been careful to provide by means of heavy adobe walls, and by a plan that centers on an unroofed but enclosed court that acts as a sun trap while providing a year-round, outdoor activity area that is completely sequestered. By limiting the size and number of exterior openings, and by shading with wood trellises those that turn toward the sun, the architect has also reduced the demand for summer cooling.

The plan of the Bague house is carefully sequenced. Arrival is across an attractive, interconnecting series of terraces, and entry is directly into the main space where a huge fireplace mass is the pivot around which living, dining and kitchen spaces are tightly rotated. Separated by level changes, these spaces are platforms that stage upward to the kitchen so that the owner, a gourmet cook, can preside over large gatherings in all three spaces simultaneously. Kitchen functions have been divided into food preparation, storage, and cleanup, and each is given its own area. Other parts of the house are arrayed around the inner court: master bedroom with terrace and secondary bedroom to the east, garage to the west, and a small, private library to the north.

Interior finishes, too, have been selected for performance, but Predock made these choices with an eye on the traditional pueblo architecture of the region. Unadorned stucco walls, wood ceilings and brick floors are all time-honored surface treatments here, but Predock has given them a freshness with contemporary hardware and details, and by carefully considered, beautifully framed views of the high desert that recur in delightful variations throughout the house. —B.G.



*Architect:* Antoine Predock  
300 12 Street, N.W.

Albuquerque, New Mexico

*Owner:* Virginia Bague

*Engineers:*

Copeland & Moran (mechanical)

*Solar consultants:* Terry Cisco, Bill Konopik

*Contractor:* G&R Construction

*Photographer:* Tim Street-Porter

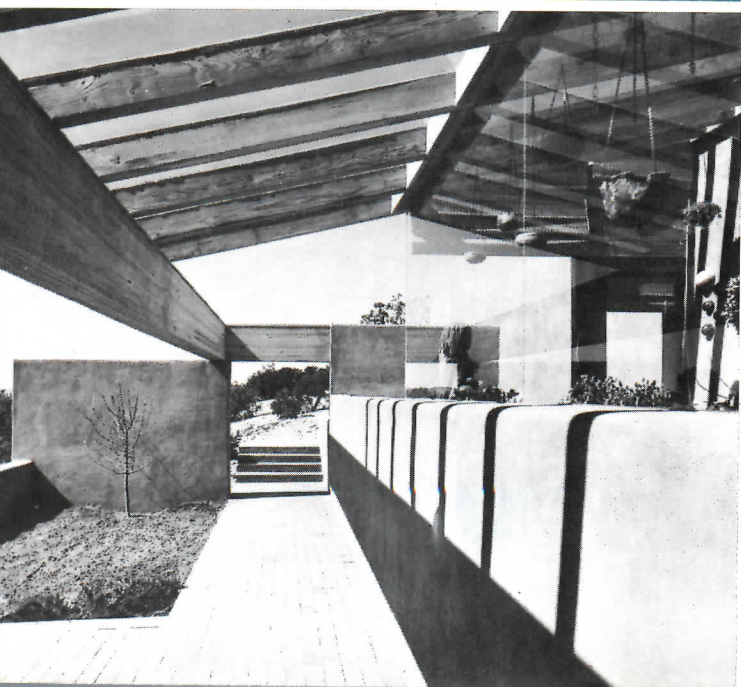

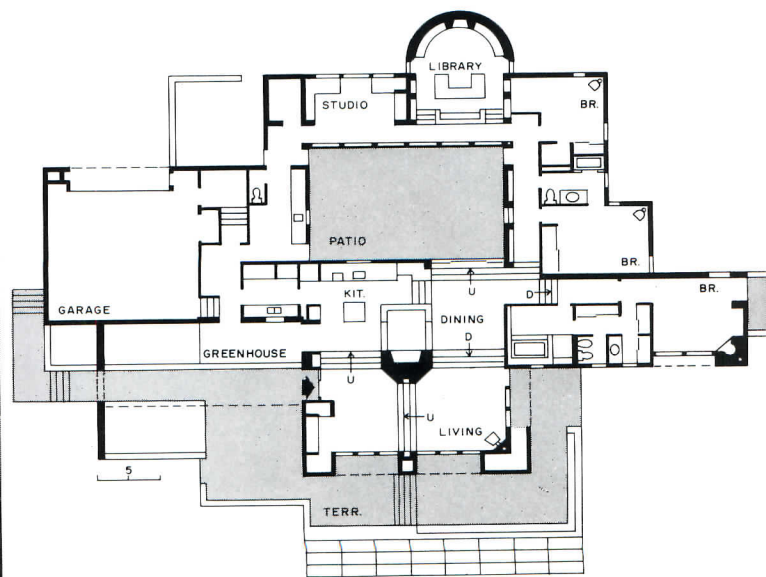
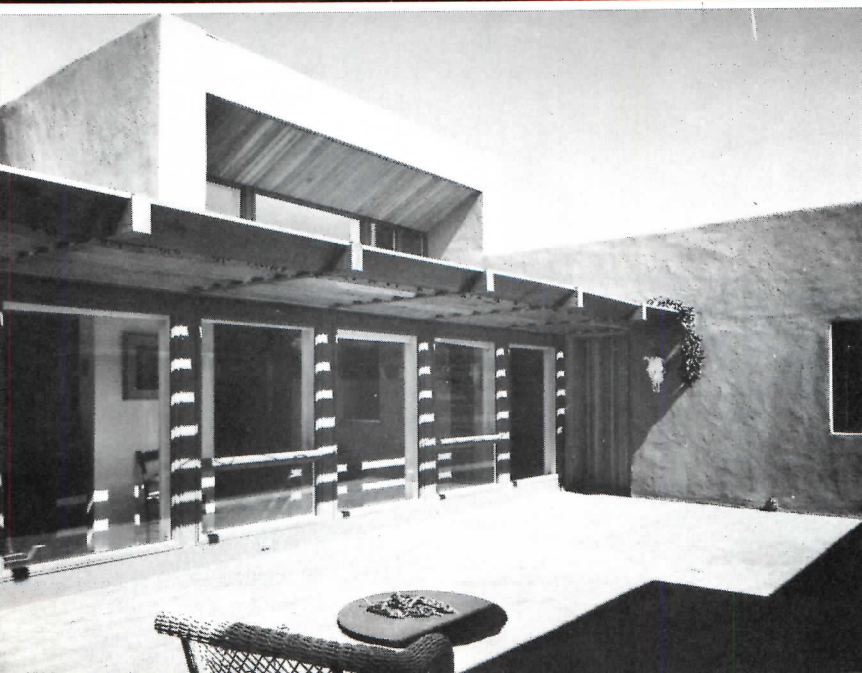

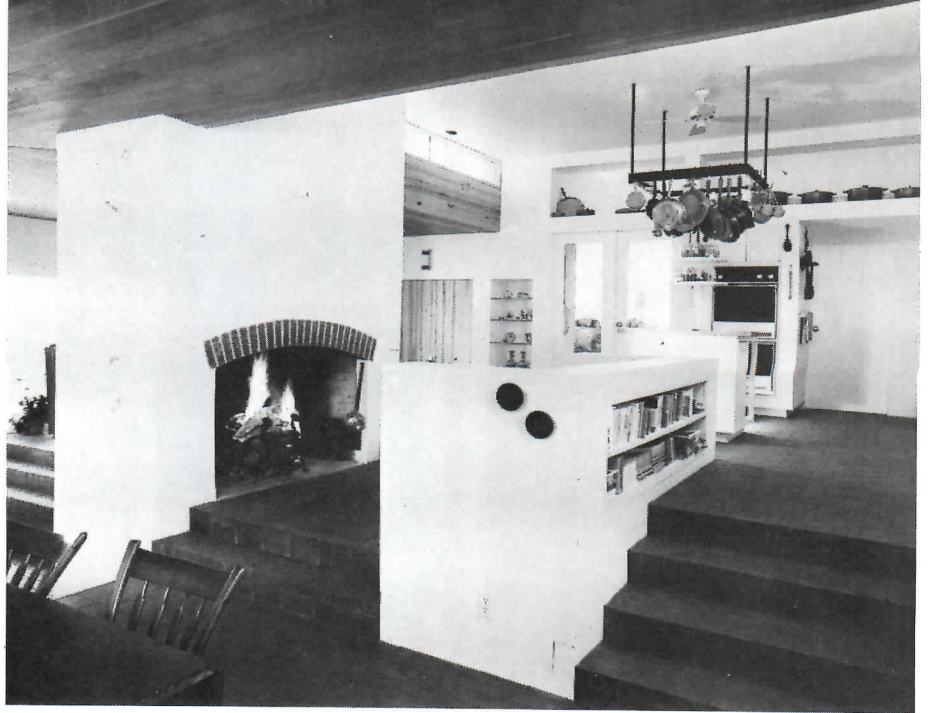

ANTOINE PREDOCK

The large photo above illustrates the hierarchy of spaces as they are staged up to the kitchen. The unroofed court is glimpsed through sliding glass doors beyond. The photo far left shows this court more fully, while the photos stacked at right explore the kitchen and its relationship to several adjoining spaces.



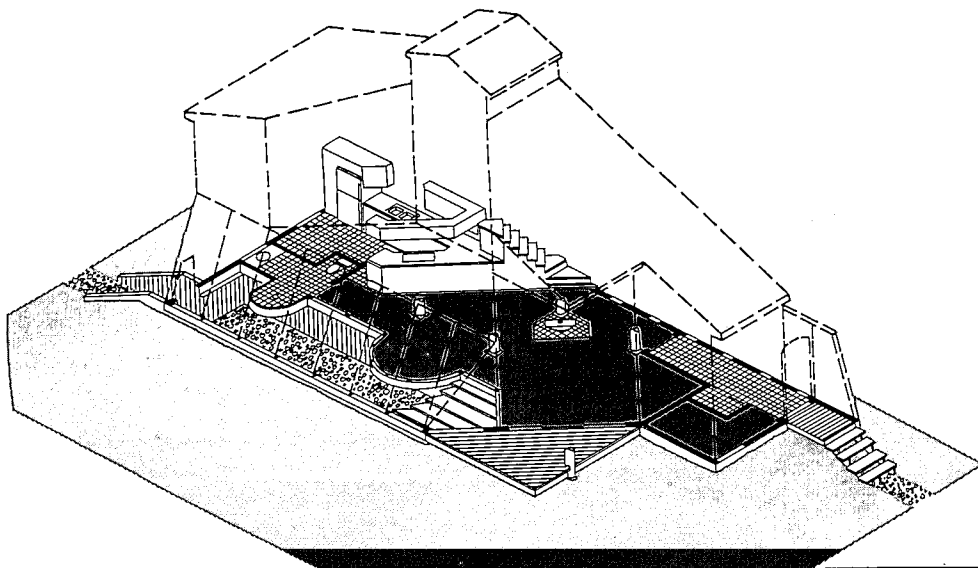

## THE BOYLES HOUSE ASPEN, COLORADO BY HARRY TEAGUE

Sited by the banks of the Roaring Fork River outside Aspen, and at an elevation of 8,600 feet, this mountain house derives its character from its setting—and in a way that is unusually direct. The over-all massing as well as the shapes of individual rooms emerged from the architect's struggle to relate a small house to an immense landscape. The interesting and provocative method Teague chose was to create two internal axes and relate each to an



external context. The greenhouse and the elements it parallels are related, quite naturally, to the east-west solar axis. The second axis, offset by 45 degrees, is the axis of the valley in which the house is built. Spaces that are related to either axis (but not both) tend to be passive and reposeful. Those that respond to both axes, and mediate between them, are active, energetic spaces that offer views to distant objects and points of reference on the valley walls.

The house is entered in a gradual process down a long entry hall that serves as an airlock. A change from exterior to interior finishes signals arrival inside, but the superbly framed mountain view is

saved for the final turn into the living room. The dining area, kitchen and greenhouse lie beyond. An angled stair rises up and over the oblique end of the kitchen to furnish access to the master bedroom (with tub), to a sequestered deck, and to darkroom and storage space on the second floor. From there, a ladder leads past a small sleeping loft to an enclosed crow's nest that promises seclusion and panoramic views through 360 degrees.

To some, the Boyles' house may have a slightly unedited look—particularly in comparison to other houses in this collection. But the seemingly random assortment of details and projected shapes are by no means accidental. They are the result of a

rigorous design process in which visual refinement is not equated with simplification, a process in which spontaneity and improvisation have an important place and individual expression is both a guiding principle and a cherished goal. —B.G.



*Architect:* Harry Teague  
P.O. Box 4684  
Aspen, Colorado  
*Owners:* Edgar and Barbara Boyles  
*Contractor:* S.L.O.W. Construction  
*Photographer:* Gordon Schenck

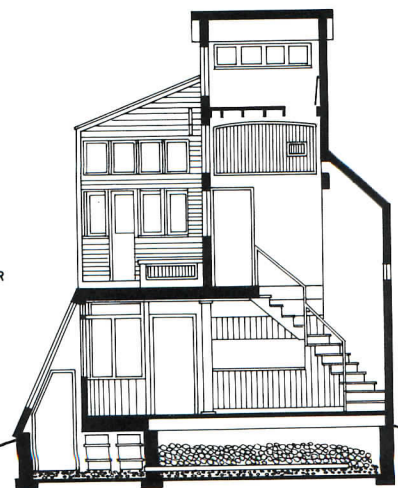
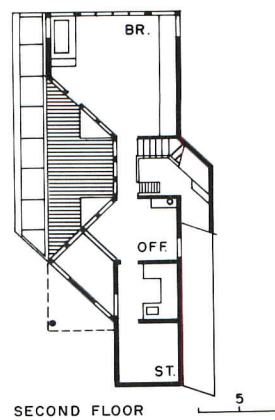
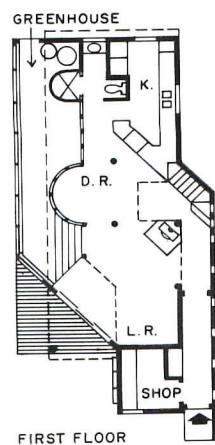



The Boyles house has also been shaped by its heating system. In a climate that averages 10,000 degree days annually, an inter-related combination of heat sources and convection devices are important. The greenhouse, the south-facing windows, the rock storage, the wood stove, even the extreme verticality of the house itself all play a part. During January and February, months that make the heaviest demand on heat, about \$40 per month for electricity and \$15 per month of wood were all that was required.

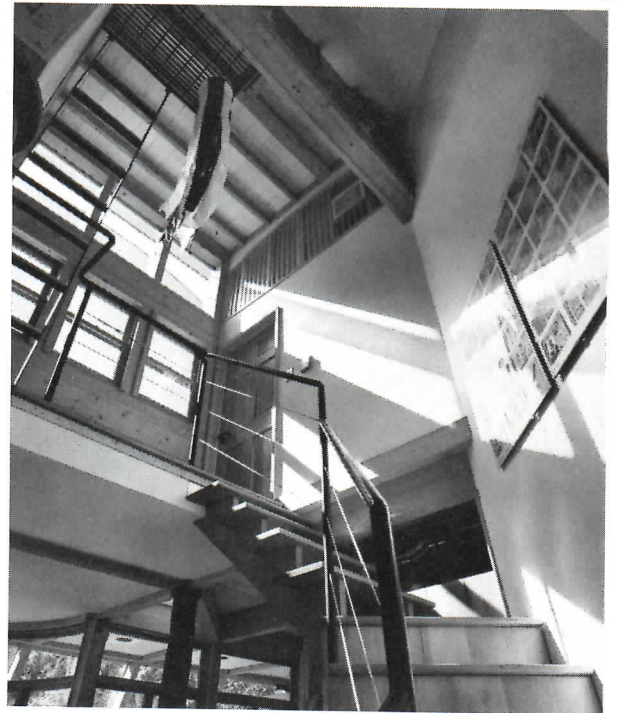

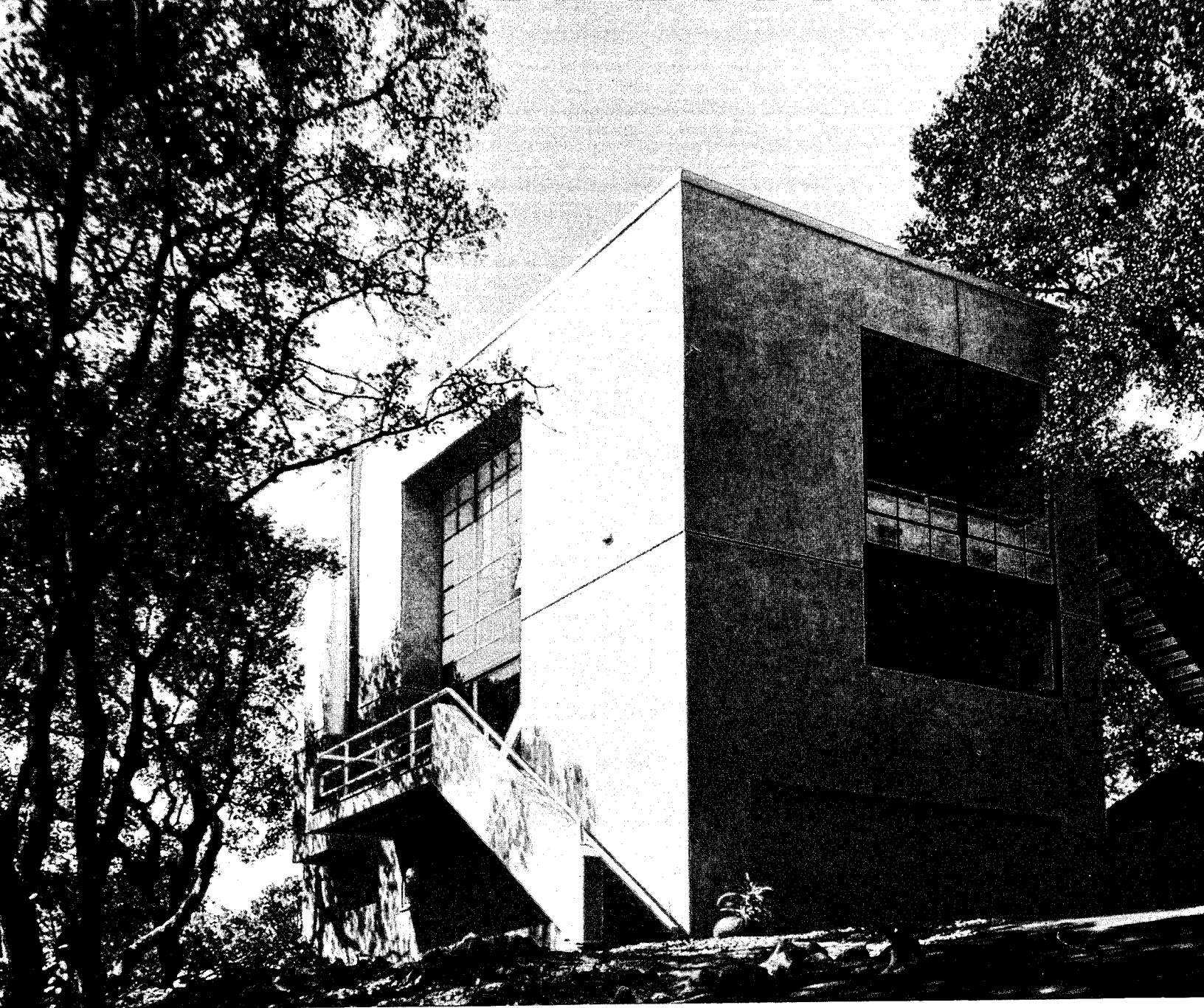

## THE VANG HOUSE NAPA, CALIFORNIA BY SEIDEL & CARLIN

During early discussions about this, their first house, the clients envisioned it being set like a sculpture in a wooded site. Their architects gave them a cubist house which succeeds as a sculptural image, drawing attention to itself in the midst of dense growth, yet serving as a very comfortable retreat.

Located in the rolling foothills near the town of Napa, California (north of San Francisco), the two-and-one-half-acre site is steeply sloped. The architects have placed the house high on an existing narrow bench-like site. This particular spot provided easy access from the main road,

and yet its height capitalizes on magnificent views—as far as 60 miles on clear days—of Suisun Bay, Mt. Diablo and Green Valley. Given these constraints of site and a tight budget, the best solution was a simple rectangular-shaped house just 21- by 38-feet, three stories high, providing 2,900 square feet of space.

Unlike most California houses designed for wooded areas, this house is not clad in wood, but in crisp stucco to enhance the formal image created by a careful composition of each elevation. The scale is cleverly deceptive, as the walls rise three stories without any indication of relationship to interior floors or functions. Large expanses of industrial windows are set into each wall and align with a grid pattern scored on the exterior as “trim” (see photos above and lower right). The trim is colored dark maroon to “match” the bark of the 100-year-old manzanita

trees flourishing on the site; the stucco walls are a very light-colored pink.

As Martha Vang is a painter, the architects treated the interiors as studio loft space—open and filled with light. By designing a two-story-high well in the center, there is a sense of expansiveness that is unusual in such a small structure. The working studio (positioned to receive north light) is located on the third floor, separated from the master bedroom by a bridge, and from the main living areas on the second floor. More often than not, the open well is used as the most convenient way to raise and lower Martha Vang’s large paintings.

While the presence of the house does not dominate the site, it is not hidden from view either. As seen from the road below, its cubic proportions and scale give it the appearance of an early work in the International Style.—J.N.



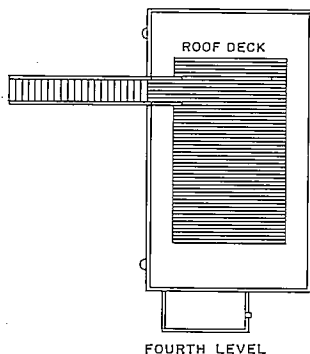
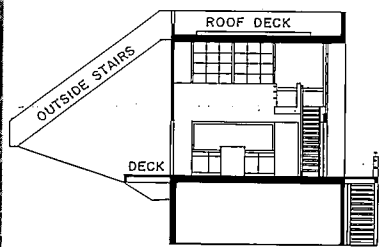
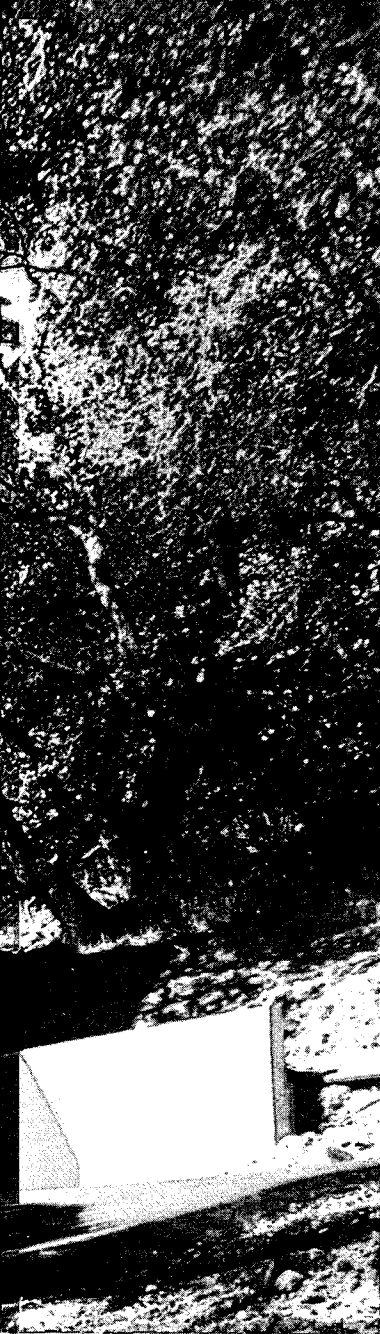

FOURTH LEVEL

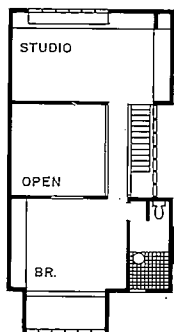

THIRD LEVEL

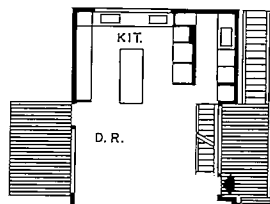

SECOND LEVEL

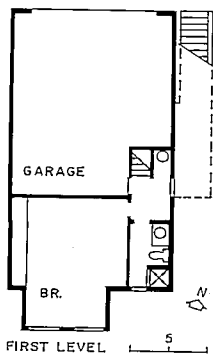

FIRST LEVEL



Architects: Alexander Seidel &  
 Jared Carlin  
 27 Orban Place  
 San Francisco, California  
 Owners: Fredrick & Martha Vang  
 Contractor: Gordon Draper  
 Photographer: Gerald Ratto



The main entrance (above) and the various rooms of the interiors all connect to the central two-story volume (right). To enhance this feeling of openness, there are no barriers between most of the rooms (with only the master and guest bedrooms sectioned off). Subtle changes in room sizes and ceiling heights create more private retreats, including the extension of bay windows on the southern elevation. The second floor bay (left) looks out over a garden and rambling stream, and the third floor bay (below left) has views to the valley below and the hills beyond.

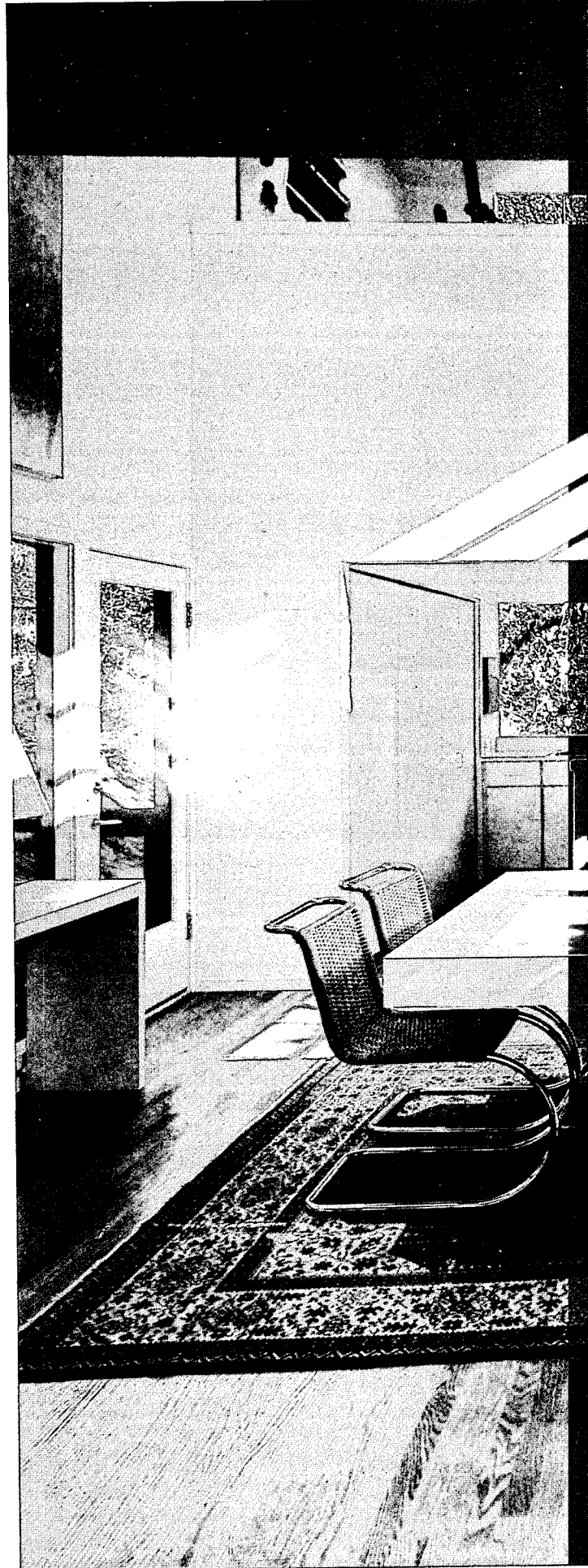
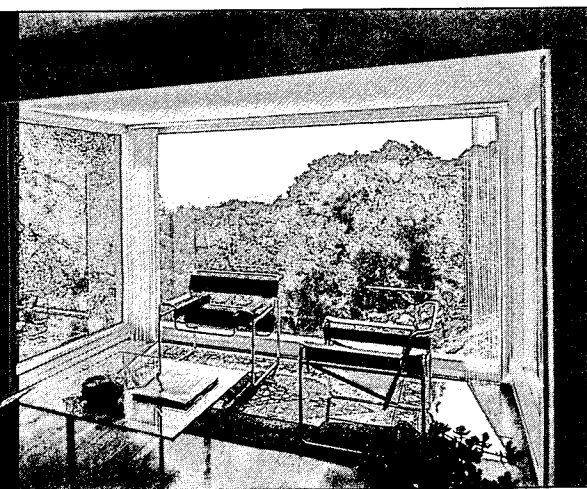



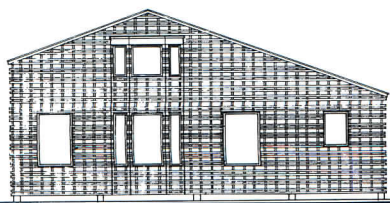

WEST ELEVATION

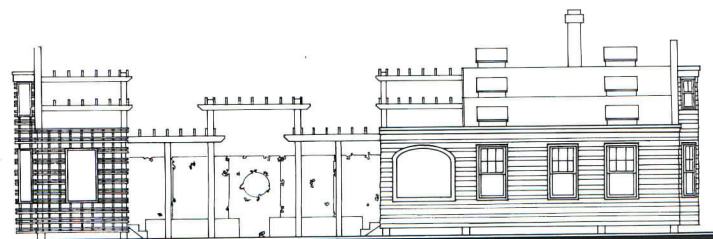

SOUTH ELEVATION



EAST ELEVATION

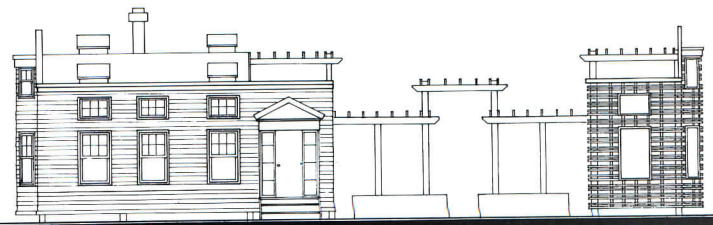

NORTH ELEVATION

# THE PEITZKE HOUSE FIRE ISLAND, N.Y. BY PETER WILSON

There's a lighthearted air sweeping across the summer resort of Fire Island that infects even the most anxiety-ridden New Yorker with a holiday spirit approaching the insouciance of childhood. That spirit is evident in the red wagons islanders employ to trundle provisions to and fro (cars are not allowed), and that spirit has been captured in the tiny house architect Peter Wilson and poet/gardener Martha Peitzke built as a vacation escape from their Manhattan loft. Not surprisingly, Wilson and "official client" Peitzke approached the project as an opportunity for displaying his-and-hers talents; happily, for husband and wife, the two interests merge in a complementary flourish.

Depending on your frame of architectural reference—and which elevation you happen to be facing—the Peitzke house is: 1) a "modified saltbox," 2) an Italian villa, 3) a formal garden, or 4) still under construction. The generous selection is not the product of indecision, but intention. Like stage sets erected to suit different acts and scenes, facades have been designed to suit different audiences—either public or private. Because the site is bordered on two sides by pedestrian walkways, New England domestic charm is provided—complete with shingles and bay windows—for passers-by; there's even a traditional front door, with pediment and antique sidelights (photo left). But such polite architectural neighborliness is revealed as merely a tip of the contextualist hat, when one walks through the

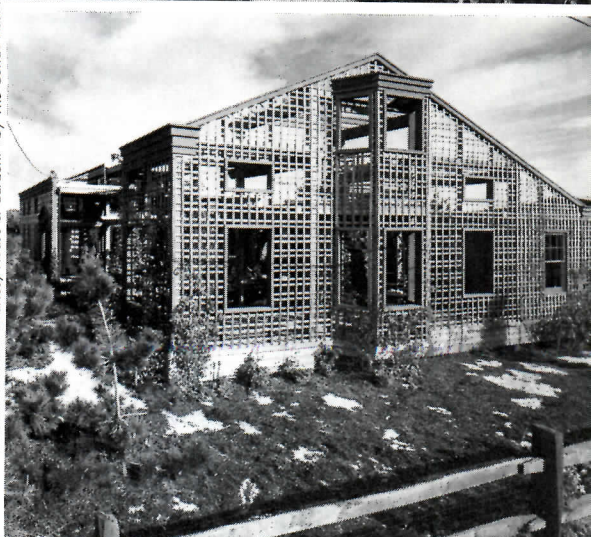
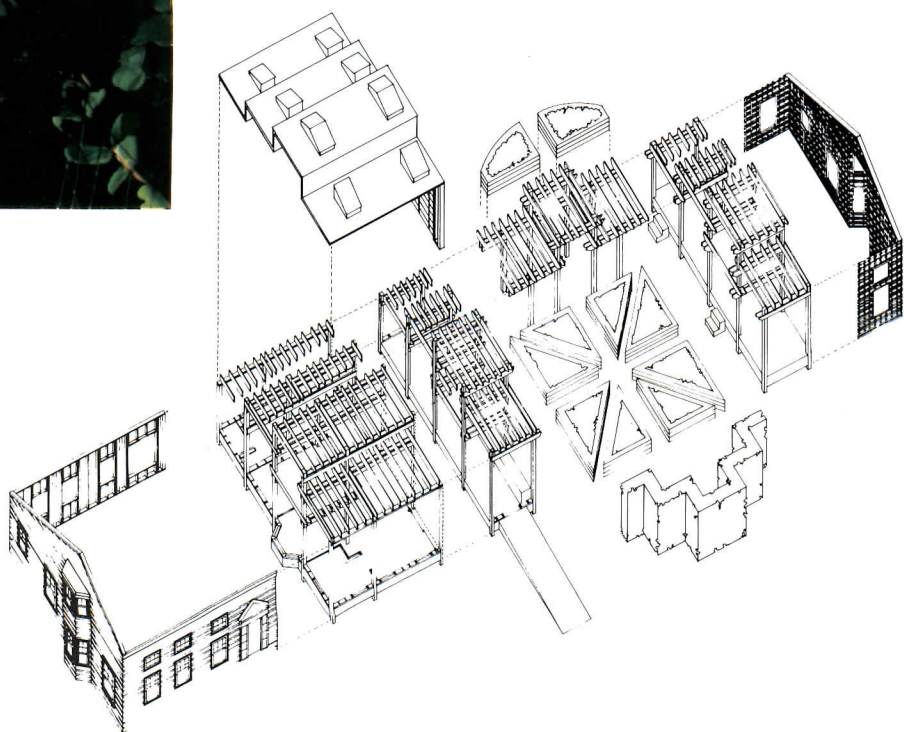

Norman McGrath. Courtesy House & Garden. © by The Condé Nast Publications Inc. photos

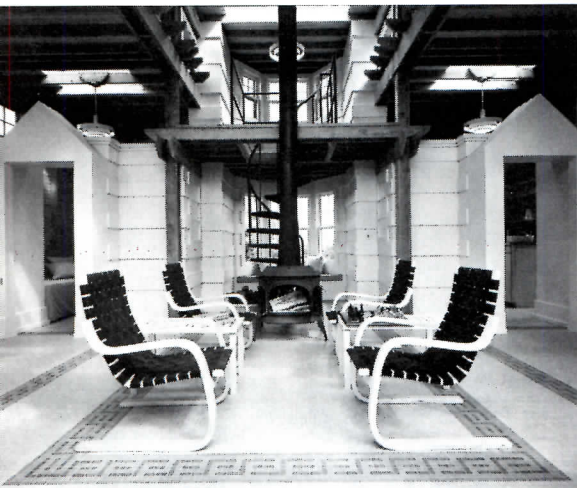

PETER WILSON ASSOCIATES

front door and discovers not a house, but a garden.

In lieu of an ocean view, the garden was conceived as the visual and social focus of the house. To sharpen that focus, and to foreshorten the prospect, Wilson erected a lattice facade: the lacy backdrop provides a definite, if transparent, edge for the garden, and, in form and fenestration, a twin for the public facade (photos previous page). Consequently, the house appears exploded—as if pulled apart, and an atrium inserted. To reinforce the scheme, *and* the lattice wall, parallel trellises and decks join beams with an interconnecting arbor. In addition to serving as the tie that binds, the infrastructure provides accommodation for alfresco dining and sleeping. (Wilson also anticipates family plays being performed on the garden pavilion stage.)

With her plot thus staked, Peitzke set about ensuring fruition and formality for her flora. Railroad ties were set in a rigid configuration of axes and cross-axes to impose order on the glorious chaos of wisteria, climbing roses, and clematis. Though deer currently feast on the garden, plans include topiary to ward off the hungry herbivores. —C.K.G.



**Architects:** Peter Wilson Associates  
 93 Nassau Street  
 New York, New York  
 Peter Wilson—design  
 Barbara Weinstein—project architect  
**Owners:** Martha Peitzke/Peter Wilson  
**Engineers:**  
 Ken Eipel/Eipel Engineering (structural).  
**General contractor:** Paul Shands Contracting  
**Photographer:** ©Peter Aaron/ESTO except as noted

Norman McGrath. Courtesy House & Garden. ©by The Condé Nast Publications Inc.

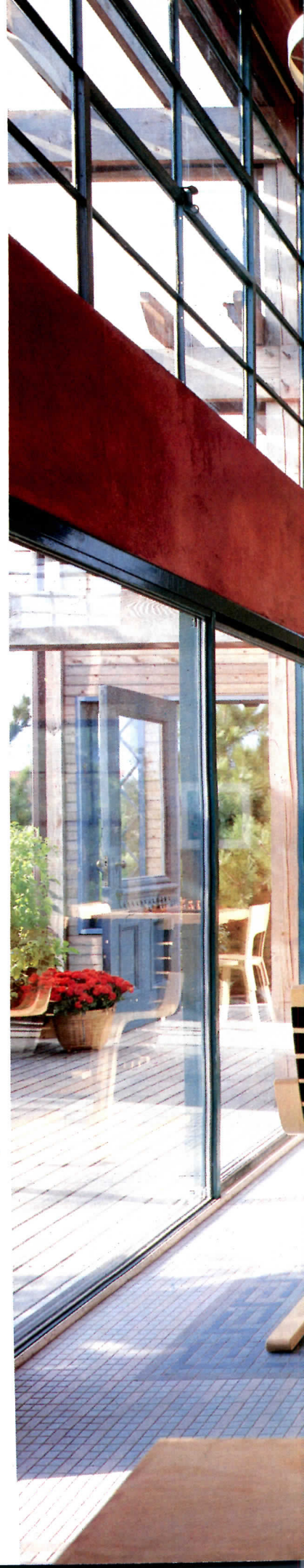
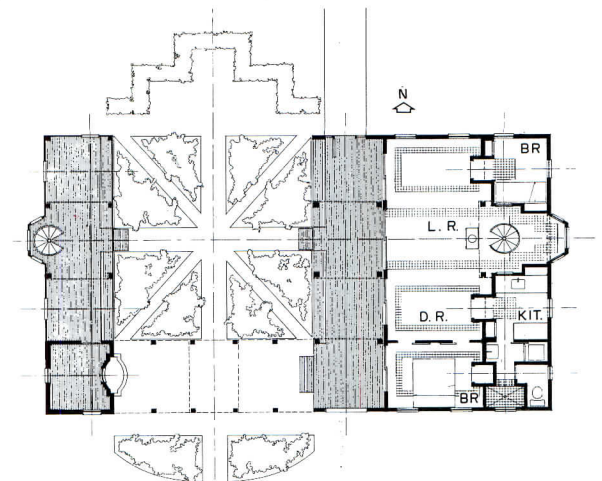
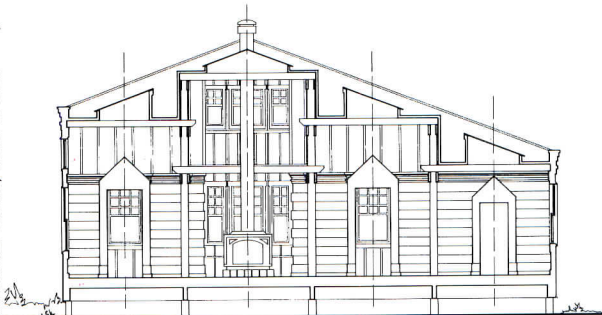







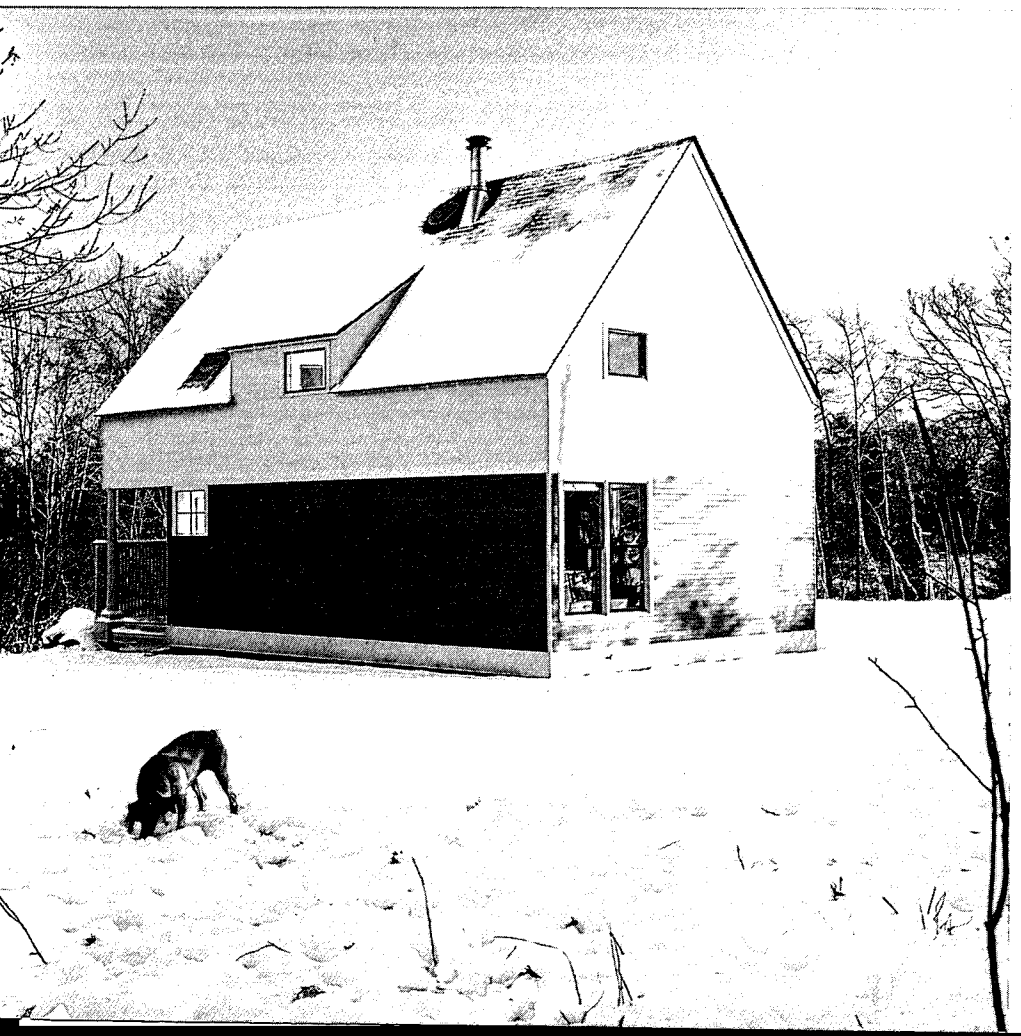

## THE ECK HOUSE NEWTON, MASS. BY JEREMIAH ECK

This "starter house" for architect Eck and his wife is small (1,200 square feet) and compact. In size and form it fits comfortably into its modest suburban neighborhood. It cost, last year, just \$65,000, not including land but including a highly effective, clever but uncomplicated and controllable passive solar system. Yet for all of its proper New England sparseness, almost everything about this little house is quite special and carefully detailed and rather elegantly finished.

To minimize the height of the house, given the steep (50-degree) roof called for by the solar design, architect Eck kept the first floor level close to the ground. He also let the roof cut through the upper floor rooms (the kneewalls are 3 foot, 6 inches inside); and reduced the apparent height by cladding the lower floor in cedar clapboards and the walls above in plywood painted light gray. ("I hope the seams won't show, but if they do I'll add battens.") The roof is green "because I hate black and there are a lot of green roofs in the neighborhood." Instead of conventional corner boards, architect Eck used stock bullnose corner boards, and oversize crown molding at the eaves and rake—a refinement that seems just right on this house. The entry (right in top photo) is picked out with a stock wooden column and a slender rail fence.

Inside (see overleaf) the plan is simple but well suited to the owners' informal lifestyle. The dining space enjoys a bay window view at one end of the kitchen. The living room is made special by raising the ceiling to the eave line (almost 12 feet) and by its huge south facing window wall (see large photo overleaf). The heavy timber framing properly suggests that something is going on above. As it is—the space above the living room is given over to a heavily insulated "solar attic"—heated to over 100 degrees on the coldest (though sunny) days by a 12-foot-square Kalwall skylight and containing both heat-storage tubes and a hot-water pre-heat tanks that can be closed off and insulated by a movable shutter at night and on dark days (see section). This past winter, the Ecks needed the living-room wood stove only three months (burning two cords), and used the supplementary baseboard electric heat only six weeks. —W.W.



**Architect:** Jeremiah Eck of Cutler/Eck Inc. Architects, members of The Associated Architects  
129 Portland Street, Boston, Massachusetts  
**Owners:** Jane and Jeremiah Eck  
**Engineers:** Paul Donnelly (structural)  
**Contractors:** Jeremiah Eck and Richard Rigoli & Co.  
**Photographer:** Paul Ferrino



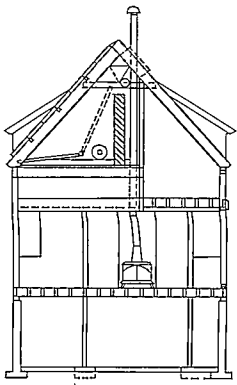

SECTION

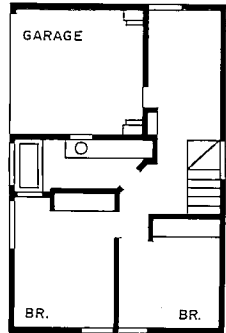

SECOND FLOOR

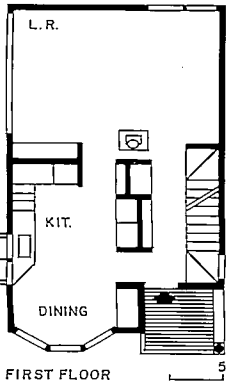

FIRST FLOOR



Section (top) shows the solar attic. There are eight heat-storage tubes—fiberglass tubes 12 inches in diameter, eight feet tall, filled with blue-dyed water. Water on its way to the hot-water heater is pre-heated in two 30-gallon black-painted tanks. The shutter (dotted line) is raised to enclose the heat-storage units at night. Room finishes are simple but carefully detailed. Cabinets are custom-made in cherry wood—"our one luxury," says architect Eck.

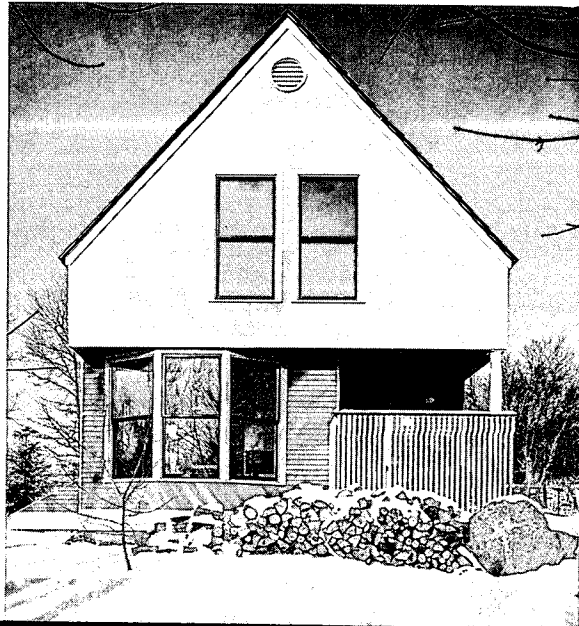
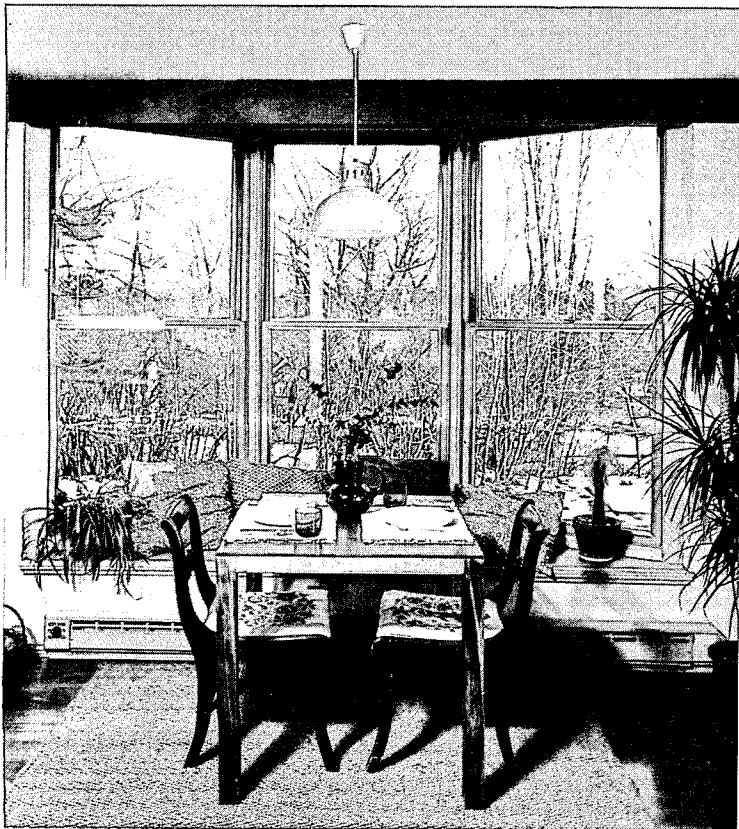
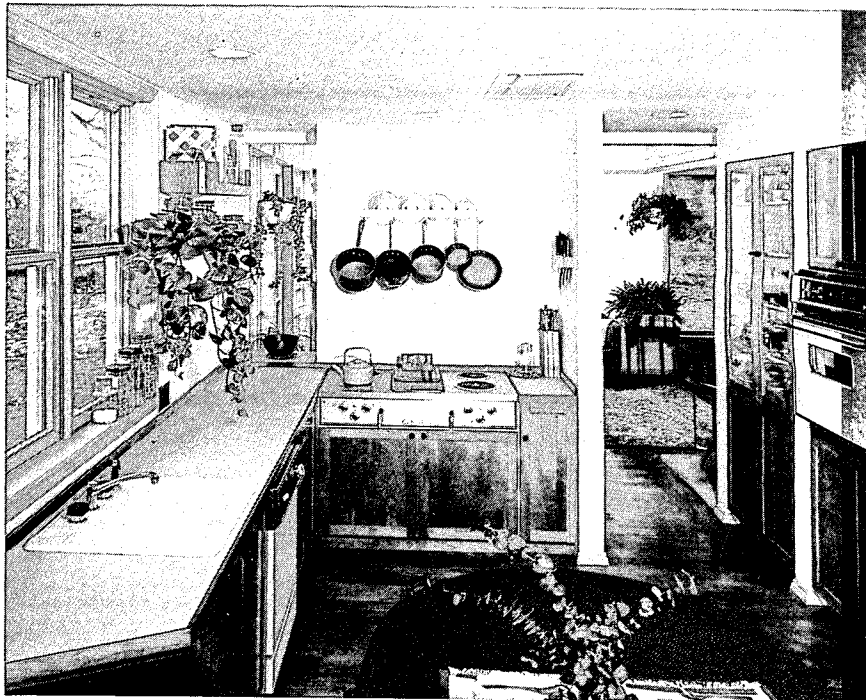

# THE BLUM HOUSE WATER ISLAND, N.Y. BY ROGER C. FERRI



Though it looks like some eccentric nautical vessel waiting to be christened and launched, the Blum house will never make that maiden voyage. And though we can almost visualize the whimsical pavilion gliding majestically across the horizon, the gangplank has been let down for the first and last time (photo left).

Such piquant imagery is not inappropriate, considering the context, the summer community of Water Island, New York, the view, the Atlantic Ocean, and architect Roger Ferri's blithe sentiments, "A beach house is the setting for a care-free mind and a soaring spirit." With one eye to the island's modest bungalows and shingle cottages, and the other to the water, Ferri developed a novel scheme that strikes a lyrical accord between land and sea—a houseboat, complete with portholes and rope lifelines.

Like a ship model on proud display, the Blum house rests upon a massive wooden podium nine feet above the encroaching thicket. While Federal flood insurance mandates take credit for elevating the house, the opportunity thus presented did not elude architect Ferri. Lattice skirts, let down to shield the structural underpinnings, visually strengthen the "base" as an independent element; consequently, the taut boxes set above appear all the more introduced—as if delivered, rather than constructed. (Not incidentally, the lattice panels are designed to break away in the unhappy event of a hurricane.) The client's preference for open, unobstructed interior spaces (photos overleaf) is expressed in the massing: two stacked and graduated volumes, oriented and glazed to the view. As a counterpoint to the geometric rigidity, and as a foil for the heat of the summer day, a flared sunscreen lifts off from the first floor, just as a beveled "lid" sets down on the second. Four Tuscan columns provide visual—not structural—support, and, in keeping with the spirit of the *S.S. Blum*, a hint of grandeur. —C.K.G.



*Architects:* Roger C. Ferri & Associates  
261 West 22nd Street  
New York, New York  
Roger Ferri—design  
Maurice Saragoussi—project architect  
Brin Magee—interiors associate  
*Owners:* David and Margo Blum  
*Engineers:*  
Robert Silman (structural)  
Batlin & Oxman (mechanical)  
*General contractor:* Tory Foss  
*Photographer:* ©Cervin Robinson





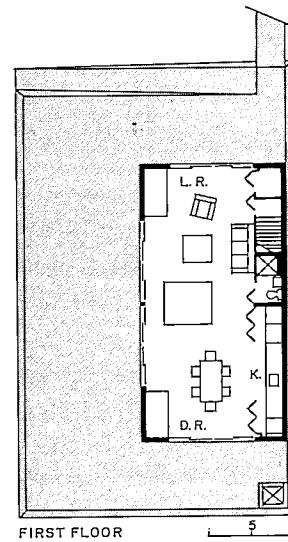
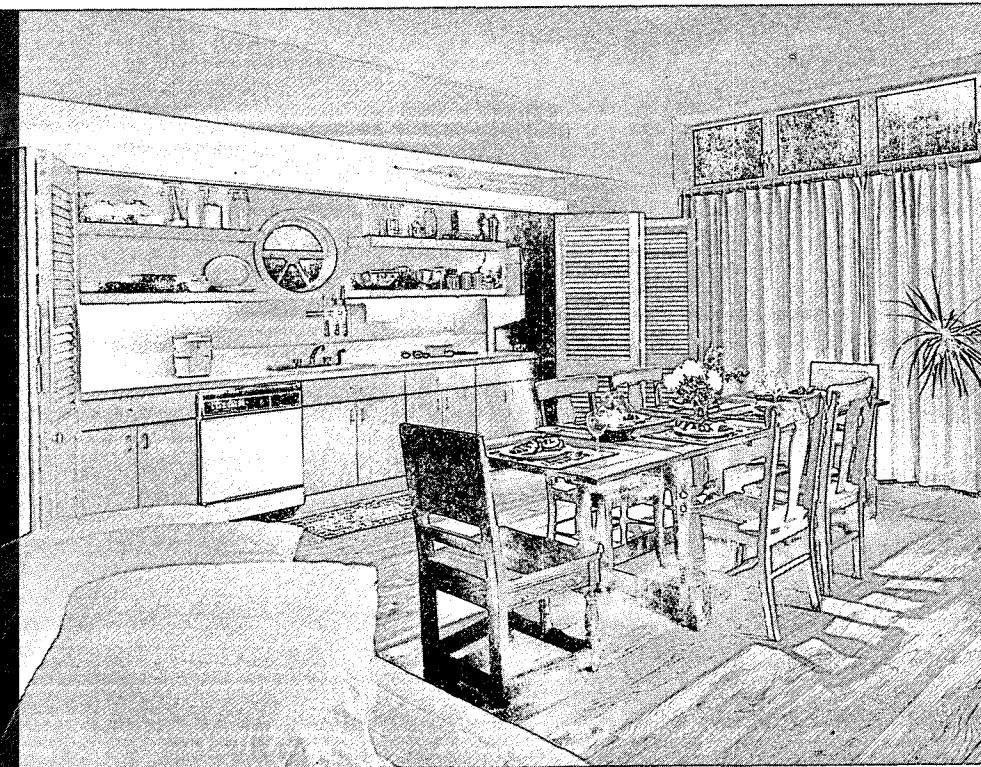

FIRST FLOOR

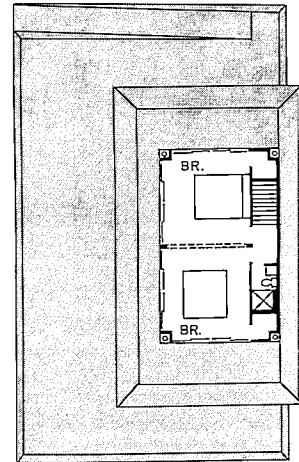

SECOND FLOOR

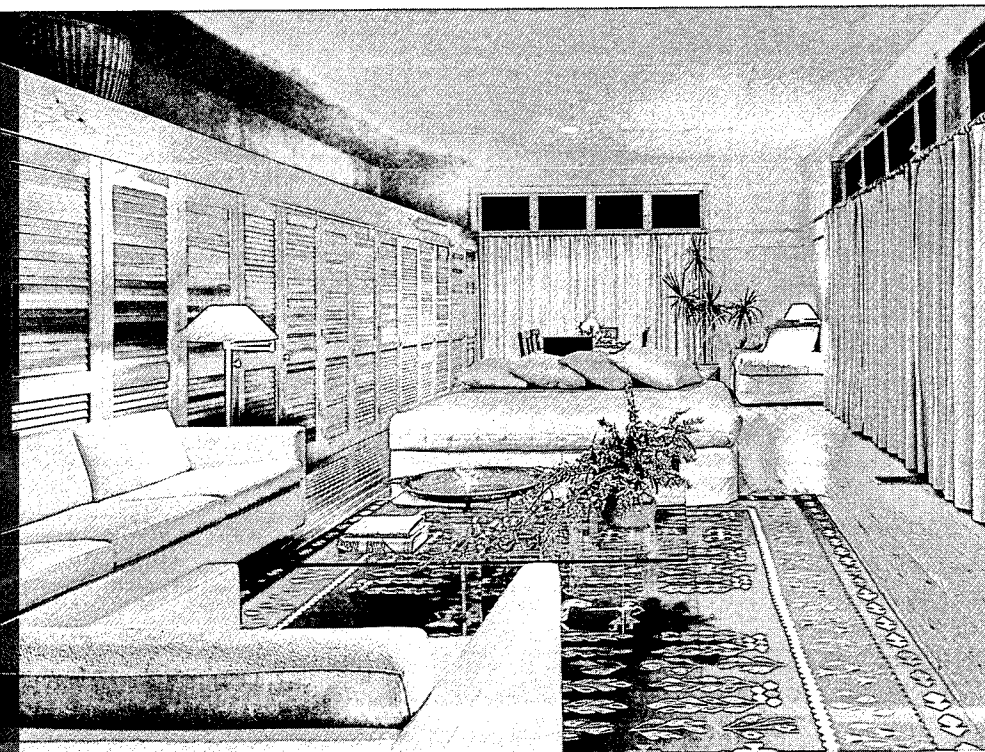

Inside the cypress pavilion, architect Ferri wisely kept a low profile: nothing detracts from the view. A simple plan provides unobstructed vistas, and satisfies the client's request for "loft-like" spaces. Furniture, finishes, and fabrics were chosen for their textural—vs. decorative—properties: downstairs, "rustic" and "natural;" upstairs, polished and polychromatic. This change in esthetic tempo is conveyed to beachcombers with a brash magenta rim on the sunscreen (photo previous page). Narrow voids between the sunscreen's horizontal planks allow for cross ventilation through a clerestory band of jalousie windows. Heavy trusses (photo top right), and marine plywood set in an irregular pattern (photo below right), ensure that the Blum house does not put to sea with the first gale.



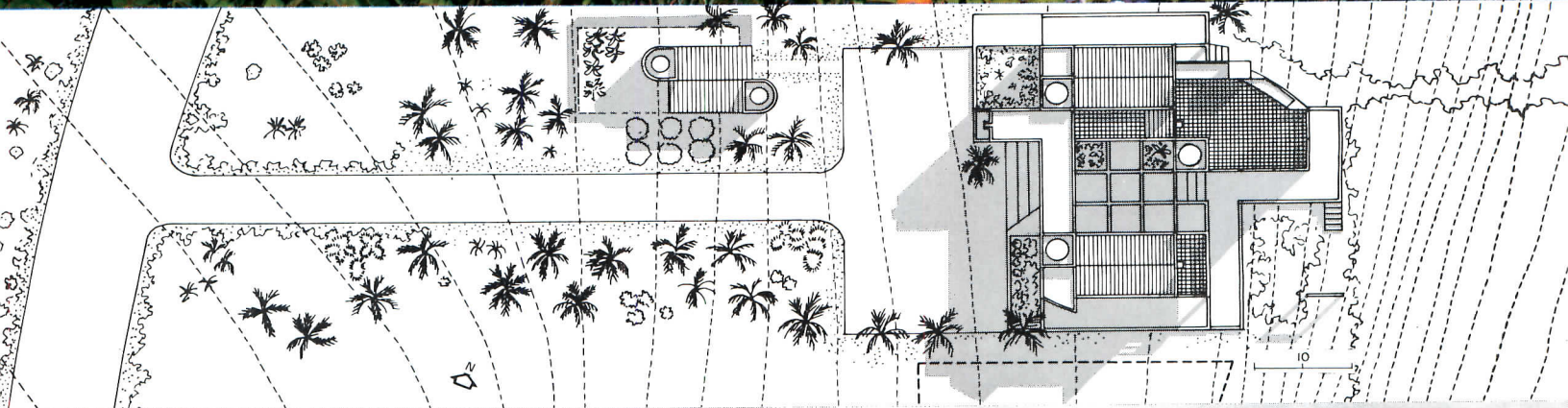



# THE LOHMANN HOUSE QUINTANA ROO, MEX. BY GEORGE WOO

Blessed by a warm sun year-around, and by a Caribbean surf that beats relentlessly against its base, this rugged limestone shelf provides a matchless backdrop for vacation activities of many kinds. And if the house that clings so securely to its heights appears to be shaped by a welling romanticism, small wonder. Both the program and the site invite the most picturesque of design responses.

Architect George Woo did not approach his task timidly. For a couple with four children who like to escape the winter fastness of Michigan when they can, Woo designed a vacation house of white planar surfaces energized with pipe railings and with a large assortment of openings turned toward the ocean and protected from the sun by broad overhangs and recessed glazing. The sense of complication is heightened by massing that separates the house into two structures linked by covered walks but spaced apart across an open court. The indoor/outdoor spaces that are so often the delight of tropical or subtropical houses are also presented in Woo's design and reach a dramatic climax in the elevated roof deck (see photo next page) that is a superb sun trap but also serves as a grand platform from which to watch the approach of tropical thunderstorms that occasionally gather and strike in this region with really awesome majesty.

But for all vacationers, the sun, the wind and the surf can be enervating, and there is a moment for even the hardiest when enough is enough. For these times, the architect has provided a series of interior spaces that are cool, withdrawn and restful. The living room is typical. It is a long and slender volume with its principal seating area pulled sharply back from the window wall. The adjacent kitchen and dining spaces enjoy a similar sense of shelter and calm. Above the living room is a multi-use loft for sleeping and storage. The bedrooms are isolated but can be easily reached by covered walkways at two levels that are themselves inviting spaces. And servants' quarters occupy a separate structure a short distance uphill.

In selecting his construction and finish materials, Woo turned his attention to what was available locally, and used these materials in ways that provide contrast, and more than a little romance. —B.G.



Architect: George C. T. Woo  
3636 University Boulevard  
Houston, Texas

Owners: Dr. and Mrs. Carl Lohmann  
Contractor: Isidoro Jimenez  
Photographer: Balthazar Korab

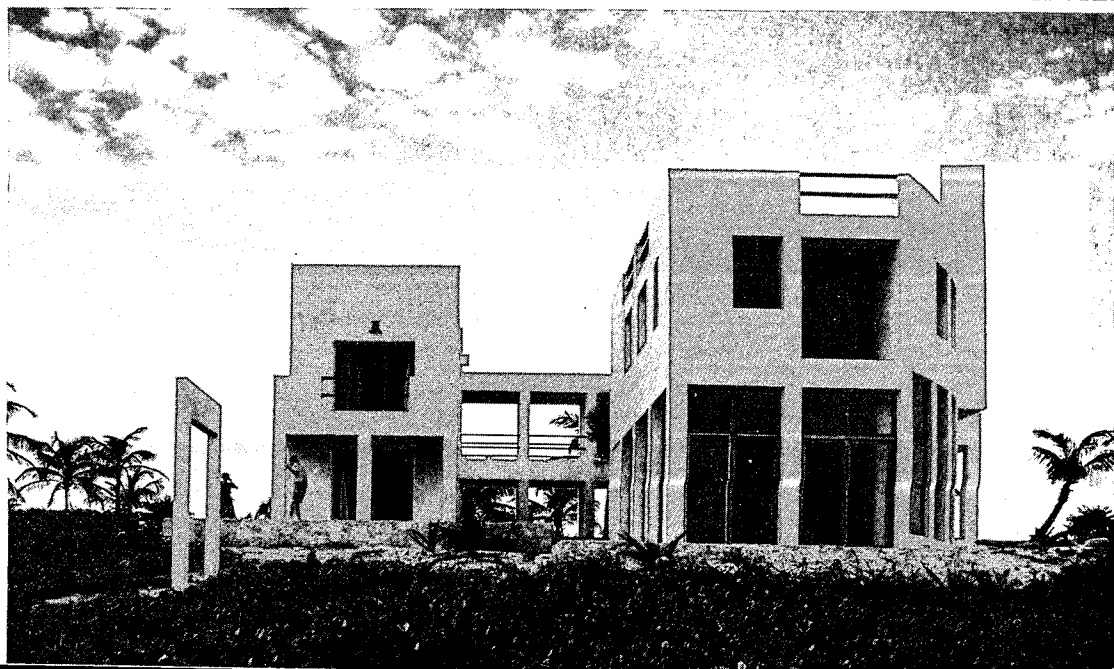
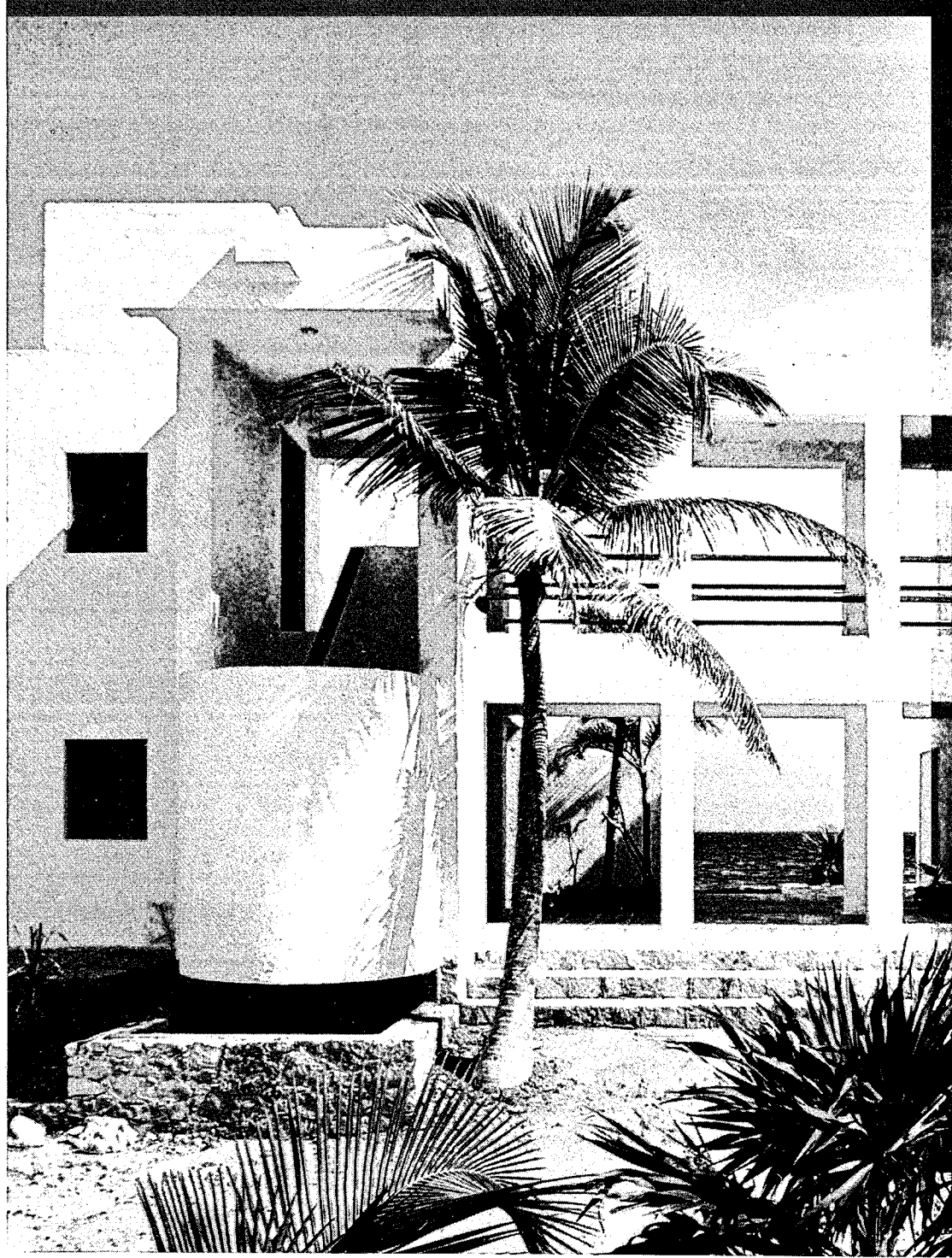

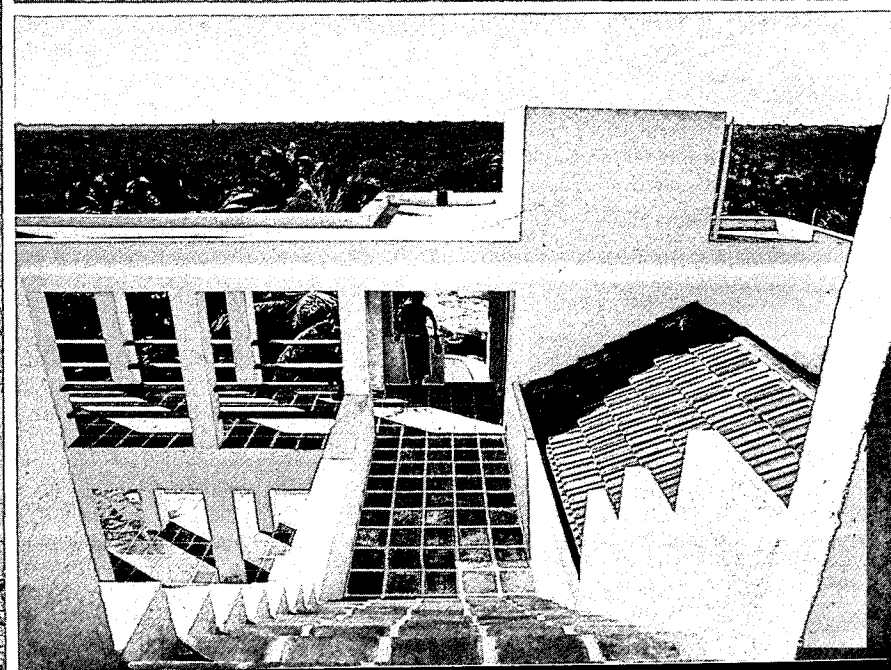
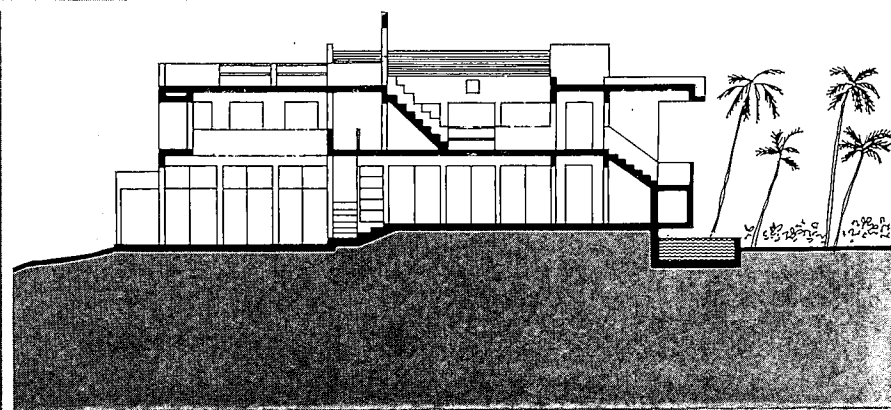
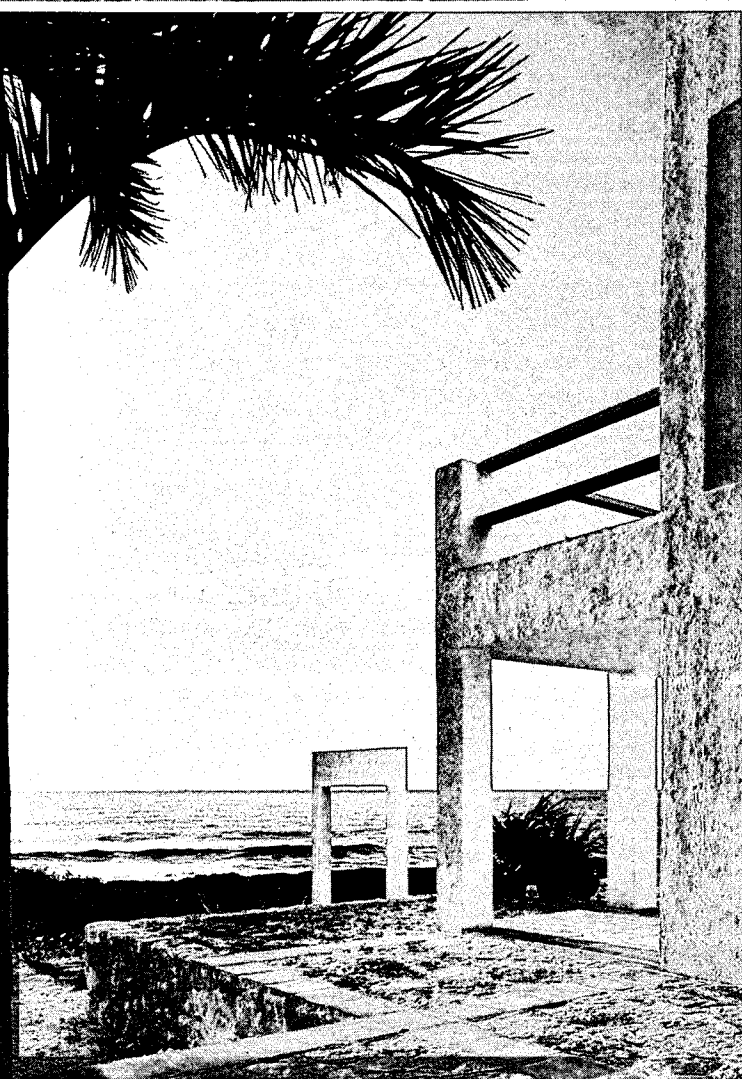
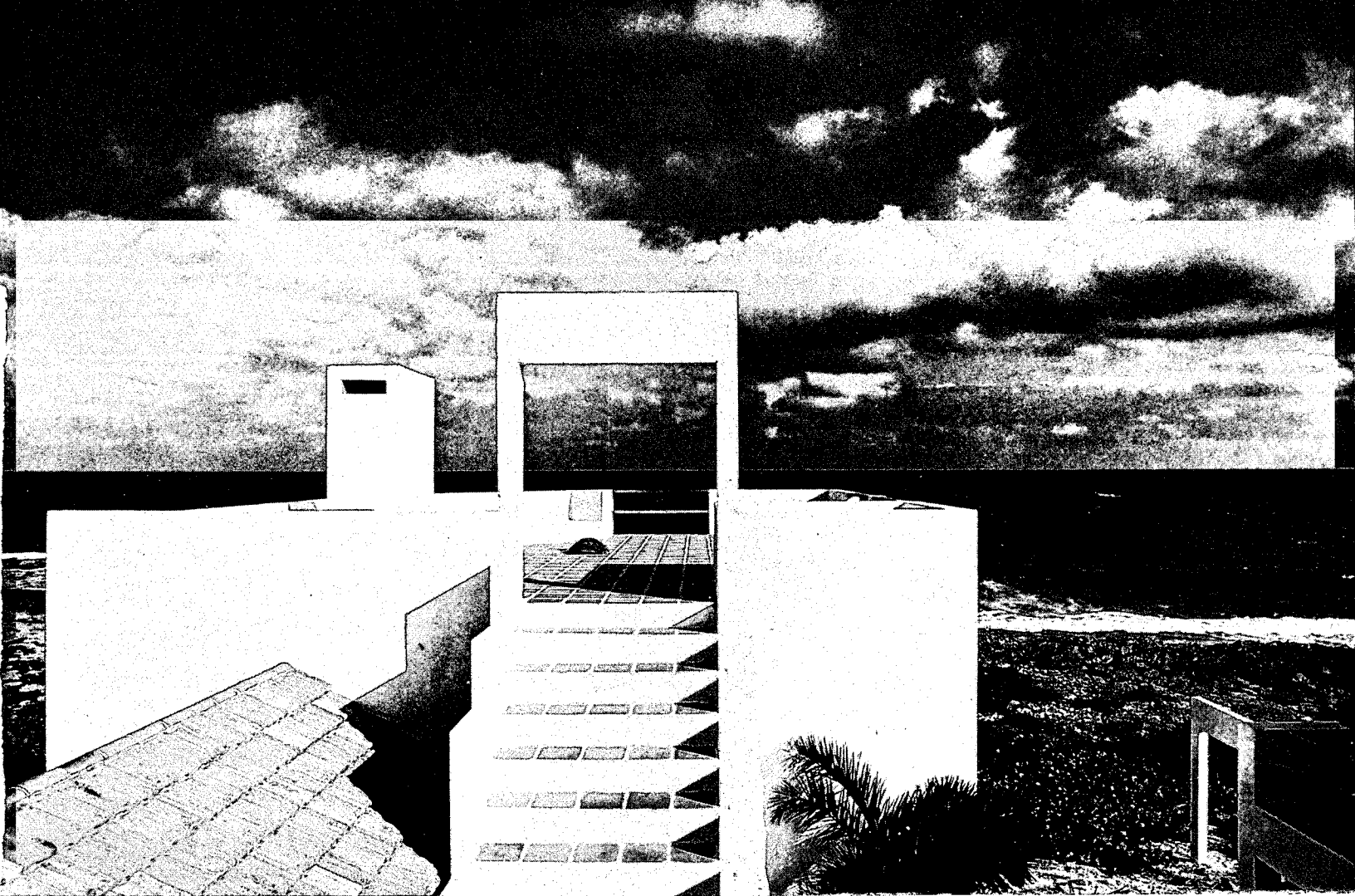

GEORGE C. T. WOO

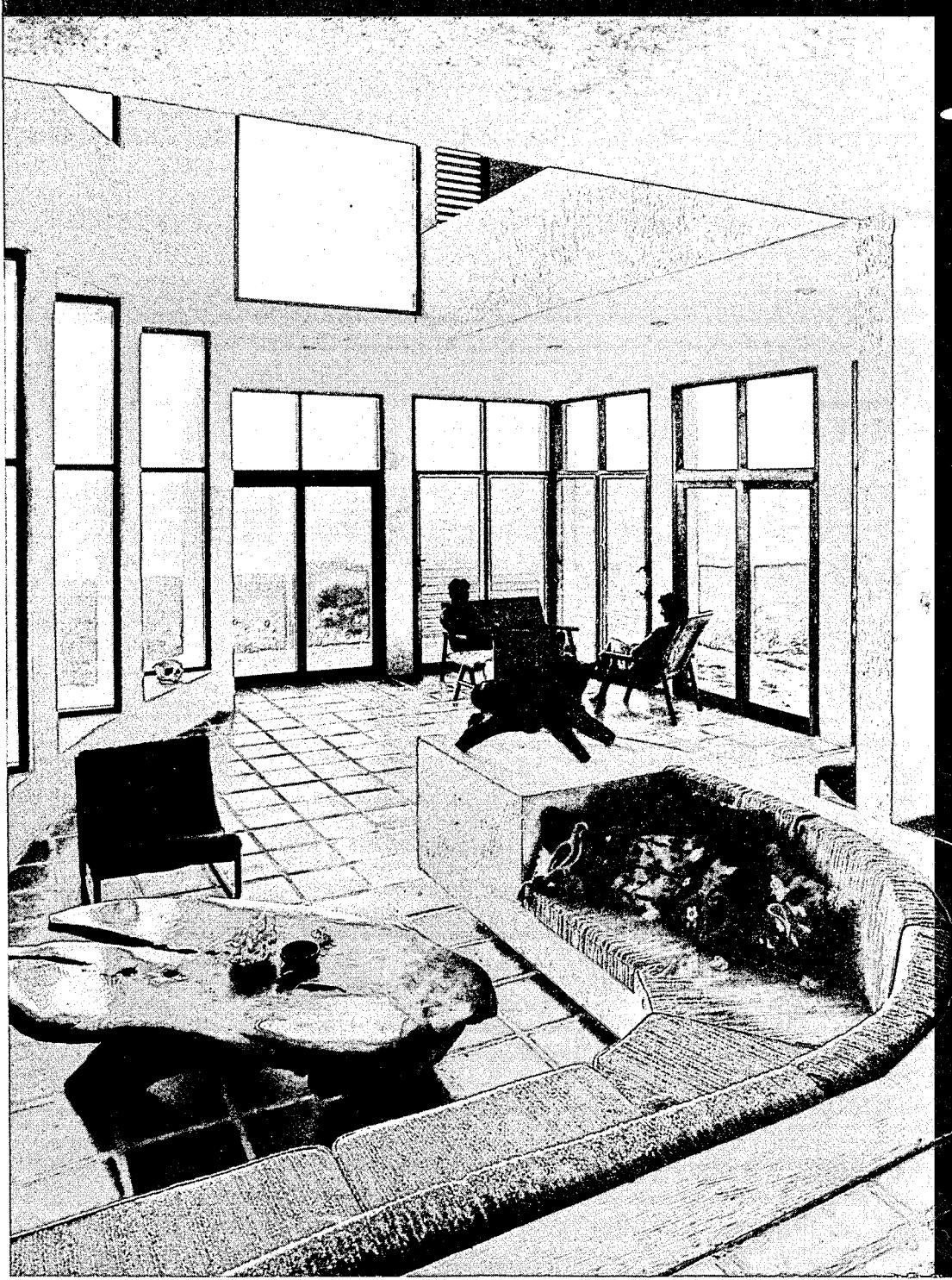
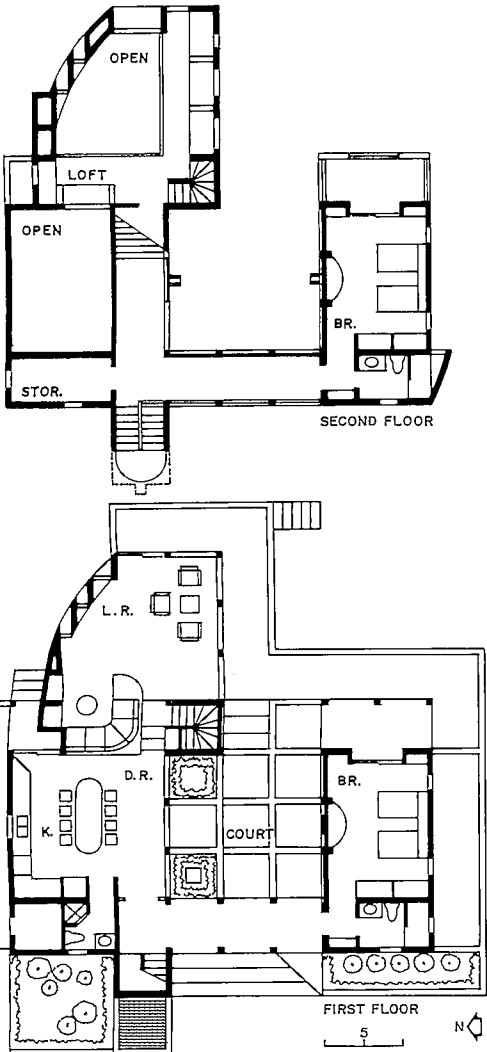

The 65- by 236-foot lot, formerly part of a coconut plantation, faces the ocean to the east and the low, thick growth of the Yucatan peninsula to the west. The house is sited about half way back on its lot at a height 20 feet above sea level and about 100 feet back from high tide. Rainwater is collected from the roof surfaces of the house and conveyed to a cistern located beneath the court for use at a later time.

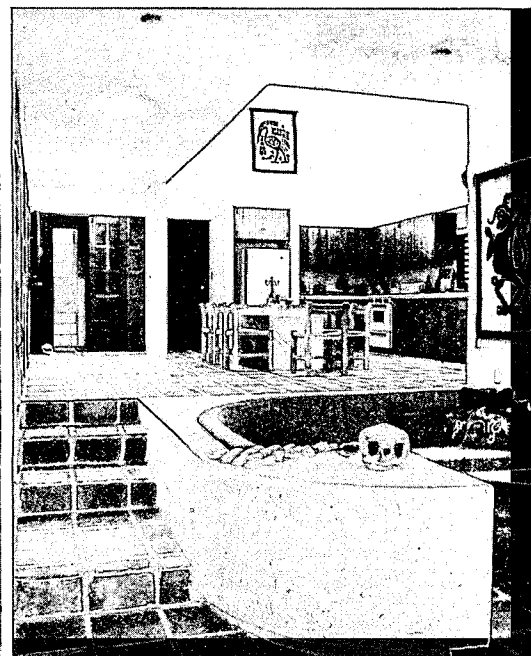
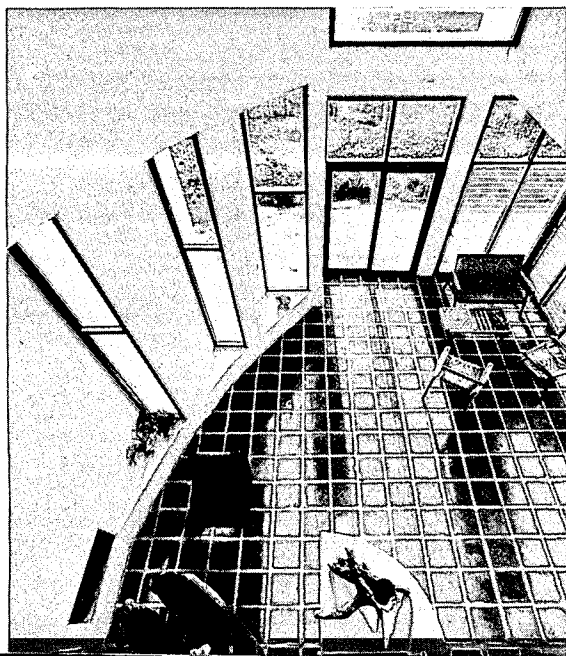



# THE McMILLAN HOUSE NEW JERSEY BY GERALD ALLEN

There is absolutely nothing obvious or ordinary about this house. It is full of pleasant surprises—in its form, its spaces, the way daylight is let in, the way the treehouse view is controlled. The house is pinned to a very steep site by tall and slender wood stilts; but this is background, scarcely seen, and certainly not expressed as an important design element. Instead, what is expressed and what is important are images that are simple and familiar—"meant to recall farmhouses in northern California for the owners and ones in the South for the architect"—though this house is in fact very elegant and sophisticated and very understated.

The drama of the site and view (and, indeed, the house itself) are hidden from view as one arrives, since the drive is thickly planted on the downhill side. It leads to a gravel-paved parking area that is enclosed on the downhill side by a garage and tool shed connected by a long arcade that, again, screens the view of the house and site beyond. These structures are made of rough-sawn cedar boards stained almost black, with dark-gray metal roofs—all designed to merge quietly into the landscape. These outbuildings seem at first to be the house itself; but what appears to be the front door actually leads not to an interior, but to a high bridge. From the bridge the steep site is revealed for the first time. An old-fashioned lattice wall on the left focuses attention to the view on the right, and the screened porch (familiar images!) of the house itself—standing in a canopy of trees on its wooden stilts.

In form, the house is a three-story square tower with a shed wrapped around it at the main floor level. In the tower, a staircase winds its way up and down around a central fireplace and chimney. Though the images on the outside—the metal roof, the rough siding, the lattice wall, the screen porch—are rural and simple; inside the details are white and refined and very contemporary and high-style. Pleasant surprises. . . .—W.W.



**Architect:** Gerald Allen  
19 Union Square  
New York City  
**Job team:** Michael Barclay, Graham Mackenzie  
Gordon, and Andrew Moszynski  
**Owners:** Deborah and Daniel McMillan  
**Engineers:**  
Robert Silman Associates, P.C. (structural)  
Raamot Associates (soils)  
**Consultants:**  
Ann Charlotte Krantz (interior furnishings)  
Christine Beebe (interior colors)  
**Contractor:**  
AVR, Ltd.—John Ansele and Edward Dwyer  
**Photographer:** Timothy Hursley

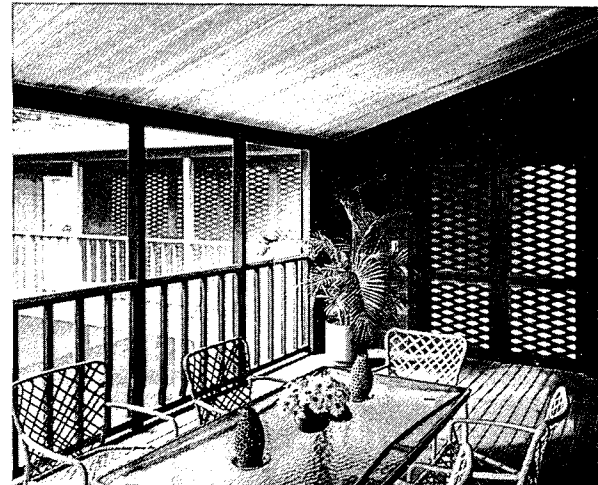
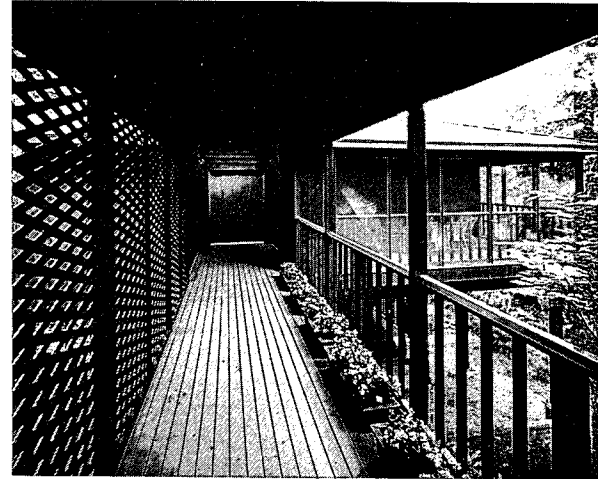
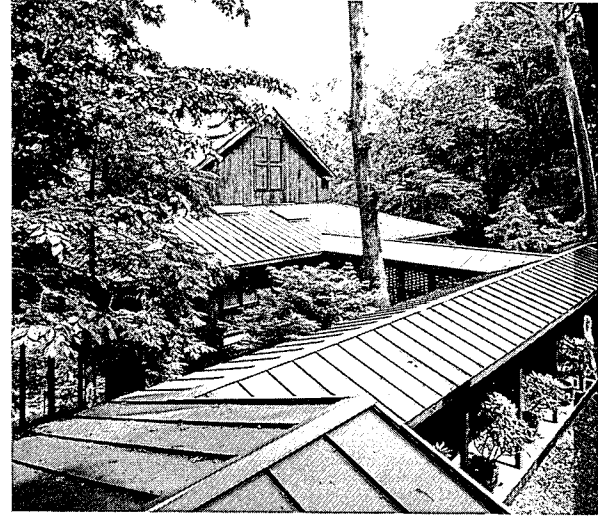
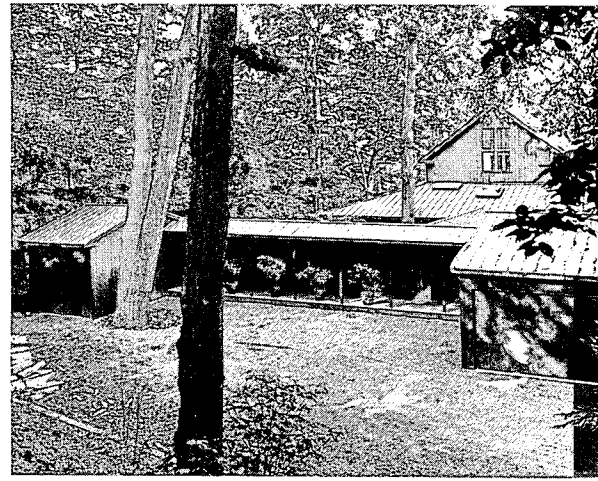
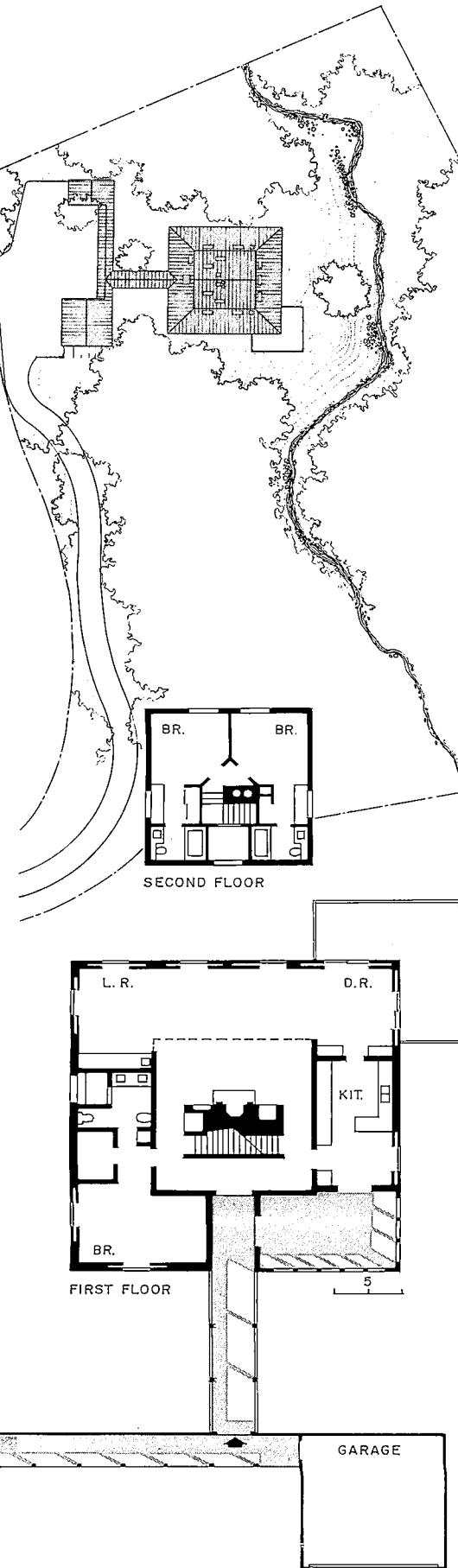

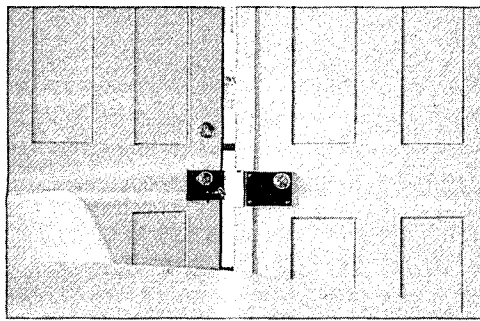

Brad Gordon photo



Just inside the entrance, a tall space rises to the peak of the shed roof. Behind it, and visible through large openings in the shape of a giant sash window, the stair ascends into a rotunda on the upper floor. The space at the entrance is lit indirectly; the stairwell, in contrast, is lit by skylights that admit shafts of sunlight. In summer, when the leaves are on the trees, this central space becomes the only brightly and directly lighted place on the whole site. In the main living spaces, a string of skylights through the sloping wood ceiling bounce light against the walls so the rooms are flooded with diffuse light.

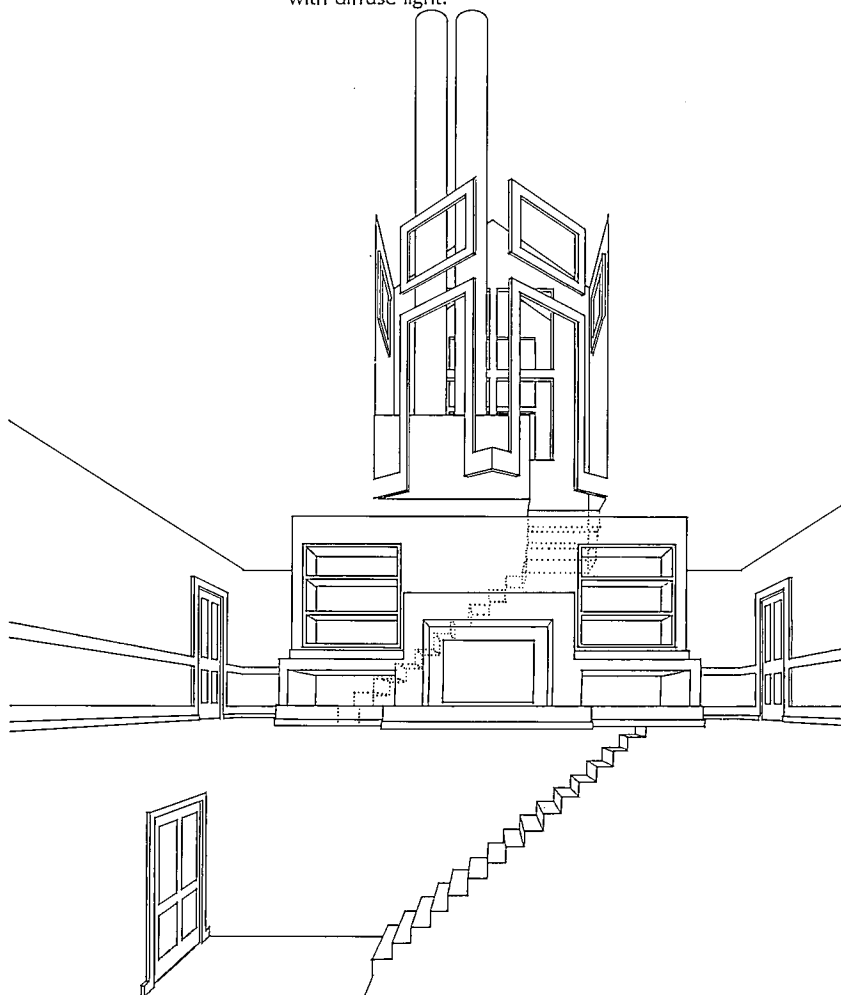



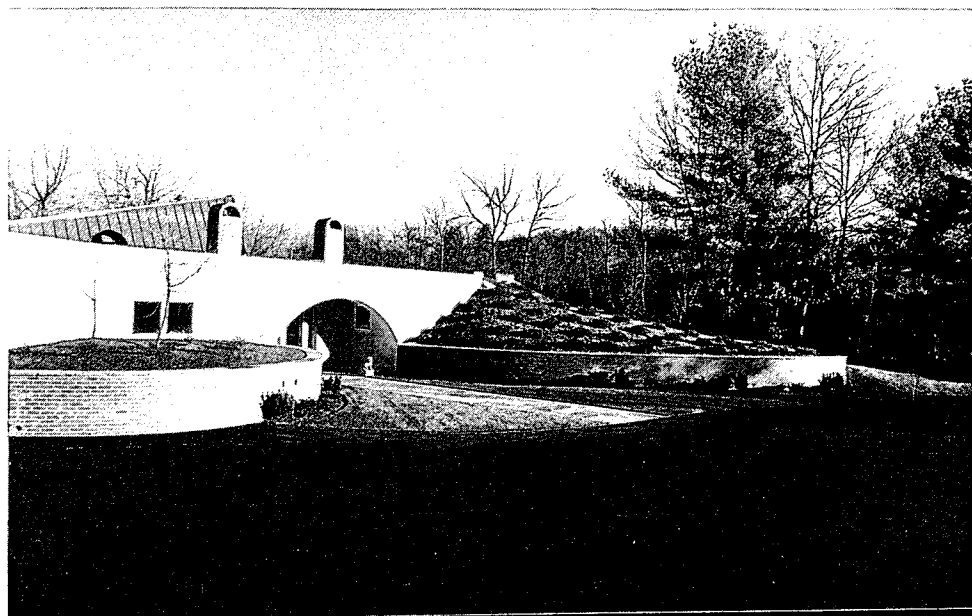
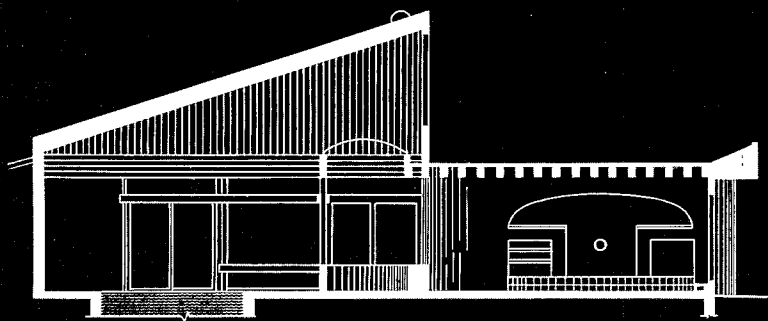
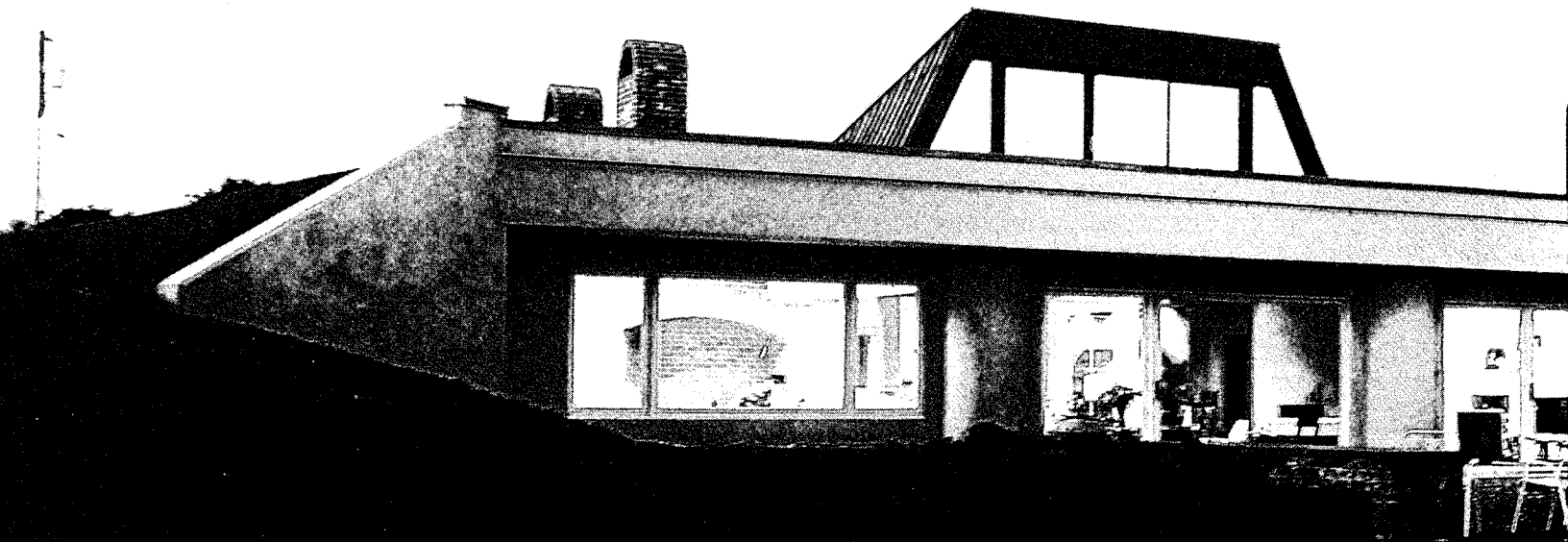



# THE LEWIS HOUSE MEDFIELD, MASS. BY DON METZ

As architect Don Metz wrote in his recently published book, *Superhouse*, "What we're looking for is an architecture vocabulary of 'earth shelteredness' that signifies the unique dynamics of building underground." Metz's pragmatic approach to this vocabulary is demonstrated by the success of the Lewis house. According to him, there are three reasons why the house performs as well as it does: it is well insulated; it is sheltered by earth temperatures which range from 45 to 50 degrees year round; and the energy it reaps from sunlight coming through the south window wall is enhanced by the thermal storage capacity of the structural materials, tile floors and interior masonry walls.

The perimeter walls of the house are of 8-inch-thick reinforced concrete. There are eight inches of extruded polystyrene insulation on the roof and three inches on the buried perimeter walls. As is the case in Metz's Winston House (RECORD HOUSES 1974), on sunny days solar gain contributes sufficient heat to maintain a temperature of 70 degrees. For cloudy days, however, there are three wood stoves and electric baseboard heating. According to owner Jack Lewis, any one of the stoves is sufficient to heat the entire house, because of effective air circulation.

Two factors which are perhaps the greatest contributors to the esthetic appeal of the Lewis house are the treatment of natural light and the use of curved walls. Since one fear of living underground is claustrophobia, natural light is also one of the most functional elements of the design. Metz introduces natural light horizontally because he believes "the horizontal line of sight is our natural aspect whereas light from above adds to our sense of being 'down under.'"

A central atrium over an indoor pool and a sunken courtyard at the east end of the house allow natural light to penetrate the deepest interior spaces. Similarly, the curved walls serve not only to engender a sense of security against the feeling of being closed in but also to influence the movement of space to create an inviting esthetic environment.—L.L.



Architect: Don Metz  
Pinnacle Road  
Lyme, New Hampshire  
Owners: Mr. and Mrs. John Lewis  
Engineer: Harris Hyman  
Contractor: Thomas W. Proe  
Photographer: Robert Perron

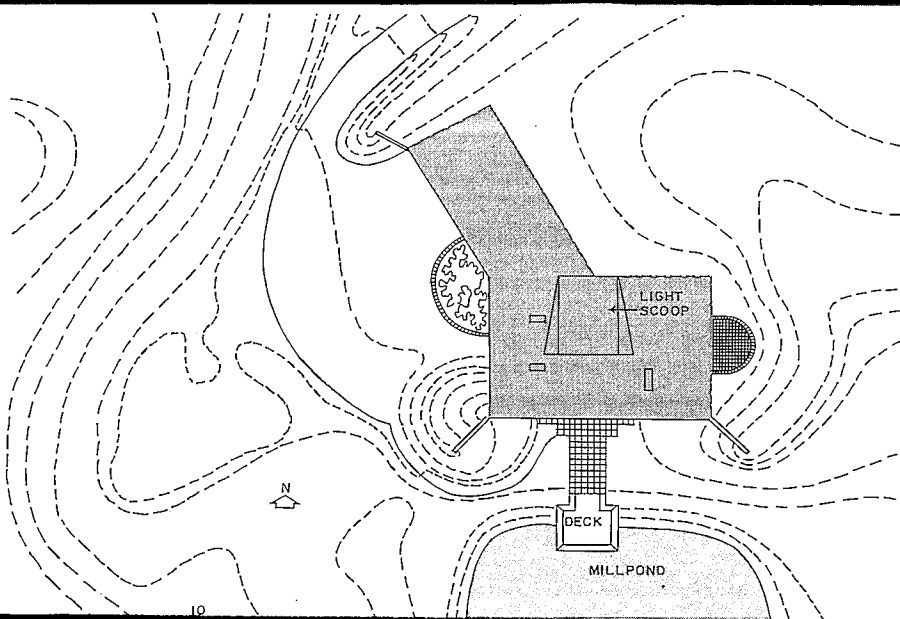

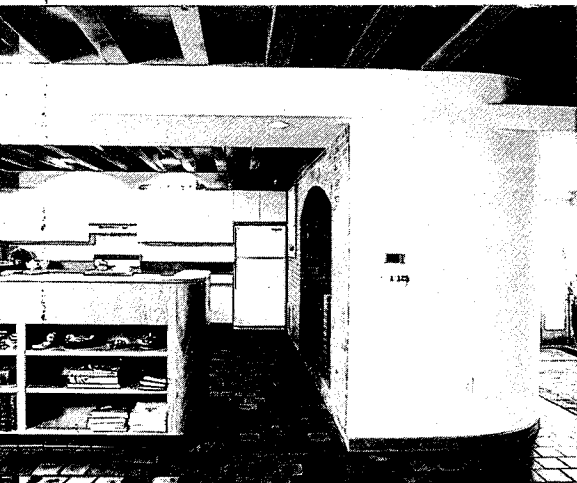
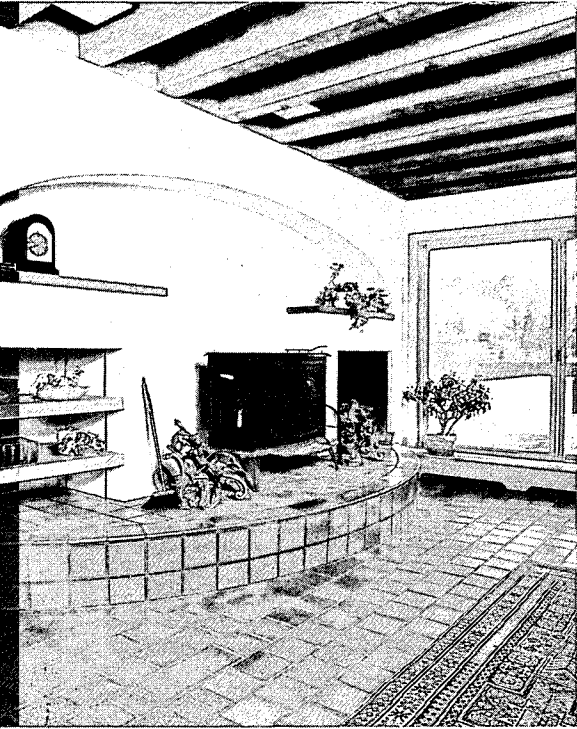

DON METZ

The Lewis house gracefully exploits the benefits of earth-coupled and passive solar design. By building the house (5,200 square feet) into a south-sloping gravel bank and berming earth along the north, east, and west walls, the heat loss at 20 degrees below zero is kept down to 38,000 Btus/hr. The earth-sheltered walls and roof and the generous south-wall glazing provide an effective, low-tech guarantee of maintenance-free, energy efficient performance for the life of the house.

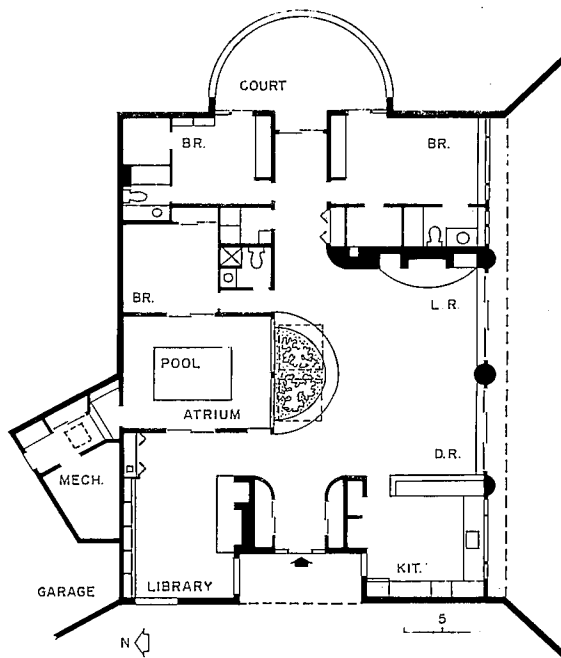



# FAMILY LIGHTHOUSE

## DOOR COUNTY, WISCONSIN

### BY NAGLE & HARTRAY

When architect James Nagle designed a vacation house in Wisconsin's Door County, he found that such contemporary architectural principles as contextuality and vernacular form fit like old shoes. Not only have he and his family spent a lot of time in these parts sailing and cross-country skiing, but he has in addition designed a number of other houses in the area.

The owners asked for an essentially simple house that would accommodate themselves, four children and guests, that would allow both quiet and convivial activity, and that would take panoramic advantage of the woods and Lake Michigan. The octagonal cedar house, which Nagle calls frankly "an object building," takes its distinctive regional form from the lighthouses in the vicinity. The square "light" 40 feet up in the treetops encloses an observatory with a window seat around the entire perimeter.

The plans of the house's three floors are pinned at their centers by a spiral staircase, around which variegated geometrical spaces—squares, rectangles, triangles—revolve (see section below and plans on next page). On the ground floor, the square stairwell turns 45 degrees to connect bedrooms around the periphery and bathrooms at the triangular corners; each bedroom has a triangular closet tucked around the well. On the second floor, sitting areas—two rectangular, one triangular—open off the stairwell, while the kitchen nudges into the central space. The square observatory on the third floor has proved equally hospitable to reading, napping and parties.

Because the house will be used year-round, the design provides both winter and summer entrances. Snow-covered visitors come in at one corner of the ground floor and then emerge into a sitting room with fireplace. The summertime entrance lies across a wood porch at the top of an open stairway.

To minimize heating and cooling, a fan at the peak of the house can be reversed according to season. In summer, it draws cool air from the lake up through the stairwell to open windows around the observatory. In winter, it forces sun-warmed air from the top down. All windows have triple glazing. —G.A.



*Architects:* Nagle, Hartray & Associates Ltd.  
230 E. Ohio Street  
Chicago, Illinois  
William Sitton, job captain  
*Engineers:* Beer Gorsky Graf (structural)  
*Contractor:* Carlson, Erickson  
*Photographer:* John Hilarides

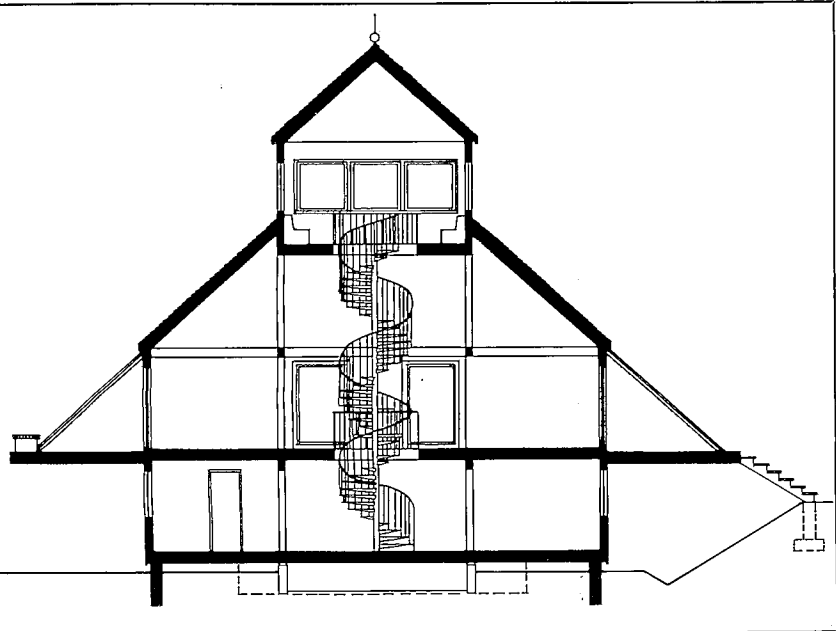



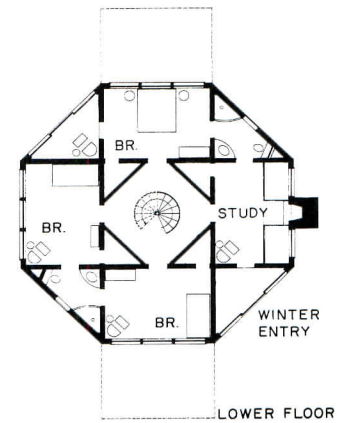
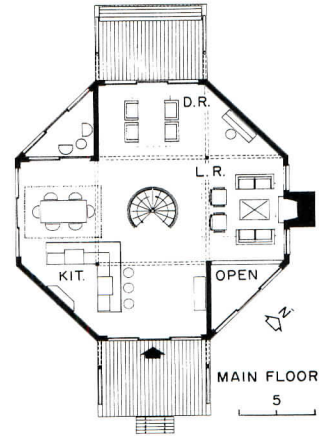
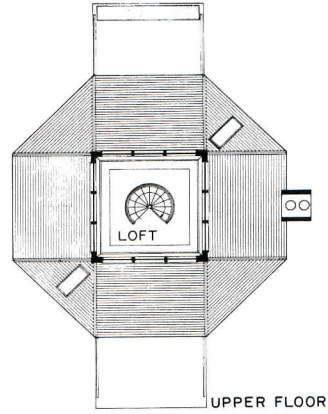

The only color in the clear-finished wood interior is purple, found on the spiral staircase. Architect Nagle has particular praise for the local Swedish carpenters whose craftsmanship was essential to the otherwise unadorned interior. Walls and ceilings are cedar; kitchen counter and table are maple block recycled from a local bowling alley. On a wall just outside the kitchen (left), a ladder for agile children leads to a corner loft.





## WELLS HILL HOUSE FAIRFIELD COUNTY, CONNECTICUT BY REDROOF DESIGN

"Sometimes my house reminds me of Andrew Wyeth's paintings," says the owner of this converted barn, as she looks out over a hillside pasture sloping away to stone walls and woods. Visitors approaching the house from the top of the hill (above left) are apt to see shades of Wyeth, too, although a walk around this surprising building reveals that it is not at all the cliché of reconstituted Americana its quaintly weathered timbers would suggest. The client asked for "a comfortable modern house inside an old barn," and Redroof Design took her literally at her word, installing a 20th-century white box—close kin to the flat-roofed studio houses of the '20s—within the skeleton of a 19th-century frame structure. This piquant juxtaposition of old and new emerged from the architects' decision to emphasize the patent artifice of a well-appointed barn. "It's really the modern counterpart of an 18th-century garden folly," says Yann Weymouth of Redroof, "rather like the Gothick ruins where ladies and gentlemen retreated to drink tea." Even though the rough-hewn posts and beams of the barn penetrate the cool planar geometry of the house, the new living pavilion is clearly defined as a self-contained volume. At the downhill base of the building, the space between the outer shell and the inner block is treated as a latticed porte cochère. On the upper levels, partial removal of old wall boards on the south and west fronts created an airy verandah that opens the interior to views and daylight, gently dappled as it passes through knotholes, crevices between boards, and exposed roof framing. Small-paned windows were retained on the east wall, the one facade where the perimeter of the house abuts the barn, and on the north, where the expanse of siding acts as a winter wind screen. Inside, a simple layout orients the two-story living room to the south for passive solar gain, the master bedroom to the rising sun, and the kitchen and dining area toward the sunset. A large round skylight above the living room offers a barn swallow's-eye view of rafters and nailers silhouetted against the clouds. —D.B.



**Architects:** Redroof Design  
30 East 20th Street  
New York, New York  
Yann Weymouth—partner-in-charge  
Peter Coan, Franklin Salasky,  
Ken Sanden—design team  
**Engineer:** Doug Watson (structural)  
**Interiors:** Rio Raikes and Franklin Salasky  
**General contractor:** Roxbury Contractors—Rio Raikes  
and Joe Speranza  
**Photographer:** Elliot Erwitt. Courtesy House & Garden.  
© 1981 by The Condé Nast Publications Inc.





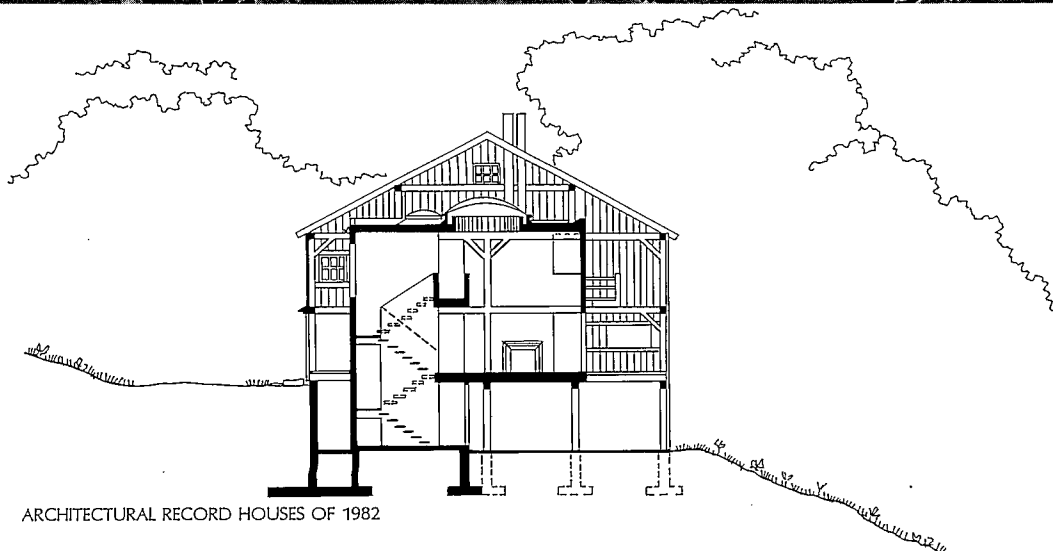

The gabled onion barn which forms both the outer shell and the inner armature of Wells Hill House formerly stood about eight miles away in farm country that has long since turned suburban. Old siding, pine plank floors, and chestnut posts and beams were dismantled and numbered for reconstruction at the new site. For a picturesquely "ruinous" effect, window frames set with cracked and pitted glass were retained on the north facade, where they admit light to the recessed entry.

REDROOF DESIGN

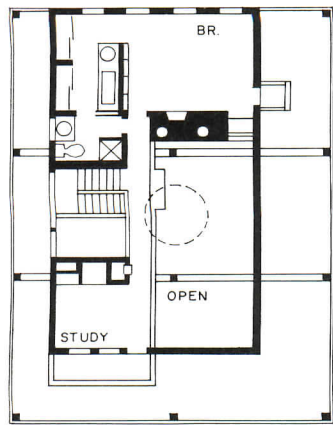

UPPER FLOOR

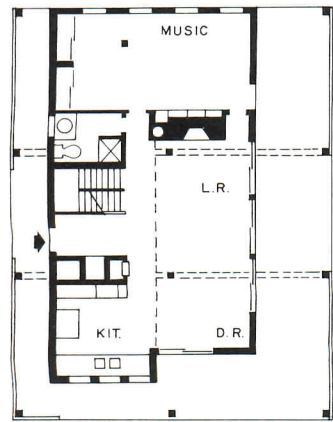

MAIN FLOOR

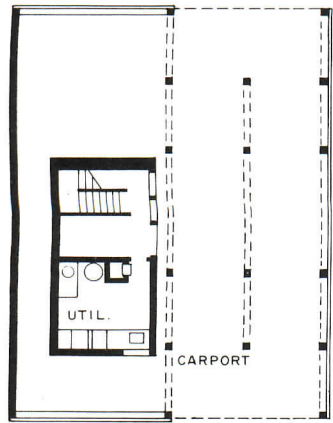

LOWER FLOOR

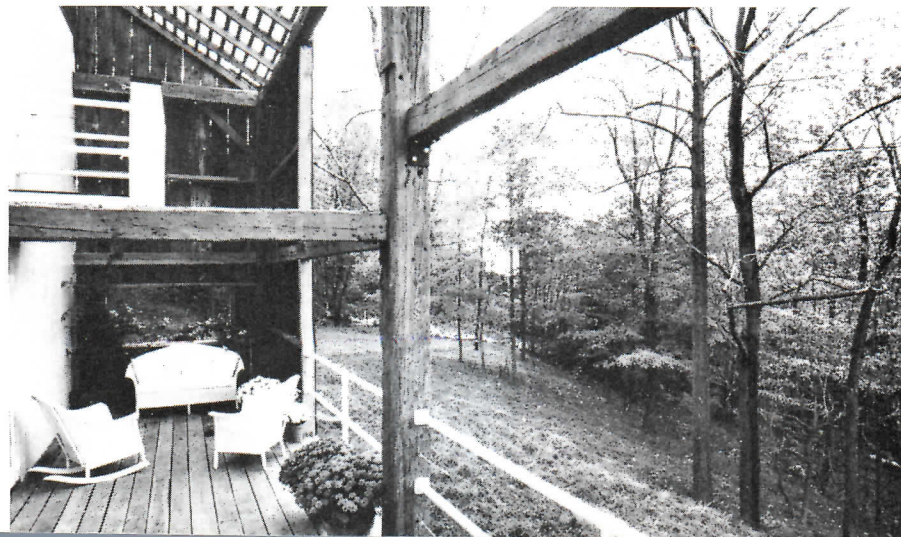

By playing off conventionally picturesque elements of rural vernacular against the no less conventional forms of early Modernism, Redroof Design has intertwined two durable strands of architectural nostalgia. While hand-carved timbers create a sympathetic setting for antique furniture (and modern pieces in the same spirit), the simple geometry of the inner pavilion, with its flat roof, bi-level living room, pipe-railed balconies, and carport, evokes the canonical *machine à habiter*.

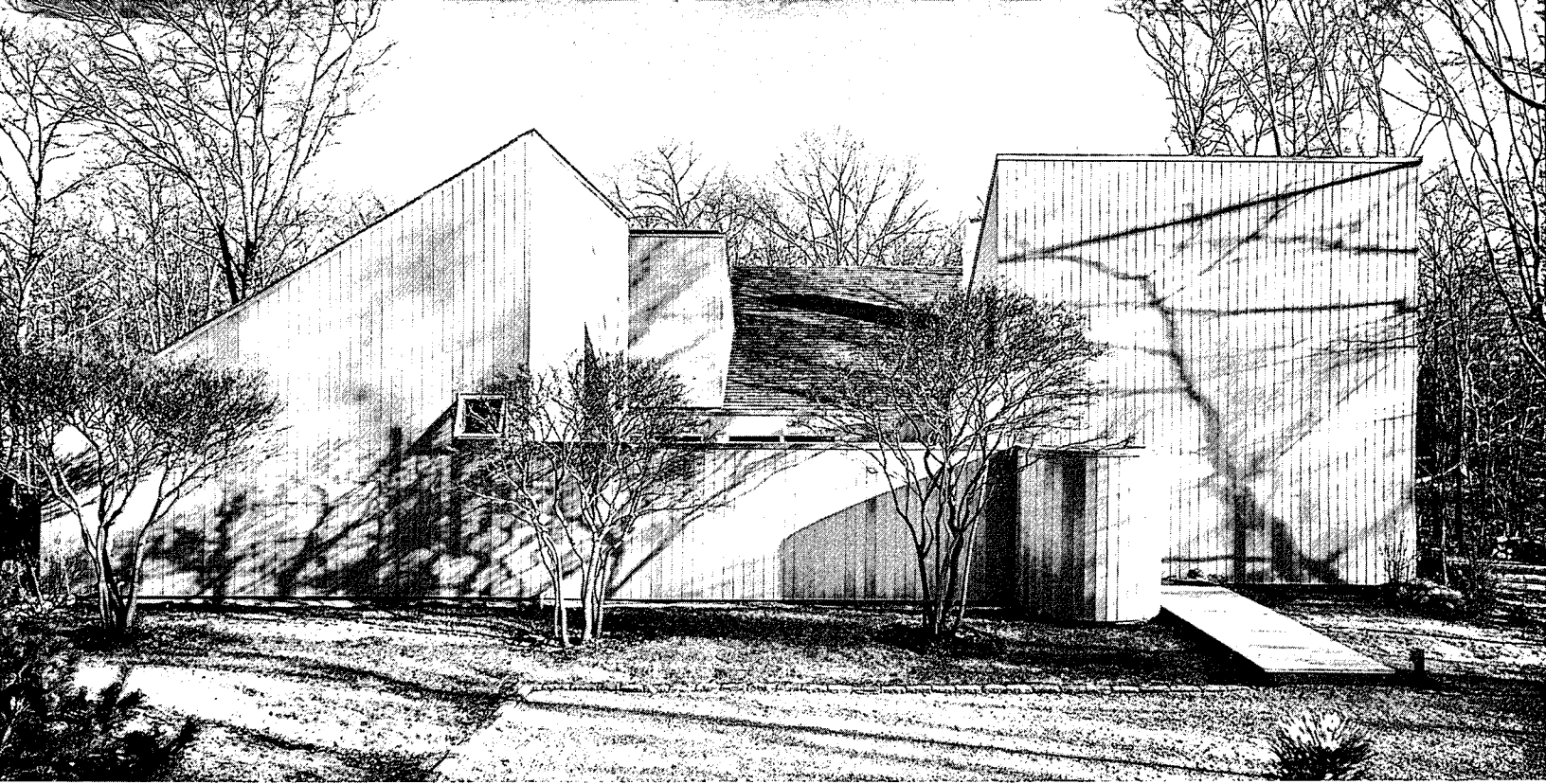

## THE CHIARAVIGLIO HOUSE EASTERN LONG ISLAND BY NESKI ASSOCIATES

This beautiful and environmentally-sensitive site is an undulating woodland of oak and beech located near Amagansett on Long Island's eastern tip. Its owners, a South American couple, wanted a private weekend retreat, and the plan that the architects developed in response to their needs unites three shed-roofed forms around a sizeable entry court. The roof massing is picturesque and characteristic of the region, but the entry court is unexpected on a site so isolated and heavily screened by trees. It developed in the plan because the owners, who come from a culture where courts are commonplace, wanted to leave the woodlands undisturbed, but yearned for a composed, contemplative, and sharply confined outdoor space.

Clustered around it, though not keyed to it visually, the main spaces of the house turn outward to the site. The living-dining-kitchen volume is edged with a long, narrow deck that overlooks a swimming pool sunk deep in a gully that sequesters it—and makes it all but invisible from inside the house. The master bedroom is isolated in its own structure, as is the guestroom wing across the court. When not in use the guestrooms can be

completely closed off and left unheated.

The house is constructed using standard wood frame, but dropped beams over the main living spaces act as bracing elements and carry the cedar of the exteriors inside where it contrasts warmly with the white gypsum board and with the floor finish of Mexican tile. Standard glazing units are used for windows and sliding door assemblies, and the detailing of materials, both inside and out, is eloquent but restrained.

Outdoor areas—particularly near the court and pool—have been carefully floodlighted, not only for the pleasant illumination that tree lighting provides, but to alleviate the sense of loneliness, even spookiness, that must occasionally overtake the occupants of any house set deep in the woods. —B.G.



**Architects:** Neski Associates  
8 West 40th Street  
New York, New York  
Susan Strohbach-associate  
**Owner:** Mr. and Mrs. Richard Chiaraviglio  
**Engineer:** Robert Silman (structural)  
**Contractor:** Lynch Lafountain & Sons  
**Photographer:** Norman McGrath

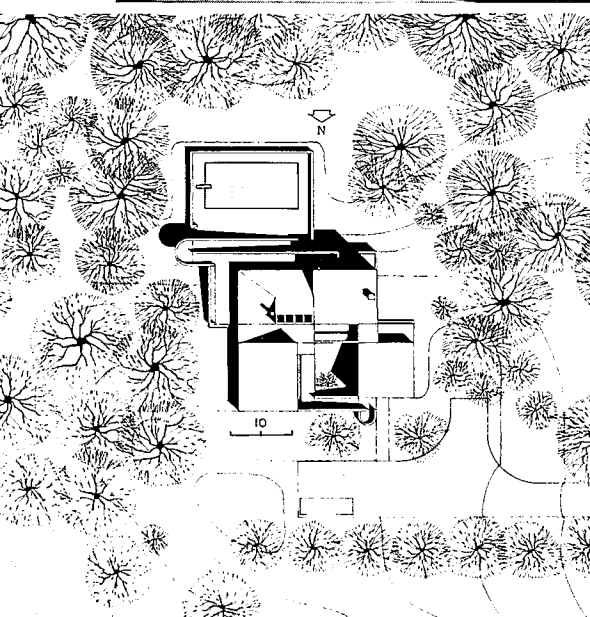
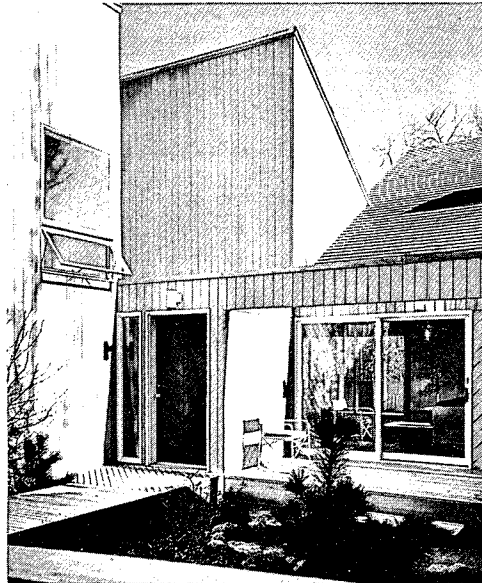







The living areas of this appealing house open to woodland views that change dramatically with the seasons. The views into the entrance court, by contrast, are no more than a modest glimpse. Dropped beams over the space effectively modulate the ceiling height (photo above).

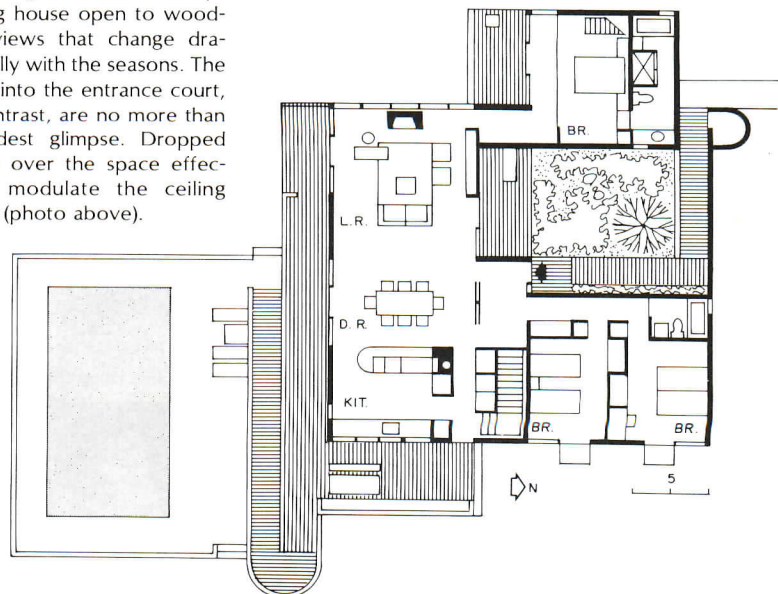





# REMODELED CARRIAGE HOUSE EASTERN LONG ISLAND BY SUSANA TORRE

Axonometrics have a way of making any building look like a grown-up doll house, an effect that is particularly congenial to the spirit of Susana Torre's scheme for this remodeled stable on eastern Long Island. In her transformation of the turn-of-the-century balloon-frame structure, Torre strove to evoke memories of snug childhood hideaways—treehouses and attic nooks—that enhance the gentle seclusion of a country retreat. Of course, the Shingle Style building is itself the vestige of another favored realm for nostalgic reverie, the pre-war era of croquet lawns, wicker tea tables, and white flannels. Without resorting to pastiche of specific period models, Susana Torre has taken great pains to preserve as much as possible of the vintage exterior, while creating new interior spaces and a series of decks and balconies that provide a remarkably flexible layout. Seen from the outside, the most conspicuous results of the renovation are an east-facing trellised entry porch (photo opposite), whose silhouette reflects the form of the gabled dormer behind, and a tall arched window cut into the opposite western facade (overleaf). Along this east-west axis, Torre has inserted a paneled center hall and stairway, reminiscent of the pivotal circulation spaces of authentic Shingle Style dwellings. The remainder of the plan has been disposed along quite different lines, with the master bedroom downstairs and the main living room upstairs in the former hayloft (plans and photos overleaf). There is a kitchen and a bathroom on each story, and two sleeping alcoves are tucked alongside the eaves upstairs, in order that both levels can be used independently, according to the variable needs of family and guests. It is the upper room, with its sloped ceiling and playhouse-like kitchen enclosure, that most nearly recovers the cozy ambience of children's secret lairs; but even here, one is drawn outward to enjoy the changing aspect of the seaside landscape. On the east, the top of the latticework porch is a sheltered belvedere for outdoor dining, and on the south, there is a bowfront balcony, just large enough for one person to look out over Shinnecock Bay and the ocean. —D.B.

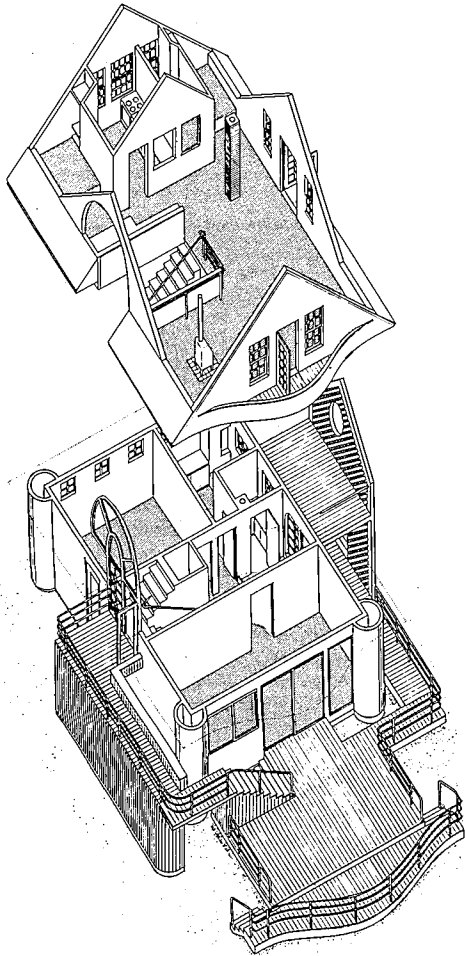

The cedar-shingled stable, designed around 1910 by New York architect Grosvenor Atterbury, was hauled from its original site a quarter-mile away to save it from an encroaching housing development. Susana Torre's landscape plan calls for a trail of yellow mustard flowers, planted to mark the path of the building's arrival.

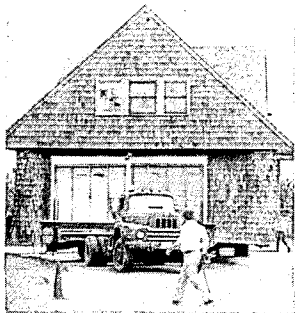

*Architects:* Susana Torre, The Architectural Studio  
242 West 38th Street  
New York, New York  
Dorothy Alexander, Steve Midouhas,  
Donna Robertson, and Richard Velsor—production  
*General contractor:* Harold Reeve and Sons  
*Photographer:* Timothy Hursley

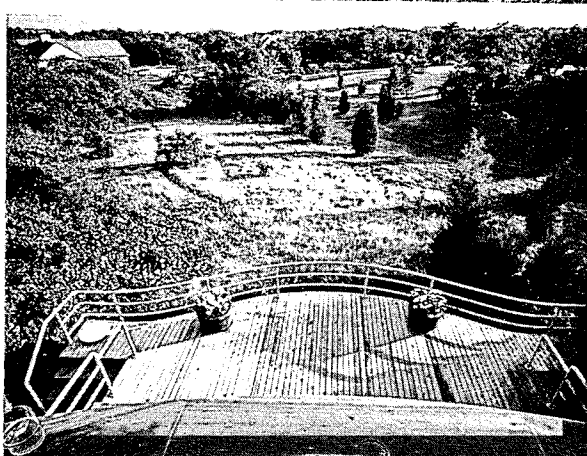
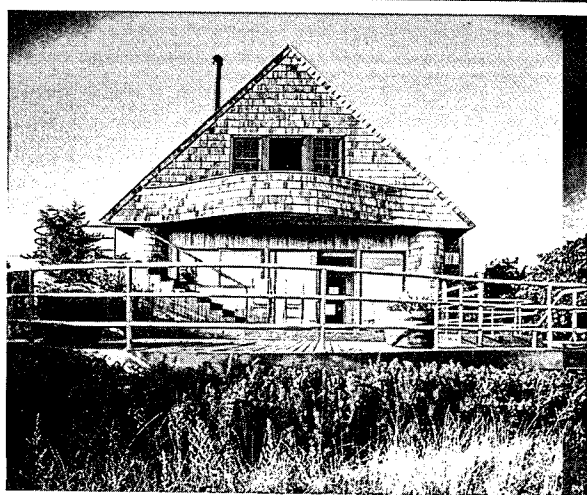
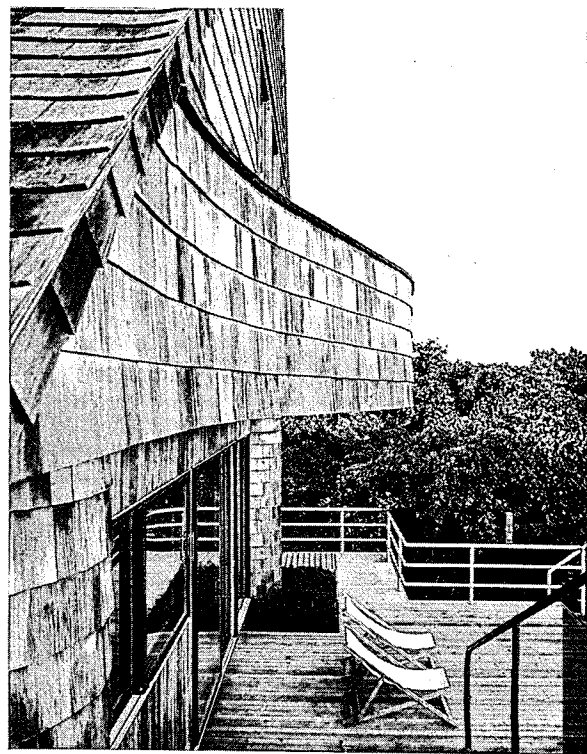

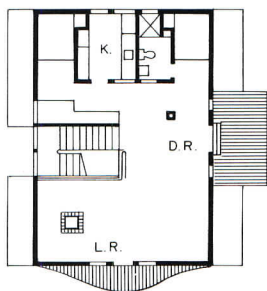
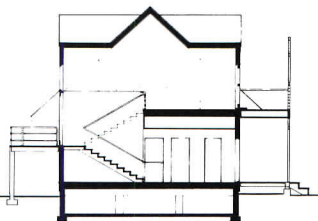

SECOND FLOOR

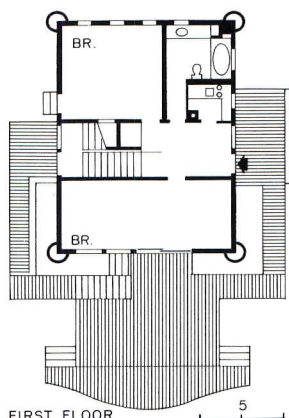

FIRST FLOOR



Although the carriage house was placed on new footings at the present site, most of the structure was kept intact during the move, including the brick chimney. Old rafters were exposed, and beaded pine boards that had covered stable ceilings now line the walls of the entry and stair hall. The sloped enclosure of the upper level has been paneled in clear-finished cedar, which contrasts with the painted surfaces of the kitchen and bathroom unit at one end of the space (opposite). With its own miniature facade, this doll house-like pavilion is flanked by sleeping alcoves for children or summer guests. (Susana Torre delights in the tilt of the corbeled chimney, which reminds her of a rough trunk poking through a tree house.) Small windows were retained in the northern gable wall, which faces a busy road. On the other three sides, windows and balconies open the room to sunrise and sunset, and a panorama of the dunes and the sea. The door on the landing (left) can function as a separate entrance to the second story.







# THE VIERECK HOUSE LONG ISLAND BY GWATHMEY SIEGEL

Without abandoning the vocabulary of forms with which this firm has been so successful, Gwathmey Siegel & Associates has striven to capture a little of the spirit and the feel of a French country house in this design for a prominent French fashion photographer and his wife, who wished to build on a heavily-wooded, six-acre site in eastern Long Island. Siting the house on the property's only knoll, and opening it eastward to distant views of Gardiner's Bay, the architects developed an economical, three-level plan that encloses only 2,100 square feet, but feels very ample in all its spaces.

The lowest level provides an entry and extra bedroom, but most of its space is given over to the owner's photographic studio. A level above are the major living spaces, and, at the top of the house, a modestly scaled loft bedroom for the owners who asked the architects to provide only the minimum of space and amenity in their private quarters.

The interiors are designed to be composite and compact. Like the French prototype—to which Gwathmey Siegel have paid at least a nodding tribute—these interiors are a place for withdrawal. Their spaces are hardworking and contain an unusual number of built-ins. The kitchen is at the heart of the plan. In the Viereck house, the stairway takes a tremendously active role in ordering and enriching spaces, and it provides not only vertical continuities but forceful diagonal thrusts that are given added emphasis by multiple pipe railing details.

In the selection of color accents, both inside and out, the architects were guided by the owners' shared preference for bright primaries. A highly-charged yellow is used at the transoms and on some interior wall surfaces while the metal flues emerge through the roof in a rich red. The rest of the exterior, by contrast, is treated in the soft gray of weathered cedar, but these surfaces are animated by projections and cutbacks—and by openings that, despite their variety, are disciplined.

Among this firm's many fine houses, the Viereck house stands out not just for its modest scale, but because it exhibits an inner consistency and control that are almost absolute. —B.G.



**Architects:** Gwathmey Siegel & Associates  
475 10th Avenue  
New York, New York  
Bruce Nagel (associate-in-charge)  
Daniel Rowen (designer)

**Engineers:**  
Geiger Berger (structural)  
Thomas Polise (mechanical)  
**Contractor:** Caramagna & Murphy  
**Photographer:** Norman McGrath

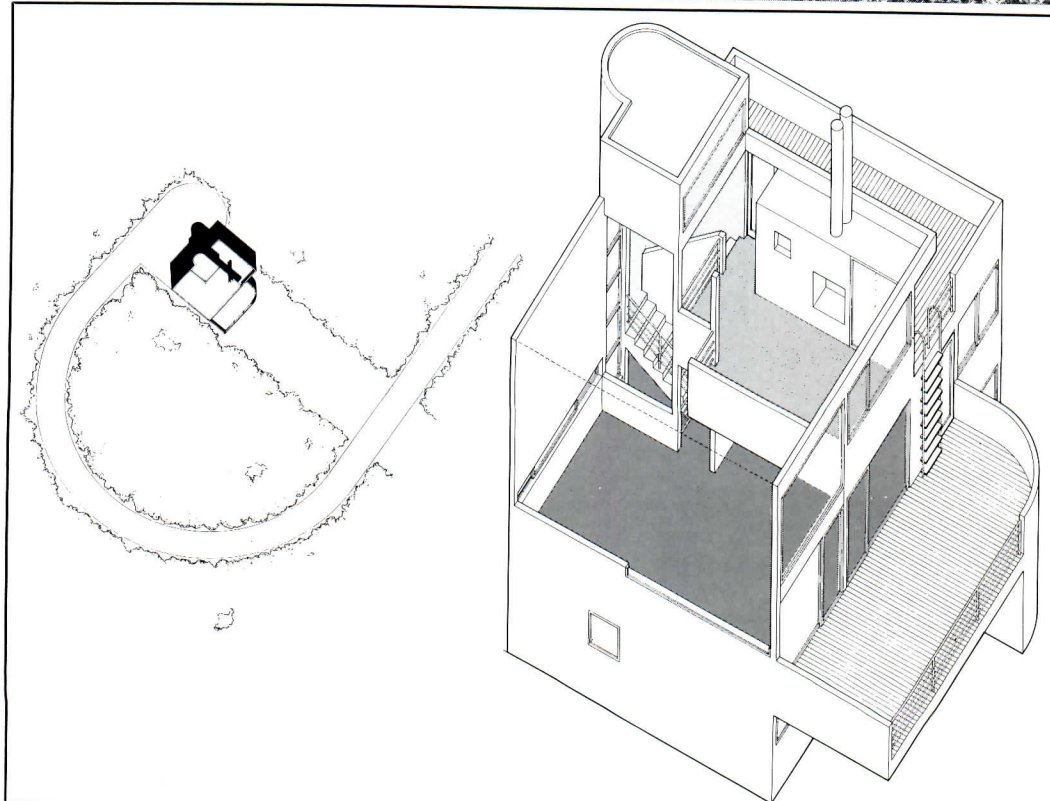



GWATHMEY SIEGEL

The plans below and the photos on this spread show the enormous visual energy generated by the spaces as they flow into each other—an energy that is one of the Viereck house's most compelling features.

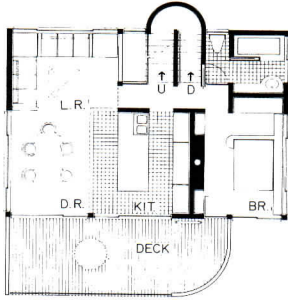

FIRST FLOOR

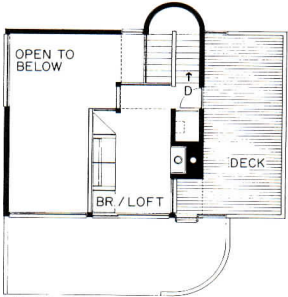

SECOND FLOOR

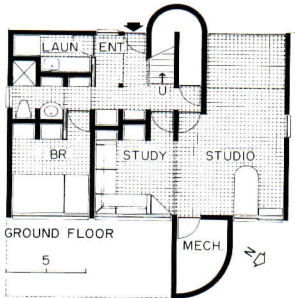

GROUND FLOOR

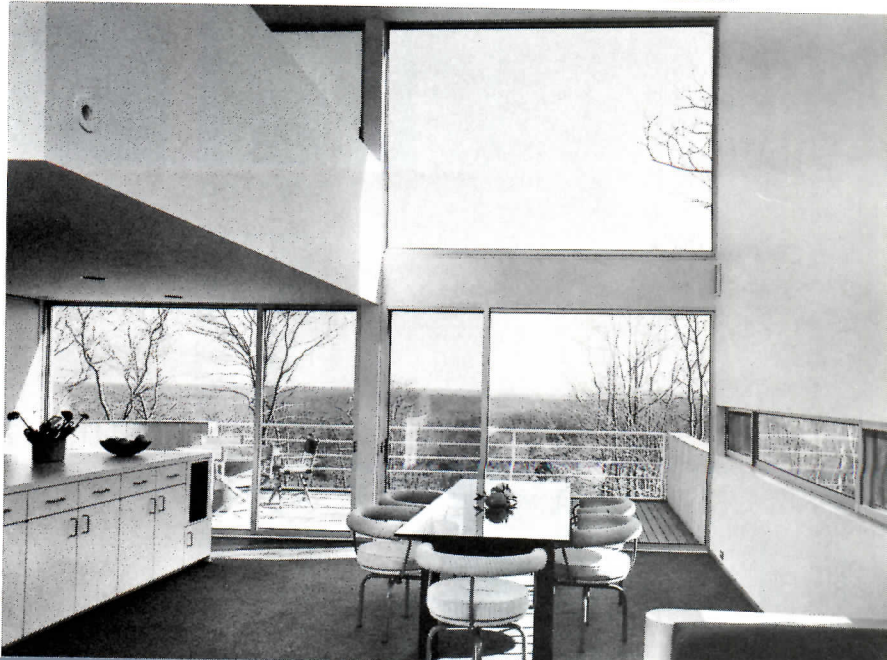
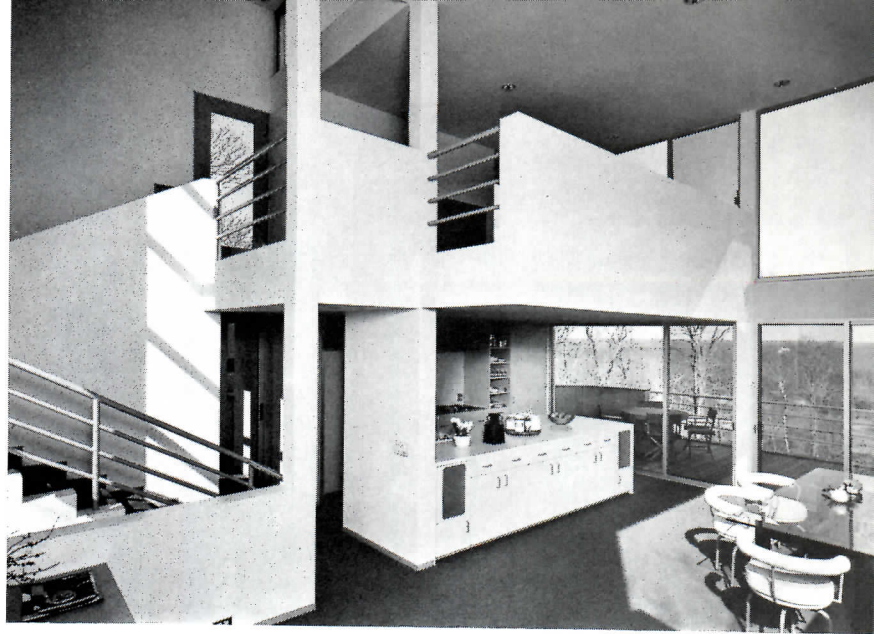

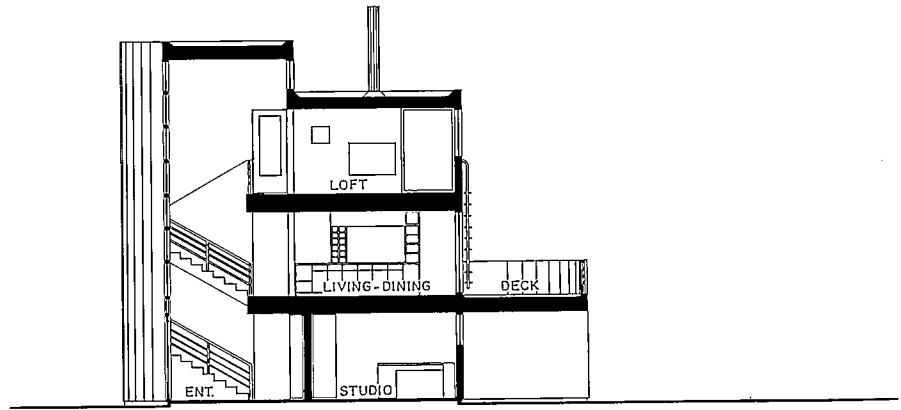
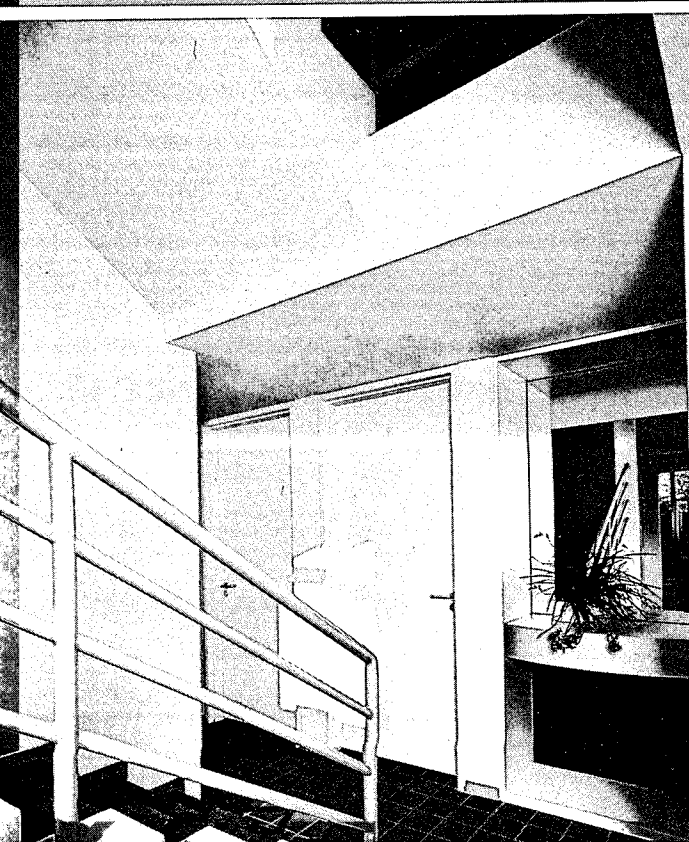
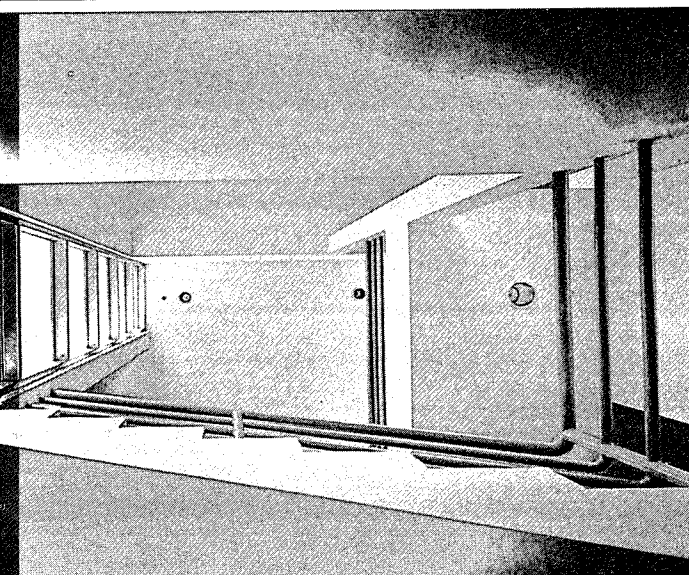
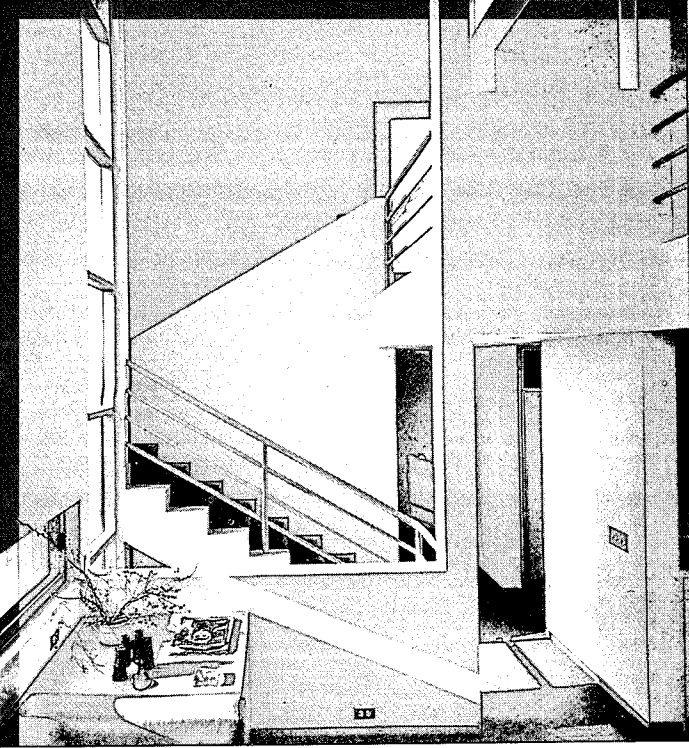

GWATHMEY SIEGEL

The simple, three-level arrangement of the Viereck house shows most clearly in the section above. The stairs (photos left) are given a visual prominence that is thoroughly appropriate to a design of such vertical development. The master bedroom (photo below) is located at the top of the house and offers superb views of eastern Long Island.

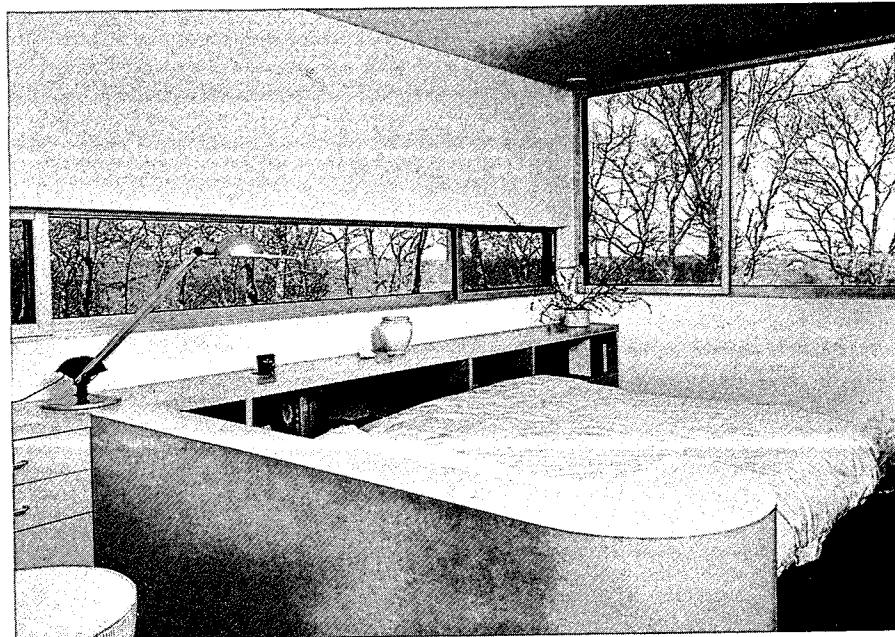



DAYLIGHT AND VIEW DO NOT ALWAYS GO TOGETHER

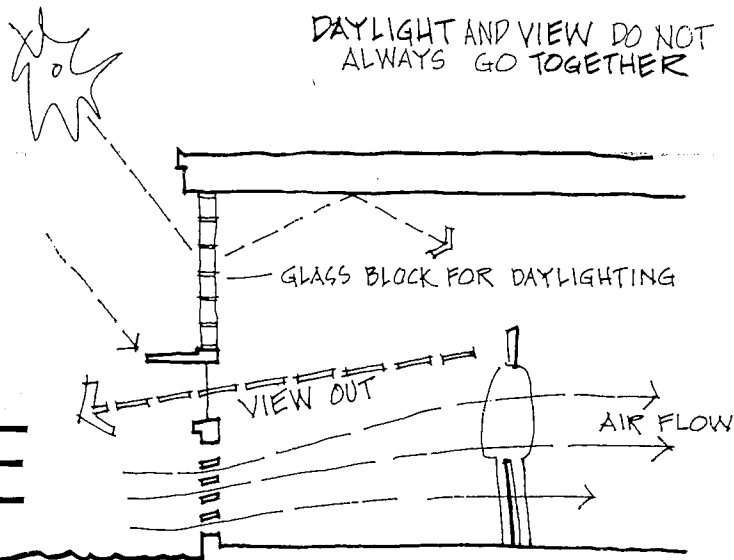

# DAYLIGHT IN ARCHITECTURE

Benjamin H. Evans, AIA

This is clearly a book whose time has come. The author demonstrates the values of appropriate daylighting in building design, and he provides techniques and principles for achieving effective use of daylight. Eighteen case studies on a variety of building types dramatize how daylight can give form to buildings.

Never before has a book explained how to test daylight design through the use of models. Evans, who has taught with models for years, describes an easy-to-use procedure for model making that can provide invaluable preliminary data on which to base your final design.

Do you think you'll have trouble convincing your client that integrating daylight into a building is worth the initial expense? Evans' cost analysis offers you a practical guide to prove the cost efficiency of daylighting. Avoiding complicated daylight calculation formulas or computer-based prediction techniques, Evans explores the potential cost savings and energy savings in using daylight.

DAYLIGHT IN ARCHITECTURE is directed particularly to architects, although building owners, lighting engineers, and design students—indeed, everyone involved in the design of a building—can benefit from reading it. Order your copy today!

216 pages, 135 photos, over 100 diagrams, charts, and drawings.

## CONTENTS

- 1: INTRODUCTION
- 2: THE NEED FOR LIGHT
  - seeing the task
  - biological needs
- 3: DAYLIGHTING RELATED TO OTHER DESIGN CONCERNS
  - electric lighting
  - natural air flow and acoustics
  - solar energy
  - view
- 4: HOW DAYLIGHT BEHAVES IN ARCHITECTURE
  - goals for good daylighting
  - guidelines for good daylighting
  - form-giving factors
  - daylight controls
  - orientation
- 5: THE NATURE OF "THE SKIES"
  - sky conditions
  - quantifying available daylight
- 6: MODEL STUDIES
  - building the model
  - instrumentation
  - available light meters
  - sky conditions
  - model testing
- 7: COST-EFFECTIVE DAYLIGHTING DESIGN
  - first costs
  - operating costs
  - blackout costs
  - determining life-cycle costs
- 8: DESIGNS WITH DAYLIGHT—CASE STUDIES
  - sidelighting (3 examples)
  - skylighting (6 examples)
  - clerestories (3 examples)
  - atria (4 examples)
  - luminous structures (2 examples)
- APPENDIX
  - life cycle cost benefit analysis.
- REFERENCES
- INDEX

### Other useful Architectural Record titles —

**ENERGY CONSERVATION THROUGH BUILDING DESIGN**  
 edited by Donald Watson, AIA  
 A collection of essays on topics that include analyzing energy use in buildings, passive solar heating, architectural design based on climate, and energy required for construction. Practical information and techniques presented by a team of experts: Spielvogel, Dubin, Stein, Knowles, Eccli, and Arumi. Preface by Sim Van der Ryn.  
 308 pages. 160 illustrations, charts, and tables. \$24.95

**THE ARCHITECT'S GUIDE TO FACILITY PROGRAMMING**  
 by Mickey A. Palmer and the AIA  
 Shows you how to collect and evaluate information for a complete and realistic picture of your clients' requirements. Emphasizes effective communication of this information to the designer. Fourteen case studies provide actual programming models.  
 304 pages. Over 125 diagrams, charts, and matrices. 75 sample questionnaires, surveys, and procedural outlines. \$34.95

ARCHITECTURAL RECORD BOOKS  
 P.O. Box 682  
 Hightstown, New Jersey 08520

Please send me the titles I have indicated:

\_\_\_\_\_ DAYLIGHT IN ARCHITECTURE at \$29.95

\_\_\_\_\_ ENERGY CONSERVATION THROUGH BUILDING DESIGN at \$24.95

\_\_\_\_\_ ARCHITECT'S GUIDE TO FACILITY PROGRAMMING at \$34.95

name \_\_\_\_\_

street \_\_\_\_\_

city \_\_\_\_\_ state \_\_\_\_\_ zip \_\_\_\_\_

Payment must accompany your order. Include \$1 per book to cover postage and handling and add applicable sales tax. Allow 3-4 weeks for delivery.

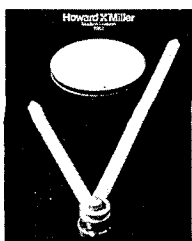

**CLOCKS** / The Howard Miller Clock Company's 1982 catalog describes their collections, identifying the features of each clock including graphics, materials and movements. The clocks, designed by Arthur Umanoff, George Nelson, and William Sklaroff, are shown in color photographs and diagrams. ■ Howard Miller Clock Co., Zeeland, Mich.

circle 400 on inquiry card

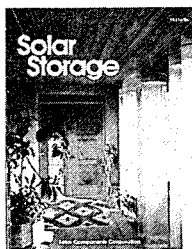

**SOLAR STORAGE** / A four-page color brochure describes non-pressurized, cylindrical, solar-energy-storage tanks made of fiberglass reinforced polymer sheet. The tanks are 18 in. in diameter, 120 in. high, and weigh 19 lb. They may be used to hold liquids, powders or solids. ■ Solar Components Corp., Manchester, N.H.

circle 405 on inquiry card



**PHOTO/VIDEO FURNITURE** / A 16-page color catalog displays a multitude of video console cabinets and utility carts as well as video tape storage and transport systems. Also included are slide trays, files and light boxes. Prices and dimensions are listed with descriptions of each model. ■ Luxor Corp., Waukegan, Ill.

circle 410 on inquiry card



**CONTROL SYSTEM** / A six-page brochure describes an automatic lighting- and appliance-control system. The system involves a programmer that carries out scheduled on/off cycles and a transmitter which sends signals to modules in existing wall boxes. It may be used for both security and energy savings. ■ Leviton Manufacturing Co., Inc., Little Neck, N.Y.

circle 401 on inquiry card

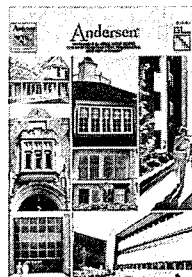

**WINDOWS** / A 1982 catalog from Andersen describes its windows, gliding patio doors and new products: a box bay unit; a window for narrow openings such as stairway landings; and ten additional sizes for the 30- and 45-deg angle bay units and bow windows. Specifications and technical data are included. ■ Andersen Corp., Bayport, Minn.

circle 406 on inquiry card

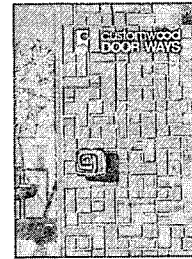

**DOORS** / A 28-page, four-color brochure illustrates eight series of door designs. Materials include oak, mahogany, walnut and ash, either finished or unfinished. Included in the brochure are specifications and information on finishes. ■ Customwood, Albuquerque, N.M.

circle 411 on inquiry card

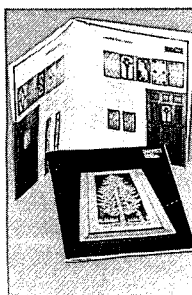

**WOOD DOORS** / A selection of doors, columns, spindles and stair parts is assembled in an indexed 68-page color catalog. Included are descriptions of and specifications for each of over 1,000 products. Among the products are sidelights, thermal glass and Dutch doors. *The catalog is available for \$2.50 by writing to: E.A. Nord Co., P.O. Box 1187, Everett, Wash. 98206.*

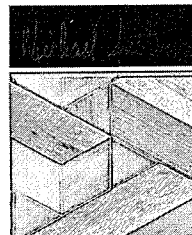

**PARQUET FLOORS** / A 16-page, four-color brochure describes 13 wood and brick designs. Installations are shown with detail drawings and photographs to illustrate the use of materials. Information on finishes is included as well as descriptions and pictures of two design applications for walls and ceilings. ■ Michael Anthony Studios, Ltd., Chicago.

circle 407 on inquiry card

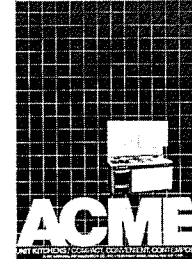

**KITCHENS** / An eight-page color catalog describes and gives specifications for compact kitchens. These kitchens come in 10 series, ranging in size from 30 in. to 72 in., and are available with a gas or electric range. Special features and optional equipment are highlighted. ■ Acme National Refrigeration Co., Inc., Long Island City, N.Y.

circle 412 on inquiry card

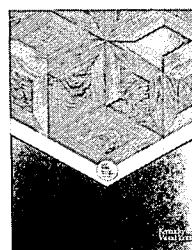

**FLOORS** / A 12-page color catalog from Kentucky Wood Floors features hardwood flooring in 37 designs. Included are photographs of installations coupled with diagrams and dimensions. Information on specifications, installation and maintenance is also included. ■ Kentucky Wood Floors, Inc., Louisville, Ky.

circle 403 on inquiry card

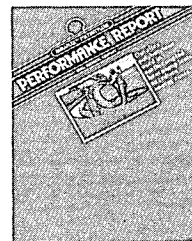

**HEAT PUMP SYSTEMS** / A four-color, four-page performance report from Shell describes its Duraflex polybutylene pipe earth coils designed to improve geothermal heat pump systems. The mechanics of the coils and pump systems, and the results of experimental installations are discussed in detail. ■ Shell Chemical Co., Houston.

circle 408 on inquiry card

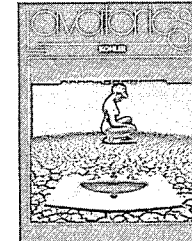

**LAVATORIES** / An eight-page color brochure shows 15 models of Kohler sinks in a variety of colors. Ten styles of faucets are shown as well. Accompanying each photograph is a description with information on available colors and the materials used. A color chart also indicates available colors for each model. ■ Kohler Co., Kohler, Wis.

circle 413 on inquiry card

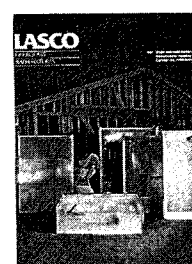

**BATHS** / An eight-page, four-color catalog describes fiberglass bath fixtures. Combination tub/showers, shower stalls and bathtubs are illustrated. The shower stall section includes two-wall showers, plus compact and deluxe three-wall showers. Products' compliance with major codes is detailed. ■ Lasco Industries, Anaheim, Calif.

circle 404 on inquiry card

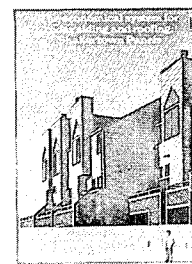

**SHINGLES** / Cedar shingle products are described in a 1982 color catalog. In 12 pages, photographs, detailed technical illustrations and data make up a reference manual of red cedar sidewall panels, roof panels and cedar shingles. A selection chart pictures each type of panel and shingle and gives dimensions. ■ Shakertown, Winlock, Wash.

circle 409 on inquiry card

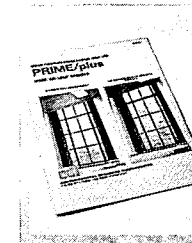

**INSIDE WINDOWS** / An eight-page brochure describes an airlock window system designed to attach to the casing opening on the inside of an original window. The brochure also compares the system to ordinary outside storm windows in terms of energy efficiency. ■ Environmental Dynamics, Inc., Findlay, Ohio.

circle 414 on inquiry card

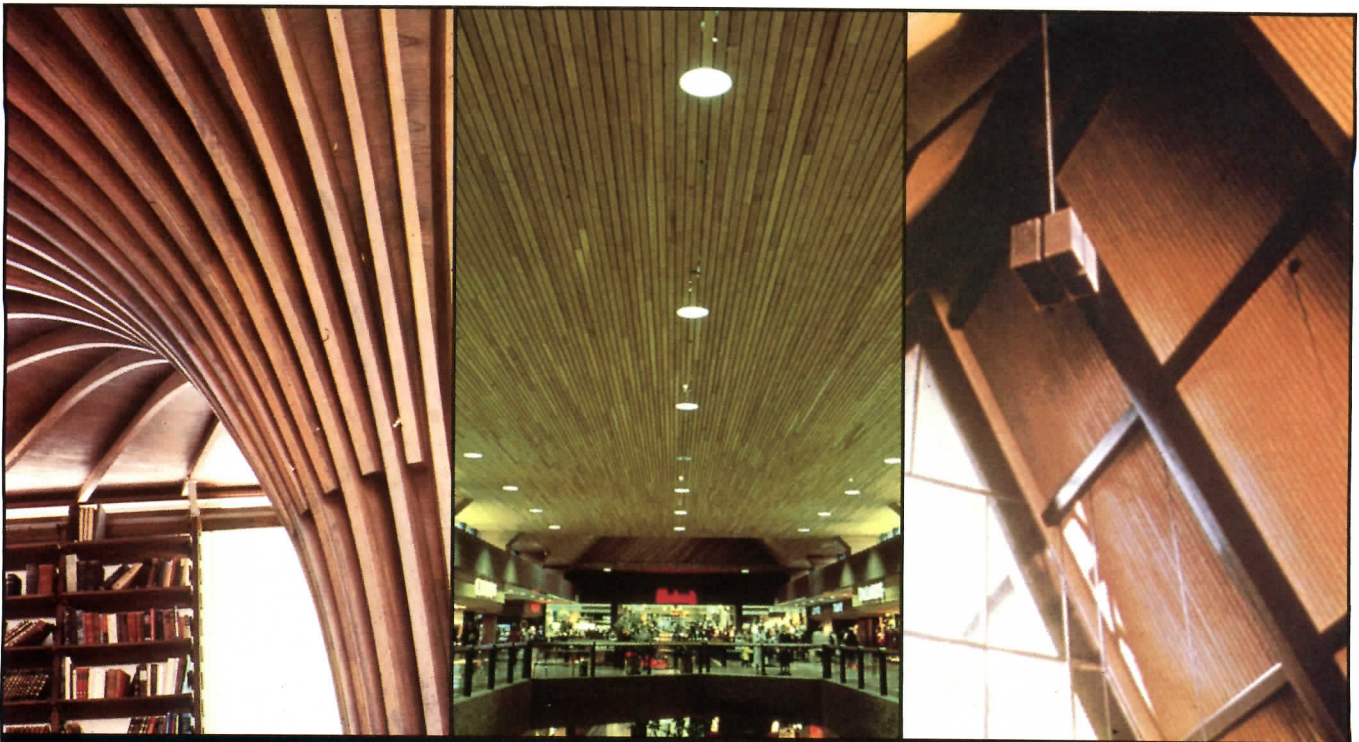

# Flame Proof<sup>®</sup> LHC.

## The Superior Fire Retardant, Pressure-Treated Wood from Osmose.

What you don't see on the outside protects on the inside. FLAME PROOF<sup>®</sup> LHC has the qualities you can count on. It is superior to other interior fire retardant treated wood because it is non-blooming, less-corrosive to metal fasteners, and has UL approval. FLAME PROOF<sup>®</sup> LHC is a special chemical formulation free of sulfates and chlorides, ideal for use wherever fire hazards must be minimized.

Osmose FLAME PROOF<sup>®</sup> LHC fire retardant treated wood has distinct advantages over other building materials for interior roof decks, architectural millwork, roof and floor trusses, beams, paneling, interior load bearing and non-load bearing partitions in apartments, commercial, industrial and institutional buildings.

FLAME PROOF<sup>®</sup> LHC fire retardant treated wood is a superior product that provides an extra margin of fire safety in any architectural application. It also qualifies for lower insurance rates.

For more information concerning FLAME PROOF<sup>®</sup> LHC send for a free copy of the Sweets Brochure or refer to the 1982 Sweets Catalogue.

  
ANOTHER QUALITY PRODUCT FROM OSMOSE.



**OSMOSE**<sup>®</sup>

**OSMOSE WOOD  
PRESERVING CO.  
OF AMERICA, INC.**  
980 Ellicott St., Buffalo, NY 14209  
Phone 716-882-5905

Circle 41 on inquiry card

## European-styled spa products

These two sleek new lines are the latest additions to this manufacturer's collection of European-designed kitchen, bath and spa products. Grohe America Inc., a subsidiary of ITT, conducted a two-year study beginning in 1975 on the acceptability of European-designed faucets; once finding great favorability, Grohe introduced in 1978 their two-handle models. The two new lines presented at right are called Euromix and Relaxa.

The Euromix line includes the single-handle lavatory centerset and kitchen deck faucet, and the tub filler/hand shower. The Relaxa line includes five different hand-held shower models.

All products are available in polished chrome, 23-karat gold, antique brass, pewter or satin brass finishes. The faucets are solid brass and feature a patented solid brass cartridge for durability.

■ Grohe America, Inc., Elk Grove Village, Illinois

circle 300 on inquiry card  
more products on page 129



Relaxa shower system

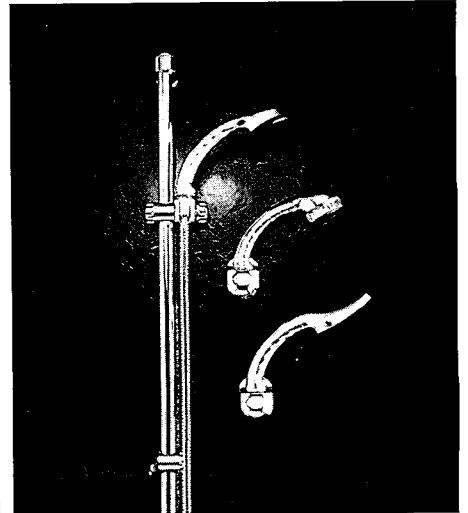

Relaxa adjustable shower head

## a potpourri of possibilities *In Lighting, And Fine Cast Aluminum Furniture Is Yours With Welsbach.*

The elegance of our street lighting, and the charm of our interior designs are now complemented by the Lahner Collection of cast-aluminum furniture.

The Lahner Collection by Welsbach is a true designers collection. An exceptionally graceful assembly of Victorian, Colonial, Traditional, Oriental and Neoclassic motifs.

Each model is painted in semi-gloss lacquer. The upholstered seating is fitted with a foam-filled, expanded, or sueded vinyl cushion. Extensive color and pattern choices are offered in both paint and upholstery.

Durable cast-aluminum preserves the authentic, precise detailing of the original handcrafted molds, and yet makes each piece lightweight and virtually maintenance free.

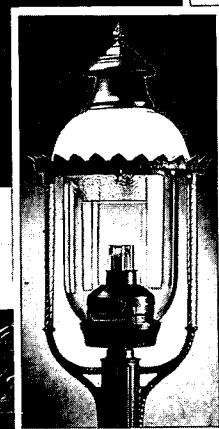

*The Welsbach tradition for fine lighting is now enhanced by*

*The Lahner Collection*

For further information and literature contact:  
Welsbach Lighting  
The Lahner Collection  
240 Sargent Drive, New Haven, CT. 06511



Circle 42 on inquiry card



Euromix tub filler/hand shower



Euromix lavatory centerset

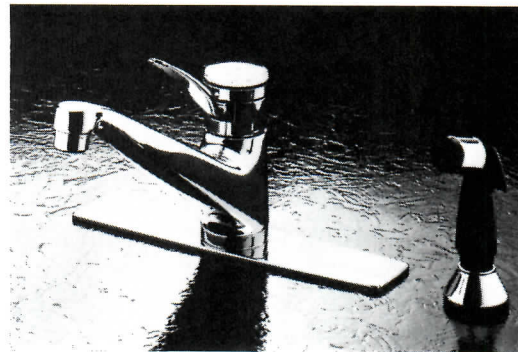

Euromix kitchen deck faucet

## Once you start using VELUX roof windows, it's difficult to stop.

With over 40 years experience specializing in roof windows and working closely with architects around the world, we've learned a thing or two. In terms of design, function, ease of installation, weather tightness and the availability of a complete program of options, including special glazings, you could not ask for more. Economically priced from about \$200 to \$500, they conform to all major building codes and may be used in passive solar applications.

**VELUX. The world leader in roof windows and skylights!**



VELUX-AMERICA INC.  
P.O. Box 3208  
Greenwood, S.C. 29646  
In Canada: Velux-Canada, 2525 a  
J.B. Deschamps Lachine,  
P.Q. Canada H8T1C5

Name \_\_\_\_\_

Address \_\_\_\_\_

City \_\_\_\_\_

State \_\_\_\_\_

Zip \_\_\_\_\_



Architect: Douglas Trees  
Contractor: Spalding & Slye

# Zero's new "sound-stop 1-R" door system

The new Zero "Sound-Stop 1-R" guarantees a continuous seal around the full perimeter of the opening. Special attention is given to the corners. Result: An S.T.C. rating of 44!

Write for our two new catalogs. One tells all about the new "Sound-Stop 1-R"—as well as the rest of the Zero line. The other tells you all you need to know about S.T.C. ratings, decibels, frequencies, etc.

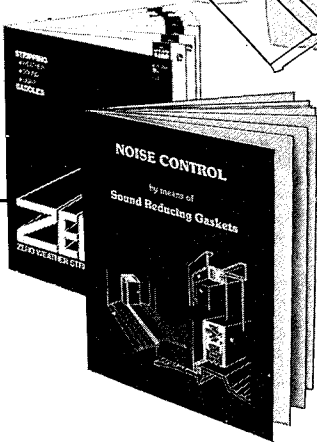
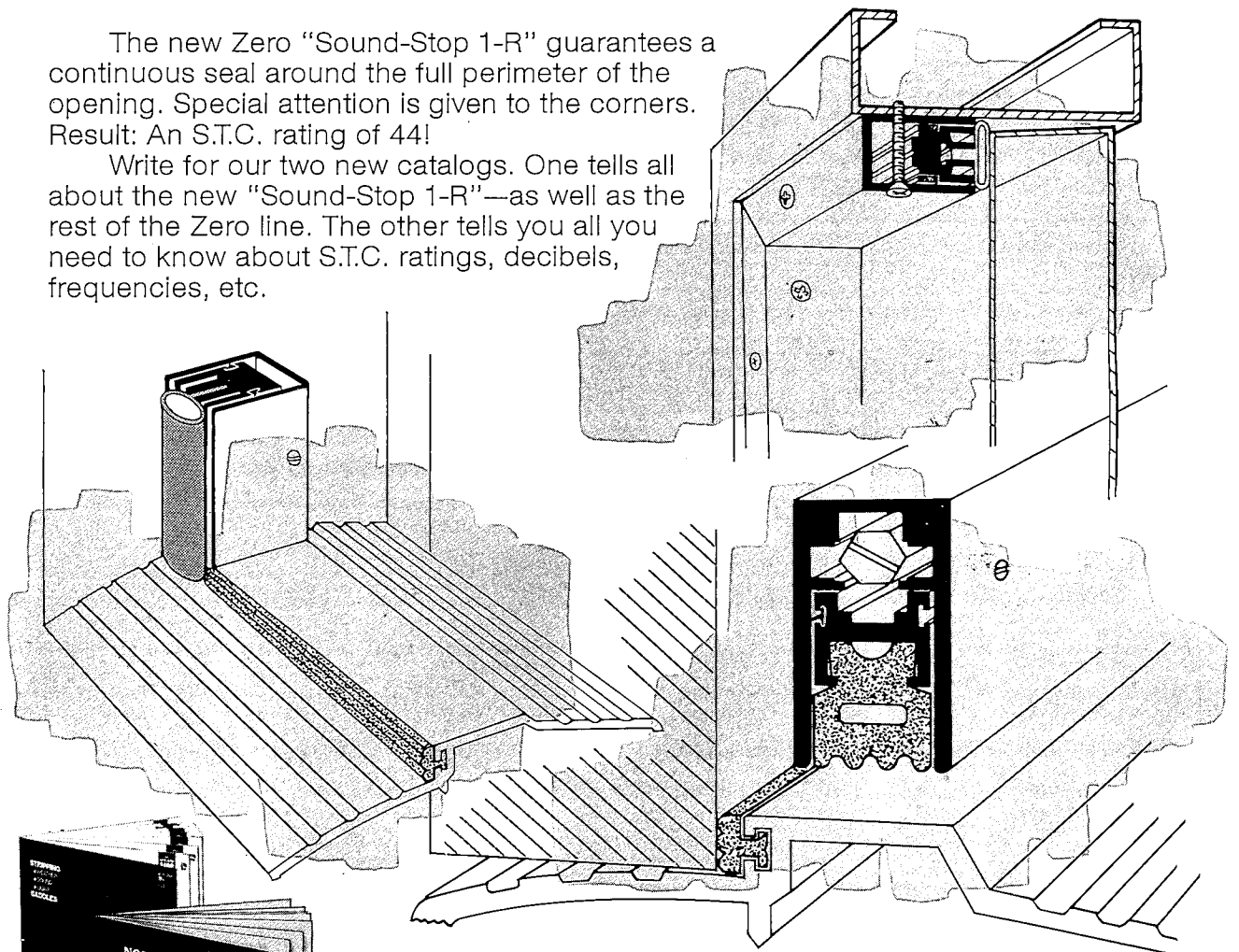

SOUND  
STOP  
SYSTEM



**Zero Weather Stripping Co., Inc.**

415 Concord Ave., Bronx, N.Y. 10455. (212) 585-3230  
1924-1982...58 years of opening the door to progress.

VISIT US AT CSI, BOOTH 509

Circle 44 on inquiry card



**ROUNDED FRAME ARMCHAIR** / Designed by Bob Becker to be rugged yet light in scale, the *Delphi Chair* has a carefully joined, rounded frame of natural ash or yellow birch with walnut, cherry or mahogany finish. It is suggested for a number of executive office applications, as a pullup guest chair, for dining or at the conference table. ■ Helikon Furniture Co., Inc., Taftville, Conn.

*circle 301 on inquiry card*

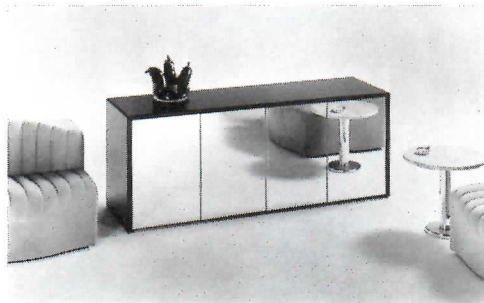

**PANEL-FRAME CREDENZA** / Another version of Paul Mayen's "Katonah" floor credenza, the 1 1/8-in.-gauge panel-frame unit is made with two, three and four touch-latch doors. Mirror-finish doors may be combined with either 14 glossy or low-glare colors, five woods and five burls. ■ Intrex Inc., New York City.

*circle 304 on inquiry card*

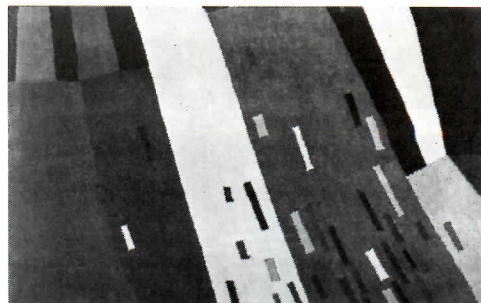

**AREA RUGS** / A new standard design in this all-wool custom area rug program, "Gotham City" is a stylized cityscape drawn by artist Bill Hinz in a linear technique. Handcrafted area rugs, wall hangings and carpeting are offered for residential and commercial applications. ■ Form III, North Vernon, Ind.

*circle 305 on inquiry card  
more products on page 131*

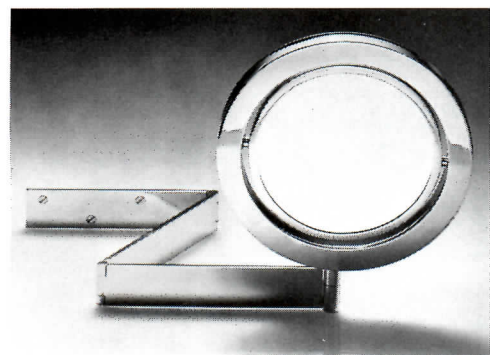

**EXTENSION MIRROR** / Stanley Paul's "Lombardy" mirror is mounted on an extension bracket, and swivels to provide both regular and two-and-a-half power magnification. The wall-hung fixture is solid brass, and is available in polished brass or chrome finish. ■ Paul Associates, Long Island City, N.Y.

*circle 302 on inquiry card*

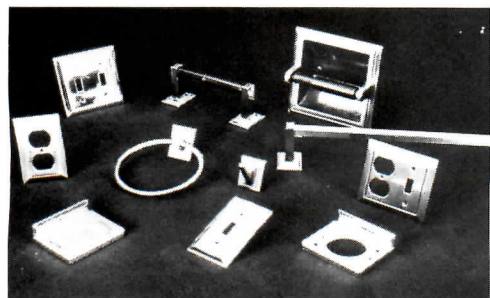

**BATHROOM HARDWARE** / The *Accent II Collection* features bath hardware and switchplates in contemporary styling. Bathware is available in antique or polished brass finishes. Each grouping includes an 18-in. and 24-in. towel bar, towel ring, recessed as well as surface-mount tissue holders, garment hook, wall-mounted soap dishes and toothbrush/tumbler holder, plus four common wall plate combinations. ■ Amerock Corp., Rockford, Illinois.

*circle 303 on inquiry card*



James Renaldo, Architect

**PROJECT:** Buffalo Convention Center, Buffalo, N.Y.

**SPECIFIED WALLCOVERING:** MAYATEX WOVEN SISAL

**INSTALLATION:** After researching many types of wallcoverings, the architects determined that MAYATEX SISAL incorporated all of the features needed for this specific installation.

**SISAL is:** Flame retardant, cigarette resistant, cost efficient, sound absorbing, insulating, extremely durable and naturally static-free. It installs easily on walls and floors with minimal surface preparation and requires very little maintenance. Exciting visual and textural contrasts are achieved when SISAL is used alone or in combination with other building materials.

**RESULTS:** Four years after its installation, the SISAL is still going strong! Architect Jim Renaldo says, "We are delighted with the performance of this product. It has fully lived up to our original expectations."

**TASITWEED**



**TASIWALLS**

These SISAL floor and wallcovering products, manufactured by TASIBEL and CORDEMEX, are available in a wide range of natural textures and colors.

For more information or to see an installation in your area contact one of these exclusive importers:

**MAYATEX**



**TAFATAX**

Eastern USA & Canada: Merida Meridian, Inc., 405 E. Hiawatha Blvd., Syracuse, NY, 13208, (315) 422-4921  
Central USA: Design Materials, Inc., 2000 Grand Ave., Kansas City, MO, 64108, (816) 221-6544  
Western USA: Continental Western Corp., 2211 Frederick St., Oakland, CA, 94606, (415) 532-1558

**Circle 45 on inquiry card**



# STO full thermal exterior insulation makes all your energy conservation concepts work better

Let's say you designed or are planning a condominium incorporating some of the most sophisticated environmental energy conservation systems in the industry.

Now, make all those systems work at peak efficiency with STO full thermal exterior insulation on the building itself.

STO exterior insulation fully utilizes the thermal mass of any structure, eliminates infiltration, reduces thermal stress and maintains vapor permeability. It's light-weight, crack resistant, maintenance free, economical and easy to install.

As dramatically demonstrated on Diamond Tower, Milwaukee, the STO system gives you absolute design freedom with virtually no restrictions on unique shapes or angles, color and texture combinations.

Write or call for full information today.



**STO energy conservation incorporated**  
Quality Lane, Box 219, Rutland, Vermont 05701  
802/775-4117  
2189 F Flintstone Drive, Tucker, Georgia 30084  
404/939-9590

Circle 46 on inquiry card

Architect of Record: Plunkett, Keymar, Reginato  
Architects and Associates.





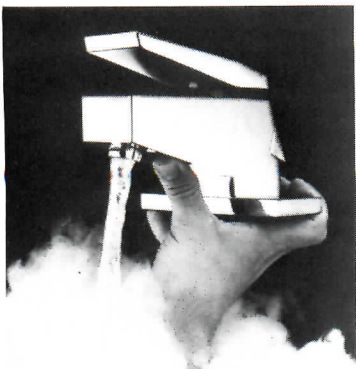

**FAUCET** / This single control lavatory faucet, called *Roma*, is part of the 1982 deluxe new product lines. It is washerless, with the water flow controlled by a ceramic disc cartridge. It is made of solid brass with a chrome finish. ■ American-Standard, New Brunswick, New Jersey

*circle 306 on inquiry card*



**KITCHEN CABINET** / Designed with front frame construction to facilitate installation and alignment, "Omni" cabinets come in almond laminate with solid oak recessed pulls and trim. Doors hang on concealed hinges, and open a full 109 deg. Convenience accessories include an appliance garage/cutlery tray and a microwave oven cabinet. ■ Merrilat Industries, Inc., Adrian, Mich.

*circle 307 on inquiry card*



**LAMINATE CABINETS** / A contemporary design, "Metallia" cabinets are available in a *Formica* lacquer finish, with mirrored backsplashes and wine-rack cubicles as shown here. The simple case lines are set off by pewter geometric pulls. ■ Roseline Products, Inc., Farmingdale, N.Y.

*circle 308 on inquiry card*

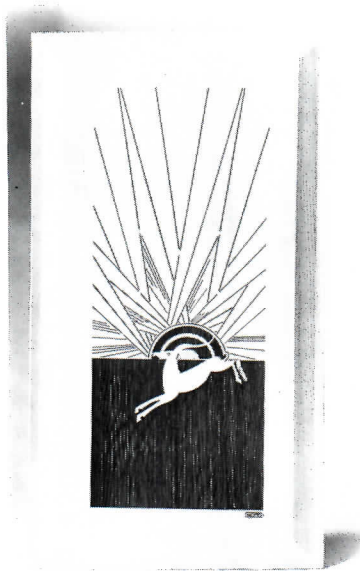

**LASER-CARVED DOOR** / Through laser beam technology, precision woodworking can be achieved. This door collection consists of seven different designs ranging from Art Nouveau style to timberline scenes. Available in door widths from 2-ft 6-in. to 3-ft. ■ E.A. Nord Co., Everett, Wash.

*circle 309 on inquiry card*

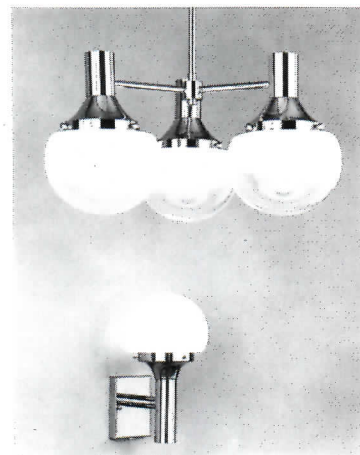

**CEILING FIXTURE** / The "Opal" light series features globes of hand-blown glass; a three-light ceiling fixture is shown here. There are also three-globe floor lamps, and a single-globe wall fixture. ■ Koch + Lowy, Inc., Long Island City, N.Y.

*circle 310 on inquiry card*



**FAUCET SET** / Shown here in polished chrome finish, the "Pompton" faucet has rectangular handles set into circular stems. Fixtures are available in five different finishes. ■ Paul Associates, Long Island City, N.Y.

*circle 311 on inquiry card*

*more products on page 133*

# A New Classic.

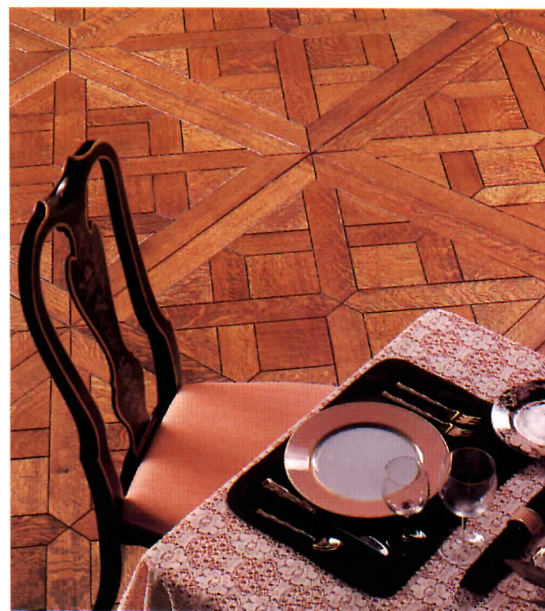

Custom Classic: Palace, Quartered Oak, Beveled Edges.

Kentucky Wood Floors introduces the latest additions to their renowned Custom Classics, a line noted for its excellence in design and craftsmanship.

"Palace," created for the Helmsley Palace in New York, is joined by two other patterns: "Aristides" and "Continental." These new additions are presented in a color brochure showcasing an entire line of quality hardwood flooring to fit any need or budget.

Contact your Kentucky Wood Floors distributor or Gary Keibler, Vice President of Marketing.

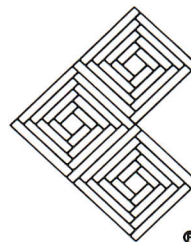

**Kentucky Wood Floors** Inc.  
4200 Reservoir Avenue  
Louisville, Kentucky 40213  
502/451-6024

**Circle 47 on inquiry card**

# WEATHER SHIELD

## Energy Efficient Windows and Doors

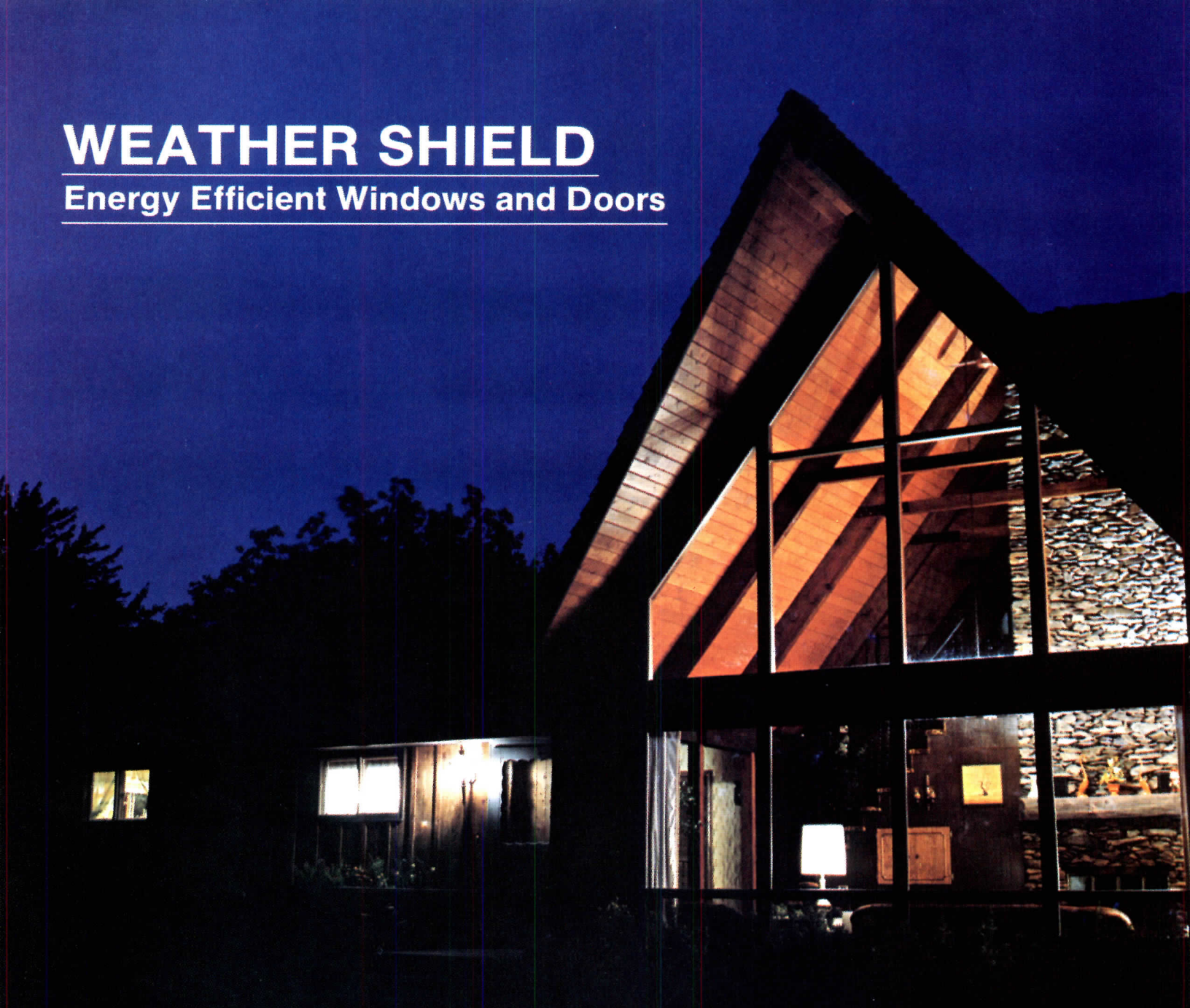

In addition to our complete line of wood windows, patio doors, and steel insulating entrance systems, Weather Shield will manufacture direct set units to your custom home plan.

Our direct sets can be ordered in a wide variety of shapes and sizes, including triangles, octagons, trapezoids, and special square or rectangular sizes.

With uncompromising craftsmanship, we design each custom unit to compliment your Weather Shield casement, awning, double hung, and scenav-u windows. For total building continuity, we offer coordinated patio and steel insulating entrance doors to further enhance your window selections.

Get to know Weather Shield, see the Sweet's file #8.16/wd or call Weather Shield's Marketing Manager, H. J. Koester at (715) 748-2100.

Direct set glazing options provide optimum energy efficiency and value — select from 1" insulating or 1" triple insulating glass, or maximize solar energy gains with our new triple and quad pane SolaireFilm units. All are available in a choice of several virtually maintenance-free exteriors.

For the design-conscious, it's Weather Shield windows and doors — a beautiful way to add shape, dimension, interest, and creative flair to the structure and architectural design of the home.

**WEATHER SHIELD**

WEATHER SHIELD MFG., INC.  
P.O. Box 309, Medford, Wisconsin 54451



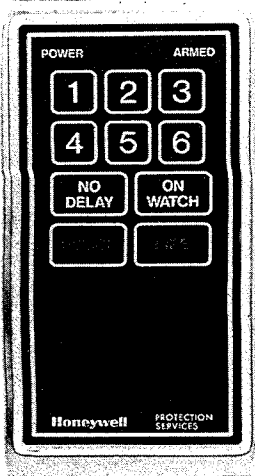

**BASIC SECURITY /** The "Classic" home and apartment security system is professionally installed to monitor selected moveable openings, sounding a siren in the panel in the event of an alarm condition. A signal is simultaneously relayed to the Honeywell central station, which instantly summons police or fire emergency services. The system can be armed or disarmed with a private code that the homeowner can change easily at will.

circle 312 on inquiry card

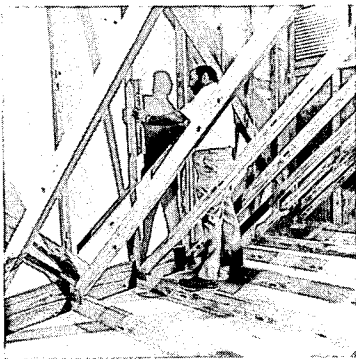

**FIRE RETARDANT WOOD /** Designed for application in weather protected areas of buildings, *Dricon* fire retardant-treated wood claims two significant advantages over other types of treated lumber: it has "low hygroscopicity" (reduced moisture pickup), and low corrosivity of metals in contact with the treated wood. *Dricon* building components such as studs, trusses and beams may be used with metal lathe and plaster or dry wall for construction in buildings classified fire resistive. Roof decks, joists and purlins of *Dricon* wood qualify for a UL Class 1 roof system designation.

circle 313 on inquiry card

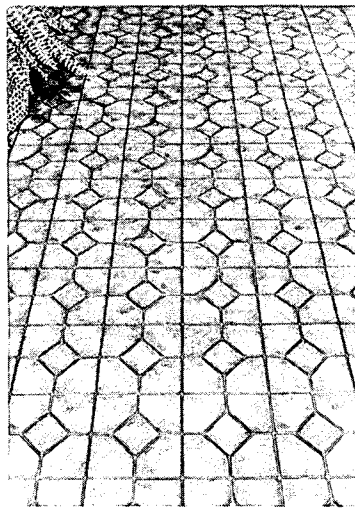

**RESILIENT FLOORING /** Subtle colorations and dimensional "grout lines" are said to add authenticity to "Key West" floor covering. The tile-pattern floor has application in most residential interiors, and features the *Diamond Glow* wear surface.

circle 314 on inquiry card

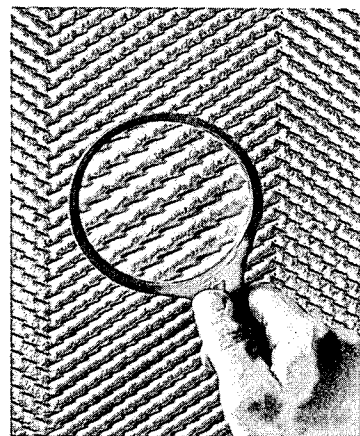

**RATED CARPET CUSHION /** Made of flame-retardant sponge rubber, "Sentinel" commercial carpet underlay has a fire hazard rating of 20-15-5 under ASTM E84-80. It meets Class A requirements of NFPA Interior Finishes Standard 101-1976, and is suitable for such high-hazard occupancy areas as hospitals, schools, hotels, etc. It can also be used in high-traffic areas such as corridors and lobbies, both above and below grade.

circle 315 on inquiry card  
more products on page 135

# People keep putting us on top.

PATENTED

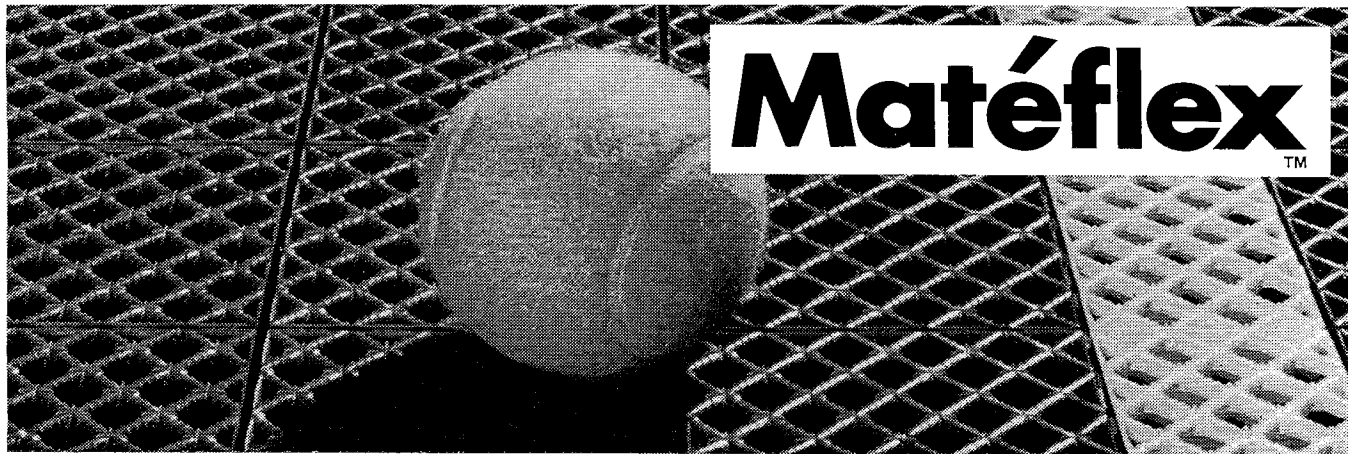

# Matéflex

TM

... And for the very best reasons! **DURABLE** and **LONG-LASTING**—Matéflex interlocking modules are made from a special blend of polypropylene and rubber that stands up to the toughest matches. Resisting heat, cold and the sun's direct rays, Matéflex is a proven winner season after season!

**FLEXIBLE** enough to absorb shock and prevent leg fatigue, yet Matéflex always maintains ideal playing speed and ball bounce.

With **INSTANT DRAINAGE** you'll never play on a wet surface. Our unique flow-through design immediately filters water, leaving the court in excellent playing condition.

**MAINTENANCE FREE**—Matéflex never needs repairs or adjustments. Once installed, Matéflex insures the best possible performance! So, if you're thinking of resurfacing your old court or building a new one, **THINK MATÉFLEX**—the best all-around tennis court surface made today—Because we planned it that way!

**Franchises Available!**

For complete information call, or mail this coupon! Matéflex by Mele, 1712 Erie Street, Utica, New York 13503 AR-52  
Phone: (315) 733-4601

**Ask about Matéflex Rooftop Tennis Court Systems**

I am interested in  on grade  rooftop systems.

NAME \_\_\_\_\_

COMPANY \_\_\_\_\_

ADDRESS \_\_\_\_\_

CITY \_\_\_\_\_ STATE \_\_\_\_\_ ZIP \_\_\_\_\_

Circle 49 on inquiry card

# Why more corporate controllers are recommending Colorline® partitions.

The reasons are simple: 100% five-year depreciation; full 10% Investment Tax Credit; significant savings over conventional drywall installation costs; faster job completion; less mess; complete re-usability; easy maintenance; and finished walls that look like a million bucks.

For details on how Colorline® partitions can save money beautifully, ask for our FREE "Colorline® Partitions Pay Off" booklet. Contact Unistrut Interior Building Systems, 1821 Bedford Avenue, North Kansas City, MO 64116, (816) 421-4011. Or call your nearest Unistrut Service Center, listed on the facing page.



## UNISTRUT

Interior Building  
Systems

GTE

Colorline® 3.75: Superior sound control with no visible fasteners.



Circle 50 on inquiry card

## GET THE FACTS FROM THESE COLORLINE DISTRIBUTORS

**ALABAMA** — See Louisiana

**ALASKA**  
Unistrut Alaska Div.  
of John P. Bagoy & Assoc.  
(907) 274-8531

**ARIZONA**  
Unistrut Arizona (602) 252-3093

**ARKANSAS** — See Louisiana

**CALIFORNIA**  
LOS ANGELES  
Unistrut Los Angeles  
(213) 921-9861

**SAN FRANCISCO**  
Unistrut Northern California  
(415) 351-4200

**COLORADO**  
Unistrut Western (303) 733-5535

**CONNECTICUT**  
See Massachusetts

**DELAWARE**  
See Eastern Pennsylvania

**FLORIDA**  
CLEARWATER  
Unistrut Florida (813) 531-0467  
POMPANO BEACH  
Unistrut Florida (305) 943-4802

**GEORGIA**  
Unistrut Georgia (404) 455-1256

**HAWAII** (816) 421-4011

**IDAHO** (816) 421-4011

**ILLINOIS**  
NORTHERN & CENTRAL  
Unistrut Illinois (312) 673-0404  
SOUTHERN — See East Missouri

**INDIANA**  
Unistrut Indianapolis (317) 897-3440

**IOWA** (816) 421-4011

**KANSAS**  
Unistrut Midwest (816) 842-2043

**KENTUCKY** (816) 421-4011

**LOUISIANA**  
Gregory-Salisbury Metal  
Products, Inc.  
(504) 524-5207

**MAINE** — See Massachusetts

**MARYLAND**  
Unistrut Baltimore,  
Div. of L.A. Benson Company  
(301) 342-9225

**MASSACHUSETTS**  
Unistrut Northeast (617) 876-1300

**MICHIGAN**  
WAYNE (DETROIT)  
Unistrut Detroit Service Co.  
(313) 722-1400

**TROY (DETROIT)**  
Unistrut Teal Service Company  
(313) 689-3000

**MINNESOTA**  
Unistrut Northern (612) 331-4383

**MISSISSIPPI** — See Louisiana

**MISSOURI**  
EASTERN  
Unistrut Service Company  
of St. Louis  
(314) 647-4344  
WESTERN — See Kansas

**MONTANA** (816) 421-4011

**NEBRASKA**  
EASTERN & CENTRAL  
Porter-Trustin-Carlson Co.  
(402) 453-2000

WESTERN — See Colorado

**NEVADA** (816) 421-4011

**NEW HAMPSHIRE**  
See Massachusetts

**NEW JERSEY**  
NORTHERN  
Unistrut Eastern  
(201) 467-0500  
SOUTHERN — See Pennsylvania

**NEW MEXICO**  
Unistrut New Mexico  
Div. of ARK Enterprises, Inc.  
(505) 881-0264

**NEW YORK**

UPSTATE  
Unistrut Buffalo  
(716) 854-7633

SOUTHEASTERN  
including New York City —  
See New Jersey

**NORTH CAROLINA**  
Mill Power Supply Company  
(704) 527-2800

**NORTH DAKOTA** (816) 421-4011

**OHIO**  
CINCINNATI  
Unistrut Cincinnati Div.  
of Jonel Company  
(513) 321-2502

**DAYTON**  
D.E.F. Industries, Inc.  
(513) 254-1768

**CLEVELAND**  
Unistrut Service Company  
of Ohio  
(216) 433-4350

**OKLAHOMA**  
TULSA  
Unistrut Oklahoma  
(918) 835-6941

**OKLAHOMA CITY**  
Unistrut Oklahoma  
(405) 232-5476

**OREGON**  
Unistrut Portland (503) 289-2531  
See also Washington

**PENNSYLVANIA**  
EASTERN  
Unistrut Philadelphia (215) 337-1282  
WESTERN (816) 421-4011

**RHODE ISLAND**  
See Massachusetts

**SOUTH CAROLINA** (816) 421-4011

**SOUTH DAKOTA**  
EASTERN & CENTRAL (816) 421-4011  
WESTERN — See Colorado

**TENNESSEE** (816) 421-4011

**TEXAS**  
HOUSTON  
Unistrut Gulf (713) 675-3261

**SAN ANTONIO**  
Unistrut Gulf (512) 349-3987

**DALLAS/FT. WORTH**  
Unistrut Texas (817) 261-3691

**EL PASO** (816) 421-4011

**UTAH** (816) 421-4011

**VERMONT** — See Massachusetts

**VIRGINIA**  
EASTERN  
Richmond/Norfolk  
Unistrut Div. of Architectural  
Industrial Products Co.  
(804) 222-6832

NORTHERN — See Maryland

WEST CENTRAL  
See West Virginia

WESTERN (816) 421-4011

**WASHINGTON**  
EASTERN (816) 421-4011  
WESTERN  
Unistrut Northwest (206) 251-5230  
VANCOUVER AREA See Oregon

**WEST VIRGINIA**  
NORTHEASTERN  
See Maryland  
CENTRAL & SOUTHERN  
Unistrut Charleston,  
Div. of Jefferts Corp.  
(304) 755-8111

**WISCONSIN**  
EASTERN & CENTRAL  
Unistrut Wisconsin (414) 355-9470  
NORTHWESTERN See Minnesota

**WYOMING** (816) 421-4011  
CHEYENNE & CASPER AREA  
See Colorado



**UPHOLSTERED SEATING** / The "O-timo" group includes a 28-in.-wide armless chair, a 36-in.-wide chair with one arm, and a 44-in. two-arm chair (shown). There are also wedges for curvilinear configurations, an ottoman, and various sofas. Though appearing overscaled, the pieces are only 38-in. deep. The base is finished in scratch-resistant *Astro* acrylic, offered in seven colors. ■ Cy Mann Designs, Ltd., New York City.

*circle 316 on inquiry card*



**CEILING FAN** / Low-profile fan with globe light fixture leaves a clearance of 6-ft 7-in. on an eight-ft ceiling. ■ Comfort Conditioning Div., Robbins & Myers, Inc., Memphis, Tenn.

*circle 317 on inquiry card*



**SHOWER ENCLOSURE** / Aluminum "StikStall" enclosure uses less metal for trim side lines: the unit is erected around the glass. Doors are the adjustable pivot type, either framed or the newer frameless style. ■ Howmet Aluminum Corp., Terrell, Texas.

*circle 318 on inquiry card*

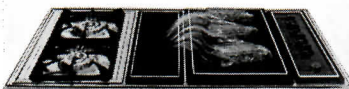

**DOWNDRAFT COOKTOP** / This self-ventilating gas unit needs no overhead exhaust hood, and can be positioned on an island, peninsula or counter. "The Gas Top" has interchangeable cooking cartridges including double burners, grille, griddle and rotisserie. All lift out easily for cleaning. ■ Modern Maid Co., Chattanooga, Tenn.

*circle 319 on inquiry card*



**CERAMIC TILE** / For such residential applications as countertops, bath, and light-duty floors and walls, new "Satinstones" 4 1/4-in.-sq tile has a gently undulated, rippled surface. This texture reflects light, particularly on wall installations. "Satinstones" are available in eight colors. ■ Huntington/Pacific Ceramics, Inc., Corona, Calif.

*circle 320 on inquiry card*

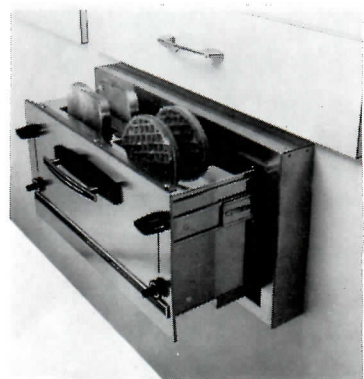

**BUILT-IN TOASTER** / Sized to fit easily between standard wall studs or above counter tops, this four-slice toaster extends from the wall housing for use. Each two-slice section has its own browning controls. Features include a slide-out crumb tray for easy cleaning. ■ Modern Maid Co., Chattanooga, Tenn.

*circle 321 on inquiry card*



**SOAKING TUB** / Made of fiberglass reinforced acrylic in any of 13 colors, the "Greek" 22-in.-deep tub provides soaking comfort and whirlpool massage in a compact, space-saving 48-in.-long unit. Features include integral armrests and spa controls placed on the tub itself; pillow is available as an option. "The Greek" is marketed at under \$1,000. ■ Kohler Co., Kohler, Wisc.

*circle 322 on inquiry card*

**Circle 50 on inquiry card**

# Homasote Easy-ply<sup>®</sup> Roof decking



## Looks Like Wood...

## ...But Insulates To R/35

- Decorative, "wood-like" vapor barrier on the ceiling side...where it belongs!
- Cover 16 square feet with each T&G Roof Deck panel...saves labor!
- Homasote Easy-ply<sup>®</sup> 2-3/8" Roof Decking provides an insulation value of R/6... TWICE the insulation value of a wood deck!
- Add 4" thick Thermasote<sup>®</sup> Nailbase Insulation over Roof Decking to increase the insulation value to R/35 PLUS!

**For FREE sample, use coupon.**

Send complete details     Send free sample.

Name \_\_\_\_\_

Company \_\_\_\_\_

Street Address \_\_\_\_\_

City \_\_\_\_\_ State \_\_\_\_\_ Zip \_\_\_\_\_

Call Me (    ) \_\_\_\_\_

EP/T    AR 82

**homasote** *Company* Box 7240, West Trenton, NJ 08628-0240  
ENERGY SAVING BUILDING PRODUCTS SINCE 1909 .

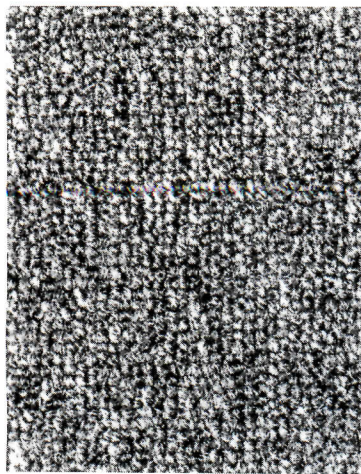

**HOMESPUN LOOK** / The "Donegal Collection" of contract carpeting from Wellco Carpet Corp. is manufactured from *Herculon* 5500-denier, six-ply multi-color yarn. Said to resemble Irish hand-crafted fabrics, the new product line includes "Donegal," shown here, an over-all home-spun look, as well as stripes and herringbone patterns. ■ Hercules, Inc., Wilmington, Delaware.

circle 323 on inquiry card



**VINYL VERTICALS** / Made of *Geon* vinyl, vertical blinds from Graber are available in 3- to 5-in. widths, and come in any length to fit any window. The louvers rotate 180 deg, adjusting to every angle for complete light, sun or view control. All louvers, when rotated, overlap not less than 3/8-in. Also offered are perforated vinyl louvers which permit a daytime view, reflect as much as 70 per cent of heat and glare, and maintain a level of opacity for privacy. ■ Graber Co., Middleton, Wisc.

circle 324 on inquiry card

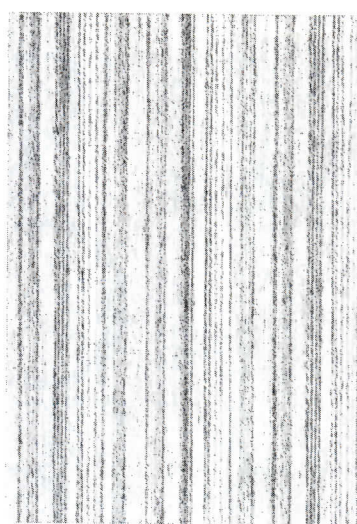

**WARP YARNS** / Paperbacked 27-in.-wide wallcoverings are available with over 60 different combinations of solid or striped warp yarns. Pictured here is "Santa Monica Free-way," a warm-toned blend of sand, apricot, seafoam and dusk yarns. These "Rhythms" wallcoverings coordinate with solid colored, acrylic-backed weaves for upholstery and walls. ■ Gilford Inc., New York City.

circle 325 on inquiry card



**SPIRAL STAIR** / An all-steel spiral stair is offered in a standard 4-ft diameter or in a 5-ft diameter package, both suitable for floor-to-floor heights up to 114-ft. All components are primed with all treads having an anti-skid factory-applied paint. The product has a steel handrail and may be used as a right-hand or left-hand stair. ■ American General Products, Inc., Ypsilanti, Mich.

circle 326 on inquiry card  
more products on page 139



## the plastic-domed ventilating skylight

Skylighting is the way to create beautiful light-filled rooms, to add new dimension and greater flexibility to interior and exterior designs.

VENTARAMA SKYLIGHTS OFFER MASSIVE SOLAR HEAT, NATURAL AIR CONDITIONING, and can be used in any climate on any roof.

COPPER FLASHED • SHATTER-PROOF • INSULATED DOME • SCREENING AND SUNSHADE • OPERABLE BY MANUAL, POLE, OR ELECTRIC MOTOR.

**VENTARAMA<sup>®</sup> SKYLIGHT CORP.**

5 Channel Drive, Port Washington, New York 11050 (516) 883-5000

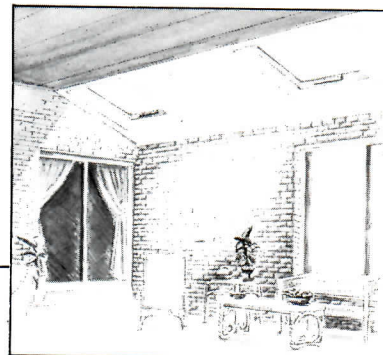
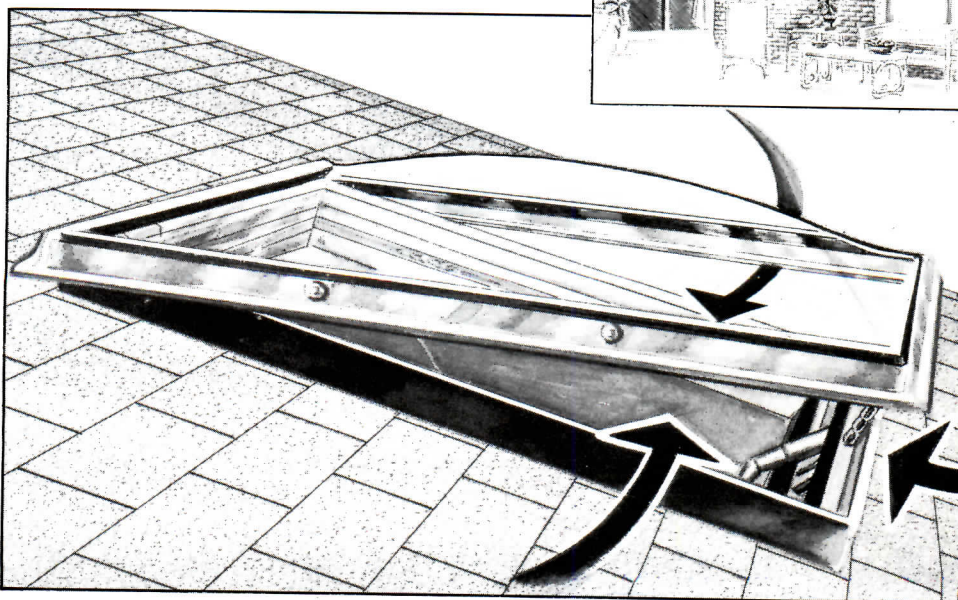

Circle 52 on inquiry card

# REPRINTS OF ARCHITECTURAL RECORD ARTICLES

You can order reprints of any articles that have appeared in Architectural Record, whether in color (if the article was published in color) or black-and-white (if published in black-and-white), in whatever quantities (minimum 100) you need, for use in your own mailings and presentations.

For more information, price quotes and help with layout and format of your reprints, call:

Carol Frances  
212/997-6081

ARCHITECTURAL RECORD



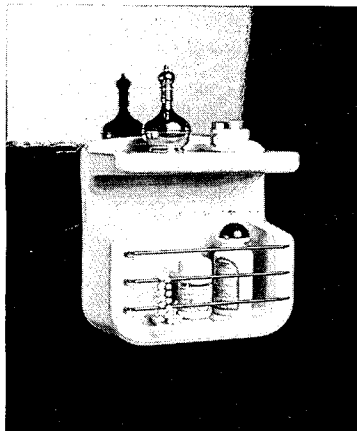

**SHELF / "Handy-Rack"** is an all-purpose shelf unit for the bath. It is 11-in. long by 6½-in. deep by 12½-in. high. Available in white or beige, it is chrome trimmed and claimed to be easy to install and maintain. ■ Allibert, Inc., Edison, New Jersey.

circle 327 on inquiry card



**WATERLESS TOILET** / This new toilet is a self-contained system that needs no water, chemicals, or plumbing hook-up for year-round use. All wastes are reduced to a small amount of safe, odorless compost material which is recommended as being good for lawns and gardens. The unit is approved by the National Sanitation Foundation. Design is of white glazed fiberglass or natural hardwood. Retail price is \$3970 for the system which accommodates a 5-member household, and includes compost tank, toilet and kitchen inlets, ventilation system, and all hardware. ■ Clivus Multrum USA, Inc., Cambridge, Mass.

circle 330 on inquiry card

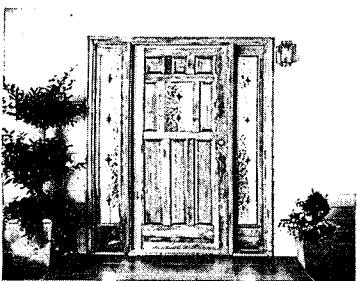

**GLASS DOORS** / The "Voyager Byzantine" line of ten leaded glass inserts are available for a variety of entry doors. The leaded glass comes in both beveled and stained forms, standard or insulated glass, and offered in standard lead finish trim or new bronze came (the latter has the look of antique gold). ■ E.A. Nord Co., Everett, Wash.

circle 328 on inquiry card



**CHAIR** / The Panta design from the Brayton International Collection can be tilted and locked into four different positions with fingertip control. The high-back lounge, the low-back and the ottoman all rest on five-arm bases. Each piece comes in a char brown finish. ■ Brayton International Collection, High Point, N.C.

circle 331 on inquiry card

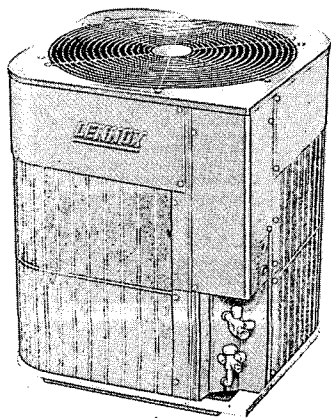

**AIR CONDITIONER** / The HS18 condensing unit is claimed to meet any efficiency standard in the U.S. The units are available in nominal sizes of 1.5, 2, 2.5 and 3 tons, representing cooling capacities from 15,500 to 36,800 Btuh. They are designed for ground level or rooftop installation. ■ Lennox Industries Inc., Dallas.

circle 329 on inquiry card

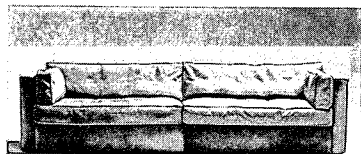

**COUCH** / Equipped with coil-spring support and covered in leather, the Mondial design from the Brayton International collection is available in one-, two-, and three-seat versions. ■ Brayton International Collection, High Point, N.C.

circle 332 on inquiry card

more products on page 140

**METTLE mica**  
a decorative laminating material

**SOLID EDGED**

GIVES YOU A

Nothing matches the quality, feel and look of solid metal. And, because METTLE MICA™ is anodized aluminum, it gives you a solid edge over foil laminates.

METTLE MICA is available in a variety of beautifully polished and brushed anodized finishes that are not flammable and won't chip or peel. METTLE MICA has no unsightly edge lines, won't pit or deteriorate and is impervious to water, alcohol and cigarettes. Although METTLE MICA is solid metal, it can be worked with standard woodworking tools, easily conforms to radius corners and can be applied with standard cements or adhesives.

Best of all, METTLE MICA gives you a competitive edge on price . . . it's one of the most economical laminating materials available. So get a solid edge by specifying METTLE MICA. Call or write for additional information, samples and the name of your local distributor.

created and produced by

the **october** co., inc.

1	2	3	4	5	6	7
8	9	10	11	12	13	14
15	16	17	18	19	20	21
22	23	24	25	26	27	28
29	30	31				

easthampton, massachusetts, 01027  
area code 413 527-9380

Consult our file in Sweet's 9.12 / 0c

Circle 53 on inquiry card

# IRON-A-WAY

## Built-In Ironing Centers

Specified by architects  
World-wide for new  
construction and remodeling.

46" ventilated steel board  
supported by telescoping  
steel rods.

Steam iron  
insulated  
compartment.  
Folding sleeveboard.  
Work area light.  
Electric control panel.  
Neatly folds away. Safety  
door switch turns off power.  
Recesses between studs or  
mounts on surface.

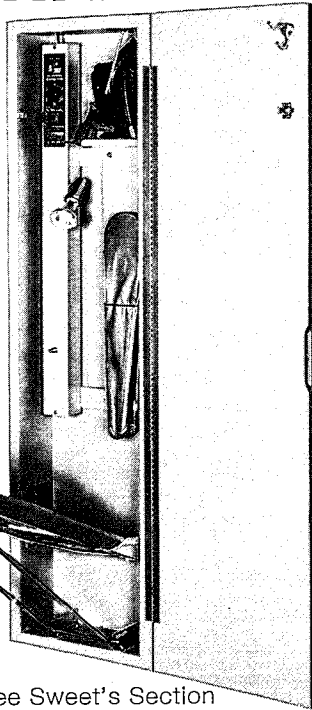

—For more information, see Sweet's Section  
— 11.27a/Iro, or

Contact the Contract Sales Division of  
**IRON-A-WAY, INC.**  
220 West Jackson • Morton, IL 61550 • (309) 266-7232



Circle 54 on inquiry card

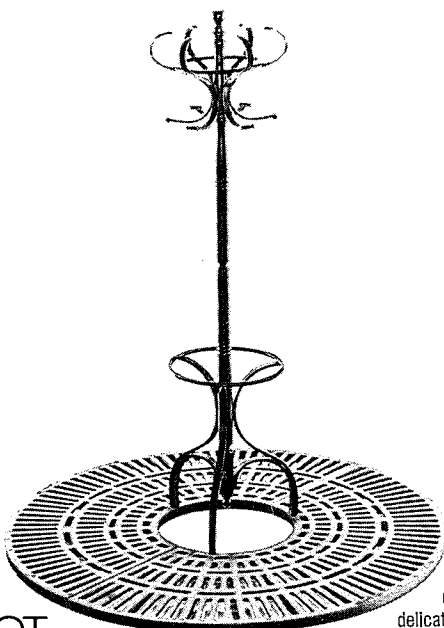

**NOT  
ALL TREES  
NEED OUR  
TREE GRATES!**

Our tree grates are specifically designed to protect the delicate root systems of living trees while at the same time allowing moisture and fertilizers to reach the necessary areas. We offer over 65 geometric design opportunities for use in malls, sidewalks, parks and shopping areas to fit into your plans. Or, we will work with you to custom design according to your specifications.

**NEENAH**   
FOUNDRY COMPANY  
Box 729, Neenah, WI 54956 (414) 725-7000

Write Dept. L for our Cat. R.. 8th Ed.



Circle 56 on inquiry card

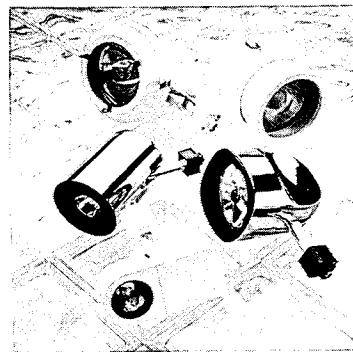

**LAMP HOLDERS** / Four low-voltage lamp holders substantially smaller than previous models are used in conjunction with low-voltage lamps which are claimed to be more efficient and economical and provide a white light that affords the most precise color rendition. The lamps feature built-in reflectors with a special dichoric coating. ■ McGraw-Edison Co., Elk Grove Village, Ill.

circle 333 on inquiry card

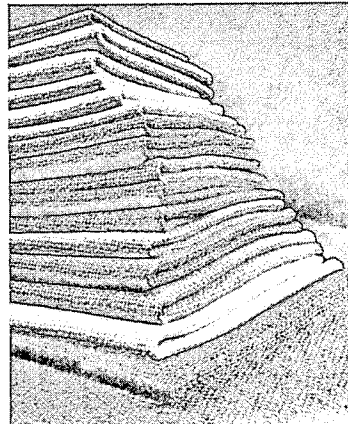

**FABRIC** / Wool-Lon is a blend of 55 percent wool and 45 percent nylon. According to the manufacturer, this fabric retains the softness and the inherent fire retardant properties of wool, while eliminating pilling and excess sheen, the weaknesses of nylon. Nylon adds strength for a heavy duty wear rating. ■ Unika-Vaev USA, a div. of ICF, Inc., New York City.

circle 334 on inquiry card

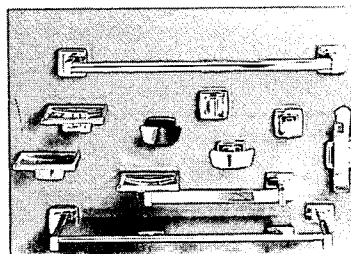

**BATH ACCESSORIES** / This new line of bath accessories incorporates a grab bar and snap-lock mounting system. All *Field-Safe* products fasten directly to the wall, eliminating the need for set screws. Finishes are soft satin, highly polished or Bronzestone stainless steel or brass. ■ Tubular Specialties Manufacturing, Inc., Los Angeles Calif.

circle 335 on inquiry card

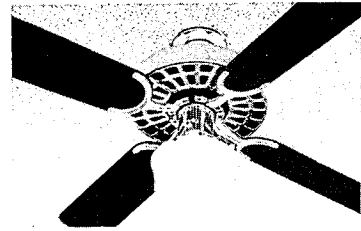

**FANS** / The "Island Fan," available in 12 styling combinations, features natural-finish wood blades and genuine cane inserts together with operating features which include reversible blade movement and an optional variable speed control. The fan is adaptable for mounting on vaulted or unusually high ceilings. Optional extension tubes in 12-in., 18-in., 24-in., and 36-in. lengths are available. ■ Island Fan Co., Grand Rapids, Mich.

circle 336 on inquiry card

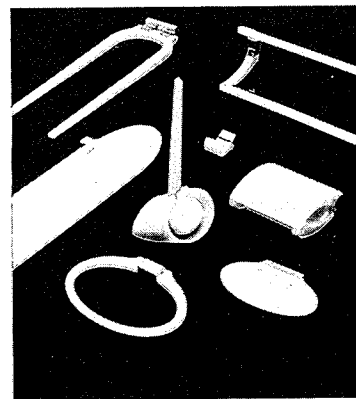

**BATH ACCESSORIES** / A selection of accessories includes: *Ovaline*, in cream or blue made of opaque French acrylic; and *Marbine*, in alabaster, cream, and sea-green, also made of French acrylic. This manufacturer has a complete line of medicine cabinets, both lighted and unlighted, with space-saving and safety features. ■ Allibert, Inc., Edison, N.J.

circle 337 on inquiry card

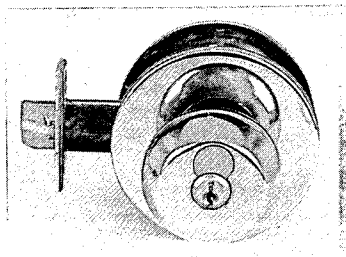

**REMOVABLE CYLINDERS** / Removable-core cylinders, that make it possible to re-establish security in a short time after a key is lost, are now available in an expanded range of products from this manufacturer. When these cylinders are used, a master control key allows the core to be removed and replaced. ■ Corbin Division, Emhart Hardware Group, Berlin, Conn.

circle 338 on inquiry card

more products on page 143

# REDWOOD

## NOW THERE ARE THREE QUALITY GRADES

You now have a wider choice of top quality redwood grades for your next project.

As always, you can depend upon the beauty and durability of Clear All Heart and Clear redwood. But now, for the first time, you can choose new B-Grade, textured with limited knots and streaks of creamy sapwood.

B-Grade, available kiln dried, offers the performance values of the clear grades. It insulates against heat, cold and noise. It resists flame spread. It holds finishes better than other woods and remains smooth, tight and uniform for lasting beauty and endurance.

New B-Grade—now, one more way to offer the beauty and performance of quality redwood.

 California Redwood Association One Lombard Street, San Francisco, California 94111

*Write for our Redwood Exterior/Interior Guide.*

**Circle 57 on inquiry card**

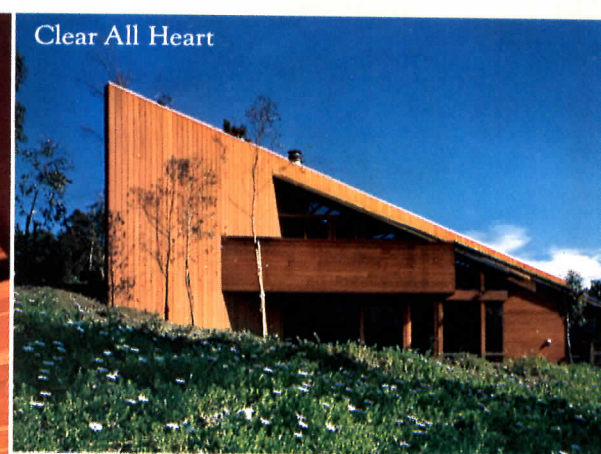

# THE EARTHEN FLOOR.



Put nature on your floor with Carolina Colony Quarry Pavers. Warmth and color made from the good earth of North Carolina. **MID-STATE TILE COMPANY**

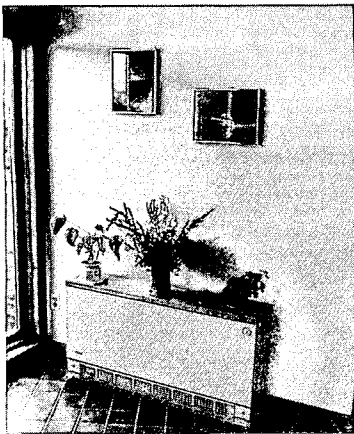

**STORAGE HEATER** / Developed in Germany, the *Stiebel Eltron* electric storage heater uses economical off-peak electricity to heat a core of ceramic bricks. Heat is stored until the room thermostat activates a small fan, providing a comfortable temperature 24 hours a day. ■ *Stiebel Eltron* N.A., Boston, Mass.

circle 339 on inquiry card



**WOOD WINDOW** / Newly designed weather-stripping of vinyl-wrapped foam has substantially reduced the air infiltration allowed by Pella's traditional-style double-hung window. The "TD" window features a double-glass insulation system; options include triple glazing, *Slimshade* blinds, and *Solarcool* bronze glass. ■ *Rolscreen Co.*, Pella, Iowa.

circle 340 on inquiry card

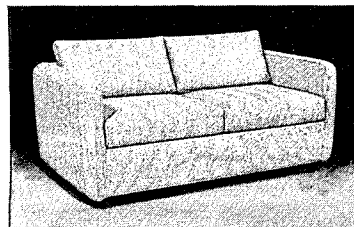

**LOUNGE GROUP** / Two contract seating lines from Chesapeake are comprised of 30 pieces developed and selected by a six-member committee of nationally-recognized designers. The loveseat shown here is also available as a chair, sofa or sleep-sofa, upholstered in Maharam fabric as well as COM. ■ *Chesapeake Mfg. Co., Inc.*, Baltimore, Md.

circle 416 on inquiry card

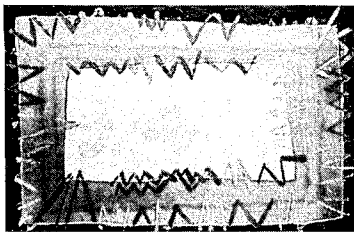

**FLOOR CANVAS** / One of a series of bright, hand-painted designs by Florida artist Ann Sams, "Navaho" may be custom colored in any size up to 12- by 15-ft. This stylized Indian motif is done in colorfast paints on heavy white cotton canvas with a strong latex backing. Coordinating fabric is also hand-painted, using a lighter-weight, 50-in.-wide cotton material. ■ *Form III*, North Vernon, Ind.

circle 417 on inquiry card

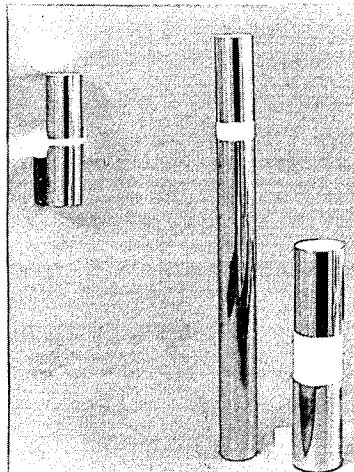

**TOUCH LAMPS** / Floor, wall and table versions of the "Sabra" lamp are shown here. Each has a 4½-in. diameter metal cylinder, which opens up to 10 in. to expose the diffused illumination from a 150-Watt bulb. Floor and table models are touch-activated to produce three levels of light from the standard one-way bulb. ■ *Koch + Lowy, Inc.*, Long Island City, N.Y.

circle 418 on inquiry card



**WALLCOVERING** / The *Flexi-Wall* System of wallcovering has properties claimed to be appropriate for passive solar energy use. When used with patented adhesive, the material is capable of transferring heat from the surface to the interior mass for storage and return the heat to the space at night. ■ *Flexi-Wall Systems*, Liberty, South Carolina.

circle 419 on inquiry card  
more products on page 144

## DISTINCTIVE WOOD FIXTURE low level illumination in a new light

"The Junior Jefferson" is a versatile fixture designed to enhance patios, walkways and other low level lighting sites. It is laminated of custom selected, kiln dried *Western Red Cedar* and harmonizes with any surroundings. Fastidious workmanship follows a tradition of more than 50 years. A wide selection of globes for incandescent to 100w is available. Direct burial or wall mounted.

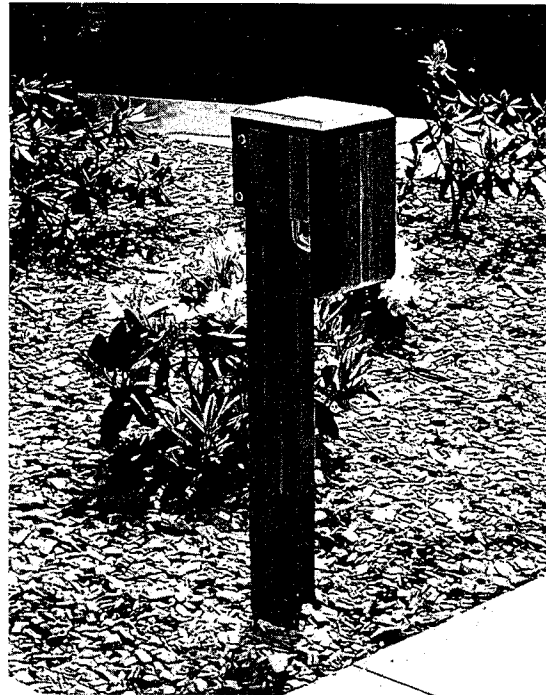

Circle 59 on inquiry card

Write on your letterhead for catalog of wood lighting standards and accessories.

**Ryther-Purdy**  
Lumber Company,  
Inc.

205 Elm Street  
P.O. Box 622  
Old Saybrook, CT 06475  
Phone (203) 388-4405

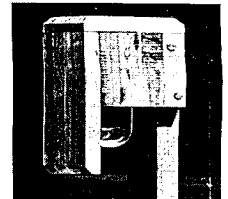
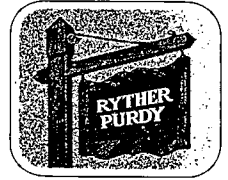

GARRISON ON HUDSON  
NEW YORK 10524  
914 424 3327

# WATERCOLORS

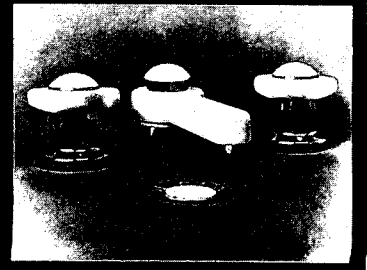
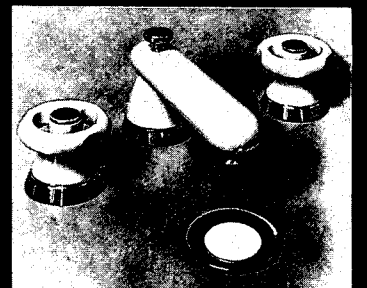

Circle 60 on inquiry card



## WORLD'S LARGEST DOOR CATALOG

New from the Northwest. Over 1,000 quality architectural millwork products packed in a unique 68-page full color catalog. By the Nord Company, est. 1924. They make them the way they used to.

Columns; Porch Posts. Of special note: leaded glass and laser carved doors. All here (and available locally). Please contact your local Nord distributor to order your catalog.

Or send a \$1.25 check or money order to E.A. Nord Co., PO 1187, Everett WA 98206.



Circle 61 on inquiry card

## We can help take the heat off...

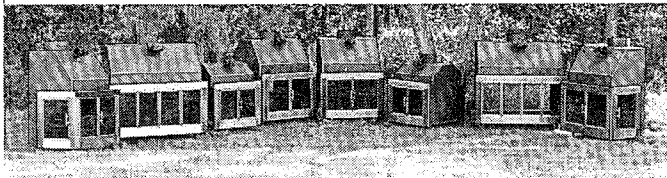

In this day and age you want a fireplace that heats like a furnace. Efficiency is the whole basis for the TIMBERLAND FIREPLACE FURNACE. Engineering ideas that work, to save energy, to produce more heat. The TIMBERLAND uses fresh outside air, through a thermostat for combustion and produces heat by natural convection of air.

Available in a size and style to meet your needs. Singles, doubles and corner models. Contact your local TIMBERLAND dealer. He will show you how the TIMBERLAND FIREPLACE FURNACE can take the heat off your heating bills. Or contact: Messer Machine & Mfg., Inc.

## your heating bills!

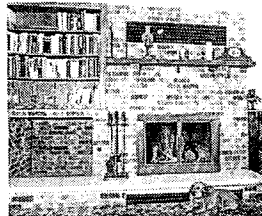

**TIMBERLAND FIREPLACE FURNACE**

**Messer Machine & Mfg. Inc.**

Hwy. 60-71 North  
Windom, MN 56101  
PHONE: (607) 831-1904

Dept. 3

Circle 62 on inquiry card

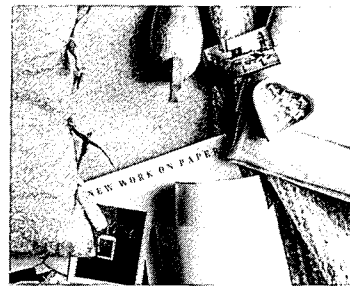

**WALLCOVERINGS** / The 115 designs in the "City Dimensionals" wall-covering collection feature raised textures in tweed, polka dot, herringbone and tattersall patterns. Over 50 coordinating fabrics, both woven and printed, are also part of the "City Dimensionals" line. ■ Imperial Wallcoverings, Collins & Aikman, New York City.

circle 420 on inquiry card

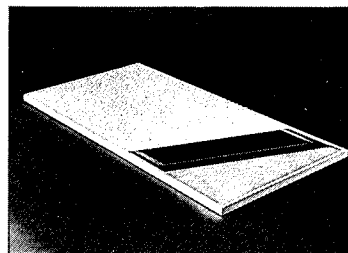

**RADIANT HEATING PANELS** / This cutaway view of the *Energy-Kote* radiant heating panel shows its textured, flameproof surface coating, graphite copper heating element, bonding adhesive and fiberglass insulation board. System comes complete with junction box and thermostat. The infrared energy generated by the *Energy-Kote* panel can bring room temperatures up to comfort level within five minutes, with energy savings over hot air systems said to be as much as 50 per cent. ■ TVI Energy Corp., New Canaan, Conn.

circle 421 on inquiry card



**MARBELIZED CHINA** / Kohler's permanent decal process simulates the look of marble on vitreous china, as shown here on the "Rialto" toilet. Especially suitable for powder rooms, the marbelized china is also available on the "Chablis" pedestal lavatory and the "Caxton" countertop lavatory. ■ Kohler Co., Kohler, Wisc.

circle 422 on inquiry card

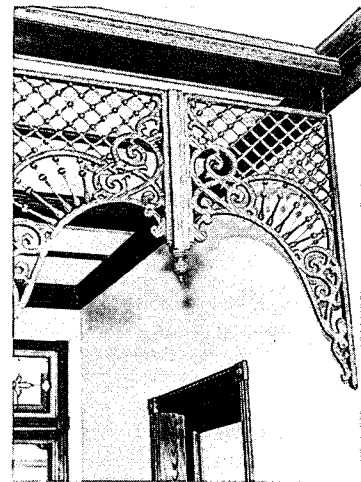

**HALLWAY MEDALLIONS** / A recent addition to this maker's line of Victorian-style millwork, solid oak or poplar gingerbread medallions may be used in hallways or entrances. Here, two medallions are joined with a turned post, forming a completed unit 46-in. wide, with a 40-in. side drop and a 26 3/4-in. center drop. This installation retails for \$220.50, including shipping. ■ Cumberland Woodcraft Co., Inc., Carlisle, Pa.

circle 423 on inquiry card

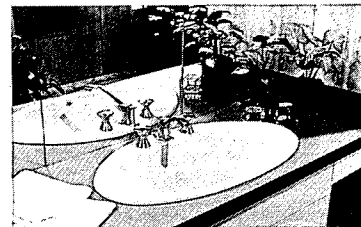

**LAVATORY** / An oval lavatory, the *Ellipse*, measures 33- by 19-in. and is crafted in enameled cast iron. A self-rimming lavatory designed for easy installation, it can be used with this manufacturer's *Alterna*, *Bravura*, or *Flair* faucets with swing spouts to cover the large basin area. ■ Kohler Co., Kohler, Wisc.

circle 424 on inquiry card

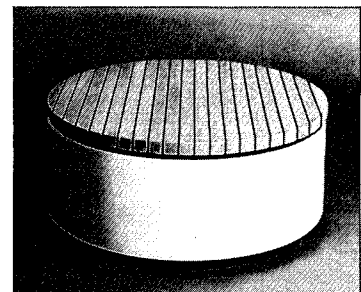

**BENCHES** / Fiberglass and wood benches are available in either round or square, and range from 24-in. to 60-in. diameter or square. The base designed in fiberglass, is available in all of this manufacturer's standard colors plus any custom color at an additional charge. Wood tops are clear, unfinished redwood or oak with a satin lacquer finish. ■ Pouliot Designs Corp., Shakopee, Minn.

circle 425 on inquiry card  
more products on page 147

# Weathering for sale . . .



Long Island Home, Architect: Jay Lockett Sears, Quogue, Long Island; Wood surfaces treated with Cabot's #0241 Bleaching Oil for the weathered "driftwood" look.

## Wood and Cabot's Stains...made for each other

# Cabot's STAINS



Here is a wood at its wonderful best. The architect, in specifying a finish for this home, sought beauty and more...a finish that would stand up to summer sun and winter cold, that would require minimum maintenance while protecting the wood for a long, trouble-free life. His choice: Cabot's Stains.

Cabot's Stains, in 87 unique colors, enhance the wood grain, grow old gracefully, never crack, peel, or blister...are ideal for shingles, siding, clapboards, paneling, and decking. In terms of natural beauty, economy, and ease of application, Cabot's Stains

are best for all types of wood, exterior or interior, and all wood surfaces, smooth, striated, or rough-sawn.

Cabot's patented colloidal manufacturing process assures exacting standards of color, deep penetration, and wood preservation. In a world that is constantly shouting "new," Cabot's Stains are very proud to be "old, the original, and still the best."

For color cards and information, write:

**Samuel Cabot Inc.**

One Union St., Dept. 529, Boston, Massachusetts 02108

**"Cabot's Stains, the Original Stains and Standard for the Nation since 1877"**

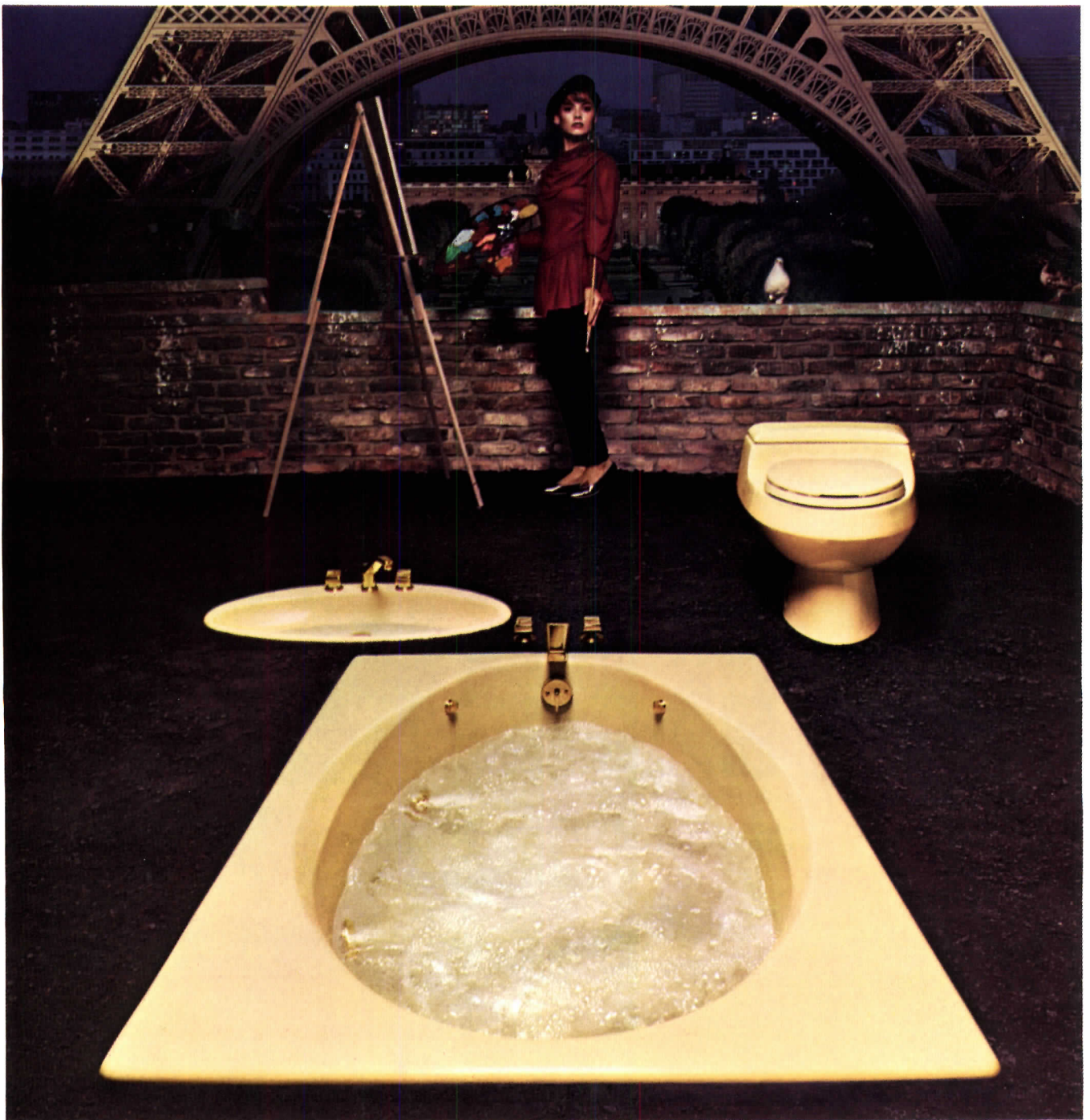

## FRENCH VANILLA... "MAGNIFIQUE."

Leave it to the French to take something as simple as vanilla and give it spice. Make it richer, creamier and tastier than it's been before.

Leave it to Kohler to bring it to the bath.

French Vanilla. Kohler's newest

color leaves your decorating palette wide open because it blends so beautifully with any shade; yet stands by itself with a flavor uniquely its own. Exhibited here on the new Pristine™ Bath/Whirlpool, Ellipse™ lavatory and Rialto Water-Guard®

toilet. Just a small part of the gallery of bath and powder room fixtures Kohler has created in French Vanilla.

For more information about this and all the Kohler products, write Kohler Company, Department RA5, Kohler, Wisconsin 53044.

THE BOLD LOOK  
OF **KOHLER**

Circle 64 on inquiry card

Copyright 1982 Kohler Co.



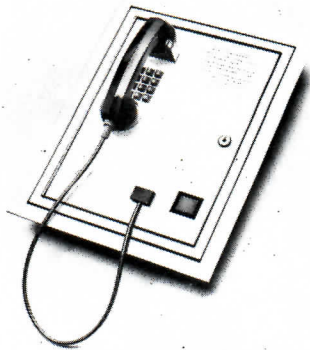

**SECURITY PHONE** / The "Fed-Fone" security system operates over existing telephone lines with standard telephone components. Designed for touchtone or dial-pulse operation, it may be used for any industrial, commercial or residential security application. A 3-digit call code ensures that the user does not have access to the 7-digit phone number of anyone in the system. ■ Federal Signal Corp., Hinsdale, Ill.

*circle 426 on inquiry card*

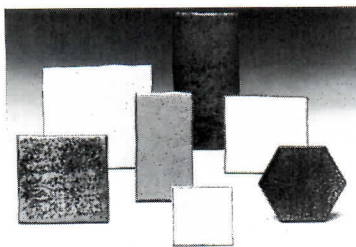

**WALL AND FLOOR TILE** / Five new colors—old gold, country gray, saddle, caramel and sand beige—have been added to the *Summitville* line of ceramic tile for kitchen and bath walls and counter tops. These colors, and 10 others, are also available in *Summitstone* 1/4-in.-thick floor tile, shown here. ■ Summitville Tiles Inc., Summitville, Ohio.

*circle 429 on inquiry card*

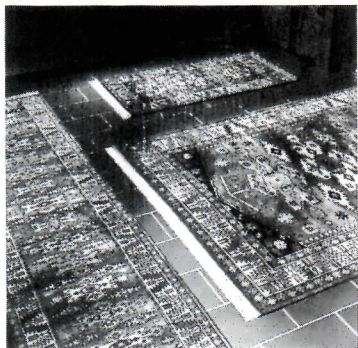

**ORIENTAL DESIGN** / Axminster woven in Holland, all-wool "Larenstan Collection" area rugs are authentic re-creations of Kuba and Shiraz designs. The bold patterns and mellow colorations are said to be particularly suitable to Early American and Primitive decorating themes. The full size and pattern range is available in stock. ■ Couristan, Inc., New York City.

*circle 430 on inquiry card*



**LINEN WALL COVERING** / Yarns of varied thicknesses are laminated to paper to create a linen blend warp-lay wallcovering which is imported from Belgium. The pattern shown is 97 percent linen and 3 percent rayon and is available in 24-in. widths in multiples of 12 yards. ■ International Linen Promotion Commission, New York City.

*circle 431 on inquiry card*

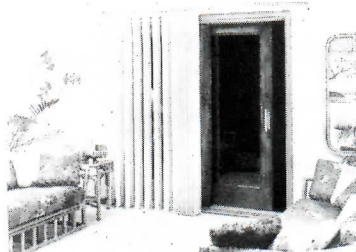

**DRAPES** / This vertical blind adjusts in both length and width to fit almost any window. The *Vertical Drape* headrail is adjustable and comes in four standard widths, and is available in white, antique brass or pecan finishes. The 5-in.-wide louver panels can be adjusted to any angle and come in three textured fabrics. ■ The Graber Co., Middleton, Wisc.

*circle 427 on inquiry card*



**SIDING** / Forestex "6-12," a 1/2-in. lap siding, is designed to give buildings a traditional narrow lap siding look, while cutting waste and application time. A self-aligning feature is claimed to cut application time by 30 percent. The product is available pre-primed with a smooth, or a rough-sawn cedar finish. ■ Forest Fiber Products Co., Forest Grove, Ore.

*circle 428 on inquiry card*

*more products on page 149*

## When keys create problems they were meant to solve . . .

# specify **SIMPLEX** Access Control Systems

Security is breached the moment keys are lost, stolen or copied. Pushbutton combination access controls eliminate keys. Fully mechanical, they use no electricity, no trouble-prone electronics. Thousands of combination possibilities are developed by sequential and/or simultaneous use of up to five buttons. Yet combinations are easily changed in less than a minute. Attractive, easily installed, very affordable **SIMPLEX SYSTEMS** are fully described in SWEETS File No. 8.30/SI, or write for catalog AR-582.

## **SIMPLEX** SECURITY SYSTEMS, INC.

P.O. Box 377, 66 Front St.  
Collinsville, CT 06022;  
203-693-8391

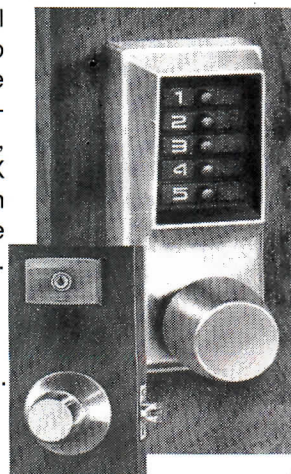

*Circle 65 on inquiry card*

## **VICTORIAN MILLWORK**

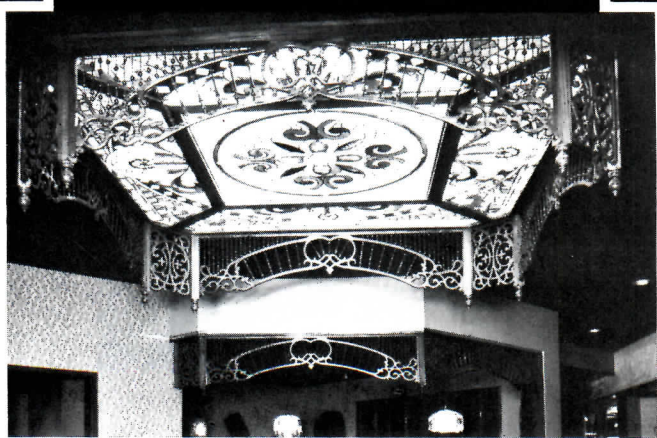

Replicas of 19th century originals in kiln dried, premium grade *solid Oak* or Poplar. Our expanded line includes designs for all interior and exterior applications: rails and balustrades, brackets, corbels, posts, grilles, fretwork, and much, much more!

- Precision manufactured so that product groups are compatible with each other for total design unity.
- Unlimited quantities for total design freedom.
- Factory direct affordable pricing.
- Custom millwork available for unusual requirements.

Send \$3.50 for full color, 24-page product and design idea catalog

**Glumberland Woodcraft Co. INC.**

2500 Walnut Bottom Road  
Carlisle, PA 17013 (717) 243-0063  
Dept. 67

*Circle 66 on inquiry card*

# Subtle strength . . .

## New! Medallion 82 Collection by Library Bureau

Now Library Bureau introduces the new Medallion 82 Collection.

Strong yet graceful, its fluid lines and rich mellow tones enhance the environment you create. Carefully molded radius corners are perfectly joined for precise balance and lasting beauty.

The collection features finely rounded aprons to protect chair arms,

and striking reveal accent strips. This full complement of related library furnishings is available in a number of dimensions and configurations to conform to your most demanding design specifications.

Choose handsome red oak in a wide variety of finishes. For increased durability, specify our high pressure laminate in matching wood patterns or

complementary solid colors.

Make the subtle strength of the new Medallion 82 Collection part of your design concept today.

Write Library Bureau, Inc., 801 Park Avenue, Herkimer, N.Y. 13350 for the name of the distributor nearest you. Or call (315) 866-1330.

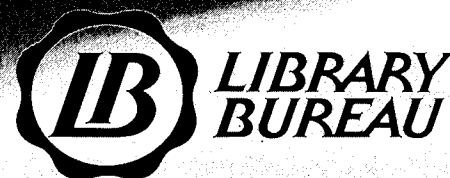
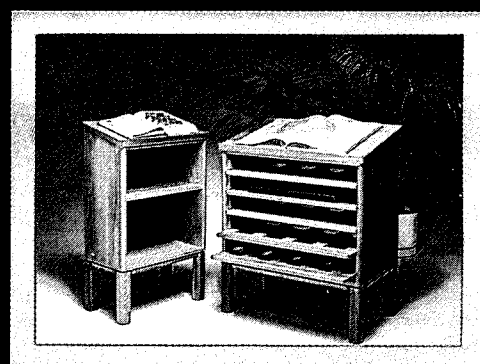
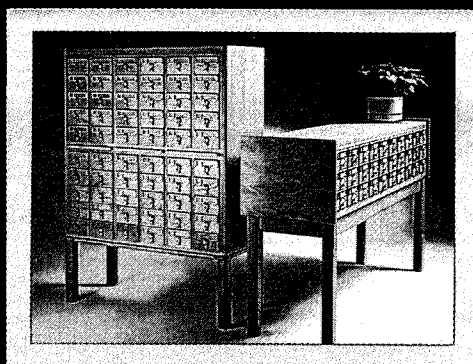
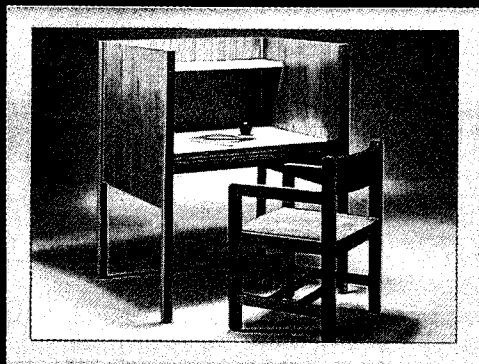

Makers of Fine Library Furniture for Over 100 Years.

# Tests prove Tyvek® Housewrap cuts heat loss through walls by 33%.



**WOOD BEAMS** / Hollow three-piece rustic beams are made of knotty white pine with a glued joint. No nails are used. Beams are available in a variety of sizes, profiles and styles for applications on ceilings or walls in both existing and new construction. ■ Rusticated Beams, Inc., West Warwick, R.I.

*circle 432 on inquiry card*



**COUNTER STOOL** / A comfortable stool constructed with a solid beech frame, the "Concetta" stool comes in bar and counter versions, 40- and 34-in. high, respectively. Seat options include vinyl rush, cane or wood, or upholstered. ■ Loewenstein, Inc., Fort Lauderdale, Fla.

*circle 433 on inquiry card*



**LOVE SEAT** / Measuring 52-in. wide by 29-in. high, the "Patricia" love seat is suitable for small reception and lounge areas. It is constructed with a hardwood frame, fully upholstered, with a tight seat and attached edge back cushions. ■ Loewenstein, Fort Lauderdale, Fla.

*circle 434 on inquiry card*



- TYVEK\* stops cold air infiltration—cuts heat loss through walls 33%. Independent tests prove it:\*\* BOCA Report 79-34 confirms it.
- Keeps cold air out of wall cavity, protecting insulation R-value.
- Moisture permeable—no danger of in-wall condensation.
- Costs about \$150 for average house.

\*Du Pont registered trademark.

\*\*Independent laboratory tests using 2x4 frame wall with 3½" R-11 insulation in 15 mph wind.



REG. U.S. PAT. & TM. OFF.  
**Circle 69 on inquiry card**

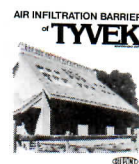

## FREE FACTS

Call (302) 999-2474. Or send coupon to Du Pont Company, Room C-11K4-A, Wilmington, DE 19898

Name \_\_\_\_\_

Title \_\_\_\_\_

Company Name \_\_\_\_\_

Address \_\_\_\_\_

City \_\_\_\_\_ State \_\_\_\_\_ Zip \_\_\_\_\_

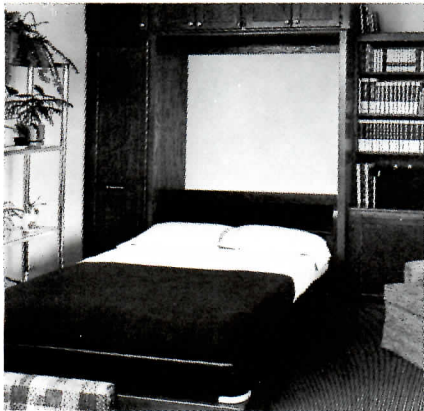

## Make the space you have into the room you need.

The SICO® Room Maker™ wall bed system opens up more usable space in the family room, den, bedroom or efficiency apartment. By day, it's a custom-designed wall system with plenty of storage. At night, a gentle pull reveals a comfortable bed in twin, full or queen size.

One smart idea is to have us install the Room Maker system away from the wall, making room behind for private dressing, storage, an office, whatever. The unit is only 18" deep, and it qualifies as part of a mortgage.

For information on the wide range of SICO Room Maker beds, walls and tables we can design and install, and for the name of your local distributor, write or phone:

**SICO INCORPORATED**  
Room Makers Division  
7525 Cahill Road, P.O. Box 1169  
Minneapolis, MN 55440, Dept. AR-5  
Phone (612) 941-1700, Ext. 118  
TWX EDNA-910-576-1771



**Circle 68 on inquiry card**

# THE CHAIRMAN OF CONSOLIDATED FOODS CORPORATION **URGES YOU TO LEAD YOUR EMPLOYEES TOWARD A SECURE FUTURE...BY ADVOCATING THRIFT THROUGH THE PURCHASE OF U.S. SAVINGS BONDS.**



**John H. Bryan, Jr.**  
Chairman of the Board,  
Chief Executive Officer  
Consolidated Foods  
Corporation

As National Chairman of the U.S. Industrial Payroll Savings Committee for U.S. Savings Bonds, he asks you to recommend the Payroll Savings Plan to your employees. Mr. Bryan believes that:

"Old-fashioned thrift and consistent saving ways have tended to be overlooked in recent years. Happily though, our country is once again swinging back to the values that made it great. The self-reliant American spirit that allowed individuals to build financial independence is re-emerging. I suggest that you add your company's support to this heartening trend by helping your people toward a secure future with their own U.S. Savings Bonds programs.

"When your company becomes part of the Payroll Savings Plan, you offer your employees a fringe benefit that costs very little, and offers a great deal. Savings Bonds rates are higher, and more attractive than ever. You'll also provide the U.S. Treasury with the least inflationary way to fund government programs. We know that we must all work together to bring inflation under control.

"Lend me your hand by offering your employees an opportunity to practice thrift and savings. It's a program that has proven its worth for over forty years—the regular purchase of U.S. Savings Bonds through the Payroll Savings Plan. Now is the right time for you to lead."

For an action kit on how to implement this program, write John H. Bryan, Jr., Chairman and Chief Executive Officer, Consolidated Foods Corporation, Three First National Plaza, Chicago, Illinois 60602

**Take  
stock  
in America.**



**Ad Council** A public service of this publication and the Advertising Council.

## 1982 U.S. INDUSTRIAL PAYROLL SAVINGS COMMITTEE

### National Chairman

**John H. Bryan, Jr.**  
Chairman of the Board and CEO  
Consolidated Foods Corporation

### Members

**Fred T. Allen**  
Pitney Bowes Inc.

**Robert Anderson**  
Rockwell International Corporation

**The Honorable Richard Arrington, Jr.**  
Mayor of Birmingham

**James F. Beré**  
Borg-Warner Corporation

**Harry J. Bolwell**  
Midland-Ross Corporation

**Dennis J. Carney**  
Wheeling Pittsburgh Steel Corporation

**Robert E. Davis**  
Thikol Corporation

**Patrick A. Deo**  
Grand Union Company

**John W. Dixon**  
E-Systems, Inc.

**Paul H. Ellicker**  
SCM Corporation

**Thomas J. Feehan**  
Brown & Root, Inc.

**Richard J. Ferris**  
United Airlines, Inc.

**Joseph B. Flavin**  
The Singer Company

**W. A. Franke**  
Southwest Forest Industries

**Alan C. Furth**  
Southern Pacific Company

**Robert W. Galvin**  
Motorola, Inc.

**William R. Gould**  
Southern California Edison Company

**Hermann J. M. Haerri**  
Consolidated Aluminum Corporation

**Robert P. Henderson**  
Itek Corporation

**Paul H. Henson**  
United Telecommunications, Inc.

**Harry Holiday, Jr.**  
Armco Inc.

**The Honorable Fob James**  
Governor of Alabama

**F. Ross Johnson**  
Nabisco Brands, Inc.

**J. C. Kenefick**  
Union Pacific Railroad Company

**James R. Kerr**  
Avco Corporation

**J. L. Ketelsen**  
Tenneco Inc.

**William A. Klopman**  
Burlington Industries, Inc.

**Laurence C. Leeds, Jr.**  
Manhattan Industries, Inc.

**Richard B. Madden**  
Potlatch Corporation

**Richard J. Mahoney**  
Monsanto Company

**Rocco J. Marano**  
New Jersey Bell Telephone Company

**Walter J. McCarthy, Jr.**  
The Detroit Edison Company

**John F. McGillicuddy**  
Manufacturers Hanover Corporation

**Paul A. Mongerson**  
Stanadyne, Inc.

**John D. Ong**  
The B. F. Goodrich Company

**Robert B. Ormsby**  
Lockheed-Georgia Company

**Charles R. Pierce**  
Long Island Lighting Co.

**Charles M. Pigott**  
PACCAR, Inc.

**Robert P. Reuss**  
Central Telephone & Utilities Corporation

**John B. Ricker, Jr.**  
The Continental Corporation

**Robert M. Schaeberle**  
Nabisco Brands, Inc.

**Robert A. Schoellhorn**  
Abbott Laboratories

**Maurice Segall**  
Zayre Corp.

**Roger B. Smith**  
General Motors Corporation

**Merrett R. Stierheim**  
Metropolitan Dade County Manager

**William G. Stocks**  
The Peavey Company

**William B. Stokely, III**  
Stokely-Van Camp, Inc.

**Irving I. Stone**  
American Greetings Corporation

**Robert K. Timothy**  
Mountain Bell Telephone Co.

**John M. Toups**  
Planning Research Corporation

**E. D. Walker**  
University of Texas System

**John A. Winfield**  
Brockway Glass Co.

# INNOVATIVE, DECORATIVE, ENERGY EFFICIENT LIGHTING PRODUCTS FOR THE 80's

**Neolight Tubes** stimulating, interesting shapes to play with . . . streaking straight or running free, signage, display, advertising.

**Straight & Narrow Series 80** crisp clean 6" wide lighting elements that clearly define an interior space . . . Many applications for versatile custom-like installations.

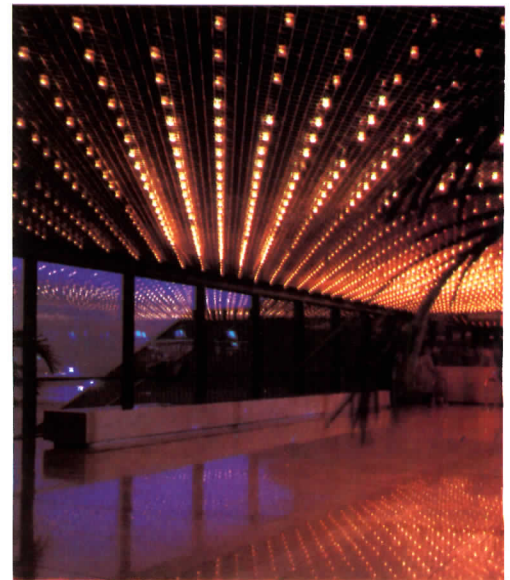

**Myriads** sparkling lamps meet under cover of tastefully designed modules and emerge as gleaming enraptured light.

**Neolight Curtains** ignite the night . . . with low energy, super soaking seeing light. Draw curtains, divider curtains, custom designs.

**Bold Cel** precise cells of perfect proportion are incised between bold lines flowing in an unbroken sweep.

There's a new, exciting, lively, informative, clear, concise, indispensable 36 page **1982 Designers Portfolio** you're sure to appreciate. Stunning lighting products and prices that range across the full spectrum of low energy, long life lighting techniques allowing you to keep a sharp edge on your creativity. Send for for it . . . it's grand!

**NEO-RAY PRODUCTS INC.** 537 Johnson Avenue; Brooklyn, New York 11237 (212) 456-7400

**neoray**  
NATURALLY

# ADVERTISING INDEX

**A**

Allied Corporation ..... 46-47

G Amarlite Products Div. of  
Anaconda ..... 42-43

American Gas Association ..... 9

L American Standard Inc. .... 11

Amsterdam Corp. .... 16A-16C

G-L Andersen Corp. .... 4-5

Architectural Complements ..... 8

G-I-L-D Armstrong ..... Cov II

D Atlantic Stairworks ..... 6

**B**

Blandin Wood Products Co. .... 154

Brown, Shep, Inc. .... 153

Burlington/Lees ..... 27

**C**

G-L Cabot, Samuel, Inc. .... 145

California Redwood Association. ...  
141

G Cervitor Kitchens, Inc. .... 32-2

Cumberland Woodcraft Co. .... 147

**D**

Delta Faucet Co. .... 7

DesignTex ..... 10

G Dryvit Systems, Inc. .... 28-29

D Dupont Co.-TYVEK Housewrap ....  
149

**E**

G-E Elkay Mfg. Company ..... 48

**G**

Grohe America, Inc. .... 33

**H**

G-L Homasote Co. .... 136

Hurd Millwork Co. .... 121-122

**I**

Inryco, Inc. .... 38-39

G International American Ceramics,  
Inc. .... 40

International Contract Furnishings,  
Inc. (ICF) ..... 36-37

International Tile & Supply Corp. ...  
32-1

International Wood Products .. 32-2

G-L Iron-A-Way, Inc. .... 140

Iron-Craft, Inc. .... 32-2

**J**

G Jason Industrial, Inc.-Pirelli Rubber  
Flooring ..... 45

**K**

G-D Kentucky Wood Floors, Inc. .... 131

Koch & Lowy ..... 14

Koh-I-Noor Rapidograph, Inc. ....  
24-25

E Kohler Co. .... 146

Kroin ..... 8

Knoll International ..... 12-13

**L**

G Levolor Lorentzen, Inc. .... 17

G Library Bureau ..... 148

**M**

Manville International Corp.-  
International Div. .... 32A

D Marathon Carey-McFall Co. .... 41

Marvin Windows ..... 30-31

G-D-L Masonite Corp.-Central Hardboard  
Div. .... 26

G-D-L Masonite Corp.-Western Hardboard  
Div. .... 123

Mateflex by Mele. .... 133

Mayatex-Sisal. .... 129

Messer Machine & Mfg. Co. .... 144

G Mid-State Tile Co. .... 142

Miller Co., The ..... Cov III

Mobay Chemical Corp. ... 40D-40E

**N**

G-I-L Naturalite, Inc. .... 34-35

G-E-I Neenah Foundry Co. .... 140

Neo Ray Products, Inc. .... 151

L Nord Co., E.A. .... 144

**O**

G-D October Co., The ..... 139

G-L Olympic Stain Company ... Cov IV

G Osmose Wood Preserving Co. ... 125

**P**

G-L Pella Rolscreen Co. .... 20-21

**R**

G-L Rush-Hampton Industries, Inc. ....  
18-19

G Ryther-Purdy Lumber Co. .... 143

**S**

G-L Shakertown Corp. .... 32

Shand Morahan & Co., Inc. .... 23

G Sico, Inc. .... 149

G Simplex Security Systems, Inc. ... 147

G-D Sitecraft by Rosenwach ..... 44

Stendig, Inc. .... 3

G-I Sto-Energy Conservation Systems,  
Inc. .... 130

Sub-Zero Freezer Co. .... 16

**T**

Tasitweed-Sisal ..... 129

**U**

G-E-I-D Unistrut Interior Building Systems 135

**V**

G Velux-America, Inc. .... 127

G Ventarama Skylight Corp. .... 137

**W**

Watercolors, Inc. .... 143

Waterworks ..... 40A-40B

G-L-I Weather Shield, Inc. .... 132

Wellsbach Lighting, Inc. .... 126

Wool Bureau, The ..... 22

**Y**

York Heating & Air Conditioning ...  
15

**Z**

G Zero Weather Stripping Co. .... 128

## ARCHITECTURAL RECORD

McGraw-Hill, Inc., 1221 Avenue of the Americas, New York New York 10020  
 Publisher: Paul B. Beatty (212) 997-4685  
 Director-National Accounts: Harrington A. Rose (212) 997-2838  
 Business Mgr.: Joseph R. Wunk (212) 997-2793  
 Marketing Services Mgr.: Camille Padula (212) 997-2858  
 Classified Advertising: (212) 997-2556

### District Offices:

**Atlanta** 30319  
 Terry G. Blackwood, 4170 Ashford-Dunwoody Road, (404) 252-0626

**Boston** 02116  
 Louis F. Kutscher, 607 Boylston St., (617) 262-1160

**Chicago** 60611  
 Donald T. Lock, (312) 751-3765  
 Edward R. Novak, (312) 751-3764  
 Cheryl L. Shores, (312) 751-3705  
 645 N. Michigan Ave. (312) 751-3771

**Cleveland** 44113  
 Michael F. Charlton, 55 Public Square, (216) 781-7000

**Denver** 80203  
 James T. Carahalios, 655 Broadway, Suite 325 (303) 825-6731

**Houston** 77040  
 Lockwood Seegar, 1 Northwind Plaza, 7600 W. Tidwell, (713) 462-0757

**Los Angeles** 90010  
 Stanley J. Kassin, 3200 Wilshire Blvd.-South Tower (213) 487-1160

**New York** 10020  
 Patricia J. Lami, 1221 Avenue of the Americas (212) 997-3603

**Philadelphia** 19102  
 Blair McClenachan, Three Parkway (215) 496-3829

**Pittsburgh** 15222  
 Michael F. Charlton, 6 Gateway Center, Suite 215, (412) 227-3640

**San Francisco** 94111  
 Stanley J. Kassin, 425 Battery Street (415) 362-4600

**Southfield** 48075  
 Charles J. Dooley, 4000 Town Center, Suite 770 (313) 352-9760

**Stamford** 06901  
 Louis F. Kutscher, Gregory Bowerman, 300 Broad St., (203) 359-2860

For detailed data, prefilled catalogs of the manufacturers listed below are available in your 1982 Sweet's Catalog File as follows:

- G General Building (green)
- E Engineering (brown)
- I Industrial Construction and Renovation (blue)
- L Light Residential Construction (yellow)
- D Interiors (white)

# heatherbrown tile



SAN ANTONIO MUSEUM OF ART  
CAMBRIDGE SEVEN ASSOCIATES/ARCHITECTS  
9 x 9 HEATHERBROWN QUARRY TILE



LEAHY CLINIC/MASSACHUSETTS  
THE ARCHITECTS' COLLABORATIVE  
6 x 6 HEATHERBROWN QUARRY TILE



HARBOR PLACE/BALTIMORE  
BENJAMIN THOMPSON ASSOCIATES/ARCHITECTS  
THE ROUSE COMPANY/OWNER & DEVELOPER  
4 x 8 HEATHERBROWN QUARRY TILE

Circle 71 on inquiry card

shep brown inc.

SOLE U.S. IMPORTER 27 STANHOPE ST. BOSTON MA 02116 617/262-5594 TWX 710-321-6840

# meet blandex<sup>®</sup>

## the all purpose panel



### MEET BLANDEX ALL PURPOSE PANELS — The New Generation Construction And Remodeling Product

Whenever construction plans call for the use of panels, BLANDEX is the single answer. From wall and roof sheathing to soffits, installation is expedited with strong, solid, single grade BLANDEX panels which are easily sawed and super tough.

Unusual strength and controlled thickness are achieved by thermo-bonding aspen wafers with phenolic resins under extreme heat and pressure. The finished product is a solid grade A panel without grain, knots or voids. It has an extremely attractive textured surface which lends itself to a wide variety of finishes. BLANDEX panels are also produced with a channel groove or reverse board and batter design for interior application as well as satisfying the growing demand for economical and durable exterior siding. An oil base prime coat and acrylic latex finish coats are recommended to enhance the beauty of the design and provide long lasting protection.



*Changing the way America builds*

Blandin Wood Products Co., Grand Rapids, Minn. 55744

Ask for BLANDEX<sup>®</sup> at your local lumber dealer.

**Circle 72 on inquiry card**



# INTRODUCING THE PRACTICAL PARABOLIC

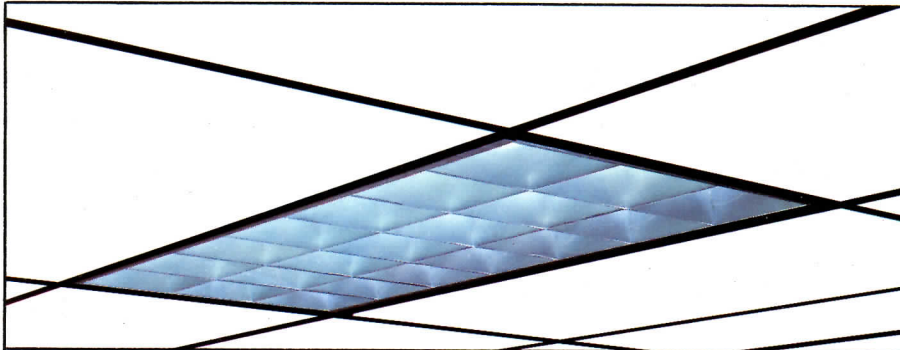

## At last . . . prestige *and* performance in a compact, full function troffer.

Now there's a parabolic that's up to 24% more efficient, provides wider distribution with low brightness and, with an overall depth of under 5 inches, is shallower than any other full-function parabolic available today. Parabolite. Designed to meet the critical energy and lighting performance demands of *your* world — today and tomorrow.

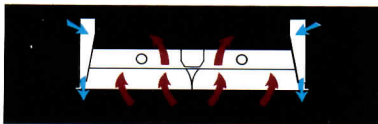

### Shallow design, full air handling

Parabolite installs easily in the tight plenums found

in modern construction, with full air handling capability for supply and return, or high volume return only.

Parabolite is lighter, easier to handle. One man can install it quickly and easily. Its spring latched, reversible safety-hinged louvre assembly makes lamp changes and maintenance simple. And it's available in a variety of standard sizes, cell designs and lamp configurations.

### One housing, interchangeable closures

Our louvre assembly is directly interchangeable with lenses on other Miller troffers that utilize the same

housing. So you can light your new building with any one of a variety of less expensive lensed fixtures, and upgrade to the prestigious look of parabolics quickly and inexpensively at any time.

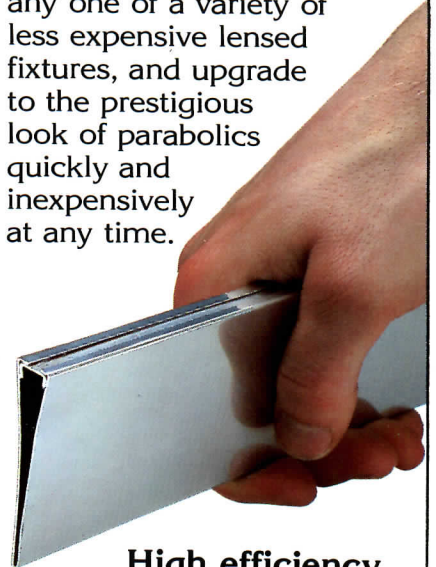

### High efficiency, low brightness

Shallower, thinner louvre blades obstruct less of the fixture's light-emitting area, so you get more usable light . . . up to 74.1% efficiency. And you'll need fewer fixtures, because Parabolite spreads the light out while still maintaining low brightness.

For details on the practical parabolic, contact The Miller Company, Lighting Division, 99 Center Street, Meriden, CT 06450. Telephone: (203) 235-4474.

parabolite

BY  MILLER LIGHTING

# Beauty that's more than skin deep.

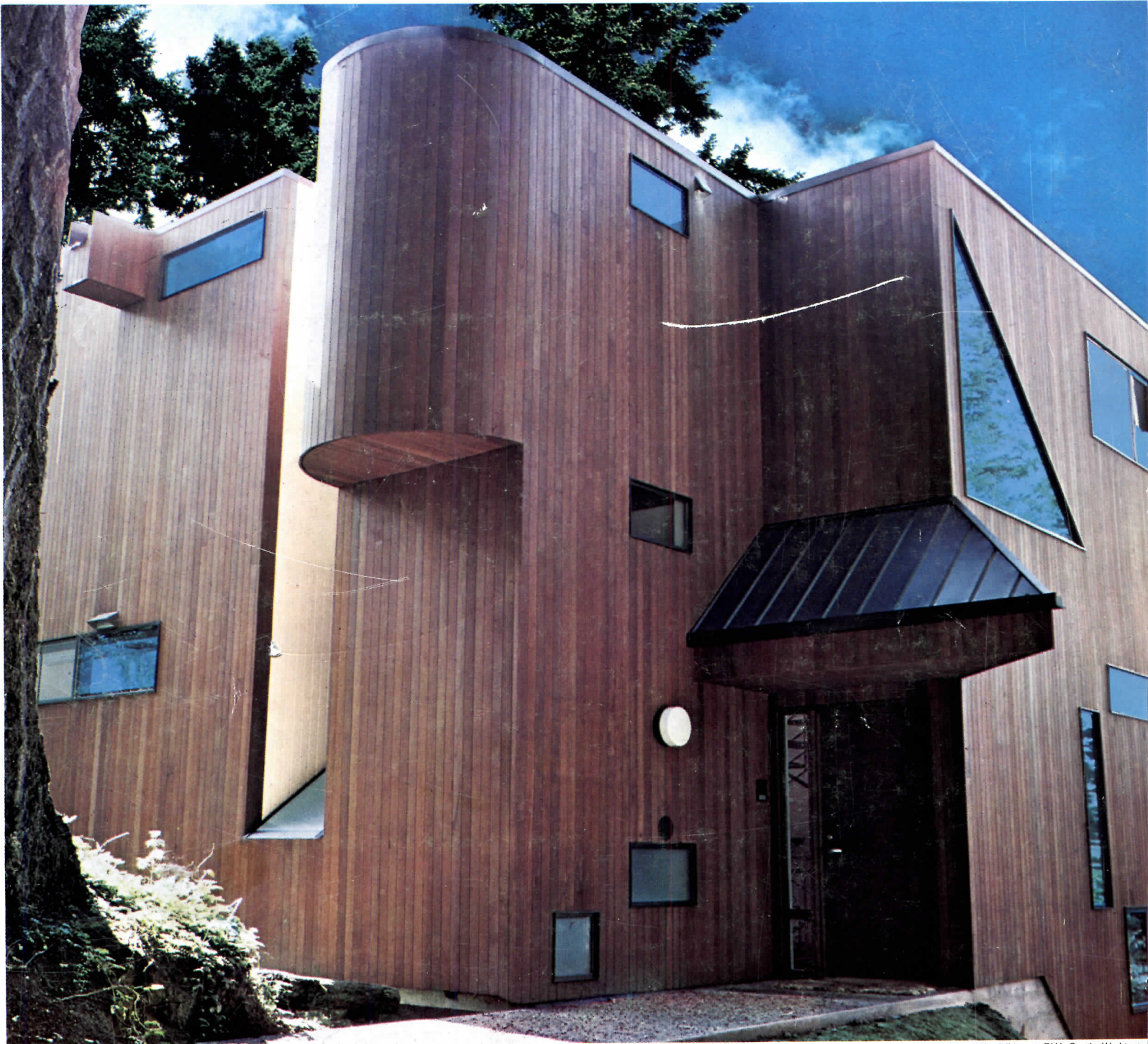

Architect: Wendell Lovett, FAIA, Seattle, Washington

Enhance and protect the natural beauty of wood with Olympic Oil Stain. Olympic *penetrates* wood to protect from within. Rich linseed oil and micro-milled pigments soak down into the fibers, giving wood a deep, uniform finish that stays beautiful no matter how wet or how dry the weather gets.

For additional information, consult your Sweet's Catalog. Or write Olympic: Dept. P, 2233 112th Avenue N.E., Bellevue, WA 98004.

**Penetrates to protect wood beautifully.**



Circle 74 on inquiry card