



Federal architecture:
An agenda for quality

ARCHITECTURAL RECORD

DECEMBER 1978

12

A MCGRAW-HILL PUBLICATION FIVE DOLLARS PER COPY

No Light Stands Alone.

So Haworth offers TriAmbient™ Lighting.

A three part system that combines Panel-Mounted Fluorescent, Panel-Mounted H.I.D. and Free-Standing H.I.D. lights for maximum lighting efficiency and economy in the open office.

TriAmbient Lighting interfaces electrically with our UniGroup® pre-wired ERA-1® panels. So fixtures can be accommodated

without special componentry, and circuits can easily be rearranged without expensive re-wiring.

Panel-Mounted Fluorescents provide down-lighting as well as general ambient illumination. Panel-Mounted H.I.D. fixtures offer an economical source of indirect light. And Free-Standing H.I.D.

lights illuminate areas not serviced by Panel-Mounted Fluorescent or H.I.D. fixtures.

TriAmbient. Three types of lights for maximum efficiency. Because no one type can stand alone.

Ask your Haworth representative for literature, or write Haworth, Inc., Holland, Mich. 49423.

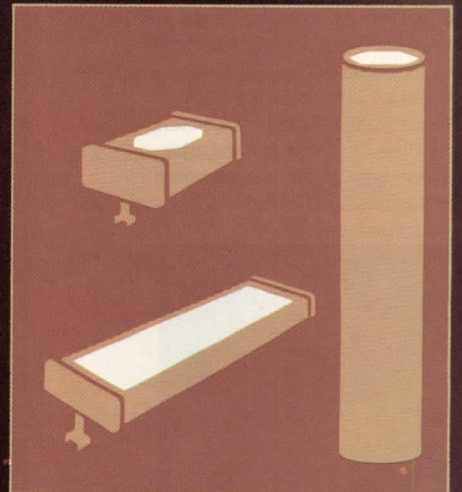

HAWORTH®

Circle 5 on inquiry card

Inflation and anti-inflation policy: what's the building industry to do?

There are very few subjects which concern architects and engineers (indeed, everyone in the industry) more than the high cost of building.

The true villain of the piece—in construction as in life—is of course inflation. So at the recent Building Products Executive Conference, sponsored by McGraw-Hill Information Systems Company, one of the talks that seemed to demand the most attention and generate the most note-taking among the 600 assembled manufacturing executives was the speech by Ted Peck, executive vice president of Owens-Corning Fiberglas, on "How to Reduce Inflation in the Building Business." Since Ted Peck has a long history of having some pretty thoughtful ideas on industry problems, I herewith unashamedly quote major pieces of his talk for your information:

Arguing that inflation in the construction industry is driven by a number of unique problems, Mr. Peck's first point was that materials and labor are not the major problem—indeed that "[the recent] discussion of wage and price guidelines tend to distract attention from the underlying problems that really require the most effort. Certainly, moderation in both pricing actions and labor settlements will help our industry. However, we need to turn a spotlight on the fact that inflation in prices of building is being driven much more by very high interest costs, spiraling land costs, and runaway overheads than by materials and labor. Data from the National Association of Home Builders shows that from 1949 to 1978 labor and material costs dropped from being 69 per cent of the total median price of houses to 47 per cent. Finance costs went up from 5 per cent to 11 per cent, land went up from 11 per cent to 25 per cent, and builders' overheads and profit from 15 per cent to 17 per cent."

The second point Mr. Peck made explored the impact of two "government-driven, inflation-causing problems." The first problem—which we all know too much about (though perhaps we too seldom add up the cost) is over-regulation. The second—which he explored in a way that I had not before heard it discussed—is "the extreme boom-and-bust cycle of the construction industry caused, in large part, by government monetary/fiscal policies . . . How does such wild cyclical instability cause inflation? The 'bust' cycle leads quickly to layoffs of skilled construction workers, contractor bankruptcies, and idle building-products plant capac-

ity. The 'boom' cycle—when the largest number of buildings are built—leads to attempting to build with unskilled labor, inexperienced contractors, and with building-product capacity less than that being demanded by all the builders.

"Workers laid off when the cycle is down often leave the industry. The houses built when the cycle begins to go up again will be built with new, relatively poorly trained workmen [yet] the hourly wage rates of construction workers did not go down during the down cycle . . . During the boom, the shortage of trained labor tends to force wages up although productivity and quality is down, completing the so-called 'ratchet effect' on wage/price levels."

Mr. Peck argued that the boom-and-bust cycle similarly affects contractors: "Just as workers leave the industry during a slump, so, too, do contractors. And improved labor productivity simply won't happen without experienced contractor management of that labor . . . Unable to predict future cycles, land developers make late decisions to start the lengthy process of development. Thus, on the boom side, there is always a shortage of ready, available, developed sites—and so prices soar. In addition, builders have difficulty in using the most efficient technology and capital-intensive methods because of the need to adapt to wide fluctuations in production levels." The similar effect on producers: "Well-managed plants and efficient production methods are of little use when a rapid 'bust' cycle causes sales to drop and inventories to pile up by the door. As manufacturers look to the future, uncertainty about the timing and level of future cycles makes them reluctant to invest in new capacity. The result—shortages during the next upswing."

Mr. Peck pointed out that "recent studies by the M.I.T.-Harvard Joint Center for Urban Studies indicate that the attempt to cure lagging output or ailing employment figures by manipulating the construction industry may be counterproductive to the health of the economy as a whole, aside from the disasters heaped on industry members." And—as we all know well—government-forced boom and bust of the building industry is not the only policy option available to government policy makers. Perhaps a chorus of voices, raised by the industry and the professions, can make itself be heard in Washington. It's worth another try.

—Walter F. Wagner Jr.



OMB's Circular A-109 has pressured GSA into adopting the Level Three procurement procedure for A-E selection, though GSA and other Federal construction agencies are reluctant to use what they regard as a system leading to high costs and construction delays. Details on page 34.

"Nonresidential building has taken over from housing as the construction industry's source of expansion," says George A. Christie, vice president and chief economist of the F.W. Dodge Division of McGraw-Hill Information Systems Company. September contracts for nonresidential construction rose 29 per cent over last September's total, led by a 52 per cent rise in commercial buildings (particularly offices) and a 60 per cent increase in industrial contracts (especially petrochemical facilities). Though residential contracts were up 12 per cent, this rise largely reflected inflation, and the number of units planned was very close to last September's level. At the end of the third quarter, the total value of construction contracts for the year was up 12 per cent.

The Federal tax reduction act offers a 10 per cent credit for commercial and industrial rehabilitation, with implications of benefit to the older cities in the North and the East. Details on page 34.

The International Union of Architects elected Louis de Moll, FAIA, as president, following its recent World Congress in Mexico City. Mr. de Moll, a Philadelphian and a past president of the American Institute of Architects, becomes the first American to head the UIA. During his three-year term, he intends to focus on architectural education, technology, energy conservation and new energy sources, housing, and historic preservation.

The Aga Khan will institute a major architectural prize to foster modern Islamic design, distributing as much as \$500,000 every three years. Details on page 37.

The Frank Lloyd Wright Home and Studio Foundation named Donald Kalec its Research Center Director. Mr. Kalec, an architect, a former Taliesin fellow, and a Wrightian scholar, will serve part-time, with a full-time assistant, at the foundation's headquarters in Oak Park, Illinois. The new research center will open its collection of photographs, drawings and correspondence to architects and scholars by appointment.

The Minnesota Society of Architects has appointed James P. Cramer its new executive director. Mr. Cramer comes to Minneapolis from St. Louis Park, Minnesota, where he served as Director of Community Education and Community Services. He has also taught at the Graduate School of Education at the University of Minnesota.

The New York Landmarks Conservancy has given its first annual Chairman's Award to NYU's Institute of Fine Arts for "excellence in the redesign of a landmark building." The institute occupies the former James B. Duke mansion in Manhattan. Designed originally by Horace Trumbauer, it was recently restored and renovated for teaching and research by architect Richard Foster (see RECORD, August 1978, pages 107-112).

NIBS has published three comprehensive studies on state standards for energy conservation in new buildings. The studies, designed as a ready reference to energy legislation and regulation, are titled *Energy-Conservation Standards for Buildings: Status of States' Regulatory Activities*, *States' Energy-Conservation Standards for New Construction: Development, Administration and Enforcement Processes*, and *States' Energy-Conservation Standards for New Construction: State Legislative Analysis*. The reports are available from National Institute of Building Sciences, 1730 Pennsylvania Avenue, N.W., Suite 425, Washington, D.C. 20006, at \$10 each or \$25 for all three.

The National Council of Acoustical Consultants has issued a 28-page directory of acoustical consulting firms, most of them located in the United States. Copies of the directory are available for \$2.50 from NCAC, 8811 Colesville Road, Suite 225, Silver Spring, Maryland 20910.

The National Trust for Historic Preservation seeks photographs of compatible new architecture in older settings for possible inclusion in its forthcoming book based on the proceedings of the conference "Old and New Architecture—Design Relationship" held last year. Black-and-white photographs may show single structures, major additions or neighborhood in-fill. Materials should be sent to National Trust for Historic Preservation, 740-748 Jackson Place, N.W., Washington, D.C. 20006, Attention: Michael Leventhal.

The New York Section Illuminating Engineering Society invites entries for its 1979 Lumen Awards. The program, which is co-sponsored by the International Association of Lighting Designers, is open to any lighting project either designed or installed in Metropolitan New York, and completed in 1977 or 1978. Submissions are due by February 28, 1979. For information: Alexander Bonvini, Jr., Bonvini/Kondos Associates, Inc., 353 Lexington Avenue, New York, New York 10016 (212/889-8848).

Introducing **MARV-A-GARD**

Presenting maintenance-free exteriors for the world's warmest wood windows: Marv-A-Gard.

Marv-A-Gard windows are the answer to a tough combination of design requirements: Permanent protection outside, warmth and beauty inside, energy excellence, and easy operation. Here's why.

Marv-A-Gard is precision-fitted aluminum with a baked-on Acrylic finish, in gleaming white or rich dark brown. Heavy extruded sections are used on the outside

of jambs, head, and sill. The sash exterior is rolled aluminum. Glazing stops are white vinyl or brown Lexan. The inside of the window is beautiful, insulating wood. The Marvin Casemaster shown here has a heavy 6/4 frame, 1 3/4" sash, extremely low air infiltration, and double or triple glazing.

Write for Marv-A-Gard literature (Bulletin 203) and complete catalogs. Marvin Windows, Warroad, MN 56763. Phone: 218-386-1430.

You've never been so insulated in all your life.



**Marvin
Windows**

Model procurement code calls for traditional method

Architects and engineers favoring the preservation of the traditional, most-qualified, selection process for construction design professionals now plan to give their enthusiastic support to a model procurement code that has been prepared by the American Bar Association.

The code, developed with Federal funding, is intended as a guide for state and local governments. A-Es now plan to testify before legislative committees and city councils to urge the adoption of the standardized codes.

Just a few months ago, representatives of A-E societies were locked in a bitter battle with the ABA over the code. Earlier versions offered local governments the option of either the most-qualified system or one based on priced bids.

Now that is changed. The draft, set to go to ABA delegates for approval in February, only mentions the traditional selection method and adds commentary favorable to its acceptance and use, saying, "The principal reasons supporting the recommended A-E selection procedure are the lack of a definitive scope of work for the A-E service at the time the selection is made and the importance of selecting the best qualified firm in order to assure the most economical and efficient facility."—*William Hickman, World News, Washington.*

Congress gives some relief to overseas employees

A financial tax that has been hanging over architects, engineers and construction company employees working overseas has been lifted. Just before it adjourned for the year, Congress passed a bill giving these taxpayers considerable relief.

U.S. taxpayers will still not be on a par with competitors from other countries—who generally pay no income tax at all to their home governments—but the reductions contained in the Foreign Earned Income Act are nevertheless considered significant and will help erase the advantages that are presently enjoyed by construction teams from other countries.

All Americans overseas will enjoy the same benefits. But because of the way the bill is crafted, a greater share of its benefits will flow to those in the construction industry. For one thing, taxpayers in countries where living costs are highest will benefit most—and that includes the Middle East, where construction activity is the greatest.

In addition, the bill permits a blanket \$20,000 income exclusion, calculated off the top, for taxpayers living in "camps"—as many construction personnel do—if they elect to

forego certain itemized deductions.

Approval of the bill marks the end of a two-year battle led by the Tax Fairness Committee, a group supported by the construction industry. The committee and its business allies had worked to restore tax incentives for overseas workers on grounds that doing so would decrease the cost of doing business and put American companies closer to a competitive footing with firms and companies from other countries who do business abroad.

In 1976, Congress passed a bill that took away the right of overseas taxpayers to exclude up to \$20,000 in annual income from their gross earnings. At about the same time, the Internal Revenue Service, under tax court rulings, began counting more company benefits as income subject to taxes.

Companies took the position that they had to pay overseas employees enough to make up the loss in spendable income. Tax Fairness Director Robert M. Gants says "the added tax burden increased our bid proposals by easily 30 per cent over what our competitors [other foreign construction companies] could bid."

The new law will not return all the benefits lost to the combination of the 1976 law and the tax court rulings, but Mr. Gants calls it "a very strong step."

The flat exclusions are not in the new law. But the deductions taken away by the tax courts are back in, and in a more generous form. Moreover, taxpayers in certain hardship locations are allowed a special \$5,000 deduction. The State Department will designate hardship posts as those where government employees (if they were based there) are paid 15 per cent or more of their regular pay as an incentive to locate there. The entire Middle East is included in this category.

The deduction package will probably benefit overseas taxpayers most. Included are deductions for excess costs of living, housing and education, as well as annual home-leave costs and moving expenses.

The cost-of-living deduction will be the amount by which the cost of living in a foreign place exceeds the cost of living in the most expensive city in the continental United States (presently New York City) for a person with a salary of a GS-14 government employee (now about \$32,000). This amount will be determined under tables, to be developed by the Treasury Department, showing the allowable cost-of-living deductions for various foreign places and for families of various sizes.

The cost-of-living deduction will in effect be indexed, if not precisely for inflation, at least close to it, because the rate of government salary increases generally approximates the inflation rate.—*William Hickman, World News, Washington.*

HUMAN SETTLEMENTS: WORLD NEWS

Triennial Aga Khan prize will award up to \$500,000

The Aga Khan has established a major architectural prize to foster "a resurgence of true excellence in design throughout the Islamic world."

Long interested in architecture, the Aga Khan has expressed concern about "the vacuum in the contemporary search for solutions to design, construction and environmental problems in the Moslem World."

In light of its aims and the unprecedented generosity of its prizes—as much as \$500,000 (\$100,000 for as many as five awards) to be distributed triennially—the competition is now in process of thoughtful organization. Eligible entries will include housing, public buildings and spaces, community planning and restoration and re-use. The program will also give special attention to the original use of readily available, local materials and to designs that encourage the development of building craftsmanship. In addition to architects and other design professionals, prize winners might also include contractors, owners, policy makers and government officials, and master craftsmen. Original research will also be considered.

The program's international steering committee includes as its members the Aga Khan; William Port-

er, dean of the School of Architecture and Planning at the Massachusetts Institute of Technology; Iranian architect Nader Ardalan; Garr Campbell, an American landscape architect now working in Paris; British architect Sir Hugh Casson, president of the Royal Academy; architect Charles Correa of Bombay; architect Hasan Fathy of Cairo; and Professor Oleg Grabar of Harvard University.

To develop criteria for the awards, the steering committee and invited architects, planners, sociologists, anthropologists, historians and philosophers from Islamic countries and the West will participate in six seminars. The first such seminar met at the Aga Khan's secretariat in France in April, the second at Istanbul in September. (RECORD Senior Editor Mildred F. Schmertz attended the second seminar and will report its proceedings in a future issue.)

Under the direction of its convenor, Professor Renata Holod of the University of Pennsylvania, the program will invite confidential entries, limited to buildings in use for at least three years; they will receive on-site evaluation by a group of "validating investigators." The jury (not yet named) will make the first award in 1980.

105-acre fabric roof will shelter Moslem pilgrims at Jeddah

Every year Moslems by the thousands fly into Jeddah on their obligatory pilgrimage to Mecca, which lies 30 miles to the east.

As part of Saudi Arabia's new Jeddah International Airport, the government will build a Haj Terminal to shelter the pilgrims, who presently cluster on the hills in tents or other temporary accommodations.

The terminal, designed by the New York office of Skidmore, Owings & Merrill, will comprise two tension structures, each of which will have 105 individual units; each of the units will cover about an acre.

Each unit will have four steel columns with radiating cables shaping and supporting the white Teflon-coated fiber glass fabric. The roof system will be 150 ft high.

Work on the Haj Terminal is expected to take three years for completion, though part of the facility is expected to be ready in time for the 1980 Haj.

Owens-Corning Fiberglas Corporation, which will provide engineering, fabric and construction services for the roof, plans to construct a two-unit prototype at its technical center in Granville, Ohio.

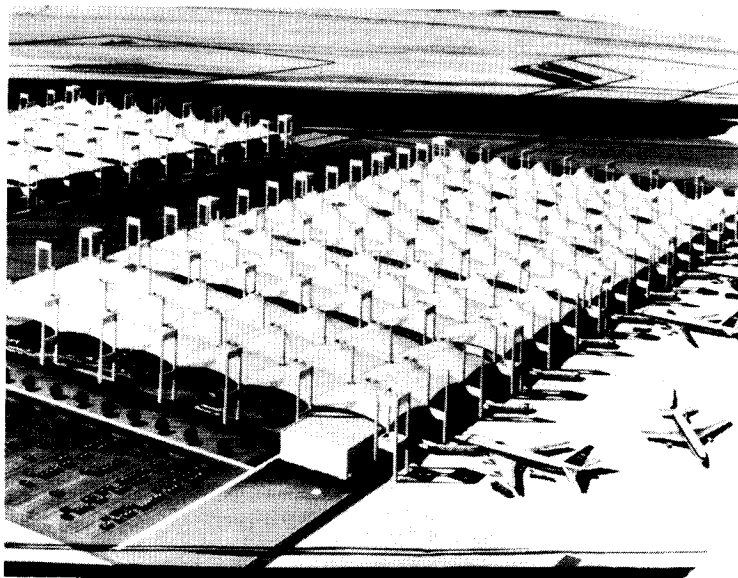

SHERWIN-WILLIAMS



HAS JUST DONE IT AGAIN.

ANNOUNCING PRO-MAR.™

For over a hundred years, whenever architectural finishes were made better, we led the way. Now, we've developed a whole new generation of architectural finishes. Pro-mar. We formulated every Pro-mar item to help make what you paint, design or maintain look better.

Stay looking good longer. And to help keep your costs down. Both your initial costs and maintenance.

THE NEW PRO-MAR INTERIOR FINISHES.

We made these paints to outperform other latex or alkyd paints in their class.

We made them easier, faster to apply. We made them to cover more uniformly and smoothly with greater hiding and touch-up quality.

And we made them easy to wash and clean.

THE NEW PRO-MAR EXTERIOR FINISHES.

We made these paints to outperform other latex or alkyd paints in their class, too.

We made them to take a beating.

Whether it's desert sun, rain, salt sprays, humidity and mildew or sub-zero temperatures.

Our new exterior paints are tougher, more beautiful and longer-lasting than ever.

OUR EXCLUSIVE BEAUMONDE™ II COLOR SYSTEM.

We designed this system to make sure you always get the right color match for your specifications. No matter what finish or substrate you're working with. Latex or Alkyd base. Throughout the 1,280 interior colors.

And 320 exterior colors. This is just the beginning. There are also Pro-mar Block Fillers, Primers, Traffic Marking Paints and Fast-Dri™ Floor Sealer. All designed to deliver the exact looks and performance your specifications call for.

Pro-mar is the finest line of architectural finishes we've ever made. And probably the finest any company's ever made.

See the Pro-mar line at Sherwin-Williams Stores across the country. Or write us. The Sherwin-Williams Company, Architectural Finishes, 101 Prospect Avenue, N.W., Cleveland, Ohio 44115. And we'll send you more information about Pro-mar.



THE NEW GENERATION OF ARCHITECTURAL FINISHES.

Circle 29 on inquiry card

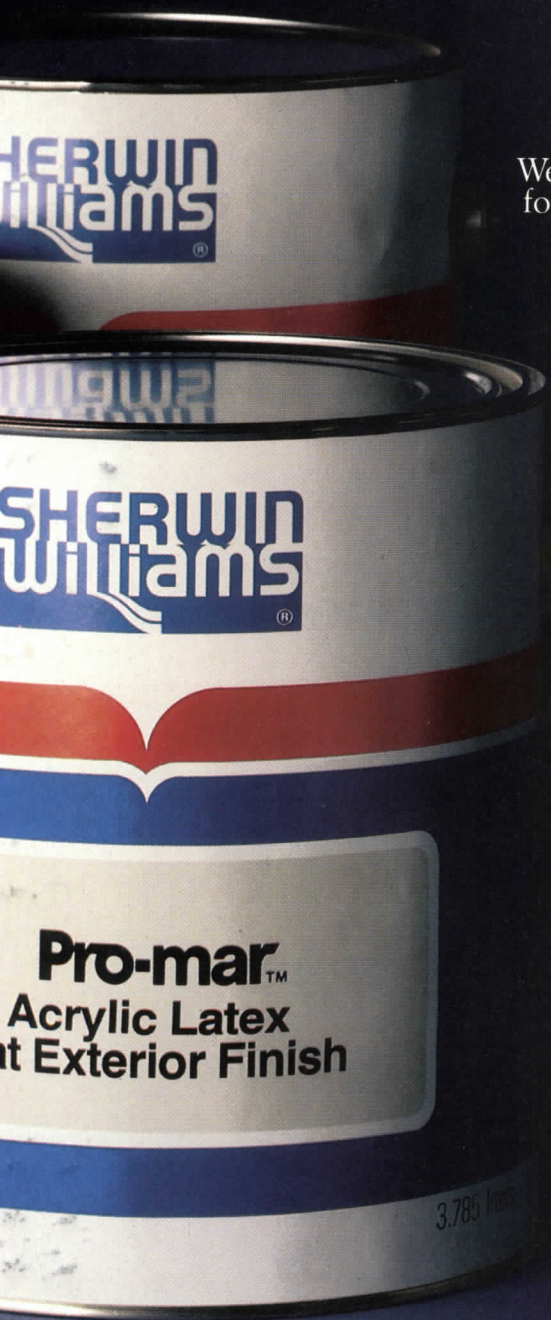

EXTERIOR: 320 colors. Acrylic Latex Flat Paint. Alkyd Gloss & Flat Paint. MORE. Latex Wall Primer. Fast-Dri Floor Sealer. Block Filler. Traffic Marking Paints.

Michigan architects present six design awards

At its annual Honor Awards Banquet in October, the Michigan Society of Architects presented awards for design excellence to six architectural firms: (1) Smith, Hinchman and Grylls, Inc., of Detroit, for the University of Detroit Law School Library and Dowling Hall Renovation; (2) Fry/Peters Associates of Ann Arbor, for the Ann Arbor Central Fire Station; (3) William Kessler and Associates of Detroit, for the Livingston County Courthouse Restoration in Howell, Michigan; (4) David W. Osler and Partners, Inc., of Ann Arbor, for the National Bank and Trust Company in Ann Arbor; (5) Harley Ellington Pierce Yee Associates of Detroit, for the Detroit Bank/Troy, in Troy, Michigan; and (6) TMP Associates of Detroit, for the Federal Office Building in Ann Arbor (see also pages 113-115 of this issue). Members of the awards jury, all from Boston and Cambridge, Massachusetts, were Sarah Harkness, AIA, Earl Flansburgh, FAIA, and

Remmert Huygens, AIA.

At its annual convention, the society also gave its highest honor, the MSA Gold Medal, to Louis G. Redstone, FAIA, for "notable contribution to the Michigan Society of Architects, the American Institute of Architects and its components," and for "outstanding achievement in one or more areas of professional endeavor" (Mr. Redstone is an author as well as a practicing architect). Charles Blessing, FAIA, Professor of Architecture and Urban Design at the University of Detroit and former City Planning Director of Detroit, received the Robert F. Hastings Award "in recognition of distinguished and significant service and contribution to the profession of architecture and the community." The annual Hastings Award, which was presented for the first time this year, is co-sponsored by the society and Smith, Hinchman and Grylls Associates, Architects and Engineers, of Detroit.

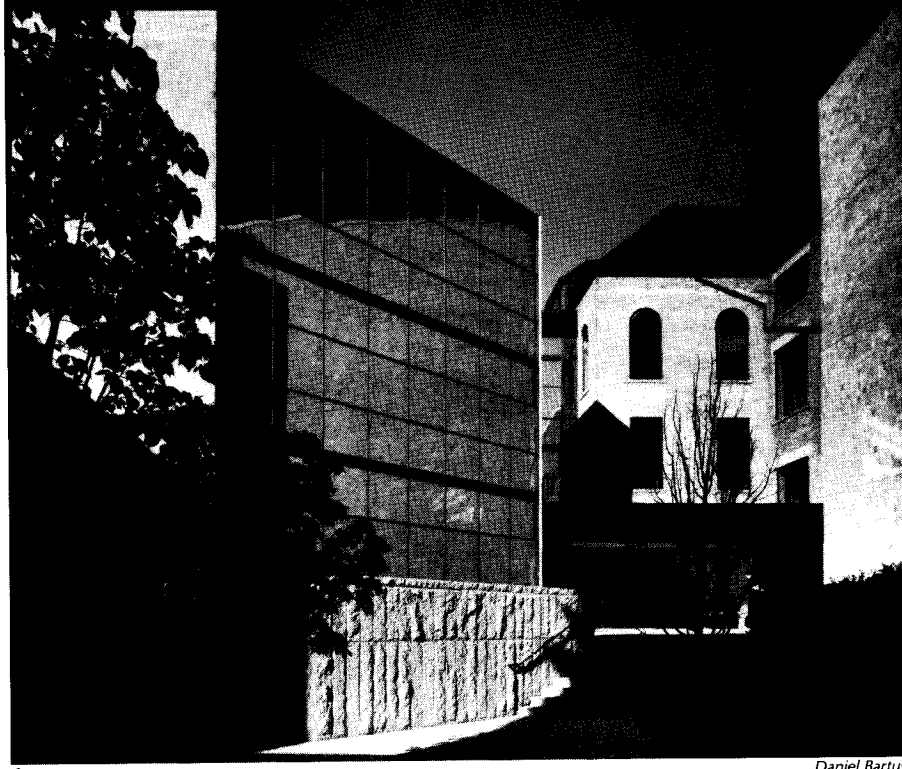

Daniel Bartus



Daniel Bartus

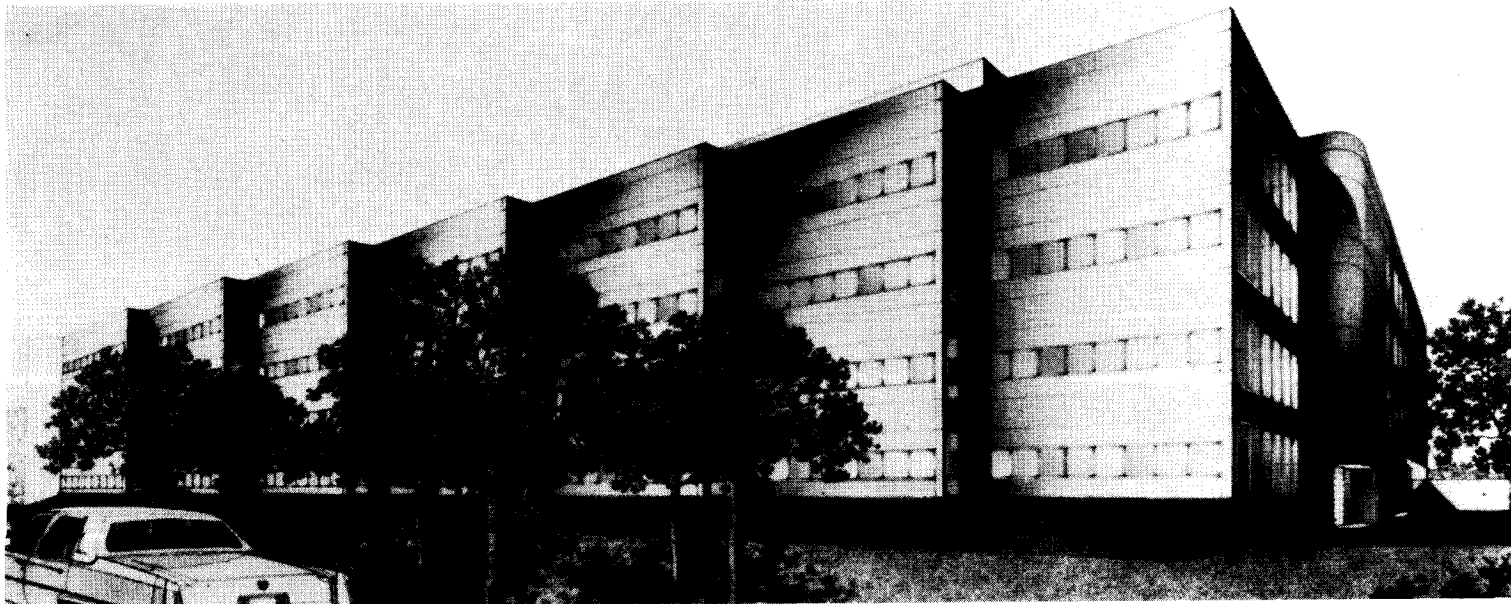

Outside Houston, headquarters for AMAX Petroleum

Outside Houston, AMAX Petroleum plans a four-story marble corporate headquarters. Analyzing the building's

orientation with respect to solar protection, architect Gwathmey-Siegel has given it four distinct facades: on the

north (shown here), flush-set clear windows, with step-backs to multiply corner offices; on the east and west

shorter walls with larger windows, reflective glass and curvilinear fire stairs; and on the south recessed fenestration



Balthazar Korab

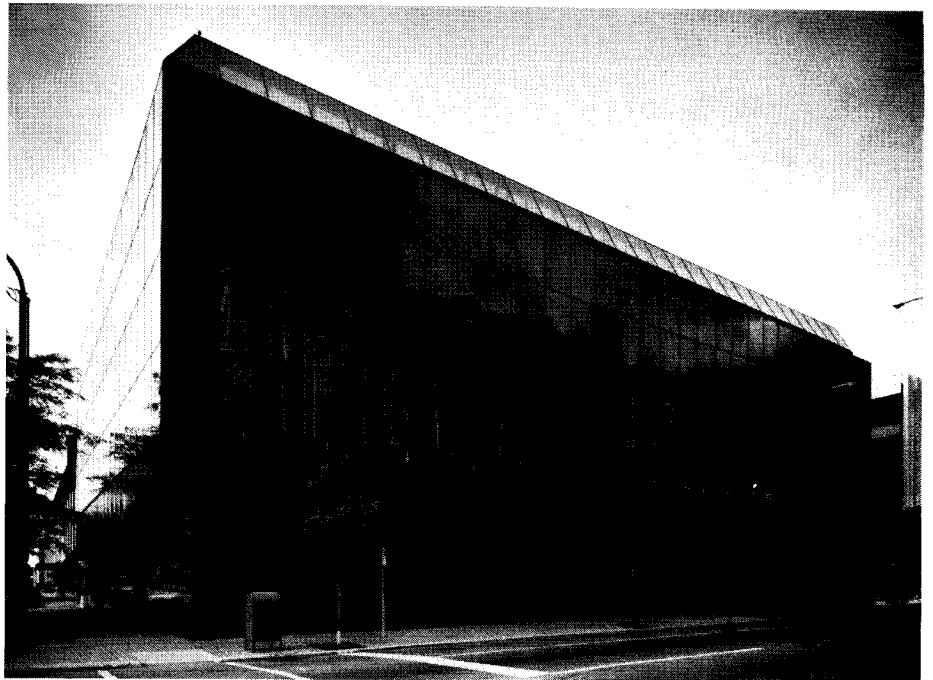

Greg Hursley

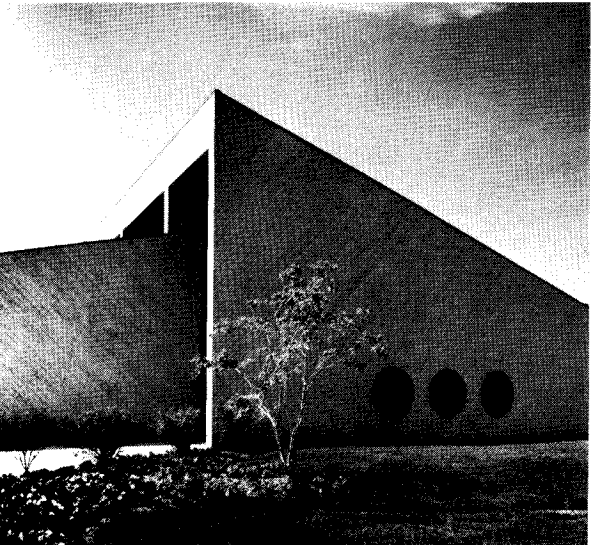

Daniel Bartush

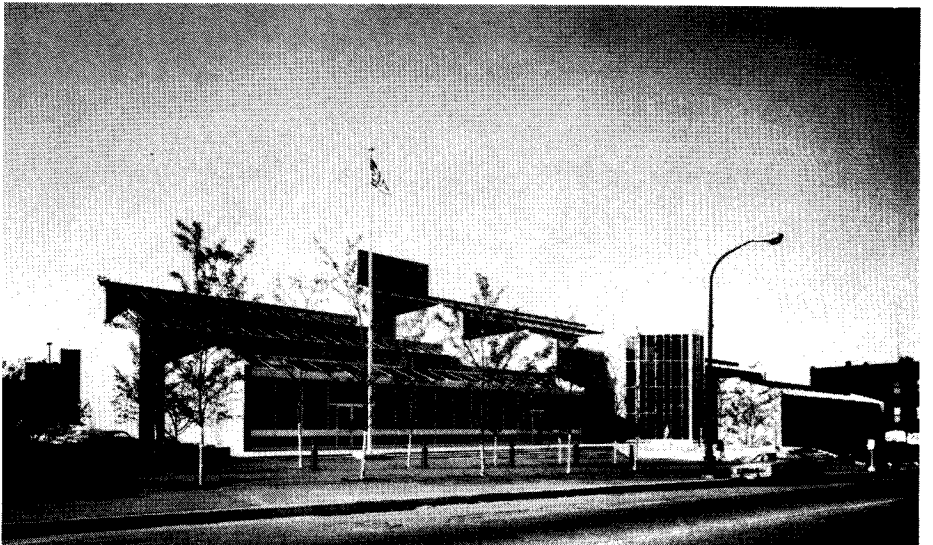

Hedrich-Blessing



In California,
9,204-sq-ft
spec office building

For the Bloeser Carpet Company in Long Beach, California, architects Irwin & Associates, Inc., designed a small, two-story rental office building that offers separate entry from the street to tenants on each floor. Entrance to the second floor is gained by a roof-hung stairway that solved a difficult footing problem imposed by an adjacent building.

On Chicago's Near North Side, a branch bank

At Clark and Division Streets, where Chicago's business district, upper- and lower-income neighborhoods converge, Continental Bank will open a seven-story building combining banking and offices. Architects of the brick and reflective glass building are Skidmore, Owings & Merrill.

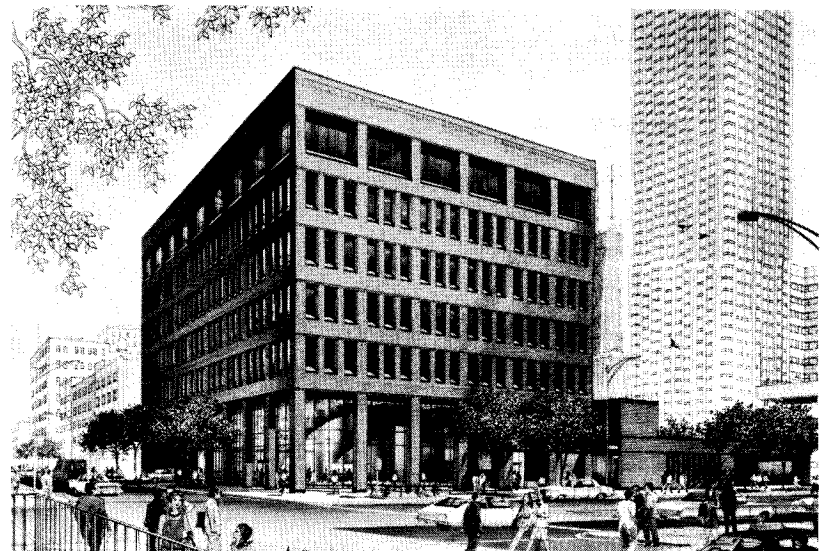



All supported floors are cantilevered to gain maximum floor area over the shallow site. The top floor has a diameter of 100 ft and overhangs the driveway below.

Steel frame wins first "round" in Port Huron

Citizens Federal Savings & Loan Association Building has the distinction of being Port Huron's first circular structure . . . and structural steel received the nod for the framing material.

Both poured-in-place and precast concrete frames were considered as alternate framing systems. But steel proved to be the best solution for several reasons: (1) the designer was able to hold the building height to the desired limit; (2) material costs were less, and (3) the frame could be erected more rapidly.

"An overnight building frame"

The 47,000-sq-ft project was built by the fast-track construction method. Construction speed was a major factor governing the selection of the framing material.

According to the design/builder, the alternative framing systems considered could satisfy esthetic requirements, but not within the owner's fixed budget. And that's where steel had the edge.

Work on the site progressed while the steel was being fabricated. Site work involved driving end-bearing piling and sea-wall sheet piling along the bank facing the river. As soon as the piling was in place, the steel was delivered to the site and erected. Time to erect the complete frame: 1½ weeks. Because of the rapid erection schedule, the structure earned the reputation as "an overnight building frame."

Hybrid frame most economical

The fabricator had the choice of using ASTM A36, ASTM A572

Grade 50, or a combination of both, whichever proved most economical. On this basis, a hybrid structure of high-strength steel columns and girders, A36 beams, and a composite steel floor deck proved to be most efficient.

The floor system consists of 3¼-in. lightweight concrete topping on 3-in. composite steel floor deck supported on steel beams. Even though many of the connections were skewed, no difficulty was encountered during fabrication or erection.

Cantilevered over tight site

The building is situated on a shallow 110-ft lot. By cantilevering the levels, the architect was able to effectively increase the building's floor area without encroaching on the re-

There are literally thousands of buildings in the world that have withstood the test of time and use. In the past, building failures often occurred during construction as empirical design methods were used on larger and grander scales, but once the solutions were found, they provided buildings that would last. It is only during recent history that failures have become commonplace events, and I think the reasons are more complex than your editorial suggests.

The tremendous increase in the amount of building that is now going on and the plethora of new materials and products alone must contribute to an increase in the number of failures if not the percentage. More basic to the problem, however, is the pervasive attitude of planned obsolescence. We no longer build for durability and permanence. Just as we buy cars and appliances that require constant maintenance and periodic replacement, so too has our architecture become one of fad and fashion with limited life expectancy. The lessons are all around us, but we do not heed. The current interest and activity in restoration and adaptive use are made possible because the old buildings—masonry buildings—are still there and still usable, and generally of higher quality than new construction. What will be left of our flimsy glass-and-steel legacy for future generations to restore and re-use if buildings are only intended for 25 or 50 years useful life?

Disposable, throw-away, non-returnable architecture is not a response to budget restrictions, because better and more durable materials and systems are available at much less cost and greater reliability. Building failures result from the attitude that architecture as art relegates functional performance to a position of unimportance and from the attitude that the transience of our built environment does not require or justify quality.

*Christine Beall, AIA
Austin, Texas*

Your article about the North End Community School in Springfield, Massachusetts (RECORD, August 1978, pages 116-119) specifically refers to the very unusual noise and vibration problems of the site, but no credit is given to our role as noise control consultants to Perkins & Will. During the school's design phase, we investigated the airborne noise and ground vibrations of the Interstate highway and railroad yard that serve as virtual roofs over occupied spaces. We provided the recommendations for materials that would permit satisfactory use of these spaces in this novel arrangement. As far as we know, our recommendations were incorporated and provide the desired degree of noise and vibration isolation.

We are enthusiastic readers of your informative publication.

*Klaus Kleinschmidt
Senior Engineer
Cambridge Acoustical Consultants, Inc.
Cambridge, Massachusetts*

I read with great interest your editorial in the ARCHITECTURAL RECORD of September 1978 and, having been involved as the National Program Administrator of the Royal Architectural Institute of Canada's Professional Liability Program since 1975, I wholeheartedly endorse and echo your comments. You have stated succinctly that which is the case.

I address myself to your question "What can and should be done to help the architect get out from between the rock and the hard place?" You go on to suggest some possible remedies and courses of action. In our role in Canada, we continually report, on an "off the record" basis, the facts of all new developments and many repetitious chestnuts in a seemingly endless and almost monotonous manner. It is our experience, however, that while we talk to the profession in many ways, the only ones who hear us are those who listen and for commercial reasons; those who should be listening turn a deaf ear.

In our opinion, the answer of course is to strive for higher professionalism, whereby those

who bend the rules and ethics and fall upon tough times will be weeded out. This, of course, smacks of perfection, and while many strive towards that goal, we really know deep down that few, if any, will achieve it. Hence your words are filled with truth in fact, and every effort should be made to heed them.

It is a fact of life, and will always be so to some degree, that the poor will always be with us, but that should not deter us from trying to make them a decreasing minority.

*J.A. Farquhar, President
National Program Administrator
RAIC & Canadian Engineers
Ottawa*

Granite.

The best in first impressions.

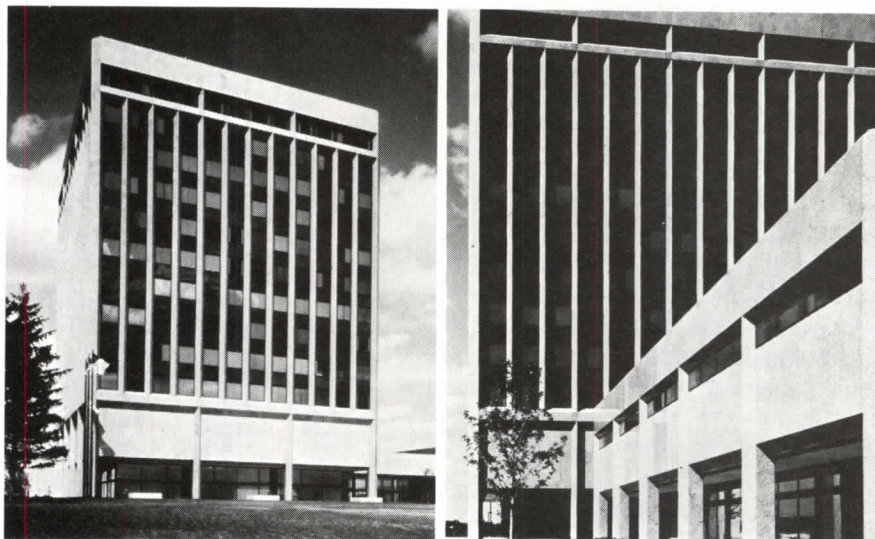

Architect: Graham Anderson Probst & White, Chicago, IL

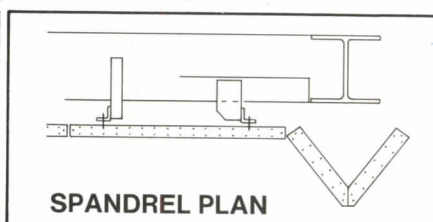
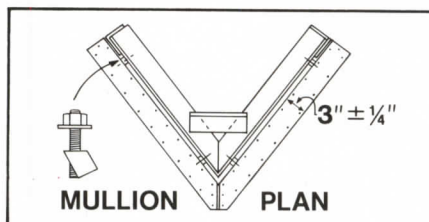

The first impression is the important one. Granite can make that impression more vivid than any other building material available. That's why Motorola, Incorporated selected Cold Spring's Texas Pearl for their corporate headquarters in Schaumburg, Illinois.

Granite affords the architect a resource from which he can create a building that reflects an image of quality... a corporate image. For lasting first impressions, specify Cold Spring Granite.

For more information, plus a free copy of our 16-page, full-color catalog showing all 18 Cold Spring colors available, call toll free **800-328-7038**. In Minnesota call (612) 685-3621, or write to the address below.



Cold Spring Granite Company, Dept. AR-12 202 South 3rd Avenue, Cold Spring, MN 56320

Circle 32 on inquiry card

ARCHITECTURAL RECORD December 1978 47

Mr. Purcell is an attorney with the Chicago and Washington, D.C. law firm of Isham, Lincoln & Beale. With a background in construction contracts and litigation, he is a frequent speaker at numerous design profession and construction industry seminars.

"Legal Perspectives" is published with the understanding that the publisher is not rendering legal service. If legal advice is required, the services of a competent professional should be sought.

in its design and construction. Also, many more judgments, decisions and acts are involved in design and construction than practically any other type of service. More witnesses, more documents and more defendants are involved in a construction case than nearly any other type of litigation. No matter how much care is exercised in trying to preserve evidence over the years, critical

in Alabama, Hawaii (subsequently reenacted), Illinois, Kentucky, Minnesota, Oklahoma, South Carolina and Wisconsin (subsequently reenacted). In those states where there is no special statute, the traditional statutes of limitation apply with the possibility that the discovery rule may be judicially grafted upon them. (This is a particularly severe problem in Illinois.)

GAF® EZ ERASABLE SEPIA DIAZO PAPERS.
**Botticelli would have loved to have them
around when he changed his mind.**

**A concealed sprinkler that goes into the ceiling.
At a price that won't go through the roof.**



The new Unspoiler sprinkler.

When you choose the new Star® Unspoiler® sprinkler, you get a concealed sprinkler that won't spoil your interior designs. At a price that won't spoil your budget.

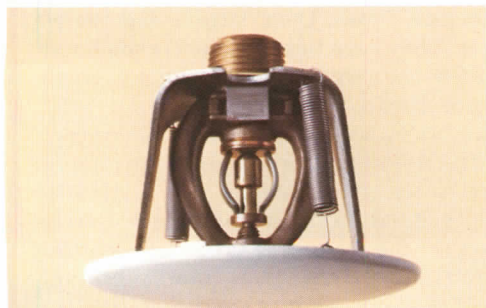

You won't find a less expensive concealed sprinkler on the market. There's no need for costly special piping. And you save big on labor costs because the Unspoiler is easy to install.

Best of all, there's no waiting for delivery. We provide same-day shipment on orders accepted by us before 3 p.m.*

**The looks look good.
The works work.**

The Unspoiler will fit just about any color scheme. Choose from our standard flat white, chrome, satin chrome and bronze colors. Or order a custom finish to match a special decor.

Star is a name you can rely on for

inventing the first concealed sprinkler, we've learned a lot about making the best product you can buy.

When you need a fire protection system that looks as good as it works, call (800) 323-4482. Illinois residents call (312) 534-1000. Or write Chemetron Fire Systems, Route #50 & Governors Highway, Monee, Illinois 60449.

*Subject to conditions beyond Chemetron's control and to limitations of liability provisions as contained in Chemetron Fire Systems Division's terms and conditions of sale.

CHEMETRON
Fire Systems

Pension fund strategy: taking advantage of "smallness"

The chief executive officer or owner of a small- to medium-sized company is usually a trustee or at least very much concerned with the performance of his organization's pension fund or profit-sharing plan. All too often these days he finds that while his company's fund manages to keep pace with, or even exceed, the Dow-Jones averages, the value of the investment goes down, rather than up. The full-time professional money managers, who have access to information and resources far beyond those available to the individual pension fund manager, have begun to embrace the indexing concept, which has as its goal only tying the market rather than trying to beat it. This shift of monies into index funds may seem to be justified by the fact that most professional money managers have been, as many of us have observed, consistently underperforming the market for many years. Considering, then, the poor track records of the full-time professionals, do managers of pension funds of \$2 million or less have any reasonable chance of success? Should the small pension fund manager follow the big guys, adopt the indexing concept and settle for a tie?

by Thomas C. Noddings

The fact is you cannot expect to outperform the full-time professional money managers if you're investing according to their rules; judging from past performances, chances are remote that the small funds will even come out as high as a tie. However, there is an important alternative to indexing, and every manager of a pension fund of \$2 million or less should be aware of it.

You've often heard that if a new strategy were developed to beat the stock market, it would be exploited by professional money managers so quickly that it would soon be worthless. This is not so.

Hedges and convertible securities are effective for smaller pension funds

The use of convertible securities is fast becoming an accepted tactic of prudent fund management. The reason for its acceptance among sophisticated investors is that convertible securities allow one to control risk, yet seek above-average return on investment. Not everybody can play this game. It has proved most effective for pension funds and individual investors in the \$100,000 to \$2 million range, combining hedges and convertible securities that are available in quantities usually too small for large institutional money managers to consider.

This strategy is also not extensively promoted by the brokerage community to its retail customers, simply because it is too

difficult to comprehend or employ effectively, and requires too much time and effort relative to the commissions earned.

This strategy—too sophisticated for brokers to employ and entailing investments too small for large professional money managers—is developed from information and ideas from the universities and individuals who are not hampered by such professional methods as indexing. It is based on the efficient market theory, designed to control downside risk and achieve about-average returns whether the stock market goes up, down or sideways. The use of hedging techniques within pension and profit-sharing plans also makes sense from the standpoint of fiduciary responsibility. Fiduciaries must act solely in the interest of the plan's participants and beneficiaries in accordance with documents governing the plan and in accordance with the "prudent man" standard. This requires diversification of the plan's investments so as to minimize the risk of large losses. Hedging enables the fiduciary to control risk and preserve capital, thus meeting his responsibility.

This makes a strong case that the use of hedging strategies in pension and profit-sharing plans not only can be done, but should be done. There are no special mechanical problems when utilizing hedging techniques. Many plans have used them successfully.

Many hedges utilize convertible securities that are undervalued. In simple terms, an undervalued convertible is one that will rise in price nearly as much as the common stock to which it is convertible, but it will fall in price a great deal less than the common stock falls. The downside risk on an undervalued convertible is small because its yield provides a floor below which its price will not fall. On

the other hand, as the price of the underlying common shares rises to approach the point where converting the bond or the preferred stock is attractive, the price on the convertible will rise nearly as much in percentage terms.

For example, Ford Motor Company common stock recently trading at \$45 per share has available a convertible bond trading at its conversion value of 72. Any advance by the common stock *must* be fully reflected in an advance by the convertible. But, on the downside, the investment floor of this high quality bond would limit the decrease to less than half the drop in the common stock.

These blue chip investment instruments make better sense to smaller pension funds

In our pension fund management portfolios, we have taken positions in 88 convertible bonds and preferred stocks. From the beginning of 1977 through September of 1978, the portfolios on average gained 34.6 per cent and yielded 6 per cent yearly in dividends and interest. Over the same period, Standard & Poor's 500 dropped 4.6 per cent. Excluding the convertibles' dividends and interest, the difference or "swing," in performance amounted to 39.2 per cent, a record that must be rated superior by any measure.

It should be emphasized that these opportunities available to small- and medium-sized pension funds and profit-sharing plans are not in the area of speculative investments. They are for the most part blue chip investment instruments available simply because they lack the huge liquidity needed by institutional money managers in developing a portfolio. The opportunities also include specialized techniques where the institutions are restricted by the size of their capital or by government imposed regulations on put and call options and short selling. (Basically, a call option gives the holder the right to purchase the stock from the seller of the contract at the specified price within a fixed period of time. The put option obligates the seller to take delivery of the stock and pay the specified price to the owner of the option within the time limit of the contract).

For example, hedging with listed put and call options can be rewarding. Using undervalued convertibles for the long side of the portfolio, this strategy permits the short sale of call options or common stock which are normally valued—a combination that still provides high profit potential at low risk.

Thomas C. Noddings is president of Thomas C. Noddings & Associates, Inc., a Chicago brokerage and investment counseling firm. Mr. Noddings, a mechanical engineer, became a stock broker in 1971 and established his firm in 1977. It now manages \$15 million for small pension or profit sharing plans. Mr. Noddings is the author of three books on investment strategy published by Dow Jones-Irwin.

The look and comfort of honest elegance.

All-Steel's new 130 series seating.

A blend of tasteful styling, ergonomics, and quality engineering.

Here is a subtle fusion of form, materials, and concerned attention to detail. A deep, dual cushioning system offers luxurious, controlled support to both the lighter and heavier parts of the body, and the waterfall perimeter relieves under-

knee pressure which can interfere with circulation. Notice the angled arms. More than a styling element, they allow the chair to be pulled farther under a desk, closer to the work.

We use the intrinsic excitement of oval, tubular chrome and a unique button tufting to create design continuity.

The new 130 Series includes 13 models, 26 styles, and a choice of four or five-arm bases. We suggest you inspect and sit in these chairs yourself. Then, make your own assessment of honest elegance.

For our new color brochure, write to All-Steel, Aurora, IL 60507.



ALL-STEEL

Circle 55 on inquiry card



ALL-STEEL
130 SERIES

An artist's point of view

Somewhat in the background of ARCHITECTURAL RECORD's coverage of at least half a dozen major buildings in the last 20 years is the sculpture of Richard Lippold. His delicate, abstract constructions of highly polished metal—tensive, but always serene—appear in almost every building type from "bars to cathedrals," including: the Four Seasons Restaurant (New York, 1959; Philip Johnson); Philharmonic Hall (New York, 1962; Max Abramovitz); the Pan Am Building (New York, 1963; Emery Roth & Sons, with Walter Gropius and Pietro Belluschi); Hyatt Regency Hotel (Atlanta, 1966; John Portman); Jesse Jones Hall (Houston, 1967; Caudill Rowlett Scott); St. Mary's Cathedral (San Francisco, 1971; McSweeney, Ryan & Lee with Pietro Belluschi); and the National Air & Space Museum (Washington, D.C., 1976; Hellmuth, Obata and Kassabaum).

Although his work can be found in many prominent public and private art collections, and has lately attracted the patronage of Middle Eastern royalty, the sculpture of Richard Lippold seems most at home—even necessary—in the public spaces where it is most often found. Lippold himself describes his sculpture as "inhabiting" its architectural surroundings, there simply as a perpetual invitation to humanity to share in the activity of the space. His attitude that neither the sculpture nor the space would be quite complete without the other is the basis for the enduring esteem in which many architects hold Lippold, who—for his part—seems completely at ease with the scale of their contemporary architecture.

In the following interview, Lippold gives us his view of the current state of art in architecture. Accompanying the interview are photos of "Gemini II," installed in the lobby of Jesse Jones Hall, Houston.

The modern movement in architecture seems to have fallen into disrepute lately. How do you view the current architectural soul-searching of the United States?

I am at the moment writing a letter to the *AIA Journal* in answer to Philip Johnson's remarks which are summarized in the July issue—after he received the AIA Gold Medal—in which he said we are entering a whole new phase. We don't know how to define it yet, but what it amounts to is a great eclecticism.

There's been a lot of criticism, for

opposed to, say, an uninnocent season. I've



Bert Brandt & Associates

Great architecture . . . has never seemed to me to be greatly functional. It's been a poem; it's been poetic; it's been a creative effort. Function is only an excuse for architecture. It's to be a symbol of our time.



Architect: Skidmore, Owings & Merrill

Happy 25th Birthday to Lever House

and the LP®
polysulfide base
sealant that has
kept this building
leak free.*

Twenty-five years of continuous performance proves the durability of polysulfide base sealants. After all, withstanding constant joint movement and vibration in a curtain wall building, like Lever House, is quite a task.

That's what separates sealants backed by performance from those backed by claims.

But Lever House isn't the only building where polysulfide base sealants have provided long term performance. There have been many others, and we would like to tell you about them.

Write: Marketing Comm.,
Thiokol/Chemical Div.,
P.O. Box 8296,
Trenton, NJ 08650

**Six months after the completion of Lever House, there were serious leakage problems. The original oil base caulk was replaced with an LP polysulfide base sealant which has remained intact ever since.*

Thiokol / CHEMICAL DIVISION

P.O. Box 8296, Trenton, N.J. 08650

thermoplastic urethanes • urethane oligomers, prepolymers and rubbers • acrylic monomers
polysulfide polymers and rubbers • plasticizers • epoxy modifiers and curing agents

I'm not interested in just making sculpture and sticking it into space, and I think a lot of what is done these days has that quality.

described that building as being like a Nautilus shell, and thought it really needed some kind of beautiful, scaled creature in there. I felt one would be too small or too lonely, so I made two, and two of them are prancing around in that space.

In other words, I was trying to enhance, not fight the space. I don't ever want to do that. I have too much respect and love for architecture to try to kill it.

Is art's relationship to architecture now different from previous eras?

I think it's the contemporary concern these days—maybe it's economic—with the function of a building, and how to do it efficiently and effectively, to make it work. I don't think anybody thought about how a cathedral worked, except that it had a lot of people in it. It's impossible to heat, it's miserable in winter and totally inefficient as a structure—difficult to make to say the least; all kinds of devices to hold it up. In other words, great architecture of the past has never seemed to me to be greatly functional. It's been a poem; it's been poetic; it's been a creative effort. (Function is) only an excuse for architecture. It's to be a symbol of our time. I think there are very few architects in the twentieth century who have really got that intellectual degree.

An example of a building I love very much is the Wieskirche, a beautiful Bavarian village church. There are four large saints standing in slight hollows made by double columns that form an oval in plan. These four saints are very large scale; they're all white, enameled white and they have touches of gold just miscellaneously put around to just give accents. The building is all white and gold. I've spent a lot of time in that building because I think it's one of the masterpieces of art. I don't say that the sculpture is that great, but if you put one of those saints in the Metropolitan Museum—like they've done with the Temple of Dendur, under a glass shed—anybody seeing it would have no idea at all of what those sculptures meant in relation to that building; you cannot take them away.

Then I've tried to imagine the building without those four saints standing there: what they do to the columns, what they do to the windows—how the light falls upon them. This was all thought out.

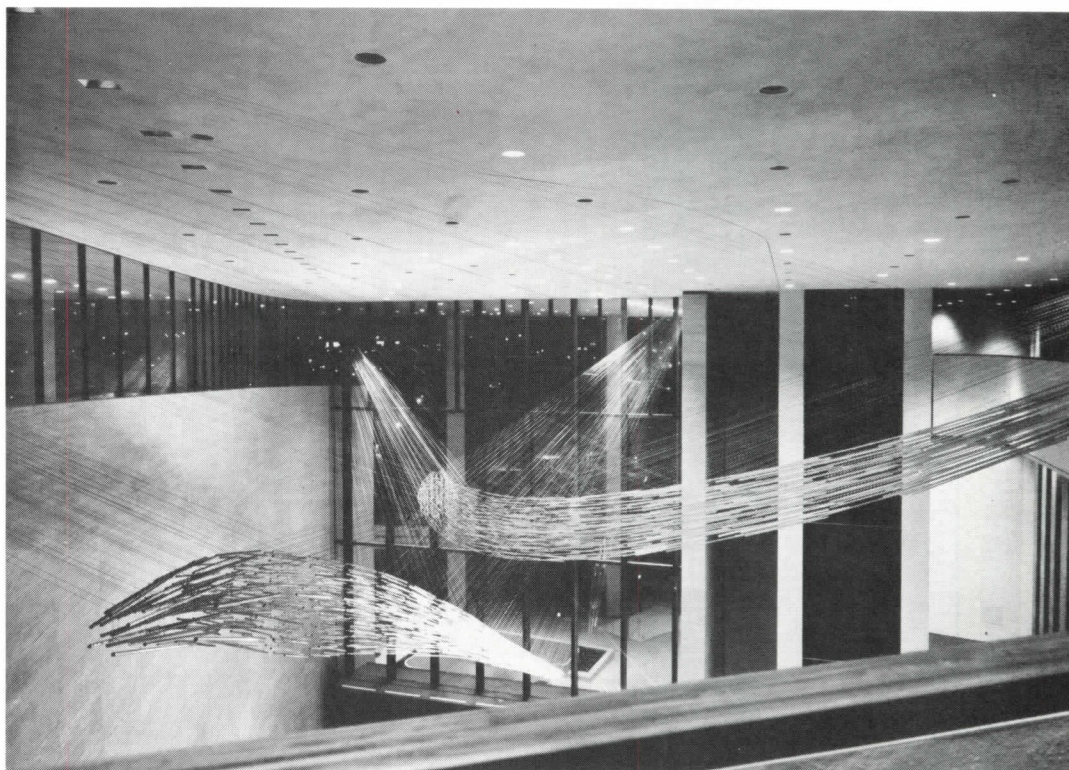

Jay Oistad

I once discussed this with Philip Johnson because I was very sad at one point in my life, and I thought, somebody's got to try to understand what I'm talking about. I had just come back from Bavaria, and I said "Philip, why can't we learn from something like the baroque sculptures, and sit down together and make something with that same kind of integration of quality? Why must you be making this over here, and I'm sitting over there?" And he said, "you just forget about those problems. You go in your back yard and make pretty things, and we'll find a place for them in the buildings."

I'm not interested in just making sculpture and sticking it into space, and I think a lot of what is done these days has that quality.

Light reflectance is a major characteristic in your work. Why is this kind of brilliance so important to you?

I happen to love metal. I can't tell you why I do. Painted metal to me is a violation of the metal; it could be almost anything. Now, the honesty about metal is that when it's polished, you see what it is. If it's dull, it could be a dull paint, it could be obscured by

something. So I've tried to use as much as possible, polished materials. I have a fabricator who's always trying to convince me—as he did for the National Air & Space Museum that it would be easier to do it in a matte finish. All this polishing is expensive, it's hard to do, it shows every little flaw. My only answer is, it has to be done. It had to be polished, because part of it disappears in reflecting the sky; it's both present and absent; it can disappear under certain light conditions; it can be present under certain light conditions; it can be modest; it can be aggressive. If it were dull, you would see it intact and nothing would ever disappear. There's no magic, no mystery and there's enough mystery in life to make me feel that I'd like to see that in works of art too.

Now there are plenty of people, critics, who see my work as just decoration, and whether it's because I'm doing it with architecture, I don't know. I would like to hope that my work is like a heart or nervous system, or something that a building would lack without it. I suppose I would like to feel that maybe this is what art should be; it should be meaningful decoration.

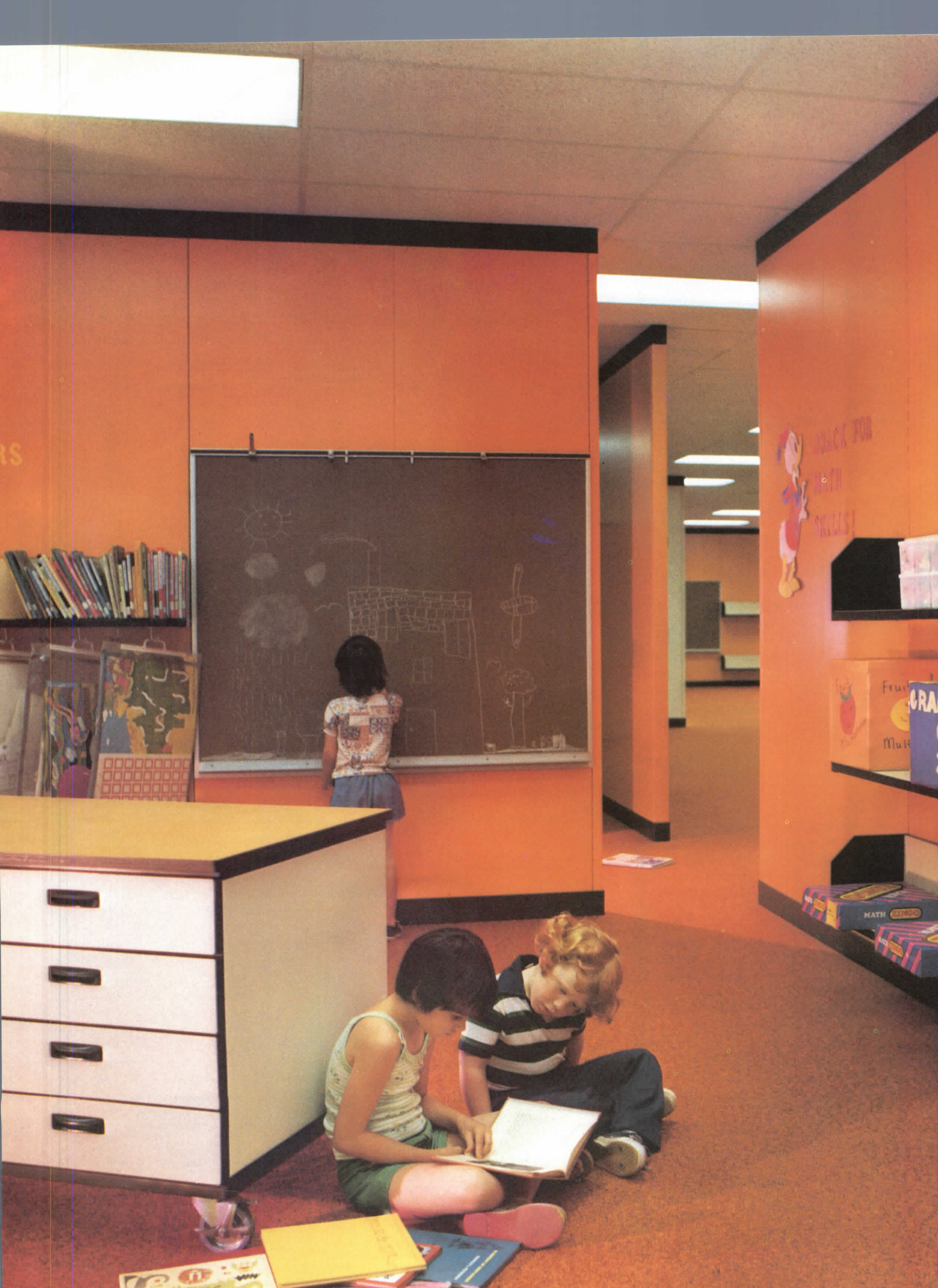

FEDERAL ARCHITECTURE: WHY NOT THE BEST?

Thomas Jefferson also built declarations, embellishing with Athenian taste, as he said, the course of a nation looking far beyond the range of Athenian destiny. But his significance as an architect, beyond historical and stylistic precedent, was that he believed that public buildings should participate, just as people should, in leavening public values.

With a view that becomes more challenging as time goes on, Jefferson saw architecture as a public service, as well as the most public art—as respectable a framework for perceiving, posing, and acting upon questions of the day as the study and practice of law.

Architecture was not the only thing in life to him, certainly, but Life, Liberty, and the Pursuit of Happiness were what architecture could most tangibly express. Political, ethical, and philosophical

development had, he believed, an intrinsic relationship. Its structural, spatial, and symbolic nature—defining, depicting, giving direction to human enhancement—were a matter of *design*.

Perhaps the concerns of a Thomas Jefferson seem remote from a country where the nearest thing to his “yeoman farmers” represents barely four per cent of the population. But it may be that it is not that the American wilderness became too practical for such public sensibilities about architecture; it may be, for all of our industry, technology, and organization, that it has not yet become practical enough.

To ask how Federal architecture is doing these days is not just to ask why our public buildings are not more “beautiful,” or to ask how the best and brightest can get more jobs. It is to ask, more

Historical Monument of the American Republic, 1876, by Erastus Salisbury Field, Museum of Fine Arts, Springfield, Massachusetts

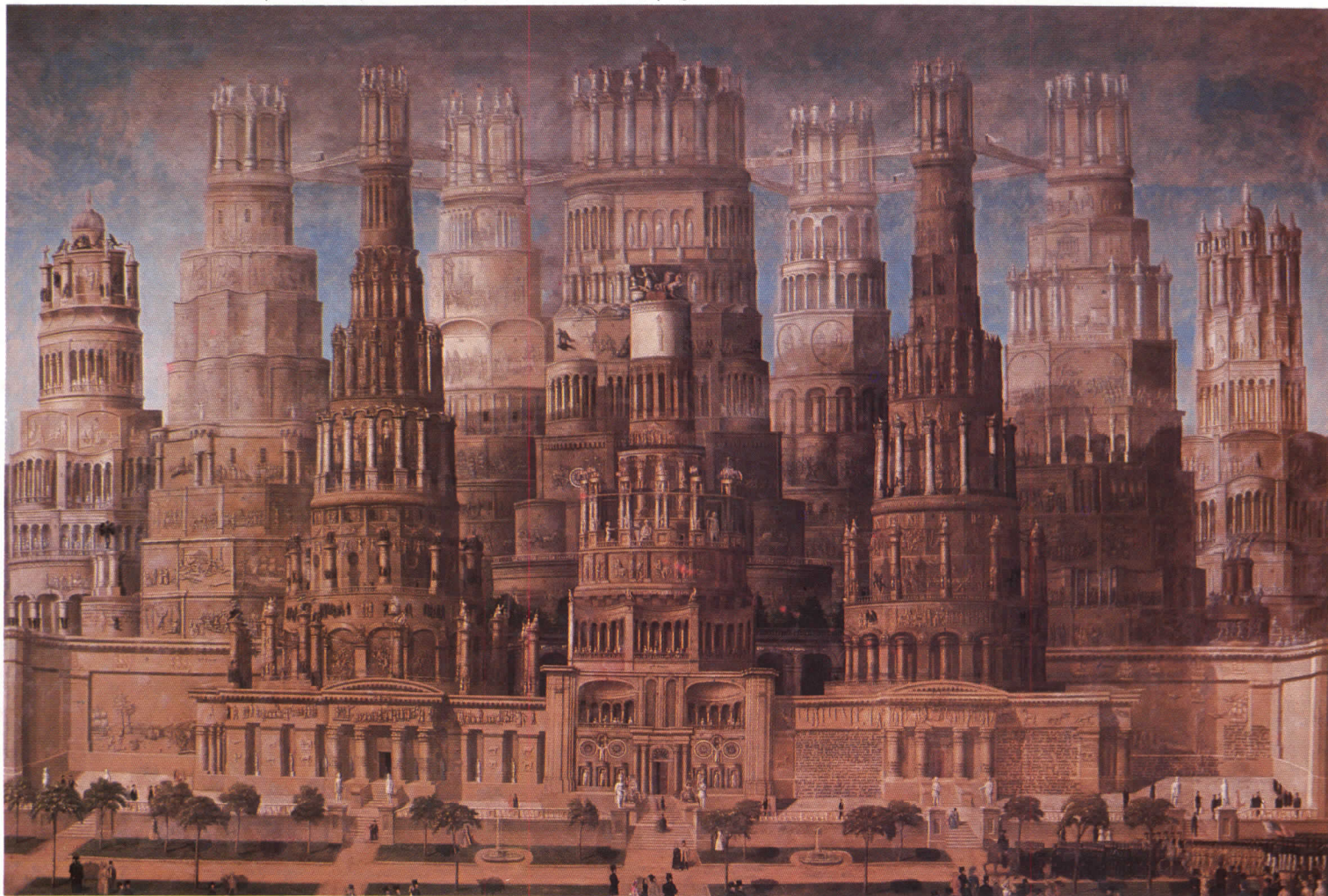

The Chicago Federal Center, by Mies van der Rohe, Schmidt, Garden & Erickson, C. F. Murphy Associates and A. Epstein & Sons (1973), right, shows off rather than showing up the heart of the Loop. The Federal Office Building in Santa Rosa, California (below), by Roland/Miller Associates (1977), is a terraced composition that steps up above a two-story public Galleria, relating itself agreeably to a broad landscaped street.



Bob Thal



Barbeau Engh photos



vitality, about the field's own limiting outlook on the philosophical as well as pragmatic nature of the public realm; to ask, indeed, why this matter of *design*, as an integral and integrating consideration, has not yet been worked into the policies, programs, and procedures of the Government. When architects praise Thomas Jefferson—his Monticello, his State Capitol at Richmond, his University—are they really praising the right things? Or should they, going further, praise, putting to work, his sense of architecture as an active, casual force for quality at every level of public decision?

Federal architecture, with its diversity and dollars, touches almost every community and curbstone in the country. With the exception of those facilities requiring strict security, every building is an opportunity, too frequently missed, to invite everyday people into a warmer relationship with the presence of the Government. Federal architecture is important because it is *us*, the very diversity and dollars of the people. And the people have a right to expect that when they encounter a Federal building that friendly looks of recognition are exchanged.

This issue of ARCHITECTURAL RECORD, without declaring a millennium, is meant to describe some momentum toward achieving quality—and toward achieving it as a matter of *routine*. This means describing more than a selection of pretty buildings—architecture is hardly a matter of prettying up what is already decided on, designed, or in place, although most agency and departmental chiefs think so. This is about the gradual changes that are taking place in policies, programs, guidelines, procedures of professional selection and project administration, and in public laws. In a time when physical enormity has induced human anonymity, it also means describing efforts to induce intimacy and identification—facilities that, whatever the specific set of functions they are built to house, engage the public imagination and, whenever possible, include public uses of a cultural, community, commercial, or educational nature.

This is a public architecture, as Senator Daniel Patrick Moynihan has said (see page 110), that would bring people together in an experience of confidence and trust: "The city beautiful is as valid a concept today as it was when George Washington and Thomas Jefferson established it almost two centuries ago. It is not a concept to be traded in for anyone's notion of private gain or social welfare. *It is not an efflorescence of elitist estheticism, it is the bone and muscle of democracy, and we must begin insisting on it.*"

Every public building can be, and should be, developed with opportunities for our humanness and wholesomeness to be exercised and expressed. Devoid of allure, amenity, and activity, most public buildings have gotten people to thinking that the public realm does not mean anything anymore, in the same sense that they have

Nashville's old Union Station (right) is one of the first of several such historic facilities to be taken over by the General Services Administration for transformation into a mix of Federal office space and publically oriented activities. GSA has conducted a Level 3 competition for this station, which was built in the 1890s to the design of engineer Richard Montfort. It was taken over for just one dollar, making this culturally vigorous program that much more cost-effective as a source of urban revitalization.

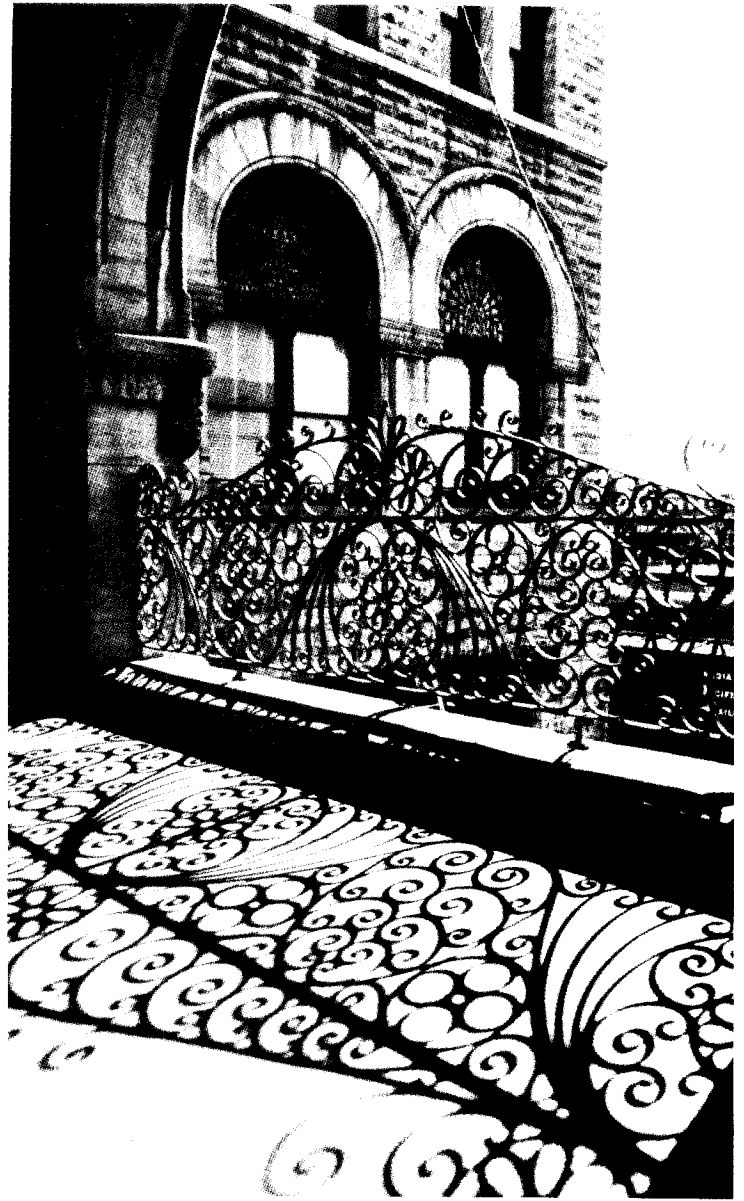

C. W. Waterfield, Jr. photos



gotten to thinking of streets—not as the “meeting rooms” that they once effectively functioned as—but as roads to drive along.

It is this detachment, of buildings as they relate to each other, of people as they relate to each other, that has been memorialized, monumentalized, and magnified by most Federal architecture. Socially, culturally, and psychologically, this detachment is damaging. Federal architecture must offer an option.

J. B. Jackson, the historian, has written, “No one in their right mind goes into a public building except on business.” Among many students of human history and daily experience, he is perceiving a problem that is central to understanding what has been so terrifically wrong—most Federal buildings are aloof from the historical, cultural, economic, and physical context of the communities in which they are built. As a result, people as a whole no longer perceive the presence of the Government as a particularly personable affair. In recent decades, good old Uncle Sam has gotten up some of the ugliest buildings in history. It is time for some good *new* days, recollective of the period when people swapped stories, goods, and concerns on the court house square—or when the post office and general store were one in the same, occasioning spontaneous human interaction.

If public buildings are to be truly public—good-feeling, good-looking, as well as functionally efficient—the best and the brightest design professionals must be attracted to work for it on a contract basis. But this alone will not transform the situation. As one White House staffer recently confided, “There is a feeling in the architectural profession that if *only* there were some decree defining and demanding quality everything would be great. No. Ensuring quality is a gradual process of learning, persuading, and *demonstrating* the cost-effective dividends, managerial efficiencies, and upbeat productivity that thoughtfully designed, well-coordinated, considerably scaled development can bring about. It is an agency-by-agency process—a matter of working out ways for agencies to communicate and cooperate, shoring up each other’s initiatives, informing each other’s assumptions, programs, and procedures. And it is a matter of ensuring inspired Executive and Legislative mandates so that quality—of programming, planning, and people—becomes and remains an institutionalized expectation, not a pleasantly surprising exception.”

Within a number of agencies, there are Lewis-and-Clark-style expeditions into the wilderness of bureaucratic custom which, when it comes to design quality, has been a morass of avoidance, if not outright hostility. The Public Buildings Service of General Services Administration, which owns or leases the equivalent of 1,300 Empire State Buildings, has struck out on a design-competition approach (page 88), which is beginning to yield high-quality designs for the

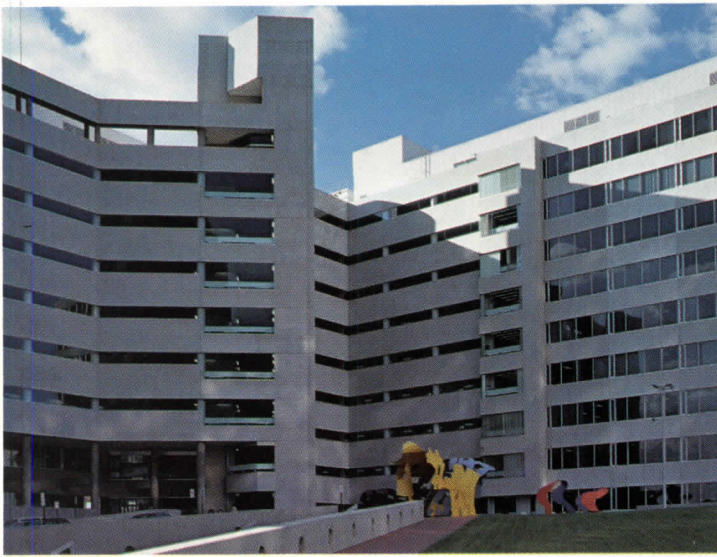

Richard Anderson

The Edward A. Garmatz Federal Office Building and U.S. Court House, by RTKL Associates (1978), is one of busy Baltimore's latest architectural blessings. Though Federal judges are not exactly effusive in their support of the idea that public buildings should indeed be open, lively places, RTKL's nine-story, V-shaped structure, folded around a courtyard and embellished with sculpture, manages to convey the majesty of the law while also creating a sense of imagination and invitation. There's some justice.

adaptation of old buildings and districts for a mix of governmental, cultural, and commercial life. This approach, GSA indicates, is also going to be used more frequently on brand-new projects—such as a projected office building in Savannah.

In this respect, the GSA, despite some last-ditch defenders of mediocrity, may be a jump ahead of other Federal agencies charged with construction—all of it adding up to \$20 billion a year. The Office of Management and Budget, which doesn't kid around, has an Office of Federal Procurement Policy, which is insisting that all agencies follow a similar procedure, selecting at least three firms from a "short list" to secure a range of preliminary designs—this for any building costing over \$12 million. Such a strategy is already pursued by the Department of Defense in getting the "best" jet, tank, or helicopter. If OMB has its way with this controversial circular, known as A-109, and if it follows up on its earlier one, A-95, which calls for "high quality urban design" as a basis for reviewing and approving grants to localities, the field of architecture could end up with one of its strongest supporters.

Any effort to improve the design of what the Government builds for itself must be matched by measures to improve the standards that are expected of projects *assisted* by the Government. As hefty as the direct construction volume is, assisted development and construction, such as that seen to by the Department of Housing and Urban Development, far outweighs what is done by the GSA or the Veterans Administration or the U.S. Postal Service.

The National Environmental Policy Act of 1969 (NEPA) gives a strong mandate to environmental design of an inter-disciplinary nature, and a well-armed regiment of design-conscious, law-abiding bureaucrats are beginning to call for its enforcement. HUD especially is trying to put it to work. This particular section of NEPA, 102 (2)(A), says that all agencies of the Federal Government must systematically use such an inter-disciplinary approach, integrating the natural and social sciences and the environmental design arts, so that planning decisions can have an enhancing impact on our environment, in whatever place, in whatever program or project, those agencies are putting their money. Of course, "strong mandates" are a dime a dozen, and this section of NEPA has thus far been followed mainly from the standpoint of developmental impact on natural resources. Urban environmental design is no less crucial to the over-all humanity and harmony of American communities, however, and this facet of the measure is steadily being strengthened as well it should be. One HUD official describes NEPA, what with everything else coming down the pike, as still the strongest handle for design quality that the Federal Government has.

So this is a time of great flux, and considerable in-agency griping, all around Washington. The agencies that have been used

to doing things their own way for years are facing the prospect of having to go the route of design competitions. This is particularly crucial at big agencies like the Veterans Administration, where officials insist competitions won't work given the highly technical, usually health-care-oriented projects it is responsible for. What is more, slogging away at the VA's construction and architectural sections, whose obligations will be \$400 million this next year, a number of dedicated in-house architects are trying, with all their might, to stir up some design innovation without having to be given a "mandate" to do so. Also, the VA, in its contracting arrangements with outside architectural and engineering firms, is loosening up its programmatic noose considerably, encouraging firms to be more imaginative in design and, lo and behold, more sensitive to community scale and locational qualities.

Still, the architectural designer who really cares—in the VA, and in most other agencies—faces a lot of dead-wood attitudes. One architect, working for a section of the Department of Defense, was designing a modest but graceful place of worship for some base somewhere. A superior asked why the nave had to be so high because, after all, it could be closed off and offices put "up there." No matter what agency one gets inside of, such anecdotes abound because architects, very rarely, get to be "up there"—meaning in top management, where their qualitative concerns can be folded into policy and procedure. This fact in turn discourages the best and the brightest from coming to work for the Government, even if they sincerely have a sense of public service and the good they might do.

Even so, there are lots of design "heros" slogging away in the bureaucracy, spiritedly, almost as if they were expecting that their often and eagerly professed dedication to quality were about to get (as it soon may) the imprimatur of official policy. Indeed, a national cultural policy, with great emphasis on design and facilities, is being readied for the President's announcement this month. The Denver Service Center of the National Park Service has been a long-standing source of thoughtful planning and design. The Department of Transportation has an embryonic but energetic design policy—a pioneering engine-to-caboose effort that came out of an inter-agency task force, and which has resulted in an on-going process of cross-referencing policy, programs, and procedures with their overall design ramifications. The Naturalization and Immigration Service is producing first-rate designs for the nation's border stations through an innovative, intense charette-style competition process. The U.S. Postal Service, The Corps of Engineers, the Department of the Navy's facilities section, the Bureau of Reclamation—scores of design professionals working with them—are clearly committed to a new day for architectural quality, even as, permeating their ranks, intellectual dinosaurs try to trample down signs of enlightenment.



Norman McGrath

The Federal Home Loan Bank Board in Washington (1977), by Max O. Urbahn Associates, is a real pioneer, wholesome and good-looking, in its inclusion of recreational features, commercial activities, and landscaped open space. It also has a nice neat fit with its surroundings, representing the relationship of the Government to the people with both spirit and subtlety. Representational overtones of a more staid, symbolic nature characterized public buildings in the earliest years of the Republic. The original U.S. Capitol (below), designed by Dr. William Thornton, refined and built by Benjamin Henry Latrobe, was, as it was meant to be, a Roman in the swamps of a new wilderness town—connecting a national adventure to the experience of history.

A lot of credit for this turnaround must go to the Department of Architecture, Planning and Design of the National Endowment for the Arts, and its Federal Architecture Project.

In the early 1970s, it set about to study, update, and put to work the original Guiding Principles for Federal Architecture, issued by President Kennedy in 1962. Under Bill N. Lacy, the Department's director until 1977, his successor Roy Knight, and the Federal Architecture Project's director, Lois Craig, a top-level task force, informed by an inter-agency liaison group, developed recommendations for the practical, evolutionary application of the Guiding Principles, began research on a history of the Federal experience in building (page 122), and fostered inter-agency teams of the type that finally yielded such policies as that now underway at DOT. Probably the most important accomplishment of this period was helping see through the passage of the 1976 Cooperative Use Act, which requires GSA to adapt existing structures of cultural, historical, or architectural significance whenever possible instead of building from scratch and, as importantly, to make provisions for community-oriented activities and amenities. GSA is moving in this direction. In many of its brand-new buildings, where some of the familiar hassles and hurtles and hell of working for the Government still exist, designs of a more comely nature, rich with innovation are also getting nailed down, built, occupied, and enjoyed (page 112).

One hears those architects, working within many other agencies, wondering how long it will take them to make *their* small step. "I feel something like that Beatles song—a nowhere man, making nowhere plans, for nobody," says one. Another describes the place and promise of a design-oriented architect in the agency he works for, "They have no idea what design is. There *is* a sense of public obligation—for me to get the drawings out, fast. Finally, they either turn you into a drone, or you become one of them, or you get fired." Even Benjamin Henry Latrobe, whom Jefferson appointed Surveyor of the Public Buildings of the United States, said, "Government service is a ruinous connection."

Yet architect Andrew F. Euston, Jr., the urban design program officer at HUD, sees the pains and the prospects differently. "Standing aloof, complaining about government, isn't going to get the architect one chip in this poker game. If the design professional has a claim, what is it? The claim is to be *part* of the broad spectrum of decision—to be an active resource, among many disciplines, so that leverage for quality is developed. We have the tool with NEPA, and more are on the way to fulfill its intent. From direct to assisted construction, the substance of design must be addressed as a matter of *law*." With that connection established, Thomas Jefferson's idea of Athenian taste can be the reality of a triumphantly human American environment. — *William Marlin*

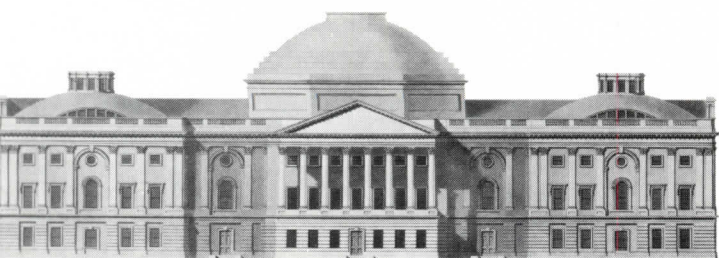
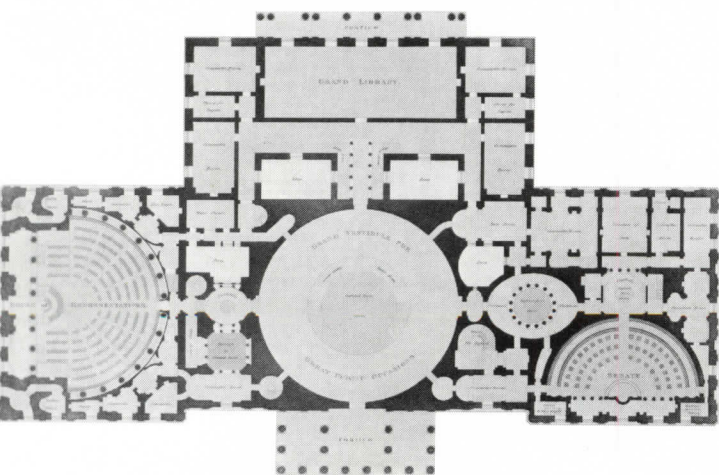

COMPETITIONS: IN SEARCH OF QUALITY

Design competitions are—and always have been—controversial. But if architects are willing to enter competitions (and it seems they are), the competition route is surely one of the cleanest routes to architect selection for Federal buildings—and, one hopes, one of the surest routes to design quality. So far, GSA's level 3's seem to be working. . . .

By Lois Craig

The GSA's new breed of competitions are called Level 3 competitions—Level 3 simply because the first step in architect selection, the review of credentials and experience has been, in GSA parlance, Level 1; and interviews of the short list of architects selected by regional GSA advisory boards has been Level 2. For a growing number of buildings, "consideration of alternative design solutions"—in short, a design competition among the short-listed firms—has become Level 3.

This is an important new emphasis—for despite the recent procurement scandals, the General Services Administration still sponsors the biggest and one of the best games around for architects. In Washington, St. Louis, New York and Nashville, the conjunction of the Level 3 competitions and Public Buildings Cooperative Use Act of 1976 (the Adaptive-Use/Mixed-Use Act) portend a new look in Federal architecture and in the giant agency's way of doing business.

Today, in a very public, town-meeting setting—architects are presenting their ideas and designs for adapting old buildings to mixed Federal and commercial use. Citizens view what *can* be. Critics write favorable reviews. RECORD devotes this issue to Federal architecture. What ever happened?

Government has gradually been accommodating public demand for more access to both its procedures and its places. In 1969 the National Environmental Policy Act challenged traditional practices of Federal public works construction and offered enormous opportunity for citizens to influence government actions. Recent legislation for freedom of information—the "Sunshine Act"—furthered the elimination of barriers. And the Public Buildings Cooperative Use Act, passed by Congress in response to recommendations of a task force on Federal architecture ap-

pointed by the National Endowment for the Arts, opened Federal buildings to commercial and cultural uses to combat the deadening effect of large office buildings in urban areas. The act also encouraged acquiring and re-using historic and architecturally interesting buildings for public use.

This summer President Carter affirmed his support of the Cooperative Use Act in an Executive Order on Federal space management. The Order repeated the calls of his predecessors for the collaboration of Federal programs with city improvement efforts, but in a markedly different context. For the first time in history the Administrator of GSA routinely attends Cabinet meetings and serves on White House advisory groups—acknowledgement of the important role of his facilities and purchasing power in urban development.

The Old Post Office in Washington, D.C. (pages 97-99) is the first of a new breed of Federal buildings that embody these trends. For the mixed re-use of the sturdy turn-of-the-century post office, the General Services Administration last year held a Level 3 design competition. Each team participating in the design competition was paid a stipend of \$46,000. The program incorporated both the adaptive-use and mixed-use provisions of the Cooperative Use Act.

GSA has subsequently paid comparable stipends in Level 3 design competitions for remodeling a 19th century post office in St. Louis (pages 88-90) and for soliciting initial redesign schemes for the Federal Triangle in Washington, D.C. (pages 91-93). Competitions and multiple-use programs are also being used for the Custom House in New York City and Nashville's Union Station. Level 3 presentations for the Nashville project were held in Nashville on November 2. Finalists' presentations for the New York Custom House have been delayed indefinitely because GSA has not yet received prospectus approval from the House of Representatives. Nashville is the first of several projected adaptations of urban railroad stations for joint Federal and commercial use. Other stations prominently considered are in Kansas City, Missouri; St. Paul, Minnesota; and Montgome-

Lois Craig, former director of the Federal Architecture Project for the National Endowment for the Arts, is author of *The Federal Presence: Architecture, Politics, and Symbols in United States Government Building*. This article was prepared for RECORD as part of her work as a Design Project Fellow of the National Endowment for the Arts.

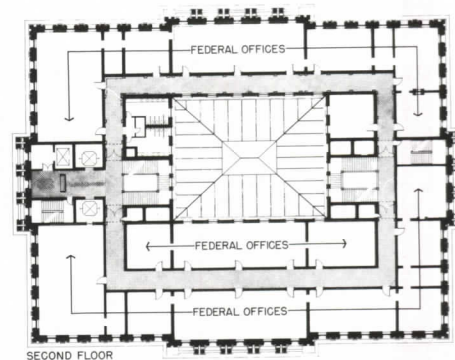

SECOND FLOOR

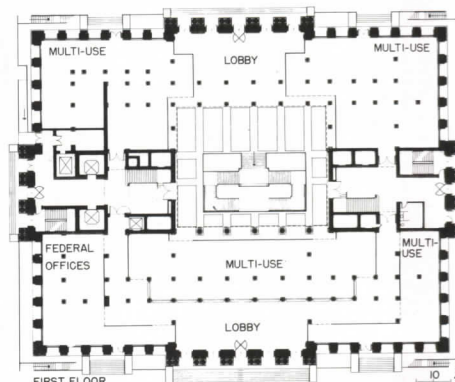

FIRST FLOOR

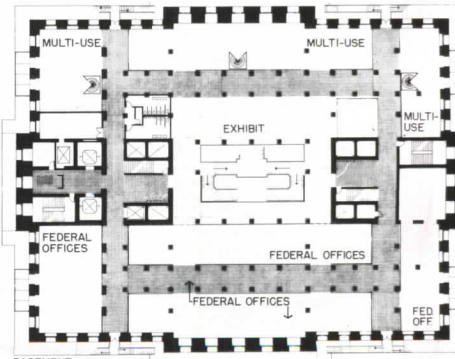

BASEMENT

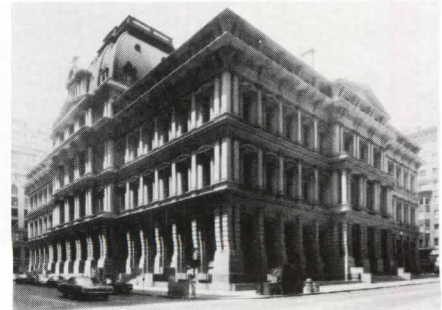

POST OFFICE AND CUSTOM HOUSE ST. LOUIS, MISSOURI

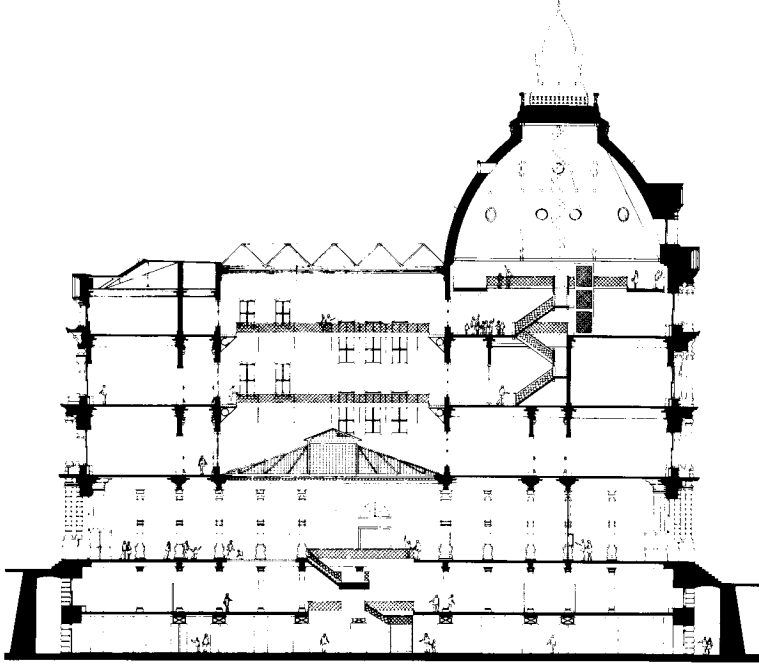

The winning proposal for adapting this grand structure—designed by the U.S. Supervising Architect Alfred B. Mullett, completed in 1884—is by Patty Berkebile Nelson Associates/Harry Weese & Associates. Their basic approach involves removing all additions since 1884 that do not directly bear upon the esthetic integrity and functional efficiency of the building; restoring missing or mutilated elements that were basic to Mullett's artistry and ingenuity; and inserting new elements only to meet contemporary functional stan-

dards, doing so in such a way to minimize physical and visual disruption of the original. Out of a projected 200,000 square feet, about 25,000 is given over to commercial or cultural space. The existing skylight, hovering in the big light-well, is to be restored. Up over the light-well, a new insulated reflective- and clear-glass skylight is to be constructed. Thus the light pouring in will once again be introduced to the deeper, lower levels where, by way of this adaptation, balcony-like esplanades and staircases will heighten appeal.

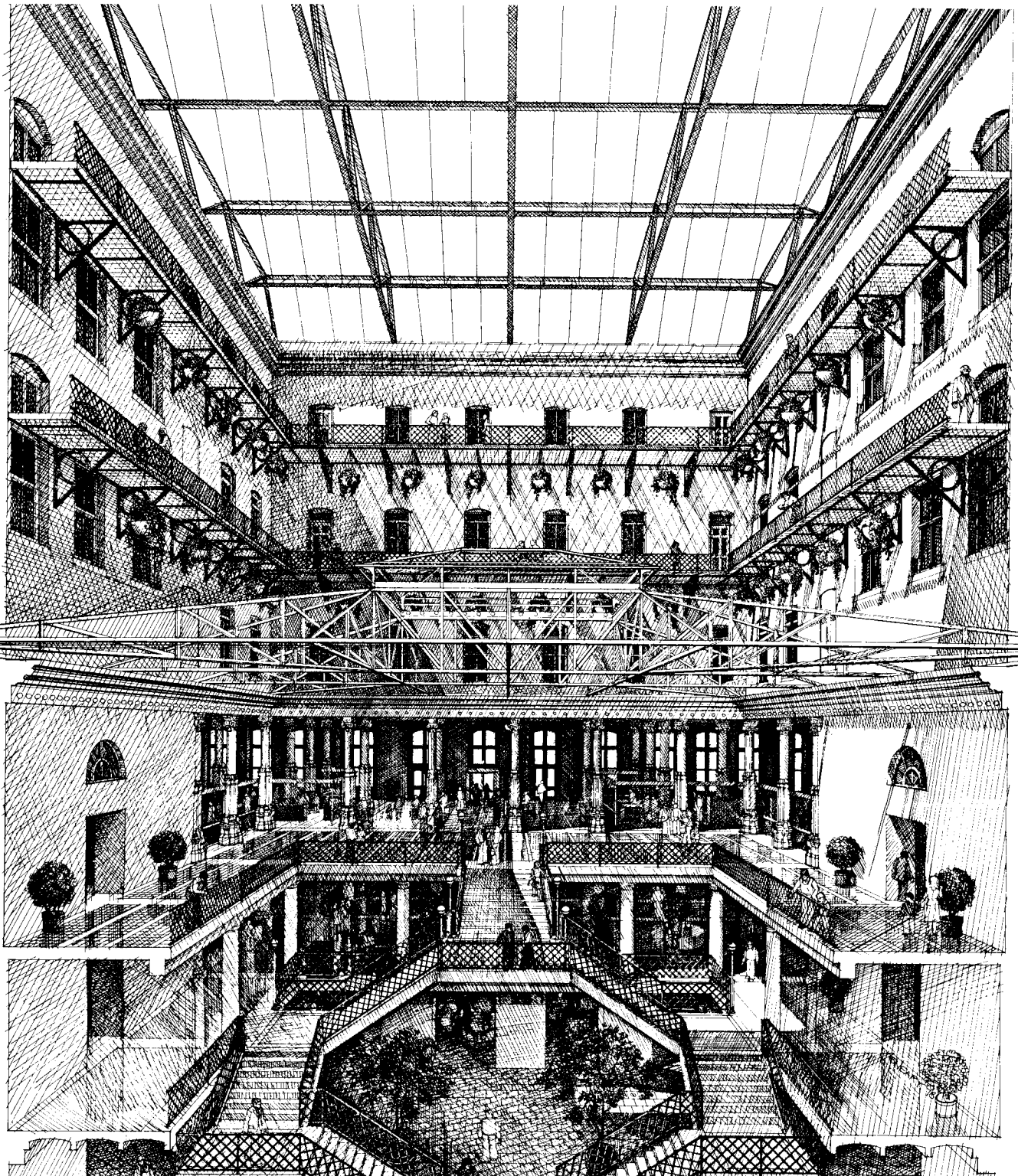

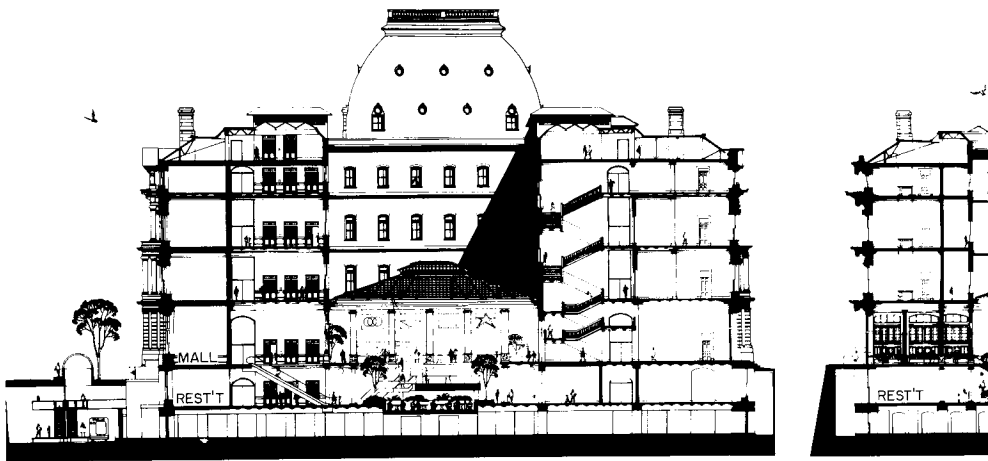

ry, Alabama. The first Level 3 competition for new construction was recently announced for a \$21 million Federal office building in Savannah, Georgia—after an unsuccessful attempt to find an adaptive-use candidate for that community. The current GSA budget mirrors the popularity of preservation: dollars for repair and alterations are more than double those for new construction, a striking change since the mid-1960s.

In the competitions held so far, the entries are diverse and imaginative

And, despite bruises, losers and winners continue to enter the new arena. The most struggle, the most adverse criticism, the most laudatory celebration surrounded the first demonstration, the Old Post Office in Washington. Particularly for this competition at the center of Federal power in Washington, the audience and attention were as high-level as you can get for a Federal building. In hindsight, it seems inevitable that the most spectacular entry would win whatever the price. And the winning entry did in fact so far exceed the stipulated budget limit that complaints about unfairness were justifiable. Solar collectors have since been eliminated to accommodate real available dollars. Architects, of course, have always risked breaking competition rules to capture the imagination of a jury; and juries have risked ignoring their own restraints to get the design or designer they want. The question endures of how much is too much—until a real building redirects critical attention.

In the next competition, in St. Louis, GSA took a tighter look at budgets. Reportedly, GSA also tightened deliberation procedures. Local interest in St. Louis ran high and some objections were made to suggestions in the press that the community would not tolerate an intrusive transformation of the historic building. The most radical solution did in fact, lose—for whatever reason. But public sessions can make the jury more responsible and, as one losing competitor suggested, subjecting a jury to local lobbying is a reasonable side effect of a public process in a democracy. Not surprisingly, the losers in this competition objected to traveling a long way

One of the two runners-up for adapting the St. Louis Post Office and Custom House is the team of William B. Ittner, Inc./Kaplan/McLaughlin/Diaz. Their design approach stressed careful, nonintrusive renovation or restoration, and the need for user-oriented, highly flexible office spaces. Structural elements of the existing building would have been retained, compatible with their original uses, but also the introduction of new functional or technical requirements would have been considered worked in to create a smooth seam between the old and new. As in the winning scheme, this one retains and restores the skylight in the

light-well, though the stair circulation in the lower ranges of this zone, with one terrace leading gradually up to another, indicates quite a bit more ebullience of space and effects than the chosen scheme, which is comparatively stately. This runner-up also placed a good deal of emphasis on the building as a focus for the on-going revitalization of downtown St. Louis. The provision of shops, as proposed on the lower levels of the adapted building, would visually tie into a proposed mall along Locust Street, just outside, and the architects further pointed out that an old tunnel along the Eighth Street foundation (once used for delivering valuables





and bullion) could well tie into the projected mass transit system for the area. Like all the finalists in this competition, this team discussed economic ramifications as much as esthetic and historical justification, re-evaluating the commercial possibilities of the adapted structure to the larger momentum building up in its neighborhood. As to strict requirements for office space, this design would have augmented existing resources by using heretofore unused spaces, such as placing a floor of offices under the roof eaves. The refurbished central light-well, ebullient in its space and effects as indicated, would have served primarily as a museum of sorts.

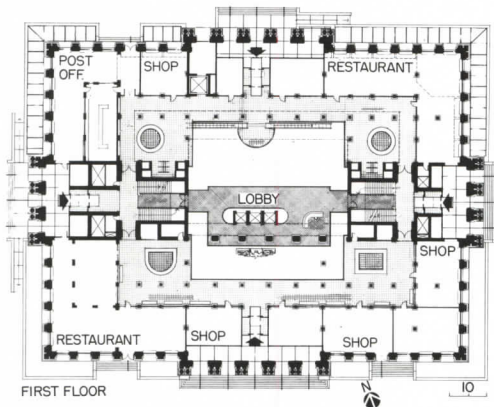
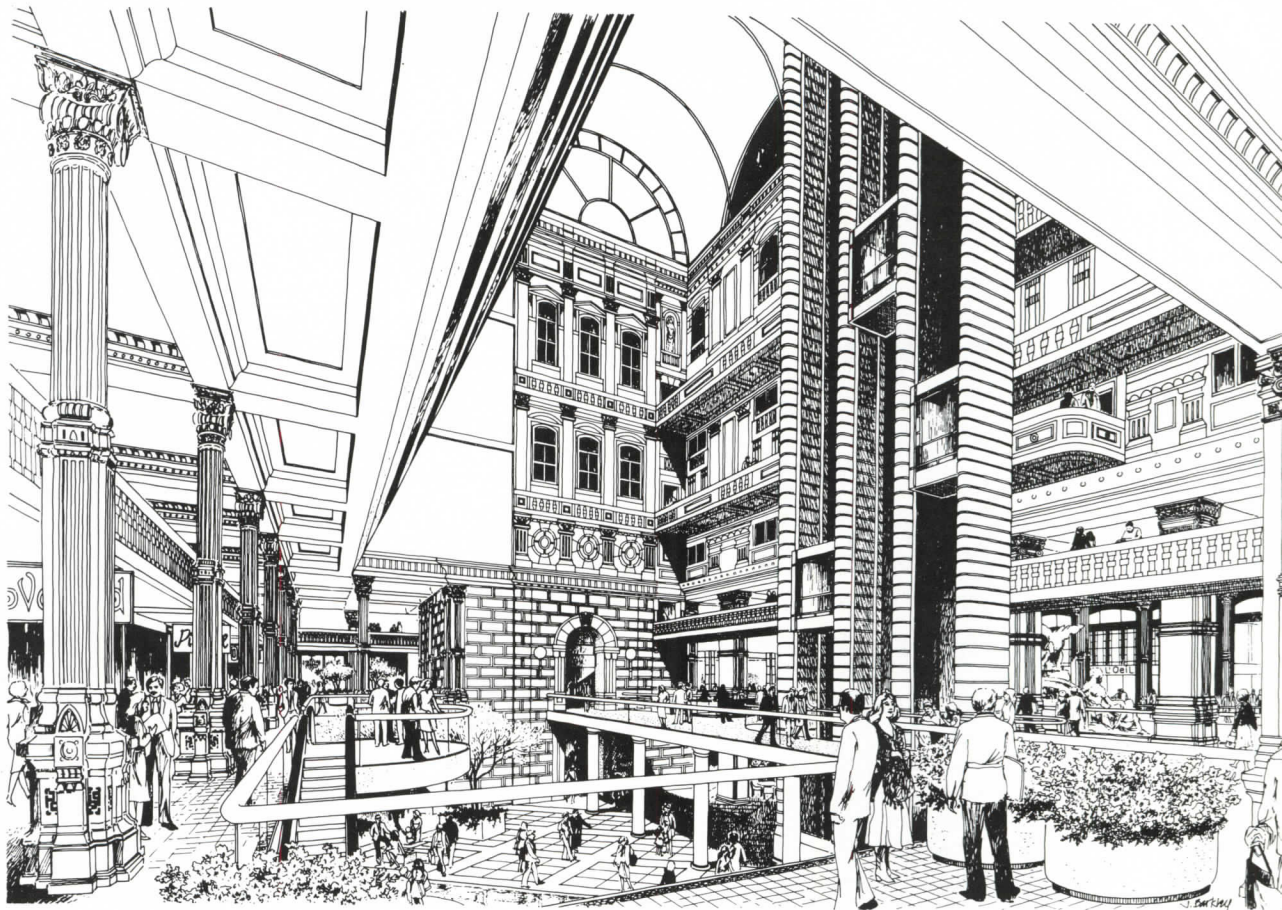

Another runner-up was the team of Eugene J. Mackey & Associates/Anderson Notter Finegold Associates. This is at once a complex and intriguing interpretation of Mullet's original mutation of Second Empire and Victorian elements. This team would have restored the superimposed orders and classical frontages of the exterior completely. But it is inside, that great light-well, where "historical recall" was given a real challenge. The south parti of the interior

would have pursued restoration of features with almost archeological thoroughness—much as the first two teams did throughout. But the north parti, facing the entrance from the proposed Locust Street mall, renovation and marked functional and visual modifications would have been made—witness the embellishment of this zone with "new" superimposed orders, recollective of the orders of the exterior, and the installation of exposed elevators.

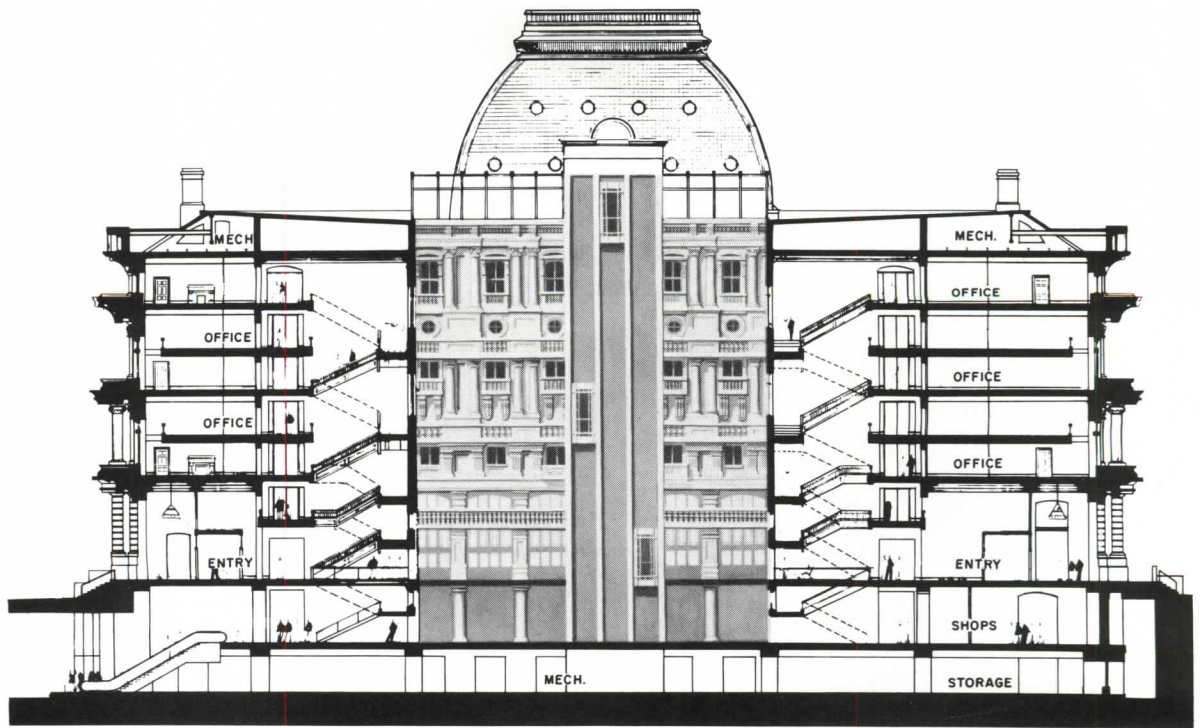

to learn of their loss at a celebrity-packed luncheon.

Competitors in the first three GSA-sponsored competitions most frequently criticized the plethora of unnecessary mechanical and structural requirements, the emphasis on the problematic, and the inadequate representation of urban real estate and design experience on the in-house GSA juries. With few exceptions Level 3 competitors report they are spending approximately double the allowable GSA competition stipends. But they also acknowledge budget-breaking is not uncommon for architects in the heat of competitive fever. In this case, how much is not enough?

Compared with the unruliness, chicanery and error of early Federal competitions, the new GSA procedures are models of propriety and order. When it came to designing a Capitol for the new nation, Thomas Jefferson displayed no qualms about influencing competitors nor about choosing a winner who did not abide by the stated requirements. Further, a disgruntled loser was named to supervise construction; and redesign became a continuing process. A design competition in the 1850s for a Federal Custom House at Charleston, South Carolina provoked a competitor to complain to the President that "the adoption of parts of the four leading designs—namely the Ground Plan of Mr. Norris, The Front Elevation of Mr. White, The Back Elevation of Mr. Hammer-schold, and the Portico and Dome of Mr. Jones—was done simply to conciliate the four architects and to neutralize the position of myself by having the unanimous vote of the Commissioners." Added to the complaint were accusations of corruption and immorality. Back in Washington the combination plan was scrapped, and the building was completely redesigned in a government architectural office. Proving winners can be losers, the premiated architects for the Library of Congress were ruined economically by the changing demands of their client and a prolonged unsuccessful legal struggle to get Congress to pay them. From the very first competitions, politicalization has permeated the process, cramping style and hiking costs.

So competitions are not just controversial today—they have a controversial history

Design competitions are widely used for public buildings in Europe. In the United States, the Department of Defense buys alternative designs before making commitments to expensive new systems—from missile hardware to housing for the Volunteer Army. But in recent decades the architecture profession and Federal administrators have resisted design competitions for civilian buildings. The very mention of the word "competition" provoked fears of dreaded price competition, which, in fact, became a troublesome specter floating out of the 1972 work of the Commission on Government Procurement. Responding to the profession's alarm, Congress passed the Brooks Bill, which codified thirty years of government practice by exempting architects and engineers from the usual Federal convention of competitive bidding. Although the Brooks Bill made by-the-way mention of design competitions, any attempt to debate seriously the values of design competition among Federal or AIA representatives was treated as dangerous or daft: "Too wasteful of time and money," "crazy architects could win," and, worse, "impossible schemes might be adopted." The American architectural profession has long officially endorsed and effectively opposed the use of design competitions. Historically, however, shifting considerations have ruled. The American Institute of Architects, formed in the mid-19th century, took a stance in opposition to design competition: "a sorry subject for the architect. It burns the fingers of those who meddle with it," said an early AIA president. But even back then "it depended." The Institute also actively promoted legislation to initiate competitive selection of architects for Federal projects as a means of getting private architects in on the growing workload of the government's Office of Supervising Architect. The justification was that the efficiency and quality of government work were inferior to standards maintained in private offices. Government architects designed both the St. Louis and D.C. Post Offices currently being restored by GSA.

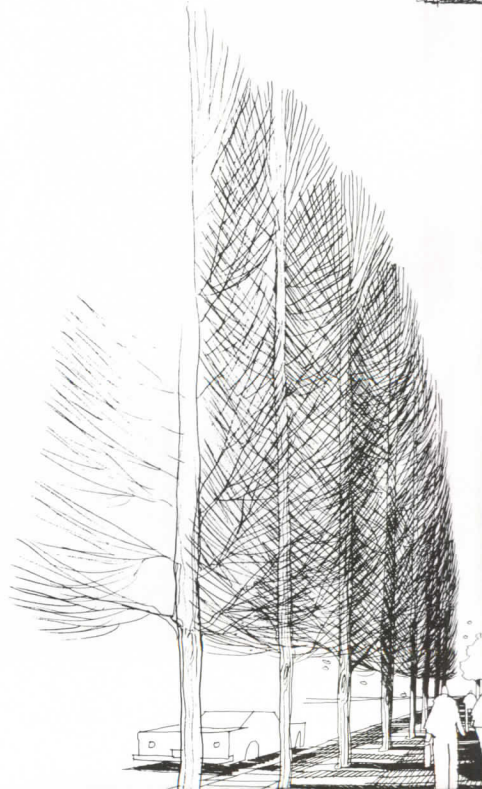
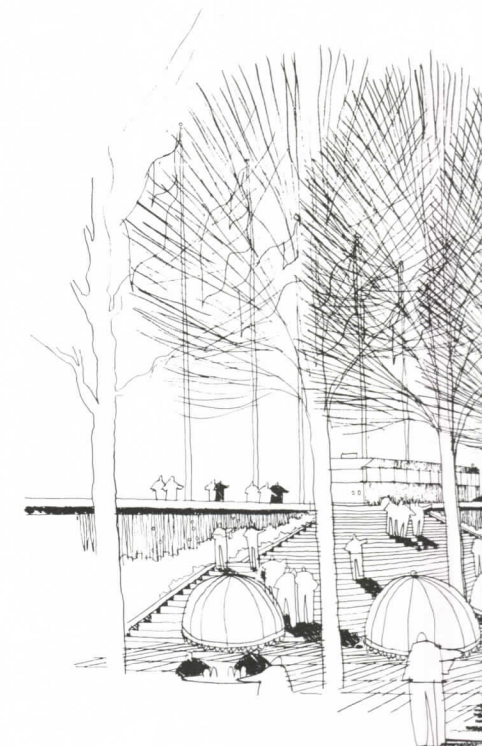
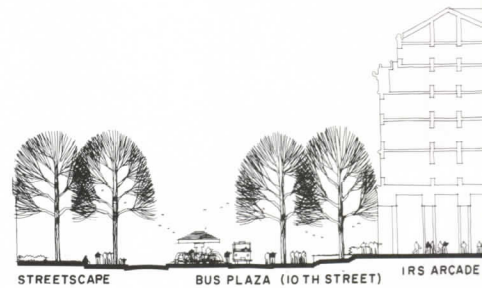

FEDERAL TRIANGLE, WASHINGTON, D.C.

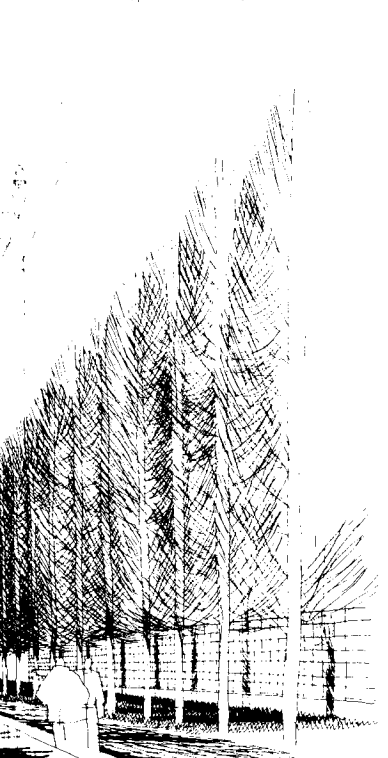
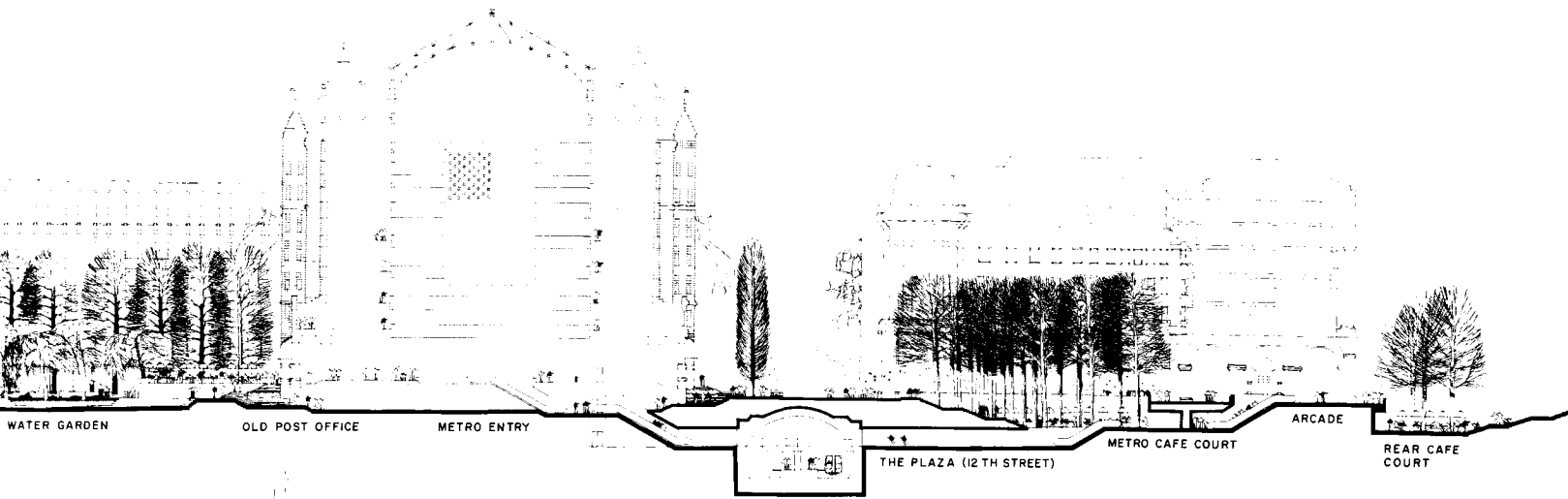

Designed in the 1930s by a Board of Architectural Consultants, answerable to Secretary of the Treasury Andrew Mellon, the Federal Triangle is a neo-classical mish-mash, never completed, with many mislaid or misfitted parts—but an area full of potential for interlacing the activities along its northern edge, Pennsylvania Avenue, and its southern edge, Constitution Avenue and the Mall. Until recently, making any human, cultural, and urbanistic sense out of the Triangle seemed tantamount to doing an adaptive re-use scheme for the Great Wall of China. The

real prod to GSA in getting a Federal Triangle competition underway was the earlier (and very first) one held for the Old Post Office on Pennsylvania Avenue (pages 96-99), the results of which pointed up the truncated, even truculent nature of the adjacent Triangle district. Of the three finalists in this competition, one will soon be designated to carry out a master plan for the Triangle as a whole, even as adaptation of the Old Post Office is already starting up. Whoever "wins," the synergism of styles and scales, activities and amenities, promise one of the more

profound exercises in urban design seen in the 20th century. Not only does the Triangle project account for the retention of the Post Office, but also the Municipal Building of 1908; further, it will tie into new subway stops and dramatize the provision of public attractions and commercial activities as embodied in the landmark Public Buildings Cooperative Use Act of 1976. The "promise" shown here is by Sert, Jackson/Jerome Lindsay, in association with The SWA Group and Monacelli Associates, urban impulses are given elbow room.

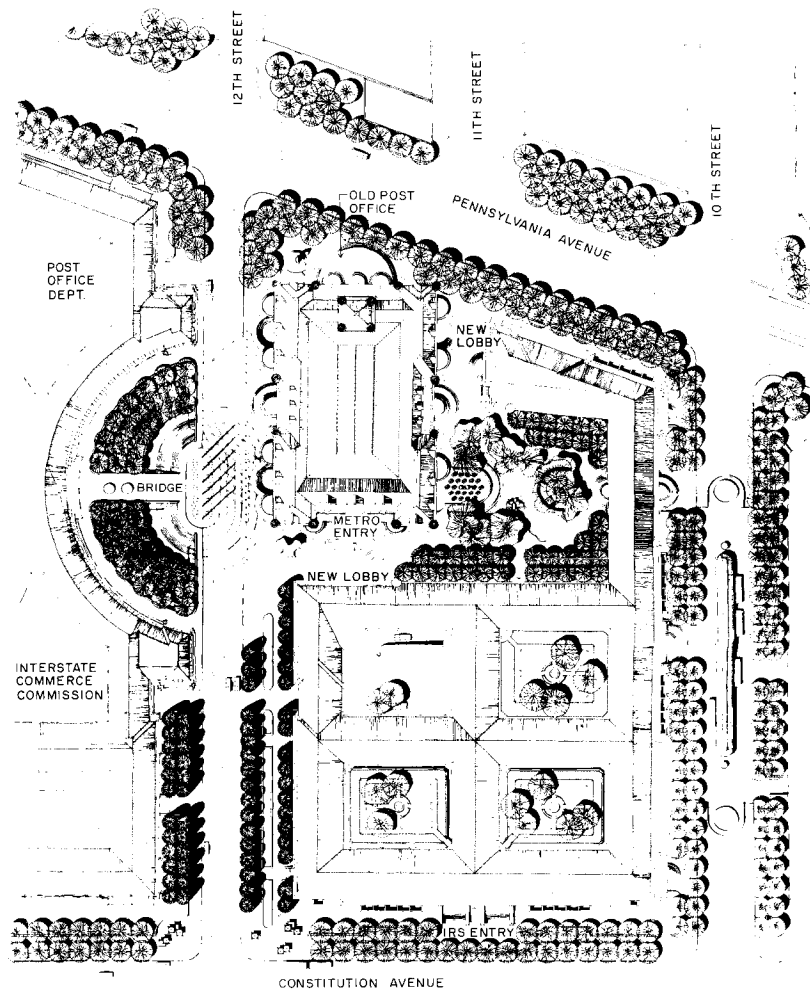

struction and life-cycle cost estimates; and planning and design concepts." An interagency advisory study group fleshed out a sequence of three levels of solicited information, including final "project proposals." Although the study group favored the use of project proposal level for new construction, it was first used as a "Level 3 design competition" for the Old Post Office in Washington.

Money and time are legitimate concerns of both government and competitors

How can the costs of the new design procedures be defended in the face of Proposition 13 sentiments for tax-cutting and concomitant budget-cutting? Substantial costs are inherent in any selection method, but comparisons are complicated by the difficulty of estimating the real costs of less visible practices.

How much of the government's time, for instance, is required in travel, meetings and evaluations to bring a conventionally commissioned design to the depth of detail of Level 3 presentations? Indeed, from these presentations the government acquires not only the ideas and expertise of the winner but the usable expertise of the losers. In the analyses of commercial marketing requirements for mixed use this information clearly fills a considerable gap in the government's own experience. And arguably, the money for a design competition is a better investment than a work of art, which has very little chance of overcoming the bad design of a building.

Other public competitions in recent years suggest that the competition route can result in lower cost than the commission route. In 1962, Percival Goodman wrote that "for something less than \$60,000 Boston secured preliminary design (for City Hall) that surely would have cost half a million dollars had they been commissioned in the normal way." In an invited competition for the Volunteer Army barracks, the Army Corps of Engineers incurred costs well below those of conventional architect/engineer selection procedures. In a small, low-budget experiment jointly sponsored by the National Endowment for the Arts and the Immigration

and Naturalization Service, six firms participated in a one-day interview/sketch competition with a program received the same day, which resulted in selecting a more design-oriented team than the initial Form 254 review suggested.

On the other side of the equation, how much of an architectural firm's senior time is devoted to personal, if legal, influence of potential clients? Like the use of time to influence potential clients the decision to exceed a competition stipend is a business decision. With no limits on allowable competitive endeavor or with unrealistic stipends the danger exists, of course, of eliminating small offices from the game. These concerns can be tempered by the knowledge that young and unknown designers have often given a lot of financially uncompensated time to becoming known.

Critics agree the GSA competition could be markedly improved . . .

. . . in cost as well as other regards, by eliminating redundant requirements and paring visual elaboration to essentials. Programs, sometimes seemingly done cut-and-paste by regional GSA offices, need to be translated into coherent architectural language more compatible with the demands of the design competition. More experienced and design-oriented juries with reliable technical support as well as postcompetition jury reports that note positive achievements of competitors could contribute to a more stimulating encounter between the private architect and the Federal agency. Public perception of the fairness of the process would be improved if the jury announced and defended its choice rather than passing the final decision on for an indeterminate time to the Administrator.

The issues of architect selection and programming cut across all government building activities. At the very least, they are matters for administrative concern for the twenty or so Federal agencies with major construction responsibilities as well as for state and local agencies. At the most, they go to the heart of the issue of quality. Even casual exposure to media coverage of the past decade provokes serious concern about

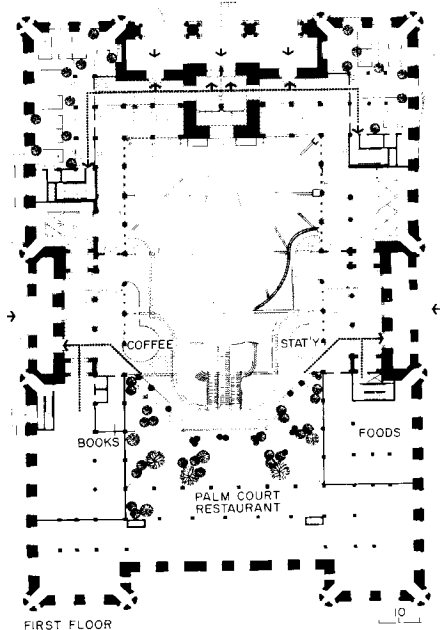
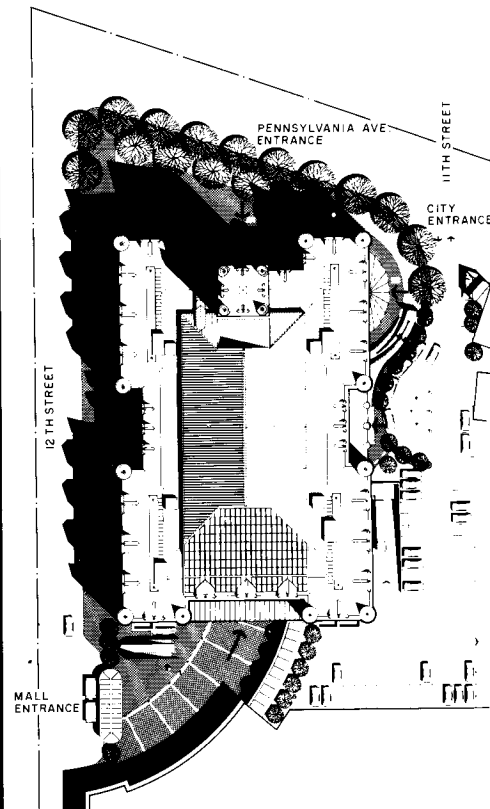

BENJAMIN FRANKLIN POST OFFICE WASHINGTON, D.C.

The winning proposal for the adaptive re-use of the Benjamin Franklin Post Office—the first of the Level 3 competitions held by GSA—was done by Arthur Cotton Moore & Associates, teamed with Stewart, Daniel, Hoban and Associates, McGaughey, Marshall & McMillan, and Associated Space Design, Inc. This is the project, now in construction, that got the whole Level 3 process perking, and the result in turn generated interest in using the process for the entire Federal Triangle (pages

92-95). The Old Post Office, as it is commonly referred to, was completed in 1899 to the design of W. J. Edbrooke, the U.S. Supervising Architect of the period. From the time it was completed, it was scorned, even by the likes of Cass Gilbert, who disliked it not for its style (sort of Gothicized Romanesque) but for its “undue height and excessive prominence” relative to the lower scale of Washington. One senator criticized it as a cross between a cathedral and a cotton mill. In the 1930s, its

presence on Pennsylvania Avenue impeded completion of Secretary of the Treasury Andrew Mellon’s Beaux Arts extravaganza, the Federal Triangle. Well, the 1970s changed all that, and the Moore scheme dramatizes that what is thought of as frightening in one century can turn out to be fashionable, certainly fun, in the next. Moore has left the metal frame of the light-well skylight intact, a metaphor for the filigree of commercial, cultural, and Federal office space that will interlace the building.

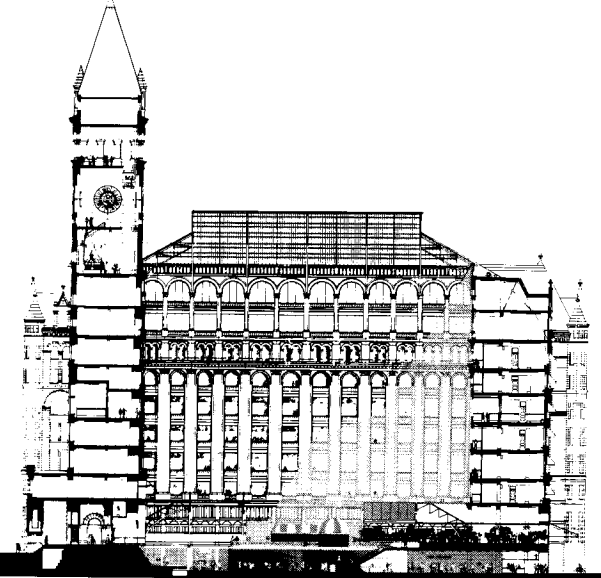

10

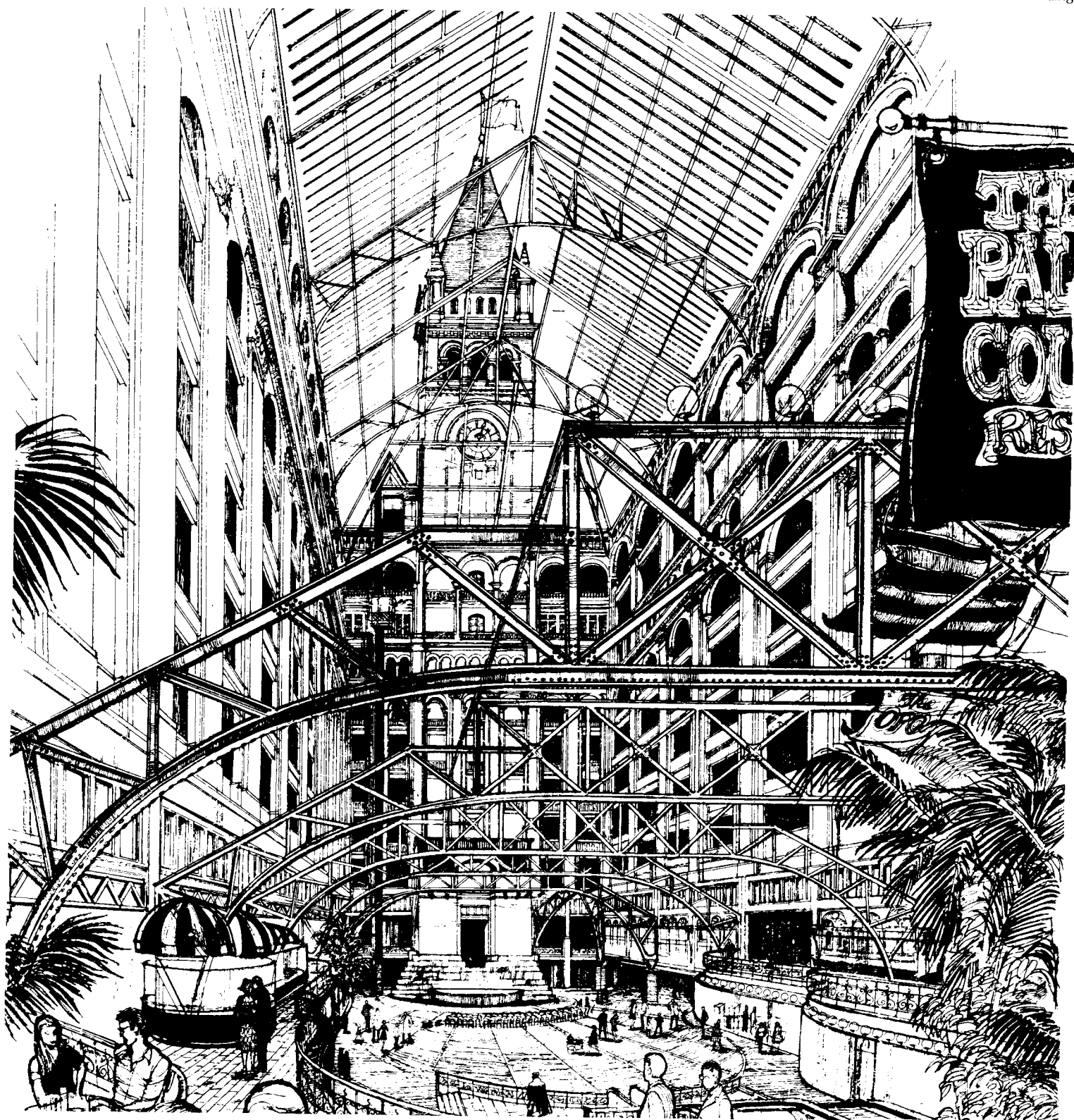

One of the two runners-up in the competition for the Old Post Office was the firm of Faulkner, Fryer & Vanderpool. This is a staid scheme, compared to Moore's winning one, but has a simplicity and splendor worthy of serious study in the context of the adaptive-re-use ethic generally. While Moore's solution is a "moveable feast," surfeited with spatial, structural, and commercial goodies, this scheme serves up, with great propriety, a banquet served by attendants in white gloves. Which works, in terms of its own premises, and invites the question as to whether adaptive re-use must invariably be an occasion for frolic.

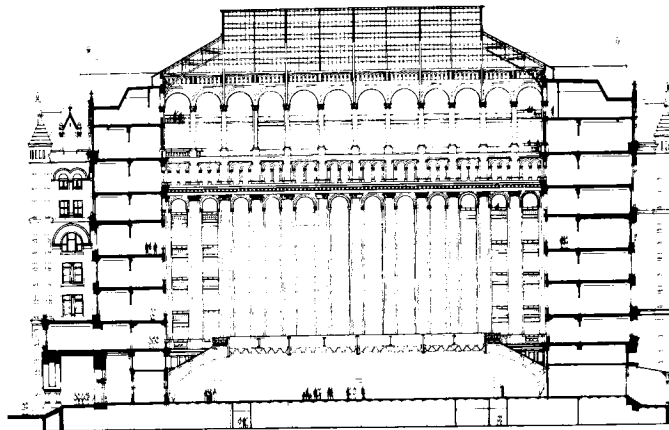

traditional in-house procedures. Rigid adherence, by government and private groups alike, to static procedures or positions on competitive negotiation, design competition, whatever can only encourage the possibility of rigid remedies favorable to no one.

The deficiencies of the sponsors of the current Level 3 design competition and the disappointments of the participants are legion. But the criticism is, in sum, surprisingly constructive. Competitors and sponsors alike acknowledge that focusing the building process on design has brought a long-missing excitement to Federal architecture. If supported and varied and reformed, public design competitions could be a powerful force for change.

The questions for the future are whether GSA is committed to experiment . . .

. . . with variations of the Level 3 competitions; whether for projects of different purpose and scale it will explore less elaborate approaches used by other public agencies here and abroad; whether new construction can attract (and surely it can!) the high-level attention that more trendy preservation projects now command.

With Congress in mind, the ultimate question is whether the impetus for new approaches in any of the construction agencies can endure in the face of inevitable failures and setbacks. Experience suggests that balancing and fine-tuning are not endemic to the huge and traditionally recalcitrant GSA. A lot of impartial outside criticism, review and support will be needed to undergird the new directions of Administrator Jay Solomon and his small band of sympathizers within GSA. What could be the role of independent agencies like the National Endowment for the Arts, which has garnered considerable respect for its experience in Federal design, the Council on Environmental Quality, the White House itself? Where is a thoughtful government-wide design awards program now that we need one?

This is a challenging time; the momentum must not be lost. "Literature describes us," Frank Lloyd Wright said, "but architecture presents us." What is our next act to be?

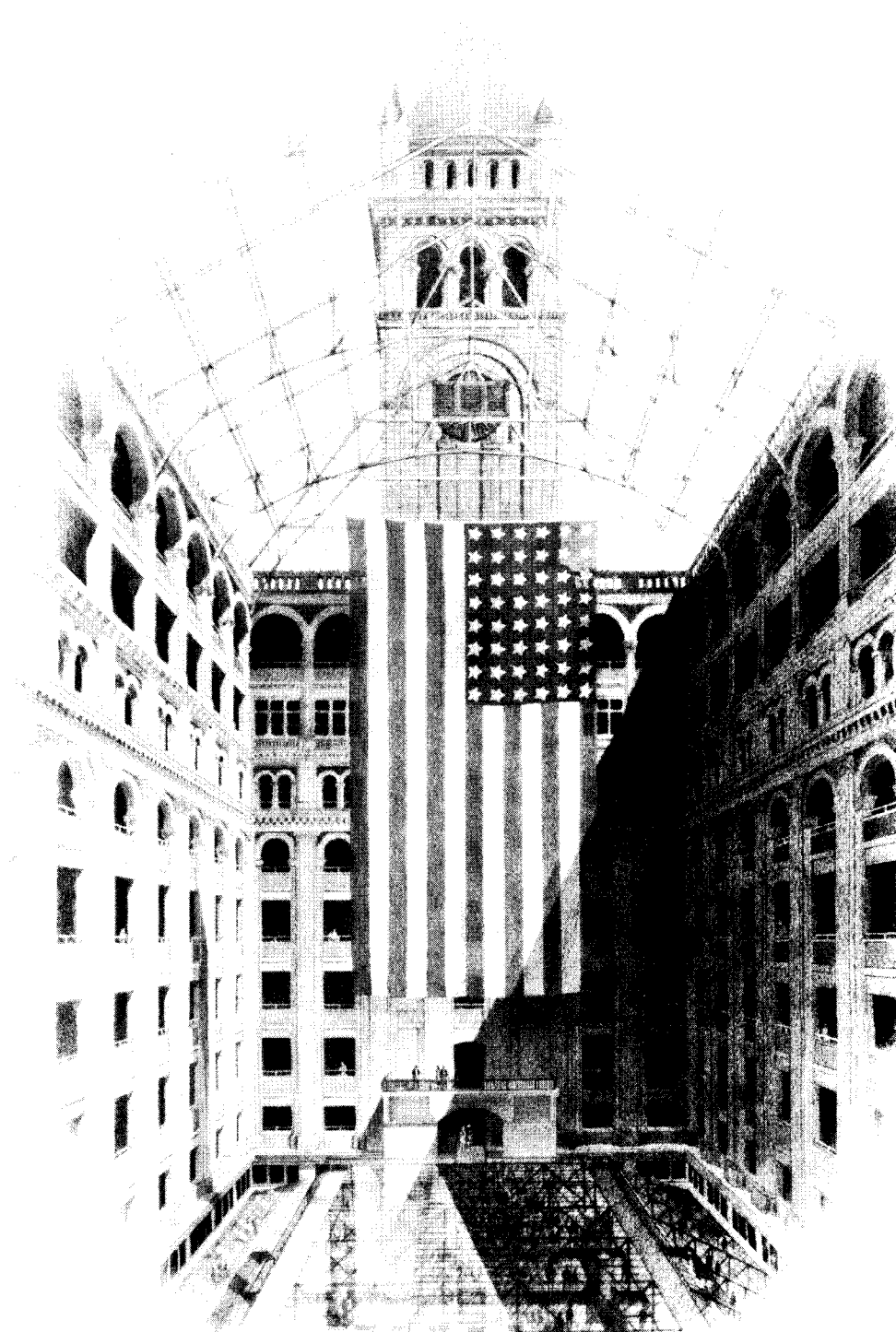

The Faulkner, Fryer & Vanderpool proposal would have restored the glass in the cast-iron frame over the old mail-sorting room, which would have become an exhibition hall of some stateliness, although without the enthralling upward movement of the cortile as occasioned by the Moore design. The space edging the cortile would have been given over to shops, a restaurant, entrance lobbies, and assorted support services—the exhibition hall in effect being one large, contained room clearly edged by, but separate from, the other activities. The offices on the nine levels rising up around the big space offered a direct but delightful layout.

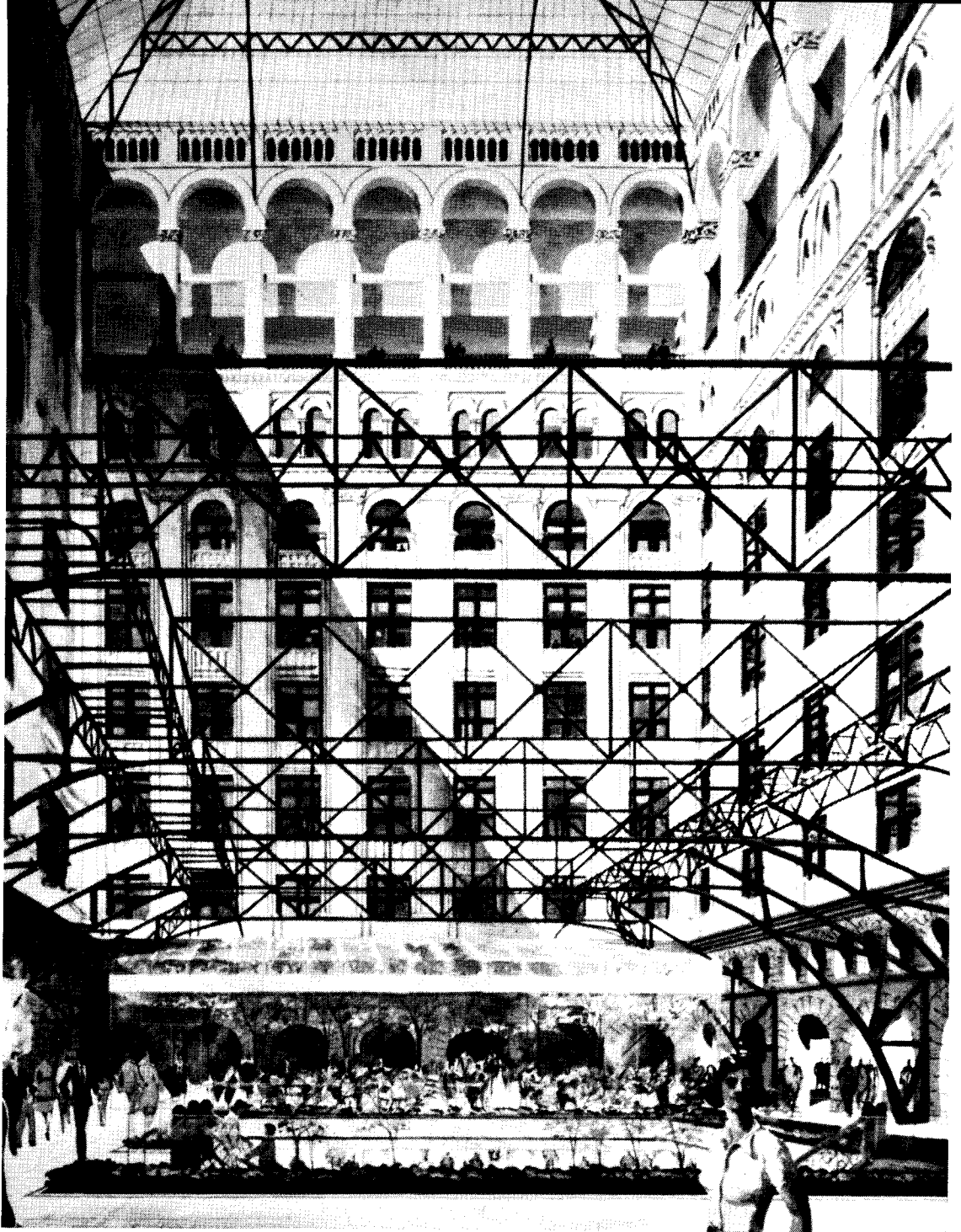
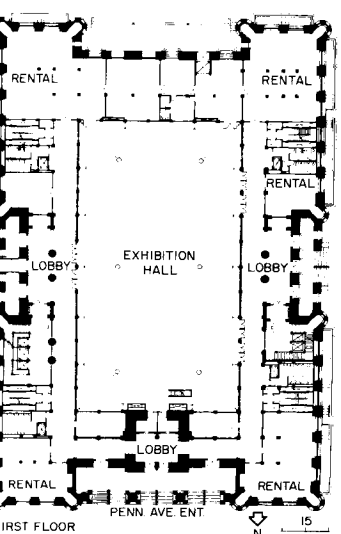
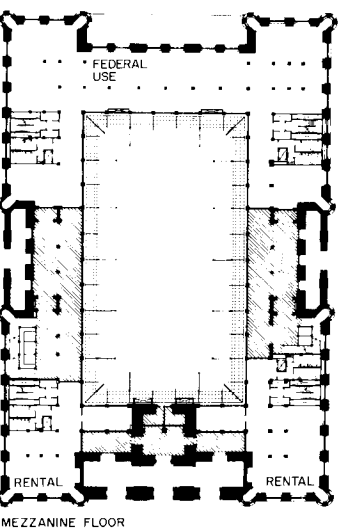

This runner-up proposal—by Shepley Bulfinch Richardson and Abbott, Hugh Newell Jacobsen, and Desmond and Lord—brings the physical and historical fact of the building's Romanesque entry arches right inside, surrounding the cortile, and would have created a continuous screen of "new" arches around the first floor, thus both blending the elements of the facade with those of a cohesive, if cavernous room (a blending the building originally never had). As in the other schemes, the frame of the skylight over the old mail room has been retained, but there is a more deliberate effort here to make of the cortile a true urban garden. If, as GSA has stated, this competition approach is a "learning experience," all three finalists in this project have taught valuable lessons.

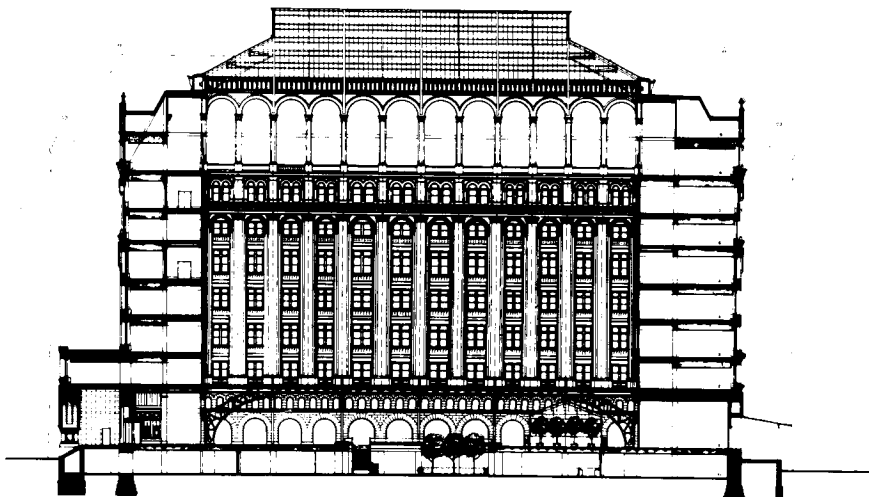

A NEW LANDMARK CENTER FOR ST. PAUL

Another way that the Federal Government is trying to support the cause of architecture is by giving its buildings away—by dramatically easing the procedures for transferring handsome but no longer needed buildings to local authorities who promise to bring them back to life. The Old Federal Courts Building in St. Paul, Minnesota, is one of the first in what may become a long string of renovative successes under this plan.

In 1971 former President Nixon signed an Executive order that directed the General Services Administration to provide leadership in maintaining the historical and cultural environment in the United States. GSA, in other words, was to become a preservationist, and it was asked to begin at home by surveying its more than ten thousand buildings to single out those of special historical and architectural worth, nominating the ones it found to the National Register. Very shortly thereafter, the GSA established its Office of Fine Arts and Historic Preservation, and, most importantly, it drafted and sponsored a Surplus Property Act Amendment (Public Law 92-362), which was passed by the Congress in 1972.

This was the stitch in time for a growing and growingly frustrated band of city officials and private citizens in St. Paul, Minnesota, who had been trying for years finally to implement a plan to put the Old Federal Courts Building back to some good use. The building had been a centerpiece in the architecture of downtown St. Paul, and as downtown had decayed over the years so had the centerpiece, so that when the Federal government moved out in 1965 the Old Federal Courts Building was a sorry shadow of its former self. But if the building's decline had paralleled the decline of the downtown, why should not the reverse also be possible, with a renovation of the building serving as a symbol for the revitalization of a whole area? Besides, it was handsome, and it also contained a great deal of space that could be put to some good use.

The problem was in finding the precise use, finding the money, and—above all—finding the way to meet the government's stringent requirements for transferring the building to local hands. Until 1972, the Surplus Property Act provided that, once a building had been declared surplus, it could either be sold for its appraised price to anyone or it could be given away to some non-profit, non-revenue-producing group whose activities benefited the general public. But a further condition of this latter possibility was that the group in question would also be subject to the detailed approval of either the Department of Health, Education, and Welfare or

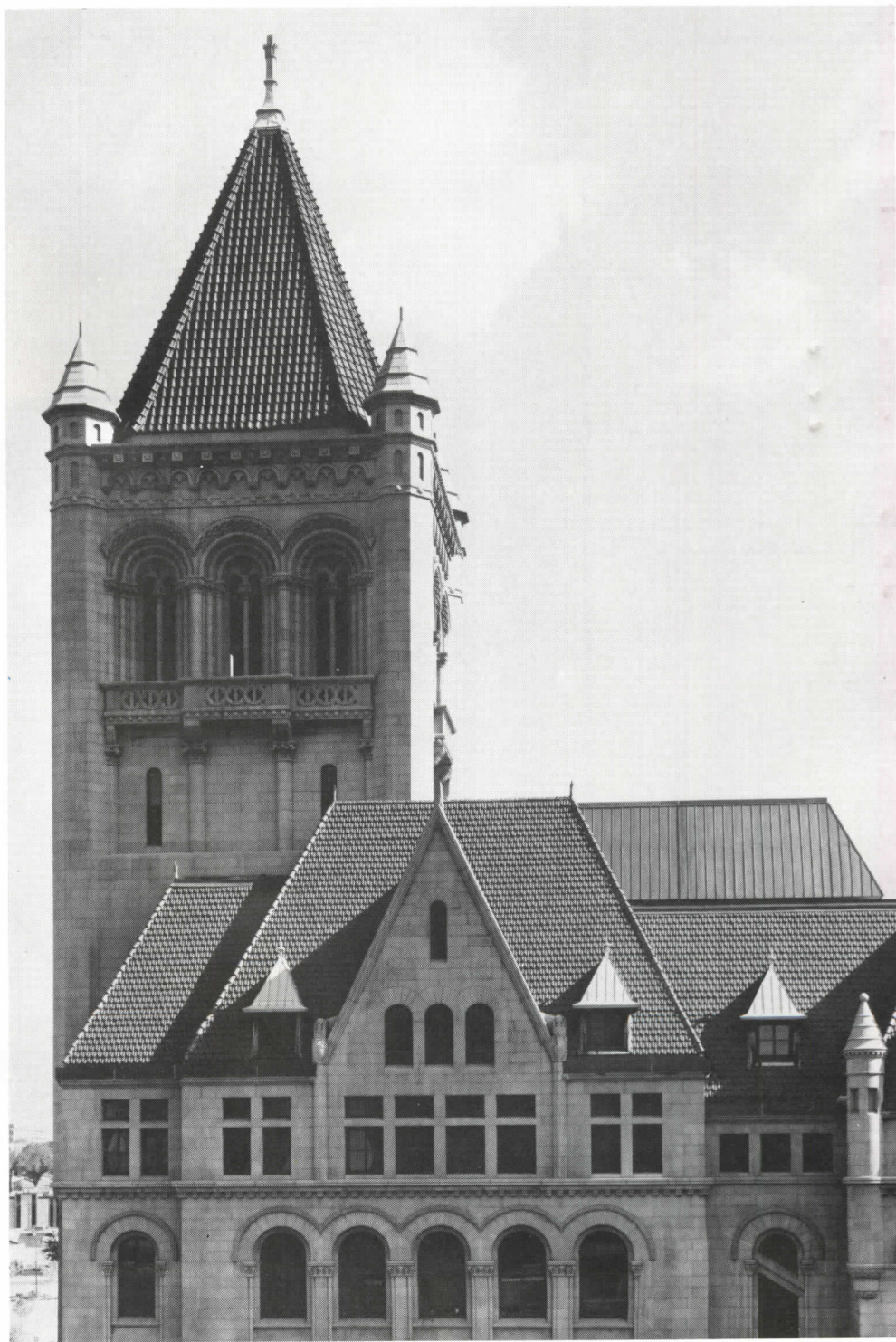

Shin Koyama photos





The photograph on the opposite page shows the Fifth Street elevation of the Old Federal Courts Building in St. Paul—now converted into a public cultural center and re-named "Landmark Center." A plan of the main floor of the building is shown on the right.

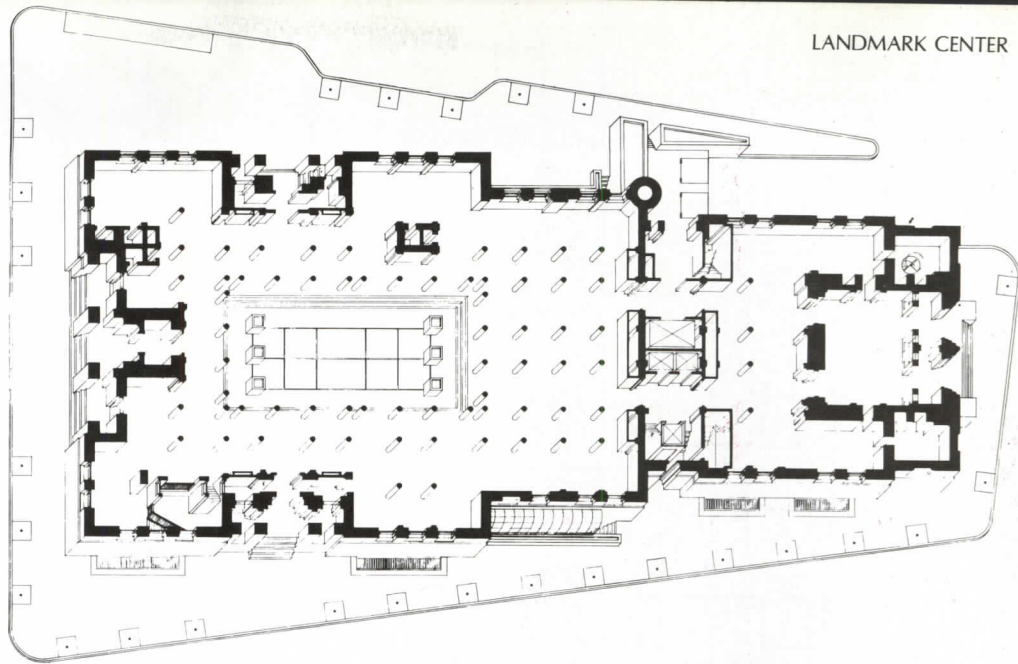

the Department of the Interior, depending on the nature of its activities. Enthusiasts in St. Paul for the renovation of the Old Federal Courts Building had tried without success to buy the building outright from the Federal government (noting that money paid to purchase it would reduce dangerously the coffers for its renovation), and they had also developed a number of specific proposals for uses that, it was hoped, would qualify the building for being given away outright by the government. All of these had been rejected by the bureaucracies.

The Congress (and the General Services Administration) simplified the entire process in 1972 and provided a much-needed break in the log jam. Now to be eligible for transfer, a Federal building had only to be surplus property, to be on the National Register, and to be the subject of an adequately funded plan for adaptive re-use. It could now be used for revenue-producing purposes and for a broad range of activities, as long as its status as a public historic landmark was not violated.

And so in October, 1972, the Old Federal Courts Building was turned over to the City of St. Paul for the token sum of one dollar. A principal occupant was to be the St. Paul Ramsey Arts and Science Council—a vigorous centralized administrative and fund-raising agency for most of St. Paul's and surrounding Ramsey County's artistic and scientific organizations.

The original building was designed and constructed from 1892 to 1902 by the United States Treasury Department under the architectural direction of Willoughby J. Edbrooke and James Knox Taylor. The first steps in its renovation and restoration—begun in 1973 by St. Paul architect Brooks Cavin—were the cleaning of the warm, pink St. Cloud granite of which the building is built and the replacement of the existing composition roof with one made of clay tiles from the original molds rediscovered in Ohio. At this time three of the original courtrooms were partially restored for public meetings and recitals.

While this was happening, an initial programming study and a preliminary budget were also being prepared by the firm of

Dober Associates in Cambridge, Massachusetts. In 1974, the firms of Perry, Dean, Stahl & Rogers, in Boston, and Winsor/Faricy, in St. Paul, were selected to prepare the final re-use scheme. This creates facilities for a new 250-seat auditorium, for shops, restaurants, art galleries, and it provides offices for the Arts and Science Council and its members. It also provides for restoration of not just the original three but four courtrooms, and, perhaps most important of all for the public's perception of the building, the high central court of the building has now been restored. This space, which is shown on the previous page, originally had three ceilings—one at the very top, another two floors below that, and one between the first and second floors to provide security for the post office that used to be there. The lower ceiling has now been removed, giving for the first time the chance for the visitor on the first floor to see this remarkable space in a single glance. In the space directly below the roof at the very top a greenhouse enlivens what was formerly an attic, as the plans on the following pages illustrate. It is surrounded by a museum art school and by additional space still unassigned, waiting for some future occupants.

Though still not yet fully complete, the Old Federal Courts Building has been sufficiently refurbished, sufficiently altered, and sufficiently loved so that it has now become the Landmark Center its supporters and creators wanted it to be. It is worth noting that there are now other similar projects under way because of the 1972 amendment to the Surplus Property Act. But it is also worth noting that there are still other projects—like the renovation of the Old Federal Building in St. Louis or of the Customhouse in New York—which are *not* under way (or if they are, under different sails) because no suitable local takers could be found. Nothing worthwhile happens quite automatically, and so while it seems certainly fair to say that GSA's initiative in the Surplus Property Act was imaginative, so does it have to be said that the citizens of St. Paul deserve due credit for their persistence in realizing its possibilities—as well as, perhaps, in helping to create the environment for it in the first place.



Shin Koyama photos

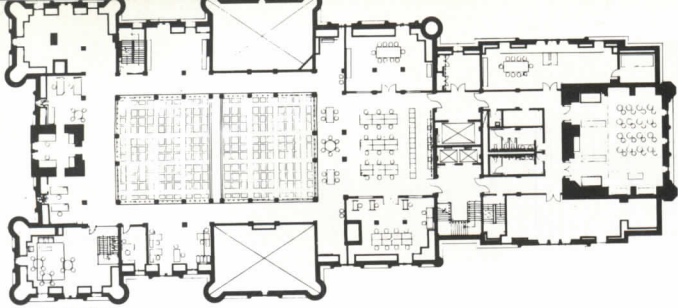

FIFTH FLOOR

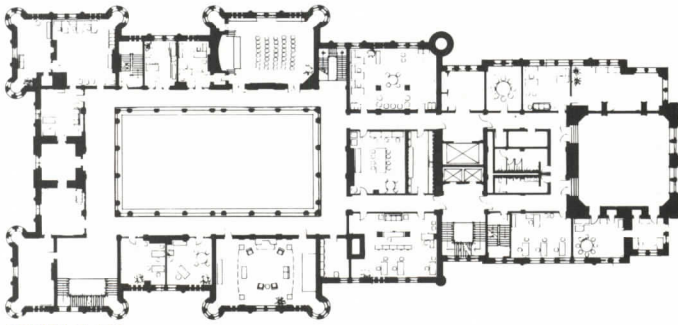

FOURTH FLOOR

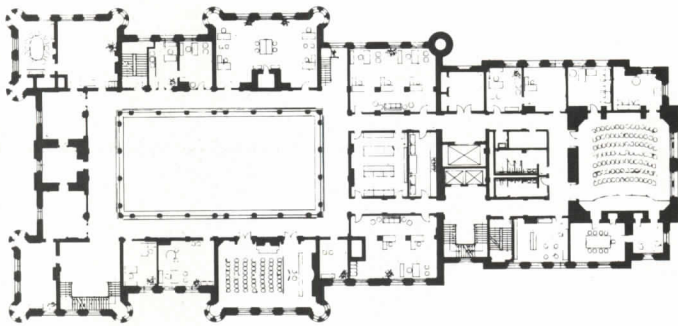

THIRD FLOOR

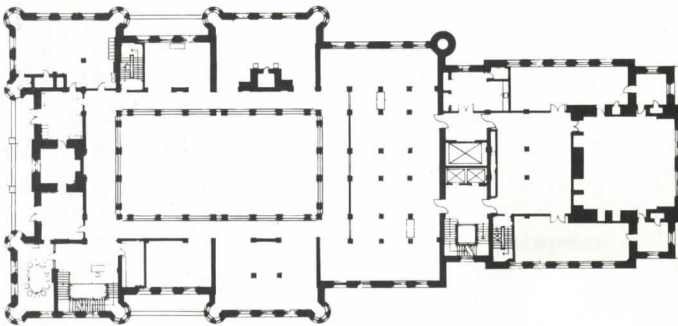

SECOND FLOOR

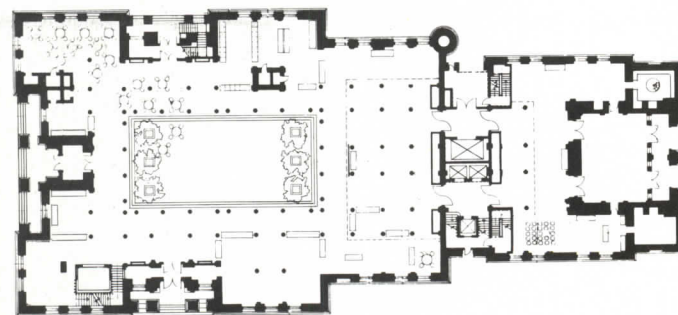

MAIN FLOOR

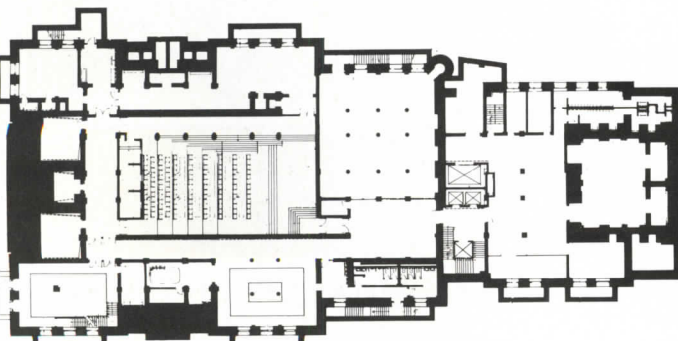

BASEMENT





The color photograph on the opposite page shows the restored law library in Landmark Center. The lighting was recreated from early photographs, and other details were handled with equal meticulousness in this purely restorational part of the project. Also restored was the Superior Court room shown on the left. The photograph on the right shows the marble foyer under the north tower, and the photographs above show the arcades around the central court inside.



Shin Koyama photos

ANOTHER STEP FORWARD: DESIGN FOR MIXED USE

Another of the new goals of Federal architecture is to "enhance as well as protect the environment by encouraging street vitality and a lively pedestrian setting in and around Federal buildings."

The first building completed that was designed to meet this goal is the Federal Home Loan Bank Board Building up near the White House. . . .

That goal was established in 1975 by a National Endowment Task Force which in its report suggested that "Federal buildings used by the public should provide the widest possible range of uses along with public use—including commercial, educational, civic, cultural, and recreation uses"—in short, what is commonly called mixed use. This goal was written into public law in October 1976 as part of the Public Building Cooperative Use Act. Several buildings incorporating mixed use are now in construction or being fitted for re-use—but the first building to demonstrate that government can in fact "live over the store" is this building, designed by Max O. Urbahn Associates.

Indeed, the mixed-use concept of this building was born long before such uses became policy—and was suggested by Max Urbahn as part of his presentation to the GSA/FHLBB selection committee, which chose his firm for the work back in 1973. The decision to push for the public amenity designed into this building was not only foresighted—but turned out beautifully.

The plot plan at right details the amenity: the L-shaped, six-story office building (and the older Winder Building on the same block) wrap around and shelter a handsome and inviting plaza, with broad pedestrian walks, a striking waterfall, a reflecting pool that provides a unique seating area in the summer under umbrellas set on decking in the pool and a skating rink in the winter, large shade trees, and a glass-roofed Galleria which in the summer will be an outdoor restaurant—all well lighted at night. Surrounding the plaza are a series of ground-floor shops (some open already, the others soon to open) and a soon-to-open quality restaurant.

A high degree of inter-agency cooperation was required throughout the design and construction process. For one thing, while GSA served as the construction agency, the building was financed by the FHLBB and its District Banks. For another: to create the plaza and Galleria, land that was part of the Winder Building (see plot plan), which is owned by the GSA, had to be incorporated with FHLBB land. The National Capital Planning Commission was involved in approval of

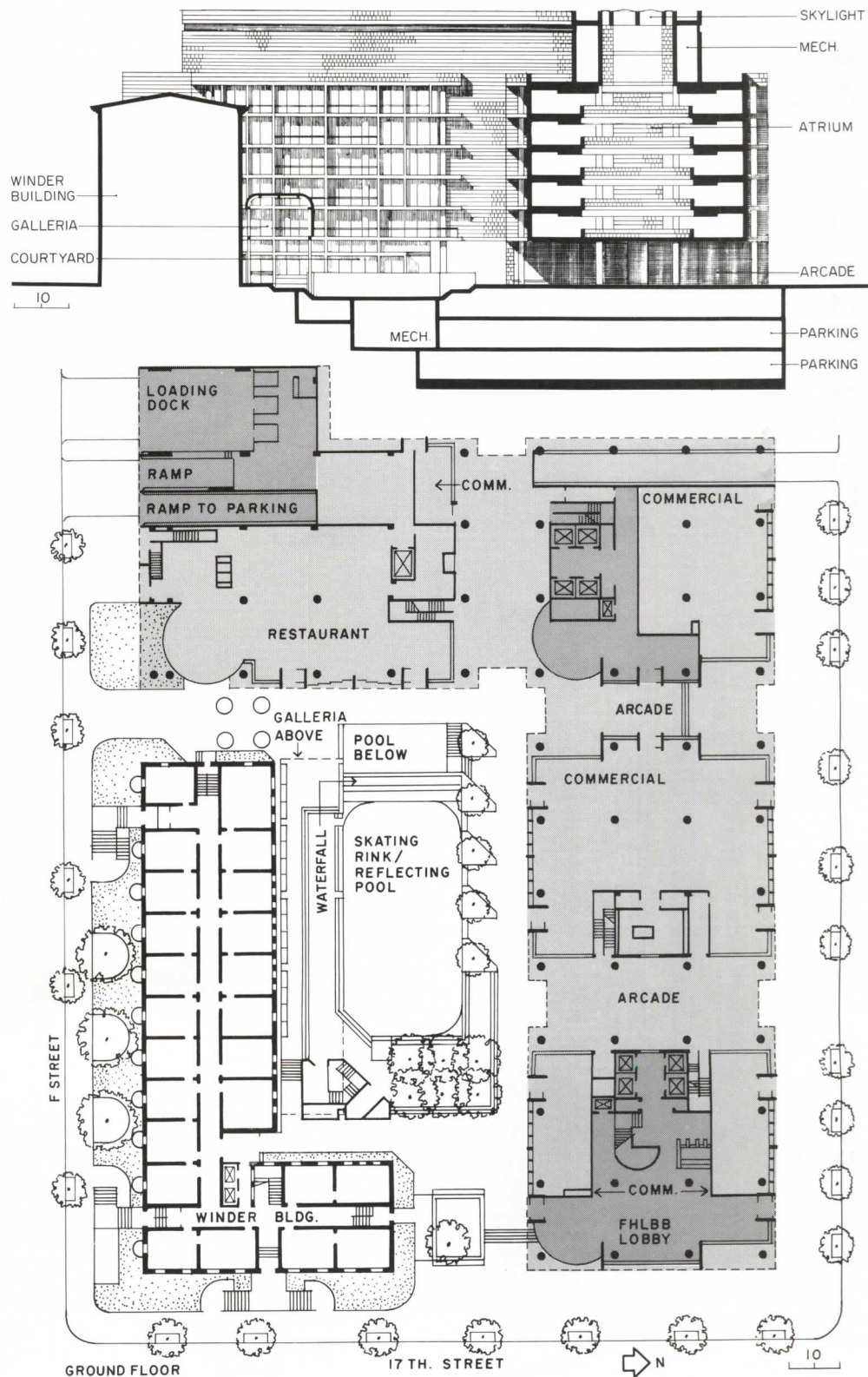

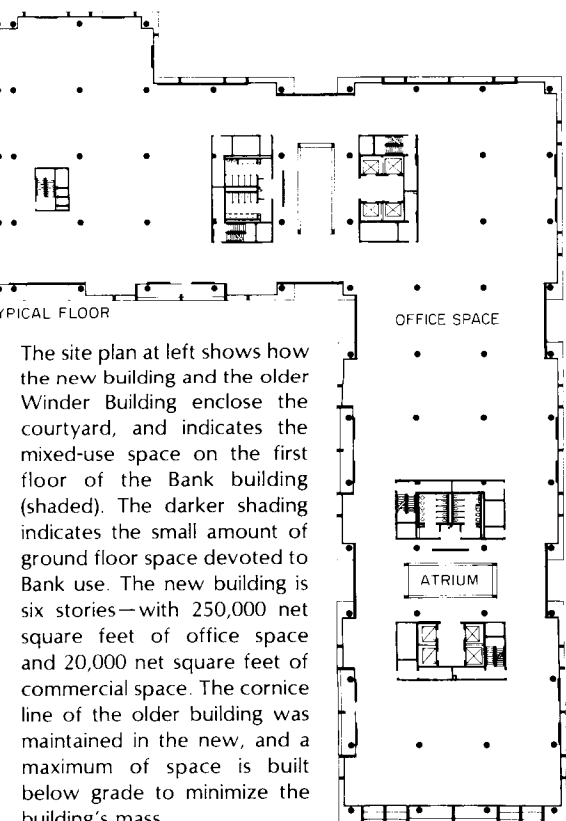

The site plan at left shows how the new building and the older Winder Building enclose the courtyard, and indicates the mixed-use space on the first floor of the Bank building (shaded). The darker shading indicates the small amount of ground floor space devoted to Bank use. The new building is six stories—with 250,000 net square feet of office space and 20,000 net square feet of commercial space. The cornice line of the older building was maintained in the new, and a maximum of space is built below grade to minimize the building's mass.

Norman McGrath photos



every phase of the design. NCPC enthusiastically endorsed the mixed-use plaza plan, and was deeply involved in some of the design decisions—specifically widening both of the major entrances to the court and keeping the court open without gates or fences. Says Urbahn's director of design, Martin Stein: "The Commission endorsed and stiffened the resolve of everyone involved to make the mixed-use concept really work." Stein adds: "Indeed, everyone involved—and especially the GSA project manager, Wayne Kulig—kept their eyes on the goal and contributed to the solution. Too often, we've worked on jobs where the Federal agencies seem to try to avoid any hassle, avoid doing anything out of the ordinary. But on this project—perhaps because then-Administrator Sampson was enthusiastic about the mixed-use concept, perhaps because of the concept itself—cooperation was superb."

Wayne Kulig says, from the Public Building Service side: "This job *did* go well. We worked hard to maintain a close continuity and communication among the team—the architects, their consultants, the construction manager. We worked so closely that paperwork was minimized—we didn't need it. Even though we were plagued by strikes, we managed to make up the days we lost. Cost control was closely maintained, and the job got a reputation for paying promptly—so we got superb cooperation from the subcontractors. And as icing to the whole job—we won one of GSA's top design awards. It was the whole team that delivered the goods. . . ."

And thus this handsome building provides an excellent prototype of one kind of quality that the Federal government is now shooting for.

FEDERAL HOME LOAN BANK BOARD BUILDING, Washington. Architect: Max O. Urbahn Associates, Inc.—project manager, George Wright; director of design, Martin D. Stein, project designer: Jo Standly. Agent for owner: General Services Administration. Engineers: Lev Zetlin Associates, Inc. (structural); Syska & Hennessy, Inc. (electrical). Landscape architects and courtyard design: Sasaki Associates. Construction manager: Turner Construction Co.





The mixed-use—the “vitality and lively pedestrian setting”—are centered around the courtyard enclosed by the new FHLBB building and the older Winder building. The photo above shows the covered arcade, where food will be served during the summer months; and the reflecting pool. Next summer, the pool will be filled with islands of tables and bright umbrellas; and this winter the skating rink (below) will be in full and festive swing. The photos at left show the ground floor stores that open to both the courtyard and (top opposite) the G Street facade of the building. The lower photo shows one of the arcades which open the courtyard to the streets—each an invitation to the passersby to come into the courtyard and enjoy. . . .

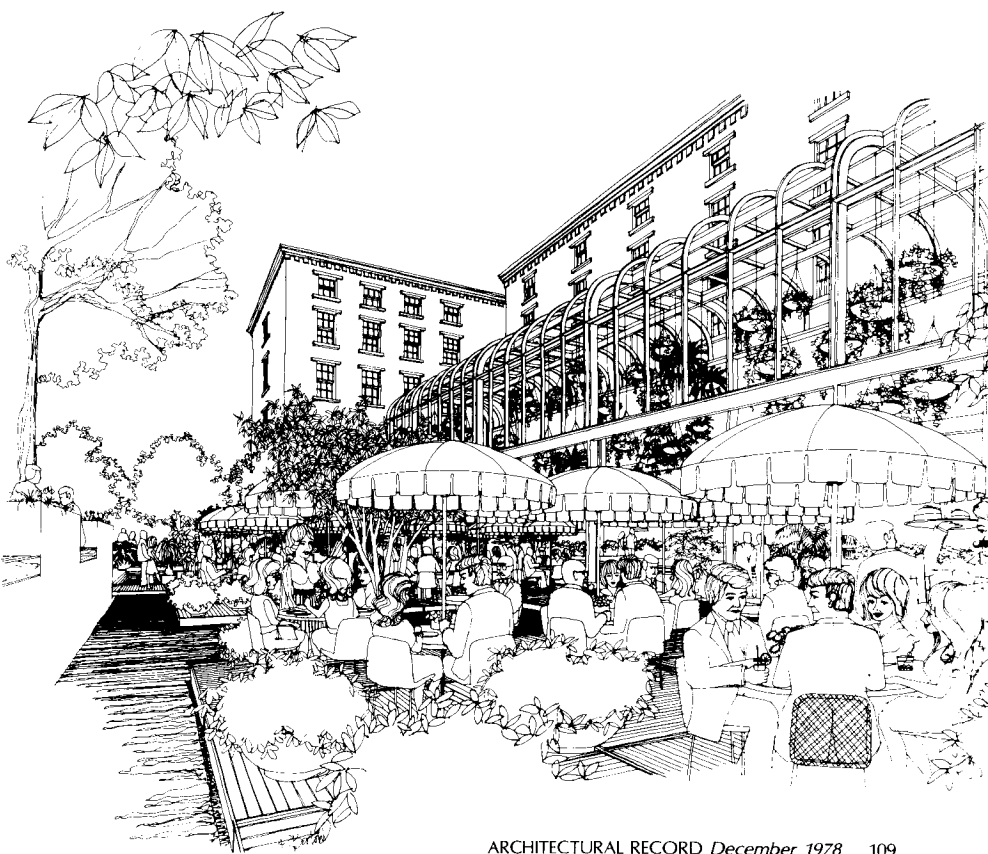

THE NEW BEGINNING: THOSE GUIDING PRINCIPLES

In 1962, as a single page of a 16-page document with the unlikely title of "Report to the President by the Ad Hoc Committee on Federal Office Space," the nation acquired for the first time in its history a public architecture policy. The Principles were written for the committee by Daniel Patrick Moynihan, then an Assistant Secretary of Labor (and then, as since a dedicated architecture buff). As an influential voice in the Senate's powerful Committee on Environment and Public Works, it is interesting to look at what he said back then . . . and what he sees happening today.

It all got started, as Senator Moynihan recalled in a recent interview, "as President Kennedy rode down Pennsylvania Avenue on Inauguration Day. He noted, with much distress, that there really was no Pennsylvania Avenue—no grand axis to the White House, just a depressing kind of urban decay, with 18th-century surveyors lots tied up among hundreds of owners and no space to build new. This question was raised with [then Labor Secretary] Arthur Goldberg, because in those days the Labor Department was, oddly, sort of the center for the arts and humanities within the government. Justice Goldberg assigned me as the staff member to work on it. I'm happy I've lived to vote for, and speak for on the floor of the Senate, the contracts to rebuild Pennsylvania Avenue—17 years and four Presidents later!

"The initiative for the Guiding Principles really came from Justice Goldberg. At its first meeting, the Cabinet started talking about foreign affairs—but quickly got onto the next-most-important subject in government which is of course office space. Everybody wanted a new building—including Labor which was in 19 different little buildings in Washington as well as our wonderful building on the Mall. This was 1960 and there really was a crush—there hadn't been much in the way of new buildings since the 1920s when the Federal Triangle had been left half finished and the country had gone through the Depression and the New Deal and World War II—and of course in those years we had developed a whole new kind and size of Federal government.

"Well, since building sounds like Labor—you know, construction and so forth—at that first Cabinet meeting the Labor Department was assigned to chair a committee on Federal office space and see what needed to be done.

"In the report, which was published in 1962 [see RECORD, July 1962], we did propose principles and standards for allocating office space and putting up new buildings. We also said—in response to the President's unhappiness—what we thought might be done to develop Pennsylvania Avenue. And then—as an extra—I wrote in those 'Guiding Principles for Federal Architecture.' [The complete text of the 1962 Guiding Principles is in the box at right.]

"I wrote them in because, as a student of government, I thought I knew that it is almost always unavailing to expect the government to be innovative. The government falls behind, it gets lost, it gets fixed in a given pattern and can't change. So what I proposed in the Guiding Principles was not that the government be innovative in architecture—simply that it build contemporary archi-

ecture, simply that it try to get the best of its time. I was trying to argue that if we try to get the best of any given generation . . . we will have something to show for it. . . ."

Five years later, Moynihan (then director of the Joint Center for Urban Studies of M.I.T. and Harvard) argued again the case for quality in Federal architecture. In a speech he said, "Somehow, somewhere in the course of the development of democratic or demagogic tradition in this nation, the idea arose that concern with the physical beauty of the public buildings and spaces of the city and the nation was the mark of—what?—crypto-deviationist anti-people monumentalism—and in any event an augury of defeat at the polls. The result has been a steady deterioration of the quality of public buildings and spaces, and with it a decline in the symbols of public unity and common purpose with which the citizen can identify, of which he can be proud, and by which he can know what he shares with his fellow citizens.

"In our time, the fear of taxpayer resentment of the costs of excellence in public buildings has been compounded with an almost ideological alarm at the implications of modern design.

"Good or bad architecture is not an option. It is a fundamental sign of the competence of government. . . . The retreat from magnificence, to borrow a phrase of Evelyn Waugh's, has gone on long enough."

Five years later, in May 1972, President Nixon directed the National Endowment for the Arts ". . . to appoint a special ad hoc task force committee to review and expand the Guiding Principles." In April 1974, the Federal Architecture Project of the Endowment published its influential "Federal Architecture: Framework for Debate." And that document has shaped much of what has happened in Federal architecture in recent years—for it not only reaffirmed the Guiding Principles, but expanded them to include the broadened scope of Federal architecture and a broadened view of architectural excellence. The Endowment report reaffirmed that "As the nation's single largest building client, the Federal government has a special obligation to seek quality in its buildings." It argued for better processes for the selection of architects, with special reference to avoiding "pervasive political influence . . . the effect of which is to push considerations of quality a step down on the list of criteria for architect selection." It suggested design competitions—and some early results have been shown earlier in this issue. It argued for mixed use—a proposal which has been written into law and is beginning to be implemented. It argued for re-use of worthwhile older buildings as Federal office space wherever feasible, and this proposal too is now public policy—and popular public policy. It fought for better landscaping and interiors, for art in public buildings, for better building management—"for maintenance and management can either sustain or destroy the architectural intent of Federal



THE GUIDING PRINCIPLES TO FEDERAL ARCHITECTURE—1962

In the course of its consideration of the general subject of Federal office space, the committee has given some thought to the need for a set of principles which will guide the Government in the choice of design for Federal buildings. The committee takes it to be a matter of general understanding that the economy and suitability of Federal office space derive directly from the architectural design. The belief that good design is optional, or in some way separate from the question of the provision of office space itself, does not bear scrutiny, and in fact invites the least efficient use of public money.

The design of Federal office buildings, particularly those to be located in the nation's capital, must meet a two-fold requirement. First, it must provide efficient and economical facilities for the use of Government agencies. Second, it must provide visual testimony to the dignity, enterprise, vigor, and stability of the American Government.

It should be our object to meet the test of Pericles' evocation to the Athenians, which the President commended to Massachusetts legislature in his address of January 9, 1961: "We do not imitate—for we are a model to others."

The committee is also of the opinion that the Federal Government, no less than other public and private organizations concerned with the construction of new buildings, should take advantage of the increasingly fruitful collaboration between architecture and the fine arts.

With these objects in view, the committee recommends a three-point architectural policy for the Federal Government:

1. The policy shall be to provide requisite and adequate facilities in an architectural style and form which is distinguished and which will reflect the dignity, enterprise, vigor, and stability of the American National Government. Major emphasis should be placed on the choice of designs that embody the finest contemporary American architectural thought. Specific attention should be paid to the possibilities of incorporating into such designs qualities which reflect the regional architectural traditions of that part of the nation in which buildings are located. Where appropriate, fine art should be incorporated in the designs, with emphasis on the work of living American artists. Designs shall adhere to sound construction practice and utilize materials, methods and equipment of proven dependability. Buildings shall be economical to build, operate and maintain, and should be accessible to the handicapped.

2. The development of an official style must be avoided. Design must flow from the architectural profession to the Government, and not vice versa. The Government should be willing to pay some additional cost to avoid excessive uniformity in design of Federal buildings. Competitions for the design of Federal buildings may be held where appropriate. The advice of distinguished architects ought to, as a rule, be sought prior to the award of important design contracts.

3. The choice and development of the building site should be considered the first step of the design process. This choice should be made in cooperation with local agencies. Special attention should be paid to the general ensemble of streets and public places of which Federal buildings will form a part. Where possible, buildings should be located so as to permit a generous development of landscape.

buildings. As this "Framework for Debate" was debated—both in public and within the Federal agencies—it became, as the Endowment hoped, a new, a broadened "Guiding Principles". . . .

Much of the work that is shown in this issue—the examples of re-use, the prototype example of mixed-use, the results of the first Federal design competitions, and the examples of work around the country that *do* demonstrate a new quality of contemporary design—does reflect those new and broadened "Guiding Principles."

For all of the progress, Senator Moynihan sounded this warning in our recent interview: "I'm now—17 years after those early days—chairman of a subcommittee [on public works, of the Committee on Environment and Public Works] that passes on new buildings. But I do have to say that you can't look too much to Congress. If we build the Rayburn Building and the Hart Building, you can't trust us. We *are* full of energy now about preservation and re-use [as other articles in this issue make clear]; and that initiative has a strong community base and it seems to work. But in my opinion the only really *great* piece of architecture that the government has built in years is Dulles airport—and that was built under Eisenhower before we had any public policy. Alas, the Kennedy Administration—which cared fervently about the arts—had as its memorial the Kennedy Center—while its great building is the one at Cape Kennedy. . . .

"But for the future: Architecture is unavoidably a government art. There is no way to avoid involvement in architecture—you can only do it well or badly. And governments are remembered or forgotten in terms of buildings they build.

"We've got to remember that—since the Guiding Principles—every Federal building in Washington has been by a name architect. So if they are not great buildings, what do we make of that. . . . ?

"We *are* making progress in making use of worthwhile older buildings for Federal use—using buildings that the community likes and wants instead of building (for better or worse) new. I think we feel strongly about the mixed-use concept—there is nothing deader than a dead office building. Over on the south side of the Mall there's only one saloon in 20 blocks! But we're making progress [see the Federal Home Loan Bank Board Building, page 106].

"I have a sense of having been through a couple of eras on this subject—and I have to say from that experience that it is one thing to get the government to raise the level of its agenda—and it's another thing to put it into legislative language so that it doesn't get bureaucratized and institutionalized . . . You cannot command creativity, you cannot ordain it, you cannot legislate it. It is not something to be procured—it is a vagrant spirit; it happens, it arises. We can hope it arises where it is least expected. . . ."

Indeed we can hope.

THREE FEDERAL BUILDINGS: HOW'D THEY GET SO GOOD?

The three Federal buildings on the following pages are unquestionably a cut above the Federal average. Their architects were chosen through the typical GSA selection process, the budgets were typical (and tight), and the process involved the same hassles (and the same good help) that the Federal client offers everyone. So how did they get so good? The story of these three buildings offers some ideas on working with the Federal client. . . . and some hope for the future of quality for everyone involved.

Architects designing projects for the Federal government have often drawn a picture of frustration in an Alice-in-Wonderland world. One observer has said: "Why can't the GSA let architects do what they are supposed to do"—deliver a completed building that carries out the best intentions of the users within the particular context of place and within the constraints of budget. It is no secret that GSA's Public Buildings Service is accused by many architects of many and sometimes conflicting directives, of endless work-making and creativity-sapping reviews and regulations—and of often having no one visibly in charge to straighten out the mess. And of course, the inevitable with surely not-generous fees and a good deal of extra procedure: "When it was all over, we lost money."

But not all of the Federally commissioned architects have been quite so unhappy. The question of fees aside, this article describes the experiences of three such architects who did accomplish at least most of what they set out to achieve as professionals. And the results of their experiences are traced from selection process through design and into occupancy. There are many snags—but little cause for desperation. According to architect William Morgan, whose almost-complete Federal Courts building is shown on pages 116-117: "I would do it again in a minute, because I was able to achieve what I wanted in a true urban sense." Morgan may not be typical, because he is unusually determined. But the outstanding results achieved by Morgan, by TMP Associates, and by the Graham-Bassetti offices should surely give hope to the hesitant . . .

Question: How closely were these architects really able to carry through their initial concepts—and why?

According to Larry Morris of TMP Associates: "The person directly in charge in the local GSA office can be the key." For TMP's office building in Ann Arbor (opposite and pages 114-115), the architects were asked to develop three initial alternate plans; TMP developed four. Of course the fourth was the plan the architects thought best met the requirements with special reference to fitting into the neighborhood. GSA official Dick McGinnis in the Chicago office backed up the architects—despite the fact that initial cost estimates exceeded the budget. (The project actually was built for less than the budget.) And it was McGinnis' own concept that the building not have an official appearance in a university town—an experience that can be contrasted with that of many architects who have been directed to conform with plans that they did not recommend, and who could find no one in authority willing to debate the issue.

William Morgan's success in seeing his striking and innovative courthouse built as conceived was partially due to the particular nature of Federal courthouse projects, wherein the judge-in-charge becomes the client along with the GSA. The Fort Lauderdale judge

was particularly responsive to the concept of public accessibility within the limitations caused by the increasing need for courtroom security. Another factor was Morgan's request for the crucial review by the Public Advisory Panel at the earliest possible date. He knew the importance of the support of the volunteer architects and GSA members on this panel, and he won resounding support early enough to have a clear vision that he was working in the right direction. Morgan also cited a minimum number of initial directives.

Outside observers argue that the Fred Bassetti and John Graham & Company's office building in Seattle (pages 118-120) differs markedly from the initial concept, but Bassetti's partner Skip Norton confirms only a few of those differences—last-minute switches from the proposed concrete structure and from the brick and terra cotta cladding to white concrete. Ironic—in view of the recent drive for mixed use—was the GSA's resistance to the architects' concept of placing stores and restaurants on the building's ground floor to enhance the liveliness of the neighborhood. Of course, the ten-year design and construction period of the Seattle building (particularly caused by funding delays) has seen a number of shifts of attitude, and—in its human scale at ground level this project can be viewed as a pioneer of what has since become government policy.

But, before the concept came the architect selection . . .

Both Morgan and TMP's Larry Morris describe the selection of their firms as the standard GSA procedure. Morgan subscribes to the *Commerce Business Daily* wherein are announced invitations to bid on procurements of every description—from stationery to architectural services. But he credits the previous track record on Federal work of his joint-venture engineers, H.J. Ross Associates, with providing enough clout for Morgan to be selected on a first time basis. And he "applauds the wisdom" of the volunteer architects on the GSA selection panel in picking his qualification forms 254 and 255 from the stack of applications for the "short list." After the GSA interviews and the presentations to the client in Morgan's ten-person office in Jacksonville, there was a silence which ended with an informal call from GSA. (On competitions, Morgan argues that "they are only as good as the programs and the judges.") TMP's selection under the same process was perhaps aided by the firm's earlier receipt of an award in the Federal Awards Program—which automatically gives preference.

According to David Dibner, PBS Assistant Commissioner for Construction Management, there are continuing improvements in the GSA/PBS selection process. These range from broader exposure for the existence of possible commissions in newspapers and professional societies to published criteria on the points on which archi-

text continued on page 121

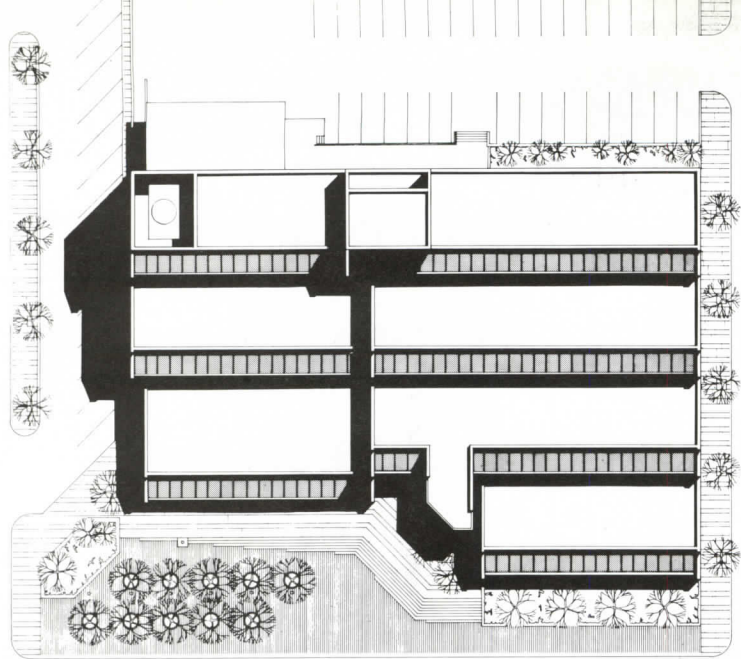

TMP ASSOCIATES' FEDERAL OFFICES IN ANN ARBOR, MICHIGAN

Housing a variety of United States Government functions, including the local branch of the Federal Bureau of Investigation and a post office, this 76,850-square-foot building presents a remarkably "unofficial" appearance—especially toward Liberty Street (bottom of site plan and foreground of photo, below), the main pedestrian link between

of Michigan campus. The four stepped-back floors were planned for open-plan furnishings, designed to accommodate the constantly changing space needs of the various agencies. And the spaciousness that was to result was enhanced by both the high entrance lobby running through the building from Liberty Street, and by a succession of perpendicular open wells at each floor



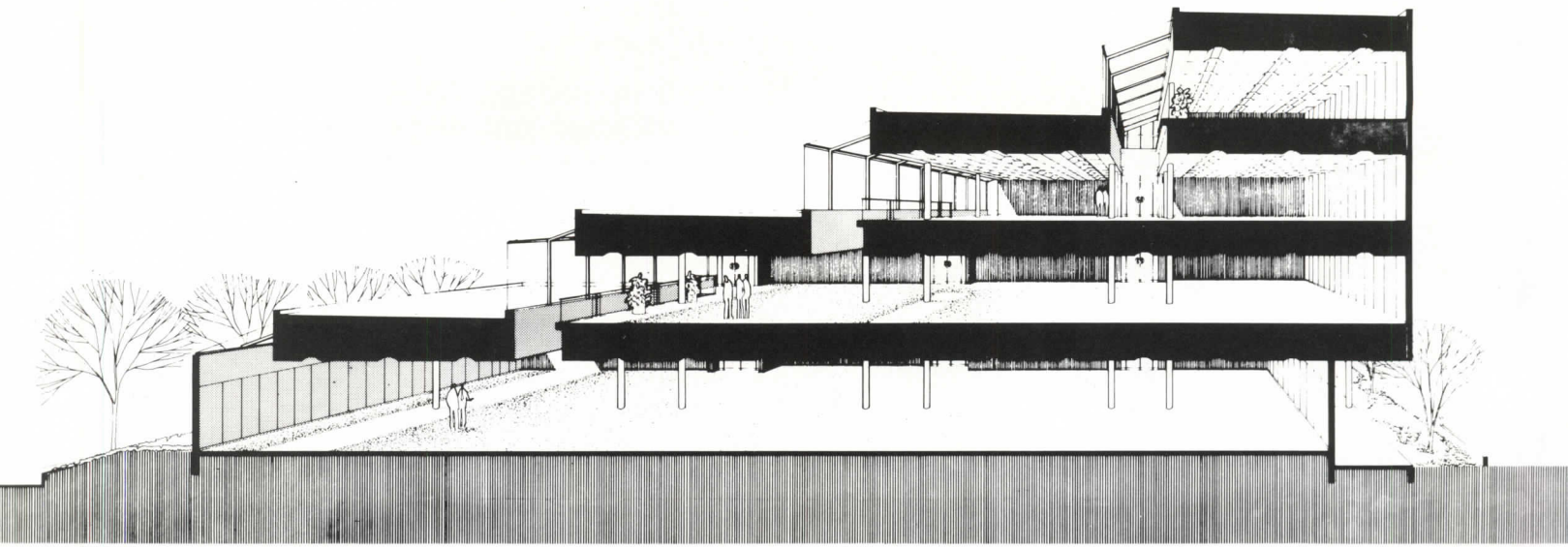



directly behind the glass lines (see section). These wells allow occupants to see the activity above and below, as well as adding to the airy quality of the spaces. But a greater number of high partitions were installed by the occupants than the architects envisioned. And the FBI demanded concrete block walls around its offices. Because of the open

planning concept (originally requested by GSA), glass areas were severely limited for acoustic purposes. And the glass was further limited to the north wall, so that it would admit glare-free natural light with a minimum of heat gain during summer months. The steel-frame construction is sheathed with tan-colored quarry tile on a masonry backing.

The considerate profile of this building, with its pedestrian-scaled main facade is a result of an unusual amount of consideration for the character—existing and proposed—of the neighborhood. The \$4-million building took five years from start of design to occupancy, and has received a merit award in the Federal Design Awards Program.



Bill Engdahl, Hedrich-Blessing photos

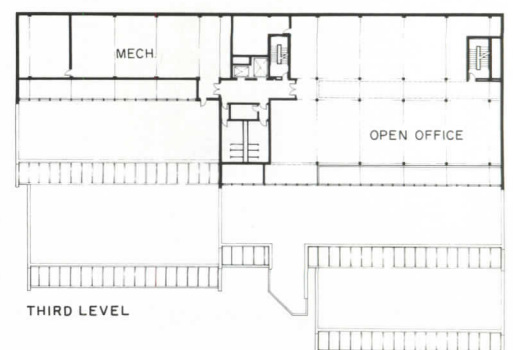
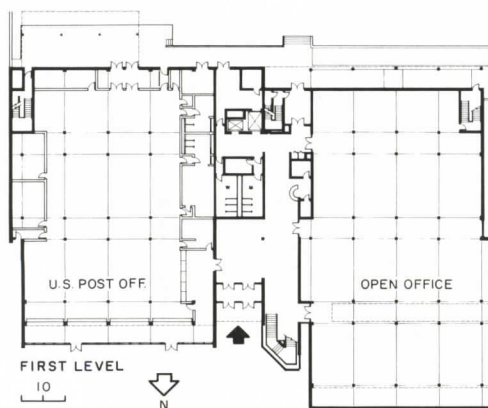

WILLIAM MORGAN'S COURTHOUSE IN FORT LAUDERDALE

The progress photos shown here already indicate the strong urban qualities of William Morgan Architects' almost-built design for a major intersection in this loosely-knit Florida city. Like Morgan's police station for Jacksonville (RECORD, January, 1978), this Federal court facility manages to combine the seemingly incompatible images of monumentality (a client mandate) and public amenity. Here, the public amenity takes the form of

what will be lushly planted water gardens, visually contained by a peristyle. The intersection gains a major pedestrian space that—because of its visual inclusion within the volume of the building—is appropriately urban. Parking spaces are provided on grade under the building, and this plan allows the relatively low massing shown here—in contrast to the tower and separate garage originally implied in the GSA program.

The concrete "tree" construction is similar to the Police Center's, as described last January. The project is nearing completion after four years, and is well under budget at \$33 per square foot. According to the report of the Public Advisory Panel: "The result is a project design of ingenuity, structural and energy efficiency and total integrity. It has the potential of achieving a new high in Federal architecture dedicated to a democratic ideal."

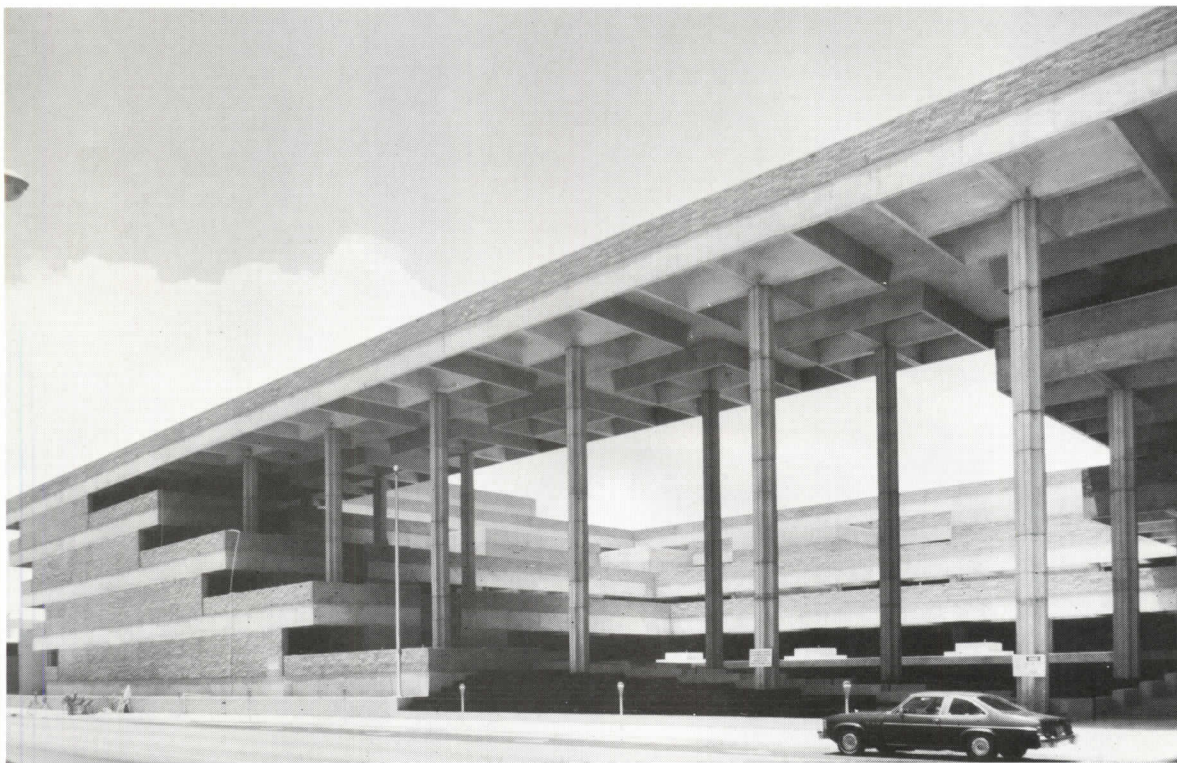

Dan Forer photos

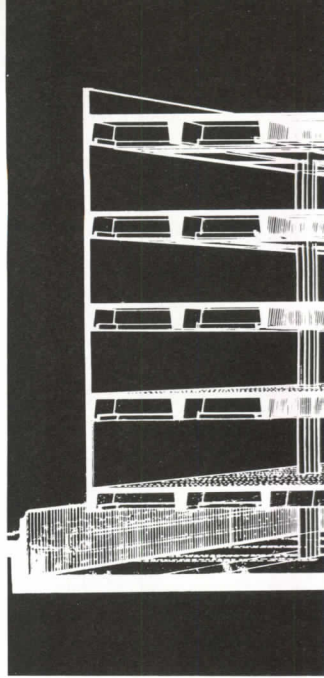
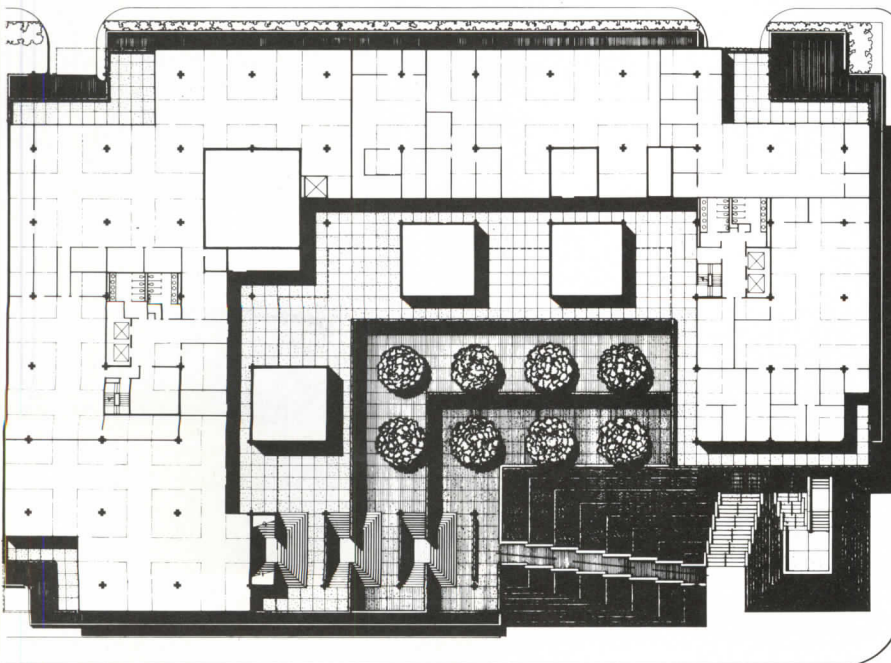

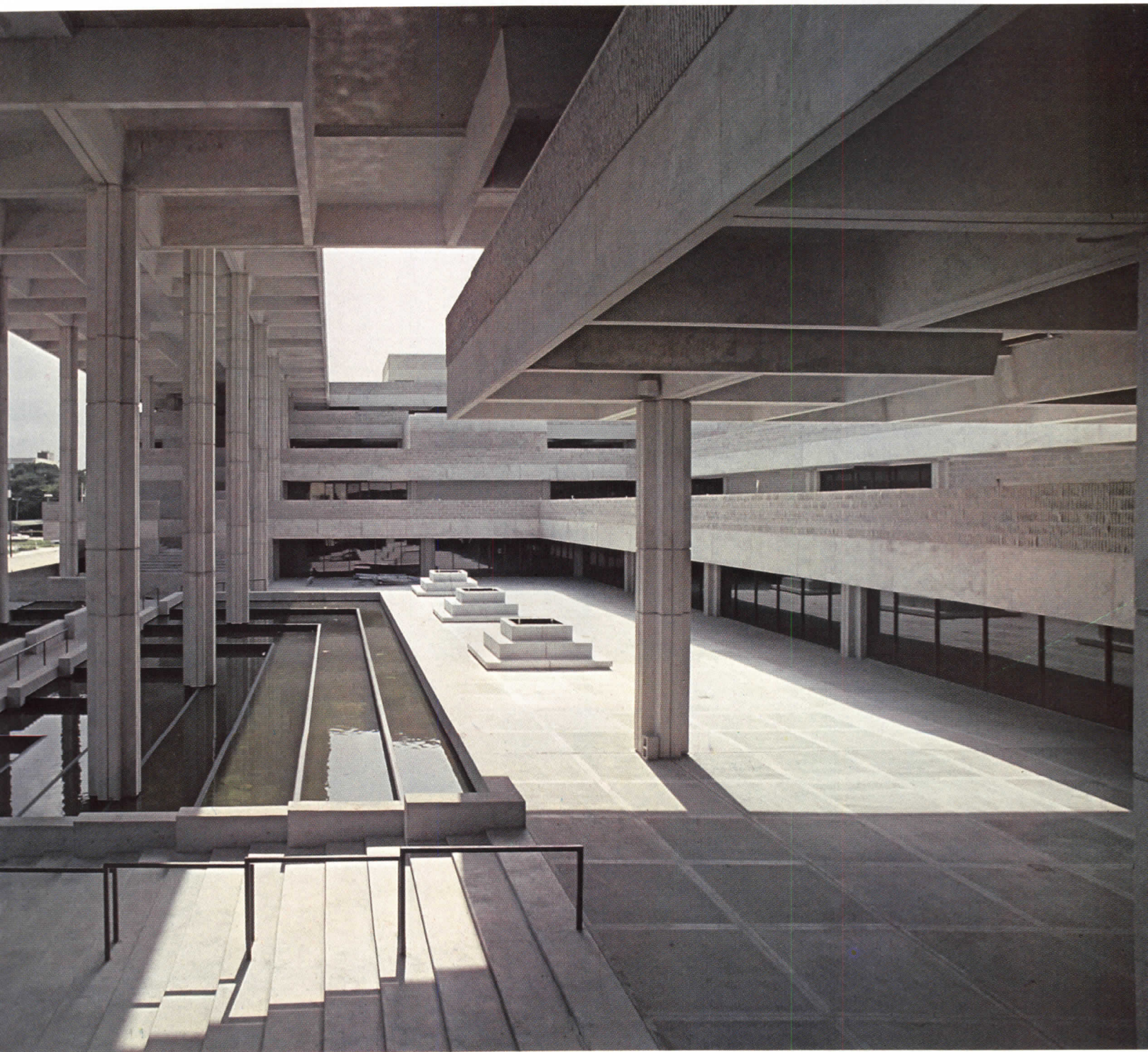
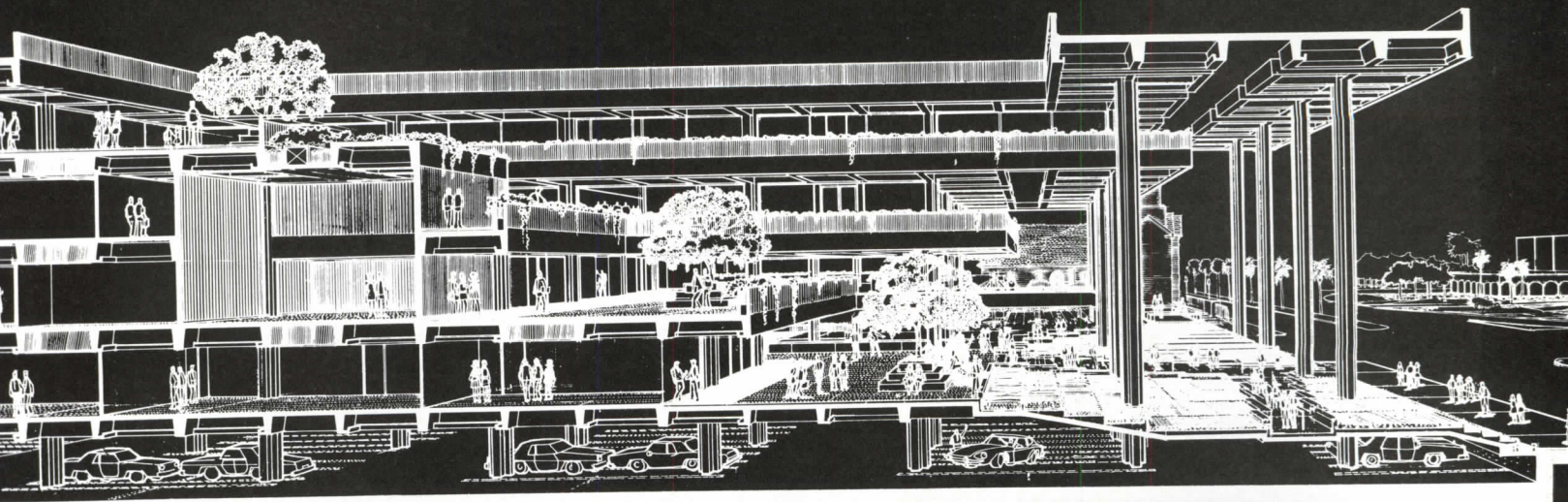

OFFICES IN SEATTLE BY FRED BASSETTI AND JOHN GRAHAM

This building has two major design objectives: To show that the owner is the Federal government (rather than a bank or insurance company), and to make it visually and physically accessible to all citizens. To meet the first objective, the precast concrete skin has been designed for both its substantial proportions and for a liveliness produced by an external expression of the various functions

within—such as a customs court on the fifth floor, an auditorium on the fourth, and the varying requirements for mechanical equipment and for natural light as the building rises. A requirement for maximum space efficiency—as well as a substantial appearance—contributed to the square plan of the 850,000-square-foot structure. But it is where this tower meets the ground that it

becomes most inventive, and truly achieves its second goal of accessibility. Well ahead of what would become government policy, the architects hoped to achieve a variety of public functions, such as restaurants on the ground floors. What the architects did achieve was a lively urban plaza that accommodates the site's 45-foot change of elevation in a series of descending landscaped

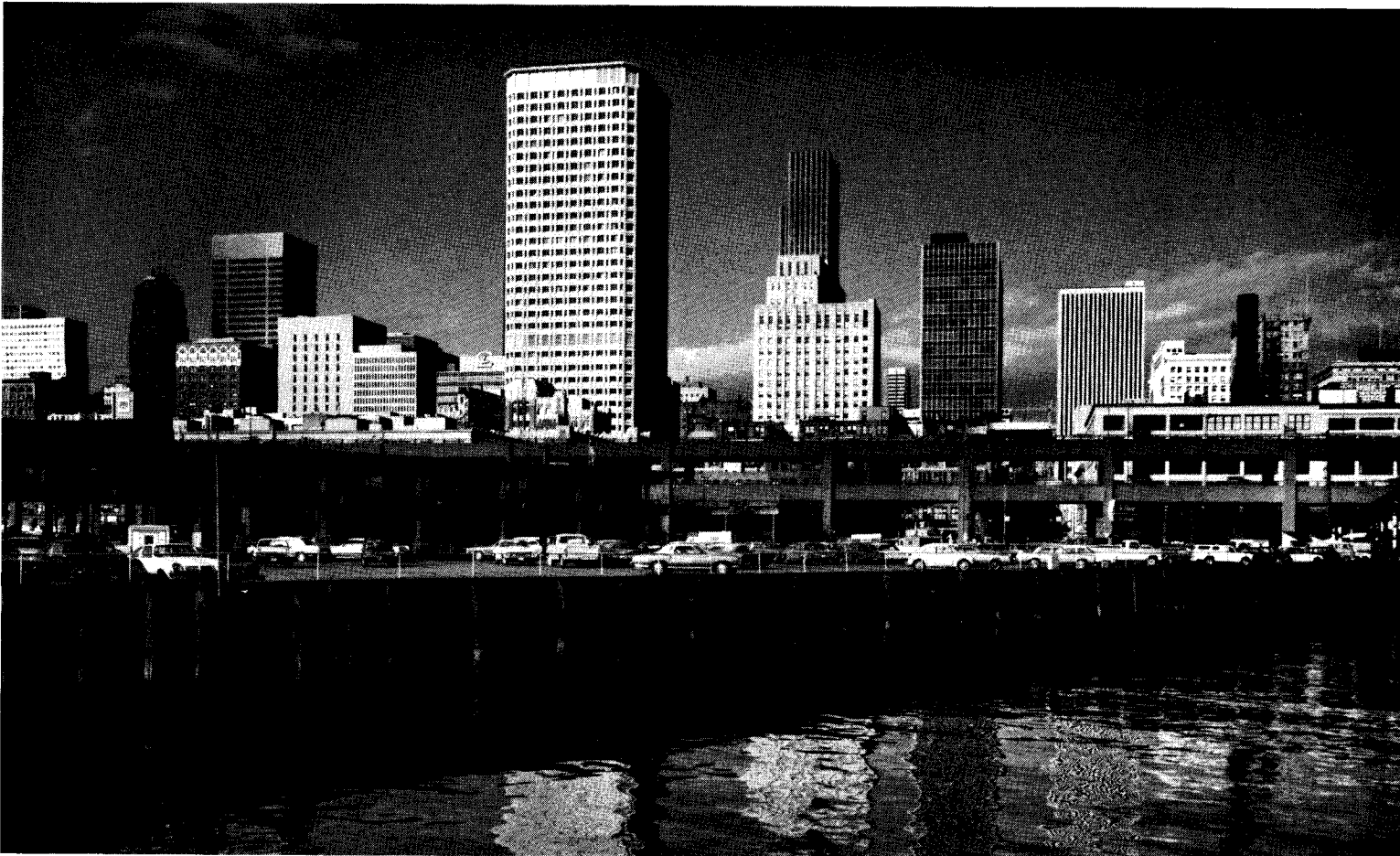

Julius Shulman photos





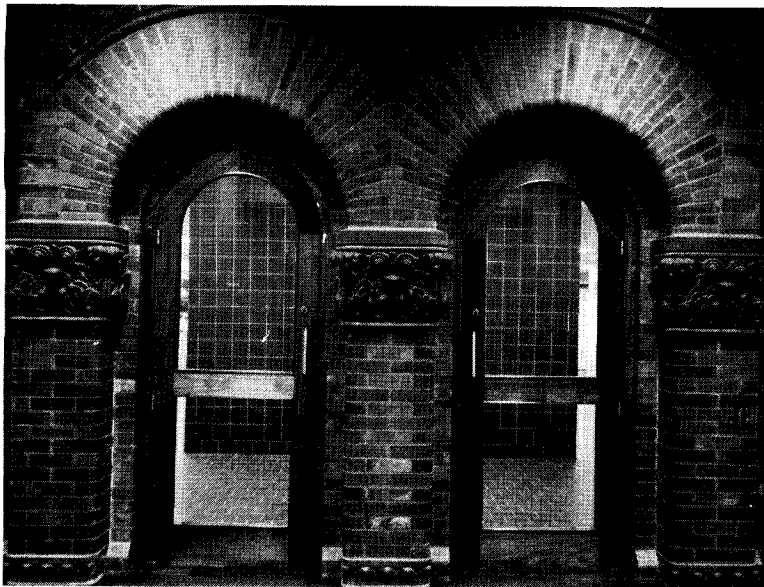

Art Huppy

terraces, likened to Rome's Spanish Steps. The plan of this plaza gains added visual interest from sections cut into the raised levels for service-vehicle and cafeteria access. The plaza and ground floors also gain visual interest by the incorporation of parts of a distinguished late-nineteenth-century building that occupied the site before the GSA's demolition (photos, left and at the bottom of page 118). The Seattle Federal Office Building is a pioneer in more than its humane treatment at the ground level. It is also a prototype for future computer-controlled

life-safety and environmental systems. According to the architects, it is "the most fire-safe large building in the United States." The sensors include smoke and water flow detectors, and manual alarms. The building is divided into seven air handling zones of one to seven floors each. Computers operate the lights and heating-cooling systems according to actual requirements to produce energy economies. The building was completed in 1975—after a design and construction period of 10 years. The construction costs were \$44 per square foot for a total of \$42.5 million.



text continued from page 112

jects will be judged in the second stage—during what Morgan referred to as the “silence.” But most interesting is the introduction of the Level 3 competition between the top three recommendations on the “short list” for which a fee will be paid (as described in the earlier article on page 88). Not only will this give firms disadvantaged by lack of previous experience a better chance, but it will allow the GSA to evaluate the compatibility of joint-venture teams.

But the AIA Committee on Federal Design sees further room for improvement. There is still room for further emphasis on quality of design ability, as opposed to size or experience of offices as a selection criteria. An example cited by Morgan is the successful group of postwar embassies designed by Kahn, Sert, Rudolph, and others who had no previous Federal experience.

While most of the concepts could be carried to success, it was not always easy . . .

Larry Morris describes TMP Associates’ five-year experience as “really outstanding”—up to the occupancy of the Ann Arbor offices. GSA’s Dick McGinnis proved sincerely interested in the community, worked to circumvent red tape, and “always had answers.” Aside from the initial requirement for three separate design proposals to the Public Advisory Panel, there was a minimum of work-making hurdles. (Still, Morris would not describe the commission as lucrative). There were few changes in plans and no more than the basic sequence of GSA approvals. The only major problem on the job: McGinnis retired almost six months before the appropriations were to run out in May of 1978—and before the purchase of the task/ambient lit furniture system that was to fill the open-plan floors for which the building was designed. And these floors are now rapidly filling with partitions and used furniture. To date, the systems furniture has not been installed; a recommended signage system has been ignored; the plants that were to complement the skylit areas are largely nonexistent, and that furniture that is newly purchased has nothing to do with the architects’ recommendations. Nor, without new monies, is the situation likely to change.

TMP’s Morris states that the GSA emphasis on “value engineering” yielded \$310,000 in construction savings and reduced life-cycle costs by \$39,000 annually. But other architects are not so sure about this emphasis. A common complaint is that the value-engineering process requires a lot of time, and tends to look at each part of the building as being isolated from the others—such as the case at Ann Arbor, in which task/ambient lighting was directed by the owners after the ceiling fixtures were in place.

William Morgan tried to work with local Fort Lauderdale groups to bring a unifying plan for future development in the blocks immediately around his new courthouse, but the Federal needs dictated speed—and there just was not time to carry through any ambitious ground work. His brief program spelled out a tower along with a separate multi-story garage, but he had little difficulty in integrating these facilities into one lower building—especially after a Henry Beck analysis showed the integrated solution to be more economical. One of the biggest problems during design involved questions about the safety of the fountains, although—as the Public Advisory Panel had stated in their findings—“the various parts of the design interact so totally and interdependently that the project would suffer if major conceptual changes are seriously proposed.” It took reports by the designers of several previous major fountains to overcome the reservations. Another problem was the GSA performance specification that spelled out standard acoustic tile ceilings with fluorescent lights—at the same time that the architect was being asked to pay attention to innovation and energy conservation. In this case the architects, had to build a large “mock up” at their own expense) of an alternate ceiling before they could gain approval.

Morgan’s biggest hurdle was the preparation of eight separate bid packages because of the insistence on “fast-track” construction.

It was almost like drawing eight separate buildings, and it raised the number of client approvals to 16. Morgan firmly believes that his building will not meet the same fate as Ann Arbor’s on occupancy.

The ten-year design-construction period for Graham-Bassetti’s Seattle office building began in 1965 during a period of what Dibner has referred to as possible “shot-gun weddings,” but—according to Bassetti partner Skip Norton—this was not the case in the marriage of architects Fred Bassetti & Company and John Graham & Company. The long time span of the commission was largely attributed to delays in full funding. By February, 1970, \$11.5 million had been spent on design fees and site work when the project was totally stopped in favor of other projects. But the next month, after everyone had presumably packed up their pencils and bulldozers, Seattle was declared an area of substantial unemployment, and was given priority in the award of Federal construction contracts. By June, the design work was virtually complete, but a freeze on all Federal construction monies continued to plague the start of construction.

Aside from some early lost battles over operable windows and sun shading on those windows, Bassetti is said to have favored retention of a fine older building on the site—or even a different site altogether. But he got his way, to a major degree on the site treatment, and seemed to be getting his way on the brick and terra cotta cladding and integral concrete structure that he felt best reflected both the specific location (surrounded by similarly-clad loft-type buildings) and the often-gray skies in the area. But Norton is willing to cite a continually changing cast of GSA personnel in charge, and—by the time that the foundations were to be bid—the GSA ordered a switch to steel structure. After detailing the cladding for the new structure, a white precast concrete cladding was directed. Still, the architects did achieve a highly sophisticated result, as can be seen on pages 118-120.

Of course, Bassetti and Graham’s experience occurred largely before the current new attitudes at GSA, and will hopefully not be repeated. According to Morgan, “the goals should now be to assure that the current high-minded attitudes of GSA leadership become the standard for the full bureaucracy. This is doubly important, because the increasing complications and growing concerns that characterize new construction today require consistent attitudes.” Still, he feels “no one will hold your hand to get a good design. You are on your own.” It may be no coincidence that the problems the architects faced here, in achieving their successes, seem to be somewhat proportional to how long ago they started work. At least, it does suggest hope for the future. . . .

FEDERAL OFFICE BUILDING, Ann Arbor, Michigan. Architects: *TMP Associates Inc.*—principal designer: *Glenn Paulsen*; designer: *John Castellana*; project architect: *Larry Morris*. Consultants: *Geiger & Hamme, Inc. (acoustical)*; *Johnson Johnson & Roy (landscape)*. General contractor: *Barton Malow Company*.

FEDERAL BUILDING, U.S. COURTHOUSE, Fort Lauderdale, Florida. Joint-venture architects: *William Morgan Architects and H. J. Ross Associates, Inc.*—project architects: *Gonzalo Gaitan and James Rink, Jr.* Associated architects: *Wright Ferguson, Glasgow & Schuster*. Engineers: *H. J. Ross Associates, Inc.* Consultants: *Ranger Farrell and Associates (acoustical)*; *William Lam Associates, Inc. (lighting)*; *Stresau, Smith & Stresau (landscape)*; *Dave Meyer & Associates, Inc. (graphics)*; *Rolf Jensen & Associates, Inc. (fire safety)*. General contractor: *Henry C. Beck Construction Management*.

FEDERAL OFFICE BUILDING, Seattle, Washington. Joint-venture architects: *John Graham & Company and Fred Bassetti & Company*—partner-in-charge-of-design: *Fred Bassetti*; project architects: *Richard Scales and Don Frothingham*. Engineers: *Skilling, Helle, Christiansen Robertson (structural)*; *John Graham & Company (mechanical/electrical)*. Landscape architect: *Richard Haag*. General contractor: *Hoffman Construction Company*.

THE WAY IT WAS (AND WASN'T)

The current drive to improve the quality of Federal architecture is only the latest manifestation of a tradition that began with Thomas Jefferson.

Maryland Historical Society

Once the Federal government sponsored an architectural competition for the design of a major government building. Finding all of the entries unsuitable, it asked the author of the most promising one to prepare a revised version. But while the revisions were being made the government awarded the prize to another entry that had arrived too late for the initial judging. In order to soothe the disgruntled feelings of the loser, it then gave him the job of supervising the construction and subsequently allowed him to change the design itself, thereby equally disgruntling the feelings of the so-called winner. Granted, the standards of architectural design were not high at the time. The President himself had said that, unless some better entries were received, the competition would be "a very dull one indeed," and another observer recalled that "scarcely a professional architect was to be found . . . which is plainly to be seen in the pile of trash presented as designs." But since the building was the United States Capitol and the President George Washington, one would have been inclined to think that things would have gone better. But one would have been wrong. Later, another President insisted that

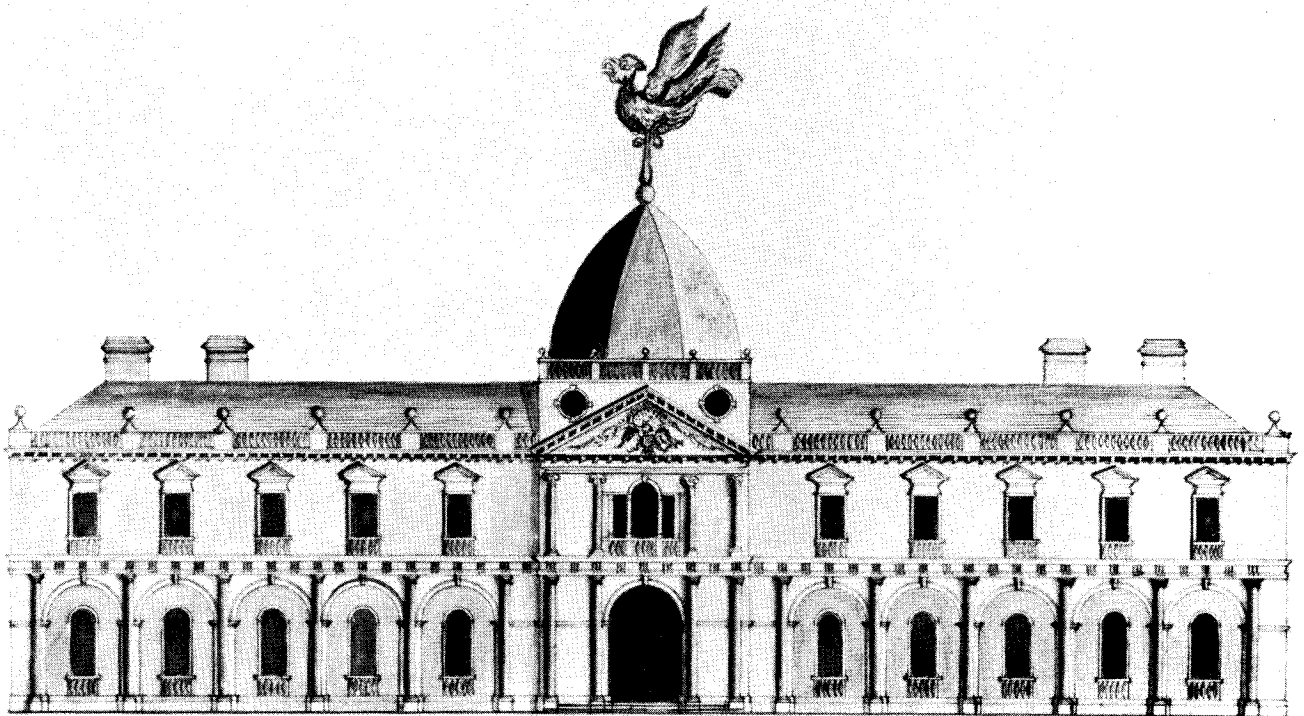

Corcoran Gallery of Art



A loser: an enormous scared bird crowns James Diamond's unsuccessful entry in the Capitol competition.

Form vs. function: one congressman dubbed Benjamin Latrobe's chamber for the House of Representatives "handsome and fit for anything but the use intended."

Mass production: hospital by Ammi B. Young, designed to be repeated over and over again.

National Library of Medicine

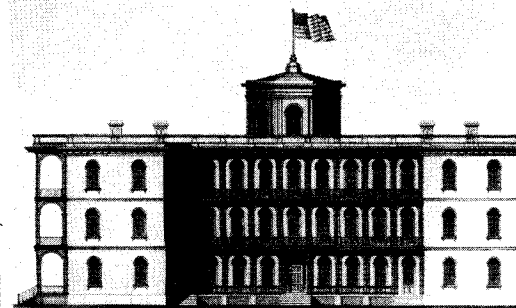

the ceiling of one government building be designed in a certain way, over the objections of the architect, who claimed it would leak. The President was Thomas Jefferson (who won), and the architect was Benjamin Latrobe (who was right: it leaked). Latrobe later opined that government service was a "ruinous connection," and Pierre L'Enfant, who is singlehandedly credited for the momentous plan of the city of Washington, may well have had similar opinions, since his period of government employment was only too brief and stormy. He was hired early in 1791 and dismissed the following February—partly, one might suppose, because he seemed to have regarded his artistic role as an inflexible one, an attitude that led him tactlessly to demolish the house of a Commissioner of the District of Columbia because it stood in the way of one of his new streets.

All of these adventures and misadventures and many more like them up to the present time are the subject of an extraordinary and extraordinarily rich new book, *The Federal Presence: Architecture, Politics, and Symbols in United States Government Buildings*, prepared by Lois Craig and the staff of the Federal Architecture

Project (MIT Press, \$37.50). For those who may find the idea of "the Federal presence" slightly spooky, like wondering if there is some one sinister standing behind the bedroom door, let it be said that the kind of presence described in this book and documented in its really remarkable collection of photographs (from which the photographs on these and the two following pages are selected) is not quite so singular and not quite so easily pinned down. There is, surely, aspiration, bombast, and pretention throughout the history of Federally sponsored architecture. But there is also touching good will, as in many of the Farm Security Administration's projects; and there is loneliness and adventure, as in solitary forts in the wilderness and lighthouses at the continent's brink; and there is also just plain, charming silliness, as in the little United States consulate in Yokohama, built in the 1930s as a replica of the White House (reportedly it led President Truman to the unexecuted belief that all of America's new embassies should be White Houses).

One of the most benign and comforting lessons that any kind of history has to teach—and it is a lesson fully evident in this new

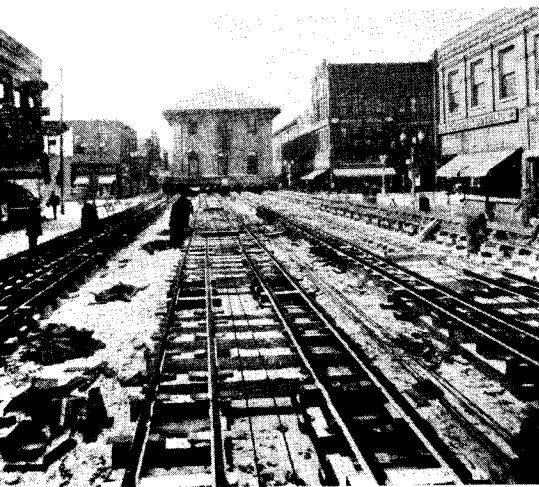

Surplus property: the Old Federal Building in St. Cloud, Minnesota, is trundled over to become a new city hall.

Exposed: the Government's own building at the World's Columbian Exposition—"a source of mortification to those who felt pride in having their country shown to advantage."

Home of the brave: the original, wooden buildings that received immigrants on Ellis Island in New York.



Library of Congress photos

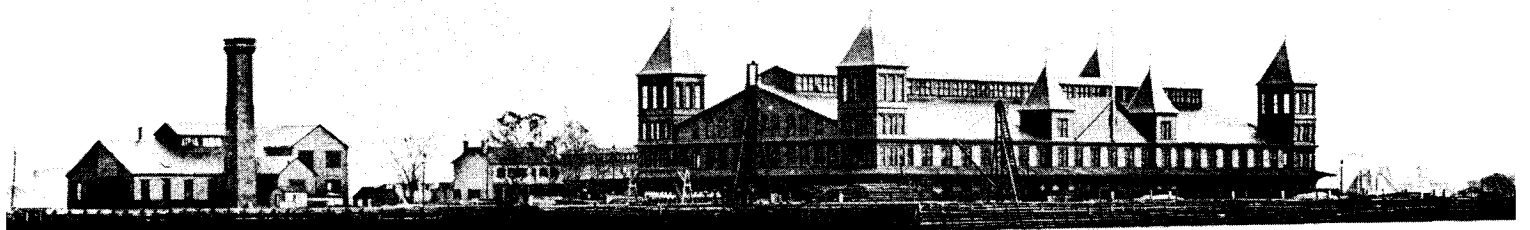

book—is that, insofar as human affairs are concerned, things appear never to have been either a great deal better or a great deal worse than they now are, and indeed they appear never to have been a great deal different. Why should this be comforting? One reason is that we all, although we traditionally have been indoctrinated with the Idea of Progress, seem also possessed—particularly at just this point in the twentieth century—of a strange, folklorish idea that comes near to being just the opposite, an Idea of Regression. Things seem hard; things seem bad; where are the good old days? And so to discover that in fact there never were any good old days comes as something of a relief. In the case of Federal architecture, if the idea of improving it seems difficult, then it is very nice to know that it has *always* seemed difficult. Similarly, it is nice to know that thoughtful people for the past two hundred years have nonetheless regarded it as something very much worth trying, even though that has often involved trodding a pathway littered with horrors. Congress, for instance, once refused to pay the two architects of the Library of Congress what was owed them for repeated changes

in the plans. One died destitute, and the other had to borrow money to bury him. And there is the case of a General Superintendent of Lighthouses in the nineteenth century who resisted supplying the nation's lighthouses with more efficient Fresnel lenses because one of his associates was a supplier of more traditional reflector lights. But there have been very notable successes too, beginning with Thomas Jefferson's early and correct perception that nobility of architectural form and nobility of national purpose deserved each other, and continuing through small and perhaps not well known projects like the Quartermaster Corps Construction Division's design for a Wright Brothers Memorial at Kitty Hawk. Most remarkable of all is the sheer range of the Federal architectural effort—not just in the twentieth century, where one expects it to be perhaps all too encompassing, but virtually from the beginning. It is hard to imagine a building type that the government has not attempted, and the cumulative result—buildings that have been loved, violated, argued about, used, and misused—form a national treasure, testaments and monuments to national folly and wisdom. —Gerald Allen

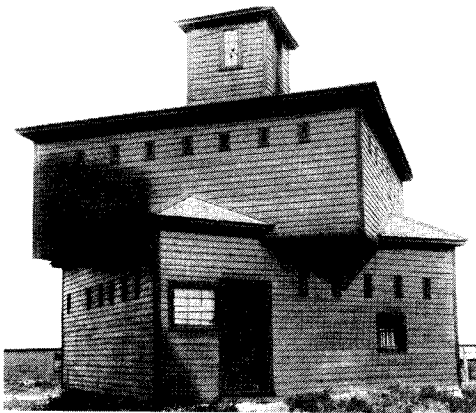

Covering all the bases: Fort Yates, a late-nineteenth-century military post whose up-to-date geometries allowed defenders to shoot in eight directions.

This is Federal architecture? Timberline Lodge at Mount Hood in Oregon, designed by the WPA.



National Archives photos

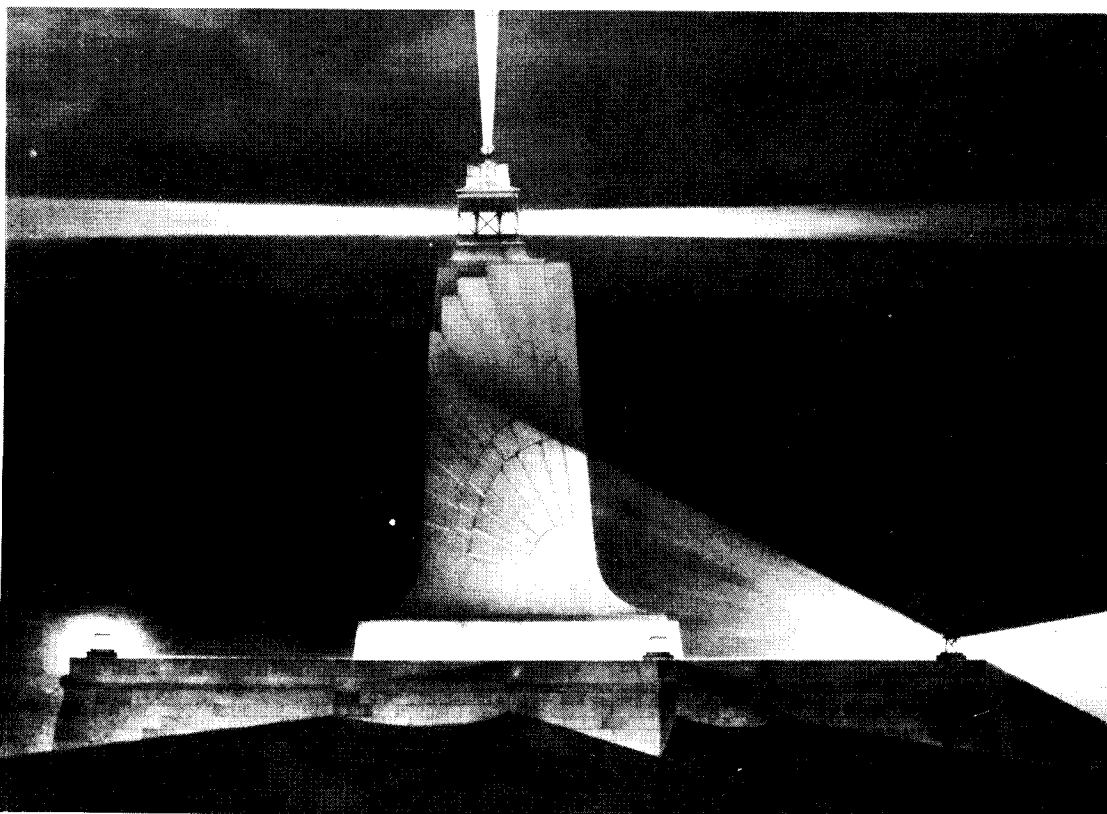

University of Oklahoma

The Federal presence: government money helped pay for the monumental faces on Mount Rushmore in South Dakota.

The birth of flight: the Construction Division of the Quartermaster Corps designed and built this monument to the Wright brothers at Kitty Hawk.



National Archives

Relocation: a hot windstorm brings dust from the surrounding desert to the Manzanar Relocation Center in 1942—"we have given the fancy name of 'relocation centers' to these dust bowls, but they were concentration camps nonetheless."

Dreams: buildings achieve their meanings through the events they have witnessed as well as the shapes they embody. Here crowds swarm about the Lincoln Memorial for the march on Washington in 1963 led by the Rev. Martin Luther King, Jr.

The biggest: the Vehicle Assembly Building at Cape Kennedy—easily the largest building in the world, containing 130 million cubic feet and capacious enough for four Seagram Buildings with room to spare.

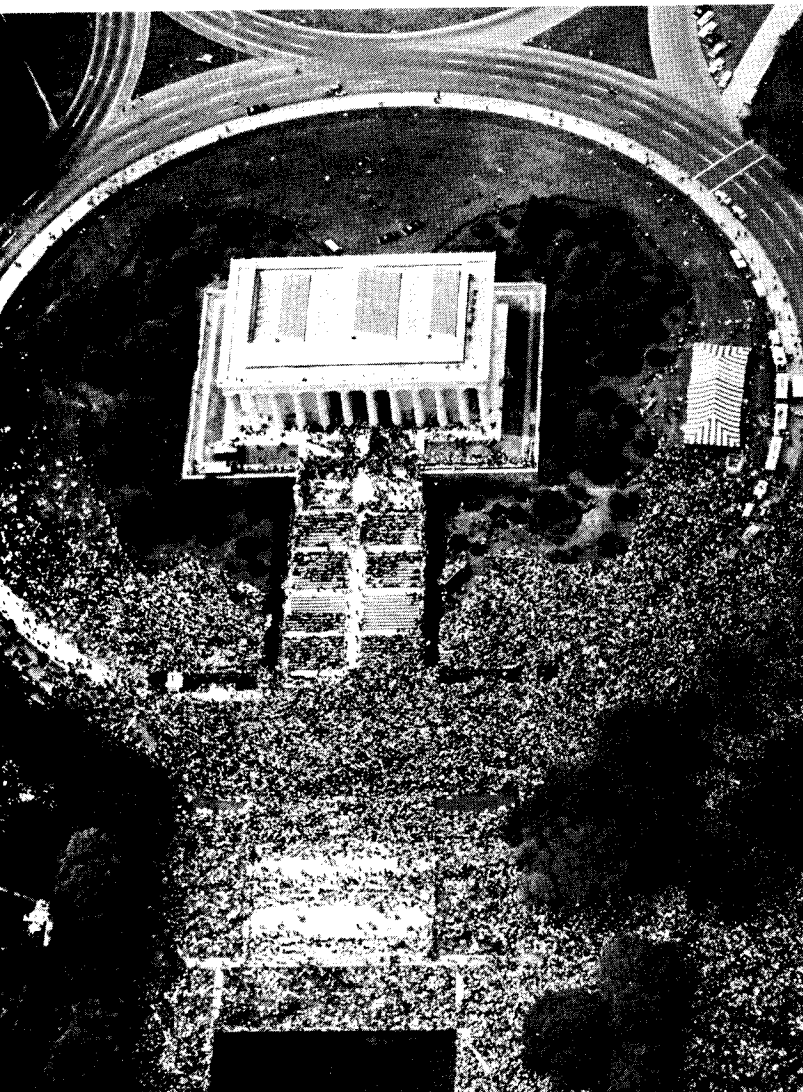

Arthur Whirman, Black Star

Wide World

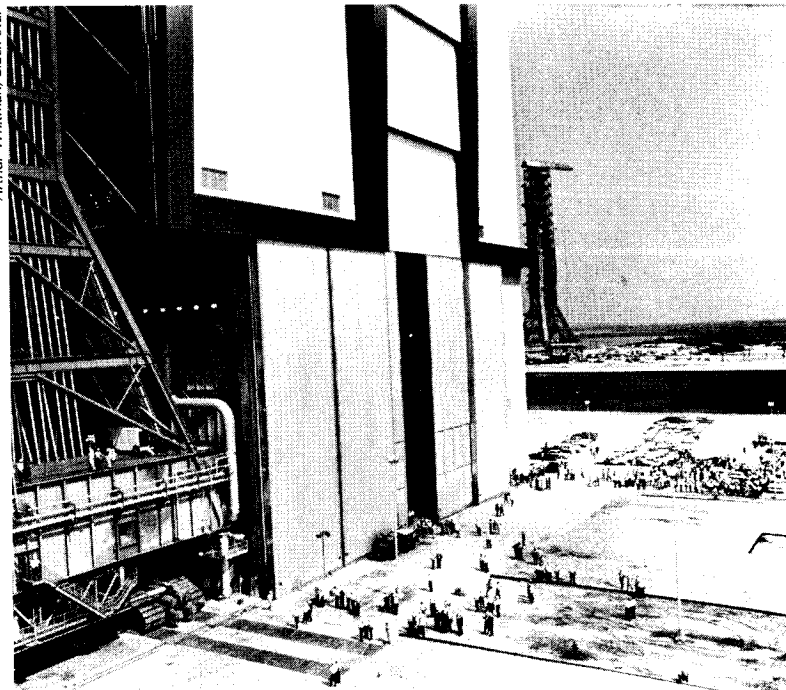

...AND EXCELLENCE FROM OTHER AGENCIES

The Public Building Service of the GSA is, of course, the Federal client for most architects. And—as this issue has shown—much of the changing government policy towards architect selection and design innovation impacts GSA work. But—again through National Endowment initiatives and the series of Federal Design Assemblies—an awareness of design excellence is spreading through the many agencies of the Federal government. For example . . .



POWER STATION, BUREAU OF RECLAMATION

Their extensive experience with concrete was one of several factors that led to the selection of Marcel Breuer Associates as consulting architects when the Bureau of Reclamation started work on the extension to the Grand Coulee Dam. The Bureau initiated the engineering concept, made the working drawings and is supervising construction. Working with the 450-man A/E staff at the Bureau's Engineering & Research Center in Denver, Breuer's office (Hamilton Smith, partner-in-charge) strove to give this massive and highly complex project a visual harmony with its setting and a sensitivity to user need.

The new power plant and asso-

ciated construction at Grand Coulee is but a part of a larger program the Bureau administers. With an annual budget of approximately \$500 million, the Bureau originates new work, renovates existing projects and is responsible for maintenance and overhaul at a variety of locations in 17 Western states. It relies chiefly on its in-house capability, but occasionally—as with this project or the proposed Ruck-A-Chucky Bridge (page 128) seeks outside design consultants. Says James Brown, director of the Bureau's Design Division in Denver: "We work hard to stay abreast of advances in technology and to keep improving the design aspects of what we do."

of Reclamation photos

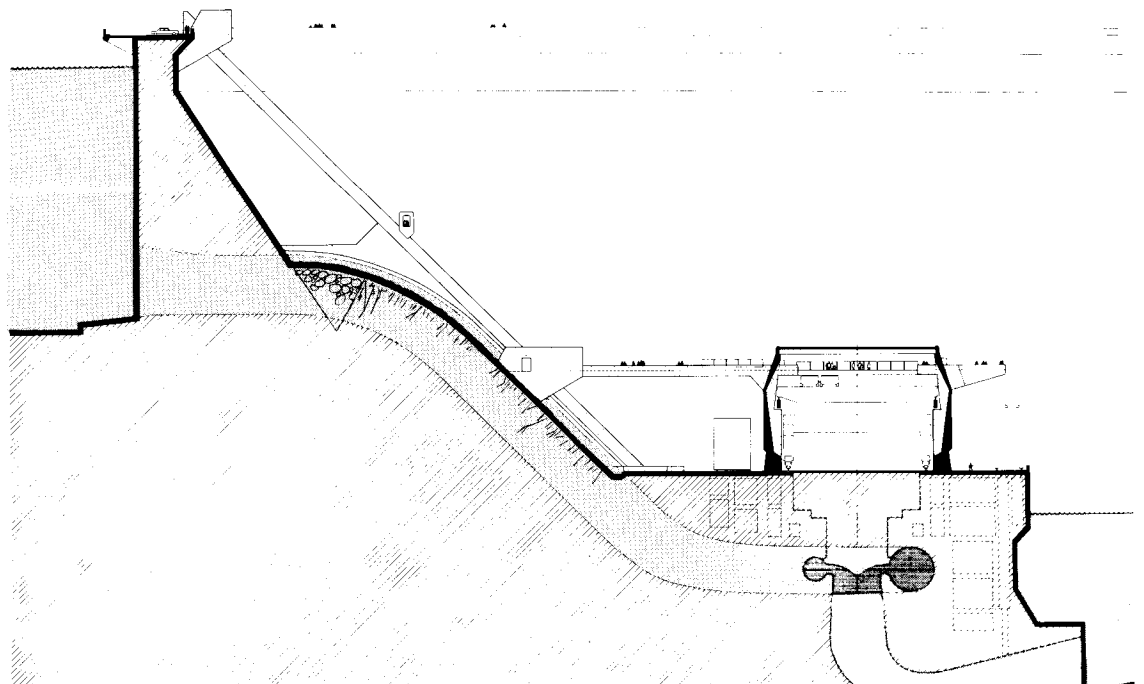
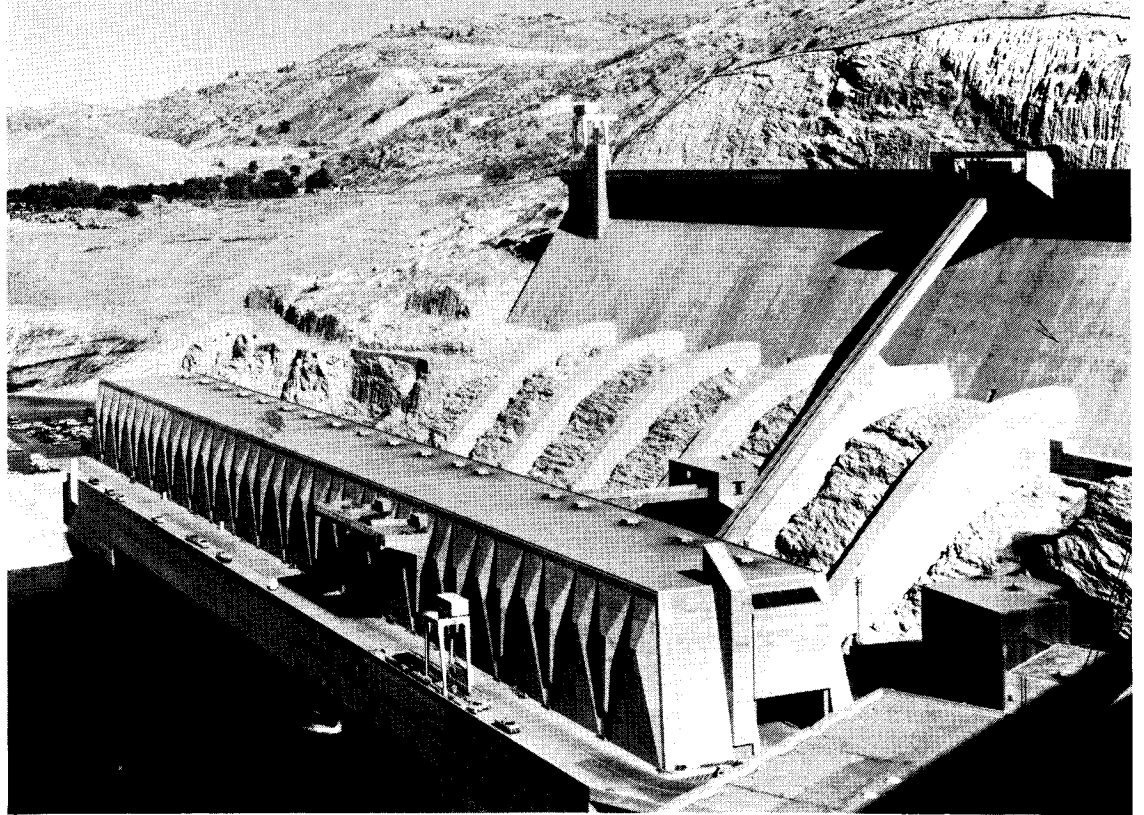

BRIDGE, BUREAU OF RECLAMATION

For so extraordinary a site—a steep-walled canyon in northern California to be inundated when the proposed Auburn Dam is completed in 1981—no ordinary suspension system seemed feasible. The depth of water, more than 400 feet, obviated mid-span submersible pylons, and the valley's sheer walls made deep approach cuts costly and environmentally unsound. After extensive study, T.Y. Lin International/Hanson Engineers with SOM's Myron Goldsmith settled on the horizontal arc design shown above. This solution minimizes the cuts, eases the alignment problems to mountain roads, and reduces the sense of intrusion into an otherwise natural site. The

forms, in an important way, grow right out of the site conditions. The curving, 1300-foot bridge deck—which carries two traffic lanes, a pedestrian way and a horse path—will be suspended from a spray of cables anchored to the valley walls. Located in an active earthquake zone, the proposed design performed well in seismic tests and the cables will be encased against fire.

The Ruck-A-Chucky Bridge proposal is a wonderfully sympathetic Federal response to the need for imagination and quality design in a project of this scope and complexity. A number of more conventional designs were discarded in favor of this innovative solution.

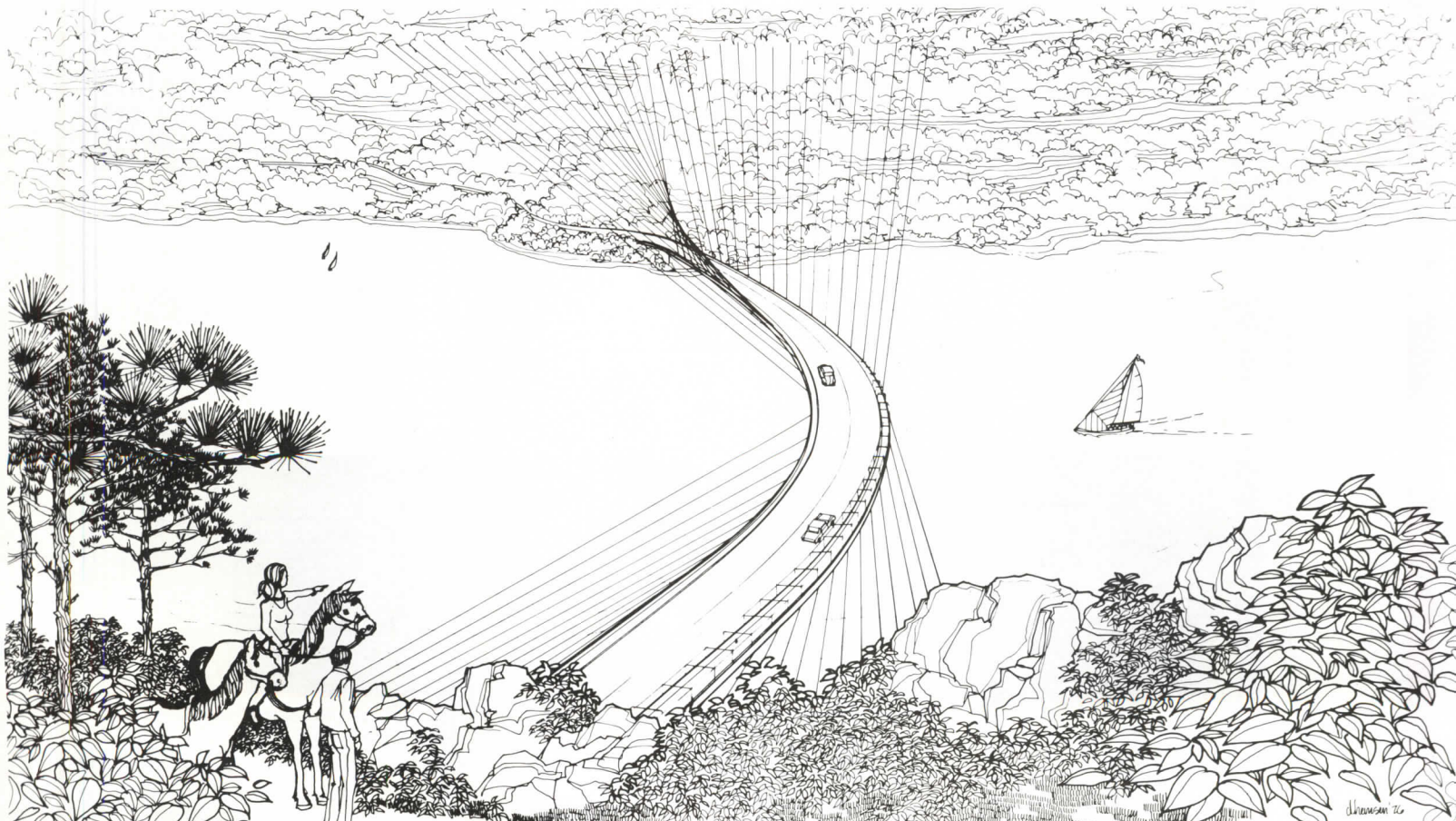
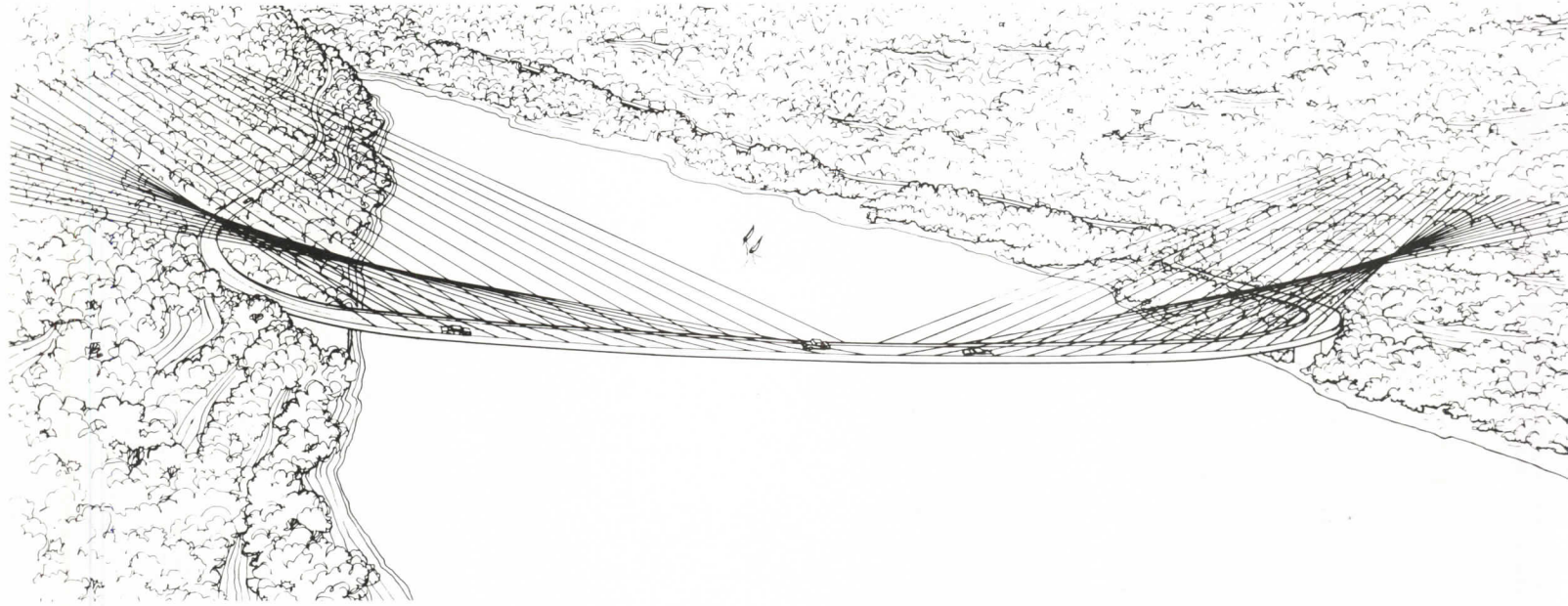
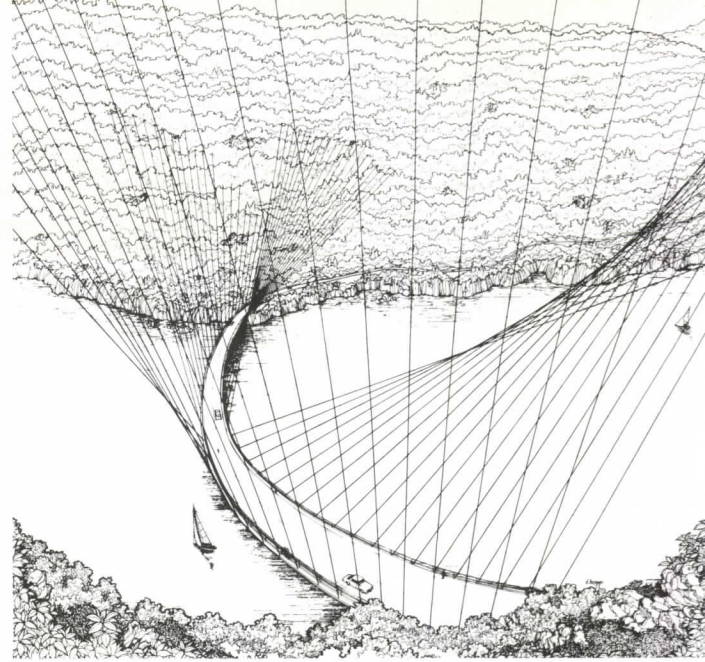

LABORATORY, ERDA

This new laboratory, specializing in the analytical chemistry of radioactive materials, is sited in a Federal research complex of semi-industrial character at Argonne, Illinois. This U. S. Atomic Energy Commission was the agency first responsible for planning the project, and Metz Train Olson & Youngren were selected as architects on the basis of a similar (but non-governmental) project they had just completed at the University of Chicago. Well into project development, AEC was dissolved to make way for the U.S. Energy Research and Development Administration (ERDA), a switch that complicated the already complex project administration. From that point forward, says MTO&Y's

designer Howard Pederson, "we were confronted simultaneously with two project coordinators—each with his particular requirements and concerns which were not always congruent."

Project guidelines, particularly the technical guidelines, were well prepared and the laboratory's Director, Dr. Charleton Bingham, was a superb client in his ability to make sound and far-sighted judgments easily and quickly. The architects report that the agency's administration procedure called for more than the ordinary number of "checkpoints" or reviews, and that contract documents were unusually detailed. In retrospect Pederson says: "Our para-

mount concern was the diffusion of responsibility that occurs when a project is checked and rechecked and parts of systems modified in order to fulfill obscure criteria. A responsibility gap develops . . . the issue of who is responsible for what becomes dangerously out of focus.

"If the taxpayer is to get the most for his money, the Federal Government must give the A/E full project responsibility with all the liabilities that connotes. . . ."

In spite of the frequent need for review and the stop-and-start design process, the Argonne Laboratory is a fine piece of design, carefully structured and sensitive to the needs and the safety of its users.



Philip Turner photos

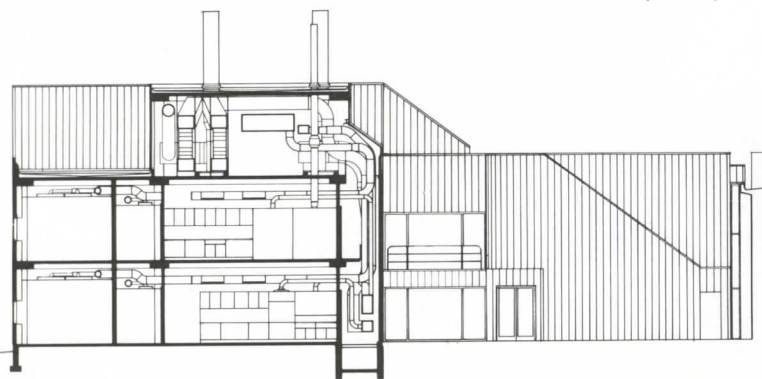
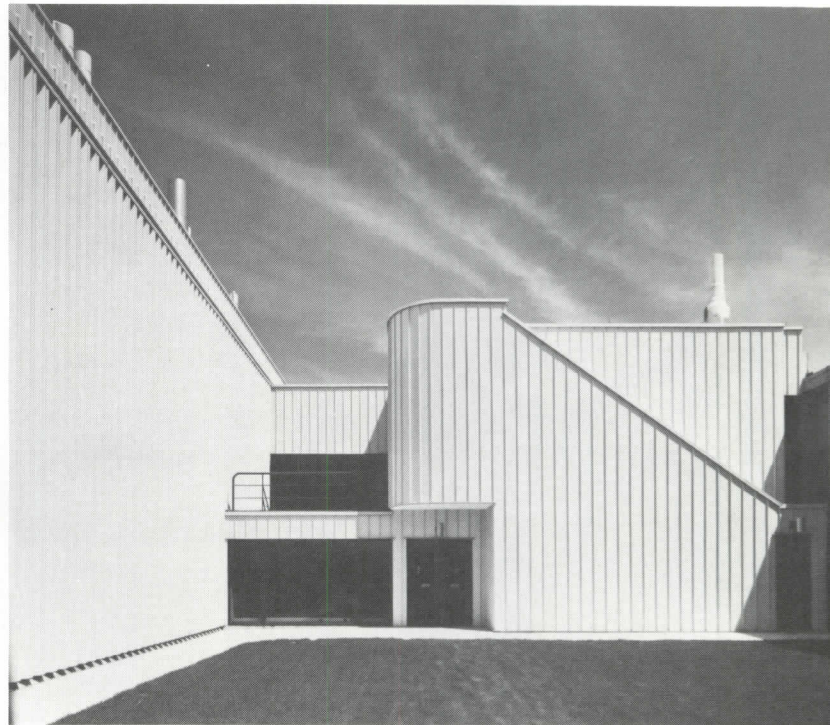

VISITORS' CENTER, U. S. ARMY CORPS OF ENGINEERS

"It was professionally rewarding," says a spokesman for the architects, "for our firm to have been involved in a project with our local Army Corps of Engineers in which we were not only given an extraordinary degree of freedom with regard to the original designs and conceptualizations, but were later afforded considerable latitude as major issues were raised."

Architects Cromwell, Truemper, Millett and Gatchell go on to say that though minor differences arose between architect and client, nearly all were compromised out satisfactorily and there was "little of the bureaucratic conservatism" that has sometimes discouraged architectural de-

sign innovation in the past.

The new visitors center, adjacent to Table Rock Dam, responds in its massing and materials to the Dam itself. A physical link in the form of a walkway was also established to reinforce the connection—a connection the architects sensed they had to develop if visitors to the dam site were to find their way to the center. The internal exhibits, on the theme of Man's adaptation to his environment, (see photo bottom right) were constructed of colorful tissues and overlays that were carefully backlit.

utes to the design's obvious quality and broadens the project's public appeal.

The architects had been contacted initially by the Corp's Chief of Operations Bill Spencer and contracting officers Homer Rabjohn and Roger Wilcox. They said, in substance, that the Corps wanted to keep a low profile and provide visitors to the site with something of value, a learning experience in which something of cultural significance would be communicated.

That is exactly what happened and the architects report that they "went about their task and completed it with a new sense of optimism about the future."

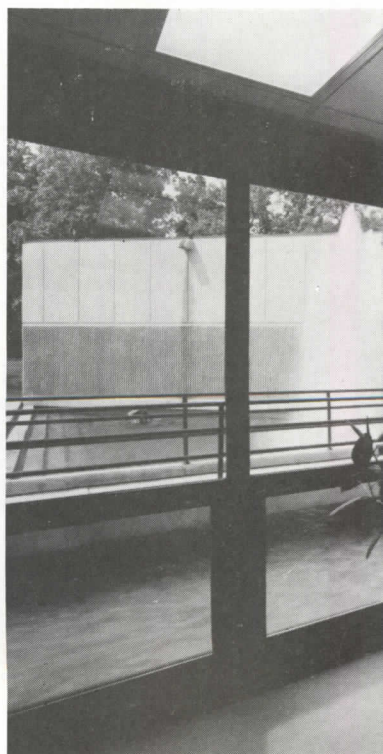
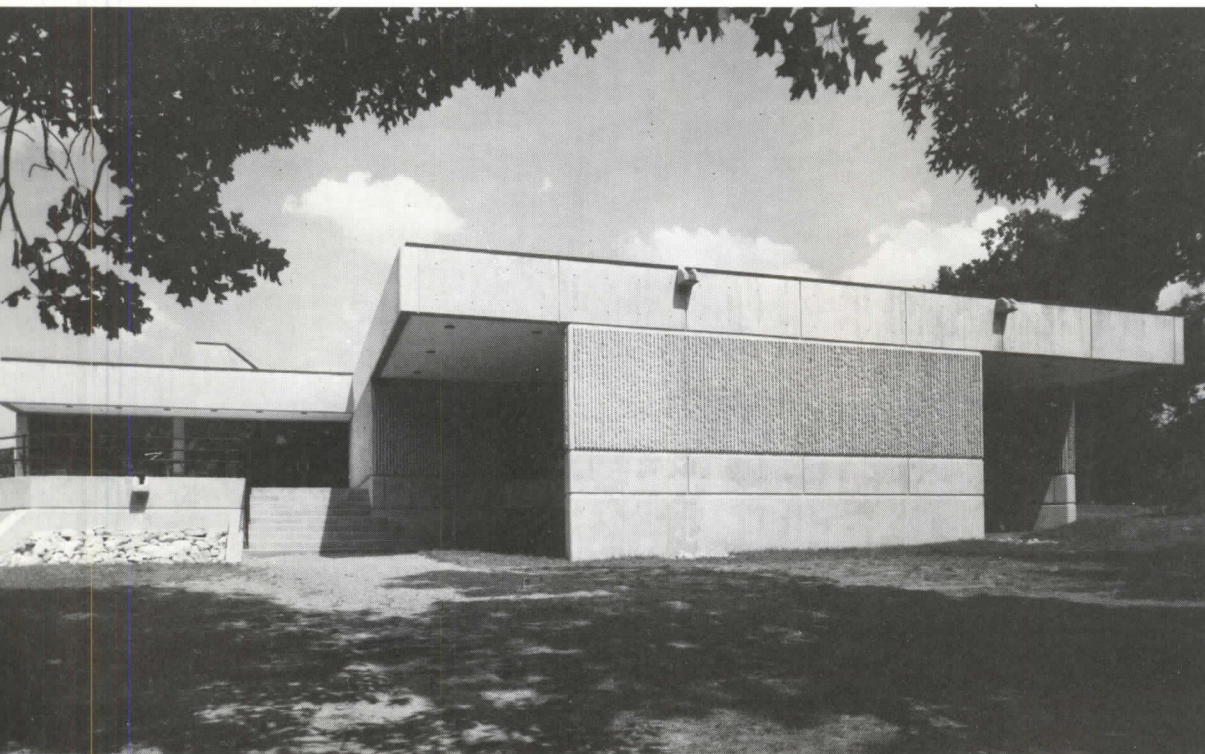
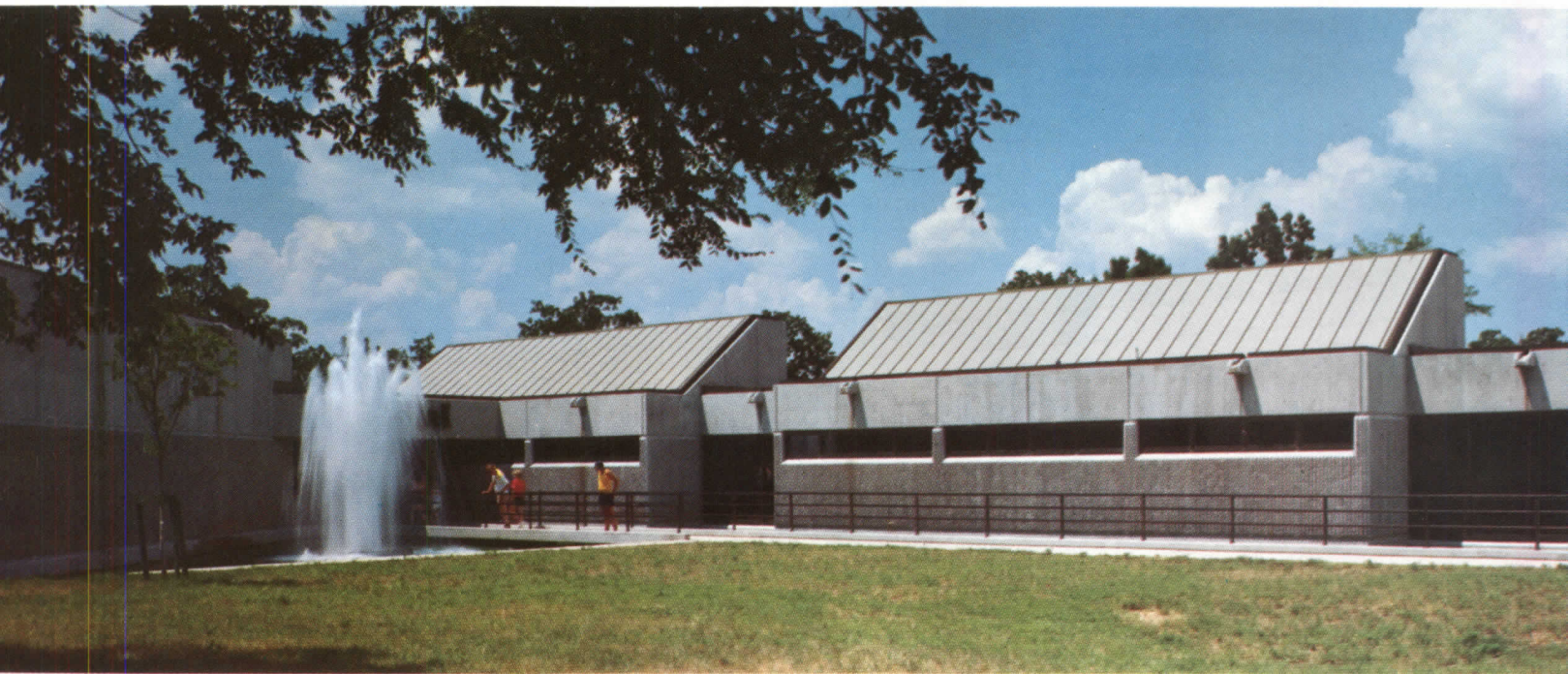

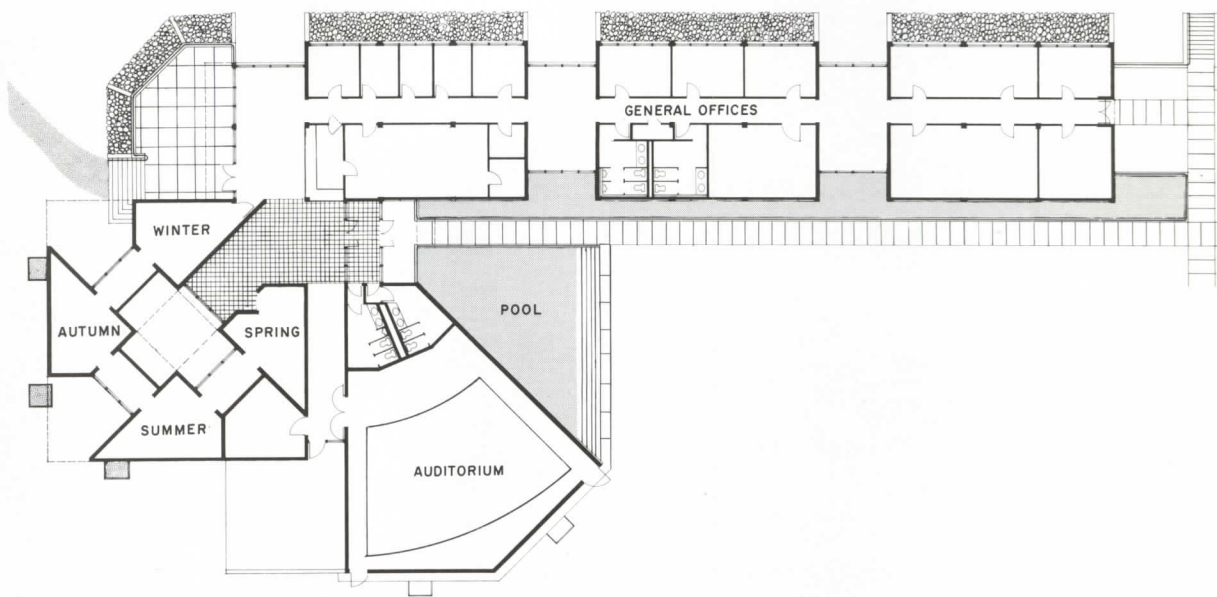
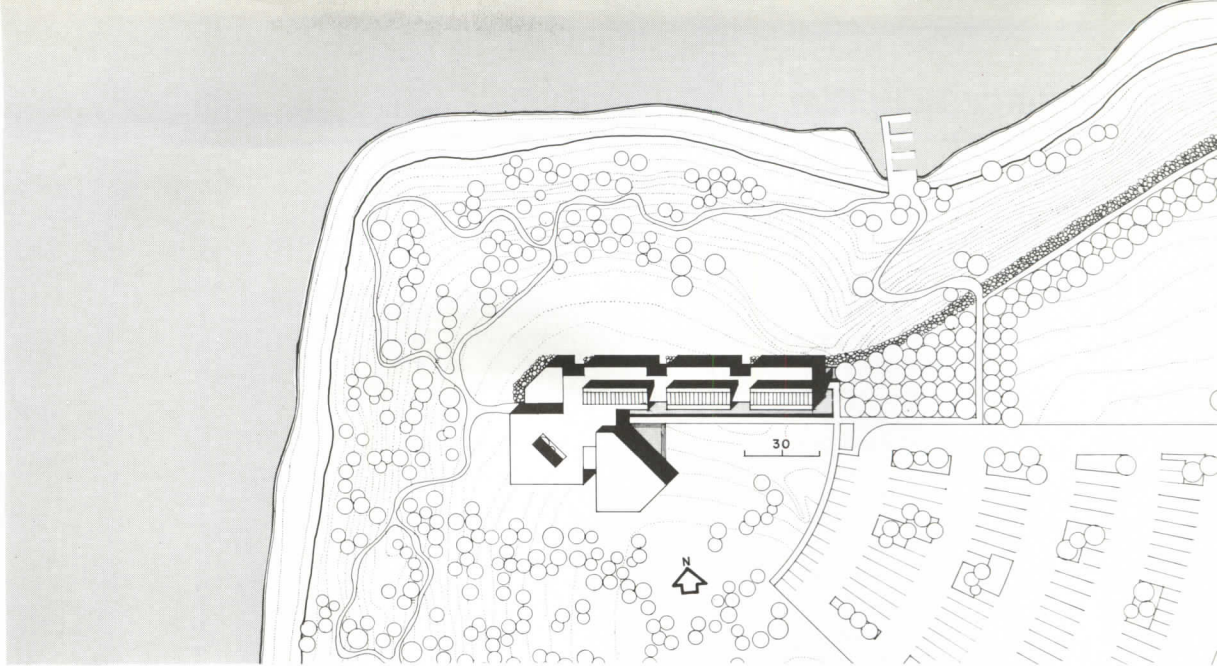
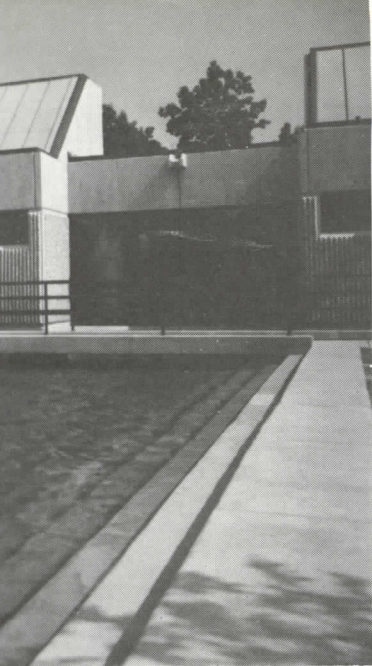

Otto Baitz photos

AIR FORCE HOSPITAL

Kaplan/McLaughlin/Diaz was retained by Western Division Naval Facilities Engineering Command to design a 320-bed medical facility to replace the obsolete David Grant Medical Center at Travis Air Force Base in California. User groups will include not only base personnel and their dependents, but a fluctuating level of patients evacuated by air to Travis from bases across the Pacific.

The architects were asked to prepare three schemes, each distinctly different from each other but each satisfying the program drafted by the Air Force. Two schemes were eliminated after design review by Air Force Medical consultants. The scheme selected was then developed

intensively by the architects in close cooperation with representatives from the armed services. "The Navy was a unique client" says the report prepared by the architects, "in that it had an equivalent for all the disciplines on the A/E team. They conversed in the same language and were acutely aware of the problem-solving issues that architects and engineers face."

In addition, to the preparation of plans, the architects and their consultants were required to prepare a substantial number of detailed reports to document their various recommendations.

The final design will include 32,000 sq ft of solar collectors.

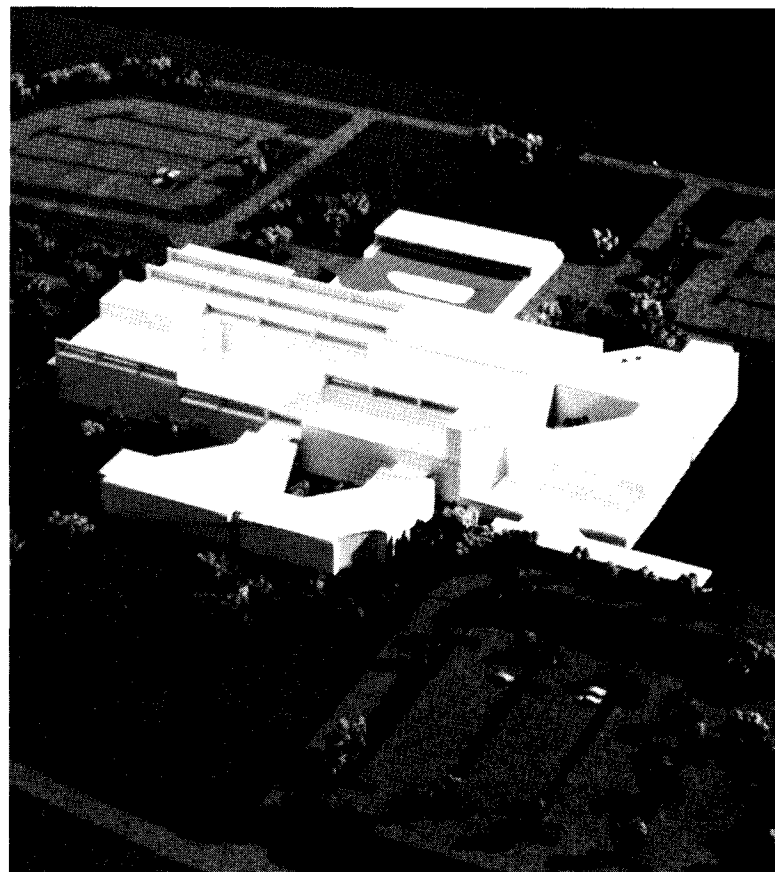
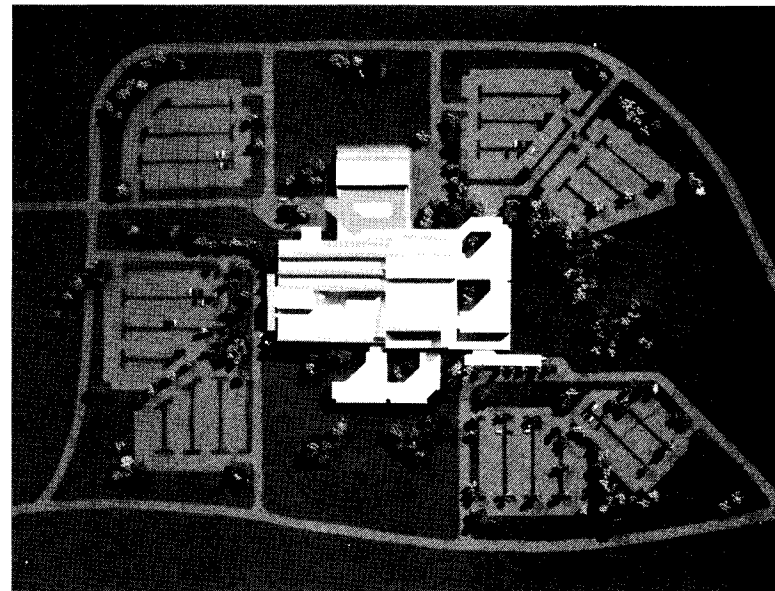
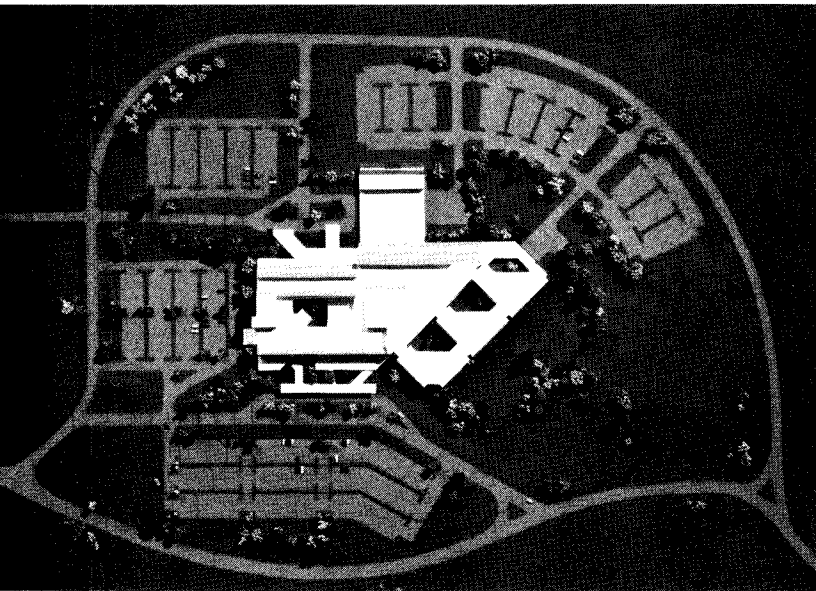

VETERANS ADMINISTRATION CHAPEL

Originally put forward by the Gold Star Mothers of St. Louis, the idea for a non-sectarian burial chapel at Jefferson Barracks National Cemetery went first to the Army and then to the Veterans Administration where officials saw its potential value and planning began. Project architects Dennis Hancher and James McCord, both from the Veterans Administration's Office of Construction, set to work on design.

The rounded and angular forms of the finished chapel come together over the nave in a striking profile. It is devotional space of a special kind, used almost exclusively for burial services and shaped to give symbolic emphasis to the mystical divide

between life and death. The chapel's siting, at the center of a small "island" hints at a similar symbolism. That such metaphysical, even poetic concerns, could shape a Veterans Administration Chapel will come as a surprise to some who think of the VA primarily in terms of hospital design, where strict and carefully proscribed standards are both inevitable and desirable. In the rare case of a VA chapel, no such constraints applied and the designers were able to proceed with greater freedom.

The willingness of the Administration's officials to accept the risk always inherent in innovative design of this special kind is also noted and applauded.

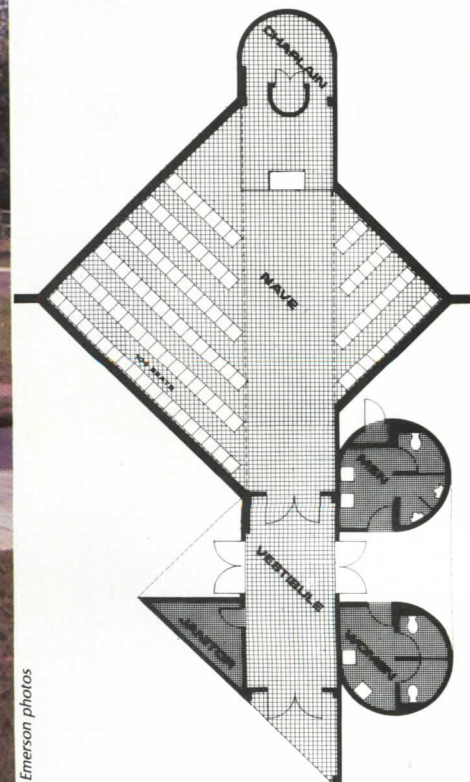
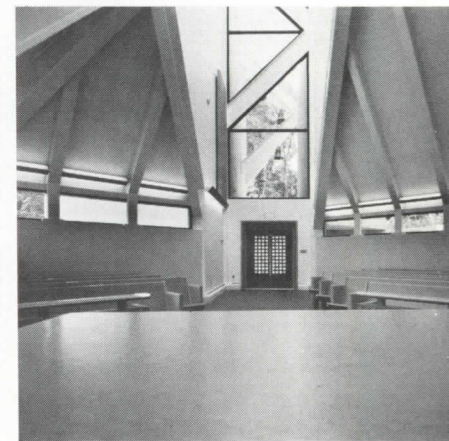
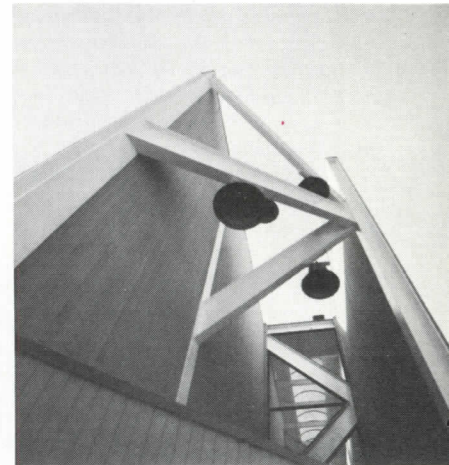

L. Emerson photos

BORDER STATIONS, DEPARTMENT OF JUSTICE

But for its red, white and blue supergraphics, the new border station at Scoby, Montana looks a lot like the old barns and saw mills that have long dotted this region on both sides of the Canadian border. That simple, welcoming, efficient but friendly quality is just exactly what Minneapolis architects Hodne/Stageberg were after when they were selected with five other finalists to enter the second and last stage of an innovative competition sponsored jointly by the Immigration and Naturalization Service along with the National Endowment for the Arts.

A panel of Bill Lacy, O'Neil Ford and Immigration Service Chief Engineer W. A. Morris had sifted through

credentials from 148 firms before settling on the six finalists. The finalists were invited to Seattle, expenses paid, were given the program for the border station and asked to treat it as a three-hour sketch problem. "No very definite architectural solution need emerge," the finalists were told. Instead, the panel would be interested in the thought processes, analytic ability and sensitivity of each competitor. The Hodne/Stageberg proposal won and is now being implemented—first at Scoby and then, in a companion design, at Boundary, Washington. A third station, this one in Yuma, Arizona, is now under construction. For Yuma, the architect selection process was

very similar except that Roy Knight replaced Bill Lacy for the Endowment and Dean Ronald Gourley was added to the panel. When the competition was over, the winner was Architecture One, Ltd. of Tuscon—a firm that had done no Federal work before (photo lower right).

There seems little doubt the lively innovative selection process has led to equally innovative solutions and that small firms not heretofore considered for Federal work have been allowed to make important design contributions. Many hope it can continue at least for small-scale projects where an accumulated technical expertise does not appear to be an essential precondition.

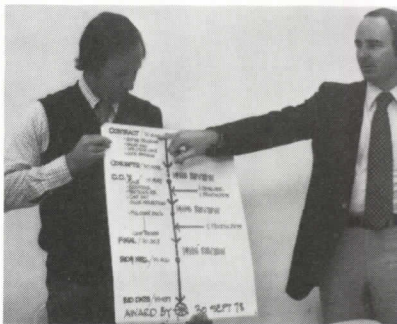
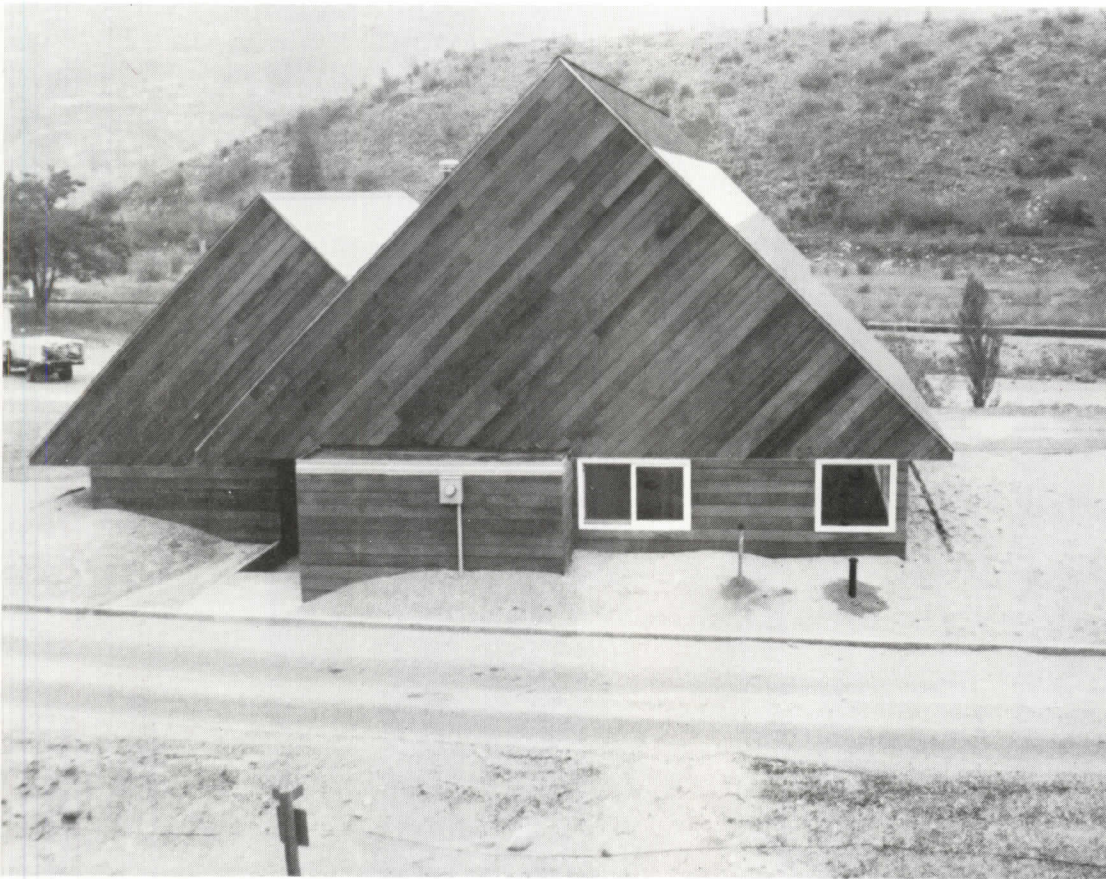

VETERANS ADMINISTRATION HOSPITAL

This 400-bed VA Hospital, now in design development by RTKL, will be located next to University hospital on the downtown campus of the University of Maryland in Baltimore. It will provide a full range of medical and surgical specialties as well as a variety of support facilities including no less than three full levels of underground parking.

The design has to pass not only the VA's own "good looks committee" but because it will occupy a site in a renewal area, it must also be approved by a joint city/state review committee. RTKL's Sandor Csobaji points out that the project has had a high level of client input and participation but, in spite of that, the archi-

tecs are commissioned for a full range of design services and are encouraged to develop and examine innovative design ideas.

The design will incorporate the latest in medical technology and patient services but is carefully planned to minimize unnecessary circulation and take maximum advantage of its proximity to University Hospital. To satisfy the campus context, brick pavers will be used inside and out. The principal finishes, however, will be metal skin and solar glass—an acknowledgement that the new hospital will be a high-tech addition to an old, established campus.

Joining RTKL for this project are CSD/ and Henry Adams.

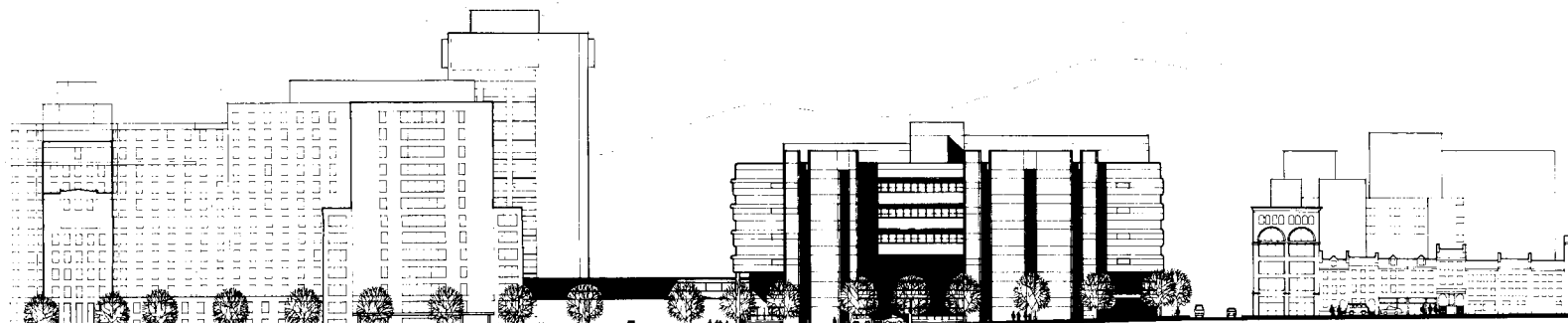
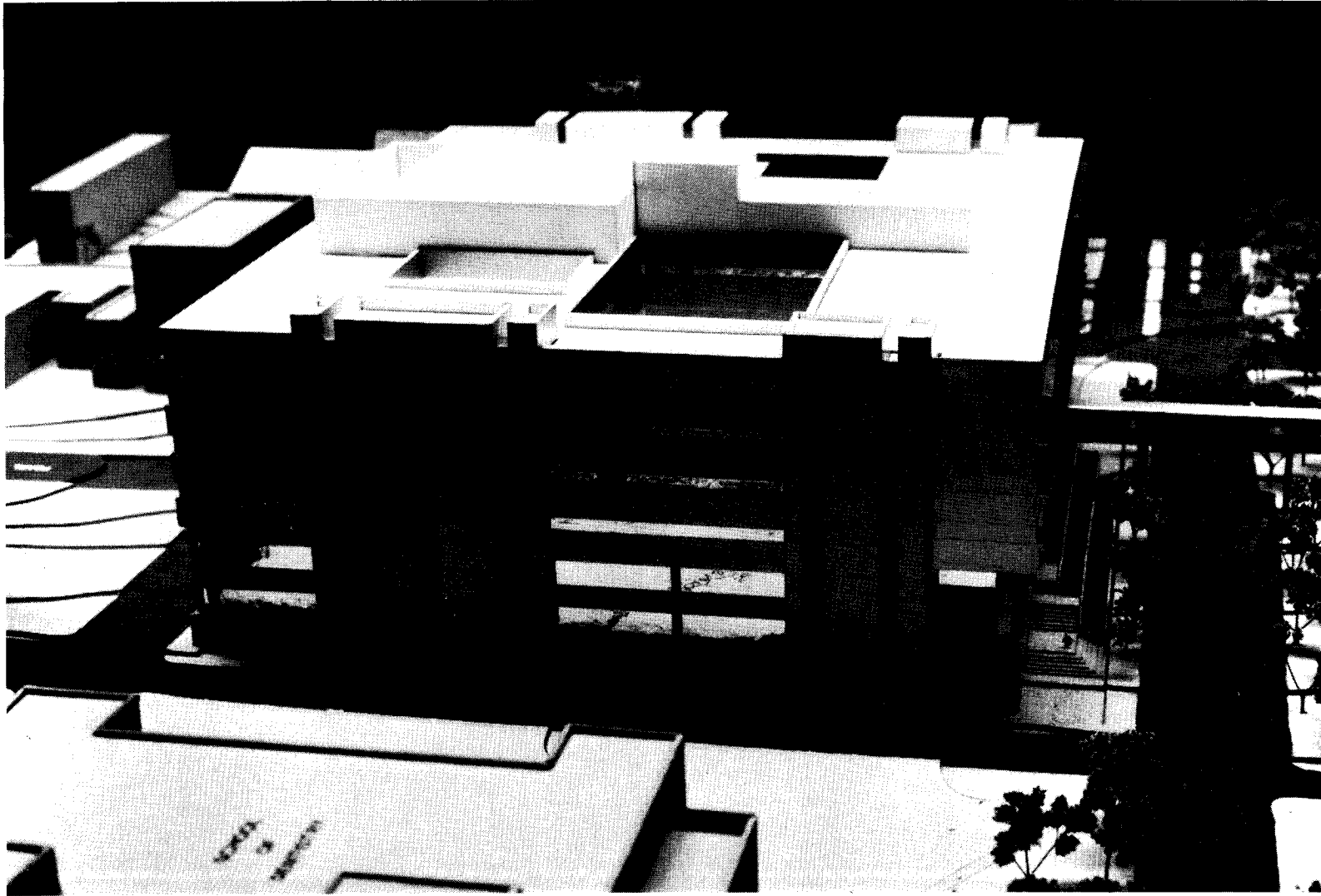
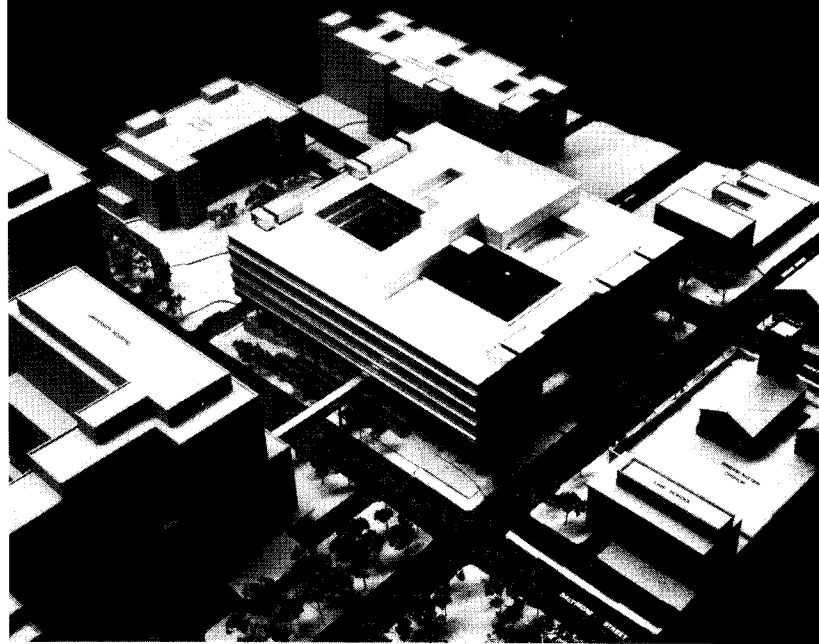

UNIVERSITY OF MARYLAND HOSPITAL, NORTH WING

V. A. HOSPITAL

AGENDA FOR QUALITY



Franklin Delano Roosevelt as Commander-in-Chief, a bronze bas relief by Leonard Baskin, will be in the Roosevelt Memorial, designed by Lawrence Halprin.

When the original Guiding Principles for Federal Architecture were issued in 1962, they were seen as a clarion call for quality. But principles, even those emboldened by the Presidency, do not necessarily become policy, informing the procedures of agencies or the character of public laws. Seventeen years, and four Presidents later, the call from Camelot is being answered in more pragmatic policy terms. The White House Cultural Policy Group, the National Endowment for the Arts, the General Services Administration, the Department of Housing and Urban Development, the Department of Commerce, the Council on Environmental Quality, the American Institute of Architects—all are in the process of pushing for various versions of a policy for the design of Federal and Federally-assisted facilities. ARCHITECTURAL RECORD, in the hope that a strong Executive Order will result from such initiatives, and in the belief that such a step is basic to ensuring quality, offers this agenda for action.

- The Federal Government, in fulfillment of the letter and spirit of the National Environmental Policy Act of 1969, should take the lead in requiring all agencies to factor the finest impulses and abilities of the architectural, urban design, and environmental planning professions into their deliberations, decisions, and dealings. Design quality, in the planning, procurement, and operation of facilities, should be insisted upon so that all facilities embody an interdisciplinary understanding of the built environment's human, cultural, and economic impact.

- Facilities should be looked upon as, more than passive functional and structural packages, opportunities to enhance the natural, physical, cultural, and economic context of the communities in which they are built. They should be designed and operated to conserve resources and energy, with a studied, supportive attitude toward life-cycle budgeting. Wherever practicable, agencies should look for existing structures of historic, cultural, or architectural significance as sources for Federal space, considerably adapting them for present-day needs. Whether dealing with older buildings or districts in this spirit or building anew, Federal facilities should be designed to include people-pulling activities of a cultural, civic, commercial, retail, recreational, or educational nature.

- The impact of Federal facilities should be considered in light of existing or projected patterns of local transportation, terrain, utilities, and other systems of community service and support. No public building, and no building or other physical development whose design and construction are assisted by Federal funds, should be approved unless these inter-related considerations have been taken into account. The review-and-approval process, not to mention that for selecting architectural and engineering services in the first place, should be informed by agency personnel and outside advisors who embody strong design experience and strong design sensibilities. Public advisory panels, relative to interviewing, selecting, and evalu-

ating public design should be strengthened, and the members of such panels should be determined by objective appraisal of their experience, integrity, and imagination. At the same time, in counsel with the Civil Service, the Government should employ more design-oriented registered architects to work within the agencies, encouraging their movement into policy-making ranks.

- All agencies should appoint a top-level, well-qualified professional as design counsel to activate, evaluate, and improve policies, procedures, and programs that can enhance the agencies' mission, image, internal efficiency, and public performance. The head of each such office should be appointed to a National Design Council, its chairman, deputies, and staff to be appointed by and responsible to the President. The Council, drawing on the resources of the agency representatives, its staff, and professional societies, should organize a Government-wide design awards program to be conducted annually, issue an annual report to the President and to Congress, work to strengthen this proposed liaison for enlightened design throughout the Government and, in consultation with its membership and the resources of the American Institute of Architects, advise and assist agencies in developing a design-competition approach in order to secure the best possible range of ideas for requested projects or facilities. The mandate of the Council should carry with it the responsibility for advising on the economic, sociological, and environmental ramifications of facilities design, while also working with agencies to ensure selection and support of top-notch creative talent. The National Design Council, even as it informs the character of agency programs, even as it includes the design counsels of all agencies, should be separate from any grants-making unit of the Government. The imprimatur of the Presidency should be upon it, but its operations and inter-agency relationships should be flexible, lending support to, but not supplanting, independent design improvement initiatives where they appear.

- All Federal agencies should recognize that programming and preliminary planning are the core of design creativity, and should involve selected designers at the earliest stages of a project. Regulations, constraints, the huge inventory of preconceived, calcified requirements, and the massive amount of paperwork customarily demanded should be simplified to create a warmer climate for the creative response and participation of design firms of many sizes—giving a chance to smaller talented organizations.

Does America need a design policy for Federal facilities, or is this just one more noble desire? As Louis Kahn said, "Beethoven did not need the Fifth Symphony. He desired it. Which is why we need it now." Nothing could be more practical if America indeed wants to be remembered in history as a society with a creative soul, and if America deserves an architecture as good as its people are.

For more information, circle item numbers on Reader Service Inquiry Card, pages 191-192

Quality design and lighting efficiency highlight task lighting

A clearly designed and versatile new system of task lighting fixtures has been designed by SPI Lighting, the Area Lighting Division of McGraw-Edison Co. The SPI task lights include six variations (far left)—each using a small 8-watt fluorescent lamp. Two of these units reduce energy consumption

by 50 per cent over a 40-watt fluorescent strip light, when combined with proper ambient lighting levels. Unlike many task lighting fixtures, these models are designed for placement at the sides of an employee's work station. The different mounting methods make the fixtures adaptable

for both open and private offices; they can be integrated with any furniture system. The patented optics direct more than 80 per cent of the light at the work station (drawing left).

■ SPI Lighting, Area Lighting Division, McGraw-Edison Co., Racine, Wis.

circle 300 on inquiry card

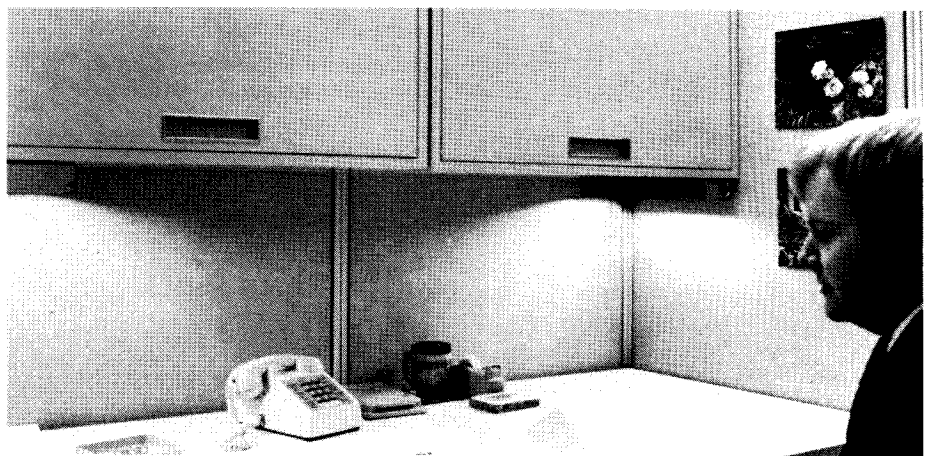
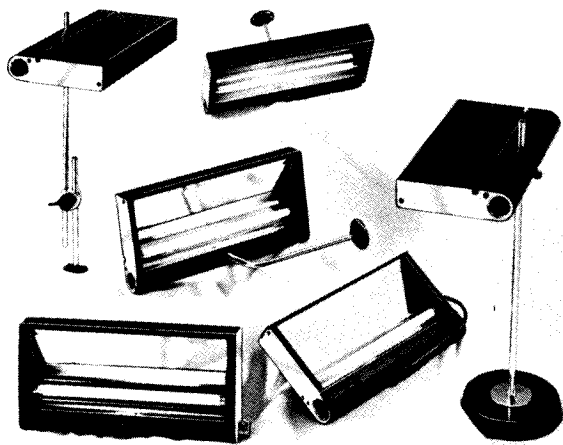
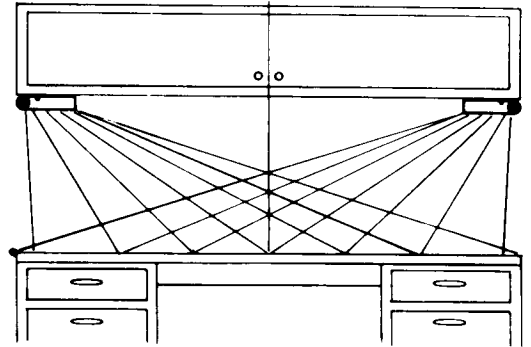

Durability and esthetics are hallmarks of roofing/siding system

A distinctive roofing and siding system is claimed to be the only field-formed, roll-formed product of its kind. Called C/S Cot-R-Cap, it was developed to solve a variety of application problems, combining the

durability of batten seam metal roof with modern roll forming technology. It can be formed at the job site; and is available in aluminum, galvanized steel, stainless steel, copper, copper clad and other metals. Eight colors are available. ■ Construction Specialties, Inc., Cranford, N.J.

circle 301 on inquiry card

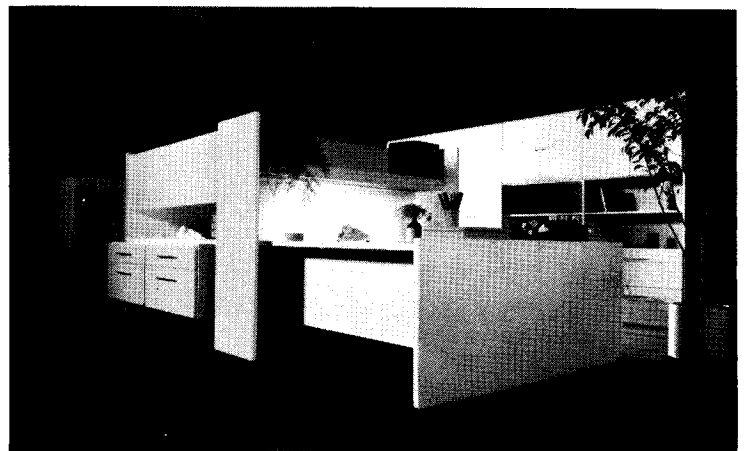

Modular furniture arrangement introduced for offices

A modular office system has been introduced by Discovery Concepts, Inc. that stresses the diversity of units, from open to closed office units. The system includes a wall collection that varies in heights from 30- to 80-in. for open office plans, and as much as 92½-in. height for floor-to-ceiling installations closing off private offices or conference rooms.

The system's parts are interchangeable, including the secretarial station shown above. The company calls itself one of the first to provide "off the shelf" modular installations, thereby trimming costs in materials and installation time.

■ Discovery Concepts, Carlstadt, N.J.

*circle 302 on inquiry card
more products on page 147*

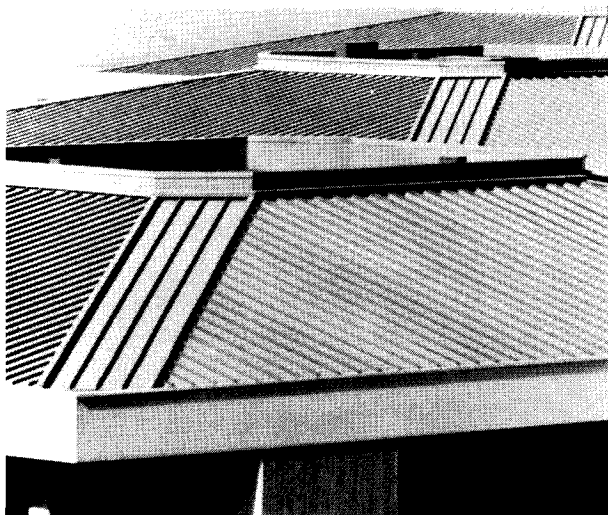

Anywhere in the world you're building... McGRAW-EDISON products are already accepted



McGraw-Edison
International Sales Corporation
1275 Davis Road
Elgin, Illinois 60120 U.S.A.

McGRAW-EDISON

We make life easier all around the world.

Circle 65 on inquiry card

For more information, circle item numbers on Reader Service Inquiry Card, pages 191-192

CONTRACT CARPETING / The product characteristics and advantages of carpeting made of *Zeflon 500* solution-dyed nylon are discussed in an 8-page specification brochure. *Zeflon* yarns said to have the heathery appearance of wool, are offered in 25 colorations. ■ Dow Badische Co., Williamsburg, Va.

circle 400 on inquiry card

CUT-PILE CARPETS / Yarns specifically engineered for use in heavy-duty commercial carpeting are described in a 4-page booklet on *Zeflon* subdued luster nylon. Cut-pile contract fabrics in solid and heather colorations are shown. ■ Dow Badische Co., Williamsburg, Va.

circle 401 on inquiry card

SOFT WALLCOVERING / An "Information File" provides actual samples of *Brunswall* textured non-woven wallcovering, and includes sound-absorption test results, static properties, and other technical data on the Class A rated, ASTM-E-84-70 tested, modacrylic, polyester or olefin fiber product. ■ Brunswall Div., Brunswick Corp., Libertyville, Ill.

circle 402 on inquiry card

PLUMBING FIXTURES / Full-line and condensed versions of this manufacturer's current plumbing fixture catalog are now available, covering general plumbing products, laboratory service fittings, food service equipment and hospital/medical specialties. The General catalog is 90 pages; the shorter edition highlights major products within each of the four plumbing lines. ■ T & S Brass and Bronze Works, Inc., Travelers Rest, S.C.

circle 403 on inquiry card

WATER CONSERVATION FIXTURES / This current application and reference catalog features nearly two dozen water-saving plumbing products, including faucets, fittings, valves and special use items. ■ T & S Brass and Bronze Works, Inc., Travelers Rest, S.C.

circle 404 on inquiry card

VAV SYSTEM / Both single- and multiple- space applications of this maker's "RSV" variable Air Volume comfort conditioning system are shown in an 8-page color brochure. The rooftop units exceed ASHRAE 90 EER standards, and reduce or eliminate reheat requirements. Air flow and temperature control features are explained. ■ ITT Nesbitt, Philadelphia.

circle 405 on inquiry card

SAFETY FIXTURES / Industrial and commercial safety fixtures, including drench showers, eye wash fountains, combination and portable units, are pictured in a 24-page short-form catalog. Swing-down eye wash fountains, are featured; technical data and dimensional drawings are given for each safety fixture. ■ Bradley Corp., Menomonee Falls, Wis.

circle 406 on inquiry card

LAVATORIES / Enameled cast iron and vitreous china lavatories are shown in an 8-page color booklet. Self-rimming basins are pictured in countertop settings; vanity top lavatories, wall-hanging and corner units, and a full line of faucets are included. ■ Kohler Co., Kohler, Wis.

circle 407 on inquiry card

SOLAR COLLECTORS / A full-color brochure explains how high-performance solar panels are designed to work effectively within a watertight structural skylight system. Detail drawings illustrate construction and installation features of the aluminum-framed integrated roof system; collector performance is presented graphically. ■ Chamberlain Mfg. Corp., Elmhurst, Ill.

circle 408 on inquiry card

CAST IRON PIPING / Soil pipe for complete drain, waste, vent and sewer systems is shown in a 22-page *No-Hub II* stainless steel coupling is featured; complete dimensional and cost information is given for each pipe type. ■ U. S. Pipe & Foundry Co., Soil Pipe Div., Chattanooga.

circle 409 on inquiry card

EMERGENCY EXIT LIGHTING / UL-, NFPA-, and NEC-approved battery-operated exit and directional lighting units are shown in product literature. Lights transfer from normal to emergency mode instantly, without lamp outage. Two standard fluorescent lamps provide high panel brightness for a minimum of two hours of emergency illumination; 24-hour rechargeable lead battery has a 10-year life expectancy covered by a pro-rata warranty. ■ McPhilben Lighting-Emerson Electric Co., Melville, N.Y.

circle 410 on inquiry card

RESIDENTIAL-COMMERCIAL FIXTURES / A complete line of water-saving plumbing fixtures and fittings, designed to perform efficiently with significantly lower water usage, are included in a commercial/residential fixture and fittings catalog. Incorporated with each fixture presentation is a chart of water usage at various water pressures, data developed in independent laboratory tests. ■ Eljer Plumbingware, Div. Wallace Murray, Pittsburgh.

circle 411 on inquiry card

UNDERFLOOR POWER DISTRIBUTION / "Making the Workstation Work" is an 8-page brochure showing how this flush electrical/communications floor outlet system serves to activate open office layouts with minimum casual wiring. The *Q-Floor Taproute* raceway permits activation of a typical workstation in 47 minutes, at an average cost of \$30.00, according to the literature. ■ H. H. Robertson Co., Pittsburgh.

circle 412 on inquiry card

KITCHEN SINKS / Cast iron kitchen sinks are pictured in place, in all 15 available fixture colors. One-, two-, and three-compartment sinks and acrylic bar units are shown; accessories include faucets, cutting boards, and built-in garbage disposal basins. ■ Kohler Co., Kohler, Wis.

circle 413 on inquiry card

ROOF-MOUNTED AC / A 32-page bulletin explains how the *EnerCon* reverse-cycle air conditioner system operates, and how the roof-mounted system interfaces with the unit air conditioners. It includes descriptions of design features; engineering data such as cooling and heating capacities, fan performance; and electrical data. ■ American Air Filter Co., Louisville.

circle 414 on inquiry card

McGRAW-EDISON

International Sales Corporation
1275 Davis Road
Elgin, Illinois 60120 U.S.A.

Please send information on the following products:

THOMAS A. EDISON and COOLERATOR room air conditioner and condensing units

SPEED QUEEN domestic laundry equipment

SPEED QUEEN and HUEBSCH commercial laundry and dry cleaning equipment

MODERN MAID kitchen appliances

TOASTMASTER small kitchen appliances

ARCTIC CIRCLE and WRIGHT evaporative air coolers

HALO commercial lighting equipment

SHOPMATE power hand tools

BUSSMAN fuses

NAME _____

COMPANY _____

ADDRESS _____

Love to look at architecture *people live in?*

See some of today's most interesting and important design ideas for the custom house in . . .



A TREASURY OF CONTEMPORARY HOUSES

Edited by
Walter F. Wagner, Jr., AIA

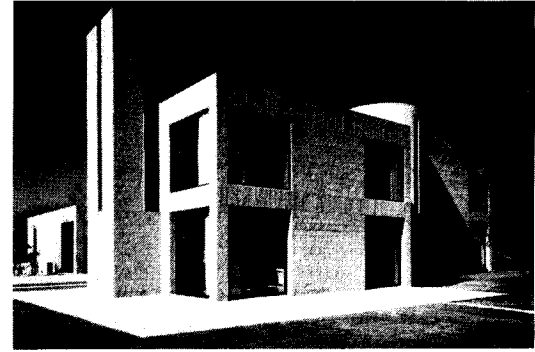

James Brett



Balthazar Korab

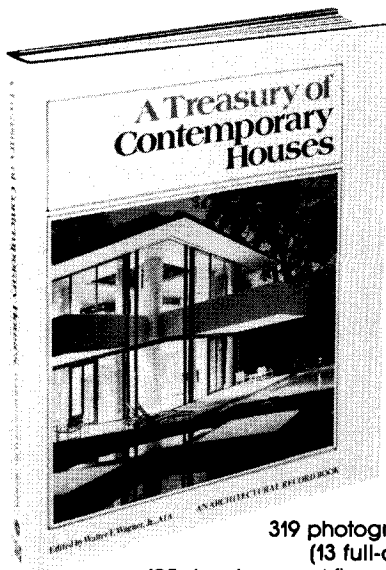

319 photographs
(13 full-color)

• 125 drawings and floor plans
• 187 pages • 9 x 12 inches • \$18.95

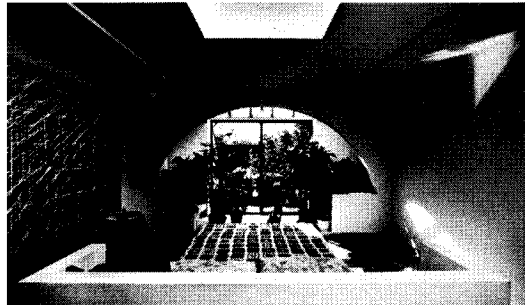

Robert Lautman

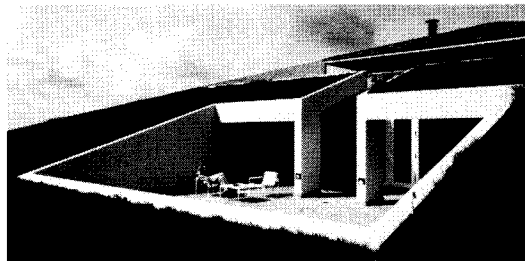

Creative Photographic Service

Both inside and out, the 53 very personal houses you'll explore in the pages of this lavishly illustrated volume are contemporary and striking. Each is a rich lode mine of ideas for new designs, new concepts, new ways of combining spaces to meet individual needs, traditions, tastes, and highly subjective ideas of what "home" is.

Each design shown was chosen (culled from *Architectural Record* issues and appearing now for the first time in any *Architectural Record* book) because it demonstrates something important about architecture—good

architecture—whether high- or low-budget. And also because it presents a different variation in plan, form, and character, giving both architect and homeowner new options and new perspectives on the ways in which architecture can capture and complement personality.

People who want a house that is truly their own can use this beautiful volume to understand and appreciate their own reasons for liking a particular kind of house—traditional or geometric or romantic or a combination of these—and be aware of why it was designed in a

particular way. For example, you'll visit . . .

- totally modern houses that continue centuries-old regional traditions
- designs that reflect today's new emphasis on energy conservation
- thrilling variations on the simplest shape of all—the box
- dazzling arrangements of "collections of boxes" to form dramatic houses
- inspired, strong designs based on the circle and the 45-degree angle
- forms of houses dictated almost inevitably by their construction materials
- genuinely contemporary houses that are nevertheless completely romantic—dispelling the notion that modern houses are "cold" by definition.

Both architects and clients will find that this volume actually raises their expectations—of what someone can look for in a house that will be a family home for many years, what degree of excellence in the house is in order, how much a really good house can give in comfort and the enjoyment of life.

Hundreds of ideas and design solutions include:

- how simple square and rectangular boxes can give enormous, sprawling, dramatic houses a sense of human scale
- how the box can become extremely sophisticated—and incorporate elegant, exquisitely wrought details
- how historical precedents and images can be subtly woven into the design of a contemporary house to enhance the whole and even make it more contemporary at the same time
- how to treat the difficult design problem of integrating a solar collector into a home aesthetically
- how a graceful arc can help define a house which "springs from and returns to earth"
- how a triangular shape can create one great space in a tiny house
- how, superbly designed, a concrete-block house achieves a sculptural effect with this wonderfully straightforward building material
- and much, much more

USE THIS CONVENIENT COUPON FOR 15 DAYS' FREE EXAMINATION

AR 12-78

Architectural Record Books
1221 Avenue of the Americas, New York, N.Y. 10020

Please send me A TREASURY OF CONTEMPORARY HOUSES (002330-1) for 15 days' free examination. At the end of that time, I will either remit \$18.95, plus local tax, postage, and handling charges, or return the book without further obligation.

Name _____
Address _____
City _____
State _____ Zip _____

**SAVE
MONEY!**

If you remit in full with this order, plus any tax, McGraw-Hill pays all regular postage and handling charges. Full return privileges still apply. This order is subject to acceptance by McGraw-Hill. Offer good only in the U.S.

03K590-4005-3

WE FIT IN

STAINLESS STEEL UNDER COUNTER LAB REFRIGERATORS AND FREEZERS

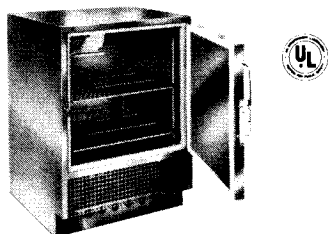

UC-5-BC refrigerator has a blower coil cooling system with automatic off-cycle defrosting and condensate evaporator in condensing unit compartment. Two adjustable stainless steel shelves are provided.

UC-5-F-BC freezer is equipped with automatic timer electric defrost. Capacity—5.4 cu. ft. (155 ltr.)

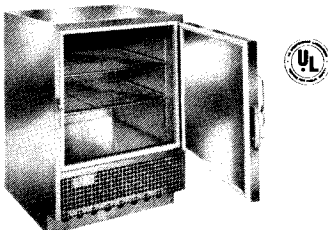

UC-5-CW* refrigerator with cold wall cooling system is equipped with push-button defrost, automatic reset and condensate evaporator. Capacity—5.4 cu. ft. (155 ltr.)

UC-5-F-CW* freezer is equipped with manual hot gas defrost. Capacity—4.6 cu. ft. (130 ltr.)

UC-5-CW-E refrigerator has the same interior features as the UC-5-CW but modified to make it *totally explosion-proof*. Capacity—4.9 cu. ft. (140 ltr.)

*With explosion proof interior only.

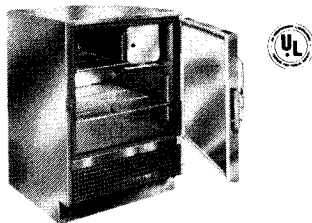

UC-5 features a two-tray ice cube cooling system with manual defrost and stainless steel defrost water tray. The cooler section has two adjustable stainless steel shelves. The entire UC-5 series features polyurethane insulated thin wall construction and air-tight neoprene thermo-break door seals. Capacity—5.4 cu. ft. (155 ltr.)

Jewett also manufactures a complete line of blood bank, biological, and pharmaceutical refrigerators and freezers as well as morgue refrigerators and autopsy equipment for world wide distribution through its sales and service organizations in over 100 countries.



Circle 68 on inquiry card

Refer to Sweet's Catalog 11.20/Je for quick reference.

REFRIGERATION EQUIPMENT /

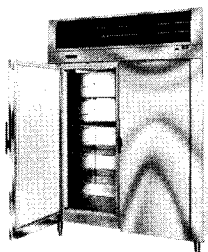

This two-door reach-in unit has a ducted air distribution system, defrost vaporizer automatic cycling control, manually controlled heater, automatic fan shutoff and expansion valve system. The exterior has a flush face design; the unit is available in white

baked acrylic enamel or stainless steel. ■ Nor-Lake, Inc., Hudson, Wis.

circle 303 on inquiry card

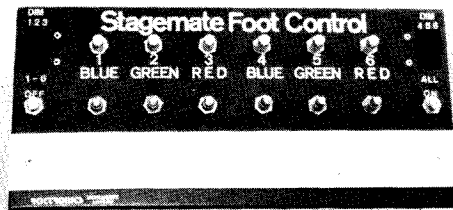

STAGE LIGHTING CONTROL / The *Stagemate* foot control is designed for remote switching, flashing and dimming of stage lights by an on-stage performer. Provided are six on-off switches and a proportional dimming control for brightness.

■ Roctronics Entertainment Lighting, Cambridge, Mass.

circle 304 on inquiry card

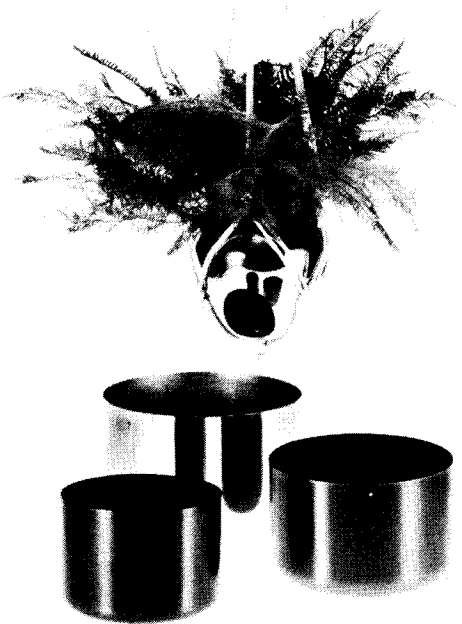

DESK ACCESSORIES / A line of sleek looking desk accessories includes various-sized planters and containers. Different finishes are available to be compatible with existing furnishings. ■ McDonald Products Corp., Buffalo, N.Y.

circle 305 on inquiry card

VINYL FLOOR /

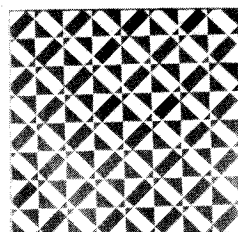

A strong geometric floor pattern has been designed as flooring. The checkerboard is available in 80 color variations. The tile comes in squares, rectangles, hexagons, octagons and stripping. ■ Eden Manufacturing Corp., Bronx, N.Y.

circle 306 on inquiry card

more products on page 149

If we don't have your size...

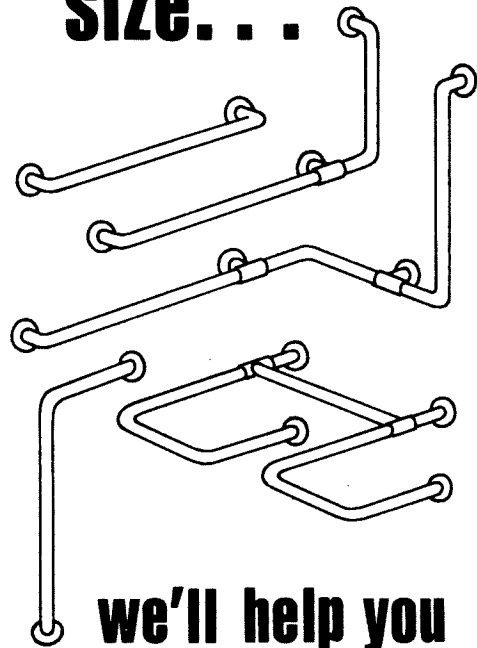

we'll help you custom design the bar you need.

Parker's grab bar line includes stainless steel bars to fit virtually every normal washroom requirement. Our catalog lists grab bars with over 1100 possible combinations of configuration, mounting, finish and diameter. However, even with such a wide selection, you may not find a bar which is exactly right for your particular application. Perhaps you need an extra length bar or an unusual configuration. In that case, Parker's experienced engineering department can design the ideal bar from your rough sketch or description. Whatever size and style bar you may need — from a simple straight length bar to a "designer original" — you can trust Parker to provide a reliable durable bar to perfectly meet your requirement.

See our catalog in Sweet's 10.16/Pa



290 PRATT ST., MERIDEN, CT 06450
TEL: 203-235-6365

ultrawall®

Movable Partitions

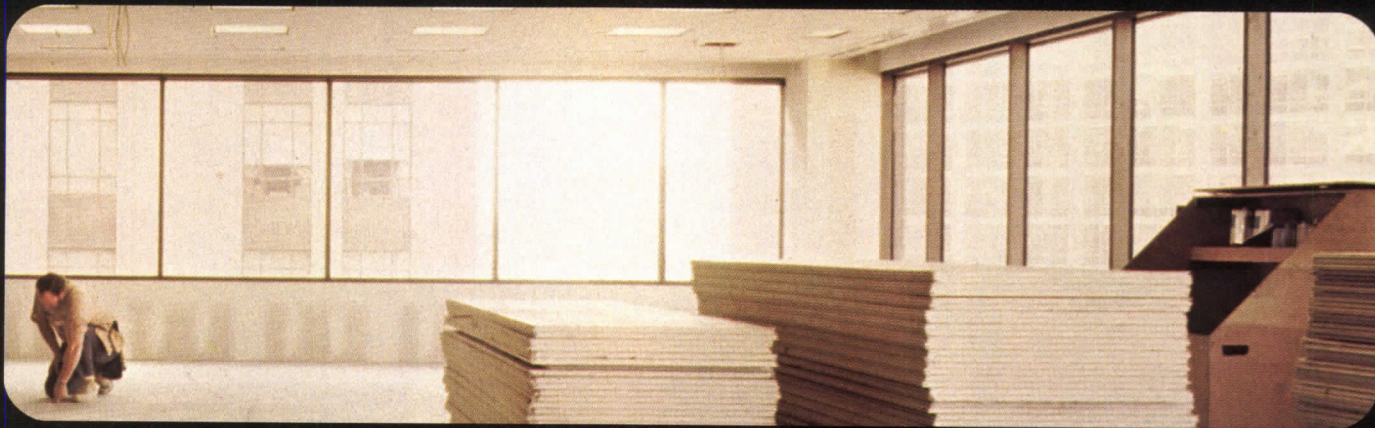

everything goes in first...

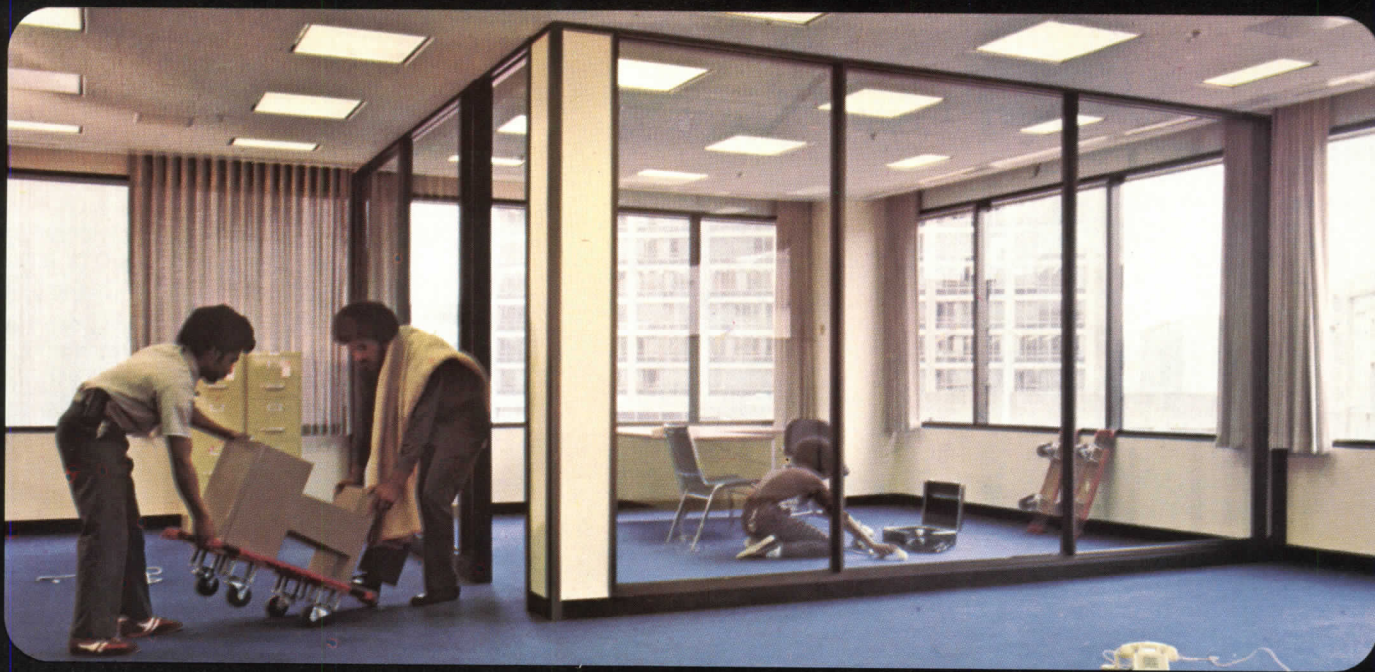

Ultrawall Partitions can wait til last.

Vinyl-covered ULTRAWALL partitions frequently start out looking like they cost more than standard fixed partitions. But when moving-in time comes, you'll find material and labor savings have made ULTRAWALL costs very attractive indeed!

So if you are comparing prices, be sure to add in the cost to cut and fit carpet and ceiling into many cubicles around fixed partitions. Then consider the simple way ULTRAWALL goes up: carpeting, ceiling, lighting and other items are installed an entire floor-at-a-time! Core and perimeter walls are finished

in one overall operation before partitions are installed. Doors, reversible frames, base, finish trim and even glazing can be handled easily, efficiently by the same partition crew. And every time you reallocate space, ULTRAWALL partitions pay for themselves all over again. Also consider the possible qualification for investment tax credit and accelerated depreciation advantages.

■ Call your U.S.G. Representative or write to us at 101 S. Wacker Dr., Chicago, Ill. 60606, Dept. AR128

UNITED STATES GYPSUM 
BUILDING AMERICA

ABOUT MAILING LISTS...

an important notice to our subscribers.

In recent years we have made the list of subscribers to McGraw-Hill publications (names and mailing addresses only) available to carefully screened companies whose products or services might be of interest to you.

These companies enter into an agreement that permits them to mail information to you without placing you under any obligation.

We have always considered such direct marketing activities to be legitimate and important in the American system of free trade—and we're confident that the majority of subscribers share this position.

However, we respect the interests of those who for some reason may wish to have their names restricted from such use by companies either affiliated or not affiliated with McGraw-Hill, Inc.

If you wish to delete your name from lists we make available to other firms, please fill in the information requested below exactly as it appears on your mailing label on the cover of this issue. Or, if you prefer, attach the label itself to the coupon and return.

McGraw-Hill, Inc.

P.O. Box 555
Hightstown, N.J. 08520
Attn: Mailing List Dept.



Please remove my name from your mailing lists.

Title of this publication

Name

Address (exactly as shown on mailing label, please)

City/State/Zip

SOUND LEVEL METER /



Said to be a low cost, yet dependable sound level meter for general survey purposes, the easily carried "CS142C" unit meets applicable ANSI S1.4 specifications. It has a dynamic range from 35 dBA to 130 dBA with both fast and slow meter response, and is designed for acoustic calibration using the "CA6" sound level calibrator. The "CS142C" meter alone is priced at \$129.00. ■ Castle Associates, Woodside, Calif.

circle 308 on inquiry card

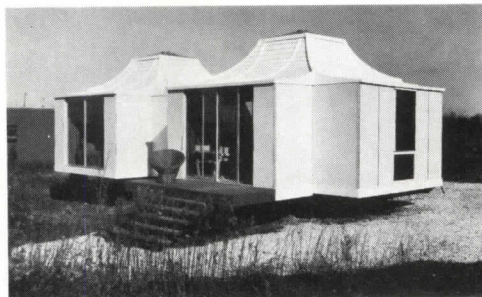

PREFAB FIBERGLASS ROOF / Part of a modular housing structure designed for fast, easy and economical erection is the cathedral roof system shown above. The five-part roof is constructed of reinforced fiberglass, fire-rated and wind-tested to 140 mph. The inside ceiling and insulation is built-in; the lightweight roof is completely finished when it has been set in place on the wood or steel stud wall structure. Each unit contains 425 sq ft of interior space, and may be joined together in series. ■ International Modular Structures, Inc., Bala Cynwyd, Pa.

circle 309 on inquiry card

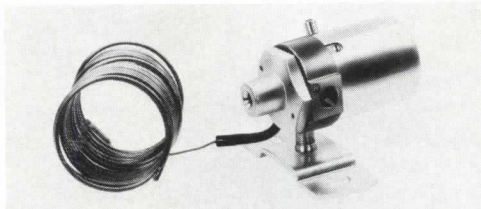

DUCT THERMOSTATS / For proportional temperature control of pneumatic actuated valves and dampers in hvac systems, the averaging bulb model shown here is direct acting with a dial range of 35F to 145F and a throttling range of 3F to 30F. The duct-mounted thermostats are said to lower equipment and installation costs; bimetal models, direct or reverse acting, are also available. ■ Barber-Colman Co., Environmental Systems Div., Rockford, Ill.

circle 310 on inquiry card

TRANSPARENT DRAIN TRAP /

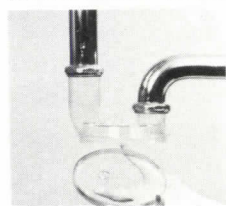

Made of high-strength clear plastic, the "Treasure Trap" replaces the standard J-bend sink drain elbow. A twist-off cap provides easy access to whatever might be caught in the drain. The plastic trap retails for \$8.95. ■ Treasure Traps, Inc., Santa Ana, Calif.

circle 311 on inquiry card

more products on page 181

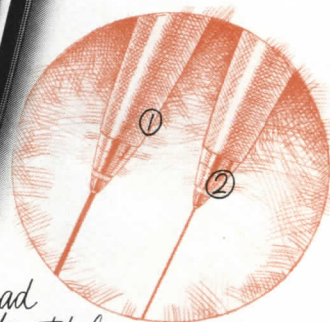
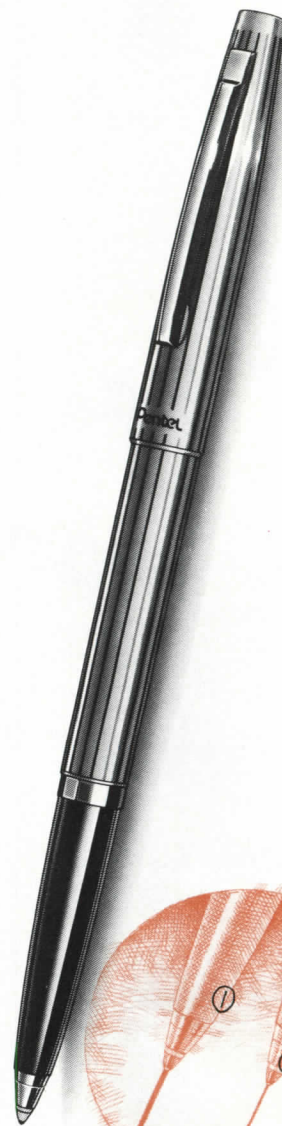

We had this beautiful idea: Create a slim-styled liquid ink ball pen in a variety of elegant finishes that's ① refillable with a choice of four colors and ② available in fine and extra-fine point sizes. It's the smooth writing easy-to-hold Slim Rolling Writer pen.

"SLIM" Rolling Writer®
only from

Pentel®

© 1978 Pentel of America, Ltd. ® Pentel and Rolling Writer are registered trademarks of Pentel Co., Ltd.

Circle 71 on inquiry card

**Fed up with
alphabet soup?
Make instant KroyType**

Press-on letters may be good and cheap.

But they're also good and messy.

Too many of some letters. Not enough of others. Never the ones you want when you need them most.

KroyType™ gets you out of the soup. Instantly.

You set KroyType on an adhesive backed, repositionable tape. Placement is quick, dry. Automatically spaced and aligned by the Kroy Lettering Machine in a variety of type styles and sizes. And similar in cost to press-on letters. Just 3¢ an inch.

Just what you need for callouts, title block data and presentation drawings. Compatible with all equipment used for blueline reproduction.

Take a few minutes to talk type with a Kroy representative. We'll fill you in on KroyType.

PHONE 800-328-1306 TOLL FREE

(In Minnesota, call 612-770-6176.)
Or circle the reader service number.
We'll send you our new KroyType brochure. Free!

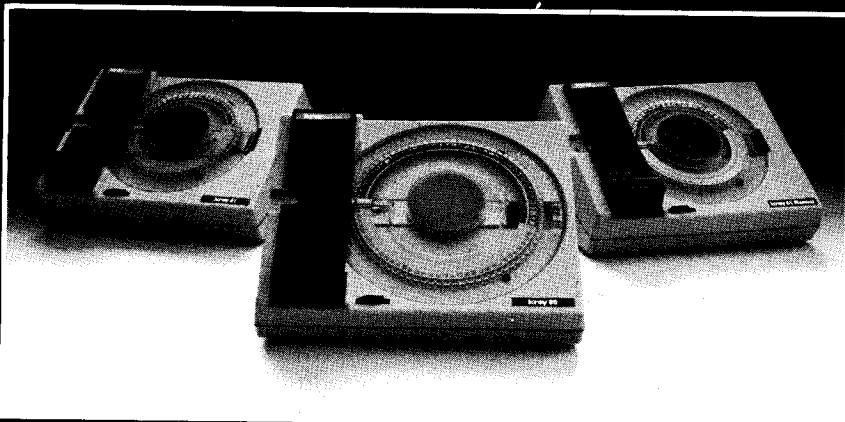

kroy

KROY INDUSTRIES INC.
GRAPHIC SYSTEMS DIVISION
1728 Gervais Avenue
St. Paul, MN 55109

Circle 72 on inquiry card

ARCHITECTURAL RECORD. Published by McGraw-Hill, Inc., 1221 Avenue of the Americas, New York, New York 10020. © 1978. All rights reserved.

Readers using the index will find buildings entered in three ways: by architect's name, by building's or owner's name, and by building type (banks, hospitals, schools, etc.) Other categories cover subjects in the engineering section (concrete, lighting, prefabrication, etc.). ABBREVIATIONS: AB—Architectural Business; AE—Architectural Engineering; BA—Building Activity; BTS—Building Types Study; LP—Legal Perspectives.

A

Alabama Power Company District Office, Montevallo, Ala.; Cobbs/Adams/Benton, archts.—Mid-Aug. 1978, BTS, pp. 92-93.

AIA. "AIA and NSPE, in separate issues, face new liability dilemmas," by Arthur T. Kornblut, Esq.—July 1978, LP, p. 61. "Design and business topics attracted hundreds at learning sessions"—July 1978, AB, p. 59. "Design/build changes all the ground rules for affected architects," by Arthur T. Kornblut, Esq.—Aug. 1978, LP, p. 57. "Design/build debate produces a new code of ethics"—July 1978, AB, pp. 55-57. "Notes on the Dallas Convention: the big news and the good news," Editorial by Walter F. Wagner, Jr.—July 1978, p. 13. "Profile: a new reference to AIA firms is aimed at clients"—Mid-Aug. 1978, AB, p. 49.

American Pole Structures Office Building, Houston, Tex.; Clovis Heimsath Assocs., archts.—Mid-Aug. 1978, BTS, pp. 120-121.

American Telephone & Telegraph Headquarters, New York, N.Y.; Johnson/Burgee, archts.—July 1978, pp. 84-85.

Amex House, American Express Headquarters Europe, Brighton, England; GMW (Gollins Melvin Ward) partnership in association with Peter Wood Partners, archts.—Mid-Aug. 1978, BTS, pp. 122-123.

Anderson, John D. & Assocs., archts.; Community College of Denver-North Campus, Denver, Colo.—Mid-Aug. 1978, BTS, pp. 78-81.

Architects II, archts.; Cumberland County Medical Center, Manor Nursing Home, Bridgeton, N.J.—Nov. 1978, BTS, pp. 138-139.

Architectural Business. "An architectural firm helps find new markets for outdated schools," by Patricia P. Rosenzweig—Aug. 1978, pp. 62-63. "Art and architecture: an artist's point of view," by Richard Lippold—Dec. 1978, pp. 69-73. "Construction costs nationally now at 9.5 per cent over last year"—Aug. 1978, p. 59. "Consultant profile: the food service planner," by Ronald P. Kooser—Sept. 1978, pp. 65-67. "Design and business topics attracted hundreds at learning sessions"—July 1978, p. 59. "Design/build debate produces a new code of ethics"—July 1978, pp. 55-57. "Home mortgage money looks imperiled again"—July 1978, p. 63. "Identifying your markets of the future," by Weld Coxe—Sept. 1978, pp. 69-71. "Low-cost computer provides financial, project controls"—Oct. 1978, p. 73. "Money market certificates reverse savings outflow"—Oct. 1978, p. 71. "Pension fund strategy: taking advantage of 'smallness'"—Dec. 1978, p. 67. "Profile: a new reference to AIA firms is aimed at clients"—Mid-Aug. 1978, p. 49. "U.S. construction costs

have increased 6.8 per cent in one year"—Nov. 1978, p. 75. "The upgrading of specification writers," by Harold J. Rosen—Mid-Oct. 1978, p. 22.

Architectural Education. "On training young graduates: Some useful 'how-to' from NCARB," Editorial by Walter F. Wagner, Jr.—Nov. 1978, p. 13. "Some thoughts about all those young people in architecture school," Editorial by Walter F. Wagner, Jr.—Aug. 1978, p. 13.

Architectural Engineering. "Engineering for Architecture," Building Types Study 521—Mid-Aug. 1978, pp. 65-127. "AISI publishes a simple, rational method for predicting fire safety of exposed steel"—Nov. 1978, pp. 141-144. "Designing precast walls to minimize staining: new industry guidelines"—Mid-Oct. 1978, pp. 20-21. "Easily installed floating floor system buffers fan-room noise"—July 1978, p. 127. "Energy-standards project tests designers' conservation skills"—Oct. 1978, pp. 129-132. "For all of the new systems and techniques, it's still the people that count," Editorial by Walter F. Wagner, Jr.—Mid-Aug. 1978, p. 7. "Gaudi: Master of form & craft," by Herman Spiegel—Mid-Aug. 1978, BTS, pp. 104-111. "Round Table: How effective are performance criteria and performance specifications in meeting users' needs?"—Mid-Aug. 1978, BTS, pp. 96-103. "Steel-deck ceiling provides low-cost security in a detention center"—July 1978, p. 128.

Architecture One, archts.; Naturalization and Immigration Service, Department of Justice, border station, Yuma, Ariz.—Dec. 1978, BTS, p. 134.

Armed Forces Reserve Center, Norwich, Conn.; Moore Grover Harper, archts.—Mid-Aug. 1978, BTS, pp. 88-89.

Arnell-Kagen Assocs., archts.; Sharon Hospital, Sharon, Conn.—Nov. 1978, BTS, pp. 130-131.

Art Galleries. East Building of the National Gallery of Art, Washington, D.C.; I.M. Pei & Partners, archts.—Aug. 1978, pp. 79-92. St. Louis Art Museum, St. Louis, Mo.; Hardy Holzman Pfeiffer Assocs., archts.—Oct. 1978, pp. 85-96.

Arts Village, Hampshire College, Amherst, Mass.; Juster Pope Assocs., archts.—Mid-Aug. 1978, BTS, pp. 94-95.

Australian Embassy, Paris, France; Harry Seidler & Assocs., archts.—Nov. 1978, pp. 103-112.

B

Bahr Vermeer & Haecker, Architects, Ltd., archts.; The Bemis Company, Inc., Omaha, Neb.—July 1978, BTS, pp. 110-111.

Banks. Federal Reserve Bank of Boston, Boston, Mass.; Hugh Stubbins & Assocs., Inc., archts.—Sept. 1978, pp. 109-118.

Banwell, White & Arnold, archts.; Famolare Headquarters, Brattleboro, Vt.—Mid-Aug. 1978, BTS, pp. 82-85.

Bassetti, Fred & Co. and John Graham & Co., archts.; Seattle Federal Office Building, Seattle, Wash.—Dec. 1978, BTS, pp. 118-120.

Batorewicz, Valerie, archt.; Plastic house near New Haven, Conn.—Mid-Aug. 1978, BTS, pp. 124-125.

Bear Mountain Inn, Bear Mountain, N.Y.; Joseph Tonetti & Assocs., archts.—Sept. 1978, pp. 120-125.

Bemis (The) Company, Inc., Omaha, Neb.; Bahr Vermeer & Haecker, Architects, Ltd., archts.—July 1978, BTS, pp. 110-111.

Black O'Dowd & Assocs., archts.; The Regent of Fiji, Fiji Islands—Sept. 1978, BTS, pp. 132-135.

Brattleboro Retract, Brattleboro, Vt.; Perry, Dean, Stahl & Rogers, archts.—Nov. 1978, BTS, pp. 126-129.

Breuer, Marcel and Robert J. Gatje, archts.; Resort Town Flaine, Haute Savoie, France—Sept. 1978, BTS, pp. 136-139.

Breuer, Marcel Assocs. and U.S. Bureau of Reclamation, archts.; Grand Coulee Dam Extension, Columbia Basin, Colo.—Dec. 1978, BTS, pp. 126-127.

Brukoff, Barry, archt.; Old Pavilion, Stanford University, Stanford, Cal.—Sept. 1978, pp. 119-128.

Building Activity. "Dodge/Sweet's construction outlook, 1978: second update"—Aug. 1978, pp. 53-55. "Dodge/Sweet's construction outlook: 1979 moving from a year of expansion into a year of stability"—Nov. 1978, pp. 65-71.

C

Callister Payne & Bischoff, archts.; Littleton Quarter at Kingsmill, Kingsmill, Va.—Oct. 1978, BTS, pp. 124-125. Shawnee Village, Shawnee on the Delaware, Pa.—Oct. 1978, BTS, pp. 126-128.

Cambridge Public Library, Central Square Branch, Cambridge, Mass.; Monacelli Assocs., archts.—July 1978, pp. 94-95.

Caudill Rowlett Scott, archts.; Trenton State College Student Center, N.J.—Aug. 1978, pp. 101-106.

Clark Tribble Harris & Li, archts.; Mecklenburg County Parking Structure, Charlotte, N.C.—Mid-Aug. 1978, BTS, pp. 126-128. Physical Plant Building, Charlotte, N.C.—July 1978, BTS, pp. 118-119.

Cobbs/Adams/Benton, archts.; Alabama Power Company District Office, Montevallo, Ala.—Mid-Aug. 1978, BTS, pp. 92-93.

Coldspring, Baltimore, Md.; Moshe Safdie & Assocs., archts.—Oct. 1978, BTS, pp. 118-121.

Commodore Sloat School, San Francisco, Cal.; Marquis Assocs., archts.—Nov. 1978, pp. 96-97.

Community Centers. Seifert Community Center, Stockton, Cal.; Marquis Assocs., archts.—Nov. 1978, p. 100.

Community College of Denver-North Campus, Denver, Colo.; John D. Anderson & Assocs., archts.—Mid-Aug. 1978, BTS, pp. 78-81.

Community Federal Center, St. Louis, Mo.; Hellmuth, Obata & Kassabaum, Inc., archts.—Sept. 1978, pp. 95-100.

Convention Centers. Philippine International Convention Center, Cultural Center Complex, Manila, Philippines; Leandro V. Locsin & Assocs., archts.—Oct. 1978, pp. 97-102.

Cornell Medical Center, Neonatal Intensive Care Unit, New York, N.Y.; Skidmore, Owings & Merrill, archts.—Nov. 1978, BTS, pp. 134-135.

Cromwell, Truemper, Millett & Jatchell and U.S. Army Corps of Engineers, archts.; Visitors Center, Table Rock Dam, Ark.—Dec. 1978, BTS, pp. 130-131.

Cumberland County Medical Center, Manor Nursing Home, Bridgeton, N.J.; Architects II, archts.—Nov. 1978, BTS, pp. 138-139.

D

Dade County Cultural Center, Miami, Fla.; Johnson/Burgee, archts.—July 1978, pp. 86-88.

Dental School, Continuing Education Facility, University of Oregon Health Sciences Center, Portland, Ore.; Zimmer Gunsul Frasca, archts.—Nov. 1978, BTS, p. 137.

E

East Building of the National Gallery of Art, Washington, D.C.; I.M. Pei & Partners, archts.—Aug. 1978, pp. 79-92.

Editorials. "Anti-inflation policy: what's the building industry to do?," by Walter F. Wagner, Jr.—Dec. 1978, p. 13. "For all of the new systems and techniques, it's still the people that count," by Walter F. Wagner, Jr.—Mid-Aug. 1978, p. 7. "The happy trend to revitalization of city neighborhoods turns out to have some sobering side effects . . .," by Walter F. Wagner, Jr.—Oct. 1978, p. 13. "Notes on the Dallas Convention: the big news and the good news," by Walter F. Wagner, Jr.—July 1978, p. 13. "On training young graduates: Some useful 'how-to' from NCARB," by Walter F. Wagner, Jr.—Nov. 1978, p. 13. "Some thoughts about all those young people in architecture school . . . and some thoughts about 'interior architecture,'" by Walter F. Wagner, Jr.—Aug. 1978, p. 13. "A time of new work, new problems, new solutions to problems . . .," by Walter F. Wagner, Jr.—Mid-Oct. 1978, p. 23. "Too many troubles in too many buildings: Why don't we start talking about what to do?," by Walter F. Wagner, Jr.—Sept. 1978, p. 13.

Eglinton West Station, Toronto, Canada; Arthur Erickson Architects, archts.—Mid-Aug. 1978, BTS, pp. 76-77.

Elder, Granville W. Station (North Shore), Houston, Tex.; Clovis Heimsath Assocs., archts.—Mid-Aug. 1978, BTS, pp. 90-91.

Energy Conservation. Elder, Granville W. Station (North Shore), Houston, Tex.; Clovis Heimsath Assocs., archts.—Mid-Aug. 1978, BTS, pp. 90-91. "Energy-standards project tests designers' conservation skills"—Oct. 1978, AE, pp. 129-132. See also Solar Energy.

Energy Research and Development Agency, Safeguards Analytical Laboratory, Argonne, Ill.; Metz Train Olson & Youngren and U.S. Atomic Energy Comm., archts.—Dec. 1978, BTS, p. 129.

Erickson, Arthur Architects, archts.; Eglinton West Station, Toronto, Canada—Mid-Aug. 1978, BTS, pp. 76-77. Yorkdale Station, Toronto, Canada—Mid-Aug. 1978, BTS, pp. 72-75.

F

Famolare Headquarters, Brattleboro, Vt.; Banwell, White & Arnold, archts.—Mid-Aug. 1978, BTS, pp. 82-85.

Federal Building, U.S. Courthouse, Fort Lauderdale, Fla.; William Morgan Archts., archts.—Dec. 1978, BTS, pp. 116-117.

Federal Home Loan Bank Board Building, Washington, D.C.; Max O. Urbahn Assocs., archts.—Dec. 1978, BTS, pp. 106-109.

Federal Office Building, Ann Arbor, Mich.; TMP Assocs., archts.—Dec. 1978, BTS, pp. 113-115.

Federal Reserve Bank of Boston, Boston, Mass.; Hugh Stubbins & Assocs., Inc., archts.—Sept. 1978, pp. 109-118.

Fine, Hyman Elementary School and Hill-Roberts Elementary School, Attleboro, Mass.; Henneberg & Henneberg Inc. and A.A. Trullis Assocs., Inc. Associated Architects, archts.—Aug. 1978, BTS, pp. 126-128.

Fluor Corporation Corporate Headquarters and Office Building for Fluor Engineers & Constructors, Southern California Division, Irvine, Cal.; Welton Becket Assocs., archts.—July 1978, pp. 103-108.

Forstel, Michael & Richard Foster, archts.; Institute of Fine Arts Renovation, New York, N.Y.—Aug. 1978, pp. 107-112.

Foster, Marcus A. Middle School, Oakland, Cal.; Mackinlay Winnacker McNeil & Assocs. and Kennard, Delahousie & Gault, archts.—Aug. 1978, BTS, pp. 114-115.

Foster, Richard & Michael Forstel, archts.; Institute of Fine Arts Renovation, New York, N.Y.—Aug. 1978, pp. 107-112.

French, Alfred & Assocs., Inc., archts.; Daniel P. French Residence, Piqua, O.—Oct. 1978, pp. 103-106.

French, Daniel P. Residence, Piqua, O.; Alfred French & Assocs., Inc., archts.—Oct. 1978, pp. 103-106.

G

Gatje, Robert J. and Marcel Breuer, archts.; Resort Town Flaine, Haute Savoie, France—Sept. 1978, BTS, pp. 136-139.

"Gaudi: Master of form & craft," by Herman Spiegel—Mid-Aug. 1978, BTS, pp. 104-111.

General American Life Insurance Headquarters, St. Louis, Mo.; Johnson/Burgee, archts.—July 1978, pp. 79-83.

General Purpose Building 60, Wilsonville, Ore.; Zimmer Gunsul Frasca Partnership, archts.—July 1978, BTS, pp. 120-123.

GMW (Gollins Melvin Ward) partnership in association with Peter Wood Partners, archts.; Amex House, American Express Headquarters Europe, Brighton, England—Mid-Aug. 1978, BTS, pp. 122-123.

Goodhue, Bertram, archt.; Four buildings: Chapel at West Point, N.Y.; Panama-California Exhibition Buildings, San Diego, Cal.; Nebraska State Capitol, Lincoln, Neb.; Church of the Heavenly Rest, New York, N.Y.—Sept. 1978, pp. 101-108.

Graham, John & Co. and Fred Bassetti & Co., archts.; Seattle Federal Office Building, Seattle, Wash.—Dec. 1978, BTS, pp. 118-120.

Gran, Warren W. & Assocs., archts.; Sewage Pumping Station, Staten Island, N.Y.—July 1978, BTS, pp. 116-117.

Grand Coulee Dam Extension, Columbia Basin, Colo.; Marcel Breuer Assocs. and U.S. Bureau of Reclamation, archts.—Dec. 1978, BTS, pp. 126-127.

Gwathmey Siegel, archts.; Apartment Housing Project, New York State University, College at Purchase, Purchase, N.Y.—Oct. 1978, BTS, pp. 116-117. Whitney Road Residential Development, Perinton, N.Y.—Oct. 1978, BTS, pp. 114-115.

H

HTB, INC., archts.; Model Secondary School for the Deaf, Washington, D.C.—Aug. 1978, BTS, pp. 122-125.

Haines Lundberg Waehler, archts.; White Plains Telephone Building, White-Plains, N.Y.—July 1978, BTS, pp. 124-126.

Hardy Holzman Pfeiffer Assocs., archts.; St. Louis Art Museum, St. Louis, Mo.—Oct. 1978, pp. 85-96.

Heimsath, Clovis Assocs., archts.; American Pole Structures Office Building, Houston, Tex.—Mid-Aug. 1978, BTS, pp. 120-121. Granville W. Elder Station (North Shore), Houston, Tex.—Mid-Aug. 1978, BTS, pp. 90-91. Memorial Station, Houston, Tex.—Mid-Aug. 1978, BTS, pp. 86-87.

Hellmuth, Obata & Kassabaum, Inc., archts.; Community Federal Center, St. Louis, Mo.—Sept. 1978, pp. 95-100.

Henneberg & Henneberg Inc. and A.A. Trullis Assocs., Inc., Associated Architects, archts.; Hyman Fine Elementary School and Hill-Roberts Elementary School, Attleboro, Mass.—Aug. 1978, BTS, pp. 126-128.

Hill-Roberts Elementary School and Hyman Fine Elementary School, Attleboro, Mass.; Henneberg & Henneberg Inc. and A.A. Trullis Assocs., Inc. Associated Architects, archts.—Aug. 1978, BTS, pp. 126-128.

Hillier Group, archts.; Jersey City Health Center, Jersey City, N.J.—Nov. 1978, BTS, p. 133.

Hodne/Stageberg, archts.; Naturalization and Immigration Service, Department of Justice, border stations, Boundary, Wash. and Scobey, Mont.—Dec. 1978, BTS, p. 134.

Hospitals. "Existing structures offer helping hands to health care," Building Types Study 524—Nov. 1978, pp. 121-140. Lutheran Medical Center, Brooklyn, N.Y.; Rogers, Butler, Burgun & Shahine, archts.—Nov. 1978, BTS, p. 132. Massachusetts General Hospital, Boston, Mass.; Perry, Dean, Stahl & Rogers, archts.—Nov. 1978, BTS, p. 136. Neonatal Intensive Care Unit, Cornell Medical Center, New York, N.Y.; Skidmore, Owings & Merrill, archts.—Nov. 1978, BTS, pp. 134-135. Olive View Hospital, Sylmar, Cal.; The Luckman Partnership, archts.—Mid-Aug. 1978, BTS, p. 118. Sharon Hospital, Sharon, Conn.; Arneill-Kagen Assocs., archts.—Nov. 1978, BTS, pp. 130-131. Travis Air Force Base hospital, Fairfield, Cal.; Herbert McLaughlin, archt.—Dec. 1978, BTS, p. 132. VA Hospital, Baltimore, Md.; RTKL Assocs., archts.—Dec. 1978, BTS, p. 136. See also Medical Facilities.

Hotels & Motels. "International Resorts," Building Types Study 522—Sept. 1978, pp. 129-144. Hotel Babin Kuk, Dubrovnik, Yugoslavia; Edward Durrell Stone Assocs., archts.—Sept. 1978, BTS, pp. 142-144. Hyatt Regency Hotel, Dallas, Tex.; Welton Becket Assocs., archts.—Mid-Aug. 1978, BTS, pp. 116-117; Oct. 1978, pp. 107-112. Palmas Del Mar, San Juan, P.R.; Esteban Padilla, archt.—Sept. 1978, BTS, pp. 140-141. Regent of Fiji, Fiji Islands; Black O'Dowd & Assocs., archts.—Sept. 1978, BTS, pp. 132-135. Resort Town Flaine, Haute Savoie, France; Marcel Breuer and Robert F. Gatje, archts.—Sept. 1978, BTS, pp. 136-139.

Houses. "Alternatives for low-rise housing design," Building Types Study 523—Oct. 1978, pp. 113-128. French, Daniel P. Residence, Piqua, O.; Alfred French & Assocs., Inc., archts.—Oct. 1978, pp. 103-106. Jacobsen, Hugh Newell, archt.; Five new designs—Nov. 1978, pp. 113-120. Summer house, Darien, Conn.—Nov. p. 114; Revivalist abstract, Eastern Md.—Nov. p. 115; Columned pavilion, Lexington, Ky.—Nov. pp. 116-117; Wall house, Selins Grove, Pa.—Nov. p. 118. Six black barns, Wayzeta, Minn.—Nov. p. 119. Littletown Quarter at Kingsmill, Kingsmill, Va.; Callister Payne & Bischoff, archts.—Oct. 1978, BTS, pp. 124-125. Plastic house near New Haven, Conn.; Valerie Batorewicz, archt.—Mid-Aug. 1978, BTS, pp. 124-125. Private Residence, Darien, Conn.; Anthony D. Wollner & Anne K. Wollner, archts.—July 1978, pp. 99-102. Shawnee Village, Shawnee on the Delaware, Pa.; Callister Payne & Bischoff, archts.—Oct. 1978, BTS, pp. 126-128.

Housing & Apartments. "Alternatives for low-rise housing design," Building Types Study 523—Oct. 1978, pp. 113-128. Apartment Housing Project, New York State University, College at Purchase, Purchase, N.Y.; Gwathmey Siegel, archts.—Oct. 1978, pp. 116-117. Australian Embassy, Paris, France; Harry Seidler & Assocs., archts.—Nov. 1978, pp. 103-112. Coldspring, Baltimore, Md.; Moshe Safdie & Assocs., archts.—Oct. 1978, BTS, pp. 118-121. Littletown Quarter at Kingsmill, Kingsmill, Va.; Callister Payne & Bischoff, archts.—Oct. 1978, BTS, pp. 124-125. Resort Town Flaine, Haute Savoie, France; Marcel Breuer and Robert J. Gatje, archts.—Sept. 1978,

BTS, pp. 136-139. Second Street Townhouses, Philadelphia, Pa.; Louis Sauer Assocs., archts.—Oct. 1978, BTS, pp. 122-123. Shawnee Village, Shawnee on the Delaware, Pa.; Callister Payne & Bischoff, archts.—Oct. 1978, BTS, pp. 126-128. Whitney Road Residential Development, Perinton, N.Y.; Gwathmey Siegel, archts.—Oct. 1978, BTS, pp. 114-115.

Hyatt Regency Hotel, Dallas, Tex.; Welton Becket Assocs., archts.—Mid-Aug. 1978, BTS, pp. 116-117; Oct. 1978, pp. 107-112.

I

Industrial Buildings. "Building for Industry," Building Types Study 519—July 1978, pp. 109-126. Bemis (The) Company, Inc., Omaha, Neb.; Bahr Vermeer & Haecker, Architects, Ltd., archts.—July 1978, BTS, pp. 110-111. General Purpose Building 60, Wilsonville, Ore.; Zimmer Gunsul Frasca Partnership, archts.—July 1978, BTS, pp. 120-123. Physical Plant Building, Charlotte, N.C.; Clark Tribble Harris & Li, archts.—July 1978, BTS, pp. 118-119. Sewage Pumping Station, Staten Island, N.Y.; Warren W. Gran & Assocs., archts.—July 1978, BTS, pp. 116-117. White Plains Telephone Building, White Plains, N.Y.; Haines Lundberg Waehler, archts.—July 1978, BTS, pp. 124-126.

Institute of Fine Arts Renovation, New York, N.Y.; Richard Foster & Michael Forstel, archts.—Aug. 1978, pp. 107-112.

Interiors. "... and some thoughts about 'interior architecture,'" Editorial by Walter F. Wagner, Jr.—Aug. 1978, p. 13. Bear Mountain Inn, Bear Mountain, N.Y.; Joseph Tonetti & Assocs., archts.—Sept. 1978, pp. 120-125. Federal Reserve Bank of Boston, Boston, Mass.; Hugh Stubbins & Assocs., Inc., archts.—Sept. 1978, pp. 109-118. Old Pavilion, Stanford University, Stanford, Cal.; Barry Brukoff, archt.—Sept. 1978, pp. 119-128.

J

Jacobsen, Hugh Newell, archt.; Five new designs—Nov. 1978, pp. 113-120; Summer house, Darien, Conn.—Nov. p. 114; Revivalist abstract, Eastern Md.—Nov. p. 115; Columned pavilion, Lexington, Ky.—Nov. pp. 116-117; Wall house, Selins Grove, Pa.—Nov. p. 118; Six black barns, Wayzeta, Minn.—Nov. p. 119.

Jersey City Health Center, Jersey City, N.J.; Hillier Group, archts.—Nov. 1978, BTS, p. 133.

Johnson/Burgee, archts.; Three designs: General American Life Insurance Headquarters, St. Louis, Mo.; Headquarters for American Telephone & Telegraph, New York, N.Y.; Dade County Cultural Center, Miami, Fla.—July 1978, pp. 79-88.

K

Kennard, Delahousie & Gault and Mackinlay Winnacker McNeil & Assocs., archts.; Marcus A. Foster Middle School, Oakland, Cal.—Aug. 1978, BTS, pp. 144-115.

L

Legal Perspectives. "AIA and NSPE, in separate issues, face new liability dilemmas," by Arthur T. Kornblut, Esq.—July 1978, p. 61. "Design/build changes all the ground rules for affected architects," by Arthur T. Kornblut, Esq.—Aug. 1978, p. 57. "Proprietorship, partnership, corporation? Weighing the alternatives," by Arthur T. Kornblut, Esq.—Nov. 1978, pp. 73-74. "Scrutinize indemnification clauses in owner-architect contracts," by Arthur T. Kornblut, Esq.—Sept. 1978, p. 73. "Statutes of limitation: more fuel for the liability fires," by Philip F. Purcell—Dec. 1978, p. 65.

Libraries. Cambridge Public Library, Central Square Branch, Cambridge, Mass.; Monacelli Assocs., archts.—July 1978, pp. 94-95. Institute of Fine Arts Renovation, New York, N.Y.; Richard Foster & Michael Forstel, archts.—Aug. 1978, pp. 107-112. Sawyer Library, Williams College, Williamstown, Mass.; Harry Weese & Assocs., archts.—July 1978, pp. 89-93. Selby, The William G. and Marie Public Library, Sarasota, Fla.; Skidmore, Owings & Merrill, archts.—July 1978, pp. 96-98.

Littletown Quarter at Kingsmill, Kingsmill, Va.; Callister Payne & Bischoff, archts.—Oct. 1978, BTS, pp. 124-125.

Locsin, Leandro V. & Assocs., archts.; Philippine International Convention Center, Cultural Center Complex, Manila, Philippines—Oct. 1978, pp. 97-102.

Los Angeles Harbor Department Administrative Office Facility, Los Angeles, Cal.; John Carl Warnecke & Assocs., archts.—Mid-Aug. 1978, BTS, pp. 112-115.
 Luckman (The) Partnership, archts.; Olive View Hospital, Sylmar, Cal.—Mid-Aug. 1978, BTS, p. 118.
 Lutheran Medical Center, Brooklyn, N.Y.; Rogers, Butler, Burgun & Shahine, archts.—Nov. 1978, BTS, p. 132.

M

Mackinlay Winnacker McNeil & Assocs. and Kennard, Delahousie & Gault, archts.; Marcus A. Foster Middle School, Oakland, Cal.—Aug. 1978, BTS, pp. 114-115.
 Manor Nursing Home of the Cumberland County Medical Center, Bridgeton, N.J.; Architects II, archts.—Nov. 1978, BTS, pp. 138-139.
 Marquis Assocs., archts.; "New directions for an established firm in a time of change," by Robert Marquis & Cathy Simon—Nov. 1978, pp. 93-102. Saint Francis Yacht Club, San Francisco, Cal.—Nov. 1978, pp. 94-95.
 Commodore Sloat School, San Francisco, Cal.—Nov. 1978, pp. 96-97. Office Building, California Department of Justice, Sacramento, Cal.—Nov. 1978, pp. 98-99.
 Seifert Community Center, Stockton, Cal.—Nov. 1978, p. 100. Saint Gregory Armenian Apostolic Church, San Francisco, Cal.—Nov. 1978, p. 101.
 Massachusetts General Hospital, Boston, Mass.; Perry, Dean, Stahl & Rogers, archts.—Nov. 1978, BTS, p. 136.
 Mayers, Murray & Phillip, archts.; The Church of the Heavenly Rest, New York, N.Y.—Sept. 1978, p. 108.
 McGuire & Shook Corporation (The) Burns-Clark-Jacobs-West, archts.; Westfield Middle School, Westfield, Ind.—Aug. 1978, BTS, pp. 120-121.
 McLaughlin, Herbert, archt.; Medical Facility for Travis Air Force Base, Fairfield, Cal.—Dec. 1978, BTS, p. 132.
 Mecklenburg County Parking Structure, Charlotte, N.C.; Clark Tribble Harris & Li, archts.—Mid-Aug. 1978, BTS, pp. 126-128.
 Medical Facilities. "Existing structures offer helping hands to health care." Building Types Study 524—Nov. 1978, pp. 121-140. Brattleboro Retreat, Brattleboro, Vt.; Perry, Dean, Stahl & Rogers, archts.—Nov. 1978, BTS, pp. 126-129. Cumberland County Medical Center, Manor Nursing Home, Bridgeton, N.J.; Architects II, archts.—Nov. 1978, BTS, pp. 138-139. Dental School, Continuing Education Facility, University of Oregon Health Sciences Center, Portland, Ore.; Zimmer Gunsul Frasca, archts.—Nov. 1978, BTS, p. 137. Jersey City Health Center, Jersey City, N.J.; Hillier Group, archts.—Nov. 1978, BTS, p. 133.
 Lutheran Medical Center, Brooklyn, N.Y.; Rogers, Butler, Burgun & Shahine, archts.—Nov. 1978, BTS, p. 132.
 Moshasuck Square Arcade, Providence, R.I.; Steffian-Bradley Assocs., archts.—Nov. 1978, BTS, pp. 122-125. See also Hospitals.
 Memorial Station, Houston, Tex.; Clovis Heimsath Assocs., archts.—Mid-Aug. 1978, BTS, pp. 86-87.
 Metz Train Olson & Youngren and U.S. Atomic Energy Comm., archts.; Energy Research and Development Agency, Safeguards Analytical Laboratory, Argonne, Ill.—Dec. 1978, BTS, p. 129.
 Model Secondary School for the Deaf, Washington, D.C.; HTB, INC., archts.—Aug. 1978, BTS, pp. 122-125.
 Monacelli Assocs., archts.; Cambridge Public Library, Central Square Branch, Cambridge, Mass.—July 1978, pp. 94-95.
 Moore Grover Harper, archts.; Armed Forces Reserve Center, Norwich, Conn.—Mid-Aug. 1978, BTS, pp. 88-89.
 Morgan, William Archts., archts.; Federal Building, U.S. Courthouse, Fort Lauderdale, Fla.—Dec. 1978, BTS, pp. 116-117.
 Moshasuck Square Arcade, Providence, R.I.; Steffian-Bradley Assocs., archts.—Nov. 1978, BTS, pp. 122-125.
 Museums. St. Louis Art Museum, St. Louis, Mo.; Hardy Holzman Pfeiffer Assocs., archts.—Oct. 1978, pp. 85-96.

N

National Gallery of Art, East Building, Washington, D.C.; I.M. Pei & Partners, archts.—Aug. 1978, pp. 79-92.
 Naturalization and Immigration Service, Department of Justice, border stations Boundary, Wash. and Scobey, Mont.; Hodne/Stageberg, archts.; station in Yuma, Ariz.; Architecture One, archts.—Dec. 1978, BTS, p. 134.
 Nebraska State Capitol, Lincoln, Neb.; Bertram Goodhue, archt.—Sept. 1978, pp. 106-107

Neonatal Intensive Care Unit, Cornell Medical Center, New York, N.Y.; Skidmore, Owings & Merrill, archts.—Nov. 1978, BTS, pp. 134-135.
 New York Telephone Company, White Plains Telephone Building, White Plains, N.Y.; Haines Lundberg Waehler, archts.—July 1978, BTS, pp. 124-126.
 North End Community School, Springfield, Mass.; Perkins & Will Partnership, archts.—Aug. 1978, BTS, pp. 116-119.

O

Oakmead Office Center, Sunnyvale, Cal.; Jacob Robbins & James Ream, archts.—Mid-Aug. 1978, p. 119.
 Office Buildings. "Building for Industry," Building Types Study 519—July 1978, pp. 109-126. "Federal architecture: An agenda for quality, why not the best?," Building Types Study 525—Dec. 1978, pp. 83-136. Alabama Power Company District Office, Montevallo, Ala.; Cobbs/Adams/Benton, archts.—Mid-Aug. 1978, BTS, pp. 92-93. American Pole Structures Office Building, Houston, Tex.; Clovis Heimsath Assocs., archts.—Mid-Aug. 1978, BTS, pp. 120-121. American Telephone & Telegraph Headquarters, New York, N.Y.; Johnson/Burgee, archts.—July 1978, pp. 84-85. Amex House, American Express Headquarters Europe, Brighton, England; GMW (Gollins Melvin Ward) partnership in association with Peter Wood Partners, archts.—Mid-Aug. 1978, BTS, pp. 122-123. Australian Embassy, Paris, France; Harry Seidler & Assocs., archts.—Nov. 1978, pp. 103-112. Community Federal Center, St. Louis, Mo.; Hellmuth, Obata & Kassabaum, Inc., archts.—Sept. 1978, pp. 95-100. Corporate Headquarters for Fluor Corporation and Office Building for Fluor Engineers & Constructors, Southern California Division, Irvine, Cal.; Welton Becket Assocs., archts.—July 1978, pp. 103-108. Famolare Headquarters, Brattleboro, Vt.; Banwell, White & Arnold, archts.—Mid-Aug. 1978, BTS, pp. 82-85. Federal Home Loan Bank Board Building, Washington, D.C.; Max O. Urbahn Assocs., archts.—Dec. 1978, BTS, pp. 106-109. Federal Office Building, Ann Arbor, Mich.; TMP Assocs., archts.—Dec. 1978, BTS, pp. 113-115. Federal Reserve Bank of Boston, Boston, Mass.; Hugh Stubbins & Assocs., Inc., archts.—Sept. 1978, pp. 109-118. General American Life Insurance Headquarters, St. Louis, Mo.; Johnson/Burgee, archts.—July 1978, pp. 79-83. Los Angeles Harbor Department Administrative Office Facility, Los Angeles, Cal.; John Carl Warnecke & Assocs., archts.—Mid-Aug. 1978, BTS, pp. 112-115. Oakmead Office Center, Sunnyvale, Calif.; Jacob Robbins & James Ream, archts.—Mid-Aug. 1978, BTS, p. 119. Office Building, California Department of Justice, Sacramento, Cal.; Marquis Assocs., archts.—Nov. 1978, pp. 98-99. PNB (Pacific Northwest Bell) Fourth Avenue Office Complex, Portland, Ore.; Zimmer Gunsul Frasca Partnership, archts.—July 1978, BTS, pp. 112-115. Seattle Federal Office Building, Seattle, Wash.; John Graham & Co. and Fred Bassetti & Co., archts.—Dec. 1978, BTS, pp. 118-120. White Plains Telephone Building, White Plains, N.Y.; Haines Lundberg Waehler, archts.—July 1978, BTS, pp. 124-126.
 Old Federal Courts Building, St. Paul, Minn.; Perry, Dean, Stahl & Rogers, archts.—Dec. 1978, BTS, pp. 100-105.
 Olive View Hospital, Sylmar, Cal.; The Luckman Partnership, archts.—Mid-Aug. 1978, BTS, p. 118.

P

PNB (Pacific Northwest Bell) Fourth Avenue Office Complex, Portland, Ore.; Zimmer Gunsul Frasca Partnership, archts.—July 1978, BTS, pp. 112-115.
 Padilla, Esteban, archt.; Palmas Del Mar, San Juan, P.R.—Sept. 1978, BTS, pp. 140-141.
 Palmas Del Mar, San Juan, P.R.; Esteban Padilla, archt.—Sept. 1978, BTS, pp. 140-141.
 Panama-California Exhibition Buildings, San Diego, Cal.; Bertram Goodhue, archt.—Sept. 1978, pp. 104-105.
 Parking. Mecklenburg County Parking Structure, Charlotte, N.C.; Clark Tribble Harris & Li, archts.—Mid-Aug. 1978, BTS, pp. 126-128.
 Pei, I.M. & Partners, archts.; East Building of the National Gallery of Art, Washington, D.C.—Aug. 1978, pp. 79-92.
 Perkins & Will Partnership, archts.; "An architectural firm helps find new markets for outdated schools," by Patricia P. Rosenzweig—Aug. 1978, AB, pp. 62-63. North End Community School, Springfield, Mass.—Aug. 1978, BTS, pp. 116-119.

Perry, Dean, Stahl & Rogers, archts.; Brattleboro Retreat, Brattleboro, Vt.—Nov. 1978, BTS, pp. 126-129. Massachusetts General Hospital, Boston, Mass.—Nov. 1978, BTS, p. 136. Old Federal Courts Building, St. Paul, Minn.—Dec. 1978, BTS, pp. 100-105.
 Philippine International Convention Center, Cultural Center Complex, Manila, Philippines; Leandro V. Locsin & Assocs., archts.—Oct. 1978, pp. 97-102.
 Physical Plant Building, Charlotte, N.C.; Clark Tribble Harris & Li, archts.—July 1978, BTS, pp. 118-119.
 Planning. "Alternatives for low-rise housing design," Building Types Study 523—Oct. 1978, p. 113-128. Cold-spring, Baltimore, Md.; Moshe Safdie & Assocs., archts.—Oct. 1978, BTS, pp. 118-121. "The happy trend to revitalization of city neighborhoods turns out to have some sobering side effects . . ." Editorial by Walter F. Wagner, Jr.—Oct. 1978, p. 13. Littleton Quarter at Kingsmill, Kingsmill, Va.; Callister Payne & Bischoff, archts.—Oct. 1978, BTS, pp. 124-125. Resort Town Flaine, Haute Savoie, France; Marcel Breuer and Robert F. Gatje, archts.—Sept. 1978, BTS, pp. 136-139. Shawnee Village, Shawnee on the Delaware, Pa.; Callister Payne & Bischoff, archts.—Oct. 1978, BTS, pp. 126-128. "The suburban alternative for the 'middle city,'" by Robert A.M. Stern—Aug. 1978, pp. 93-100. Whitney Road Residential Development, Perinton, N.Y.; Gwathmey Siegel, archts.—Oct. 1978, BTS, pp. 114-115.
 Pope, Juster Assocs., archts.; Arts Village, Hampshire College, Amherst, Mass.—Mid-Aug. 1978, BTS, pp. 94-95.
 Product Reports. Product Reports 79—Mid-Oct. 1978, pp. 24-178. "Case studies: Four product application features"—Mid-Oct. 1978, pp. 14-18. "A time of new work, new problems, new solutions to problems. . ." Editorial by Walter F. Wagner, Jr.—Mid-Oct. 1978, p. 23. "Trends: Product trends exemplified"—Mid-Oct. 1978, p. 13. "The upgrading of specification writers," by Harold J. Rosen—Mid-Oct. 1978, AB, p. 22.
 Public Buildings. "Federal architecture: An agenda for quality, why not the best?," Building Types Study 525—Dec. 1978, pp. 83-136. Armed Forces Reserve Center, Norwich, Conn.; Moore Grover Harper, archts.—Mid-Aug. 1978, BTS, pp. 88-89. Dade County Cultural Center, Miami, Fla.; Johnson/Burgee, archts.—July 1978, pp. 86-88. Elder, Granville W. Station (North Shore), Houston, Tex.; Clovis Heimsath Assocs., archts.—Mid-Aug. 1978, BTS, pp. 90-91. Energy Research and Development Agency, Safeguards Analytical Laboratory, Argonne, Ill.; Metz Train Olson & Youngren and U.S. Atomic Energy Comm., archts.—Dec. 1978, BTS, p. 129. Federal Building, U.S. Courthouse, Fort Lauderdale, Fla.; William Morgan Archts., archts.—Dec. 1978, BTS, pp. 116-117. *The Federal Presence: Architecture, Politics and Symbols in United States Government Building*, book by Lois Craig and the staff of the Federal Architecture Project: an interpretive essay—Dec. 1978, BTS, pp. 122-125. "GSA competitions in the cause of quality," by Lois Craig—Dec. 1978, BTS, pp. 88-99. Memorial Station, Houston, Tex.; Clovis Heimsath Assocs., archts.—Mid-Aug. 1978, BTS, pp. 86-87. Naturalization and Immigration Service, Department of Justice, border stations, Boundary, Wash. and Scobey, Mont.; Hodne/Stageberg, archts.; border station, Yuma, Ariz.; Architecture One, archts.—Dec. 1978, BTS, p. 134. Nebraska State Capitol, Lincoln, Neb.; Bertram Goodhue, archt.—Sept. 1978, pp. 106-107. Old Federal Courts Building, St. Paul, Minn.; Perry, Dean, Stahl & Rogers, archts.—Dec. 1978, BTS, pp. 100-105. Panama-California Exhibition Buildings, San Diego, Cal.; Bertram Goodhue, archt.—Sept. 1978, pp. 104-105. Visitors Center, Table Rock Dam, Ark.; Cromwell, Truemper, Millett & Jatchell and U.S. Army Corps of Engineers, archts.—Dec. 1978, BTS, pp. 130-131. "Where the new agenda began: those guiding principals"—Dec. 1978, BTS, pp. 110-111.
 Public Works. Grand Coulee Dam Extension, Columbia Basin, Colo.; Marcel Breuer Assocs. and U.S. Bureau of Reclamation, archts.—Dec. 1978, BTS, pp. 126-127. Ruck-A-Chucky Bridge, Auburn Dam Reservoir, Cal.; Skidmore, Owings & Merrill, archts.—Dec. 1978, BTS, p. 128.

R

RTKL Assocs., archts.; VA Hospital, Baltimore, Md.—Dec. 1978, BTS, p. 136.
 Ream, James & Jacob Robbins, archts.; Oakmead Office Center, Sunnyvale, Cal.—Mid-Aug. 1978, BTS, p. 119.
 Recreational Facilities. "International Resorts," Building

- Types Study 522—Sept. 1978, pp. 129-144. Palmas Del Mar, San Juan, P.R.; Esteban Padilla, archt.—Sept. 1978, BTS, pp. 140-141. Resort Town Flaine, Haute Savoie, France; Marcel Breuer and Robert F. Gatje, archts.—Sept. 1978, BTS, pp. 136-139. Saint Francis Yacht Club, San Francisco, Cal.; Marquis Assocs., archts.—Nov. 1978, pp. 94-95.
- Regent(The) of Fiji, Fiji Islands; Black O'Dowd & Assocs., archts.—Sept. 1978, BTS, pp. 132-135.
- Religious Buildings. Chapel at West Point, N.Y.; Bertram Goodhue, archt.—Sept. 1978, p. 103. Church of the Heavenly Rest, New York, N.Y.; Mayers, Murray & Phillip, archts.—Sept. 1978, p. 108. Saint Gregory Armenian Apostolic Church, San Francisco, Cal.; Marquis Assocs., archts.—Nov. 1978, p. 101. Veterans Administration Chapel, Jefferson Barracks National Cemetery, St. Louis, Mo.; Veterans Administration, archts.—Dec. 1978, BTS, p. 133.
- Renovations & Restorations. "Existing structures offer helping hands to health care," Building Types Study 524—Nov. 1978, pp. 121-140. Bear Mountain Inn, Bear Mountain, N.Y.; Joseph Tonetti & Assocs., archts.—Sept. 1978, pp. 120-125. Brattleboro Retreat, Brattleboro, Vt.; Perry, Dean, Stahl & Rogers, archts.—Nov. 1978, BTS, pp. 126-129. Cumberland County Medical Center, Manor Nursing Home, Bridgeton, N.J.; Architects II, archts.—Nov. 1978, BTS, pp. 138-139. Dental School, Continuing Education Facility, University of Oregon Health Sciences Center, Portland, Ore.; Zimmer Gunsul Frasca, archts.—Nov. 1978, BTS, p. 137. "The happy trend to revitalization of city neighborhoods turns out to have some sobering side effects . . ." Editorial by Walter F. Wagner, Jr.—Oct. 1978, p. 13. Institute of Fine Arts Renovation, New York, N.Y.; Richard Foster & Michael Forstel, archts.—Aug. 1978, pp. 107-112. Jersey City Health Center, Jersey City, N.J.; Hillier Group, archts.—Nov. 1978, BTS, p. 133. Lutheran Medical Center, Brooklyn, N.Y.; Rogers, Butler, Burgun & Shahine, archts.—Nov. 1978, BTS, p. 132. Massachusetts General Hospital, Boston, Mass.; Perry, Dean, Stahl & Rogers, archts.—Nov. 1978, BTS, p. 136. Mosshusack Square Arcade, Providence, R.I.; Steffian-Bradley Assocs., archts.—Nov. 1978, BTS, pp. 122-125. Neonatal Intensive Care Unit, Cornell Medical Center, New York, N.Y.; Skidmore, Owings & Merrill, archts.—Nov. 1978, BTS, pp. 134-135. Old Federal Courts Building, St. Paul, Minn.; Perry, Dean, Stahl & Rogers, archts.—Dec. 1978, BTS, pp. 100-105. Old Pavilion, Stanford University, Stanford, Cal.; Barry Brukoff, archt.—Sept. 1978, pp. 119-128. Saint Francis Yacht Club, San Francisco, Cal.; Marquis Assocs., archts.—Nov. 1978, pp. 94-95. St. Louis Art Museum, St. Louis, Mo.; Hardy Holzman Pfeiffer Assocs., archts.—Oct. 1978, pp. 85-96. Sharon Hospital, Sharon, Conn.; Arneill-Kagen Assocs., archts.—Nov. 1978, BTS, pp. 130-131.
- Research Buildings. Energy Research and Development Agency, Safeguards Analytical Laboratory, Argonne, Ill.; Metz Train Olson & Youngren and U.S. Atomic Energy Comm., archts.—Dec. 1978, BTS, p. 129.
- Restaurants. Bear Mountain Inn, Bear Mountain, N.Y.; Joseph Tonetti & Assocs., archts.—Sept. 1978, pp. 120-125.
- Robbins, Jacob & James Ream, archts.; Oakmead Office Center, Sunnyvale, Cal.—Mid-Aug. 1978, BTS, p. 119.
- Rogers, Butler, Burgun & Shahine, archts.; Lutheran Medical Center, Brooklyn, N.Y.—Nov. 1978, BTS, p. 132.
- Ruck-A-Chucky Bridge, Auburn Dam Reservoir, Cal.; Skidmore, Owings & Merrill, archts.—Dec. 1978, BTS, p. 128.
- 62-63. Commodore Sloat School, San Francisco, Cal.; Marquis Assocs., archts.—Nov. 1978, pp. 96-97. Fine, Hyman Elementary School and Hill-Roberts Elementary School, Attleboro, Mass.; Henneberg & Henneberg Inc. and A.A. Trulli Assocs., Inc. Associated Architects, archts.—Aug. 1978, BTS, pp. 126-128. Foster, Marcus A. Middle School, Oakland, Cal.; Mackinlay Winnacker McNeil & Assocs. and Kennard, Delahousie & Gault, archts.—Aug. 1978, BTS, pp. 114-115. Model Secondary School for the Deaf, Washington, D.C.; HTB, INC., archts.—Aug. 1978, BTS, pp. 122-125. North End Community Schools, Springfield, Mass.; Perkins & Will Partnership, archts.—Aug. 1978, BTS, pp. 116-119. Westfield Middle School, Westfield, Ind.; The McGuire & Shook Corporation Burns-Clark-Jacobs-West, archts.—Aug. 1978, BTS, pp. 120-121.
- Seattle Federal Office Building, Seattle, Wash.; John Graham & Co. and Fred Bassetti & Co., archts.—Dec. 1978, BTS, pp. 118-120.
- Second Street Townhouses, Philadelphia, Pa.; Louis Sauer Assocs., archts.—Oct. 1978, BTS, pp. 122-123.
- Seidler, Harry & Assocs., archts.; Australian Embassy, Paris, France—Nov. 1978, pp. 103-112.
- Seifert Community Center, Stockton, Cal.; Marquis Assocs., archts.—Nov. 1978, p. 100.
- Selby, The William G. and Marie Public Library, Sarasota, Fla.; Skidmore, Owings & Merrill, archts.—July 1978, pp. 96-98.
- Sewage Pumping Station, Staten Island, N.Y.; Warren W. Gran & Assocs., archts.—July 1978, BTS, pp. 116-117.
- Sharon Hospital, Sharon, Conn.; Arneill-Kagen Assocs., archts.—Nov. 1978, BTS, pp. 130-131.
- Shawnee Village, Shawnee on the Delaware, Pa.; Callister Payne & Bischoff, archts.—Oct. 1978, BTS, pp. 127-128.
- Skidmore, Owings & Merrill, archts.; Neonatal Intensive Care Unit, Cornell Medical Center, New York, N.Y.—Nov. 1978, BTS, pp. 134-135. Ruck-A-Chucky Bridge, Auburn Dam Reservoir, Cal.—Dec. 1978, BTS, p. 128. The William G. and Marie Selby Public Library, Sarasota, Fla.—July 1978, pp. 96-98.
- Solar Energy. "Engineering for Architecture," Building Types Study 521—Mid-Aug. 1978, pp. 65-127. Alabama Power Company District Office, Montevallo, Ala.; Cobbs/Adams/Benton, archts.—Mid-Aug. 1978, BTS, pp. 92-93. Armed Forces Reserve Center, Norwich, Conn.; Moore Grover Harper, archts.—Mid-Aug. 1978, BTS, pp. 88-89. Arts Village, Hampshire College, Amherst, Mass.; Juster Pope Assocs., archts.—Mid-Aug. 1978, BTS, pp. 94-95. Community College of Denver-North Campus, Denver, Colo.; John D. Anderson & Assocs., archts.—Mid-Aug. 1978, BTS, pp. 78-81. Famolare Headquarters, Brattleboro, Vt.; Banwell, White & Arnold, archts.—Mid-Aug. 1978, BTS, pp. 82-85. Memorial Station, Houston, Tex.; Clovis Heimsath Assocs., archts.—Mid-Aug. 1978, BTS, pp. 86-87.
- Steffian-Bradley Assocs., archts.; Mosshusack Square Arcade, Providence, R.I.—Nov. 1978, BTS, pp. 122-125.
- Stone, Edward Durrell Assocs., archts.; Hotel Babin Kuk, Dubrovnik, Yugoslavia—Sept. 1978, BTS, pp. 142-144.
- Stubbins, Hugh & Assocs., Inc., archts.; Federal Reserve Bank of Boston, Boston, Mass.—Sept. 1978, pp. 109-118.
- TMP Assocs., archts.; Federal Office Building, Ann Arbor, Mich.—Dec. 1978, BTS, pp. 113-115.
- Textronix Inc., General Purpose Building 60, Wilsonville, Ore.; Zimmer Gunsul Frasca Partnership, archts.—July 1978, BTS, pp. 120-123.
- Tonetti, Joseph & Assocs., archts.; Bear Mountain Inn, Bear Mountain, N.Y.—Sept. 1978, pp. 120-125.
- Transportation. "Engineering for Architecture," Building Types Study 521—Mid-Aug. 1978, pp. 65-127. Eglinton West Station, Toronto, Canada; Arthur Erickson Architects, archts.—Mid-Aug. 1978, BTS, pp. 76-77. Washington, D.C. Metro Stations; Harry Weese & Assocs., archts.—Mid-Aug. 1978, BTS, pp. 66-71. Yorkdale Station, Toronto, Canada; Arthur Erickson Architects, archts.—Mid-Aug. 1978, BTS, pp. 72-75.
- Travis Air Force Base hospital, Fairfield, Cal.; Herbert McLaughlin, archt.—Dec. 1978, BTS, p. 132.
- Trenton State College Student Center, Trenton, N.J.; Caudill Rowlett Scott, archts.—Aug. 1978, pp. 101-106.
- Trulli, A.A. Assocs., Inc., Associated Architects and Henneberg & Henneberg Inc., archts.; Hyman Fine Elementary School and Hill-Roberts Elementary School, Attleboro, Mass.—Aug. 1978, BTS, pp. 126-128.
- U
University & College Buildings. Apartment Housing Project, New York State University, College at Purchase, Purchase, N.Y.; Gwathmey Siegel, archts.—Oct. 1978, BTS, pp. 116-117. Arts Village, Hampshire College, Amherst, Mass.; Juster Pope Assocs., archts.—Mid-Aug. 1978, BTS, pp. 94-95. Community College of Denver-North Campus, Denver, Colo.; John D. Anderson & Assocs., archts.—Mid-Aug. 1978, BTS, pp. 78-81. Dental School, Continuing Education Facility, University of Oregon Health Sciences Center, Portland, Ore.; Zimmer Gunsul Frasca, archts.—Nov. 1978, BTS, p. 137. The Institute of Fine Arts Renovation, New York, N.Y.; Richard Foster & Michael Forstel, archts.—Aug. 1978, pp. 107-112. Old Pavilion, Stanford University, Stanford, Cal.; Barry Brukoff, archt.—Sept. 1978, pp. 119-128. Physical Plant Building, University of North Carolina, Charlotte, N.C.; Clark Tribble Harris & Li, archts.—July 1978, BTS, pp. 118-119. Sawyer Library, Williams College, Williamstown, Mass.; Harry Weese & Assocs., archts.—July 1978, pp. 89-93. Trenton State College Student Center, Trenton, N.J.; Caudill Rowlett Scott, archts.—Aug. 1978, pp. 101-106.
- Urbahn, Max O. Assocs., archts.; Federal Home Loan Bank Board Building, Washington, D.C.—Dec. 1978, BTS, pp. 106-109.
- V
Veterans Administration, archts.; Chapel, Jefferson Barracks National Cemetery, St. Louis, Mo.; Veterans Administration, archts.—Dec. 1978, BTS, p. 133.
- VA Hospital, Baltimore, Md; RTKL Assocs., archts.—Dec. 1978, BTS, p. 136.
- Visitors Center, Table Rock Dam, Ark.; Cromwell, Truemper, Millett & Jatchell and U.S. Army Corps of Engineers, archts.—Dec. 1978, BTS, pp. 130-131.
- W
Warnecke, John Carl & Assocs., archts.; Los Angeles Harbor Department Administrative Office Facility, Los Angeles, Cal.—Mid-Aug. 1978, BTS, pp. 112-115.
- Washington, D.C. Metro Stations; Harry Weese & Assocs., archts.—Mid-Aug. 1978, BTS, pp. 66-71.
- Weese, Harry & Assocs. archts.; Sawyer Library, Williams College, Williamstown, Mass.—July 1978, pp. 89-93. Washington, D.C. Metro Stations—Mid-Aug. 1978, BTS, pp. 66-71.
- Welton Becket Assocs., archts.; Corporate Headquarters for Fluor Corporation and Office Building for Fluor Engineers & Constructors, Southern California Division, Irvine, Cal.—July 1978, pp. 103-108. Hyatt Regency Hotel, Dallas, Tex.—Mid-Aug. 1978, BTS, pp. 116-117; Oct. 1978, pp. 107-112.
- Westfield Middle School, Westfield, Ind.; The McGuire & Shook Corporation Burns-Clark-Jacobs-West, archts.—Aug. 1978, BTS, pp. 120-121.
- White Plains Telephone Building, White Plains, N.Y.; Haines Lundberg Waehler, archts.—July 1978, BTS, pp. 124-126.
- Whitney Road Residential Development, Perinton, N.Y.; Gwathmey Siegel, archts.—Oct. 1978, BTS, pp. 114-115.
- Wollner, Anthony D. & Anne K. Wollner, archts.; Private Residence, Darien, Conn.—July 1978, pp. 99-102.
- Wood, Peter Partners in association with GMW (Collins Melvin Ward) partnership, archts.; Amex House, American Express Headquarters, Europe, Brighton, England—Mid-Aug. 1978, BTS, pp. 122-123.
- Y
Yorkdale Station, Toronto, Canada; Arthur Erickson Architects, archts.—Mid-Aug. 1978, BTS, pp. 72-75.
- Z
Zimmer Gunsul Frasca, archts.; Dental School, Continuing Education Facility, University of Oregon Health Sciences Center, Portland, Ore.—Nov. 1978, BTS, p. 137. General Purpose Building 60, Wilsonville, Ore.—July 1978, BTS, pp. 120-123. PNB (Pacific Northwest Bell) Fourth Avenue, Office Complex, Portland, Ore.—July 1978, BTS, pp. 112-115.

FOR SALE

Tree Stamps—Treeline's top quality line of rubber stamps offer the quality of hand drawn trees with the convenience of tree stamps. Write for free catalog. Treeline, 52 Raleigh Road, Department A, Belmont, Ma. 02178.

BUSINESS OPPORTUNITY

American Arab Architect, AIA—Medical Facilities Planner, Designer and Consultant, Master of Architecture and Urban Design—Rice Univ. Health and Institutional Facilities Orientation. 23 years Diversified Experience in U.S.A. & Middle East. NCARB, Registered in Massachusetts. Permanent Residence in Minnesota, but ready to relocate. Presently working as Hospital P.A. with American A/E Firm at Athens, Greece. Looking for possible Association, Partnership or Joint Venture with a Medium Size, A/E Firm presently involved or looking for involvement in Middle East Business. Available early January 1979. BO-8312, Architectural Record.

PROFESSIONAL SERVICE

INFRA-RED
Scanning Services
P.O. Box 343 Beaver, PA 15009

- ★ Remote Temperature Measurement
- ★ Electrical Inspections
- ★ Insulation Performance
- ★ Furnace Inspections
- ★ Refractory Failure
- ★ Energy Conservation

EDWARD R. SCHAUFER, P.E.
AGA Thermovision Surveys
(412) 775-3735

OVERSEAS JOBS GUIDE

Job Hunting Guide + Directory of 650 Firms. Details on job sources, resumes, taxes. US \$6.00 + 50¢ P&H (US & Canada). To foreign addresses—add \$1.50 P&H. Friar Books, Dept. AR, 8956 E Ardenale, San Gabriel, CA 91775.

MAGAZINES

Back Issue Magazines. Free List over 200 titles, 1890 to 1978. Send Stamped Envelope: Dept. A.E. Everybody's Bookshop 317 West 6th, Los Angeles, Ca. 90014.

TO ANSWER BOX NUMBER ADS:

Address separate envelopes (smaller than 11" x 5") for each reply to:

Box Number (As indicated)

Classified Advertising Department
Architectural Record
Post Office Box 900, NY 10020

IONIZATION SMOKE DETECTOR / Designed for

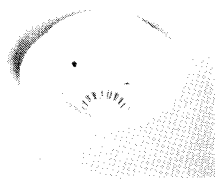

flush or surface mounting, this ionization smoke detector features identical dual-chamber construction for absolute stability: the detection chamber and its "twin" compensation chamber

react in exactly the same way to changes in temperature and humidity, fluctuations in line voltage, and component aging. A metering jack on the detector head allows for easy sensitivity testing after the unit is in place; detector sensitivity is adjustable. The detector head twist-locks into prewired ceiling-mounted bases for operation on two- or four-wire circuits. ■ Rixson-Firemark, Inc., Franklin Park, Ill.

circle 312 on inquiry card

SOLAR HOT WATER / Designed by research

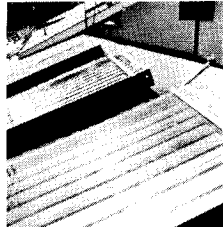

associates at the University of Oregon Solar Energy Center, these solar collectors for domestic hot water heating are said to be simple enough for the average homeowner to construct over a weekend. The collectors were constructed of structural plywood with a tempered glass cover. Behind the glass, an aluminum absorber (available in kit form) traps radiation and transfers the heat to water-filled tubes. The entire system, including a pre-heating tank and pump, should cost about \$600, according to the Center. ■ Georgia-Pacific Corp., Portland

circle 313 on inquiry card

ROOF VENTILATOR / A recirculatory roof venti-

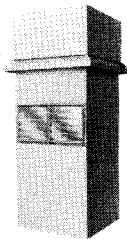

lulator blows warm stratified air down to working level in the winter, and serves as a standard exhaust device in warmer weather. An optional T-hood design can be used as an intake, mixed supply, or exhaust unit; an automatic upblast model

features a reversing motor, changing the unit from recirculation to exhaust. The ventilators are said to be easily placed in existing roofs, and come with curb, automatic shutters, reversible panel fan and two-way intake/discharge grille. ■ Industrial Air, Inc., Amelia, Ohio.

circle 314 on inquiry card

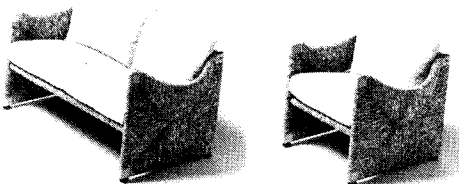

CONTRACT FURNITURE / Designed by Mario Bellini and manufactured in Italy, the "Papiro" arm chair and settee have a frame of natural beechwood, sea grass and straw. Down cushions may be upholstered in fabric or leather. ■ Atelier International, Ltd., New York City.

circle 315 on inquiry card

AZTEC

is the perfect way



to heat outside glass corridors

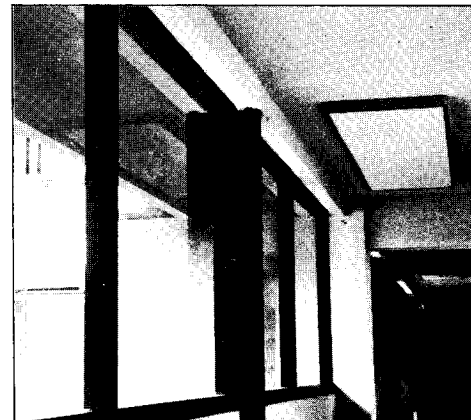

or perimeter corridors

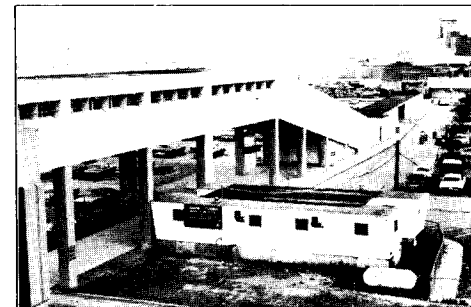

or pedestrian walkways.

Aztec low temperature electric radiant heating panels fit in or on all types of ceilings, not only saving energy and lowering life cycle costs, but allowing complete freedom in the allocation of floor and wall space and in the productive use of glass.

For more information on Aztec electric heating panels or for the Aztec engineering representative nearest you, call or write to:

AZTECH INTERNATIONAL, LTD.
2417 Aztec Rd., N.E., Albuquerque, N.M. 87107
505-345-5631

Toll free (except NM) 800-545-8306

Circle 92 on inquiry card



**Owens-Corning Wall Panels keep the office quieter.
Even when things get out of hand.**

These Owens-Corning Wall Panels are hard at work soaking up sound.

So that even the noise from the morning coffee wagon seems softer. Quieter. More bearable.

They do their job handsomely. The fabric-covered panels come in a range of colors—from quiet to loud.

And installation is almost as easy as hanging a picture.

If you're having trouble hearing yourself think, put the walls to work. In offices, schools, auditoriums, hospitals.

For a free color guide and catalogue of acoustical performance, write T. A. Meeks, Owens-Corning Fiberglas* Corp., Fiberglas Tower, Toledo, Ohio 43659.

*T.M. Reg. O.-C.F. © O.-C.F. Corp. 1978



Circle 93 on inquiry card