



AN ART CENTER FOR BOWDOIN COLLEGE BY EDWARD LARRABEE BARNES  
CREDIT LYONNAIS TOWER, LYON, FRANCE, BY COSSUTTA & ASSOCIATES  
BETTER ANSWERS TO HOUSING THE ELDERLY: MAPLE KNOLL VILLAGE  
ALL IS NOT SO QUIET ON THE WEST FRONT, BY JEAN PAUL CARLHIAN  
BUILDING TYPES STUDY: SHOPPING MALLS IN THE CENTER CITY  
FULL CONTENTS ON PAGES 10 AND 11

# ARCHITECTURAL RECORD

MARCH 1978

**3**

A MCGRAW-HILL PUBLICATION

FIVE DOLLARS PER COPY

## Letters to the editor

It's great to see a magazine take real leadership in pushing outward the frontiers of architectural thought.

In both your "Home Towns Come Back" issue [December 1976] and your "Architect, Developer Community" issue [December 1977], you have identified an emerging trend, defined its significance within a philosophical and conceptual framework, and given it a good impetus forward.

Your own piece in the December 1977 issue, "The case for design quality in today's marketplace," was excellent. You said things nobody else could say. In my view they were right on target, and I concede that they added new dimensions to my own viewpoint.

I thought that Jeanne Davern's discussion of our work in *Mondev* showed extraordinary insight and a remarkable skill in putting together ideas in about as condensed a form as they could be, and showing how they relate to each other.

Under the stimulation of your writings, architects will be led to see more fully the potential of the new roles that are opening up for them in urban development. Developers, too, can find there a new understanding of the role of design.

The new ways of working that can result will be of immense value in the development of American cities.

*Edmund N. Bacon  
Philadelphia, Pennsylvania*

As a member of the Lighting Standards Committee of the Massachusetts State Building Code Committee who supported Section 9 of ASHRAE 90-75 (hereinafter simply 90-75), I was of course interested in the news item appearing on page 34 of the November issue of *ARCHITECTURAL RECORD*. ["New Massachusetts energy standard sets limits on lighting loads in both new and old buildings"]. Your readers should be aware that while the Lighting Section of 90-75 has its shortcomings, so do the proposed alternatives.

Contrary to some contentions, 90-75 will conserve energy, is reasonable in application for both designers and code officials, and is fair to users—fairer than arbitrarily assigned watts/square foot values since it recognizes variations in lighting needs as well as the need to limit energy use.

As an A.D. Little study indicates, 90-75 can be expected to provide an average reduction from past lighting

practice of at least 25 per cent. In many cases it will be significantly more. Direct comparison with predetermined watts/square foot codes is difficult. By its very nature 90-75 will sometimes set higher limits and sometimes lower limits since it is more sensitive to both lighting needs and energy needs. In any event, unqualified statements that 90-75 will not save energy, or is less stringent than generalized watts/square foot approaches, are more rhetorical than factual.

Those who consider the identification by the lighting designer of a task (or tasks) for a given area onerous almost seem to be suggesting that the lighting requirements are independent of the task. There is also the matter of treating individually switched task lighting as though it doesn't use energy.

The inspection of the completed building is the same for either system: 1) determine total watts by counting lighting fixtures and 2) check against approved drawings. In use the design professionals will learn ways to systematize their power budget calculations—some have already been setting up computer programs. Admittedly, at the point of plans approval 90-75 may be somewhat more demanding, but not much more so than for some areas other than lighting.

The matter of fairness is, of course, largely in the mind of the judge. Equal pay for all, for example, might be considered fair by some; equal pay for equal work, by others; etc. In my judgment 90-75 is more fair than arbitrarily assigned watts/square foot values since it gives greater consideration to lighting needs. Furthermore, it has been subjected to the consensus discipline with an opportunity for participation from a broad range of interests.

In the end no code can of itself produce optimum design, nor should it be expected to. Neither need it assume that most designers are rascals intent on wasting energy. Section 9 of ASHRAE 90-75 does not attempt to dictate lighting design—it does provide an opportunity to match lighting needs with the need to use energy wisely.

*George W. Clark, PE, FIES  
Danvers, Massachusetts*

## Calendar

### MARCH

**9-10** Modern Land Use Control, sponsored by the Practising Law Institute; Hyatt on Union Square Hotel, San Francisco. Contact: Practising Law Institute,

810 Seventh Ave., New York, N.Y. 10019.

**30-31** Conference, "The Marketplace for Architectural/Engineering Services—New Directions," sponsored by COFPAES; Roosevelt Hotel, New York City. Contact: Donald A. Buzzell, COFPAES Federal Programs Conference 1978, c/o American Society of Civil Engineers, 345 E. 47th St., New York, N.Y. 10017.

### APRIL

**19** Institute on the Hospital Based Medical Office Building, sponsored by the American Hospital Association; Phoenix. Contact: Yoko B. Kojima, Department of Health Facilities, Division of Health Delivery Systems, AHA, 840 N. Lake Shore Dr., Chicago, Ill. 60611.

**20-21** "The Government Official and A-E Contracting," sponsored by COFPAES, The American Public Works Association, The American Society of Consulting Planners, and the National Institute of Government Purchasing, in conjunction with Catholic University's School of Engineering and Architecture and School of Law; The Royal Sonesta Hotel, New Orleans, Louisiana. Contact: Arnold Prima, Administrator of Government Affairs, The American Institute of Architects, 1735 New York Ave., N.W., Washington, D.C. 20006.

**23-24** Dallas Market Center, Spring Market Days. Contact: 800/527-2730.

**24-26** Conference, "Health Facility Reuse," sponsored by the Graduate School of Architecture and Planning at Columbia University with the American Hospital Association; Columbia University, New York, N.Y. 10026.

### MAY

**3-6** SUN DAY in New York, solar and alternate energy show; the Old New York Custom House. Contact: SUN DAY Center, 355 Lexington Ave., 16th Floor, New York, N.Y. 10017.

**4-6** Seventh International Conference on Noise Control Engineering, INTER-NOISE 78, sponsored by the International Institute of Noise Control Engineering; Jack Tar Hotel, San Francisco, Calif. Contact: INTER-NOISE '78, P. O. Box 3469, Arlington Branch, Poughkeepsie, N.Y. 12603.

**15-20** International Federation of Interior Designers (IFI), World Congress, sponsored by the American Society of Interior Designers; Washington, D.C. Contact: Ola M. Pfeifer, American Society of Interior Designers, 730 Fifth Ave., New York, N.Y. 10019.

ARCHITECTURAL RECORD (Combined with AMERICAN ARCHITECT, ARCHITECTURE and WESTERN ARCHITECT AND ENGINEER)

March 1978, Vol. 163, No. 3. Title® reg. in U. S. Patent Office, copyright© 1978 by McGraw-Hill, Inc. All rights reserved. Copyright not claimed on front cover and editorial four-color separations. Indexed in Reader's Guide to Periodical Literature, Art Index, Applied Science and Technology Index, Engineering Index, and The Architectural Index. Published monthly except May, August, and October when semi-monthly, by McGraw-Hill, Inc.

Quotations on reprints of articles available. Every possible effort will be made to return material submitted for possible publication (if accompanied by stamped, addressed envelope), but the editors and the corporation will not be responsible for loss or damage.

EXECUTIVE, EDITORIAL, CIRCULATION AND ADVERTISING OFFICES: 1221 Avenue of the Americas, New York, N.Y. 10020.

PUBLICATION OFFICE: 1221 Avenue of the Americas, New York, New York 10020. Second-class postage paid at New York, New York 10001 and at additional mailing offices.

OFFICERS OF MCGRAW-HILL PUBLICATIONS COMPANY: Gordon L. Jones, president; Paul F. McPherson, executive vice president; Gene W. Simpson, group vice president; senior vice presidents: James E. Boddorf, planning and development; David G. Jensen, manufacturing; Ralph R. Schulz, editorial; vice-presidents: James E. Hackett, controller; Robert L. Leyburn, circulation; Edward E. Schirmer, sales.

CORPORATION OFFICERS: Harold W. McGraw, president, chief executive officer and chairman of the board; Robert N. Landes, senior vice president and secretary; Ralph J. Webb, treasurer.

SUBSCRIPTIONS: Subscriptions solicited only from architects and engineers. Position, firm connection, and type of firm must be indicated on subscription orders. Please allow 4-12 weeks for shipment.

CHANGE OF ADDRESS or subscription service letters should be forwarded to Fulfillment Manager, ARCHITECTURAL RECORD, P.O. Box 430, Hightstown, N.J. 08520. Provide old and new addresses, zip code or postal zone number. If possible, attach issue address label. Annual subscription prices: U.S., U.S. possessions: \$17.00 for architects, engineers and other individuals in the fields served; others \$26.00. Canada: \$19.00 for architects, engineers and other individuals in the fields served; others \$28.00. Australia, Brazil, and Japan: \$40.00 to architects, engineers; others, \$45.00. Other countries: \$35.00 to architects, engineers; others, \$45.00. Single copies: \$5.00.

GUARANTEE: Publisher agrees to refund that part of subscription price applying to unfilled part of subscription if service is unsatisfactory.

ASSOCIATED SERVICES/McGraw-Hill Information Systems Co.: Sweet's Catalog Files (General Building, Engineering, Industrial Construction and Renovation, Light Residential Construction, Interiors), Dodge Building Cost Services, Dodge Reports and Bulletins, Dodge/SCAN Microfilm Systems, Dodge Management Control Service, Dodge Construction Statistics, Dodge regional construction newspapers (Chicago, Denver, Los Angeles, San Francisco).

THIS ISSUE is published in national and separate editions. Additional pages of separate editions numbered or allowed for as follows: Western Section 32-1 through 32-4. POSTMASTER: PLEASE SEND FORM 3579 to Fulfillment Manager, ARCHITECTURAL RECORD, P.O. Box 430, Hightstown, N.J. 08520



# In Warroad, Minn., the “custom” is always right

We do a lot of things that benefit the architect who does beautiful things with wood windows. We gladly provide special shapes and sizes, oversize jambs, true divided lites, special casing, solar bronze or gray glass, and other options. Normal shipping schedules apply, eliminating delays during the building phase. Write for literature. Marvin Windows, Warroad, MN 56763. Phone: 218-386-1430.

*You've never been so insulated in all your life.*

Architect: Keith Waters



**Marvin  
Windows**

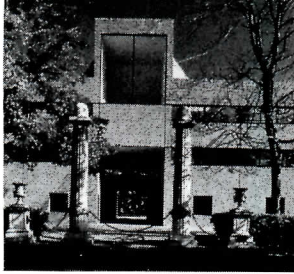

Visual Arts Center, Bowdoin College

## For good looks and low maintenance, International Harvester specified Alcoa V-beam siding.



Beauty, economy and low maintenance. That's what International Harvester wanted from the siding for its new automated materials stor-

age facility in East Moline, Illinois. And that's why Alcoa® V-beam siding was chosen—because it offers all that—and more!

V-beam siding is a strong, formed sheet product, so it was the logical choice for durability. The contours are simple yet attractive, giving just the appearance that International Harvester wanted. Yet, for all its strength and beauty, V-beam siding is light, inexpensive and easy to install.

Alcoa's Super Alunalure® Gold finish was selected. Its rich, earthy color blended beautifully with the facility's surroundings. And like all of our other nine colors, it requires little maintenance.

Alcoa makes a wide range of commercial and industrial building products in a number of gages, configurations and colors. And engineering and design assistance from Alcoa's technical staff is available. For more information on the many advantages of Alcoa industrial building products, write: Aluminum Company of America; 1140-C Alcoa Building, Pittsburgh, PA 15219.

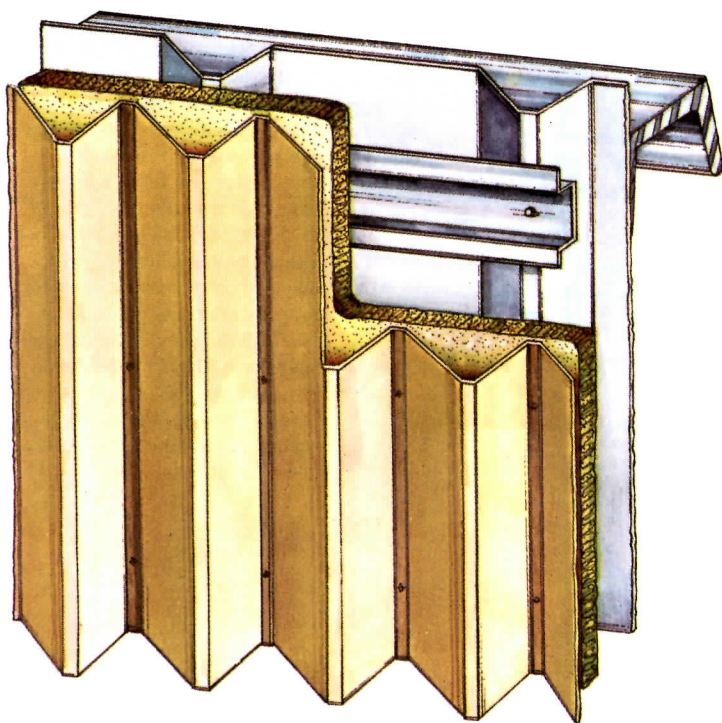

**We can't wait for tomorrow.**

 **ALCOA**

*For more data, circle 7 on inquiry card*

## Some reflections on the NAHB Convention

There are good and bad things about going to an NAHB Convention.

The bad thing is that so many builders and architects and lenders and producers and government officials go to them (attendance this year in Dallas was well over 50,000) that even a hotel reservation with "confirmed and guaranteed" stamped all over it doesn't get you a room. This year every place in Dallas was filled and more than a few who didn't have some kind of connection or another were staying on the far side of Dallas/Fort Worth airport and had to get up awfully early to catch a nine o'clock session. And trying to get dinner! I survived only by sneaking into the hospitality suite of our sister publication, *HOUSING*, and eating a lot of hors d'oeuvres.

The good thing about attending an NAHB convention is that it is such a very good convention. It attracts top speakers like HUD Secretary Patricia Harris and Assistant Secretary Lawrence Simons; Senate Majority Leader Byrd and a number of his fellows; the super-smart and involved mayor of Portland, Oregon, Neal Goldschmidt; Lud Ashley, the able and thoughtful chairman of the House Subcommittee on Housing and Community Development (and head of the Ad Hoc Select Committee on Energy in his spare time); Oakley Hunter, head of Fannie Mae, John Dalton, head of Ginnie Mae, and Philip Brinkerhoff, president of the Federal Home Loan Mortgage Corporation; Herb Stein, former chairman of the President's Council of Economics; and so on. . . .

The NAHB Convention offers (I just spent 10 minutes counting in the program) no less than 87 separate scheduled program sessions ranging from An Overview of the 1978 Mortgage Market and Using the Lumber and Plywood Futures Market to Capitalizing on the Swinging Singles Market. Those meetings, spread over three days, followed three days of meetings of 70 standing committees. Mixed in were scheduled sessions of consultation between attendees and NAHB staffers on 33 subjects ranging from apprentice training to zoning; and on top of that were offered 61 open-discussion meetings with experts in various phases of buildings ranging from Builder-Subcontractor Relations to an AIA-organized Plan Room Workshop to which builders can bring their land plans or house designs for criticisms.

It's an impressive platter of useful knowledge that is offered to the homebuilders—and you better believe they take it seriously. Almost all of the sessions were heavily attended.

From a design and architectural point of view I can report that there was a *lot* of traffic through the AIA's Plan Room Workshop.

The numerous sessions I mentioned earlier included a good many on design- and planning-related subjects, including cost-effective residential development standards, energy cost reduction for apartments, interior design; the zero lot line house, a regional overview of community landscaping, solar energy, active or passive, systems technology in construction, designing bathrooms and development of small "community shopping facilities," "custom features at affordable prices," designing and building energy-efficient homes, barrier-free design for the handicapped, and land development for the small-volume builder.

A number of plan services were offering their designs for sale in the exhibit area—and if they did not have quite the traffic that Frigidaire generated with a great barbershop quartet and Kohler did with its "Environment"—a multi-purpose bath unit which offers not just bathing but sun bath, steam room and "gentle rain," all demonstrated for one's wondering eyes by an extraordinary young lady—those "plans by the dozens" attracted a lot of attention and a lot of builders were giving their names for future follow-up.

Most astonishing, and more encouraging: The session on Design 1978—which featured Art Danielian, Walt Richardson, and Barry Berkus, all very good architects experienced in residential design and all from (guess where?) California—was not just jammed but overflowing. As a good architectural editor should, I went to listen and could not squeeze into the room, which must have seated between three and four hundred. Builders had dragged chairs up to the door and were standing on them in the hallway trying to hear and see the slides.

The whole performance made me wonder once again why we cannot manage a connection between more homebuilders and more architects. A lot of California builders are working with California architects who seem to do very well in that kind of practice—and the results show. While I am not an unbridled admirer of California residential design, I cannot think of a state where there is more good residential design—some of it (like the work of perennial award winners Fisher-Friedman and Donald Sandy Jr. AIA/James A. Babcock) not just of very high design quality but consistently fast-moving in the marketplace. There are some lessons here somewhere for architects.

—Walter F. Wagner, Jr.

ARCHITECTURAL RECORD March 1978 13

**The American National Metric Council will present its plans for measurement conversion in construction** at its annual conference April 2-5 in Atlanta. Plans include working timetables and identify potential forecasting and scheduling problems. For information: ANMC, 1625 Massachusetts Avenue, N.W., Washington, D.C. 20036.

**The Fellows of the American Consulting Engineers Council have established a \$10,000 Award of Honor** for outstanding engineering accomplishment in applied research, design, and development of materials, processes or procedures. The 1979 Award will go to an engineer or team developing practical advances in energy production or conservation. Nominations will be accepted until December 8 by the Fellows' Award of Honor, ACEC, 1155 15th Street, N.W., Washington, D.C. 20005.

ARCHITECTURAL RECORD March 1978 33

---

# ONLY U.S.G. MAKES IT ALL...DOWN TO THE STUDS!

---

We firmly believe that a systems-oriented approach is imperative to helping you meet today's extraordinary commercial building needs. That's why you'll find U.S.G. systems innovative in concept, practical in application, and fully integrated down to the steel stud framing. As proof, we offer here just three of many complete answers for your consideration—proved alternative ways to meet and beat the specs at significant time and cost-savings.

Write to us at 101 S. Wacker Drive,  
Chicago, Illinois 60606,  
Dept. AR-38.



Curtain Wall

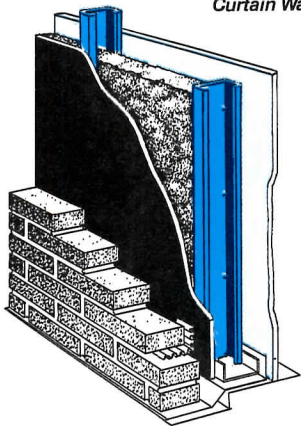

**VERSATILE WAYS TO ENCLOSE STRUCTURES ECONOMICALLY!** USG® Curtain Walls offer lightweight non-load bearing systems that fabricate fast on or off the job site, using conventional components. Chase space is provided for running services. USG Curtain Walls are suitable for steel or concrete framing and offer excellent thermal insulation to help conserve energy.

Fire: 2 hour  
Weight: 2.7 to 4.3 lb/ft<sup>2</sup> (13.2 to 21.0 kg/m<sup>2</sup>)  
excluding exterior cladding  
Wind Load: up to 40 lb/ft<sup>2</sup> (1.92 kPa)  
Thermal Resistance, "R": up to 24 °F•h•ft<sup>2</sup>/Btu  
(4.2 k•m<sup>2</sup>/W)

AR-38A

Masonry Furring

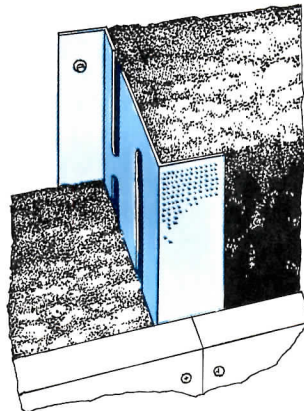

**MORE "R" FACTOR PER DOLLAR PLUS POSITIVE ATTACHMENT!** New USG® Z-Furring Channels assure positive attachment. Gypsum panels screw to Z-channels that attach directly to masonry. Hold more securely than metal over insulation systems where "fishhooking" of pins sometimes occurs. This advanced technique cuts heat loss by providing a major increase in thermal resistance.

Thermal Resistance, "R": up to 25 °F•h•ft<sup>2</sup>/Btu  
(4.4 k•m<sup>2</sup>/W)

AR-38C

Shaft Wall

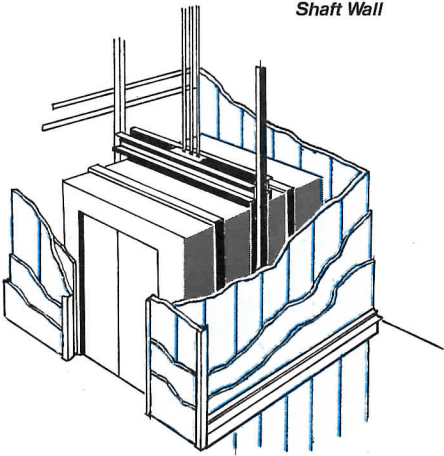

**COST-SAVING ALTERNATIVE TO BULKY MASONRY SHAFTS!** USG® Shaft Wall System with the C-H stud provides a 1½" chase space for services. Utilizes ½" SHEETROCK® FIRECODE "C" gypsum panels, instead of 5/8" panels. Requires less space and its lighter weight saves on structural steel, reduces material handling.

Fire: 1 and 2 hour  
Sound: up to 50 STC  
Weight: 8.5 lb/ft<sup>2</sup> (41.5 kg/m<sup>2</sup>)

AR-38B

**UNITED STATES GYPSUM**  
BUILDING AMERICA

For more data, circle 20 on inquiry card

## DOE's 1979 budget shows increased emphasis on weatherization and growing interest in underground dwellings

The Carter Administration wants to double its spending on ways to save energy in houses. The new funding level, if approved by Congress, will allow the Department of Energy to spur the commercial sale of energy-efficient houses and promote the design of underground dwellings.

One measure of DOE's increased emphasis on energy conservation in residential and commercial buildings: the Department's fiscal 1979 budget would go to \$263 million, up from just \$125 million set aside for the purpose this year.

A large part of the increase is for DOE's weatherization assistance program, which is intended to help states improve the energy efficiency of low-income housing, especially that owned by the elderly or the handicapped. This part of the budget alone would rise from a current \$64 million to \$199 million in fiscal 1979.

Smaller increases, however,

would let the Department move ahead with projects to get energy-saving designs into the marketplace. In Orange County, California, for instance, DOE is currently teaming up with Mission Viejo, Inc., to design energy-efficient houses. "These are in the planning stage now, but in fiscal 1979 they'll start cranking them into production," says John Cable, DOE's chief architect and engineer in the division that deals with energy conservation in buildings.

The Mission Viejo project coincides with President Carter's emphasis on getting designs—in housing as well as other areas—off the drawing boards and into production.

The Department's underground housing project poses more problems and is only now in the development stage. It is part of the "innovative shelters" program, and the title is an understatement. As DOE officials foresee development, houses would be

built largely underground, with some portions remaining above the surface to provide inhabitants with an esthetic view and some daylight.

Mr. Cable says the Department will first evaluate energy savings in such houses, then determine whether they are cost-effective. If both findings are positive, DOE will ask for designs in fiscal 1979.

"Right now, the obstacle is institutional financing," says Mr. Cable, "and if we finally decide to go ahead, we will initiate programs with S&Ls and mortgage companies, and then possibly go on to demonstration villages. Right now, the financing institutions won't go along with underground housing because they have doubts about its resale value."

DOE plans to sponsor a national conference on underground housing this spring at the University of Texas at Arlington. A date will soon be announced.

President Carter's proposed 1979 budget will also let DOE move ahead faster on the five-year-old air infiltration project that it took over from the National Science Foundation. The project is currently limited to a study of urban houses in Princeton, New Jersey.

"What we are finding there," Mr. Cable says, "is that insulation is not always what it's cracked up to be." According to the DOE architect, air infiltration at walls, doors, windows and other vulnerable areas is often so great that insulation in traditional locations has much less impact than was originally estimated.

In addition to these projects, DOE will continue in the upcoming fiscal year the study of such areas as roofs and walls, ventilation (to second-guess widely varying local building codes), illumination, and energy performance standards.—*Don Ediger/William Hickman, World News, Washington.*

### In Federal budget, building wins a little, loses a little

President Carter's carefully crafted spending blueprint for the government's fiscal year beginning October 1 is sure to be modified by Congress, which has its own ideas about how the people's business ought to be run.

But if recent history is any indication, enough of what the President proposes will be adopted to make his suggestions significant.

Essentially, the President's plan has three parts: a spending level that's austere by contemporary standards, a tax plan intended to increase consumer spending and encourage businesses to make capital investments, and a voluntary damping of inflation.

What this means to the construction industry is hard to gauge. Inducements for businesses to make capital investments in new buildings and plants have obvious advantages for construction. And construction is more sensitive to inflationary pressures than other industries and will benefit if they are held in check.

If Congress goes along with Mr. Carter, however, direct Federal spending on construction will be lowered. The General Services Administration, for instance, is down for less than \$40 million of its own funds to begin new buildings. It does, however, have a record \$189 million for major repairs and alterations.

President Carter does not propose another extension of the Local Public Works program, and hospital construction undertaken by the Veterans Administration faces a reduced spending level.

But the President wants the Department of Housing and Urban Development to make a 65 per cent increase in new subsidized housing starts, to reach a new total of 296,700 units. Community development block

grant spending will hold steady at about \$2.6 billion, and the new "action grant" program for neighborhood renewal—with \$409 million in funds—is expected to produce actual spending of \$159 million in fiscal 1979.

The tax cut, pegged at \$25 billion, is about evenly divided: half for businesses to aid in capital formation, and half for consumers to make up income losses incurred as Social Security taxes increase.

And because of Treasury losses due to the tax cuts, Mr. Carter predicts a \$60-billion deficit in the \$500.2-billion budget. While this would represent a record amount in spending, it is actually only 2 per cent above present annual spending in inflation-adjusted dollars.

Still, the business community is concerned about the Carter plan. While it does not specifically object to the spending program, it has serious doubts on other fronts. Clamps on expense-account entertainment and travel seem like harassment to businessmen. And they object to laws eliminating the export-promoting Domestic International Sales Corporation (DISC) allowance as well as other tax breaks for U. S. companies operating abroad.

Labor, too, finds objections to the plan. Their complaint: despite labor's all-out support for Mr. Carter's candidacy, the President is lukewarm, or opposed to, most labor-supported programs. He did give the Humphrey-Hawkins full-employment proposal moderate support; he also suggested that Congress begin taxing unemployment insurance benefits when family gross income exceeds \$25,000.

Big city mayors are highly critical of Carter's plan, too, and they have become pessimistic about their chances of getting what they want when the President springs his urban

policy message this month. The problem is that the Carter Administration continues to plug "targeting" of existing funds from existing programs as a way of helping needy cities. The mayors say urban progress depends on new Federal dollars.

If the mayors got their way, Mr. Carter would go for an \$11-billion supplemental budget request along with his urban message that would include \$6 billion more for employment programs, \$2-3 billion more for economic development and \$1 billion more for transportation.

Mayor Lee Alexander of Syracuse, president of the U.S. Conference of Mayors, expressed alarm at the President's goal of reducing Federal spending as a percentage of Gross National Product, saying that Mr. Carter cannot do this and still push for health insurance, welfare reform, and help for the needy cities.—*William Hickman, World News, Washington.*

### Texas Society of Architects plans town-meeting project

The Texas Society of Architects has planned an ambitious and well-thought-out program to engage the cooperation of laymen throughout the state in an examination of the quality of life in Texas during a period of many changes.

Launching the year-long program, titled "Texas—The Quality Life," at TSA's recent annual convention, President Preston M. Bolton said, "We want a dialogue between the architects of Texas and their fellow citizens which will help people *design* the future instead of just letting it happen to them." By opening up such communication, the Society hopes it can create opportunities for its membership to exercise architectural leadership at the local level.

One of the problems TSA had to meet in planning the program was the great diversity of communities within the state. Wichita Falls, El Paso and Houston, for example, come close to being a three-way set of opposites, and the Society did not want, in the words of a spokesman, "a media program neatly packaged for distribution to 17 chapters."

Instead, TSA has asked each chapter to submit a program tailored to its own community, local concerns with the built environment, and the citizen groups most likely to supply insight and good questions at a "town meeting." TSA offers in return help in programming, recruiting speakers, publicity, and funding.

The San Antonio chapter has scheduled the first of these town meetings for March 17. As the first community in Texas to have a metropolitan-wide transit system, San Antonio will take the theme "Mobility and the Good Life: A Challenge for San Antonio." Participating groups, in addition to the AIA chapter, include the new Metropolitan Transit Authority, the Alamo Area Council of Governments, Centro 21, a city-supported "action team" of civic and business leaders, and the Departments of Environmental Studies at both Trinity University and the University of San Antonio.

Other TSA chapters contemplate programs on such subjects as energy conservation, downtown revitalization and the interaction of urban growth and the quality of life. Suggested conference participants range from universities and other professional organizations to chambers of commerce.

Although TSA does not expect all 17 chapters to submit ideas for meetings in 1978, it does expect that the town-meeting program will continue in following years.



## Long-range economic outlook reflects population decline

The nation's population growth rate will continue to decline in coming years, with profound impression on the national economy. But economics is like architecture: sometimes less is more.

That, essentially, is the conclusion drawn by 41 economists who advised a Congressional committee on long-term economic growth prospects. The staff of the Joint Economic Committee has distilled research papers submitted by the economists and has concluded that the nation is entering upon a new economic era.

The era will be marked by a further decline in the birth rate, a reduction in the size of the work force leading to labor shortages and productivity increases, and a continuation of technological progress. The new conditions will also mean, the study predicts, some improvement in the quality of American life.

The annual growth of the country's labor force will fall to less than 1 per cent by the late 1980s, a reflection of the steady decline in the U.S. birth rate since 1960. At the same time, the potential growth of full-employment Gross National Product may be expected to decline from today's 4 per cent to about 3 per cent per year.

The growth of the labor force will continue to decline, the report predicts, through the year 2000, reducing potential GNP growth close to the level of the growth in productivity. If the nation can adjust to these changes, the economists believe, they will lead to faster increases in per capita income and the quality of life.

The researchers have other good news: the long-foreseen materials shortage has been "defeated" for a number of reasons, one of which is

the reduction in the size of the nation's automobiles and the phase-out of leaded fuel for use in private cars. A second factor limiting the demand for basic materials is the gradual decline in the formation of new households.

Moreover, the economists do not see growth hampered by a lack of capital. The prevalent view of the independent economists is that "no pervasive shortage of investment funds is likely, barring a sustained investment boom extending into the 1980s."

Most analysts agree, however, that the fraction of GNP going into business investment over the next several years must be somewhat higher than in the past decade. This can easily be accomplished, the analysts say.

The study takes issue with President Carter's plan for warming up the economy by providing corporations with incentives to invest. "It is questionable that new corporate tax incentives will substantially boost investment," the study says, and it contends that investment incentives ought to be spread equally in other areas—human capital, research and development, unincorporated businesses and residential capital.—*William Hickman, World News, Washington.*

## HUD plays down new towns, shifts attention to old ones

The dream of building a string of Federally financed new towns across the country was taken off the drawing board and put into legislation by the Democrats 10 years ago. In January, a Democratic administration finally consigned it to the ash can.

Of the 13 new towns that won Federal approval, only six—financed by \$150 million of government-backed

bonds—are still "judged to be capable of continued development," according to Housing Secretary Patricia Harris. The seven others are broke, with HUD forced to pay off \$149 million of developers' bonds.

The new towns HUD deems financially viable are St. Charles, Maryland; Maumelle, Arkansas; the Woodlands, Texas; Soul City, North Carolina; Harbison, South Carolina; and Shenandoah, Georgia. The new towns that went broke are Jonathan, Minnesota; Park Forest South, Illinois; Cedar-Riverside, Minnesota; Riverton, New York; Flower Mound, Texas; Gananda, New York; and Newfields, Ohio.

Mrs. Harris at a recent news conference spoke of "embarking on a new course" and of a HUD decision to "support new-towns-in-town instead of creating new satellite cities. . . ." But what HUD officials had to say suggests that the new program—if it actually materializes—would be more aptly described as a revival of the urban renewal program.

New Communities Administrator William White made it clear that HUD has ended government guarantees for bonds of private developers, guarantees that were the financial heart of the New Communities program.

Mr. White also said that any further financial commitment by HUD to the new-town-in-town idea depends on showing the White House and the Office of Management and Budget that little or no additional Federal funds will be required to support the six new communities that HUD hopes can stay afloat.

HUD officials said that the new "in-town" concept is to have cities use already-cleared renewal sites for future neighborhood development projects with the help of HUD grants only.

Other HUD sources noted that under the 1977 Housing Act cities receiving community development

block grants are authorized to use these funds to guarantee loans, and to pay the principal and interest on guaranteed loans. They say this new source of financing could, on a smaller scale, replace the Federal guarantees no longer being made under the New Communities Act.

The mayors of a number of cities immediately began seeking HUD funds under the new program—among them Baltimore, Boston, Chicago, Detroit, Hartford, Milwaukee, New York City, Sacramento, Columbus, Ohio, Los Angeles, Toledo, Washington, D.C., Atlanta, Macon, Georgia, Memphis, and Nashville.

Most of these mayors would also like some of the \$1.2 billion the Secretary has to hand out over the next three years under the new "action grant" program aimed at stimulating private investment in distressed inner cities. Under this program—Carter's original initiative to help out ailing central cities—some 300 cities and towns have been deemed "eligible" under the criteria laid down by Congress to guide Mrs. Harris in her picking and choosing.

A major requirement of the program is for the city to show firm commitments from private investors to put their own money into a neighborhood; otherwise, HUD officials say, no Federal grant will be approved.

HUD's fiscal 1979 budget shows an estimated 300 projects to be approved for a piece of the first \$400 million to be passed out under this program. But HUD officials say they expect that perhaps only 150 cities will get grants—with the middle-range running around \$3 million. By law, 25 per cent of the funds must go to cities and towns with less than 50,000 population. HUD expects to announce approved projects by the end of this month.—*Donald Loomis, World News, Washington.*

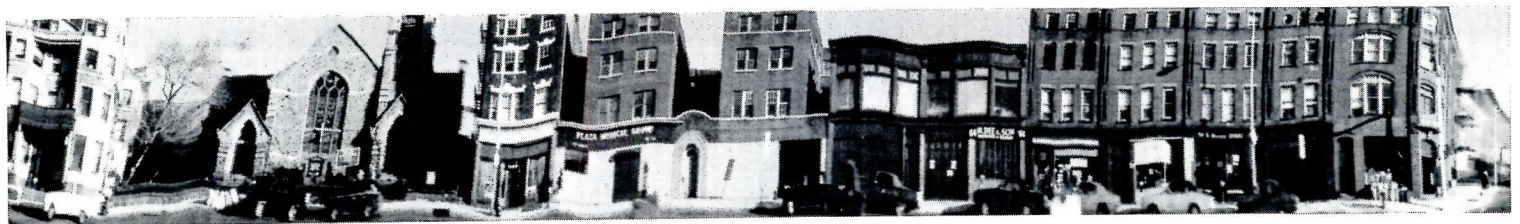

## Yonkers museum looks behind the dilapidation of its own neighborhood to discover salvageable beauty

Yonkers, New York, which at the turn of the century provided a believable milieu for Thornton Wilder's *Dolly Levy* and her suburban matchmaking, has in recent years fallen into civic discouragement and bankruptcy. To restore pride in the city's common architectural possessions and to offer encouragement for renovation, the Hudson River Museum in Yonkers retained the services of architects Hardy Holzman Pfeiffer Associates to assemble and design a special exhibit titled *Warburton Avenue: The Architecture of a Neighborhood*.

Warburton Avenue is one of Yonkers' main arteries, along which many buildings have suffered decay or demolition, but which still has a number of distinguished buildings as well as some potentially attractive old houses.

One of the exhibit's major components is a pair of 125-ft-long photomurals installed in a tunnel and depicting both sides of a mile-and-a-quarter stretch of Warburton Avenue, from Phillipe Manor Hall, an 18th-century national landmark, to the Museum itself, originally a Victorian building

that was renovated and added to a few years ago by SMS Architects. The mural, a detail of which is shown above, was photographed and hand-painted by the Globus Brothers, who used their Globusscope, a computerized scan camera that produces an extremely long seamless exposure.

The exhibition also displays a number of architectural artifacts from the neighborhood, including the unrestored facade of a recently demolished frame house with porch and Victorian ornament—evidently the hit of the show.

Hardy Holzman Pfeiffer have, moreover, contributed conceptual designs for the adaptive use of three abandoned buildings on the street—an ex-A&P, for example, might become a community center, in answer to what a pre-exhibit survey indicated is a need felt by the neighborhood.

In conjunction with the exhibition, which continues until March 19, the Museum will offer a number of how-to workshops on fixing up, and its bookstore will supply literature on the techniques and financing of residential renovation.



# WATERPROOF. WEATHERPROOF.

## STYROFOAM\* brand insulation in the IRMA roof design protects you from both water and high energy costs.

This protected membrane roof does more than keep rain and snow out.

It also protects against one of the biggest energy thieves in a building today—heat loss through the roof. And in the summer, cool air loss.

With the IRMA system, you're assured of years of insulation value. Unlike conventional roof systems, it protects the membrane. So it's less likely to rupture and let in moisture.

### New Roof or Re-roof

Our protected membrane roof is the perfect finish for your new building.

It's also ideal for re-roofing. So even older buildings can experience the advantages of the IRMA system—both in terms of membrane protection and energy savings.

### An Unconventional Approach

The IRMA roof design is a patented technique that uses conventional materials in an unconventional way. The roof membrane is laid directly on the roof deck. It's then covered with

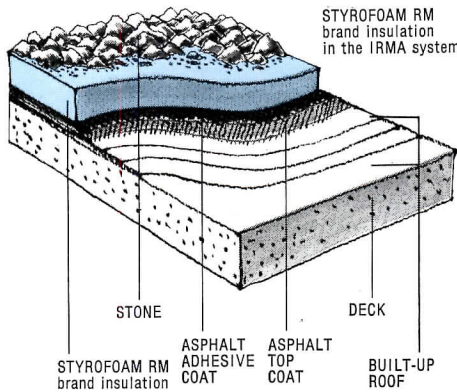

STYROFOAM RM brand plastic foam insulation and finished with crushed stone.

The membrane is protected from heat and cold as well as from the elements. So it stays pliable. And it lasts longer. In fact, experimental roofs have performed for 20 years and more without trouble.

### 10 Year Water-Tight Warranty

We're so confident of the protected membrane roof that we warrant it to be water-tight for 10 years. Also, we warrant that STYROFOAM RM brand insulation will retain at least 80% of its thermal resistance for 10 years.

If it doesn't perform as warranted, The Dow Chemical Company will repair or modify the roof at its own expense to assure performance as warranted. A complete copy of the warranty is available upon request.

For more information on how the IRMA system can weather-proof and waterproof your building, write to The Dow Chemical Company, STYROFOAM RM, Midland, MI 48640.

**STYROFOAM\***  
BRAND INSULATION



\*Trademark of The Dow Chemical Company

*For more data, circle 21 on inquiry card*

WARNING: STYROFOAM brand insulation is combustible and should be properly installed. For roofing applications it should be provided with an adequate protection. For specific instructions see Dow literature available from your supplier or from Dow.

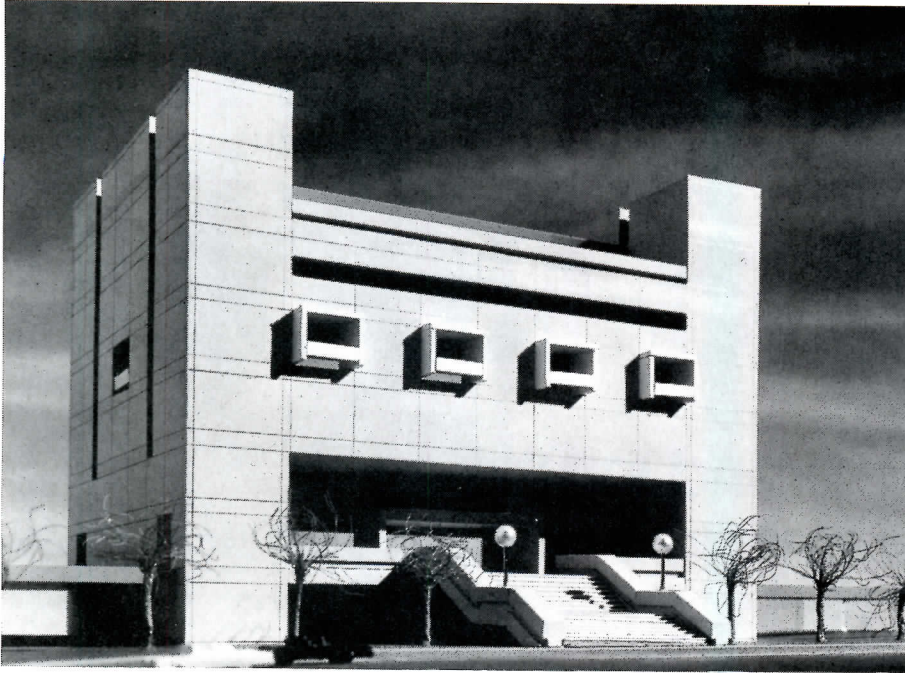

Louis Checkman

### Institute of Public Affairs will honor Hubert Humphrey

The late Senator Hubert H. Humphrey of Minnesota was not only an honored public servant but a much-loved teacher, a role he never entirely foresook during his years in office. Unveiling the design for the new Humphrey Institute of

Public Affairs to be built at the University of Minnesota, Vice President Mondale called it "an especially fitting tribute to an extraordinary public servant." Designed by Carson, Lundin & Thorson, PC Architects, the building will sit on a high bluff

overlooking the Mississippi River and will serve as a gateway to the campus in Minneapolis. The structure, faced with buff-colored Minnesota stone, will surround and incorporate an existing building. Estimated cost is \$4 million.

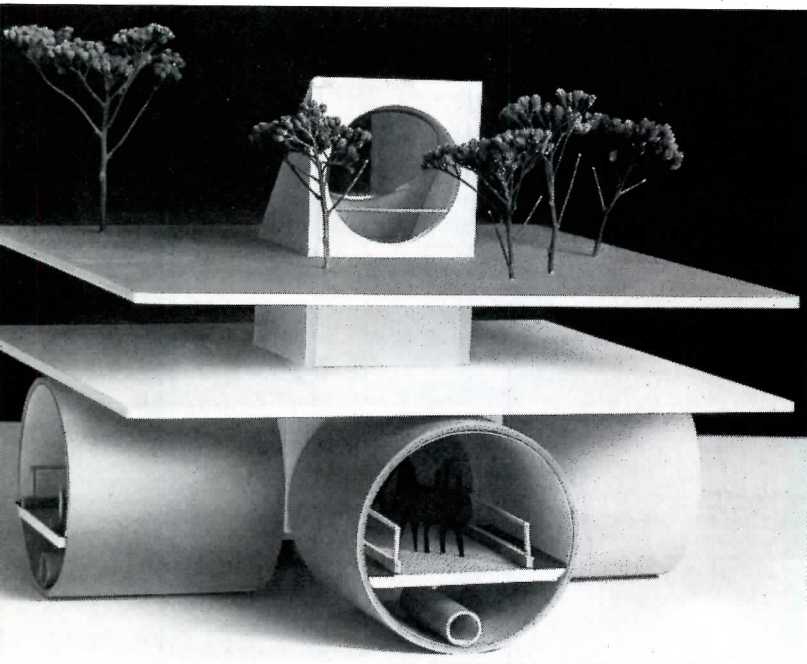

### Periscopes bring light and "view" underground

At Detroit Medical Center, a 15-ft patient transportation tunnel, now under construction, will provide underground connection to a new central unit for radiation therapy from six hospitals and Wayne State University's medical school. To supply illumination—and a glimpse of the outdoors—four outside periscopes will penetrate the tunnel at intervals along its 450-ft

length. Large angled mirrors, mounted inside the sloping roofs of towers at the surface, will reflect light and views of the landscape to the space underground. The concrete towers will be 12 ft high and 13 ft square. The designers are William Kessler & Associates, Inc., Zeidler Partnership, Inc., and Giffels Associates, Inc., in architectural joint venture.

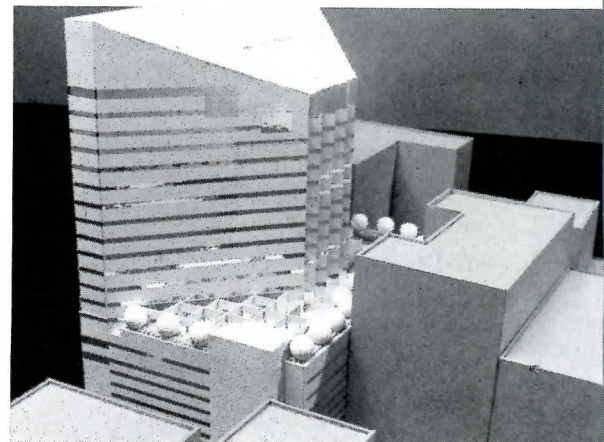
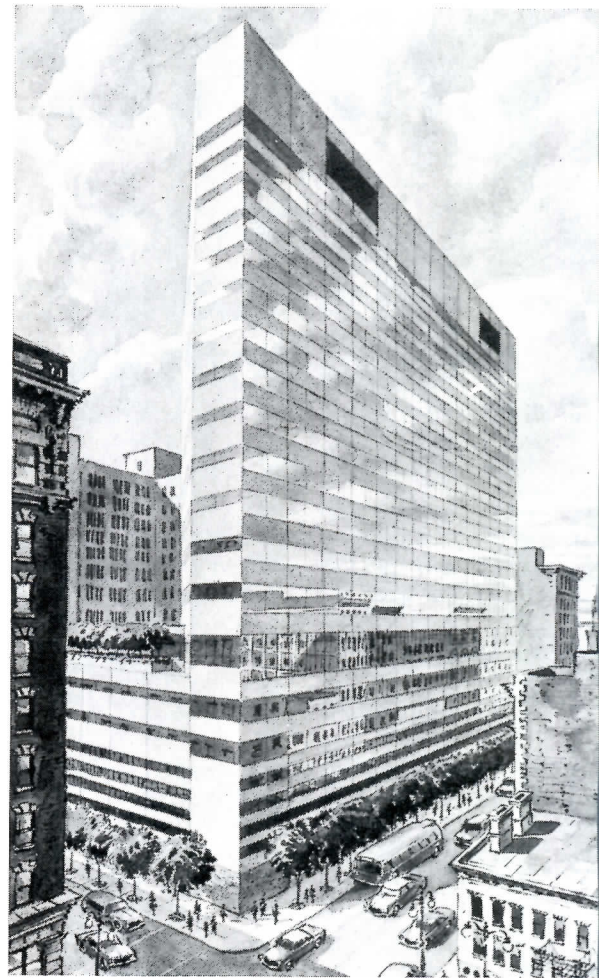

### RTKL win competition for Federated offices

Federated Department Stores, Inc., intending to build a corporate headquarters building in Cincinnati, invited five design-build teams to submit entries in competition. The winning design, by RTKL Associates, Inc., of Baltimore, with builders Henry C. Beck Co., Inc., of Dallas, is a 21-story building that will incorporate a renovated parking garage at its base. The

pleated south wall and flanking angled walls will command a generosity of views toward the Ohio River and Kentucky. At the 20th floor, an atrium will provide reception area for terraced executive office on the top two floors. The curtain wall will be beige aluminum panels and silver reflective glass, and the parking garage will be faced with granite.

**Packers of herbal tea will build in Colorado**

Celestial Seasonings, a firm that blends and packs herbal teas (including Zinger and Sleepy-Time, among others), will build its new offices and manufacturing facilities in Boulder, Colorado. The plant, which will include bagging rooms, warehousing for raw herbs and packaged teas, and laboratories, as well as administrative offices, will be heated and cooled by an active/passive hybrid solar mechanical system. Among the amenities to be offered the company's employees: a meditation pavilion, housed in a pyramidal shelter on the grounds near the office building. The architects of the \$3.5-million project are Joint Venture, Inc., of Boulder.

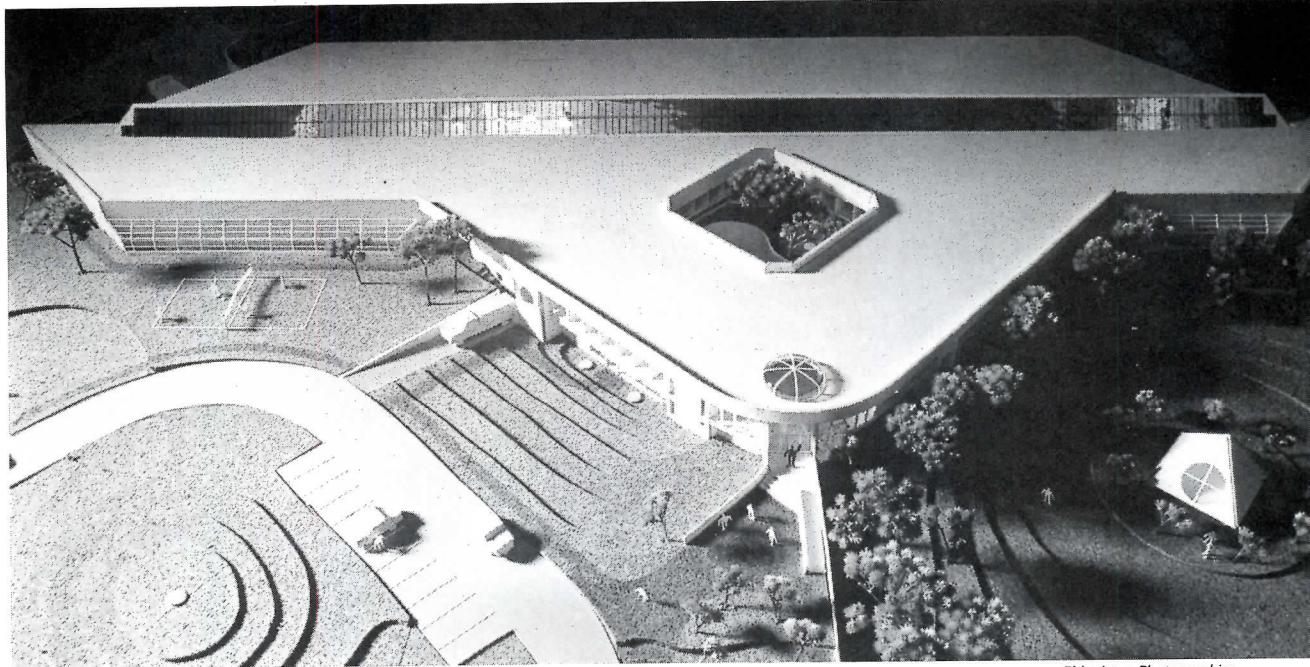

Phlogiston Photographics

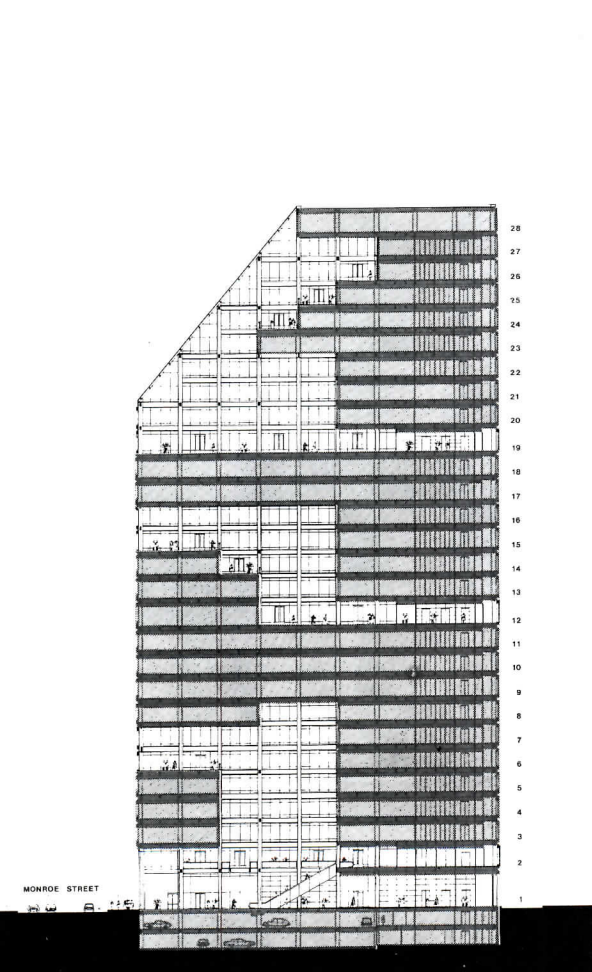

**SOM stacks up three atriums in Chicago office building**

By stacking their atriums vertically, Skidmore, Owings & Merrill, Chicago, have managed to furnish an office building with no fewer than three of them. Looking at it another way, they have managed to enclose three office buildings in one envelope. Developers Draper and

Kramer call the building, now under construction in downtown Chicago, the "first multi-atrium office building in the country." SOM located the mechanical core at the back of the building, freeing the front for either atriums or expansive office floors. The terraces over-

looking the atriums afford a variety of spatial configurations from floor to floor, and areas will vary from 22,000 to 38,500 sq ft per floor. The curtain wall will combine an insulated aluminum panel with triple semi-reflective glazing. Completion is scheduled for late 1979.

## Plywood Design Series-2

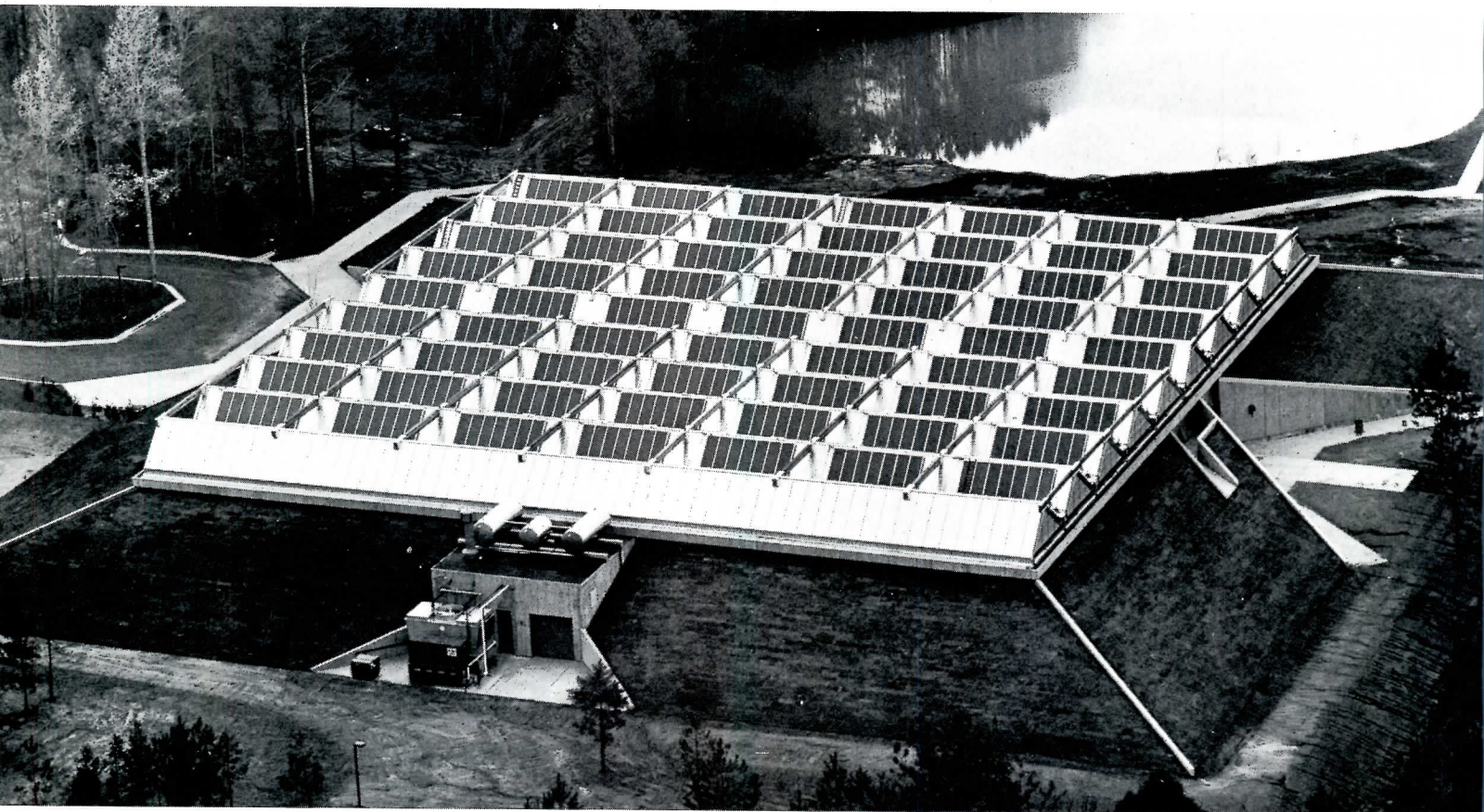

Shenandoah Solar Recreation Center: Shenandoah Development, Inc., owner; Taylor and Collum Architects, Atlanta, Georgia.

## A man upon whom nothing was lost

BERNARD MAYBECK: ARTISAN ARCHITECT, ARTIST, by Kenneth H. Cardwell. Peregrine Smith, \$24.95.

Reviewed by Jeffrey Limerick

San Francisco's Palace of Fine Arts seemed like something out of a dream the first time I caught sight of it: a gigantic classical temple of rust and gold visible between rows of pastel post-World War I Spanish Revival houses in the Marina district. Even after forty years of decay, this "temporary" exhibition structure built for the Panama-Pacific Exhibition of 1916 still retained the grandeur and beauty that had prompted two generations of concerned citizens to save it from destruction. Then in 1962 over six million dollars went into rebuilding a reduced version of it in permanent materials: a tribute, if you will, to the genius of its architect, Bernard Maybeck.

Maybeck was a fascinating man. He was born in New York City in 1862, the son of a German emigrant woodcarver. After a mediocre response to an excellent secondary education, he was apprenticed to the large furniture and interiors firm where his father was a superintendent. The young man's tendency to daydream and to work improvements on the drawings placed before him soon convinced his father that Ben should be a designer. Maybeck made his way to Paris where he decided to enter the *Ecole de Beaux Arts* and become an architect. He subsequently joined the atelier of Jules Andre, where he was urged to apply French rational thought and modern technology to the architectural problems of his native land in an attempt to arrive in turn at an appropriate response to American culture. But he was also taught that traditional architectural values and forms must also figure in the solution to modern problems.

Maybeck never lost respect for the lessons of the *Ecole*. But neither did he forget the value of sincere craftsmanship and the respect for the nature of materials which he had learned as a furniture maker and which had been reinforced by his study of European Medieval vernacular buildings. The two influences were present in his work throughout his long career.

After returning to the United States and to stints in New York and Kansas City, Maybeck decided to try his fortune in San Francisco. Here his individualistic approach to design

found favor. The more than 150 buildings he produced during his long professional career are a truly original contribution to American architecture.

It is regrettable that so little has been written about Maybeck and his work. Esther McCoy's excellent chapter on him in her *Five California Architects*, recently reprinted by Praeger Publishers, stimulated an interest that the few books and articles on aspects of his work that have appeared since then have been unable to satisfy.

For quite some time, Maybeck fans have been aware of a much more complete study of the architect's work being prepared by Professor Kenneth Cardwell of the University of California's Berkeley School of Architecture. Professor Cardwell first met the retired architect as a student in 1940, beginning a friendship that lasted until Maybeck's death in 1957. When the Maybeck drawings and papers were given to the university, Cardwell began the laborious process of cataloguing and documenting them. He then decided to publish a collection of these drawings and photos, but it was soon apparent that a more complete explanation of them was necessary. Now, at last, the book has been published by Peregrine-Smith. It is beautifully designed, exhaustively researched and full of photos and plans, most of which have never been published before. Although the text is too close to reportage for my taste, the subject is fascinating. The book is well worth reading and will no doubt become the classic work on the architect's career.

Although Professor Cardwell has been quite thorough in documenting Maybeck's career, he has left out a great deal of material that would have placed the architect in context and helped explain why the Bay Area of the 1890's was so well suited to him.

The stigma of provincialism that had led early San Franciscans to appear Eastern at all costs was being replaced by a rapidly growing awareness and appreciation of the unique qualities of the region and the more relaxed style of life it would allow. The search for an architectural expression appropriate to the place created a fertile atmosphere. The work of Ernest Coxhead and Willis Polk, who were experimenting with scale, vernacular materials, and elements drawn from sources as diverse as the late shingle style and colonial revival to Medieval and Hispanic imagery, and the growing influence of arts and crafts ideals helped Maybeck focus his energies and imagination (the best source for this interesting background is *Bay Area Houses*, edited by Sally Woodbridge).

Maybeck's response to the situation was

to take advantage of the freedom it offered to be willfully and creatively innocent; to set aside the preconceptions about the proper way to do things that most of us acquire with a measure of architectural sophistication, and to see his possibilities with fresh eyes. He used whatever materials, structural systems, and plan configurations suited his practical and aesthetic purposes, though they were often at odds with accepted practice. He freely combined historical imagery from sources as diverse as Classical Rome and California barns—a dangerous practice that in less capable hands might have created meaninglessly picturesque and confused effects.

Maybeck's ideas on the simple home appropriate to the Bay Region were duly recorded by his friend and first client, Charles Keeler, the self-appointed promoter of the artistic life among the intelligencia of Berkeley. When Keeler helped to reorganize the Hillside Club as a political instrument to foster crafted, site-sensitive architecture in the hills above the University of California campus, Maybeck found an acceptance and a source of sympathetic and intelligent clients such as few architects have enjoyed.

The many houses Maybeck built are difficult to classify. Professor Cardwell points out that those constructed during the first two decades of his practice express a strong interest in structure, the expressive qualities of simple materials, and the craft of building. The small chalet for law professor George Boke of 1902 combines planning innovations like a continuous L-shaped living and dining room (to overcome visually the building's modest size) with a totally modular structure of redwood. The material, every board, every joint, contributes to the overall effect. It is a superb design for a very modest and inexpensive house.

Later in his career Maybeck became much more interested in manipulating forms, colors, and textures to achieve an appropriate image and mood. Cardwell shows that this tendency was a part of his work from the beginning. He was a very solid craftsman but could also summon marvellous visual effects. Wyntoon, the Mount Shasta retreat built for Phoebe Hearst also in 1902, was made of the very stuff of his rugged site. "The color of the woodwork is the color of the bark of the pine trees—a violet brown. Now fill the windows with leaded glass and see the light through the dining room windows, windows which are large enough to light a cathedral. Imagine the clear blue and white foam of the river in the foreground, roaring ceaselessly, and you have a picture of rest and, at the [pearly, misty]

continued on page 47

Jeffrey Limerick is an architect and lecturer in architecture at Yale who is currently writing a book on America's grand resort hotels with Richard Oliver and Nancy Ferguson.

# there is no "or equal" to ColorKlad

Since its introduction, ColorKlad has been the finest roofing-fascia metal available on the market. Compare cost and quality – there simply is no "or equal" to ColorKlad...because ColorKlad's beauty, durability and economy put it in a class by itself.

## ...and now, the best is better!

We've made the best roofing-fascia metal on the market even better – 2 ways! While others endeavor to produce a product **equal** to ColorKlad, we've implemented technological improvements which enable us to announce ColorKlad's superiority in 2 **new** ways – putting ColorKlad (already Number 1 in its field) still further ahead!

### New coating system

We've developed a new coating system which dramatically improves ColorKlad's corrosion resistance and low temperature formability. For further details, call your ColorKlad representative or call the toll free information number below.

### New 20 year written warranty

We've improved our warranty to reflect the technical advances we've made in ColorKlad. In clear, concise warranty information, we assure you in writing that ColorKlad is, without reservation, the finest exterior metal available – and that its quality will endure 20 years from now. We feel this warranty offers more protection than any in the history of coated metals.

Architects... if any other metals supplier claims an "or equal" to ColorKlad, ask for a copy of that product's warranty in writing... then compare it to ColorKlad. You will find there is no "or equal" to ColorKlad!



## Vincent

Brass & Aluminum Co.  
Building Products Division  
724 24th Ave. SE, Mpls., MN 55414

Dial direct without charge

MINNESOTA ONLY  
NATIONWIDE

800-552-1202  
800-328-7772

SEND FOR OUR NEW COLORKLAD BROCHURE  
AND FREE COLOR SAMPLES TODAY!

Name \_\_\_\_\_

Title \_\_\_\_\_

Company \_\_\_\_\_

Address \_\_\_\_\_

City \_\_\_\_\_ State \_\_\_\_\_ Zip \_\_\_\_\_



dawn of the day, an enchanted castle." (Maybeck, 1904).

Admittedly Wyntoon is an extreme example, but it also points out how different Maybeck's conception of space was from most of his arts and crafts contemporaries. Rather than horizontal continuity, his houses are a composed experience of dramatic spatial events accenting the vertical dimension. Maybeck worked in plan and section. One of the disappointments of Professor Cardwell's book is that the illustrations, as good as they are, give no indication of volumetric relationships as, for example, the transparent isometric drawings used by William Turnbull do. Drama to enrich and ennoble everyday life is the very stuff of Maybeck's art.

It is also a shame that Professor Cardwell chose not to include much anecdotal material, for Maybeck was an eccentric and fascinating as his buildings are. The reader is given only glimpses of the man's unassuming Bohemian life, his warmth and humor, and even less of his iron will and flaring temper when faced with incompetence or compromise.

Maybeck's character helps explain his failure to take full advantage of his professional opportunities. For example, Professor Cardwell shows that although he was principally known as a designer of small buildings carefully fitted into the landscape, he also had a strong appreciation for the pageant of urban life and a great talent for largescale design and planning. It was the Roman-scaled Palace of Fine Arts that thrust him into national prominence. And yet most of his other large works went un-built. The close personal involvement demanded by his individualistic approach and his dislike of committees and compromise put him at a temperamental disadvantage. He once remarked that he preferred to sow the seeds of grand idea and let others figure out how to get it done.

I was pleased to see Professor Cardwell dispel the myth of Maybeck's declining practice and poverty as the interests of the architectural profession moved toward the romantic and sentimental period styles of the late 'teens and 'twenties. He changed with the times, experimenting with the new images and materials that interested him and making them his own. His third decade of practice was more successful in dollar value than his early career. I think Cardwell is right in proposing that the pressures of an expanding practice and his growing interest in image and mood brought about a decline in the quality of Maybeck's work, though his later buildings were usually dramatic and delightful and always interesting. A telling comparison can be made between his vaguely Moorish Oakland Packard showroom of 1928 and his First Church of Christian Scientists in Berkeley of 1910. The auto showroom, despite the innovative use of sprayed colored gunnite on its walls, is a make-believe stage set intended for the display of Earl Anthony's modern "magic carpets." It is all surface decoration, though Maybeck was highly successful in integrating his diverse stylistic sources into a coherent total composition that successfully evoked a fanciful

*continued on page 49*

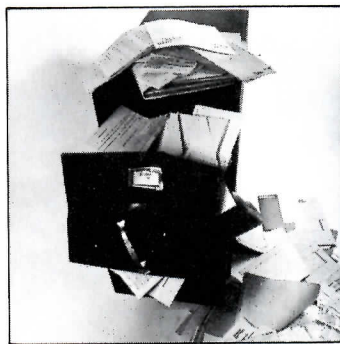

## Your best offense is a loud defense

Business crime in 1976 hit an all-time high of \$44 billion. For security-sensitive companies, that's cause for alarms.

Detex Exit Alarms, we suggest. Choose from surface or flush-mounted styles, battery or AC powered. Installed at doorways, windows, cabinets or cages, they shriek in protest against unauthorized use.

For doors that need to be locked from without, yet opened from inside for

emergencies, a Detex Exit Control Lock is the choice. If its warning legend doesn't scare off violators, the blast of its horns surely will.

These alarm devices can be wired to a Detex Remote Indicating Panel for multi-door monitoring from one location. All are part of a broad line of reliable, low-cost security hardware for entry and exit control, detailed in our omnibus brochure. We're holding your copy.

Detex Corporation • 4147 Ravenswood Ave. • Chicago, IL 60613

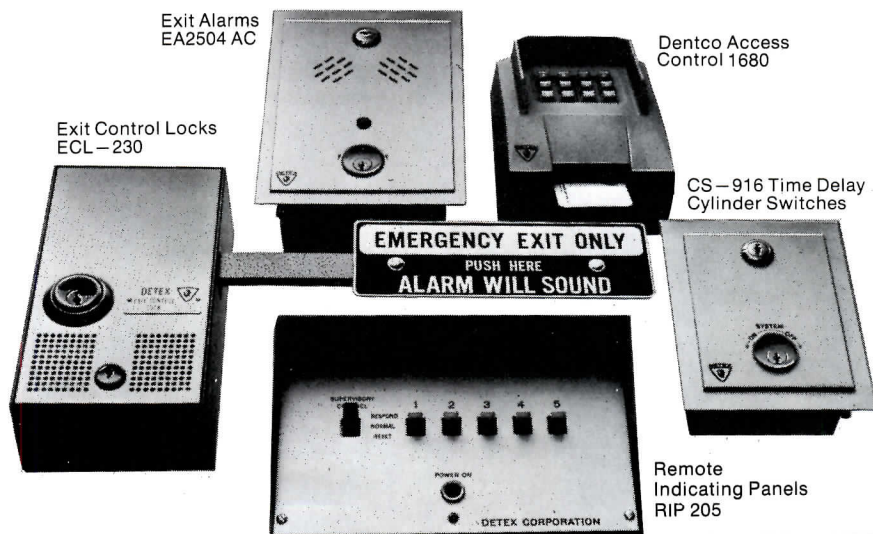

For more data, circle 25 on inquiry card

# Help retrofit those older buildings into space-age energy savers.

Johnson Controls specializes in automated building controls. We help you do the whole job from design to hardware to installation. Results? See below.

### Saves energy for three generations of buildings.

This 66-year-old building is the Harris Bank's third Chicago building to utilize a single JC/80 computer for energy management. The others: a 38-story high-rise built in 1976 and a 23-story building built in 1960.

### U.S. Naval Academy cuts energy costs 27%

By expanding their Johnson Controls JC/80 building automation system to four additional buildings ranging in age from one year to 70 years old, the Naval Academy expects to save \$142,000 yearly, paying for the expansion in less than 2½ years.

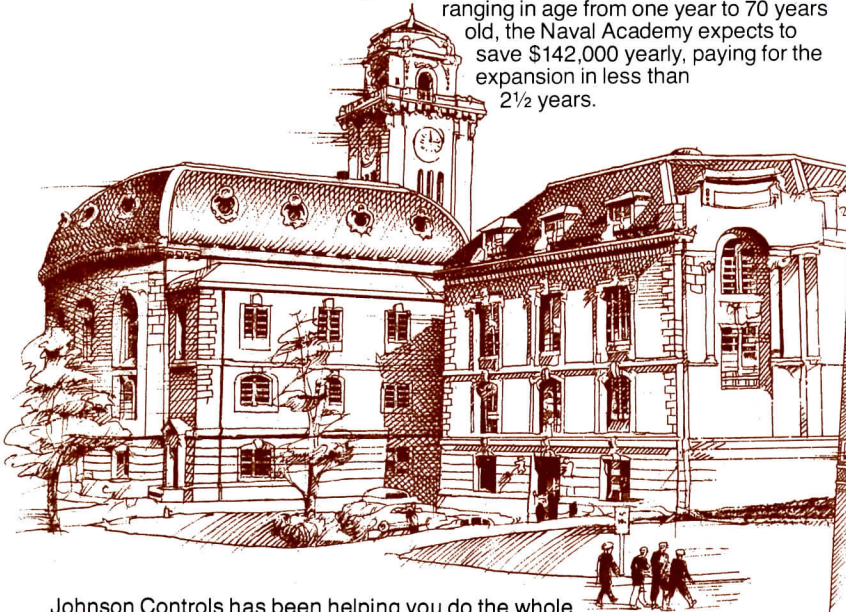

Johnson Controls has been helping you do the whole job for over 90 years. And from basic temperature controls to the computerized JC/80, today more than one third of all large commercial, institutional, and government buildings in the U.S. employ some form of Johnson controls. We would like to work with you on your next project.

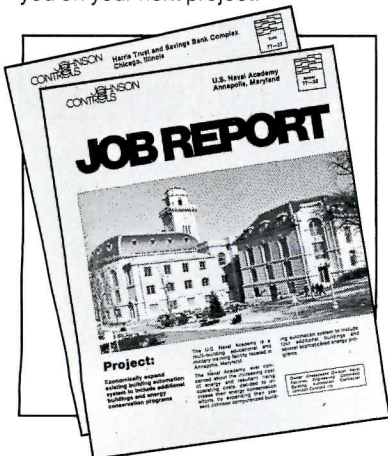

## FREE.

Job Reports on these and similar buildings with full details on how the problem was solved, and names of consultants involved.

Send coupon to: Mr. Ron Caffrey, Vice President, Marketing Johnson Controls, Inc. Box 423, Milwaukee, Wis. 53201

Name \_\_\_\_\_

Title \_\_\_\_\_

Firm Name \_\_\_\_\_

Arch  Eng  A/E  Contr  \_\_\_\_\_

Address \_\_\_\_\_

City \_\_\_\_\_ State \_\_\_\_\_ Zip \_\_\_\_\_

**JOHNSON**  
**CONTROLS** We make buildings earn more.

H-2

# ICE RINK

Buying and Specifying

## GUIDE & CHECK LIST



PUBLISHED BY AMERICA'S LARGEST MANUFACTURER & INSTALLER OF ICE RINKS

## FREE FROM AMERICA'S LARGEST MANUFACTURER & INSTALLER OF ICE RINKS

For your free copy, just write or call. This 28 page guide contains essential information for the architect on the following:

- Latest ice rink developments.
- Kinds of rink refrigeration.
- Indirect Brine versus Direct Liquid Refrigeration.
- Utilizing waste heat.
- Initial cost and operating cost comparisons.
- Ice temperature control.
- Ice hardness requirements.
- Subsoil heating and when needed.
- Dehumidification and when required.

### SERVICES PROVIDED TO ARCHITECTS:

1. Typical ice rink plans, specifications, options.
2. Preliminary cost estimate.
3. Customized plans and specifications for your project.
4. Accurate project cost estimate for budget protection.
5. Total BONDED ice rink responsibility including refrigeration, installation, concrete rink floor, subsoil heating, waste heat recovery, dasher boards, nets, scoreboards, etc., etc., etc.

ARCHITECTS DO BETTER WITH HOLMSTEN

## HOLMSTEN ICE RINKS, INC.



2301 Como Ave., St. Paul, MN 55108  
612-646-8625

REQUIRED READING continued from page 47

romantic mood—a very different thing from the erudite assembly of historical fragments of his day—or of our own.

First Church, surely Maybeck's greatest work, combines an innovative plan with a dramatic exposed structure to give rich patterns and rhythms, accented by decoration and coloristic effects intended to reveal and enrich what is there. Common materials such as transite and factory sash and a diverse set of allusive historical images are freely used to make art out of the very stuff and construction of the building—a much more integrated and moving experience than the manipulation of applied forms and imagery.

Maybeck continued to practice into the 1930's when the Depression reduced his commissions to the point where his wife managed to talk him into retiring. Even then he remained active, developing his Berkeley property and working on grand schemes for San Francisco and Berkeley.

By then, a new generation of Bay Area architects was beginning to pay attention to his work, praising his innovative informal planning and logical, economical construction—qualities important in their own work. Jean Murray Bangs recalled recently that she had to be very careful in selecting photos for her articles on Maybeck in the late 40's (which were largely responsible for getting Maybeck his AIA gold medal), lest the more dogmatic and evangelical of the Modernists in the profession should be offended by his decorative craftsmanship and use of historical imagery. Since then, each generation has found new interest in Maybeck's work, be it his "witty juxtaposition of surprisingly scaled historical elements," his use of "vernacular forms and low art commercial materials," or the beauty, drama, and emotional power of his spaces. I find myself, frankly, in awe of such a rich life and work. But eventually we have to ask ourselves the value of Professor Cardwell's book and Maybeck's example. In addressing himself to that question, Cardwell stresses that Maybeck was not a revolutionary out to create a new order. He saw the architect's prime function to be surrounding the individual with beauty. He applied "contemporary technology and materials," "direct structured expression," "innovative planning," and his "masterly handling of the elements of architecture" to those ends. "His ability to resolve conflicts between the demands of individuality and continuity, between craft production and mechanization, makes his work valuable for its insights on problems comparable to contemporary ones." We must all realize that for a variety of reasons, buildings like Maybeck's simply can't be built today (if for no other reason than that we simply don't see the world the same way). But we can be inspired by his artist's creative process: his careful search and willingness to use whatever idea, image or material that furthered his intentions. It is here that Maybeck can provide an example for us to emulate. He was, to borrow a phrase from Henry James, a man upon whom nothing was lost.

◆ For more data, circle 27 on inquiry card

For more data, circle 28 on inquiry card ◆

# NEW 300 SERIES GRAB BARS

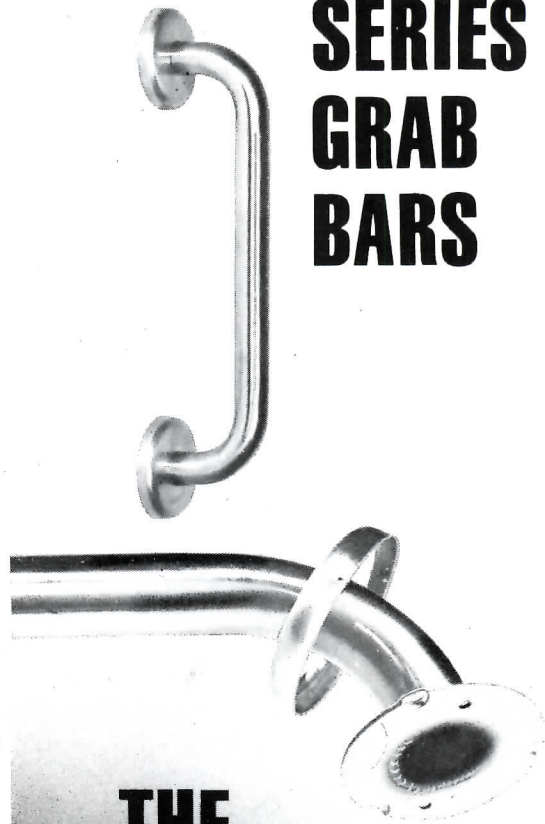

## THE INSTALLATION IS A "SNAP"

The Parker 300 Series grab bars feature an easy method of concealed installation. Escutcheon flanges, finished to match the grab bars, are snapped over the previously secured wall flanges, providing permanent, vandal-proof mounting. These stainless steel bars are available in either a 1 1/2" or 1 1/4" diameter, with either a smooth satin finish or a non-slip gripping area. They are produced in straight lengths, as well as a variety of special application configurations. The easy mounting and neat appearance of Parker's 300 Series grab bars make them perfect for installation wherever the safety of grab bars is required.

See our catalog in Sweets



290 PRATT STREET  
MERIDEN, CONNECTICUT 06450  
TELEPHONE (203) 235-6365

# design flexibility . . . the key to Power-Strut's Modular Grid Ceiling Support System

Easily moved internal panels allow for seasonal expansion or contraction

Adjustable track lighting fixtures, hidden by baffles, spotlight merchandise

Hanging baffles hide open ceiling, electrical and mechanical equipment

A crisscross grid of Power-Strut continuous slot channel is hung from unfinished ceiling or building's steel structure

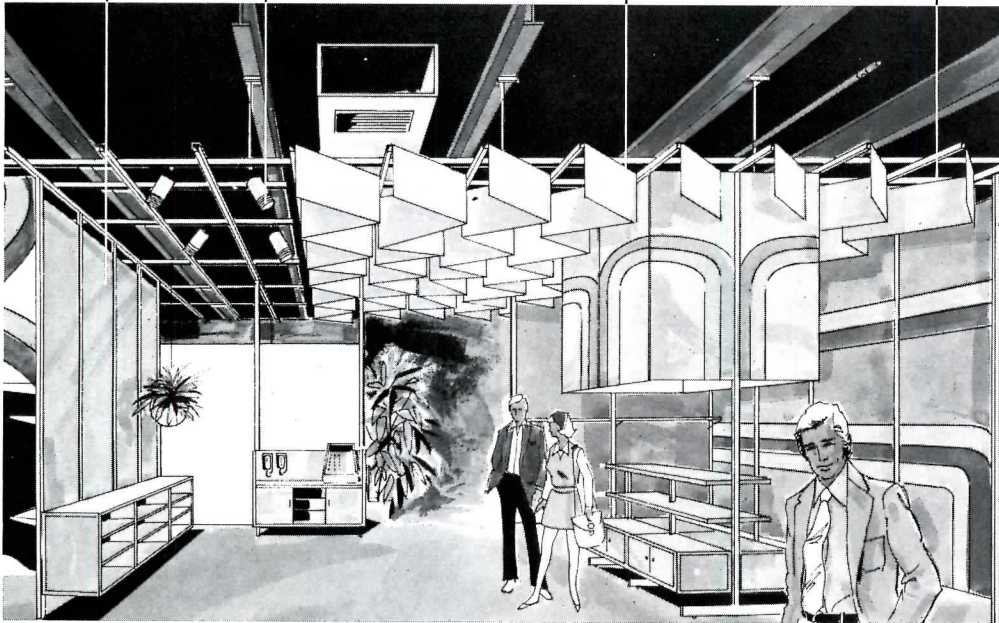

The Power-Strut Modular Grid Ceiling Support System is simple in design and easily installed. And is an ideal way to engineer ceilings for new construction or remodeling projects.

Power-Strut Modular Grid Ceiling Support System installations include shopping malls, department stores, offices, restaurants, museums and terminals.

For more information on Power-Strut Modular Grid Ceiling Support System write for our brochure.



**POWER-STRUT**

**VAN HUFFEL TUBE CORP.**  
WARREN, OHIO 44481

For more data, circle 29 on inquiry card

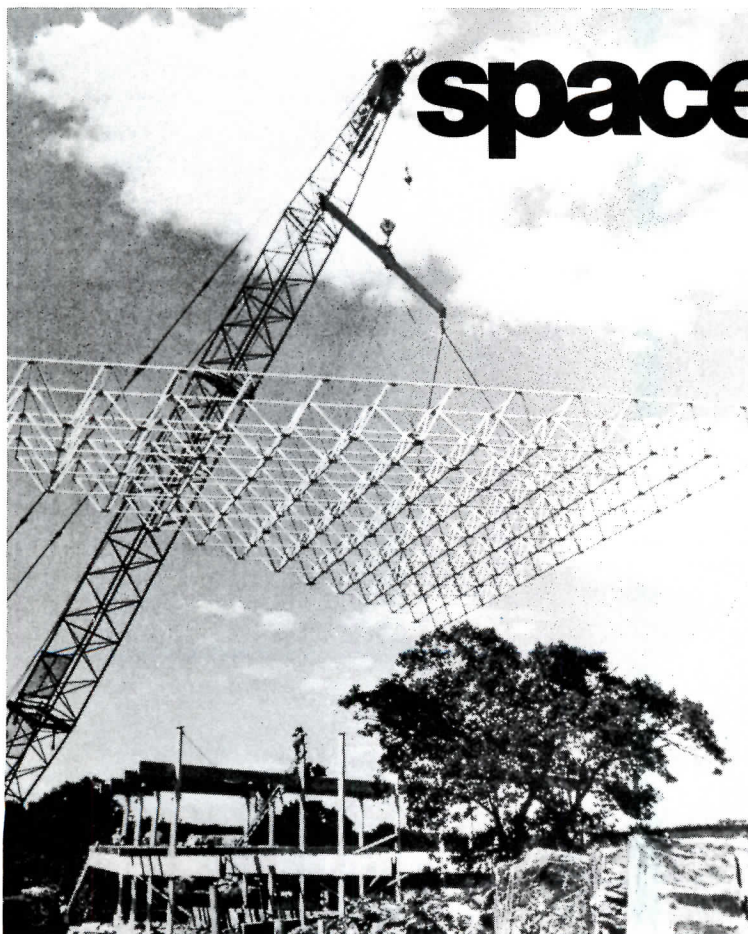

## space frame...

The lightweight, modular roof support system

The new Power-Strut Space Frame System is designed to provide flexibility and simplicity for your architectural and construction objectives.

Space Frame modular roof construction system gives you these advantages . . .

- Lightweight and strong
- Fast and easy assembly on the ground or in place at the job site
- Five basic component parts, all standard products stocked by Power-Strut
- Component parts available for four-foot or five-foot modules

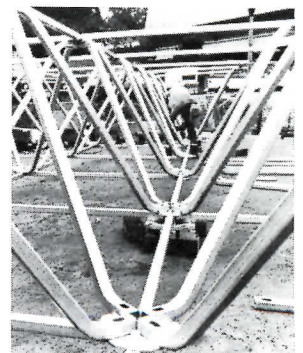

This 3,000-square-foot roof structure was shipped on five pallets, field assembled in two days and hoisted into position by a single crane. For more details write . . .

**POWER-STRUT**

**VAN HUFFEL TUBE CORP. • WARREN, OH 44481**  
a division of Youngstown Sheet and Tube Company  
\*patent pending

For more data, circle 30 on inquiry card

## Dodge/Sweet's construction outlook, 1978: first update

Last year the construction industry really put it all together. A plentiful supply of mortgage money stretched the housing boom all the way through 1977. Federal spending to reduce unemployment gave a strong boost to public works construction. General economic expansion finally brought forth a belated burst of commercial and industrial building. The result: a 26 per cent surge in total construction contract value—the biggest yearly gain in nearly three decades of cyclical ups and downs. Our 1978 forecast (RECORD, November, 1977, page 55) calls for still further improvement in construction markets, but hardly a replay of last year's extraordinary advance. That's mostly because in 1978 we'll be losing the thrust of construction's biggest single sector—housing. Some other key information forms the basis of this revised outlook for 1978.

By now we have the advantage of knowing a few facts that we could only guess about back in November. Some of them turned out to be disappointments.

- Recent surveys of business capital spending plans for 1978 indicate a disturbing lack of confidence in the economy's future performance. McGraw-Hill's year-end tabulation showed an intended 11 per cent increase in spending for new plants and equipment for this year. Minus an expected 8 per cent of this for higher costs, this leaves only 3 per cent growth in physical terms during 1978.

- The President's tax cut proposal—\$25 billion as of October—will offer little help in 1978. Only one-quarter effective this year, it amounts to little more than a trade-off against the \$6 billion hike in Social Security taxes.

- The President's energy program remains stalled in Congress.

Some other "happenings" in the waning months of 1977 were mixed blessings.

- G. William Miller, Arthur Burns' successor to the chairmanship of the Federal Reserve Board, took the position that growth and full employment (not restraint) are needed to relieve inflationary budget deficits and reduce unit costs.

- Meanwhile, however, the Fed's effort to strengthen the dollar internationally has pushed up short-term interest rates at home where disintermediation may already be under way.

- Finally, there's the current torrid pace of construction contracting itself. Last year closed out on a strong upbeat as the fourth quarter topped year-earlier building value by 32 per cent! That's a nice jumping-off place for 1978, but it's a rate that can hardly be sustained.

Going into 1978 the construction market seems perhaps even a bit more vulnerable than it did only a few months ago, but it's much too soon for any major revision of the November estimates. The basic thesis—that the housing cycle is at its peak and that nonresidential building is the key to 1978 expansion—still holds.

### Nonresidential building: a gain of 13 per cent in contract value

In the final months of 1977, the pace of contracting quickened on both the private and the public sides of the lagging nonresidential building market.

Commercial and industrial building which had been recovering at a steady 5 per cent per quarter rate, jumped 11 per cent (seasonally-adjusted) in the fourth quarter to an annual rate of 850 million square feet.

### National Construction Contract Value

(millions of dollars)

		1977 Actual	1978 Forecast	Per Cent Change
<b>Nonresidential Buildings</b>	Office Buildings	\$ 5,247	\$ 5,950	+13
	Stores & Other Commercial	8,344	9,550	+14
	Manufacturing Buildings	5,150	6,100	+18
	<b>Total Commercial &amp; Manufacturing</b>	\$ 18,741	\$ 21,600	+15
	Educational	\$ 5,217	\$ 5,650	+ 8
	Hospital & Health	4,485	4,900	+ 9
	Other Nonresidential Buildings	6,856	7,650	+12
	<b>Total Institutional &amp; Other</b>	\$ 16,558	\$ 18,200	+10
	<b>Total Nonresidential</b>	\$ 35,299	\$ 39,800	+13
<b>Residential Buildings</b>	1- & 2-Family Homes	\$ 50,867	\$ 49,300	- 3
	Apartments	9,293	11,700	+26
	<b>Total Housekeeping</b>	\$ 60,160	\$ 61,000	+ 1
	<b>Total Nonhousekeeping</b>	\$ 1,273	\$ 1,500	+18
	<b>Total Residential</b>	\$ 61,433	\$ 62,500	+ 2
<b>Nonbuilding Construction</b>	Highways & Bridges	\$ 10,209	\$ 10,800	+ 6
	Utilities	20,275	20,000	- 1
	Sewer & Water	7,124	8,300	+17
	Other Nonbuilding Construction	4,873	4,600	- 6
	<b>Total Nonbuilding</b>	\$ 42,481	\$ 43,700	+ 3
<b>Total Construction</b>		\$139,213	\$146,000	+ 5
<b>Dodge Index (1967 = 100)</b>		252	264	

### Floor Area of New Buildings

(millions of square feet)

		1977 Actual	1978 Forecast	Per Cent Change
<b>Nonresidential Buildings</b>	Office Buildings	138	150	+ 9
	Stores & Other Commercial	429	465	+ 8
	Manufacturing Buildings	171	195	+14
	<b>Total Commercial &amp; Manufacturing</b>	738	810	+10
	Educational	112	114	+ 2
	Hospital & Health	67	68	+ 1
	Other Nonresidential Buildings	184	193	+ 5
	<b>Total Institutional &amp; Other</b>	363	375	+ 3
	<b>Total Nonresidential</b>	1,101	1,185	+ 8
<b>Residential Buildings</b>	1- & 2-Family Homes	1,966	1,790	- 9
	Apartments	416	490	+18
	<b>Total Housekeeping</b>	2,382	2,280	- 4
	<b>Total Nonhousekeeping</b>	36	40	+11
	<b>Total Residential</b>	2,418	2,320	- 4
<b>Total Buildings</b>		3,519	3,505	-



When you create a design  
in which no two tiles will  
ever be identical, you've  
started a Renaissance.

Renaissance™ is here. The brand-new glazed ceramic tile that creates walls of such drama — other materials seem dull and repetitive by comparison. In Renaissance, every tile is unique in color and pattern. So the overall design is as original as a work of art. And just as enduring.

Renaissance outlives synthetic materials in every way because it's real ceramic tile. So the color and pattern won't fade. And with normal wear, the tiles won't scratch or stain.

Renaissance comes in a variety of colors and sizes (shown: 4¼" sqs. 703 Rn. Copper). And Redi-Set® pregrouted systems. Or for use with a colored grout. To find out more, visit any American Olean Color Center or Showroom or write to us at: 2417 Cannon Avenue, Lansdale, Pa. 19446 for free information and actual color chips of Renaissance. It's the natural thing to use.™

CERAMIC TILE  
**American  
Olean**  
A Division of National Gypsum Company

For more data, circle 49 on inquiry card

The extraordinary surge of contracting for retailing facilities in the late months of 1977 is due for a comedown, especially with the prospect of a diminishing rate of homebuilding in the months ahead. Office buildings, on the other hand, are showing more sustainable growth than expected, while industrial construction—after a few soft months—is now back in step with capacity utilization.

The updated 1978 outlook for commercial and industrial building: an increase of 10 per cent to 810 million square feet.

*Institutional building*, which was running 10 per cent behind 1976's square footage through most of the year came to life in the waning months of 1977. Round II of the Public Works Employment Act added an extra billion dollars to the fourth quarter's contracting for schools, hospitals, and public administration buildings. With roughly another billion still to be contracted, the Act will support a relatively high volume of activity during the early part of 1978 (above 400 million square feet). After that, contracting for institutional building will

settle back to its previous 350-360 million square feet range.

The updated 1978 outlook for institutional and other nonresidential building: only a small gain to 375 million square feet, since Round II's impact is divided about equally between 1977 and 1978. Total nonresidential building, which exceeded 1977 expectations, now looks headed for a 1978 gain of 8 per cent in square footage, and 13 per cent in contract value.

#### Residential building: holding steady now but starts will decline by year end

October's basic premise underlying the 1978 housing forecast remains unchanged: the combination of demand saturation and tightening credit will reverse the three-year expansion of residential building.

One indication of excess in the booming homebuilding market: sales failed to keep up with starts in 1977. Between the first and final quarters of last year production of one-family homes increased by 10 per cent. However, the rate of sales was no higher at year-end than it

was in the early months.

By contrast, rental vacancy rates *declined* in 1977 to a seven-year low of 5.3 per cent despite the year's 40 per cent increase in multi-family starts. No sign of saturation here (yet).

Recent months brought a sharp reduction in the flow of savings to the nation's thrift institutions. With most money market rates now above the rate paid on savings it is expected that the 1978 net savings inflow will be at least \$10 billion short of 1977's record amount. The impact of a savings slowdown won't be felt in housing markets until later in the year, however, since the current high level of commitments for future lending should ensure against mortgage scarcity through most of the first half of 1978.

The updated 1978 outlook for residential building: fewer one-family units, and more apartments will bring small year-to-year changes in total residential building: dwelling units down 3 per cent; square feet down 4 per cent; contract value up 2 per cent. By 1978's fourth quarter, however, the rate of housing starts is likely to be 20 per cent below the 1977 fourth quarter rate.

#### Nonbuilding construction: 3 per cent increase or about \$20 billion

As the Public Works Employment Act advanced to Round II, contracting for roads, sewers, and water supply experienced a second surge. Round I, the first \$2 billion installment (which was disbursed at the end of 1976) made its impact on public works contracting during the first half of 1977. Then, after a brief intermission in the third quarter, Round II's larger disbursement escalated each of these categories to new highs.

With more than half of the \$6 billion total now contracted out, the 1978 pattern is expected to show a continued high rate of contracting for public works projects in the first half of the year, followed by a return to a more normal level in the second half.

The "post-energy crisis" boom in electrical utility construction extended into 1977 with a record \$20 billion of new generating capacity started during the first nine months. Since last September, however, not a single additional project of any significance—fossil fuel or nuclear—has been reported. It may be no more than coincidence, but the break came at just about the time that President Carter's energy program lost its momentum.

Perhaps a clear statement of national energy policy—including resolution of key issues such as growth vs. conservation, and nuclear vs. coal—is needed to show whether the recent break in the sharply rising trend of utility construction is just another temporary interruption or the start of a new trend. Meanwhile, we'll hold 1978's forecast to a repeat of 1977's \$20 billion.

The updated 1978 Outlook for nonbuilding construction: a scaled-down increase of 3 per cent, which could turn out significantly larger or smaller depending on a few power plants.

George A. Christie

Vice president and chief economist  
McGraw-Hill Information Systems Company

Regional Construction Contract Value (millions of dollars)	Northeast Conn., D.C., Del., Mass., Md., Maine, N.H., N.J., N.Y., Eastern Pa., R.I., Va., Vt.			Midwest Northern Ill., Ind., Iowa, Ky., Mich., Minn., N.D., Ohio, Western Pa., S.D., Wis., W. Va.		
	1977 Actual	1978 Forecast	Per Cent Change	1977 Actual	1978 Forecast	Per Cent Change
<b>Nonresidential Buildings</b>						
Commercial & Manufacturing	\$ 2,833	\$ 3,275	+16	\$ 4,759	\$ 5,575	+17
Institutional & Other	3,468	3,925	+13	4,419	4,725	+ 7
<b>Total</b>	<b>\$ 6,301</b>	<b>\$ 7,200</b>	<b>+14</b>	<b>\$ 9,178</b>	<b>\$10,300</b>	<b>+12</b>
<b>Residential Buildings</b>						
1- & 2-Family Homes	\$ 6,620	\$ 6,650	—	\$11,948	\$11,575	— 3
Apartments	1,565	2,100	+34	2,328	2,800	+20
Nonhousekeeping Residential	216	250	+16	276	325	+18
<b>Total</b>	<b>\$ 8,401</b>	<b>\$ 9,000</b>	<b>+ 7</b>	<b>\$14,552</b>	<b>\$14,700</b>	<b>+ 1</b>
<b>Nonbuilding Construction</b>						
Highways & Bridges	\$ 2,075	\$ 2,250	+ 8	\$ 2,577	\$ 2,800	+ 9
Utilities	3,362	3,000	—11	3,799	5,000	+32
Other Nonbuilding Construction	3,211	3,350	+ 4	2,720	2,850	+ 5
<b>Total</b>	<b>\$ 8,648</b>	<b>\$ 8,600</b>	<b>— 1</b>	<b>\$ 9,096</b>	<b>\$10,650</b>	<b>+17</b>
<b>Total Construction</b>	<b>\$23,350</b>	<b>\$24,800</b>	<b>+ 6</b>	<b>\$32,826</b>	<b>\$35,650</b>	<b>+ 9</b>

Construction Contract Value (millions of dollars)	South Ala., Ark., Fla., Ga., Southern Ill., Kan., La., Miss., Mo., N.C., Neb., Okla., S.C., Tenn., Tex.			West Alaska, Ariz., Cal., Colo., Hawaii, Idaho, Mont., Nev., N.M., Ore., Utah, Wash., Wy.		
	1977 Actual	1978 Forecast	Per Cent Change	1977 Actual	1978 Forecast	Per Cent Change
<b>Nonresidential Buildings</b>						
Commercial & Manufacturing	\$ 6,758	\$ 8,000	+18	\$ 4,391	\$ 4,750	+ 8
Institutional & Other	5,358	5,900	+10	3,313	3,650	+10
<b>Total</b>	<b>\$12,116</b>	<b>\$13,900</b>	<b>+15</b>	<b>\$ 7,704</b>	<b>\$ 8,400</b>	<b>+ 9</b>
<b>Residential Buildings</b>						
1- & 2-Family Homes	\$18,483	\$18,250	— 1	\$13,816	\$12,825	— 7
Apartments	2,537	3,525	+39	2,863	3,275	+14
Nonhousekeeping Residential	312	425	+36	469	500	+ 7
<b>Total</b>	<b>\$21,332</b>	<b>\$22,200</b>	<b>+ 4</b>	<b>\$17,148</b>	<b>\$16,600</b>	<b>— 3</b>
<b>Nonbuilding Construction</b>						
Highways & Bridges	\$ 3,788	\$ 3,900	+ 3	\$ 1,769	\$ 1,850	+ 5
Utilities	10,944	9,000	—18	2,170	3,000	+38
Other Nonbuilding Construction	3,748	3,850	+ 3	2,318	2,850	+23
<b>Total</b>	<b>\$18,480</b>	<b>\$16,750</b>	<b>— 9</b>	<b>\$ 6,257</b>	<b>\$ 7,700</b>	<b>+23</b>
<b>Total Construction</b>	<b>\$51,928</b>	<b>\$52,850</b>	<b>+ 2</b>	<b>\$31,109</b>	<b>\$32,700</b>	<b>+ 5</b>

# Closer selection made easy.

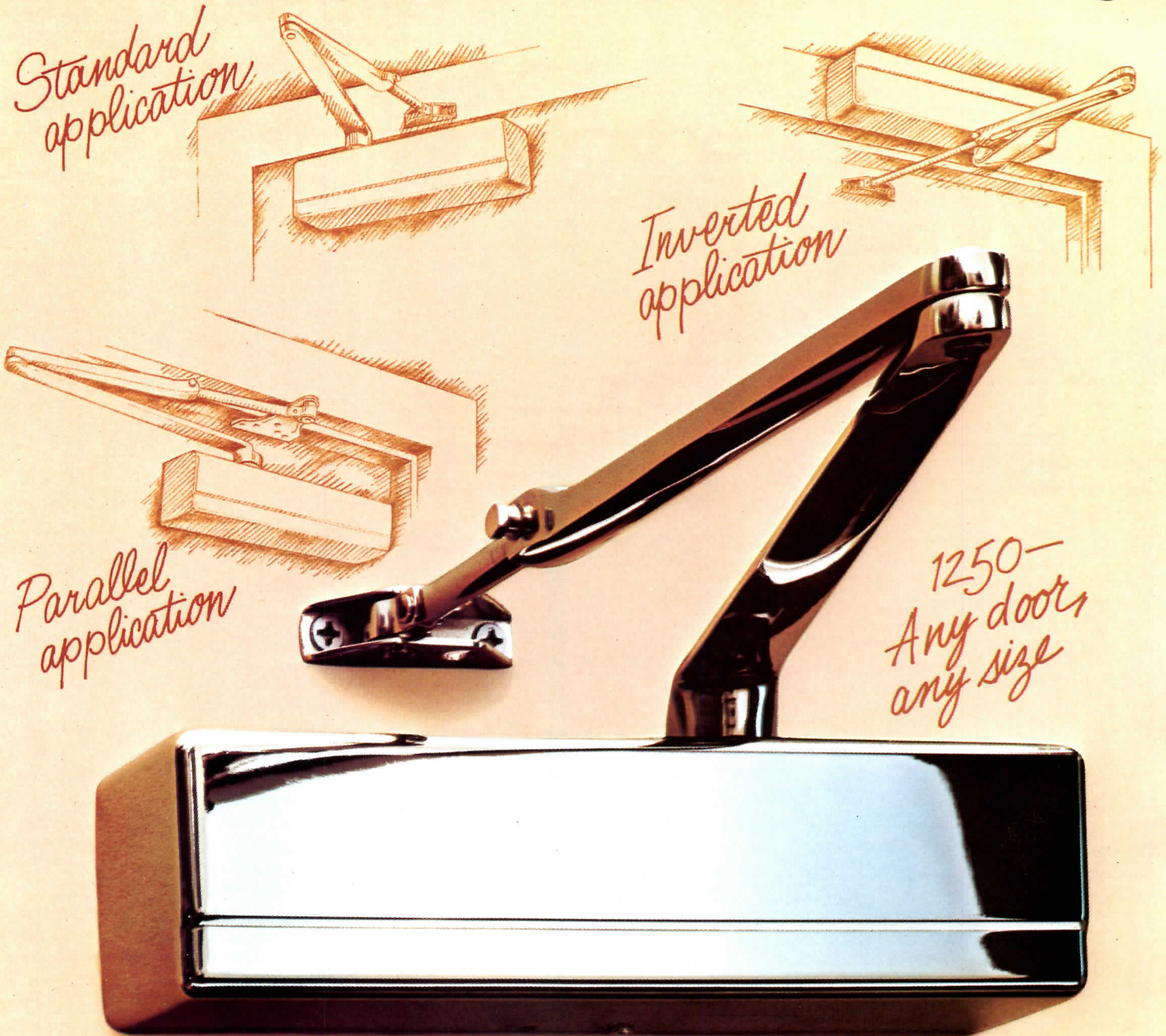

Sargent's 1250 closer is the only one you'll need. Because of its total flexibility, it's like getting 30 different closers in one. With all the quality you'd expect from Sargent. And still sensibly priced to meet most budget considerations.

#### **The ambidextrous closer.**

Designed for easy installation regardless of the hand of the door, the 1250 closer is also non-sized for added flexibility. It's convertible from a size 2 closer to any size up to 6, right on the job, with just a few turns of its spring adjustment screw.

**Offers installation versatility, too.** Whatever your mounting requirements, the 1250 closer can be installed in the standard, inverted or parallel arm mounting position. And is available with holder-stop arm, as well.

**The Sargent quality is built-in.** Engineered with the same precision and detail that distinguishes Sargent top quality lines, these new closers give a whole new meaning to long-life dependability. Particularly as it applies to on-the-job flexibility.

#### **Prompt delivery is assured.**

Inventoried in the Sargent Mercury Shipping Service, these closers can be shipped within 48 hours of receipt of order.

**Sargent 1250... the one to specify.** For additional information, contact your Sargent architectural hardware distributor or write Sargent & Co., New Haven, Ct. 06509.

## **SARGENT**

Division of Walter Kidde & Company, Inc.

### **KIDDE**



## Professional liability: negligence isn't the only problem

Professional liability claims against architects normally involve allegations of negligence (i.e. alleged failure by the architect to meet the standard of ordinary care expected under the circumstances). However, claims also can be based on other legal principles having little to do with the law of negligence. A plaintiff's attorney often will organize his client's claims to utilize as many legal theories as possible in order to maximize chances of recovery. The use of different legal theories (or causes of action, in lawyers' parlance) depends on the facts of the case but can determine which statutes of limitations apply, the degree and type of proof required, and the measure of damages allowed if the allegations are proven. If architects are aware of the various ways lawsuits can be structured, proper contract language and professional practice techniques can be utilized to avoid the application of certain (non-negligence) legal theories. This month's Legal Perspectives column will take a look at some recent cases involving design professionals and allegations of implied warranties, anti-trust violations, libel and slander and interference with contract.

by Arthur T. Kornblut, Esq.

An architect who uses carefully prepared professional service contracts and who closely monitors correspondence and other communications from the firm would never expressly guarantee or warrant the outcome of the services for the client or project. In the absence of an expressed warranty, the law will not imply that an architect should have performed services to perfection, or that the building he designed should have been suitable for its intended purposes, or that the client should be satisfied with the outcome.

### Implied warranties

Unfortunately, of all the legal theories upon which plaintiffs base claims against architects, none is more over-used and abused than the principle of implied warranty. It is a rare case today that does not contain allegations that an architect was both negligent and breached an implied warranty when things go wrong with a project. In his defense, the architect's attorney then must be prepared to show that the architect did meet the standard of care when rendering services, and he also must convince the court that the law does not imply any warranties about those services.

A very recent New York case illustrates how a case can proceed on these different legal theories and how courts apply the theories to the facts. In this case (*Milau Assoc., Inc. v. North Ave. Dev. Corp.*, 42 NY2d 482 10/11/77), a contractor and subcontractor were sued because a faulty sprinkler system

damaged goods stored in a warehouse. At the trial, the jury found the contractors had not been negligent in providing the services to install the system. The trial judge refused to instruct the jury that liability could be imposed for breach of an implied warranty that the system would be fit for its intended purpose. The plaintiffs then appealed, claiming it was error for the court not to give this instruction on their behalf.

On appeal, using language very favorable to architects and other professionals, the highest court in New York affirmed the correctness of the judge's decision.

The court noted, "... those who hire experts for the predominant purpose of rendering services, relying on their special skills, cannot expect infallibility. Reasonable expectations, not perfect results in the face of any and all contingencies, will be ensured under a traditional negligence standard of conduct. In other words, unless the parties have contractually bound themselves to a higher standard of performance, reasonable care and competence owed generally by practitioners in the particular trade or profession defines the limits of an injured party's justifiable demands."

### Private anti-trust cases

When an architect prepares restrictive or proprietary specifications, there is always a possibility that a manufacturer whose products cannot meet the specifications will bring a private anti-trust lawsuit alleging collusion or conspiracy to restrain trade among the architect, owner, contractor and specified product manufacturer. With these cases, as with implied warranty cases, the absence of negligence will not be a defense. An architect's best defense to private anti-trust allegations lies in rendering proper professional services and exercising independent professional judgement. The

courts seem to be uniform in saying that closed or restrictive specifications are not illegal, even if they appear to create a monopoly or restrain trade, if they were the result of the architect's honest belief that the items so specified will be in the best interests of the client and the project.

For the architect who, after exercising independent professional judgement, utilizes closed specifications, the danger lies not so much in being held liable for damages on private anti-trust grounds as in having to incur the expense of defending against the lawsuit in the first place. Professional liability insurance policies normally would not cover claims of this nature because they do not arise out of allegations of professional negligence. On the other hand, it is quite possible that the absence of such coverage is one reason why there have been relatively few of these lawsuits over the years.

### Libel, slander and interference with contract

A third claim type not involving negligence occasionally brought against architects involves allegations of libel and slander or interference with contract. These suits are most likely to occur when an architect has said something negative either orally or in writing about a contractor's performance. Recognizing that clients hire architects, in part, to protect their interests during construction and that not all contractors perform satisfactorily, the law has established rules to permit an architect to make statements under certain circumstances without incurring liability, even though such statements otherwise would result in liability.

In a recent Connecticut case *Kecko v. Town of Monroe*, 374 A.2d 179 1/4/77), an architect was found not liable for recommending to his client that a proposed subcontractor be rejected and replaced. When the client accepted this advice, the subcontractor brought suit for wrongful interference with contract. The trial court found for the defendants, and the state supreme court affirmed by saying that the parties had not acted wrongfully. The court stated: "Pursuant to its contract with the town, the architect was under an obligation to advise the town as to the suitability of contractors and subcontractors and accordingly enjoyed a qualified privilege . . . One is privileged purposely to cause another not to perform a contract, or enter into or continue a business relation, with a third person by giving honest advice to the other within the scope of a request made by him."

Mr. Kornblut is a registered architect and practicing attorney in Washington, D.C.

"Legal Perspectives" is published with the understanding that the publisher is not rendering legal service. If legal advice is required, the services of a competent professional should be sought.

# GLIDDEN VINYL WALLCOVERINGS.

**Because paint isn't always the answer.**

When your job needs vinyl wallcoverings instead of paint, Glidden is the paint company that has the vinyls.

Hundreds of patterns, including deep textures, all in commercial grades with your choice of three weights, and all in your choice of two widths.

So you can match widths and weights to your job—you won't pay for heavyweights when lightweights will do, or for 54-inch widths when 27-inch widths will save.

Money-saving options, like these, are part of the Glidden commitment to be your one-source, full-service supplier

for everything professional painters and decorators need.

That includes complete technical service backup for all our coatings and free color styling assistance from our Color Studio professionals.

Tell us about the job you want to do. We'll tell you how our products and services will help you get it done.

In paint, or vinyl, or both.



**SCM** GLIDDEN COATINGS & RESINS  
ARCHITECTURAL & MAINTENANCE  
SCM CORPORATION, CLEVELAND, OHIO 44115

For more data, circle 51 on inquiry card

For your nearest  
Glidden Representative  
call SWEETS BUYLINE.



# Photo-documentation on restoration work: a new technique that lowers costs, saves time and maintains control

The last five years have seen great advances in the application of photographic techniques to the production of contract documents. These techniques have evolved largely in response to the growing interest in projects involving historic preservation, restoration, and building re-use, where photography meets the requirement of extreme accuracy called for in the duplication of difficult-to-delineate existing conditions. Following is how one architectural firm uses the technique.

by Roy Lowey-Ball and Gilson Riecken

The obvious advantages of photo-documentation are speed and accuracy. Short-circuiting the necessity of drawing existing conditions saves enormous quantities of time, and the accuracy of well-chosen photographs means less confusion both in the office and on the job. The ambiguity inherent in much architectural drafting is replaced by photographs of the real thing, readily understood by everyone. It is this

directness and clarity that ultimately expedites client understanding of the project and the contractor's ability and willingness to bid. Architectural offices struggling to hold down overhead are pleasantly surprised to find that major economies in terms of drawing time result from the use of photo-documentation techniques.

Briefly, the process works like this. Typical photo-documentation sheets require the use of

photo-sensitive *mylar*. Photographs of the existing structure are selected for use on the sheets and the drawings that accompany these images are photographed as well. The entire ensemble of photographs and drawings is then assembled in proper sequence to form the "sheet." Negatives are produced at the desired size and are laid out in their proper order and contact printed onto the *mylar* film. The result is a full-size transparency of photo-positive images which can be run through any diazo printing machine. Experience with this process indicates that production time may be cut by 50 to 90 per cent per sheet.

The weakness of such a process is that it requires a high degree of clairvoyance on the part of the architect coordinating the contract

The process requires the use of electrostatic reproductions on translucent matte-finish adhesive film.

The drawings include:

- 1 NORTH (Strand) ELEVATION
- 2 UPPER WINDOWS - NORTH ELEV
- 3 DETAIL - FIRST LEVEL CORNICE
- 4 DETAIL - CAST-IRON ARCH
- 5 DETAIL - CAST-IRON ARCH
- 6 PARTIAL EAST ELEVATION
- 7 DETAIL - WINDOW CTYPE
- 8 DETAIL - COLUMN BASE
- 9 DOOR @ N.E. CORNER
- 10 DOOR - NORTH ELEV
- 11 DETAIL - METL CLAD DOOR
- 12 S.W. CORNER ELEV

NOTES:

- PLASTER WORK: All plaster to be removed as specified. Entire facade of building, including the back faces of parapets shall be re-plastered. See Specifications.
- LOOSE BRICK: All broken or loose brick areas shall be repaired and covered. All brick arches behind cast-iron lintels of the 1st level shall be repaired as required. All facade brick shall receive new plaster finish.
- CAST-IRON RESTORATION: see Specifications.
- WINDOWS: 1st level windows to be repaired as spec. 1st level windows shall receive continuous waterproofing gasket at the window head and at each joint. Gasket to receive exterior sealant. See Specifications.

PHOTOGRAPHS: All views and details shown on this sheet, including all Special Conditions or All Typical Conditions. Typical conditions are intended to serve as a guide to other, similar conditions which shall be created in a like and a like manner.

DATE	REVISIONS	APPROVED
10/15/78	1. WINDOW CTYPE	APPROVED
10/15/78	2. WINDOW CTYPE	APPROVED
10/15/78	3. WINDOW CTYPE	APPROVED

Greenlee & Spicella, Inc.  
1000 W. 10th Street  
Austin, Texas 78705

7621

BLUM BUILDING  
Galveston, Texas

SHEET NO. 3 OF 3

## The new 700 Series from ALL-STEEL

Attractive, comfortable, quality construction and easy on the budget. Handsomely accented in oval tubular chrome, the 700 Series is a complete line of seating, with models available for virtually any office requirement.

For more information, write:  
All-Steel Inc., Box 871,  
Aurora, Illinois. 60507.



All-Steel Showrooms in New York, Los Angeles, Chicago, Aurora. In Canada, All-Steel Canada, Ltd. One of the **CIT** Companies.

*For more data, circle 52 on inquiry card*

documents; prior to composing the final *mylar* sheet he must anticipate all conceivable conditions likely to form a part of the job. Those familiar with the internal dynamics of most architectural offices and projects are aware that last-minute changes can wreak havoc with the lead-time required for this process. In addition, the architect is saddled with having to work at close quarters with an outside party, the printing company, over whose internal scheduling he exercises but little effective control.

Our firm has had a long and continuing involvement in historic preservation projects throughout the state of Texas, and we had experimented briefly with photo-documentation several years ago when working on the restoration of an 18th century Spanish mission structure. This experience demonstrated the validity of photo-documentation as a means of communicating information, but at the same time underscored the complexity and lack of flexibility inherent in preparing photo-mylar sheets.

### The technique can be applied using electrostatic printers

The firm was recently faced with a special problem presented by a re-use project on the Strand in Galveston, Texas, where we were retained to recycle the century-old Blum Building from its present abandoned state into a mixed-use restaurant-office building. No copies of the original building plans existed. This fact, coupled with severe time and budgetary constraints pointed to the use of photo-documentation to facilitate facade restoration drawings. Portions of the contract documents were required for a facade grant application, so to minimize delays, facade restoration drawings were begun considerably in advance of the remainder of the project. The drawings had to be sufficiently flexible to permit last-minute changes: the addition, deletion, or substitution of photographic images. Lead-time for composition was cut to a minimum.

To overcome these problems, we turned from the use of photo-mylar sheets to electrostatic reproductions on translucent matte-finish adhesive film. (Electrostatic reproduction refers to plain paper copiers.) Matte-finish adhesive films are translucent plastic sheets, adhesive backed and attached to liner sheets that are compatible with electrostatic copiers and similar in appearance to *Zip-a-tone*. Recent advances in plain paper copier technology now permit some measure of control over contrast and several degrees of reduction in image size. The new machines are also capable of high quality reproduction of photographs. Most plain paper copiers accept standard letter and legal-size sheets of adhesive film.

The initial stages of this process are similar to those typical of the photo-mylar process. The existing building was thoroughly photographed both for large elevation views and for specific details. We found the 35mm format adequate since the limit in image quality is set by two factors: 1) the number of "stages" (reproductions) the image must pass through from camera to finished sheets, and 2) the diazo printing process itself. Contact sheets of

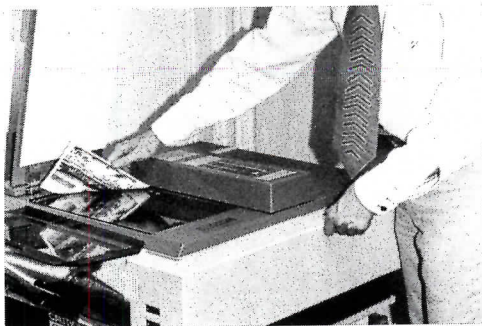

Figure 1



Figure 2



Figure 3

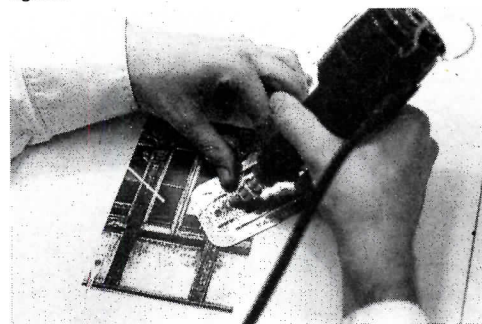

Figure 4

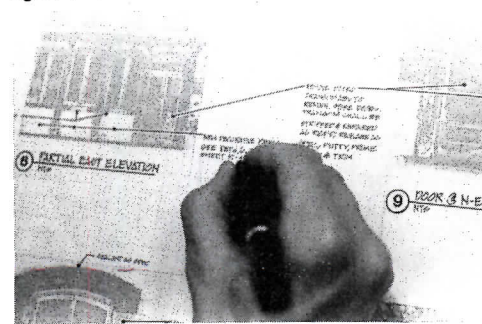

Figure 5

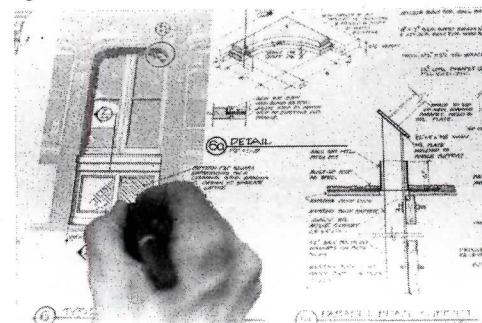

Figure 6

35mm film were then used to select negatives for enlargement to 5×7 prints.

The images chosen for enlargement were printed *in reverse* since it was anticipated that the adhesive-film copies would be applied to the back of the vellum tracing sheet. The reverse prints were all normal exposures printed on medium contrast paper.

The "backwards" prints were then routinely copied onto adhesive-film (Figure 1) and spray fixative applied to prevent smudging. The sheets were composed in the same manner as an ordinary set of contract documents; the images fit within the standard detail grid developed by the office. After trimming excess film from the images with scissors, we mounted the copy in its proper position on the reverse side of the tracing sheet. If the copy was wrongly positioned or if it was decided to delete the image or substitute another in its place, we simply peeled the copy off the sheet without damaging the whole (Figure 2). Replacement adhesive film images require the same amount of time to prepare as do ordinary plain paper copies — less than a minute — with the added advantage that *no* third, or outside party, needs to be brought into play.

Placement of the image on the back of the drawing sheet (Figure 3) facilitates notation. Note arrows can be highlighted by erasing a line through the image on the adhesive-film side after the arrows were drawn on the front of the sheet (Figures 4 and 5). A dummy diazo print without notation was prepared to mock up the notes and arrows so as to reduce erasures on the original sheet. During the course of the facade work, detail images were deleted and others added as the work progressed (Figure 6).

The use of the electrostatic process in conjunction with photo-documentation is a major advance which solves several problems at the same time. It reduces the "lead-time" during which the drawings are in the hands of printers to practically zero. The entire process can be handled "in-house" if the office happens to possess a plain paper copier, and a dark room. Architects prone to delaying decisions until the last minute (or, as is usually the case, caught in a deadline squeeze) will be grateful for the immediate response time offered by this method. In general, quality control is improved because the process is simpler. Fewer photographic intermediates are required, and each photograph is individually adjusted for clarity and contrast on the final document. Best of all, the overall cost of the process is a small fraction of the cost of producing photo-mylar film sheets. A recent direct comparison with a project using the photo-mylar process, revealed that the photo-mylar sheets cost roughly 12 to 15 times as much to prepare as electrostatic equivalents.

Photo-documentation is a valuable tool in the hands of the architect involved in restoration and renovation work. Today it is a fast, flexible and cost-effective method easily within the range of even the smallest firms.

The authors are with the San Antonio, Texas, firm of Ford, Powell & Carson Architects & Planners, Inc.

# HAGER...TRADITIONALLY FIRST WITH THE RIGHT ANSWER.

Sparks of innovative genius flew off Charles Hager's anvil as early as 1848. In those days, his hardware outfitted Conestoga wagons. Later, his hinges were used on the early wooden Budweiser® beer cases.

A lot of things have changed since those early days, but the tradition of being first with the right answer is stronger than ever at Hager. Our technologies and skills are hard at work on new products to follow in the footsteps of the Camtrol, Torsion, Raconteur and our electric and pneumatic hinges.

That's why our promise for today and tomorrow remains the same...whatever the need, Hager will be first

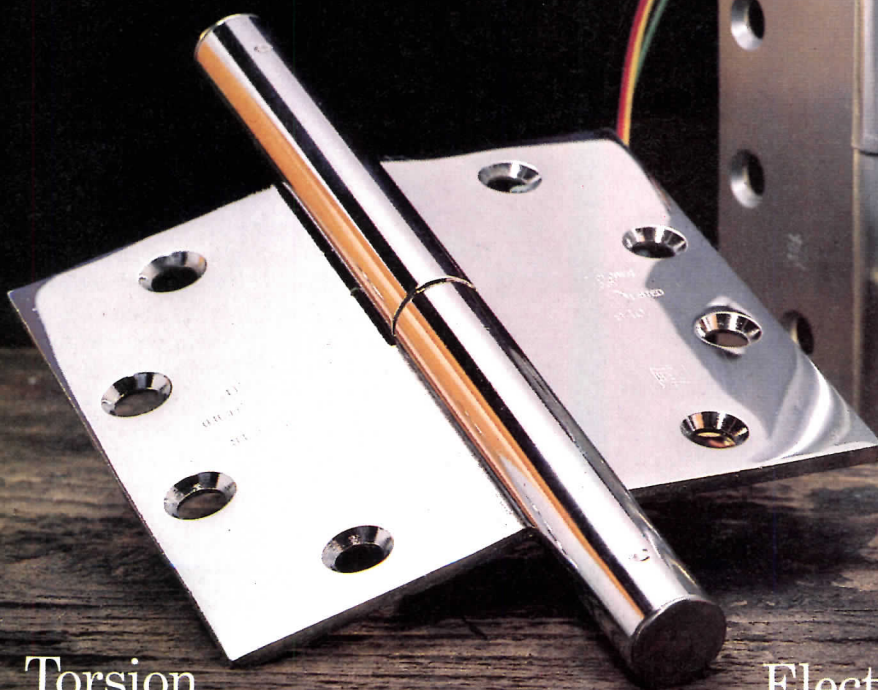

Torsion

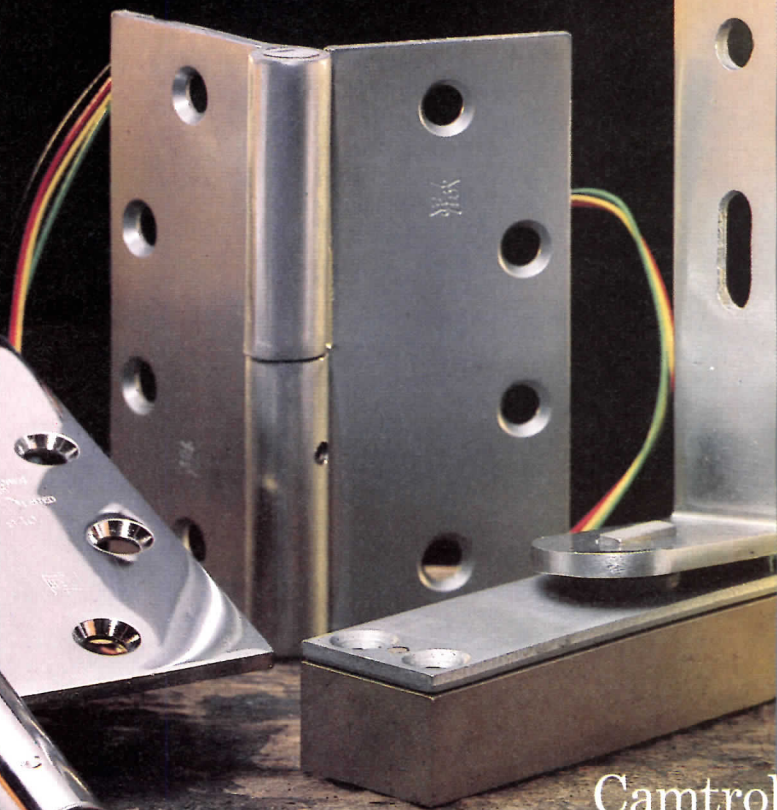

Electric Hinges

Camtrol



Henry Rutter photos

## ARALDO COSSUTTA'S NEW LOOK-OUT IN OLD LUGDUNUM

Good old Lugdunum, or Lyon as it has been called since the Middle Ages, was set up by Gallo-Romans over 2,000 years ago. Today it's the second-largest city in France, a workers' city mainly, with a surfeit of three-star restaurants. Political energies are being directed toward securing, and symbolizing, a wider economic base now, while at the same time, the city's many Medieval remnants and fine Renaissance districts are being fixed up. The mainstay of its modernizing impulses is an urban renewal area called *la Part-Dieu*, across the Rhone River to the east, where Napoleon once housed some troops quite grandly. And rising amid its otherwise disappointing collection of commercial, corporate, and commercial buildings, Cossutta & Associates' new Credit Lyonnaise Tower, containing a bank and, at the top, a skylit hotel (above), is the only semblance of contemporary design civility in sight. What it took to ensure such precision and poise is a lesson in both moral tenacity and professional control — making its formal character all the more worthy of admiration. — *William Marlin*

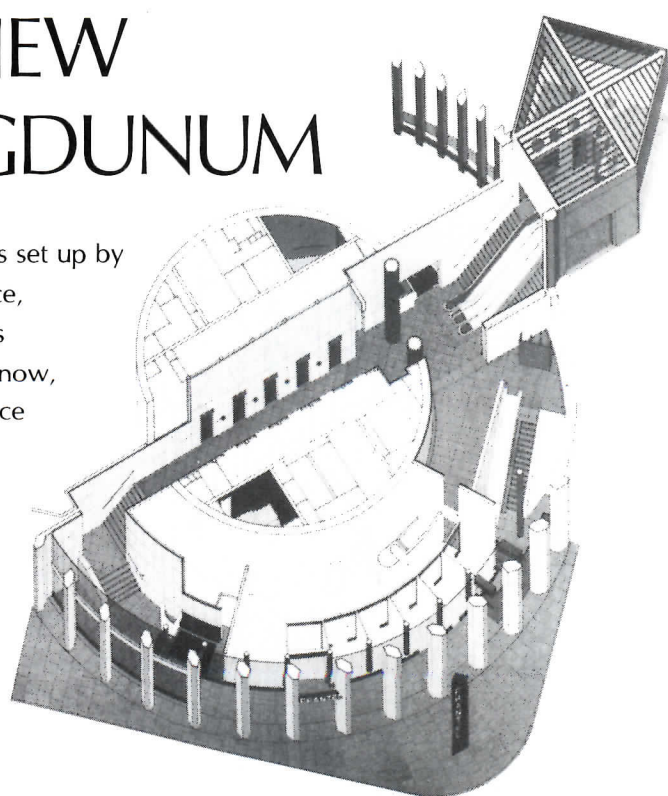



The Credit Lyonnaise Tower in Lyon, France rises amid an urban renewal area and redeems an otherwise vapid environment. Its precast concrete cladding is precise, polished to a gloss, and looks like fine stone.

The plaza-level entrance (below left) provides access to the main banking hall and the office elevators (below right). The building is a triumph of detailing amid the expediency of French construction.





## CREDIT LYONNAIS TOWER

When Araldo Cossutta, a long-time principal of I. M. Pei & Partners, struck out on his own in 1973, he took along the responsibility for an interesting commission in the French city of Lyon.

This commission, which had come into the office in 1971 from the *Societe des Centres Commerciaux* (SCC), a big developer, was for the Credit Lyonnais Tower. It was finished last fall and is named for a big bank.

While the design and detailing of this tower are interesting enough, what is really interesting is what it took to keep the integrity of the architecture intact—because the French way of getting buildings up is very different from the American way of getting buildings up.

This one goes up 42 stories, which, in low-slung, history-laden Lyon, makes it visible from all around the area. The tower, or *tour*, is round, made of concrete, clad with exquisitely polished precast units, has an emphatic angular indentation all the way up one exposure, and is topped with a pyramidal hat.

The pyramid is a skylight, made of glass sheets that are set into steel trusswork, and it covers the atrium of a hotel, the Hotel Frantel, which takes up the top ten floors of the building. Below this, ranging down through the cylindrical shape, are 28 office floors, most of them used by the bank. And below these, on the level of an elevated pedestrian plaza that ties into a surrounding renewal area called *la Part-Dieu*, is the main banking hall, a high round room with a squared-off mezzanine set into it.

Below the plaza level, the tower hits the street level, and within this intermediate section of the cylinder, several elements of access are skillfully composed. The idea of *la Part-Dieu*, if there is one, is to keep car traffic separate from all of the office workers, shoppers, and sight-seers who are sauntering up above. So at this street level, the tower has a hotel lobby to drive up to, from which people are shot up to the front desk on the 33rd floor. Off to one side of the lobby are some shops and, off to the other side, there is an entrance to the offices which, in turn, leads up one more level to the main elevator lobby. Here, too, the hotel runs a little restaurant, in addition to the ones it runs way up above, called the Grill. These main elevator banks are, in turn, connected, up one more level, with the main plaza entrance. Cossutta got more than a building into place at *la Part-Dieu*; he got place—a congenial, consolidating sense of it—into an otherwise disappointing precinct full of graceless buildings in gimmicky get-ups. Much of this local architecture, like the watered-down Beaujolais that one finds in plastic cups at quick-order counters, is a diluted sampling of unfortunate years; whereas, with the Credit Lyonnaise Tower, Cossutta has broken out a fine old cask.

His client, SCC, originally planned to build on an adjacent rectangular plot squeezed in between a shopping center and parking garage; but on Cossutta's urging, Jean-Louis Solal, SCC's director, fought hard and had the site switched to its present, more focal position next to the site of a big public auditorium,

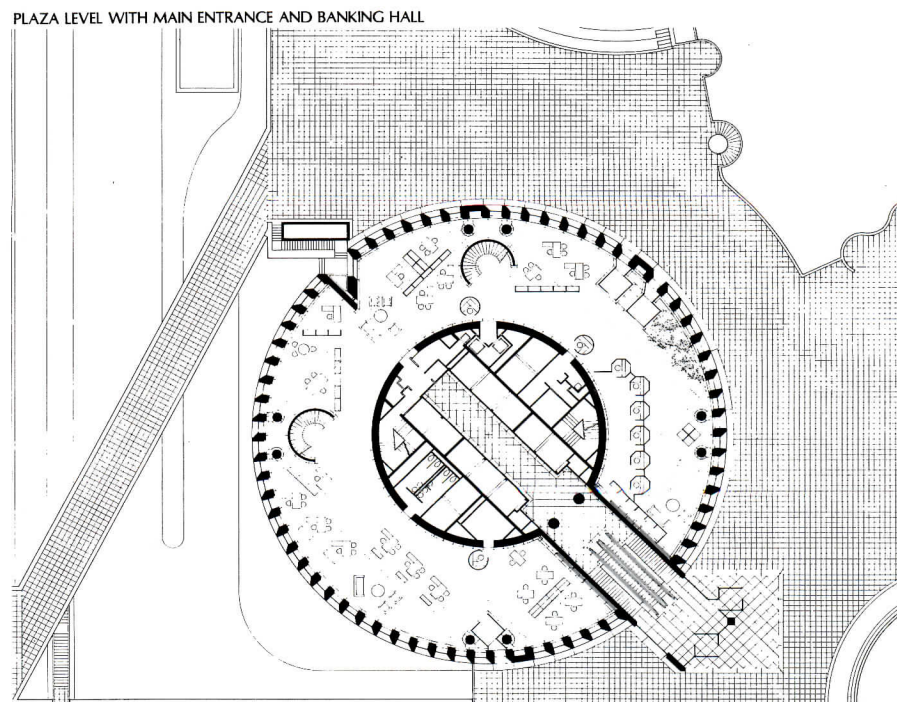
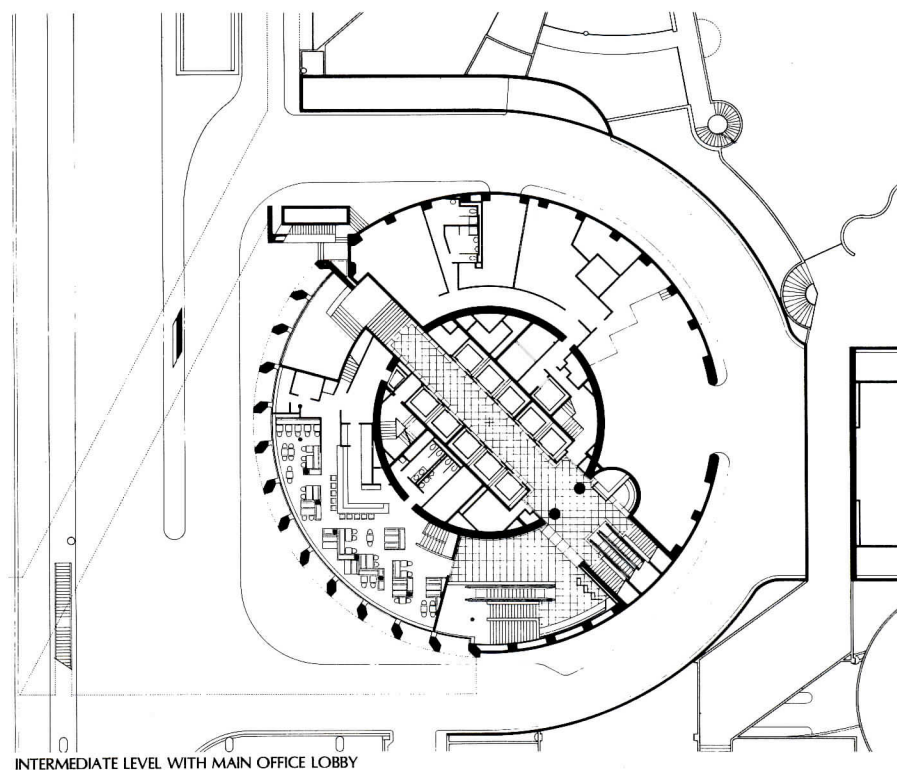
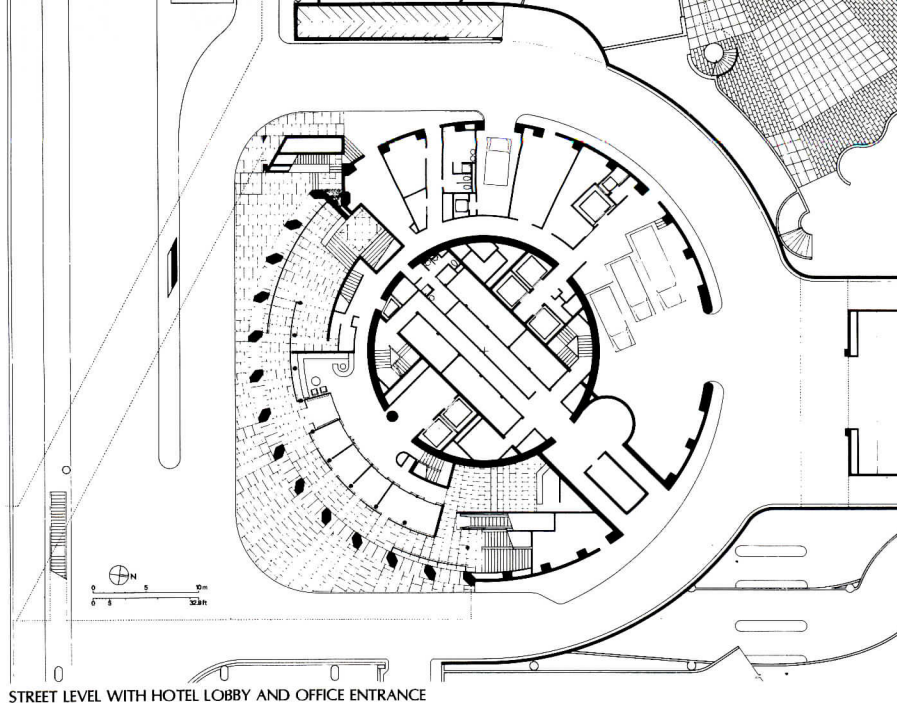



which was already in the works at the time, and which resembles an aggressive clam. At least the clam was partially dug in, below the main plaza level, next to the street. It has its own plaza, named for Charles De Gaulle. What with the projected tower and its main entrance being positioned next to the auditorium, Cossutta's team suggested a graceful amphitheater-style sequence of stairs to smooth the seam, spatially and functionally, between the two levels. As a result, the two buildings now have a rather sociable relationship.

As soon as SCC had freed Cossutta from the first site, which would have locked him into a rectangular shape to get the required floor area, he was able to act upon the impulse that he had been harboring for a round shape. Connotatively, the very word *tour* had long evoked a round image, standing out on watch, like a sentinel, keeping life safely together. The Credit Lyonnais Tower, in a city that had never been given to tall buildings, and in a country that has come to loathe them in recent years, had been permitted by officials as the one symbol of economic and cultural primacy that would be allowed in Lyon — anchoring *la Part-Dieu* as a regional center of commerce, business, retail, and culture. Cossutta saw it as an opportunity to create a center, a unifying presence, in a renewal area that had none. At the same time, the round shape that he had in mind seemed right as a symbol of respect for the older section of town, west across the Rhone River, and for the region stretching beyond.

The authorities set up two guidelines in permitting such a tall building. One was an imaginary 45-degree line, drawn up from the edge of a main street on the outer boundary of the development area. That was a legal discipline. The other was an imaginary line drawn all the way across the city from the west, corresponding to the embankment on which the cathedral is situated. That was an intellectual discipline, which Cossutta relished, although it was later determined that, due to a surveying slip, the top of the tower is actually 20 feet higher than the line drawn across from the cathedral base.

"A real resentment has built up in France about tall towers," says Cossutta, "mainly because most of those that have been built have no hint of human identification or environmental character. So I think that guidelines, had they not been given, would have been devised by ourselves as a check on ourselves—as a reminder that this opportunity carried with it a special responsibility to create a building which, though physically tall, would also be an instrument of identification for the surrounding area."

Of course, the symbolism of a round shape is only one of many reasons for preferring it and the other reasons pertain to matters of efficiency and economy. First of all, the cylinder encloses the largest area with the smallest ratio of perimeter wall, meaning savings, and making its symbolism all the more appealing to those concerned with esthetic justification. Also, with a cylindrical shape, the sunlight can't build up the concentration of

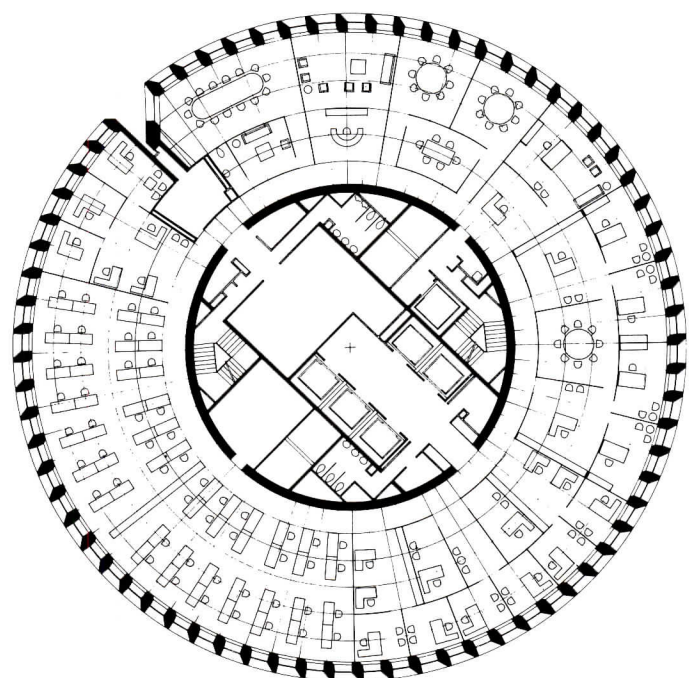

TYPICAL OFFICE FLOOR

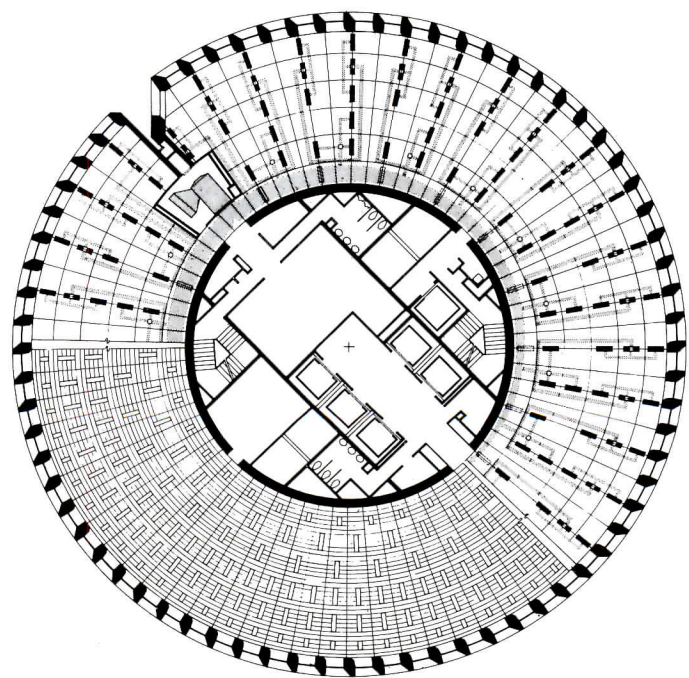

AIR CONDITIONING AND LIGHTING

The 28 office floors are modular for maximum flexibility. The floors incorporate all electrical and telephone distribution. Each floor also has its own air-conditioning system, enabling local variation in volume and thus considerable over-all economies. A rare thing in France, floor-to-ceiling windows include a transparent laminated section, where the code routinely requires a deep sill, with the larger plate glass portion above. A code variation was permitted because of the deep recess of the glass, back from the inner faces of the columns, the laminate section, and the continuous run of convectors between the columns, thus providing the protective qualities desired and typically secured by the required meter-deep minimum for sill heights. A sprinkler system is installed throughout the building, elaborating on the already stringent standards for fire-rating in France.

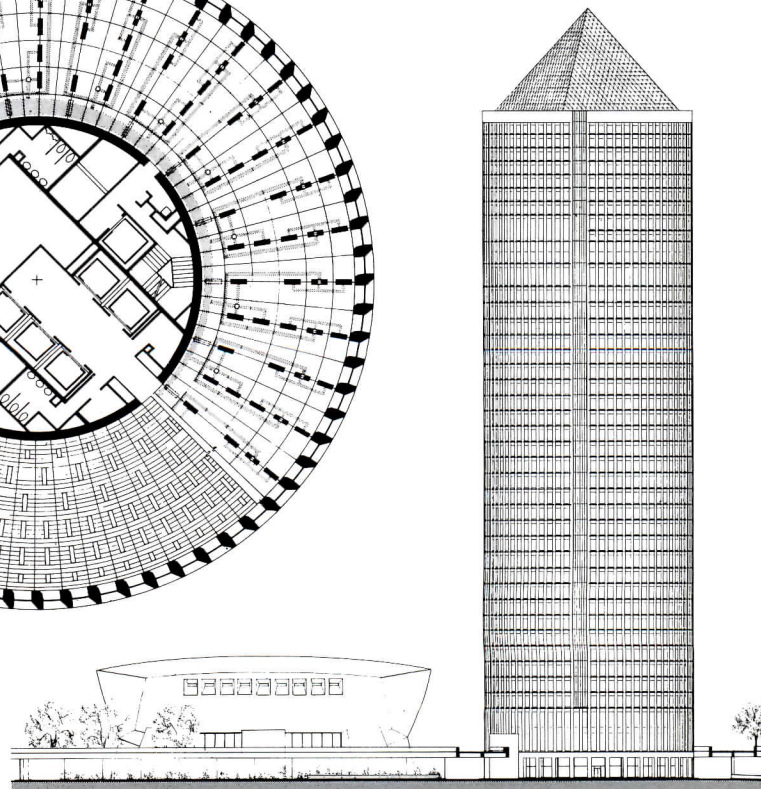



restaurant

heat that would be the case with a square or rectangular shape. At the Credit Lyonnais Tower, a maximum of 21 per cent of all the glass (and the glass represents only 45 per cent of the entire exterior wall) is exposed to the sun at any one time — and that's under the most unfavorable conditions. Most usually the exposure is down around 15 per cent. Moreover, the floor-to-ceiling windows (practically unheard of in France) are set back 22 inches from the outer face of the structural columns, and these columns—rhomboidal in section and arrayed around the perimeter like vertical Venetian blinds—enhance the inherent energy economy of the cylinder. In addition, its variable-volume air conditioning was the first time that this system was used in France, which had been accustomed to the relying on the old constant-volume method. An average temperature is thus established, with comparatively small increases or decreases being required. Floor-by-floor flexibility is further provided by the architects' having placed fan rooms on every floor, thus cutting down on long mechanical runs and the high-pressure pumping of air. The economy of all this amazed the French, and not understanding the full role of the round shape in securing such energy savings, one estimator, going over the mechanical drawings, told SCC that the architects needed a hundred per cent more capacity. The building, in use, shows economies in excess of 50 per cent over other buildings of comparable space, conventional shape, and the customary energy-sapping systems.

Over-all, the Credit Lyonnais Tower is a classic, not only of energy conservation, but of the kind of conscientious design that, at the very core of concept, makes no distinction between the sources of beauty and the sources of utility. As tellingly, it was designed *before* the so-called energy crisis scared the living daylights out of businessmen and bankers, including the client and major tenants of Cossutta's tower. This is a useful lesson. Most of the design tactics that have been called for, these last few years, to conserve energy need not have been kept on the shelf so long. Cossutta never kept them there, but, then, he is known for being a perfectionist.

He is also known as an apostle of concrete technology, and all through his career, going back to the early days with I. M. Pei, he has steadfastly refined his use of it to the point where, as at the Credit Lyonnaise Tower, it is a precious material. The Denver Hilton, the L'Enfant Plaza in Washington, the University Garden Apartments in Chicago, the Christian Science Center in Boston — all done during the Pei years — demonstrate a constant effort to seize upon the capacity of concrete to make the most of light and shadow.

"I have never been at ease with a reflective architecture only," he says, "and with concrete, you can deal with relationships of opacity and transparency that seems somehow richer, more arresting, more absorptive than metal-and-glass solutions. My own fascination for concrete goes back to my studies in France, at the Ecole des Beaux Arts, when I was first exposed to the pioneering work of

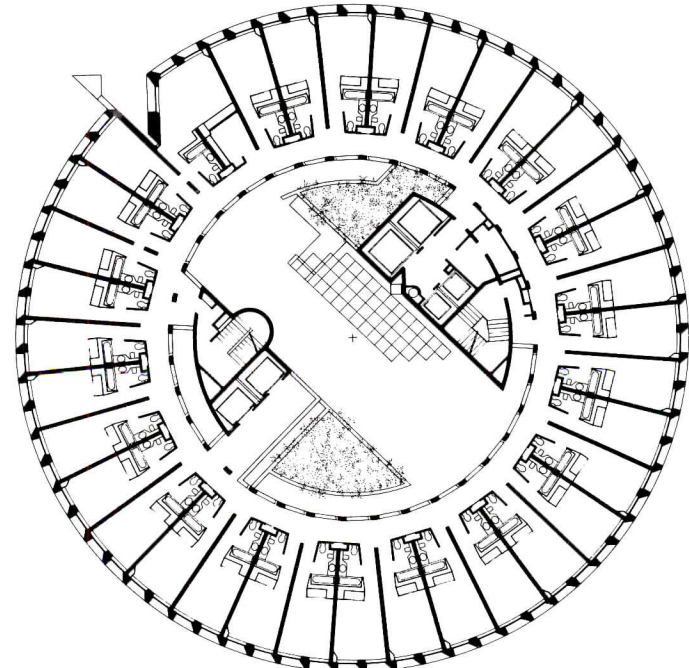

TYPICAL HOTEL FLOOR

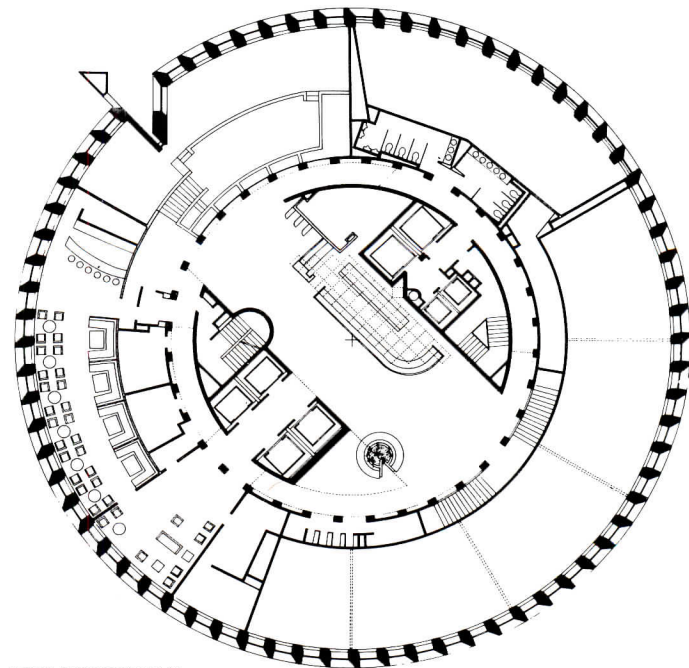

HOTEL RECEPTION LEVEL

The Hotel Frantel takes up the top ten floors of the Credit Lyonnais Tower. Two hundred and forty-five rooms, occupying seven of these, are arrayed in a series of arcades around a high interior atrium that is topped with the pyramidal skylight. Though evocative of John Portman, this atrium more immediately relates to the old Lyon tradition of interior courtyards. The two lower public levels of the hotel contain lounges, a bar, and a restaurant, the variation of height being reflected by a sweep of double-height windows on part of the facade, this picking up, in turn, the double-height windows at the base of the building where the higher banking hall is situated. A variation in the fire code was allowed in the case of the hotel by providing a smoke-free vestibule between each room and the atrium space.

Auguste Perret, and certainly to my apprenticeship with Le Corbusier. Frank Lloyd Wright was also a great inspiration, what with the subtle aggregate surfaces of his poured concrete forms at Unity Temple. There is science and sensation and symbolic power for me in this material."

For this tower, Cossutta did what he calls a *concours*, a competition literally, for the structure; and the drawings were drawn, rather like an outline, to denote the dimensional and structural limits of three possible materials — concrete, precast concrete, and steel. Into this dotted-line framework of possibilities came the estimates, with concrete winning, and Cossutta says that this approach enabled complete success in securing first-rate construction, with corresponding efficiencies of time and costs.

What one sees, though, is the magnificent precast concrete units with which the supporting structure is clad, and these have a precision and polish rarely achieved with this technique. Granite cladding had initially been decided on, but, with the oil embargo having hit, SCC officials passed the word along to cut 20 per cent out of the cost of the building, even though those same officials had originally added one million dollars to the budget for a more luxurious finish. They got luxury anyway, and over-all, the building came in eleven per cent below the revised estimate.

The architects made a trip to the Loire River Valley, looking for just the right aggregate material, and found a reddish-brown granite with faint flecks of green and blue. The granite was carefully crushed in several gradations of size, to allow for the gradations in the density of the aggregate in the units. A pigment of iron oxides, from bright orange to darkest brown, was then cooked up for the final mixing with the concrete, and because of the gradations of aggregate, which is extremely close-grained on the surface of the units, the amount of concrete that actually shows is infinitesimal. In polishing, oxides of aluminum were initially used, but the gloss seemed a little subdued. The manufacturer, going back to the Middle Ages, suggested using an oxide of tin for the polish. "For reasons that no one could scientifically explain, we got a *real* gloss, then," exults Cossutta. With this precision and polish, and with the units having almost the inherent characteristics of natural stone, it was possible to have extremely thin joints, and this enhanced the uniformity of the facades while also allowing for easy glazing, which Cossutta prefers to slip right into his materials, securing them with practically invisible reglets instead of the more customary and obtrusive metal framing. What has been put up in Lyon is a direct, unadorned, and eloquent exchange between mass and glass, illumined by the movement of the sun which, in turn, brings about a textured relief as the close-spaced sequencing of the rhomboidal columns is caressed by the light.

In choosing the cylinder, Cossutta was choosing a universal, generalized form which, for all of its symbolism and efficiencies, depends upon modifications for the fulfillment of its character. One form of fulfillment in this

case is the arrangement of the columns, angling out from the planes of recessed glass, and arrayed around the shape in a counter-clockwise sequence. What this does is give an asymmetrical element to the basic symmetrical shape, an element of visual momentum, in effect, that is sped up or slowed down as one walks around the building, views it from varying distances, and as the light changes. Another way that Cossutta fulfilled this geometry was by way of the vertical indentation, which the French came to call an *encoche*, which, roughly translated, means "kink."

This *encoche* is there for two basic reasons. Cossutta wanted to give directionality to what would have been an otherwise indeterminate surface, and, symbolically deferring to the old section of Lyon, the *encoche* is directed westward. It also, in a more practical sense, supplies a corner office on every floor, which the usual cylinder couldn't have, obviously — and that was an important selling point. More definition is given to the tower by the pyramidal skylight, its angularity picking up on that of the *encoche*. A dome up there might have done nicely, or a cone, but Cossutta felt that the pyramid was the best way to give directionality to all points of the compass in the same sense that the *encoche*, in a more immediate urban sense, gives an orienting quality to the tower as it relates to the old downtown over the river.

On a conceptual level, Cossutta seems to have accounted for everything, and on the practical level of justifying his concept to SCC, the design of the tower accounted for every dimension of function. All of this was put down in impeccably detailed drawings—the kind of drawings that American architects love to produce, and the kind that they are expected to. It was a tooth-and-nail fight, for four years, though, to keep those drawings in control; because in France the drawing is not the law and, other than the facade — "the facade is the only thing that the architect is still king of in France," says Cossutta — the architect most usually supplies a basic outline of requirements, all the way through mechanicals, and then lets the contractors propose.

For reasons that are Napoleonic in origin, the French contractors share equal responsibility with the architect, and, Cossutta continues, "It has just become too hopeless for architects to bother with doing detailed construction documents when the French contractors are going to come in and say that they won't take the responsibility."

On this job, with all of the trades being seen to by a *coordinateur* (there is rarely a general contractor on a French job), and operating with a book of basic minimum standards, the trades, not especially attentive to how their respective responsibilities might relate to each other or to the final precision of the building, were apt to ignore such things as the architects' specification for joint widths between the stone cladding in the lobbies, not quite comprehending why two-millimeter joints weren't as adequate as three-millimeter joints.

As a result, the architects had to maintain a constant look-out for coordination of the

trades to ensure careful follow-through. One example was ensuring that uneven mechanical runs wouldn't result in uneven ceiling heights. The heights *are* even, and those stones in the lobby are joined just-so, but it's because Araldo Cossutta and his team believed that architectural integrity consists as much in the doing of a concept as in the drawing of it. France, admiring the Credit Lyonnaise Tower today, may yet understand what their admiration *should* consist of.

David Martin, Cossutta's project architect in Lyon, says, "You can get to the point, talking about idealism in architecture, that it all begins to sound a little trite. But imagine a situation, such as exists in France, where the architect is considered in complete seriousness as a kind of brush-and-easel man, doing color wash drawings with shadows. There is no concept of the architect's coordinative, supervisory role as Americans think of it."

That's for the *coordinateur* to think about, a function rather similar to our construction managers. He is hired by the client, gets one to two per cent of the cost of the work done by each contractor involved and a percentage of the total cost of construction. Cossutta came onto this job with a complete, coordinated set of drawings, which is strange to the French system. The calculations, the estimates, all were checked and cross-checked by the controlling agent, SOCOTEC, which is required by the system to review and approve every detail pertaining to structural, technical, and security matters.

Those SOCOTEC people, being very official and very professional, are the *real* engineers in France. Very objective and thorough. But then come all the contractors, whose only idea of 'meaning' in architecture is to figure out the other contractors' motives, to shave every last *sou* of cost and inch of steel, to refuse responsibility for this or that detail, and then to specify the solution by which he will accept responsibility. It is then in the interest of all these trades to negotiate extras eagerly. People set traps so that the extras are necessary, while, at the same time, other people are shaving off costs. It can be as amusing as it is harrowing. At one point, a contractor agreed to payment for the aluminum lighting fixtures by *weight*, only later to find out that the client was insisting on a lighter weight aluminum.

In command of the basic structure, in complete control of the character of the precast cladding of the facade, in daily deliberation about measurements to be followed and finishes to be refined (or at times redone), Cossutta & Associates finally delivered a calm, composed, cohesive work of architecture. It is a reminder, as W. Somerset Maugham used to say, that the best things tend not to show the effort they required.

---

CREDIT LYONNAIS TOWER, Lyon, France. Architects: *Cossutta & Associates*—Araldo Cossutta, principal-in-charge; David Martin, project architect; Arnaud Puvion de Chavannes and Marta Rudzki, project associates. Engineers: *Weiskopf & Pickworth* (structural); *Cosentini Associates* (mechanical and electrical). Contractors: *Thinet et Cie* (concrete and masonry); *Morin, S.A.* (precast facade units).

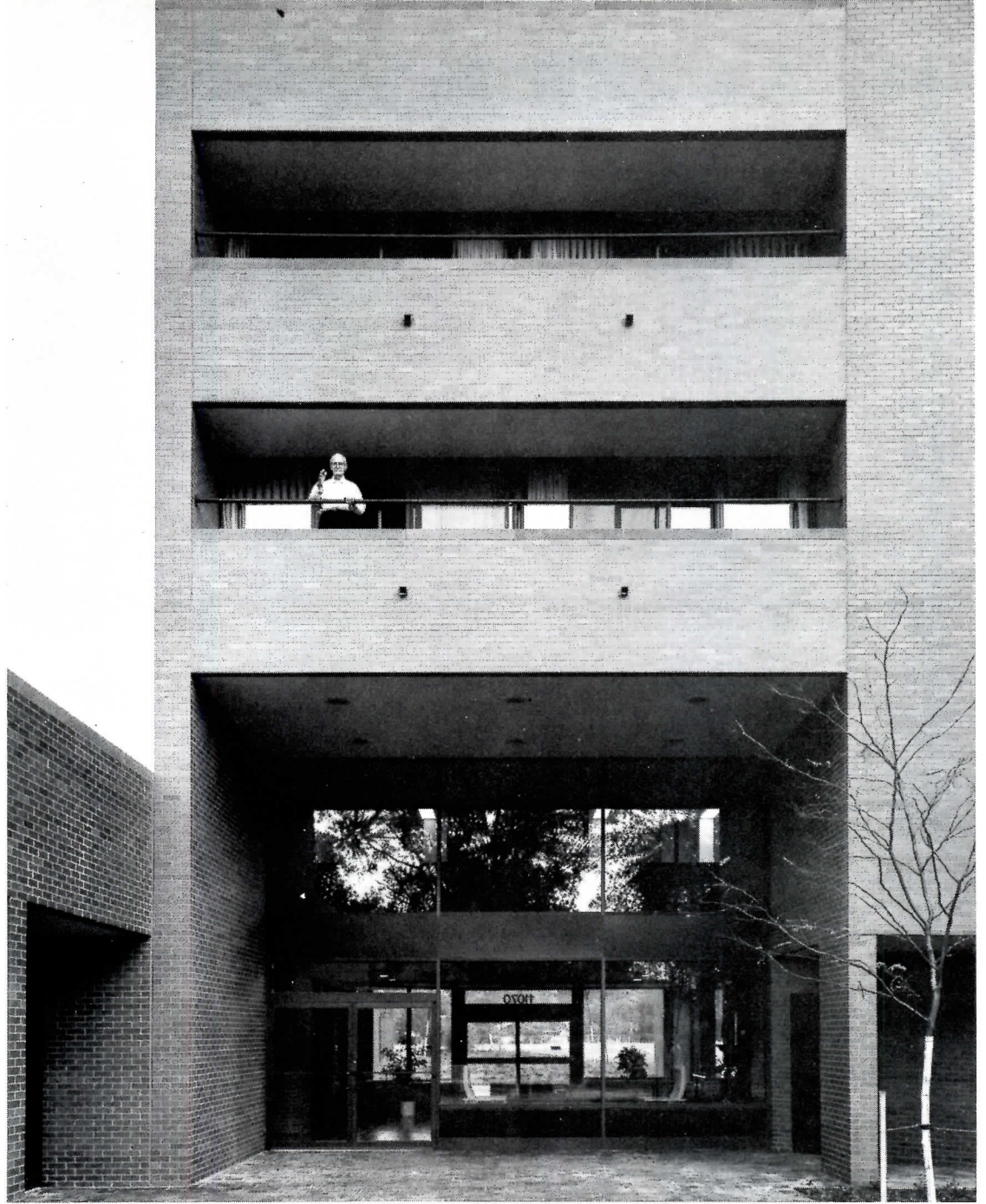

Bo Parker photos

## BETTER ANSWERS IN HOUSING THE ELDERLY WITH CARE: MAPLE KNOLL VILLAGE

In May of 1977, *RECORD* published a Building Types Study on housing the aging that argued for more humane surroundings—less institutional in character and more considerate of the elderly as individuals. Architects Gruzen & Partners, who designed the mid-rise Palisades Nursing Home shown last May, have now finished work on another facility—Maple Knoll Village in Springdale, Ohio shown here. Maple Knoll has the character of a real village where people might choose to live, not an institution where they are sent. At the same time it provides for continuous physical care at all levels of need; it does not shuffle its residents off to other facilities when their health conditions worsen. It is truly a place to live—and not just a place to live out time.—C.K.H.

Intimate in scale and more like conventional housing than an institution, suburban Cincinnati's Maple Knoll Village encourages the sort of living—and not just custodial care—for the elderly that one hopes is the wave of the future. With a steadily growing part of the population in old age, and with the decreasing number of close-knit families that once provided ongoing care in the home, architects Gruzen & Partners have found good answers to what the alternative—communal living—can be. It may often have to be communal because of common specialized physical needs—and according to some gerontologists, because of psychological needs as well. But Gruzen has proven that such living need not be in the inhumane hospital-like atmosphere that has sapped vitality from so many older people in the past.

Maple Knoll clearly resolves what often has been regarded as a contradiction: an at-home atmosphere *and* provision on a continuous basis for medical needs that have normally been met by transferring ailing residents to institutional environments. And as *RECORD* explained in the Building Types Study for last May, the transfer may kill the elderly through trauma.

At Maple Knoll, three levels of care are accommodated in four types of buildings. At the most independent level, persons with limited medical needs live in town-houses of one and two bedrooms, clustered at the northwestern corner of the site. The other buildings, linked together by a wide street-like corridor, have one bedroom or efficiency apartments for the relatively independent in the northernmost block, communal facilities in the central block and nursing care in the southern. These linked buildings are arranged around a large "village green" of lawn and mature trees that occupied the site before the new construction (photo opposite).

While there is some natural segregation of facilities for the various levels of care, there is also a strong interaction of all the residents that is encouraged by the interior "street" and the large number of shared activities that it connects (see plan overleaf). Because of the constant traffic along the street, the lounges dispersed along the street's length offer the same appeals to the more sedentary elderly that are gained in other projects by such persons clustering around the main entrances just to "see what is happening." And to counter the idleness that makes residents cluster, there are the many opportunities to develop busy hands and minds that are discussed further on.

Maple Knoll's 32-acre site was occupied by an older structure, and its foundations were retained as a partially covered terrace and a central focus of the "village green." Because of the desire to make a direct contact between the buildings and the green, the site's access road was located on the outside of the ring of connected buildings. And to create another variation on the scale of exterior spaces, the northernmost apartment block encloses courtyards that open onto the green.

Both the townhouse units and the apartments are large by institutional standards, and could well be like smaller apartments that residents might have occupied in their more active years. The concept is to ease the transition to a new life style. The town houses have individual garages and many of the 150 apartments have balconies. It is only in the nursing rooms that a more practical, institutional character predominates.







The vertical mass of the chapel projects from the central building of commonly shared facilities, and is the focus of the "village green" (photo above and center of site plan below). The entrance to the nursing-care building is shown in the top photo at left.

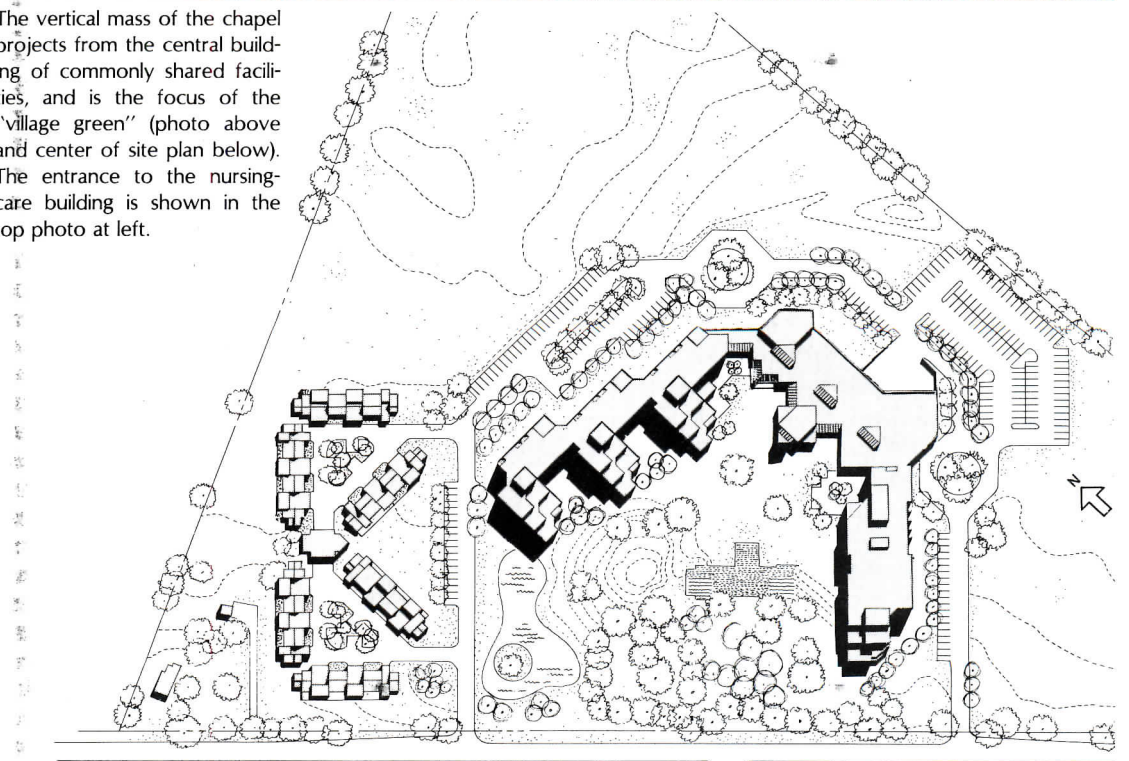

But even in many of these, there are balconies, and a large proportion of the 165 beds are one to a room.

But of course, the object is to keep residents out of the nursing units in the first place, by stimulating their all-important psychological drives. In accomplishing this stimulation, the programs and the attitudes of the administration become as important as the physical surroundings. At Maple Knoll, residents are offered a number of activities beside the usual social programs. Most striking is the opportunity of teaching either in the pre-school facility or in the day-care center, that are both located on the ground floor of the nursing unit. (These are intended for the younger children in the neighborhood.) It is well established that the elderly can be extremely effective in working with the very young. Another unusual opportunity is the ability to make various craft objects, which are sold in Maple Knoll's gift shop. Both activities keep interest and a sense of responsibility high, while allowing for the opportunity to produce income.

To house the many activities, there are—besides the facilities already mentioned—craft rooms, a machine shop, a therapy room, a beauty shop, a snack bar, a library, a gift shop and a chapel. The chapel is located at the focus of the common facilities building, and its importance on the village green is accentuated by its high roof and vertical mass. Round windows near the altar further enhance its special character. All of the stained glass in the chapel was designed by artist Harriet Hyams.

The ambitious and vital nature of both Maple Knoll's programs and the facilities to house them are a result of the special natures of the clients and of the architects. The client, Southwestern Ohio Senior Services grew from an organization once called the Widows and Old Men's Home, founded more than 100 years ago by Harriet Beecher Stowe's mother. Up to the recent past, the group had a traditional custodial attitude, which has been radically changed by a new administrator, the Reverend Jerry Smart.

According to Gruzen partner-in-charge Peter Samton, it is vitally important that the architects are involved in the planning for such facilities right from the initial programming stages. This is especially true when the architects have had as much experience as Gruzen's, which began in the early 1950's. "In a specialized but relatively unresearched field, there is much to be learned from repetitive experience. This ranges from improving hand rails to the location of lounges."

Maple Knoll currently houses 315 residents, and expansion around the perimeter of the site is planned for up to a total of 700. The buildings now contain 290,000 square feet, and the construction cost was \$12.5 million. The basic structural system is precast concrete plank on masonry bearing walls, and the cladding is brick.

MAPLEKNOLL VILLAGE, Springdale, Ohio. Owner: *Southwestern Ohio Senior Services, Inc.* Architect: *Gruzen & Partners—partner-in charge: Peter Samton; project architect: Benedetto Puccio; design assistant: Robert Evans.* Associated architects: *Glaser & Myers & Associates, Inc.* Engineers: *Robert Silman Associates* (structural); *Syska & Hennessy, Inc.* (mechanical/electrical). Landscape architect: *M. Paul Friedberg & Partners.* Cost consultant: *Amis Construction & Consulting Services, Inc.* Construction manager: *Gruzen/Amis*

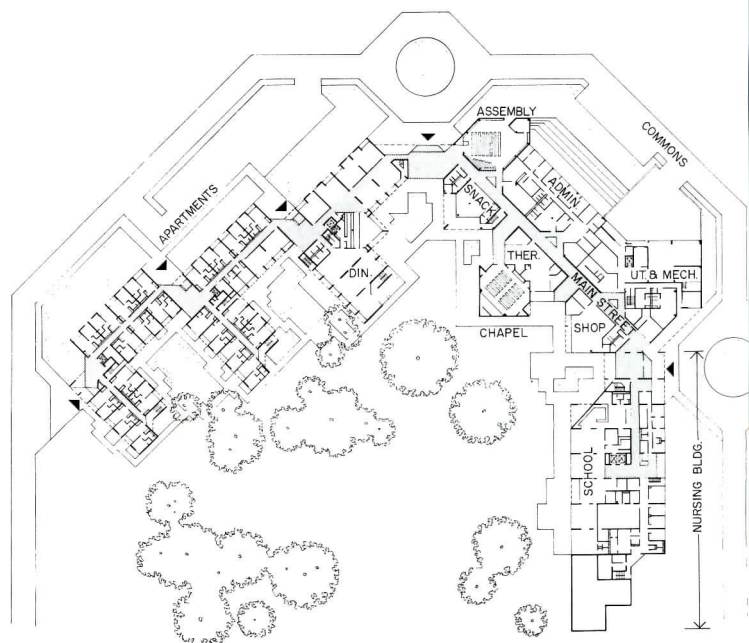





The apartments in the building for semi-independent living approximate normal apartments in non-institutional surroundings, and lend themselves to the residents own furniture (photo, above). Most have either balconies or skylights opening from the living rooms. The "main street" (photo at left), which connects the various buildings and activities, opens to lounges which obtain either views through windows or obtain natural light through skylights, as does this lounge in the central building. Here, hanging banners have been designed by artist Susanna Lewis to add life and color. The chapel is shown below.



# ALL IS NOT QUIET ON THE WEST FRONT

It is difficult to avoid wondering if the forces for preservation in America—whose voices were once, and still are, urgently needed in the face of the mindless destruction of fine buildings from the past—are themselves becoming erratic in their judgment of what is worth preserving and seem to be carried away by an almost hysterical urge to oppose any alteration of any kind.

by Jean Paul Carlhian

The battle over whether to "extend" or "restore" Charles Bulfinch's West Central Wing—generally referred to as the West Front—of the United States Capitol is raging again. This month, the Congress is scheduled to be presented with a set of documents prepared by the Architect of the Capitol which describe the esthetic and financial dimensions of the problem, and basically Congress will have to choose between three options: to shore up the existing West Front, to build a new one along the lines suggested by the Capitol's mid-nineteenth-century architect Thomas U. Walter, or build an altogether new one along still undetermined lines. The arguments for and against each of these courses have much that is surprising, and surprisingly general, to tell us about how we regard not just our architectural past, but our architectural present as well. First, though, the background needs to be considered.

The United States Capitol—unlike the White House or the Brighton Pavilion or the Paris Opera—is not the creation of any one man, but the result of the efforts of a succession of designers whose additions have several things in common. All are symmetrical (and therefore they all respect the main east-west axis of L'Enfant's city plan), all are the same height, all consist of a base surmounted by a two-story element punctuated by columns or pilasters, and all are crowned by a balustraded cornice. But the building grew by fits and starts. William Thornton, Benjamin Latrobe, Charles Bulfinch, Thomas U. Walter, and others left their mark on it, and none of these men—some of them not even architects—seem to have regarded the building as work to be completed as its original author intended.

Bulfinch, for instance, having carried out Latrobe's design for the East Central Portico, set to work on a new West Central Wing entirely his own. Both porticos as well as the original House and Senate wings were built of an inferior stone, and, after the British arson during the War of 1812, they were painted.

Thomas U. Walter appeared on the scene in the mid-nineteenth century, having, like Thornton before him, won a Capitol design competition. During his tenure as Architect of the Capitol, he practically tripled the size of the building he had originally found, adding to it North and South wings of more durable marble and topping it off with his spectacular cast-iron dome, finished in 1863. When he resigned in

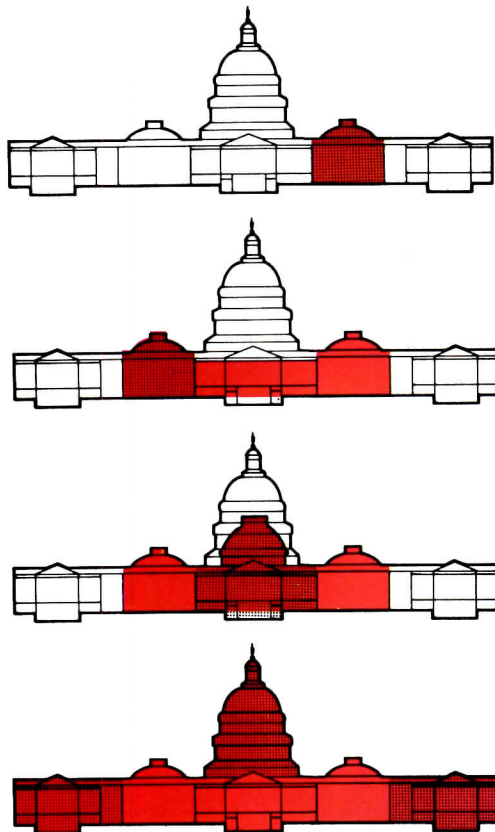

1865, he was preparing a series of drawings to show how he envisioned the completed Capitol. His design called for the demolition of Bulfinch's West Front (designed in harmony with Bulfinch's more modest and lower wooden dome) and its replacement with a much bolder base for his newer and more magnificent creation. Meanwhile, additional protective coats of grey paint were applied to the Thornton, Latrobe, and Bulfinch facades until the new and expected construction was carried out.

Walter's additions not only transformed the appearance of the Capitol in a radical way, but, as time went by, they also provided Americans with a symbol of their government, so that the image of his dome, appearing on postage stamps, money, and in countless other forms, has captured their minds, and it has come to represent the very ideal of American democracy.

After Walter's resignation, Frederick Law Olmsted constructed the terraces below the West Front, completing them in the early 1890s. Bulfinch's facade was not changed, and since then no other modifications have been made to this side of the building.

In the late 1950s and early 1960s, however, the East Front—amid much controversy and under the direction of J. George Stewart, then Architect of the Capitol—was

moved some thirty-two feet forward, and Bulfinch's version of Latrobe's East Portico design was reproduced, but this time in marble. It not only followed some of the recommendations made in a 1904 report by the New York firm of Carrère and Hastings on the provision of a visually adequate base for Walter's dome, but indeed it appears to have followed the recommendations of Walter himself.

Meanwhile, the West Front continued to deteriorate; shoring seemed necessary and was added. The Congress—understandably alarmed by the situation—ordered a comprehensive survey of the problem. The firm of Praeger Kavanagh Waterbury was retained, and the results of their studies were the subject of an extensive and elaborate report which supplemented earlier reports of 1957 and 1964, and which was published in 1971. It concluded that complete restoration of the West Front was feasible and could be achieved for \$13.7 million or for \$14.5 million, depending on the method used. The restoration, however, was not carried out.

In 1976, in response to pressures from an overcrowded House of Representatives, the Architect of the Capitol was asked to study the possibility of extending the West Front. Preliminary plans were prepared, and an estimate of \$55 million was advanced.

The Senate, however, experiencing much less overcrowding and counting among its members ardent champions of the restoration approach, responded unfavorably to the suggestions of the House, which had already voted the required appropriation, and, instead, it asked the Architect of the Capitol to update the Praeger Kavanagh Waterbury report to include recent costs and other necessary items as well as a capital budget to repaint the building every five years. The Architect of the Capitol estimated \$45 million.

The American Institute of Architects, for its part, had demonstrated its interest in the whole matter as far back as 1937. From then to this very day, it has reiterated its initial and unalterable position in favor of restoration, as most recently voiced by its Task Force on the West Front of the Capitol, established in 1966. The only degree of flexibility it has entertained is with respect to the kind and extent of restoration required. After what appear to have been hasty consultations with specialists serving on a voluntary basis, a representative of the task force addressed a committee of the Senate on

**There is the serious implication that no one should have the affrontery to utter any negative statement about a building so sacred. What could be behind such an assumption except the fear that whoever touches the Capitol will make a mess of it?**





A design by Thomas U. Walter for the West Central Wing.

last June 14th, and he enumerated five degrees of depth to which restoration work might be carried, with price tags ranging from \$2.2 million to \$3.3 million.

One can well understand the Congress's bewilderment on hearing from two presumably reliable architectural sources that the West Front could be restored from anywhere from \$2.2 million to \$45 million, and that a totally new building providing much more space could be had for only \$10 million more.

And so with the House by a slight majority favoring extension and the Senate favoring restoration—and with some clarification of the costs obviously necessary—the Congress instructed the Architect of the Capitol to prepare more detailed documents relating to the AIA task force's five restoration steps, to update yet again the Praeger Kavanagh Waterbury report, and to update the plans for extension. These documents are to be prepared in sufficient detail to allow reliable cost estimates to be made, and they are to be completed in March, 1978—this month.

Without passing hasty judgment on the parties involved, one ought to ponder their respective problems and positions. The Architect of the Capitol's duty is to serve two equally important clients, both jealous of their prerogatives and both fiercely independent. The preliminary drawings for a new extension, prepared in response to the House's instructions, do not necessarily reflect his own personal artistic preferences; they are based, as a point of departure, on Walter's legacy. Any suggestion at this point that they represent the final design may be termed premature.

As for restoration, when it applies to a public monument of such national importance, where every piece of work remains under the daily scrutiny of the press, the public, and their elected officials, it is a tricky business, and one should not be blamed for taking great care in deciding which methods to apply. Repair work is risky, and no architect can ever be assured in advance of what the work will uncover as it progresses. Costs, too, have the regular habit of escalating at a frightening rate. And so one can hardly blame the Architect of the Capitol for being cautious.

It is, on the other hand, a remarkable fact that representatives of the architectural profession—a profession well known for constantly harping that its clients seem never to appropriate enough money for the solution of the

problem at hand—now cast doubt on the budgetary findings of one of their eminent colleagues. Puzzling, too, is the fact that representatives of this same profession—a profession besieged from left and right by lawsuits—now advocate with proclaimed assurance a series of restoration measures derived from what appear to be rather scant engineering analysis and relying primarily on the advice of a restoration expert who confesses an incomplete knowledge of the building and who also confesses having recently made only a purely visual and rather hasty inspection.<sup>1</sup>

In all of this, though, one must keep in mind the fact that, as far as construction on Capitol Hill is concerned, Congress is its own master, not subject to review by anybody, whether it be the Committee on the Fine Arts or the National Capital Planning Commission. The Congress, moreover, traditionally regards itself as the spokesman of its constituents and does not see the necessity of seeking official advice from anyone—though one exception was Senator Baker's unprecedented public hearings in 1974 on the extension of the Dirksen Building.

While the Congress's bewilderment over the conflicting assertions being made about the West Front is certainly understandable, and while its determination to see that appropriate documents leading to accurate cost estimates be made is laudable, the tight schedule it has imposed runs the risk of seriously impairing the degree of thoroughness with which such work should be carried out.

The schedule mandated by the Congress is also unnecessary, for while the slow but steady deterioration of the building does go on—especially in those parts destined to be painted but which have not received a new coat since 1968—it should be made clear that the West Front, well shored up as it is, is in no immediate danger of collapse. Time, therefore, is not of the essence, in spite of the report in *Engineering News Record* in June, 1977, now proved erroneous, that the building was sliding down the Hill at the rate of an inch a year.

Nonetheless, the country may very well be faced with a Congressional decision this month to proceed immediately with restoration. This would preclude any further study or public debate. On the other hand, should the Congress decide to proceed with some form of extension, appropriate time can still be allotted to the study of alternative solutions;

only under these circumstances could the public at large and the architectural profession be given the chance to debate the extent, the nature, and the style of the proposed addition.

With all of these things to be considered, Congress seems to have only three options. What, then, are they?

#### A new approach

The first—and the most daring—alternative would be to take up history's gauntlet and proceed with an altogether new West Front, conceived along late-twentieth-century lines of thought and executed with the techniques of our times.

The problem, of course, would arise of how first to search for and then to choose the right architect. Methods available and previously tried, with varying degrees of success, range from the simple polling of public opinion (either spontaneous or prompted) and the consulting of professional organizations (with possibly a request for nominations) to the setting up of a search committee (the composition of which itself presents problematical facets). This latter was the device, for instance, chosen by the Kennedy family for the selection of the architect for a Presidential library, with a roster of a dozen architects including several prominent foreigners. In the case of the Capitol, such a method would free the Congress from the responsibility of a rather specialized selection, and it would also provide its members with a plausible answer to the inevitable criticisms that the selection of any one individual by a public body is bound to produce.

Another more traditional way would be the establishment of an open architectural competition. Such a device offers the advantage of broadening the base from which a suitable candidate might emerge. It does, too, have its own drawbacks—beginning with the composition of the jury. Since no architect worth his or her name would enter the competition without the assurance that it would be judged by respected and trusted colleagues, naming a jury presents the same problems as the naming of a search committee—with the difference that, on a search committee, one of its own members might conceivably be designated by secret ballot. On a competition jury, members by agreeing to serve would have to renounce their right to compete, and so selecting the most qualified

## What does 1891 represent symbolically?

## Why should the Capitol be frozen to its 1891 configuration?

## Why should it not be seen for what it is: an unfinished building?

jurors might also eliminate the best competitors. In any case, one of the great appeals of an architectural competition is that it traditionally has been an accepted way to select the architect for a momentous assignment, and, incidentally, on two other occasions for the Capitol itself.

It should be noted, though, that the whole idea of designing a totally new West Front is likely to cause a great outcry from virtually all preservationists—whether they be historians or architects—and to the usual preservationist sentiments they will add a list of further objections.

Among the first is bound to be that the spirit is simply not there, that too much time has gone by since Walter's last creation, that the whole approach to architecture has changed, that nobody worthwhile in the profession is interested in classical architecture, least of all in symbolism and in monumentality. Proponents of such arguments point to the Washington Cathedral and the Cathedral of St. John the Divine in New York—with the spirit of the generation of the Klauders and the Crams and the Goodhues now gone—standing unfinished. But, on the other hand, there do seem to be mounting indications that a new concern for form, for symbol, and for other philosophical aspects of architecture is in the process of supplanting architects' traditional twentieth-century "functionalist" fetishes. The United States today harbors many of the greatest living architects, and some of these indeed have demonstrated their understanding of classical architecture, monumentality, and symbolism. It is reassuring and comforting, too, to observe the courageous and vigorous aspirations of a group of younger architects who are dedicating themselves to the re-examination of values and the restatement of principles. They deserve our highest expectations, and they form a rich source of unused talent yearning to be challenged. The time, then, *does* seem right for a renewal of interest in the kinds of design problems raised by the West Front.

Others, though, will argue that the invention of new materials (reinforced concrete to replace marble) and the development of new construction methods (like mechanization at the job site) would necessarily render any new addition incongruous with the old. But one may wonder if this is really true. Wasn't Walter's selection of cast iron (a modern material in his day) over more traditional methods a luminous

proclamation of his faith in the belief that additions to older buildings need not necessarily preclude the use of the most up-to-date materials? As for those who, on the other hand, fear that architects' recent infatuations with glass, concrete and steel may have made the appearance of an altogether new West Front predictable, it should be pointed out that the radical demands of energy conservation have rendered that kind of predictability moot, and Walter's thick walls and small windows might not prove to be so obsolete nowadays after all.

Still others, though, will argue that certain aspects of architecture—those mainly concerned with detailing—are now taboo because of the lack of skilled labor. This argument is well known, somewhat worn-out, and needs to be examined. If one assumes that skilled labor has been spoiled by the use of mechanical tools, one has only to look at the remarkable degree of richness and delicacy that users of a plain saw were able to achieve—*mechanically*—in the era of "carpenter gothic" to realize that such notions as delicacy, intricacy, richness, and detail need not depend on the human hand. Any architect, too, knows perfectly well that success in the implementation of *any* design—however elaborate or austere—always depends on the skill of the individual workman. And skilled workers do exist.

Another, and perhaps better founded, fear lies in people's lack of confidence in the Congress's ability to act wisely in architectural matters. Being its sole judge on Capitol Hill, it has to bear the blame for such massive errors as the Rayburn Building—a building, incidentally, designed by an architectural firm that can claim credit for many decent buildings. Yet, in spite of such distressing thoughts, there are still signs of progress, as slow and timid as they may appear. The new Dirksen building represents a definite improvement over the Rayburn debacle, and Senator Baker's recourse to open hearings was a historic step in the right direction. There are to be found among Congressmen good and well-intentioned minds interested in architectural matters, and efforts should be made to elicit their support for action, to develop their active participation in debate, and to encourage them to seek advice from well informed sources.

### Completing Walter's scheme

Congress, though, might well wish to consider

another option, that of completing the West Front of the Capitol along the lines of Walter's design, either in faithful or general accordance with the plans he prepared at the time of the construction of his central dome. Four versions of his concept are preserved, one consisting of an ample pediment resting upon a broad set of regularly spaced columns aligned with an intercolumniation similar to that of the wings.

The advantages of pursuing such an option are evident in that they would effectively dispose of the delicate and always arguable question of compatibility between the new and the old. In other words, it would be stylistically safe. It would present the argument, convincing to many, that such a drastic series of transformations as Walter's deserves to be completed. Historical precedents may indeed be rare, if any, for the completion of an architectural project exactly as intended over a century later. That no such feat comes readily to mind does not necessarily mean that it should not be attempted today, at a time when systematic restorations are becoming so fashionable and when the architectural profession is at last beginning to awake from forty years of denigration of classical thought.

Such a course also would not be likely to arouse the ire of landscape architects, whose conservationist members would be satisfied that the original Olmsted terraces—purportedly conceived by Olmsted to accompany Walter's proposed new West Front—could be preserved, in spite of the odd and somewhat disturbing relationship of its pair of monumental flights of steps with the north and south corners of the central part of the West Front.

### Restoration

Congress can, finally, fall back to the safest of all positions, keeping things as they are. It can undertake the necessary, if expensive, repairs to ensure the stability and maintain the appearance of the West Front and its terraces as they now stand. While such a solution would follow the recommendations of the AIA task force and indeed would please all historians and espousers of history, it would also have several serious disadvantages.

The first is that it would take on all the attributes of a final solution, closing the door—perhaps forever—on any further change. The Capitol grew as the nation grew until 1891; since then the nation has continued to grow, but not the Capitol. What does 1891 represent



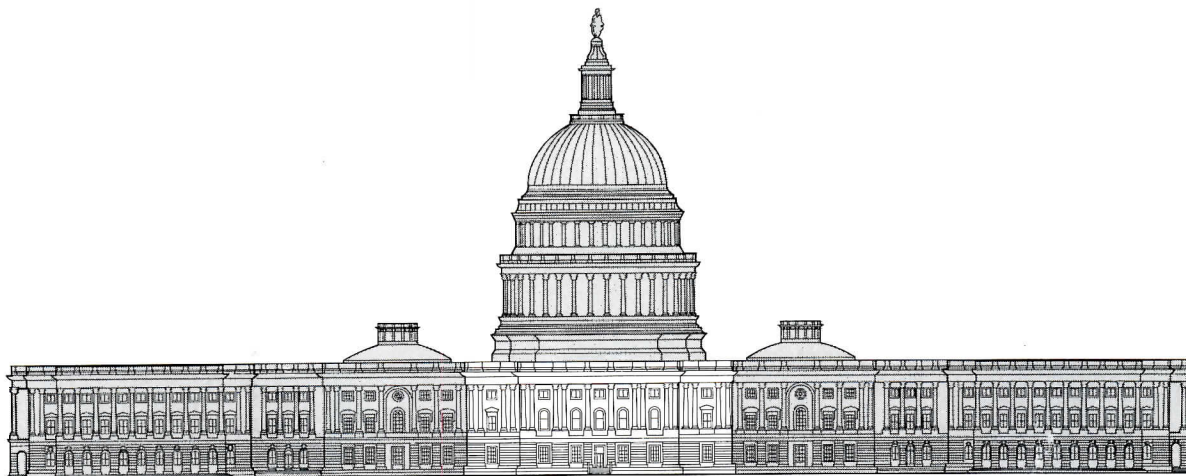

The West Front as it exists today

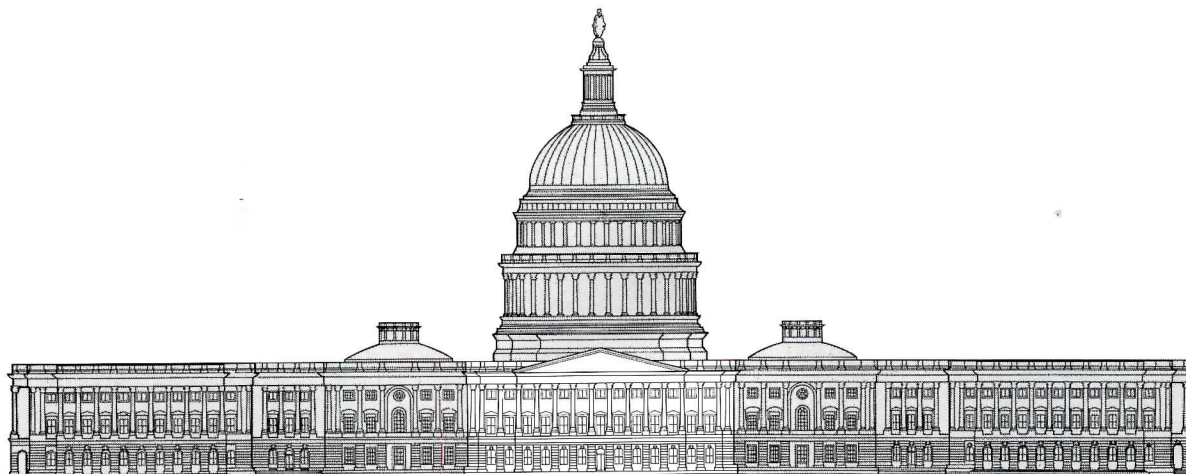

The West Front with Thomas U. Walter's design for the central wing

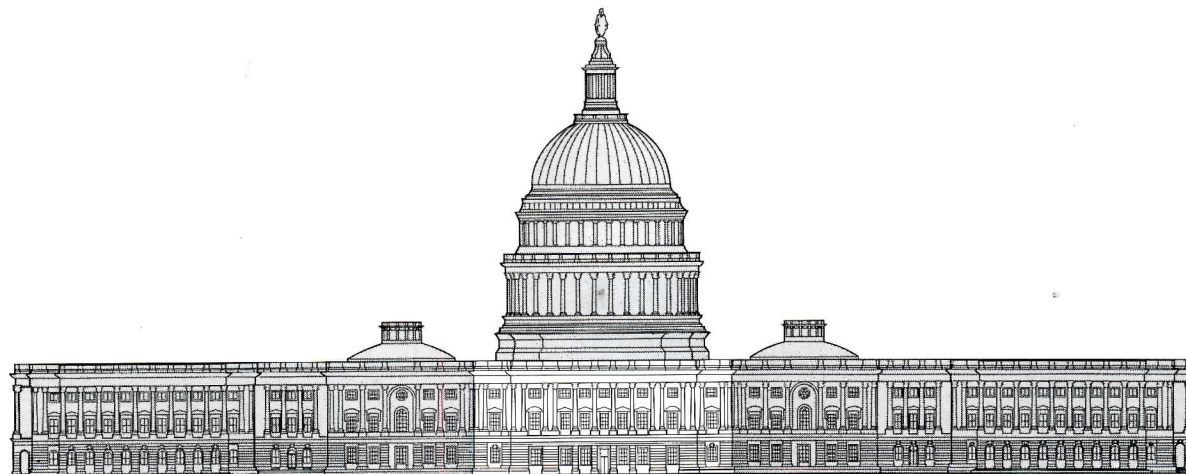

The West Front with an extension proposed by the Architect of the Capitol

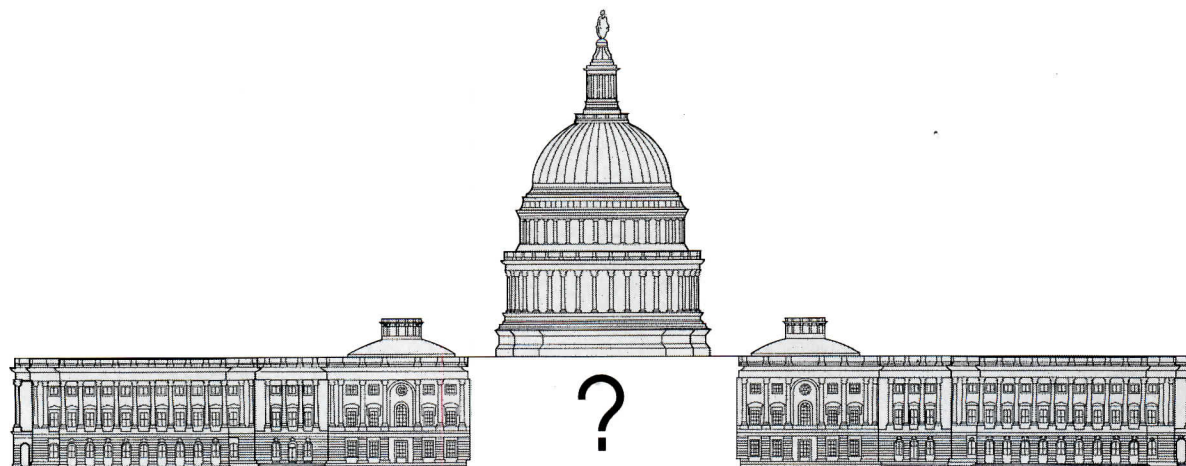

symbolically? Why should the Capitol be frozen to its 1891 configuration? Why should it not be seen for what it is: an unfinished building? One could convincingly advance the theory that the preservationists' desire to stop the growth of a building whose tradition has been one of growth is itself an untraditional gesture.

Another disadvantage is that restoration of the West Front would restore something of dubious architectural merit. Proponents of restoration—many of them architects and architectural critics—do not seem at all disturbed by the shocking anomaly of placing such a gigantic dome and broad drum on top of so narrow a portico. As for Bulfinch's West Front itself, it displays one of what must be the most peculiar intercolumniations to be found in the history of colonnade treatment. A shrunken version of his Massachusetts State House, it may appear original to some, quaint to others, but it can with certainty be stated that there is nothing classical about it. Also perplexing is the length of the portico. Why does it not cover almost the whole extent of the facade in the manner of Walter's East and West wings? The overall timidity of Bulfinch's statement leads one to believe that he chose to treat the West Front as a "garden" or back facade—a mere plan envelope punctuated by the quiet accent of an unassertive and therefore small portico. But, in any case, the sheer bulk, the height, and the over-all size of Walter's additions make all such considerations completely academic.

Another question is that of "history." As far as the West Front is concerned, no one seems to be able to name any event of historical importance that ever took place there—aside from the well known encounter between Daniel Burnham, the architect, and Alexander J. Cassatt, the president of the Pennsylvania Railroad, which resulted in the latter's agreeing to remove his terminal from the Mall and the former's winding up with the commission to design Union Station.

So what is it that the preservationists want to preserve? If Bulfinch's portico is still standing, even precariously, his dome is gone. The stone used in the columns, perhaps the result of the energetic lobbying of some congressman pleading for a constituent, is of inferior quality. It has now been painted twenty-seven times. And so one may well ask what is authentic here? The original stone, replete with political overtones, or the paint? Should one try again

to reopen the original quarry or reproduce the exact color of the very first coat? Are such pursuits warranted or even defensible? If painting the West Front in the original color is justified, what difference would it make if the paint were applied to concrete rather than to a stone of inferior quality? Is it historically sensible to adopt forever a painted solution, devised, after all, as a palliative? If so, then the advocates of paint, praising the charm of its mellowness, might well be advised, historically speaking, to start a campaign to paint over the central part of the new East Front replicated in 1961 in marble, since this, too, was a facade that had traditionally been painted.

The restoration of the West Front, then, is really very hard to defend on historical grounds, and, more generally, it is difficult to escape the conclusion that the forces for preservation in America—whose voices were once, and still are, urgently needed in the face of the mindless destruction of fine buildings from the past—are themselves becoming erratic in their judgment of what is worth preserving and seem to be carried away by an almost hysterical urge to oppose any alteration of any kind.

The automatic enthusiasm of so many architects and architectural historians for preservation nurtures the horrifying doubt that the profession of architecture might not feel up to the task at hand. It nurtures as well the serious implication that there is no one qualified enough to speak out appropriately in the West Front controversy, and that therefore no one should have the affrontery to utter any negative statement about so sacred—and therefore untouchable—a building as the Capitol. Thus what Latrobe dared to do to Thornton's design, what Bulfinch did to Latrobe's intended West Front, what Walter did to Bulfinch's dome and was about to do to Bulfinch's West Front—what, in other words, a succession of architects has done—would be precisely what our own generation, strangely lacking in self-confidence, would not have had the nerve to do. Where, after all, would the architectural world be today if Bernini had refused to add to the facade of a Maderna who had not hesitated to demolish a facade by Michelangelo, who had not considered it below his dignity to build a dome on top of foundations by Bramante?

What kind of strange veil of timidity seems to have spread over architects? Could it be that the generation of architects involved in the

West-Front controversy was brought up so strictly within the confines of the negativist, anti-classical tenets of the Bauhaus, that it therefore feels neither inclined nor even capable of responding to the challenge at hand? Could the preservationist vendetta, in other words, be the Bauhaus's most ironic legacy?

Or, on the other hand, could it be that people nowadays are simply afraid to speak up? Architecture used to be read as an open book by laymen and professionals alike. When architects criticized architecture, they addressed themselves to a subject they knew. But lately the business of architects criticizing other architects has come to seem a little ungentlemanly, even unethical. As a result, the activity has been turned over on a platter to architectural historians and their offspring, architectural critics. Thus even so perceptive a critic as Ada Louise Huxtable has written of the Capitol—persuasively and, it has to be argued, mistakenly—that "the rationalization of would-be 'improvers' that they could fix up some alleged 'incorrect' features of this historic facade . . . is monstrous arrogance."<sup>2</sup> And a respected professional like George Lewis, executive director of the New York chapter of the AIA has written, "The idea that anyone in 1977 can arbitrate what is and is not correct about the architecture of the Capitol is just as outrageous as would be a proposal to iron out the asymmetry of Chartres Cathedral."<sup>3</sup> What could be behind such pronouncements, if it is not the fear that whoever touches the Capitol will make a mess of it? This ought not to be, and is not, an admissible proposition. The comparison, too, between Chartres and the United States Capitol is at very best irrelevant, for it altogether misses the central point. Chartres has stood for centuries as a complete symbol of its age. The Capitol has not, for its age still lives.

Jean Paul Carlhian is a practicing architect in Boston and a graduate of the *École des Beaux Arts*; he has long been interested in classical architecture in general and in the design of the U. S. Capitol in particular.

#### Footnotes

1. Senate Hearing before the Committee on Appropriations, Legislative Branch Appropriations for Fiscal Year 1978, Tuesday, June 14, 1977, pp. 1214, 1210, 1203.
2. *The New York Times*, July 4th, 1977.
3. *The New York Times*, July 2nd, 1977.



AN  
ART CENTER  
BY  
EDWARD  
LARRABEE  
BARNES

There are some buildings which could only be the way they are—or so they appear. Every choice that went into their making seems to have been inevitable, correct, allowing no alternatives. Edward Larrabee Barnes' Visual Arts Center is such a building. One can imagine ways other fine architects might have added a wing to this particular McKim, Mead and White building on this particular campus—because of course Barnes' solution is not really the only one possible. But it shows his special ability to find solutions for complex problems which seem altogether simple and right.

"The old campus of Bowdoin College is even prettier than Harvard Yard" says Edward Larrabee Barnes. He is an architect for whom words like "pretty" come naturally and whose own work calls forth words like "graceful" and "elegant." When Barnes talks about the Visual Arts Center at Bowdoin he has little to say about its cost, mechanical system, structure, acoustics, lighting—aspects of the building which nonetheless clearly consumed his attention because they are so well resolved. An engineer and cost accountant by necessity, he is nonetheless an architect who thinks and feels like an artist. He prefers to talk about his search for the kind of symmetry, proportion, mass and scale for the Visual Arts Center which would be in harmony with the buildings that surround it.

As an artist first and foremost, Barnes belongs in the company of the great architects who have built on the oldest quadrangle of the campus. They are the Neo-Classicists McKim, Mead and White who designed the Colonial-Revival Walker Art Museum which the Visual Arts Center adjoins, and the Romanticist Richard Upjohn whose Early American Gothic Revival chapel the Visual Arts Center axially confronts.

The Walker Art Museum is similar in design to one of McKim, Mead and White's masterpieces, the Morgan Library in New York and is a beautiful building in its own right. It has the same Palladian references as the Morgan. Both the Walker and the Morgan are entered through a *serliana*, or loggia derived from Palladio's Basilica in Vicenza and both are graced by a dome. Barnes was originally requested by Bowdoin to design the proposed Visual Arts Center as a wing added to the symmetrically perfect Walker. He indeed made the connection—but invisibly, underground.

Richard Upjohn's simple, picturesque and rustic stone chapel at Bowdoin is one of the oldest buildings on the campus. It is on axis with the main gate. The path from the chapel across the quadrangle and through the gate is a ceremonial passage for the graduating class and for wedding and funeral processions. Barnes' new building bridges the path.

The old quadrangle itself is filled with ancient elms and covered by a canopy of

branches and leaves. It is defined by buildings of congenial height and massing, separated from each other by distances roughly equal to their lengths. It is a fine campus of the kind only to be found in the United States and not at all similar to the closed quadrangles of Oxford and Cambridge or universities on the Continent.

"I love this campus," says Barnes. "The buildings make the quadrangle seem like a great room, but because so much space is squandered between each building you can look through it in all directions. Originally I was expected to hook the new building onto the McKim, Mead and White structure. I insisted that it had to be one more separate building and not a wing, to respect the open-close, open-close perimeter of the quadrangle.

"I am told that I should feel guilty for always creating symmetrical buildings, but this time I have no guilt. Symmetry was absolutely essential. The formal balance of the Visual Arts Center conforms to the classicism of the Walker Art Museum, but the real reason for the symmetry was the necessary placement of the building on the axial path bisecting the main gate to the campus at one end and the Upjohn chapel doorway at the other.

"My big decision was to design the Visual Arts Center around a daylighted, unheated walk-through space that preserves and enhances the ceremonial walk. Le Corbusier's Carpenter Center at Harvard is the first building I ever saw where a campus walk is taken through and out again. On your way you can see the students at work through the glass walls. I knew that something like it would work at Bowdoin."

As the plans indicate, the walk-through opening fans out almost at once, echoing the diagonal campus walks and allowing a wide yet framed view of the quadrangle during the brief passage through the building. The walk-through is completely open in good weather, but can be closed in winter by an ingenious system of custom-made wooden doors. These are the most complex of the building's many elegant details designed by Barnes' associate Alistair Bevington.

As can be seen on the site plan (below) the facade facing the quadrangle lines up exactly

with the facade of the Walker Art Center, the projections of Gibson Hall and the setback of the Searles Building. Thus Barnes respects the long-established perimeter of his side of the quadrangle.

The cornice of the Visual Arts Center lines up with the underside of the cornice of the McKim, Mead and White building. Barnes made the width and depth of his building roughly the same as that of the Walker, so that "these two blocks as masses seen in moonlight without detail would share the same density, the same stance."

The facade which faces the main campus gate (cover and below) has a high studio window as wide as the entrance to the walk-through. Its width in turn is established by the distance between the Doric columns of the gate. The austere shapes and elegant proportions of the high window and the entrance below, juxtaposed against the ornamental columns, form a campus entrance of great subtlety and sophistication.

The Visual Arts Center is easily recognized as a work of Barnes and no one else. What makes it so unmistakably his, however, can not be explained by his method of problem solving as he describes it. Although Barnes' attempts to explain his buildings tell us very much about them, they also tell us very little, for like most architects he does not talk about the way his work expresses his nature, nor may he have much of an idea how it does.

Since Barnes is an architect who is also an artist his work must indeed express his nature. His buildings seem to be the work of a spirit which rejects the spontaneous, the accidental, the capricious and the unessential, and thereby achieves an architecture of great reticence and repose. —*Mildred F. Schmertz*

VISUAL ARTS CENTER. Bowdoin College, Brunswick, Maine. Architect: *Edward Larrabee Barnes*—associate: *Alistair Bevington*; project architect: *Demetri Sarantitis*. Consultants: *Zoldos-Silman (structural)*; *Hannaham & Johnson (mechanical)*; *Donald Bliss (lighting)*; *Nicholas Quennell (landscape)*; *Donald Wolf and Company (costs)*. General contractor: *Davison Construction Corp.*

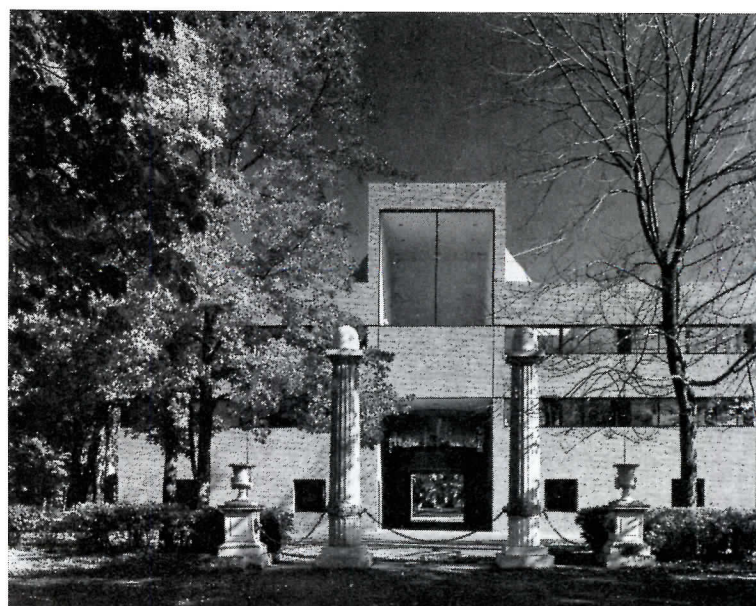
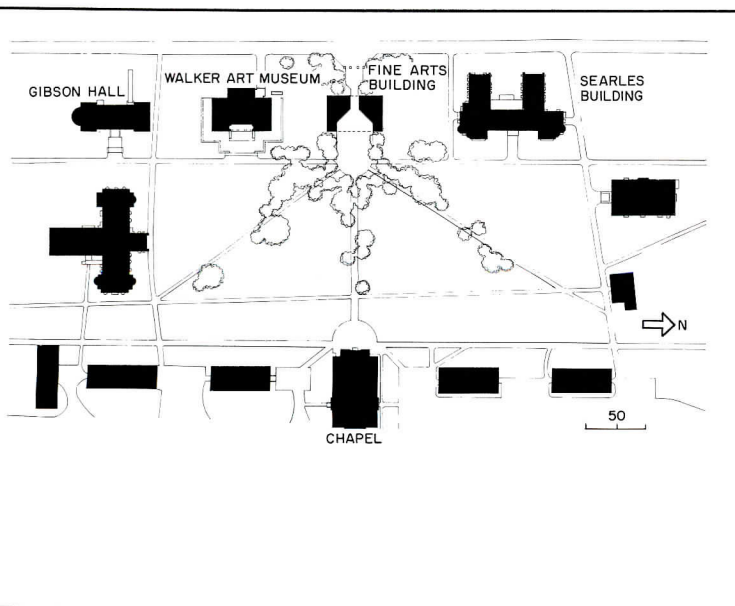

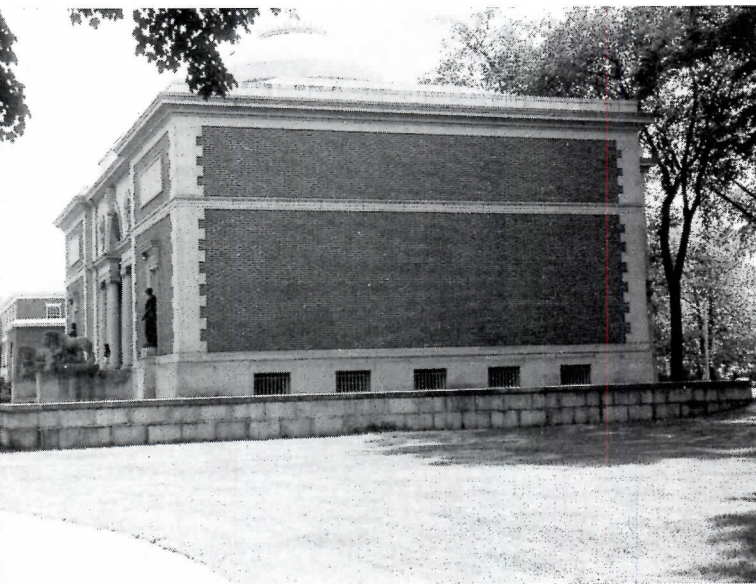

Edward Larrabee Barnes



The plan of the old quadrangle (far left) shows the axial relationship between the Visual Arts Center and the Richard Upjohn chapel (left). On the opposite page is the entrance gate facade. Shown above are views of the Walker Art Museum, and the Searles Building. Because Barnes believes that the individual buildings that define the quadrangle are in very good scale to each other, he made the Visual Art Center approximately similar in size and massing. Above ground and visible are three stories, the first containing classrooms, the second a library and offices and the third a high-ceilinged, skylit studio. Other spaces are below ground (right). A new lawn has been created above ground.

BASEMENT

The basement plan shows the underground link between the Visual Arts Center and the Walker Art Museum. The shaded areas indicate offices and workshops. A new gallery links the museum galleries with the new auditorium and stage. The Y-shape echoes the walk-through at the ground level above. The auditorium, gallery and student workshops beneath the brick paving and lawn are roofed over with exposed long-span, precast concrete tees. The all concrete structure stops at grade where the steel-frame superstructure begins.

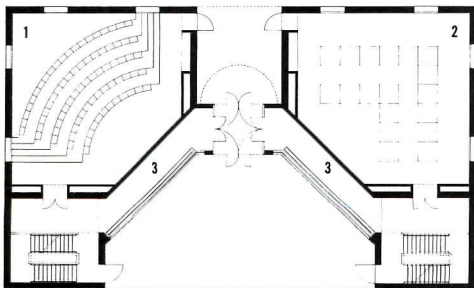

FIRST FLOOR

1. Eighty-seat classroom
2. Picture study room
3. Gallery

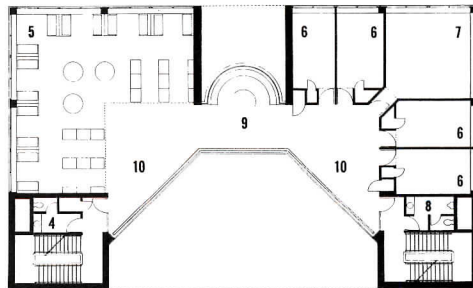

SECOND FLOOR

4. Women's room
5. Library
6. Office
7. Seminar
8. Men's room
9. Lounge
10. Secretarial

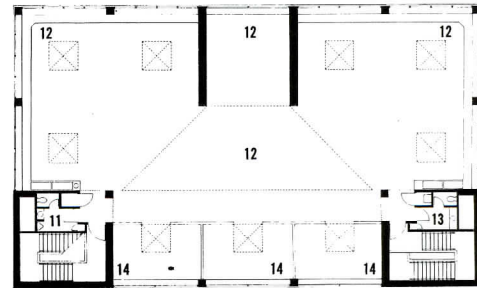

THIRD FLOOR

11. Men's room
12. Studio
13. Women's room
14. Private studios

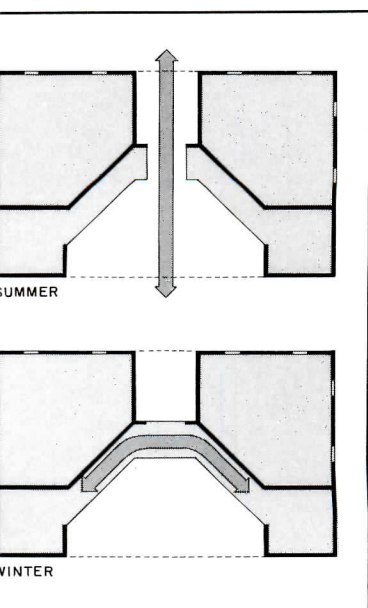

The water-struck wood-fired "Eno" brick is from the same lot used by Louis Kahn on his Exeter College Library in New Hampshire. It is close in texture and color to brick in the adjoining Walker Museum. The large areas of fixed glazing on the walk-through (above and opposite page) increase the transparency of the building in both directions on the chapel axis. The second floor is the most transparent. From the library lounge (above) the paired Doric columns of the entry gate are visible through the glass semi-circle looking west. The lounge has uninterrupted glazing to the east as well opening up the view to the quadrangle and chapel. The specially designed doors (right) pivot to close the passage in winter. This detail was difficult to work out. The success of the entire concept, however, depended upon the correct design and construction of these doors.

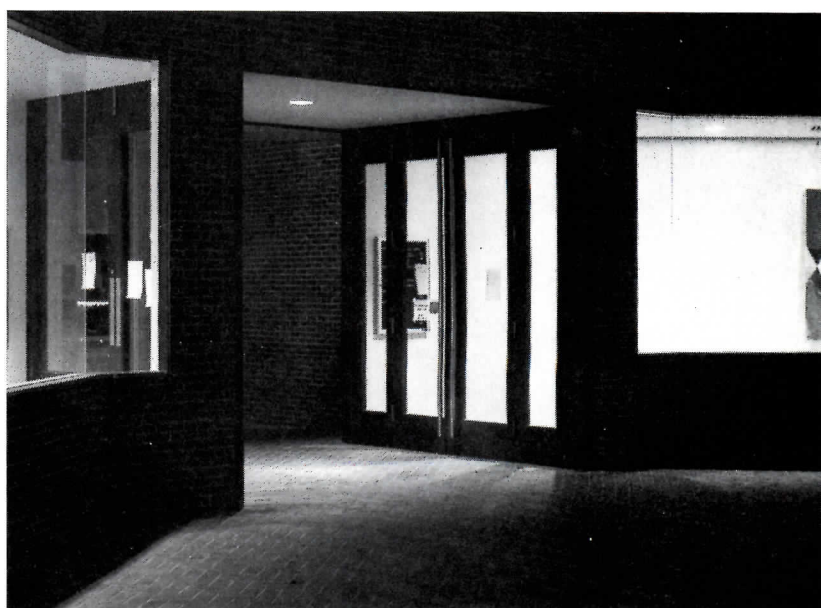





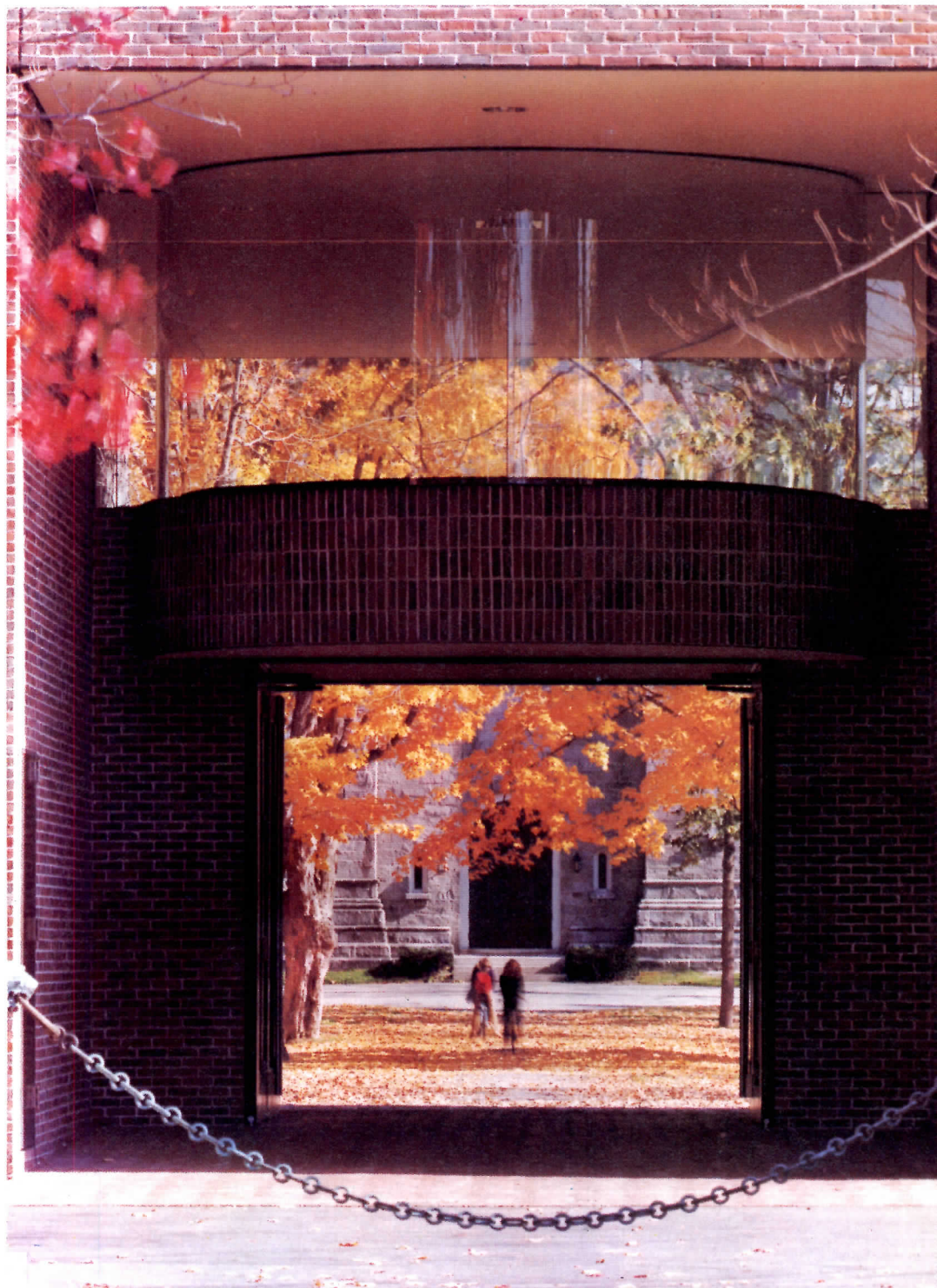

*The proportions of the Visual Arts Center appear to be generated by Barnes' intuition rather than by any mathematical formulas. His vocabulary of materials and forms is austere, but paradoxically the building seems almost luxurious because of its superb detailing. The brick is used in three ways—in a herring bone pattern on the ground, a running bond for the walls and in a soldier course to help articulate the semi-circular curve of the library lounge (above). The lounge is glazed on both sides increasing the transparency of the opening. The deep overhangs and old trees shield the interiors from glare. The paintings in the gallery space to the left and right of the walk-through announce the building's function as an art center, and bring the vibrancy of contemporary artistic life to the 19th-century quadrangle.*





*The dramatic height of the centered studio window, which on the exterior so dramatically reinforces the entrance to the Visual Arts Center and the campus beyond, enhances the main studio (left) as well. The Y-shape used in the basement and the first and second floors of the structure also appears as a ceiling form on the studio floor. It becomes a tilted trapezoid which makes the transition from the high ceilinged rectangular volume at the window to the lower ceiling of the surrounding studio. Beyond this trapezoidal hood, the studios are well lit by skylights. The main studio is one big flexible space with ample windows shaded by the huge elm trees which surround it. The perimeter wall of the studio is lined with storage cabinets under a continuous work ledge at the window sill.*



*If the Visual Arts Center were sited on a treeless plain it would not satisfy us as completely as it does planted here among Bowdoin's stately elms. A denial of nature and the ornament derived from it is part of what abstract architecture and painting are about. Piet Mondrian never faced the sidewalk when sitting in a cafe because he did not wish to look at the people and trees. People who live in rational, abstract spaces, however, tend to fill them with plants, and buildings purified of ornament and caprice tend to look better among trees. Barnes' building looks wonderful at Bowdoin, but in this instance it is no accident of nature. Barnes designed the Visual Arts Center so that the elms would be its ornament. From inside, framed by the huge windows they are living wall decoration. Outside they shadow, dapple and soften the plain brick surfaces.*

# SHOPPING MALLS IN THE CENTER CITY

The most recent trend in shopping center development has been the design of retail complexes in the downtown area. Regardless of the size of the community, many of these inner city business districts have suffered decay over the past years when the regional shopping center flourished. Some cities have tried to turn the tide of this degeneration; the ones shown in this Building Types Study have succeeded in beginning their commitment through the construction of special urban retail complexes. Commercial construction is estimated to rise 17 per cent over 1977 (according to Dodge/Sweet's 1978 Construction Outlook) and much of this will no doubt be similar in nature to the center-city redevelopment exhibited here. —*Janet Nairn*



## DRAMATIC SKYLIGHTED GALLERIA CREATES NEW SHOPPING EXPERIENCE IN TORONTO

Toronto's newest center city development is also the city's most tremendous new shopping experience. A vast multi-level complex with a parking garage, an office tower, a major department store and myriad number of smaller shops now exist. A yet-to-be-constructed second phase (with an expected Fall 1979 completion date) will add another 125 shops, office tower and complete the link-up of the Centre to all transit facilities. Eventually more than 3.2 million square feet—over 15 acres—in the heart of Toronto will be developed through an imaginative design solution that will cost \$250 million.

The site is a five-block area of prime real estate in downtown Toronto, owned by The Eaton Store Company. The surrounding streets are filled with stores and shops and businesses which have been drawing people for years. At the northern end of the site and anchoring the complex is a high-rise office tower (called Number One Dundas) and the Eaton's Store.

Stretching from the store through the middle of the site is a linear shopping complex.

The architects' idea was to create an enclosed shopping area rather than an arcade-type exterior—with the same vigor and sense as the Galleria in Milan.

The Galleria mall stretches 860 feet, varying from 28 to 56 feet in width and is 90 feet high, topped by an immense arched skylight. Five floors of commercial rental space rise on each side of the mall floor (which is the main level, equal to the street elevation). Below this mall level are two other shopping levels, and connections to the subway system. Interior landscaping includes trees and park-type benches. Elevated walkways connect each side of the mall, and a variety of niches were designed where persons could overlook the mall and its activities. Street lights, awnings, bold graphics and patterned floors complete the character and individuality of the levels.

The new Eaton's store is the "flagship" for

the company and is the commercial symbol of the Centre from the street. Its main entrance was set at a diagonal to the corner of a main intersection adjacent to the office tower and constructed of glass that steps down to the sidewalk. This creates an exciting entrance from the street, but is even more dramatic from the interior as a unique lightfilled rotunda. The use of glass also carries forth the design theme of tiered glass entrances around The Galleria and the skylight itself. A carefully delineated exterior for The Eaton's Store (not shown) provides an arcade at street level that protects pedestrians from the weather and shades display windows, and complements the design of Number One Dundas office tower.

The Eaton's store was also designed in an L-shape around several existing buildings that will not be demolished—Trinity Square with its historic Holy Trinity Church, Scadding House and old parsonage. The Square holds a prominent position in the five-block development



Ian Samson photos



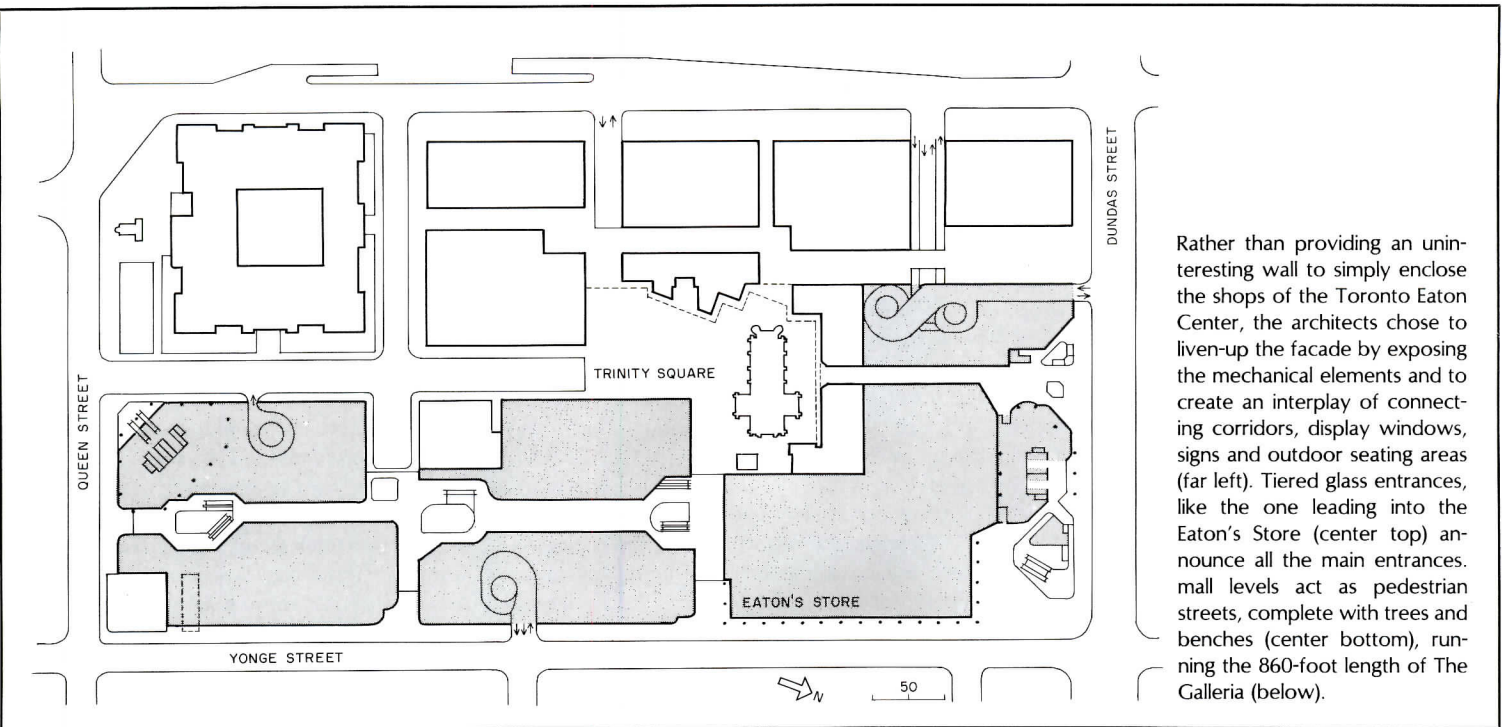

Rather than providing an uninteresting wall to simply enclose the shops of the Toronto Eaton Center, the architects chose to liven-up the facade by exposing the mechanical elements and to create an interplay of connecting corridors, display windows, signs and outdoor seating areas (far left). Tiered glass entrances, like the one leading into the Eaton's Store (center top) announce all the main entrances. mall levels act as pedestrian streets, complete with trees and benches (center bottom), running the 860-foot length of The Galleria (below).



area and the decision to retain the low-rise buildings is not only a benefit to the city but to the complex, adding a highly individualistic visual element that could not have been otherwise achieved. The Square can be viewed from restaurants and upper level corridors of the shopping areas. Its open plaza has also been used to announce one of the three major entrances into The Galleria.

One of the initial problems facing the design team was an 18-foot elevation drop from the north to the south ends of the site. Instead of sloping the levels parallel to the grade, the malls were angled slightly in the opposite direction. While this tended to create a problem of "level orientation" for users it did allow for fewer level changes, prevented secondary and possibly unusable spaces and permitted each level to directly connect to a subway or street or both. Two major vertical circulation cores presently exist—the Trinity Square entrance and the major east-west connection called Albert Way.

Albert Way is a pedestrian extension of Albert Street closed for development of the

Centre. Tiered glass enclosures mark each of these entrances and will also highlight a third major entrance to be constructed later.

One of the key factors influencing the design was the site's accessibility to all forms of transportation. The project connects to the subway system, and to streetcars and buses. Two parking garages will handle 1,600 cars; and at least one pedestrian walk bridge will be constructed to one other major store.

The exterior is constructed as a steel frame hung by tension cables from double columns. In an effort to "maintain the scale and spirit of the street and avoid a building that by its length and size could look like an institution" says design architect Eberhard Zeidler, "we fit a variety of stores into this light framework, allowing individuality and complexity."

Despite the enormity of the complex, there are an additional four acres for future development. In order to permit future flexibility, one of the two parking garages has been designed for conversion into commercial space, the building has been structurally readied for the addition of mezzanines, the

roof has been designed to permit a garden apartment/hotel on one portion and a cabaret or arena on another portion, and provisions have been made for a third office tower.

TORONTO EATON CENTRE, Toronto, Ontario, Canada. Owner: *The Cadillac Fairview Corporation Ltd./The T. Eaton Company Ltd./The Toronto-Dominion Bank*. Architects: *Zeidler Partnership/Architects and Bregman & Hamann—Sidney Bregman, coordinating partner; Eberhard H. Zeidler, design partner*. Engineers: *C.D. Carruthers & Wallace Consultants Ltd. (structural); H. H. Angus & Associates (Office Tower and Dundas Mall mechanical/electrical)*. Consultants: *Rolf Jensen & Associates Ltd. (fire safety); National Planning Inc. (parking)*. Construction management: *The Foundation Co. of Canada Ltd.*

THE EATON STORE. Architects: *E. L. Hankinson (chief architect with Eaton Store); Parkin-Millar & Associates (associated architects); Bregman & Hamann (consulting architects and structural engineers)*. Engineers: *Ellard-Willson Associates Ltd. and H. H. Angus & Associates Ltd. (mechanical/electrical)*. Fire safety consultants: *Rolf Jensen & Associates Ltd.* Construction management: *Eastern Construction Co. Ltd.*





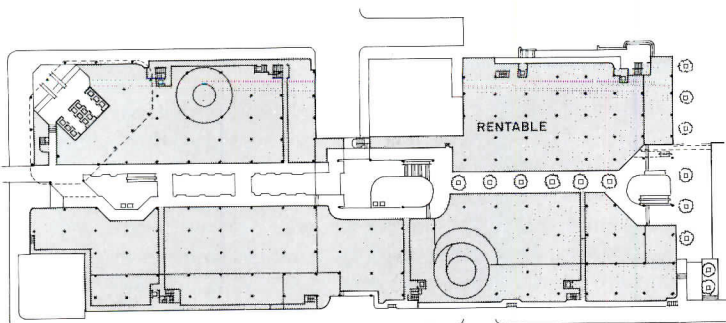

MALL LEVEL "c"

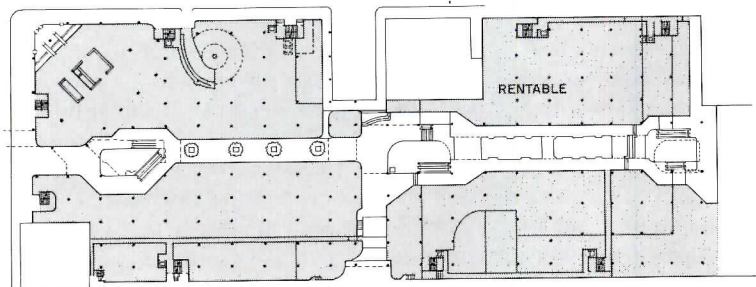

MALL LEVEL "B"



An integrated circulation system was devised that connects the stair/escalator core at the entrance to Eaton's (left) and its mezzanine restaurant (middle right), to the glass-tiered entrance off Trinity Square (above), elevated to the bridges throughout The Galleria (top right) and to the perimeter corridors (bottom right).

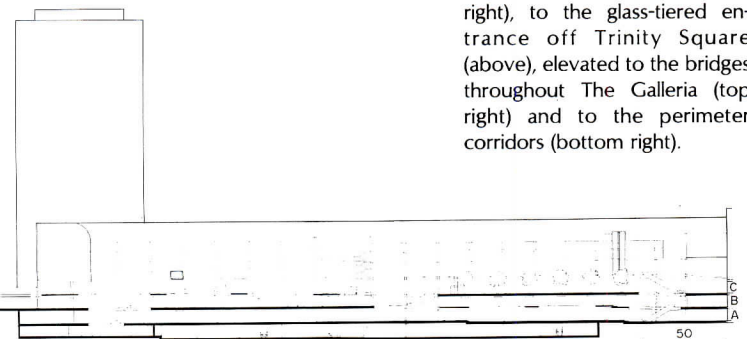

## METROPOLITAN SHOPPING COMPLEX IN SALT LAKE CITY IS KEY TO REDEVELOPMENT

The completion of the ZCMI Center in downtown Salt Lake City is one of the largest retail/office complexes in the country to be privately owned and developed; done so by the Zions Securities Corporation, the commercial real estate arm of the Mormon Church. ZCMI (Zions Cooperative Mercantile Institution) was completed in 1977 at a cost of \$50 million after design had begun in 1962.

The Center occupies eight acres of a ten acre site in the middle of downtown Salt Lake City, in a area full of religious and business buildings. Across the street from the Center is Temple Square (the location of the Salt Lake Temple, Tabernacle, Information Center and Assembly Hall of the Latter Day Saints Church). Historic buildings that attract tourists are nearby, too, including the Beehive House and Lion House—homes of Utah's first territorial governor and church leader, Brigham Young. In the same area is also the Salt Palace convention, sports and exhibit center. These and other

shops and businesses have continually drawn people into the center of town.

Two million square feet of space are under one roof—450,000 square feet of which is occupied by the ZCMI Department Store that anchors the complex. Another 300,000 square feet of shops is distributed around the central mall. A 27-story office building is also part of the Center.

The project was shaped by its urban surroundings more than with other projects of this kind. Unlike city blocks in other cities, each one in Salt Lake City is an unbelievably large 660 feet square. The block selected for the Center is this size but it already had four existing buildings, one on each corner. The only space on which to build was between and around these buildings.

The architects designed a building that fills in the entire block, incorporating the existing buildings and converting the empty space in the center of the block into a mall. To create a

strong, expressive exterior that would tie the new and old buildings together visually, a concrete windowless exterior (except for a clerestory glass band) connects all buildings. The perimeter was set out-of-line with the older buildings' exteriors to offset the old from the new and give the appearance that the older buildings were recessed into the new complex. The new office tower was handled in the same manner to maintain the character of projecting and receding planes.

One of the four corner buildings is the ZCMI Department Store (begun in 1856 by Brigham Young as a merchants' cooperative to buy and transport necessary goods from the East). At the main street elevation there is a 100-year-old facade of historic value; it has been listed on the National Registry of Historic Places. Retention of the facade received public approval but it did not meet local building codes. This necessitated the removal of the elements, strengthening them and their re-



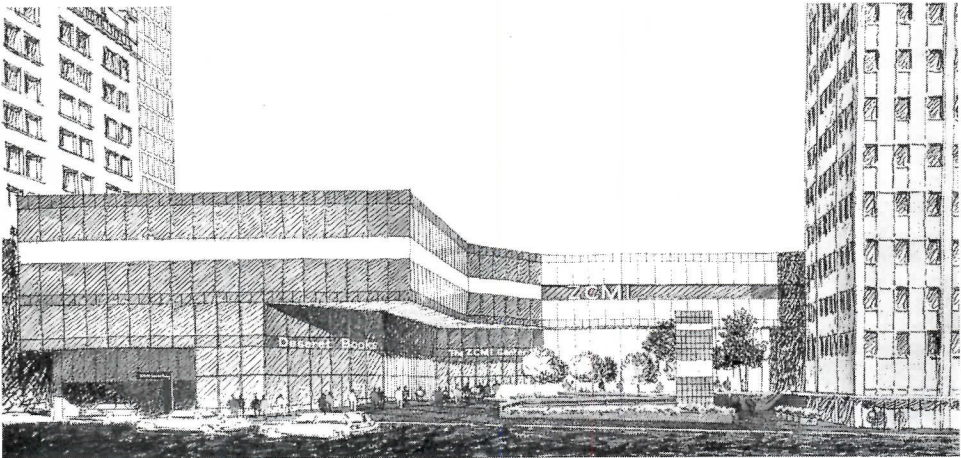
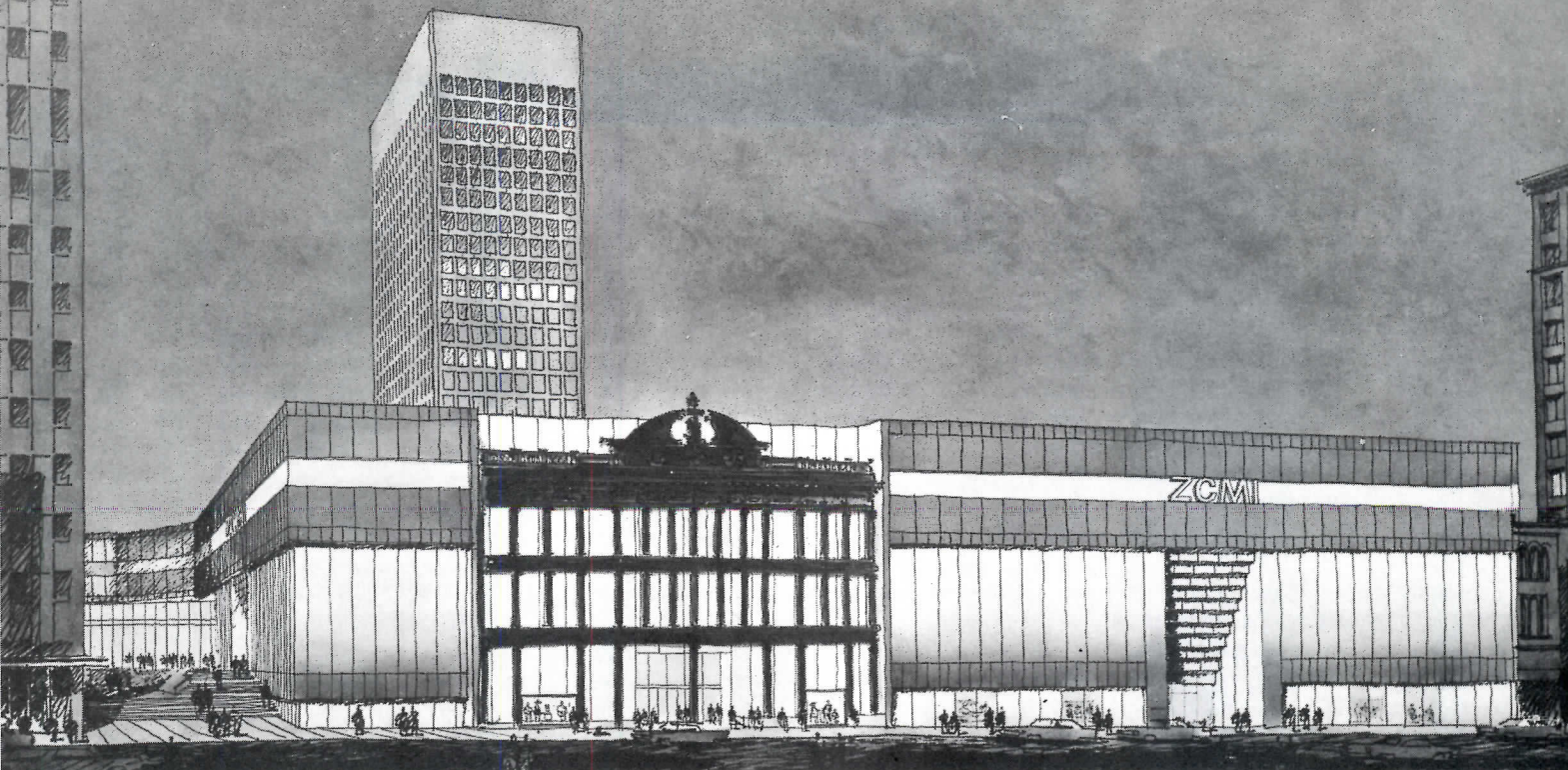

On a large site in the heart of downtown Salt Lake City (left) the ZCMI Center was developed. The initiative behind the Center came from the former president of the ZCMI Department Store, Harold Bennett, who believed in the necessity of a fully-developed retail complex. The plans which Gruen Associates designed initially in 1962 were not significantly changed through the ten year development period. A historic facade for the ZCMI Department Store was saved and installed on the Center's new exterior (middle right). An office tower (right) was included as part of the project, also owned by the Zions Securities Corporation, real estate arm of the Mormon Church.

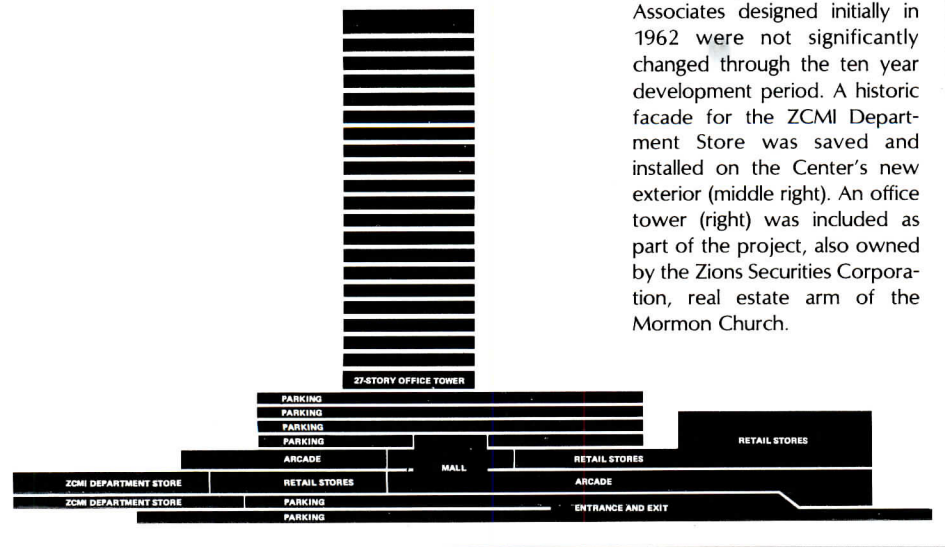

placement into the new exterior. Part of the facade was fashioned in cast-iron, part in sheet metal. The sheet metal section could not be preserved and the original cast-iron elements of the lower one-third of the front were lost after modernization in years past. The facade had been designed by engineer James Bogardus to be prefabricated and easily disassembled. This ease allowed for the saving of the elements. Under consultation and supervision of local architect Stephen Baird, knowledgeable in the restoration of historic buildings, all facade elements were removed from the original building, repaired, replaced and matched, and built into the new exterior wall. While this was happening, the interior of the store was also being remodelled—all while the store remained in operation.

What space remained on the site between the existing structures has been made into an enclosed two-level shopping mall, that runs through the center of the site in a jagged configuration. Access to the mall is only from three streets. Sixty-five stores are grouped around this mall, and additional stores and

offices are placed on the south and north streets.

Of paramount significance is the fact that the mall is sandwiched between parking facilities both above and below, making it totally inaccessible to natural light. From the project's inception parking had been a dilemma. A parking structure in the area thought to be usable by future ZCMI Center shoppers was demolished; thus the creation of on-site parking became necessary. The Gruen Associates' solution was to provide parking for 2,000 cars on six levels; four located above the retail mall, two below. In order to light the mall, a system of fluorescent lighting fixtures was custom-designed by the architects working with the fabricators, and set above opaque acrylic panels. This lighting system provides a continuous, luminous ceiling with no variation in light level.

Despite the number of shoppers who use the Center daily, there are no vehicular circulation problems in the area because the downtown streets are 132 feet wide. Local bus transit also connects with the Center.

Gruen Associates has had prior experience with this type of center city development, having designed the Midtown Plaza in Rochester, New York, in 1961. Even though the ZCMI Center has a unique set of problems, these were solved in initial studies and not changed over the ten years it took to develop the project.

THE ZCMI CENTER, Salt Lake City, Utah. Owner: *Zions Securities Corporation*. Architects: *Gruen Associates—Edgardo Contini, partner-in-charge; R. L. Baumfeld, principal-in-charge of design; Miloyko Lazovich, project designer; Mel Gooch, Sydney H. Brisker, project coordinators*. Architects for The ZCMI Department Store: *Chaix & Johnson Associates (interiors)*. Engineers: *Gruen Associates—Henryk Walocha (structural/electrical, mechanical for Center and The ZCMI Department Store); Store, Matakovich & Wolfberg (mechanical for office tower and central plant); Ralph Rollins (foundation/soils)*. Consultant for restoration of historical facade for The ZCMI Department Store: *Stephen Baird, architect*. General contractors: *Christiansen Brothers, Inc./W.W. Clyde and Company*.

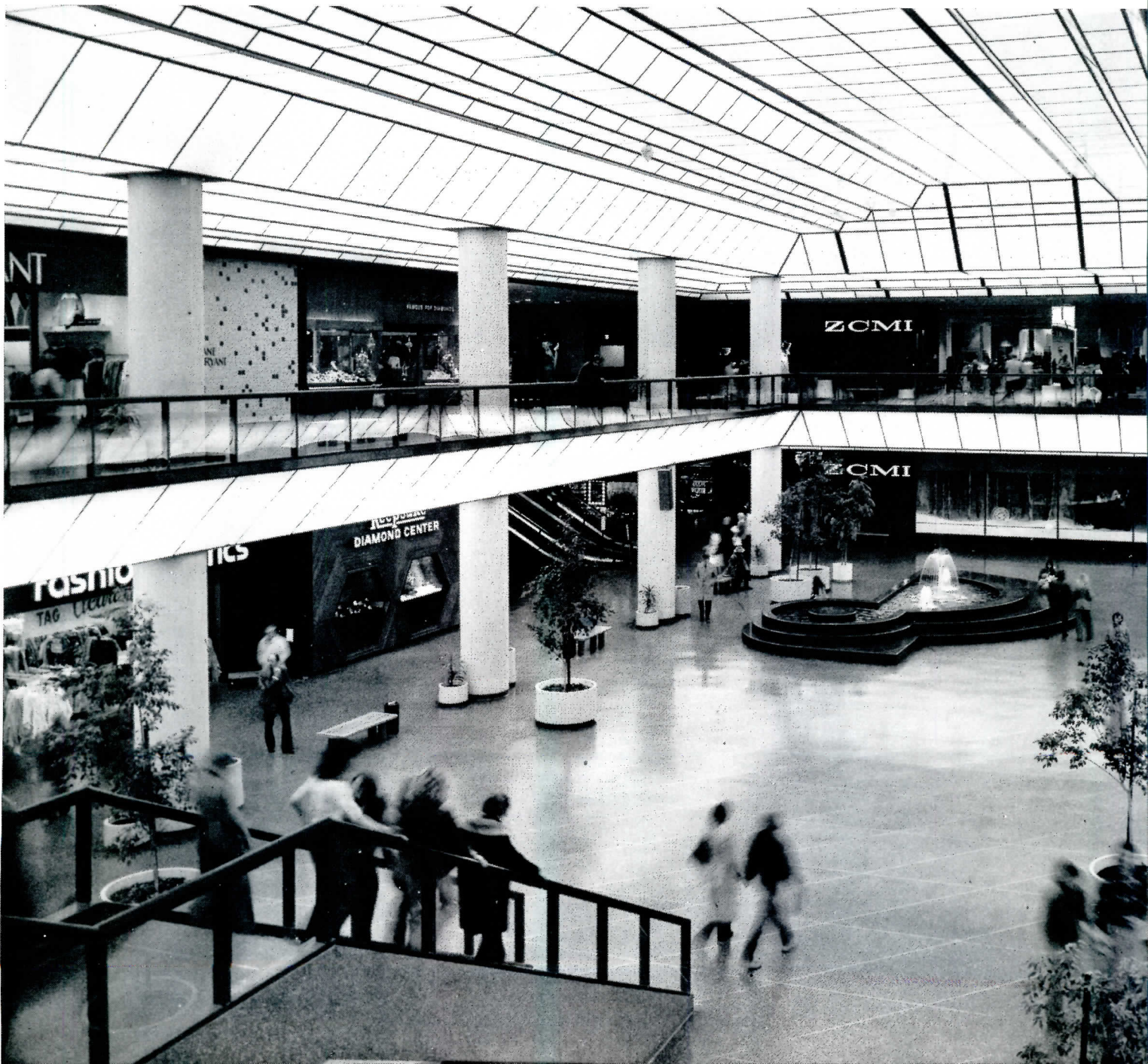

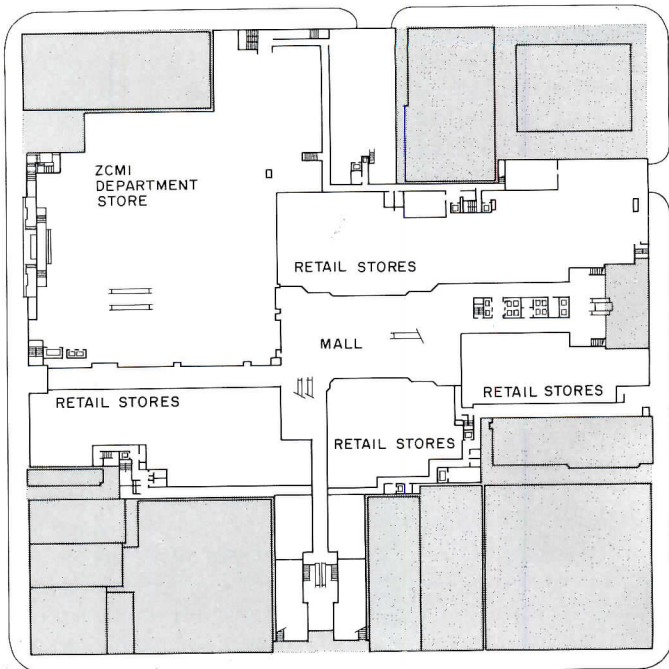

LOWER LEVEL

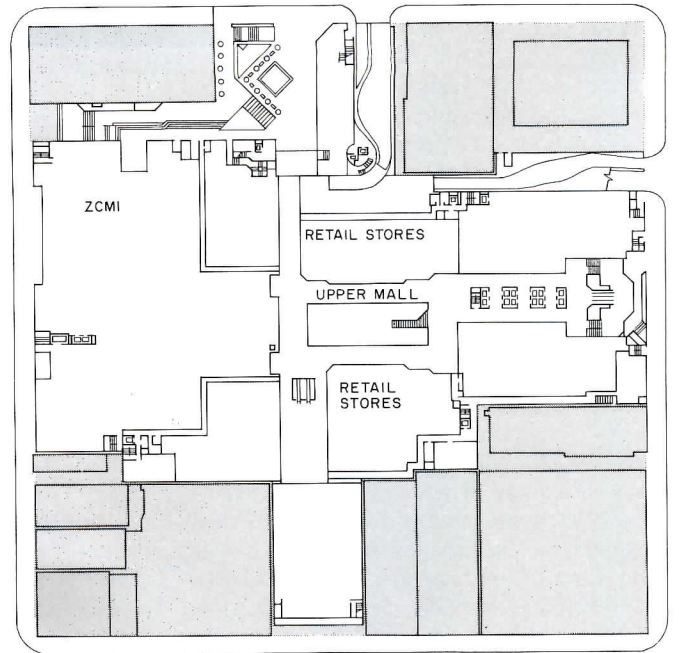

UPPER LEVEL



A two-level shopping mall was created from vacant space running through the center of the site. Parking levels were located above and below the mall, necessitating the custom-design of a lighting system that provides continuous luminescence. And in another instance of reuse of materials saved from the old ZCMI Department Store, columns were included in the design of the store's restaurant shown in photo (right).



Hal Rumel Studio photos except as noted

## SYMBOL OF NEW PHILADELPHIA IS URBAN CORE SHOPPING COMPLEX

Coming after 20 years of city planning, the successful design and completion of The Gallery shopping complex has started to turn the tide in redeveloping downtown Philadelphia. The Gallery consists of a four-level enclosed mall that is anchored by two large department stores and has over 200,000 square feet of retail space, connecting to all forms of transit. An interplay of landscaped courts and an intricately-planned circulation system have created a long overdue, exciting and bustling shopping environment.

As a crucial step in Phase One of the Market Street Redevelopment Plan, The Gallery is a living symbol of what can be. The Market Street Plan is an ambitious \$500 million long-range commercial urban renewal project—the brain child of the Philadelphia City Planning Commission—intended to transform five blocks of run-down century-old structures into a new shopping-office-hotel district. It would stretch along the northern side of Market Street

from city hall almost to Independence Mall. As early as the 1950s, plans were devised for improved transportation facilities and hook-ups between local and suburban rail lines. In 1960 the Market Street Plan was incorporated as part of the Planning Commission's comprehensive plan for the City. Later, financing was provided partially by a grant from the Department of Housing and Urban Development of the area, including Willo von Moltke, Romaldo Giurgola and Skidmore, Owings and Merrill. Bower and Fradley Architects won a design competition for The Gallery and are now coordinating architects for the master plan. (RECORD April 1974, pages 137-152)

Prior to this project, Bower and Fradley had designed an office building adjacent to the Market Street area called 1234 Market Street; some design principles of this building were carried forth into The Gallery, primarily a public hall with three-level rental space and connections to transportation.

The completion of the total Market Street East Plan is many years away but with the construction of The Gallery, the Redevelopment Authority and City Planning Commission are spurred on, preparing a land acquisition proposal for a neighboring block. By summer of 1978 plans could be underway for another retail complex to link with The Gallery. Construction of a commuter tunnel tying together the Reading and Penn Central lines and other subway lines is being organized.

The project is a joint venture of The Redevelopment Authority of the City of Philadelphia and Rouse Philadelphia, Inc. (a wholly owned subsidiary of The Rouse Company), even though complete ownership is retained by the Redevelopment Authority. In 1974 the City received and approval a proposal from The Rouse Company for the enclosed mall and the City Council approved a lease agreement with The Rouse Company, stating they would lease the building's shell for 99 years, and in

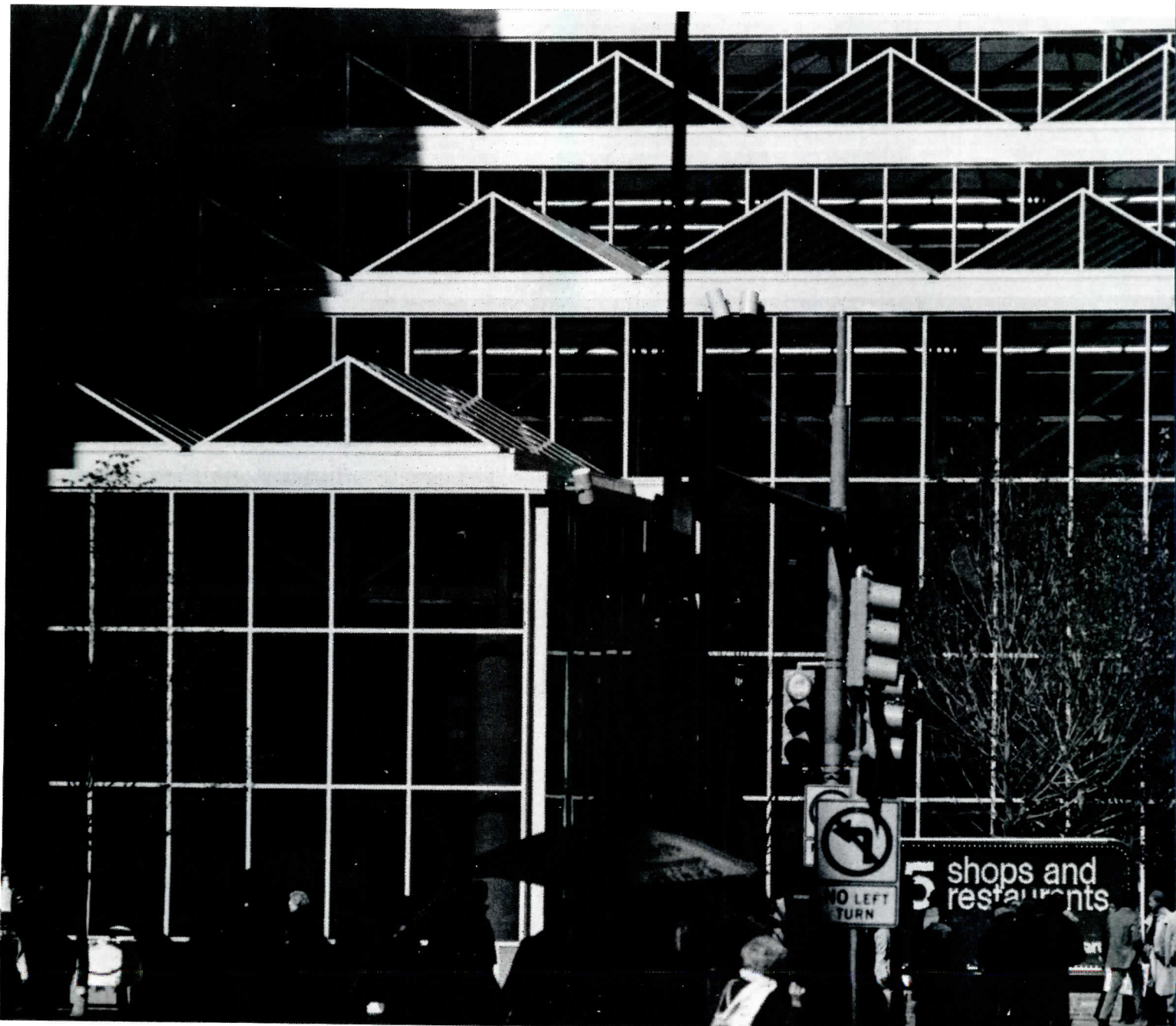

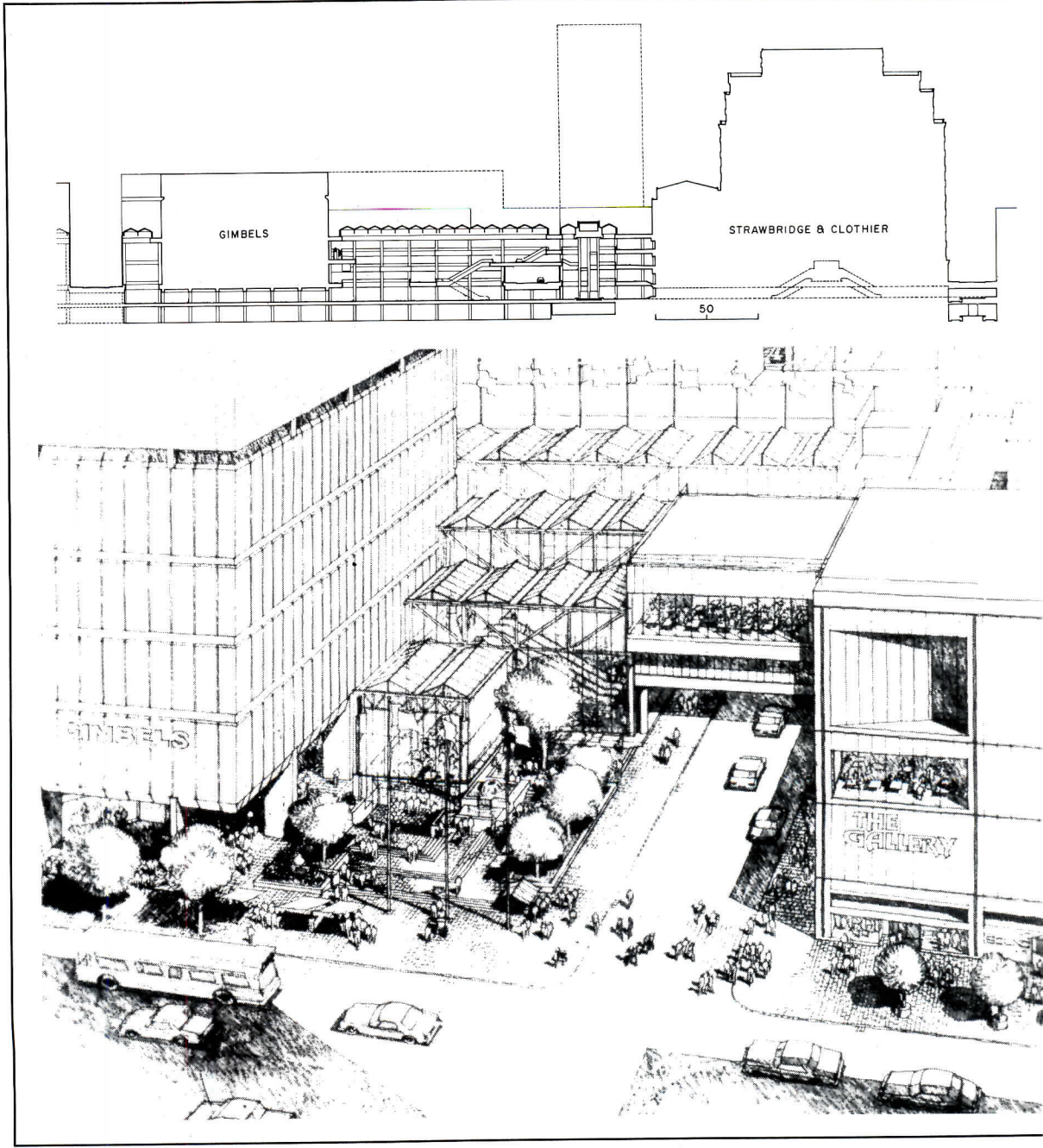
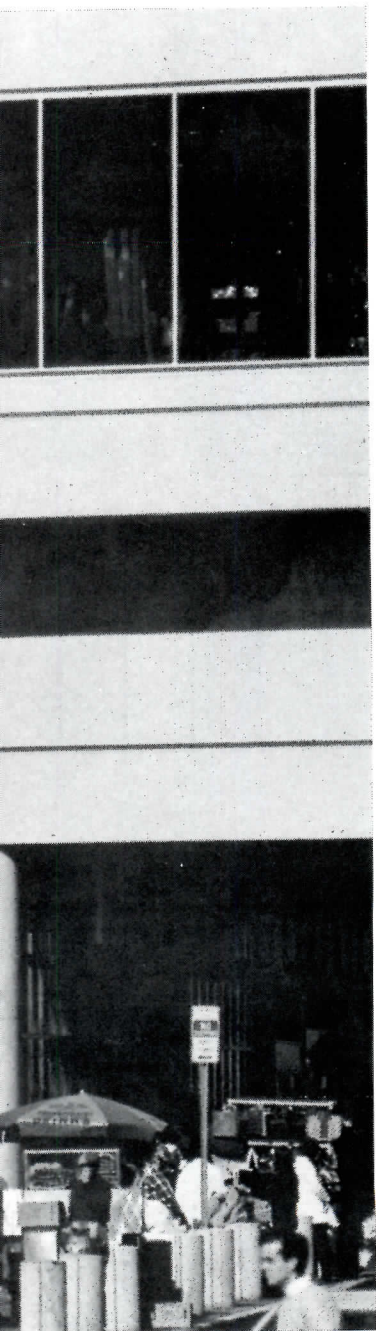
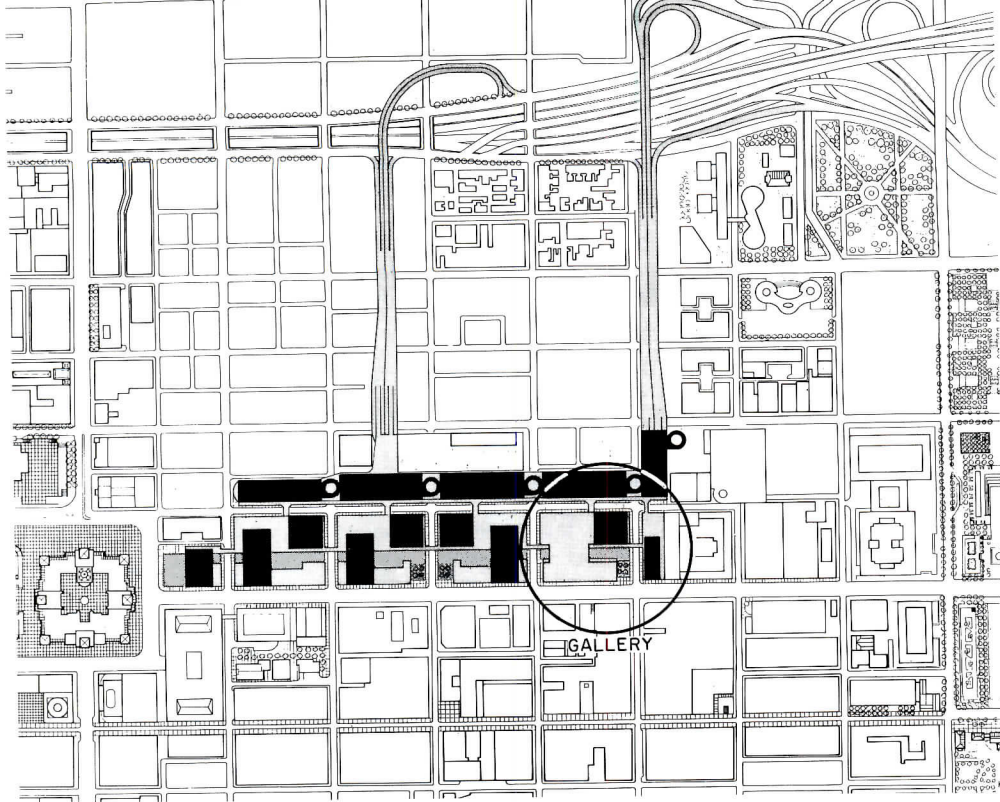

turn, sublease space to retail tenants. In a complicated financial arrangement, one-third of the financing came from private sources while two-thirds was public money. The architects designed—and for which the Redevelopment Authority played an unusual role as construction manager—the pedestrian mall, public courtyards, a truck tunnel, other public improvements, the urban design scheme and design controls for all private development and the coordination of rail station public areas.

The Gallery at Market east is fully enclosed, located at 9th and Market Streets between two of the city's major department stores—Gimbels and Strawbridge & Clothier. Gimbels has built a new 500,000 square foot department store while Strawbridge & Clothier recently completed an overall renovation of their store. Each store is directly connected to each of the Gallery's four levels. To be located behind the shopping mall is a new 850-car parking structure with a direct entrance into the Gimbels store. This will bring the total number of parking spaces to 1600 in the area.

Of importance is the transit connections of

subway, bus, trolley, rail and taxi to the shopping complex. While advancement has been made so that nearly every person can enter and exit near transportation, future link-ups will expand this critical system.

A full four-story glass-enclosed central court is the focal point of the mall, with escalators, stairs, elevators rising to various levels. Shops wrap around the court. An intricately-designed circulation system works well, and it has had to move packed crowds since the center's opening in 1977. The main entrance (shown on the previous two pages) is a series of pyramid-shaped glass enclosures, highlighting and offsetting the entrance from the existing buildings in the area. A two-level pedestrian bridge reaches across one street now, with other elevated connections planned. The construction of a hotel is possible, for the city owns the air rights over the shopping complex. An important access for servicing the center is an underground truck tunnel.

Since the \$55 million structure opened, nearly 100 per cent of the space has been rented and merchants have reported fantastic

sales. These figures have proven out the theory of the center-city complex, which was never in doubt in the minds of the architects or the Redevelopment Authority's staff. Its location has attracted people not only from the surrounding residential areas such as Society Hill, Queen's Village, Franklinton, Washington Square West and Rittenhouse Square, but from neighboring New Jersey.

THE GALLERY, MARKET EAST REDEVELOPMENT AREA, Philadelphia, Pennsylvania. Owner: *Redevelopment Authority of the City of Philadelphia*. Architects: *Bower and Fradley Architects—John A. Bower, Jr., partner-in-charge of design; Frederick M. Fradley, managing partner; Roger B. Lewis and Robert T. Mannel, project architects*. Engineers: *A & R Engineering Co., Inc. (structural); Leonard Weger Associates Inc. (mechanical/electrical)*. Consultants: *Collins Dutot Partnership (landscape); Sylvan R. Shemitz & Associates (lighting); Cerami Associates (acoustical); Peter Corsell Associates (technical); Wilbur Smith & Associates (vehicular movement)*. Construction management: *Redevelopment Authority of the City of Philadelphia*.





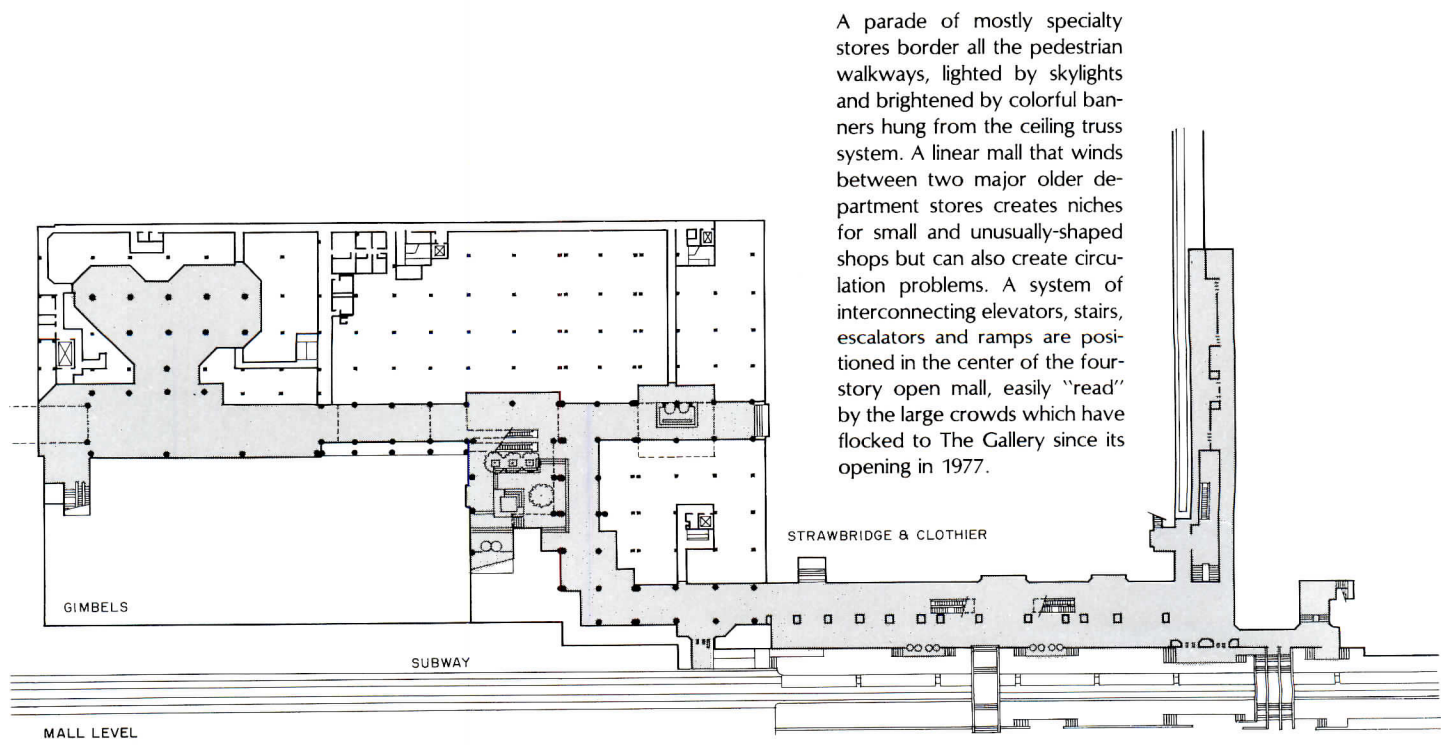
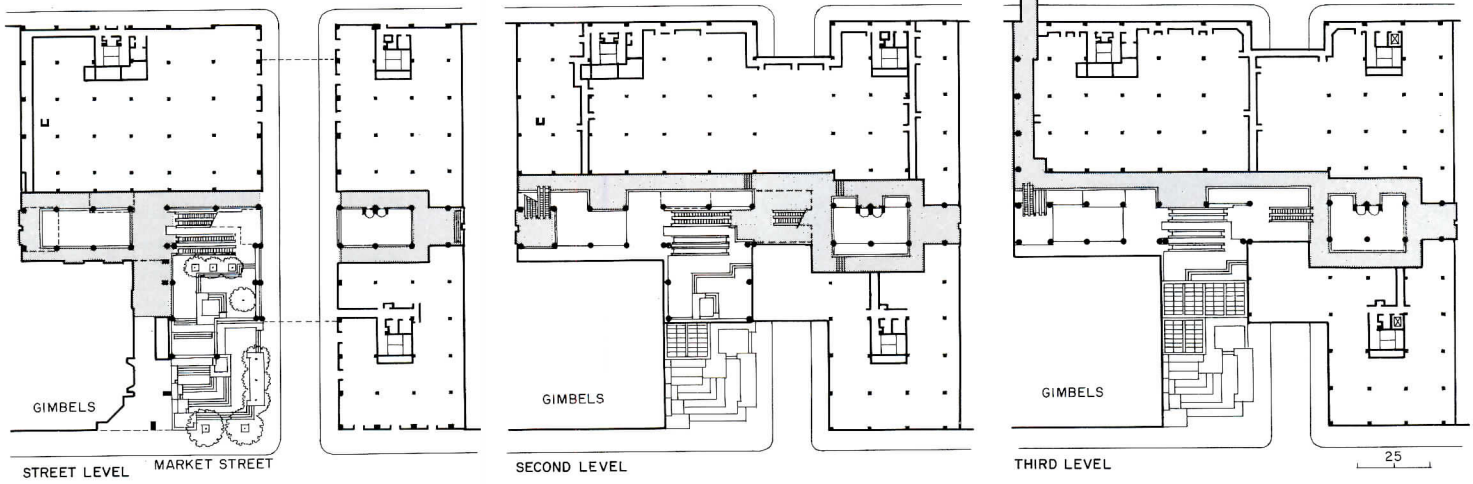
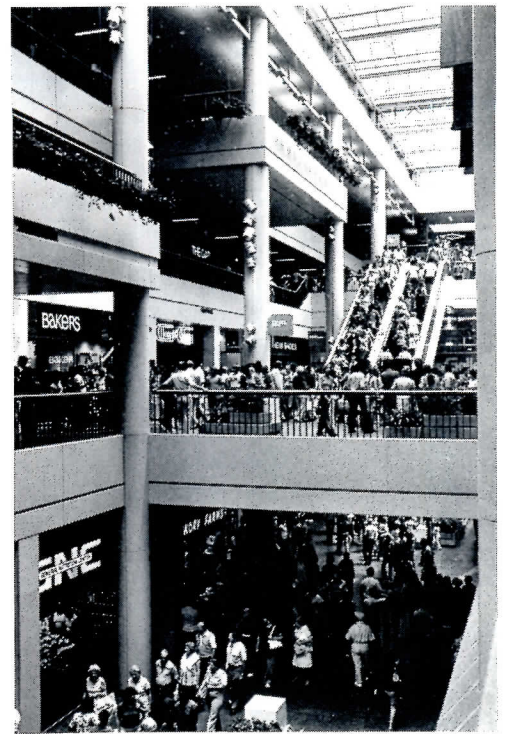
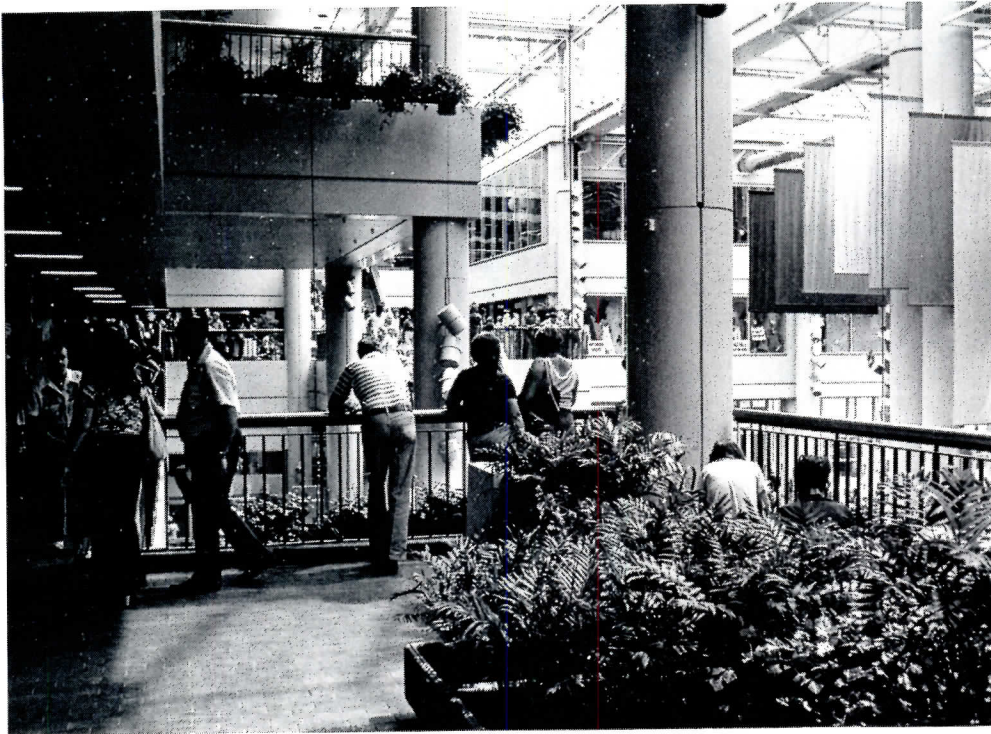

A parade of mostly specialty stores border all the pedestrian walkways, lighted by skylights and brightened by colorful banners hung from the ceiling truss system. A linear mall that winds between two major older department stores creates niches for small and unusually-shaped shops but can also create circulation problems. A system of interconnecting elevators, stairs, escalators and ramps are positioned in the center of the four-story open mall, easily "read" by the large crowds which have flocked to The Gallery since its opening in 1977.

## REHABILITATION OF OLD BREWERY WILL BRIGHTEN MILWAUKEE

Plans have been developed by Elbasani Logan Severin Freeman architects to create a mixed-use complex in downtown Milwaukee through the rehabilitation of several old industrial buildings and new construction. To be called The Brewery, it is one of the first steps in implementing the Milwaukee Redevelopment Corporation's 1974 plan for revitalizing downtown Milwaukee.

The design concept would preserve four Blatz Brewery buildings—a warehouse, wash house, bottling house and brewery—converting them into shops, housing, offices and a variety of community-oriented spaces. A four-block area in which the buildings are located would be closed off, except for limited vehicle travel, creating a "super block".

Surrounding the proposed site are projects which have started the trend of historic preservation in the city, specifically the restoration of the old City Hall and the Pabst Theatre. These are located on significant portions of the bank

along the Milwaukee River and join with a new performing arts center and office buildings. The area has suffered physical decline, and up to this time the single greatest impediment to further redevelopment in the area has been the brewery complex itself. The buildings have either been vacant or used as warehouses.

The wash house, warehouse and most of the brewery would be converted into specialty retail and commercial space, a total of 210,000 square feet. The upper floors of the brewery would become housing, while the bottling plant would be transformed into offices and parking. A 60,000 square foot museum is contemplated and at least 370 residential units (both rental and condominium, in new or rehabilitated buildings) would be provided. While new construction will be primarily low-rise and in-scale with the existing brewery structures, a new hotel and apartments could be 16 stories high. Elevated walkways within the complex will be prevalent, but they would also connect

to the adjoining performing arts center and garage.

The positioning of the new buildings and open spaces was chosen as a natural extension of open spaces and new and restored buildings to the south. The main public entrances would be from the "super block's" center, with access to the residential units from the side streets.

There will be some restoration of the existing buildings' facades with particular concentration on the parapet details, and the strengthening of a tower at the brew house. New construction is intended to be of compatible masonry, emphasizing brick, similar to that used in construction of the brewery.

THE BREWERY, Milwaukee, Wisconsin. Architects: Elbasani Logan Severin Freeman (formerly The ELS Design Group).

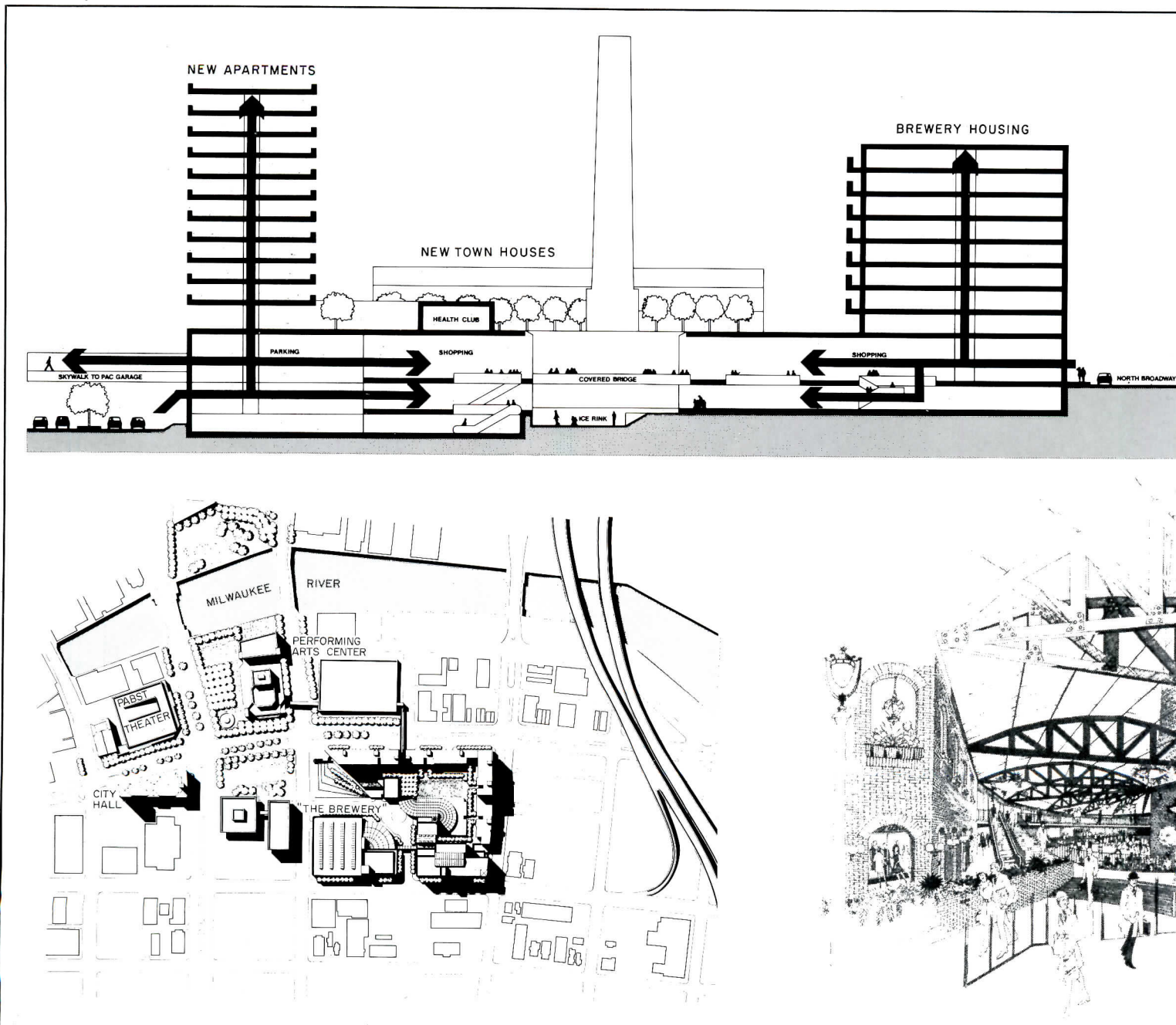

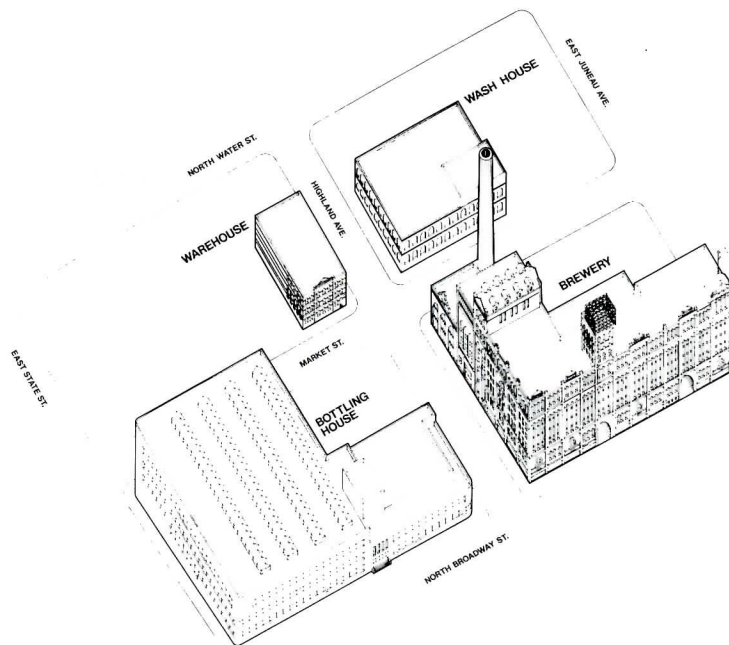

The architects have designed other mixed-use complexes for diverse downtown areas, and each city has suffered a decay that downtown Milwaukee is attempting to stop. In this urban plan a set of four existing buildings (upper right) would be transformed into an energetic complex through the rehabilitation and addition of retail stores, housing, offices, recreation facilities and a theater and museum. The brewery (above) would be converted into shops on the lower levels and housing on the upper floors, and perhaps would be connected to an arcade shown in the sketch (below). The project is intended to be financed through private and public funds.

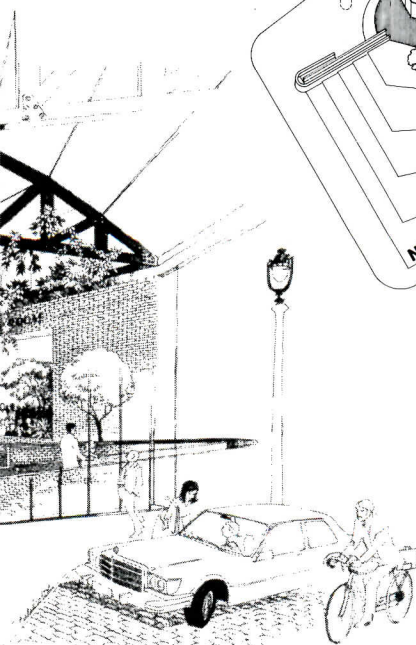
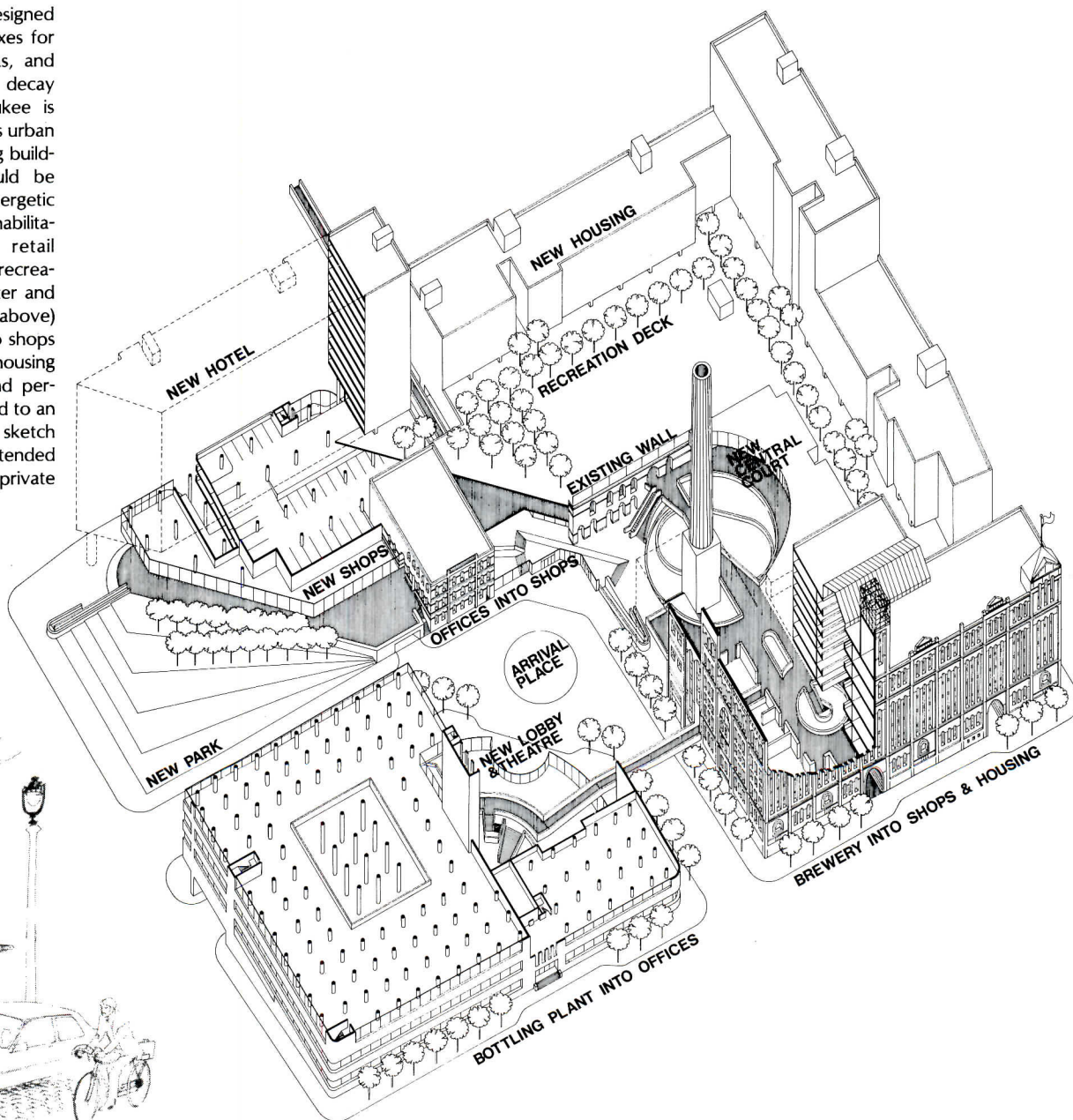

## GLASS STRUCTURE CREATES UNIFIED SHOPPING AREA

Troy, New York, is receiving a shot-in-the-arm with a new shopping mall in the central business district that combines rehabilitation of existing structures, and new construction creating a new retail center. In a town rich in 19th Century architecture, particularly in its mercantile buildings, the architects hope that this Mall will spur development in the area, turning around the evident physical decay.

A private developer, Carl Grimm, provided the thrust necessary to start the project with the renovation of the atrium and rehabilitation of the Frear building on the site. With the city allocating \$1.7 million "for a showplace and civic space in the downtown area," the architects designed a glass enclosure that will wrap around three sides of an existing department store, connect to the Frear building and to a new building of specialty stores and shops. Construction is presently underway, with completion scheduled for the end of 1978.

The focal point of the new center is, of

course, the glass structure. "Through the scale and use of glass we wanted to capture the qualities of the 19th Century imagery, but use a 20th Century vocabulary," said partner Geoffrey Freeman. Angled both vertically and horizontally, the glass steps back from the street to a central court, creating an open plaza on the street. A 550-car garage will also be built.

Armed with energy studies, the architects believe the glass is more than a visual asset. A balanced air circulation system has been devised to recirculate either cool or warm air, depending on the time of year, from the glass-enclosed areas to the store spaces.

THE TROY MALL, Troy, New York. Owner: *The City of Troy*. Architects: *Elbasani Logan Severin Freeman (formerly The ELS Design Group) and Harrison & Mero, associated architects—Leon Parham, project architect*. Engineers: *The Office of Irwin Canter (structural); Segner & Dalton (mechanical/electrical)*. Contractor: *SAI Constructors Inc. (garage and mall)*.

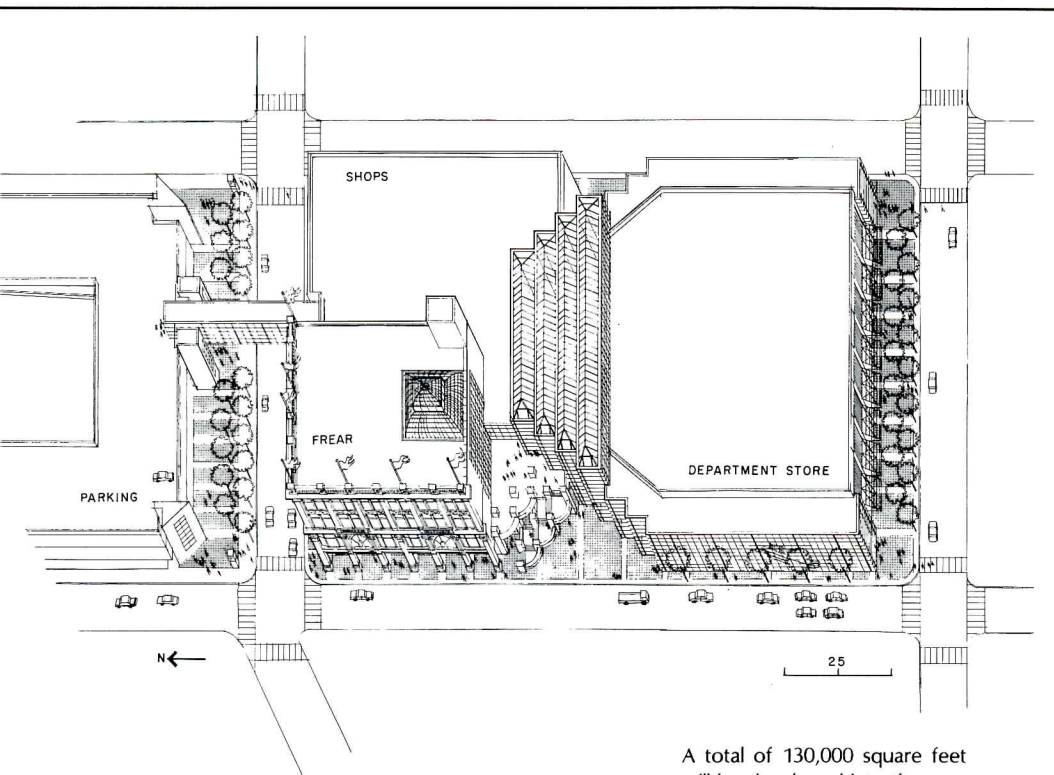

A total of 130,000 square feet will be developed into the new hub of the Troy central business district. The glass structure that will unify a variety of spaces will also generate a visual excitement opening up views from the interior and from the street. Access to the project is on the diagonal, from the corners of the site, as well as from the mid-block entrances.

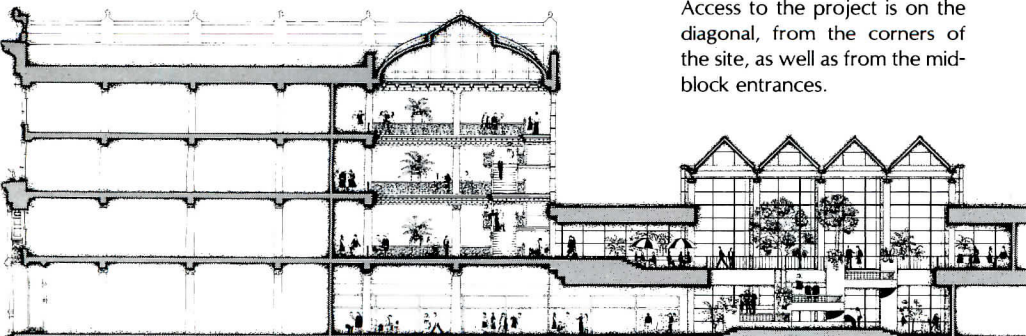

## Prefab brick channels yield visual variety and cost savings, too

A masonry bearing wall system, whose novel feature is a prefabricated brick channel for forming in-wall beams, cantilevers and lintels, enabled the architect for Brookhaven College in Dallas to use a series of arched openings, cantilevered walls and wall penetrations that provide visual and spatial interest. Furthermore, the system saved money by reducing formwork and the number of construction trades. James Pratt, partner in charge for Pratt Box Henderson & Partners, the architects, says the constraints of other systems were too rigid for such a wide variety of configurations.

The school, which is part of the Dallas County Community College District, is a series of nine building segments, tightly organized around courtyards, totaling 300,000 sq ft of building area costing \$18 million. Most of the buildings on the campus are two stories, ranging from 30 to 48 ft in height. The tallest

structure is the stage loft of the theater which is 95 ft high.

The masonry bearing wall system comprises an insulated brick cavity wall stiffened by reinforced, grouted pilasters on 12-ft centers (in unobstructed walls), and by 16-in bond beams at each floor level. The cavity is insulated with  $\frac{3}{4}$ -in. boards of polyurethane, giving a U value for the wall of about 0.12. With the system, the contractor, Dee Brown Masonry, installs not only the brick, but also all reinforcing steel, grout, insulation and some windows.

The prefabricated brick channels are constructed in a factory using a high-bond mortar containing an epoxy-type additive. For this reason the channels must be made under plant conditions with a high degree of control and frequent testing. The high-bond mortar is used only because of the construction technique, and not for the ultimate strength of the

composite elements. The wall is actually designed around normal-strength mortar, according to the structural engineer, Thomas W. Taylor of Datum Structures Engineering, Inc. The high-bond mortar achieves a strength of 3000 psi and more in three days, and 6000 psi and more in 28 days. The epoxy mortar is used in the field only to join the channels forming beams and cantilevers.

The U-shaped channels serve as both a finished surface outside and in and as a form for concrete for beams and cantilevers. (A few of the channels are L-shaped, with a single side of brick, where the interior wall does not call for a surface of brick but can be concrete block.)

Basically, the channels are forms for reinforced concrete beams that span openings and that, along with the pilasters which are at each side of the opening, carry the rest of the brick



above them. Typical reinforcing for these beams is two no. 6 bars top and bottom. (Bond beam reinforcing is one no. 4 bar top and bottom.)

The prefabricated brick channels range in size from small lintels 2 ft long, 8 in. high and 2 ft deep to the largest which is 5 ft long, 4 ft high and 2½ ft deep. Typical size is 4-ft long, 2-ft high, and 16-in. deep. The longest channel-formed beam spans 80 ft at the top of the stage in the theater.

In total there are 1500 prefabricated channels requiring approximately 300,000 of the 2.5 million bricks used on the project.

The brick cavity wall is at least 16-in. thick, comprising two 4-in. wythes of brick and an 8-in. space between them. These are constructed in the conventional way with conventional mortar. Even with high-tensile wire reinforcing, these walls cannot span more than 12 ft because of wind load, so, as mentioned earlier, reinforced pilasters are provided on these centers. Where door and window openings occur, the pilasters are located on each side of an opening. And while the cavity wall normally is 16 in. thick, it varies with height. For example for a 75-ft high unbraced stage wall in the college's theater building, the wall is 2½ ft thick, though the outside and inside wythes still are only 4 in. of brick. Grouted pilasters that normally are 16 in. deep are now 2½ ft deep and reinforcement is increased to 12 no. 8 and no. 9 bars. Reinforcing also varies in pilasters according to wind loads, and is different for exterior and interior walls. The grouted pilasters in a 16-in wall measure 8 by 16 in. and are formed inside the cavity by use of 4-in. thick concrete blocks. They are reinforced vertically

with a column cage of three or four no. 6 bars.

The designers of the project explain the economies of the system this way: Conventionally, a building with face brick would require a conventional frame (perhaps requiring fire protection) with 4-in. of face brick on the outside, and then metal studs, insulation and interior surfacing. Contrast the conventional approach with this new version of the masonry bearing wall, they say, where the brick cavity walls form the structure, include insulation, and provide finish inside and out. In the construction process, once the grade beams were in place, only the masonry trade was involved. One contractor handles the reinforcing steel, concrete, insulation and masonry for the walls, instead of three or four different crafts. Use of pumpable grout allowed the work to be done by grout masons, and eliminated vibrating—an important factor because this might have damaged mortar used in the walls. The grout is a six-sack mix with a high water/cement ratio (50 gallons), and aggregate is ¾-in. pea gravel; slump is 10¼ in. While specifications call for 2500 psi at 28 days, the contractor reports cylinder breaks averaging 4000-5000 psi. The system was developed as a team effort over a three-year period by Datum Structures Engineering and Dee Brown Masonry. —Lorraine Smith, *World News, Dallas*.

BROOKHAVEN COLLEGE, Farmers Branch, Texas. Architects: *Pratt Box Henderson & Partners*. Engineers: *Datum Structures Engineering, Inc. (structural); Alan H. Smith Consulting Engineers, Inc. (mechanical/electrical); Albert Half Associates, Inc. (civil)*. Construction manager: *Avery Mays Construction Co.* Masonry contractor: *Dee Brown Masonry, Inc.*

Lorraine Smith, photos

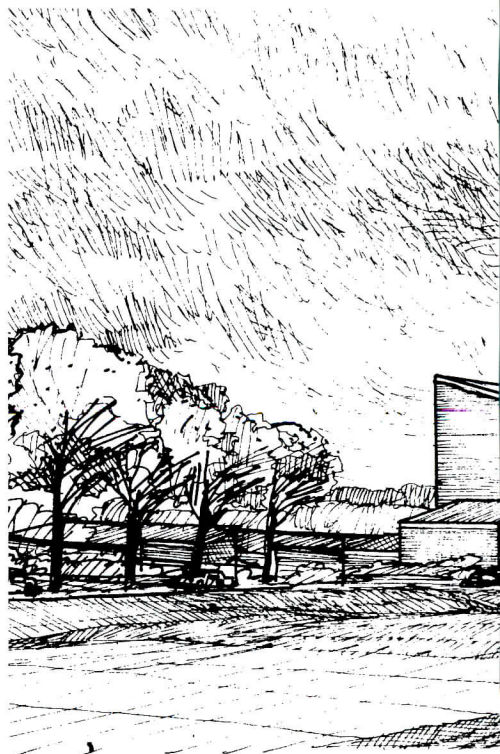
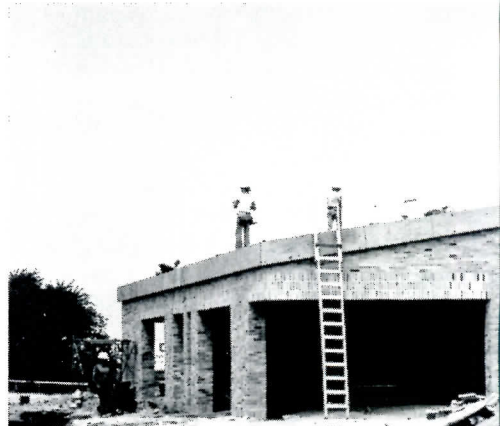
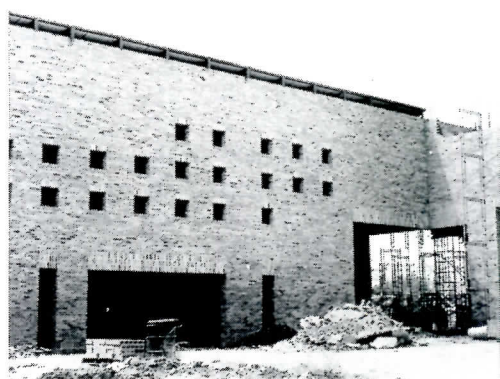
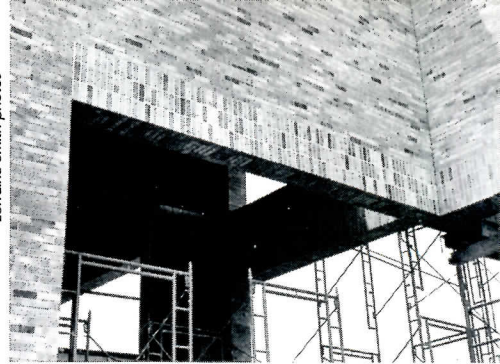

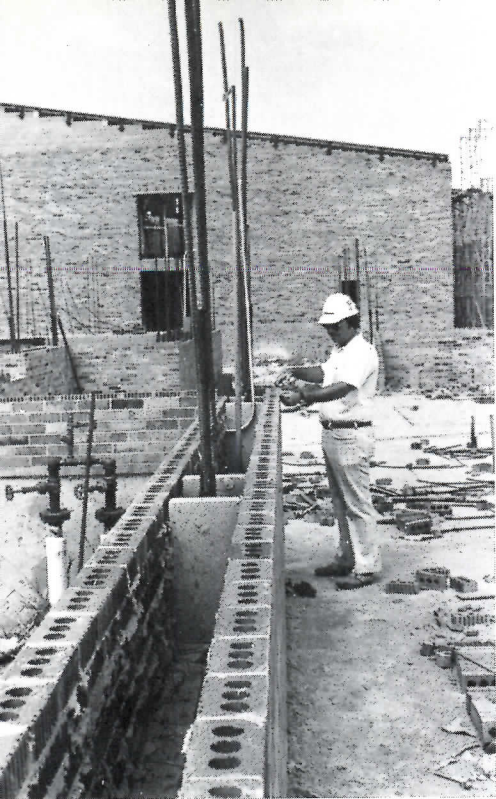

The prefabricated brick channels gave the architect considerable freedom in configuring the exterior walls, as shown in the photos. Objective was to create a memorable experience for the students, all of whom commute. Illustrated are beams over archways, cantilevers for openings and corners, lintels for windows and pierced openings. One of the channels is being positioned on shoring, above. Note the reinforcing for pilasters in this photo and above center. Concrete masonry units block off space where pumped mortar will be placed. The cavity wall, which is insulated with  $\frac{3}{4}$ -in. slabs of polyurethane, is erected conventionally. Walls generally are from 30 to 48 ft high, though the theater has a 95-ft wall.

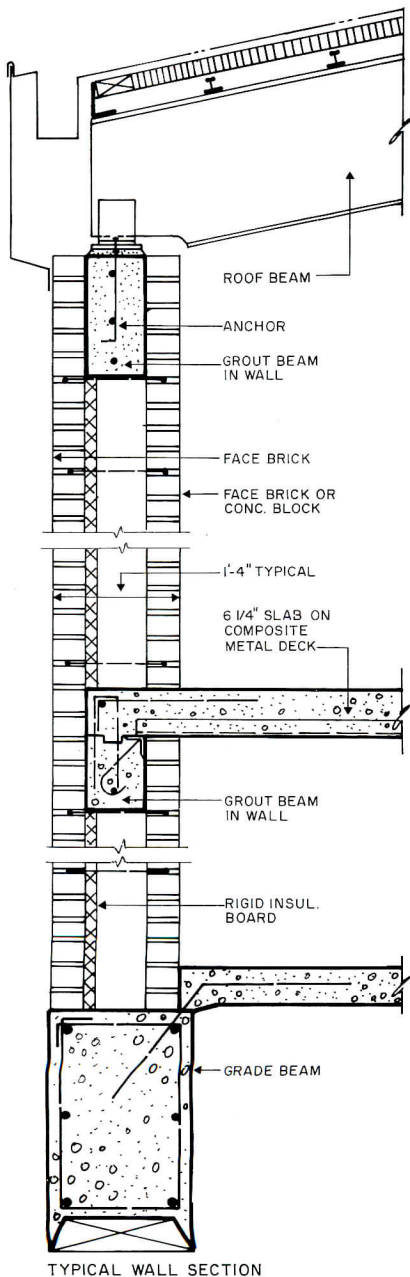
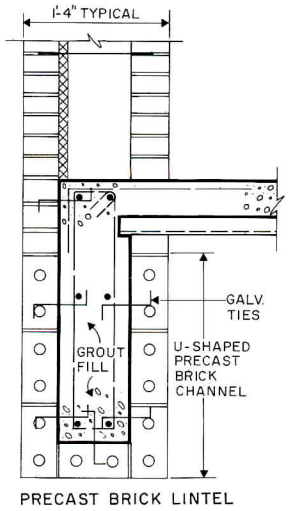
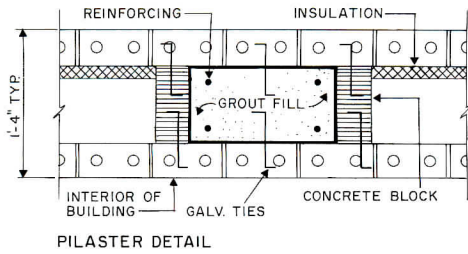

The prefabricated channels were fabricated using an epoxy additive in the mortar to provide strength sufficient for shipping. All mortar for the channels and pilasters was of the pumpable type. In the photo above, pumped concrete is being placed for a portion of the structure for the theater. At left is a section through the cavity wall. At top left are details of the precast channel and the pilaster.

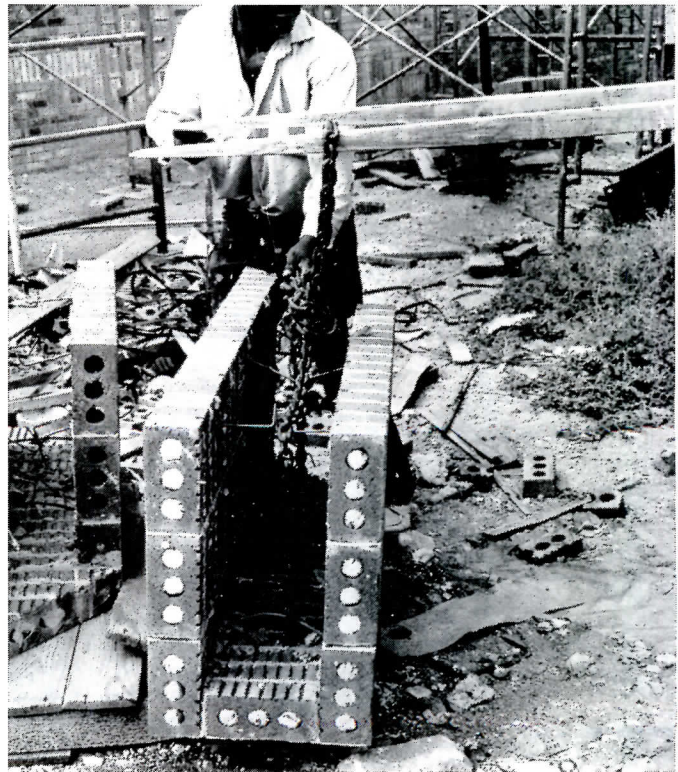



For more information, circle item numbers on Reader Service Inquiry Card, pages 207-208

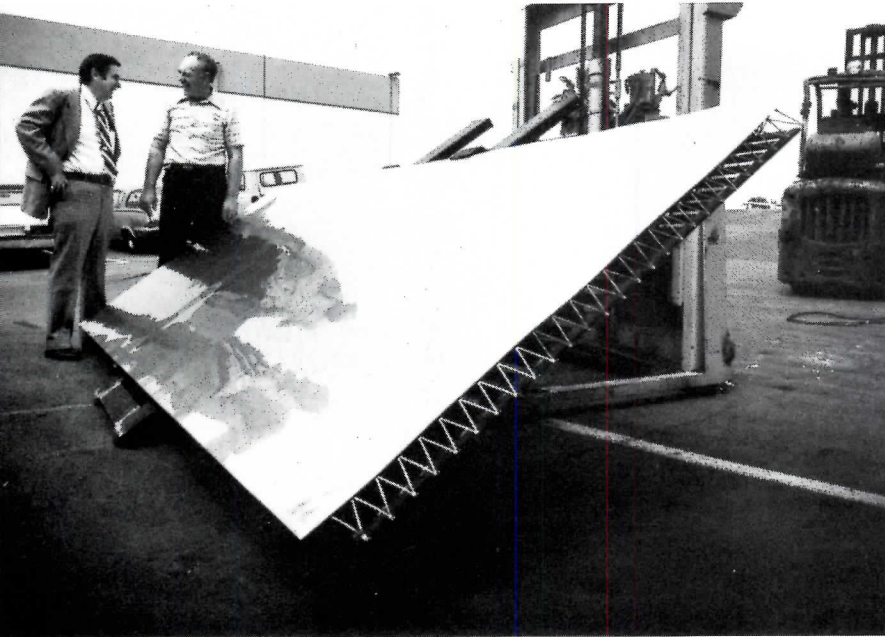

## All-welded sandwich panel reduces costs of stainless steel fabrication

A patented all-welded sandwich panel is said to reduce the costs of stainless steel fabrication and construction. The company welds stainless steel on one side and mild steel on the other of

2-in. thick panels in sizes up to 30 ft long and 10 ft wide. A panel of 16 gage stainless steel on one side and 16 gage mild steel on the other is said to have the same strength and 10

times the rigidity of 1/2-in. steel plates, yet the cost is under \$7.50 per sq ft. ■ Wirecomb, Inc., South El Monte, Calif.

circle 300 on inquiry card

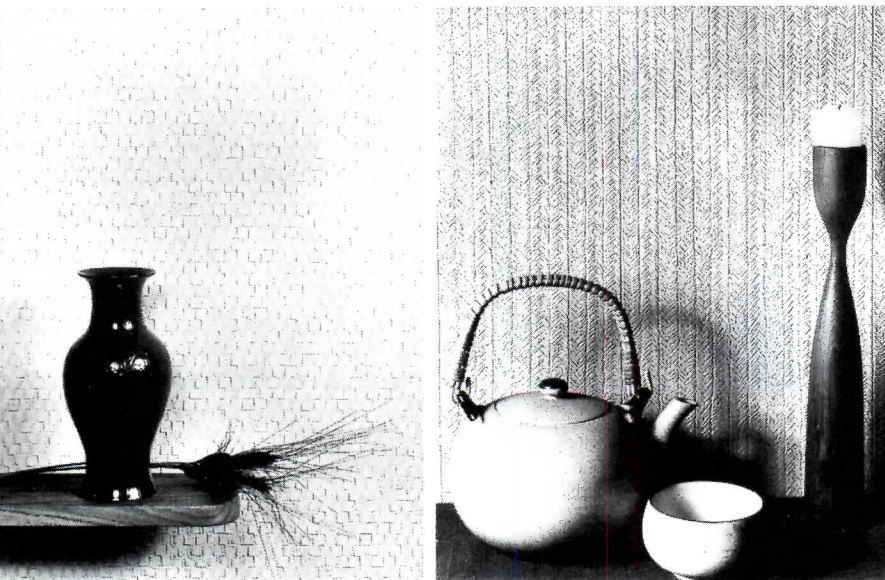

## New textures added to fabric-backed vinyl contract wallcoverings

Three new textures have been added to the *Guard* line of contract wallcoverings. "Djarta" (not shown) is a 24-ounce fabric with a woven grass texture that comes in 30

natural, pastel or bright colors. Contour (left) is a basket-weave design available in 22-ounce weight, in 16 natural and earth colors. "Sand Stripe" (right) is offered in a 22-ounce

weight, in ten shades each in sand, clay and stone colors. ■ Columbus Coated Fabrics Div., Borden Chemical, Columbus, Ohio.

circle 301 on inquiry card

## Load controller moderates electrical energy use

"Model HES-410" load controller is recommended for hospitals, stores, offices, schools and small manufacturing concerns. The company claims control of kilowatt-hour expenses with the unit which cycles up to 32 separate loads. The self contained

unit requires no signal from the utility. Kilowatt demand is controlled by instantaneously leveling the rate of power usage. ■ Haughton Energy Systems, Div. of Reliance Electric, Toledo, Ohio.

circle 302 on inquiry card

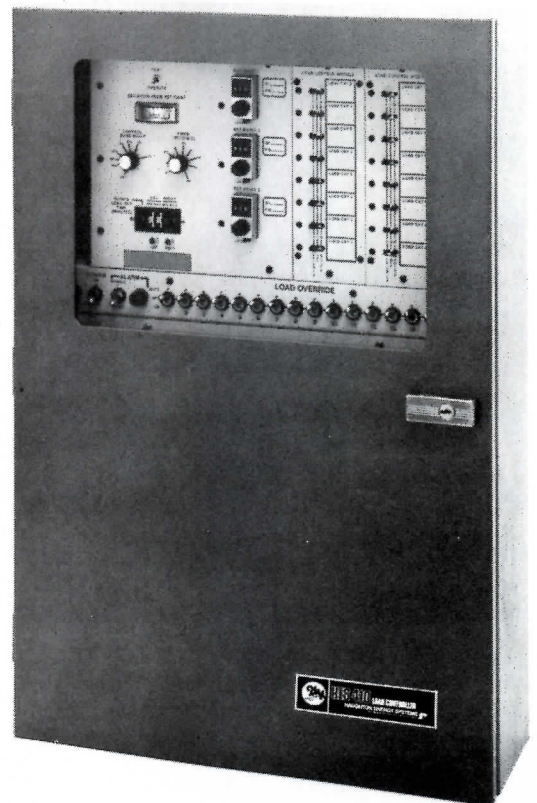

## No-fade warranty offered for contract carpet

"Contract 7," a 7000 denier grass constructed of Patlon 7/7 polypropylene, is offered with a seven-year no-fade warranty for both interior and exterior

installations. A special feature is the Dow urethane backing. ■ Sheridan Carpet Mills, Dalton, Ga.

circle 303 on inquiry card

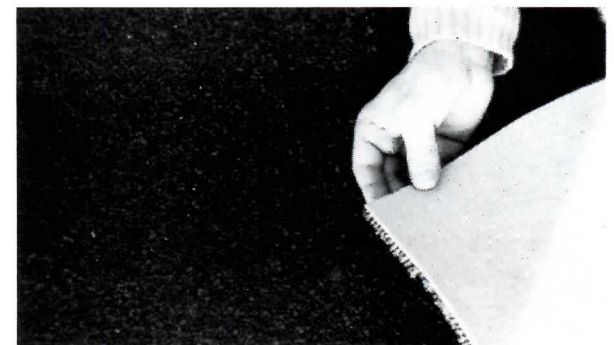

# Three ceiling problems, three Conwed solutions.



## 1. Rough treatment

There are actually two Conwed® solutions to this problem. Our ultra-hard Rock Face® tile and panels provide both abuse-resistance and beauty and are ideal for unsupervised corridors and public places. Where abuse is heavy—such as a gymnasium—we offer an Impaction® Ceiling System. It's designed to take a blow from a high flying ball, give with it, then snap back into place. It's U.L. fire rated too! Both of these solutions were introduced by Conwed.

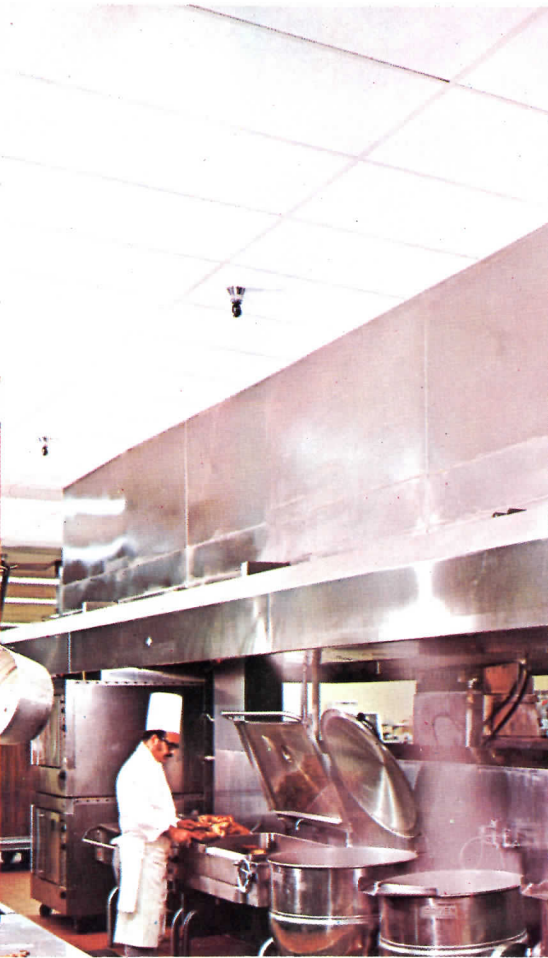

## 2. Grime and grease

There are certain areas where cleanliness is crucial: kitchens, hospitals, laboratories, supermarkets. For these problem areas, Conwed makes the Metal Face Ceiling. The vinyl-coated, metal-clad surface resists penetration of dirt, moisture and odors. Even areas with concentrations of grease come clean with a sponge and mild detergent solution. The washable ceiling is another Conwed first.



## 3. High humidity

Conwed Ceramic Ceilings are designed to withstand high humidity and are resistant to heat and corrosive chemical fumes. They offer excellent acoustical control, a pleasing appearance and a two-hour U.L. fire rating. An obvious application is for swimming pools, but the Ceramic Ceiling is also appropriate for installation under outside canopies, soffits and in areas as diverse as kitchens and industrial plants.

# And as many more solutions as there are problems.

Conwed has been making ceiling products for over 50 years. We've had one basic way of doing things—isolate a need, and develop a product solution in a form contributing to interior design and

minimal maintenance. This approach has made Conwed a concept and product innovator. For more ceiling solutions, write Conwed Corporation, 332 Minnesota Street, P.O. Box 43237, St. Paul, Minnesota 55164.



*For more data, circle 64 on inquiry card*

*innovative products for better environments*

For more information, circle item numbers on  
Reader Service Inquiry Card, pages 207-208

# AZTEC

400 low temperature  
electric radiant heating  
panels are being used for  
total perimeter heat in  
the six story  
**Doctors' Medical Arts Bldg.**  
adjacent to Doctors' Hospital  
in Tulsa, Oklahoma.

Air conditioning is provided by  
a variable air volume system.  
Heating is controlled through a  
solid state system regulated  
by a combination of outside  
air temperature and solar  
loads on each face.

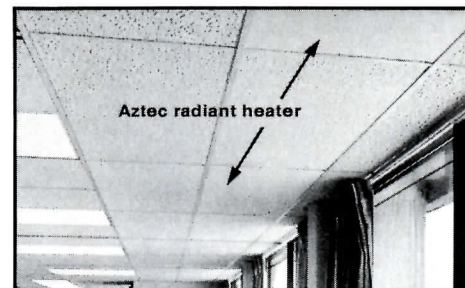

## HTB Inc.

(formerly Hudgins, Thompson &  
Associates, Inc.) Architects, Houston.

**Collins-Soter Engineering Inc.,**  
Consulting Mechanical Engineers,  
Oklahoma City

**Homer Wager,** Building Engineer  
Doctors' Hospital Complex 2323 S. Harvard,  
Tulsa, OK 71745 918-936-5481

**R&B Equipment**  
6565 E. Skelly Drive Tulsa, OK 75145  
918-663-4946  
Aztec Engineering Representative

**Aztec panels have a patented crystalline  
surface. A superior graphite element  
assures uniform heat across the panel.  
No moving parts. No maintenance.  
10 year limited warranty.**

For more information on Aztec electric  
heating panels or for the Aztec engineering  
representative nearest you, call or write to:

**Aztech International Ltd.**  
3434 Girard N.E., Albuquerque, N.M. 87107  
505-345-5631  
**TOLL FREE 800-545-8306**

For more data, circle 65 on inquiry card

**STEEL SECURITY SYSTEM** / "Security Plus for Criminal Justice Facilities" is a six-page brochure outlining a tamper-proof, all-steel floor and ceiling system designed for jails and other detention centers. Anchored to the building's structural frame as a continuous barrier, "Security Plus" units can incorporate lighting, sound control, air distribution and electrical wiring in an integrated ceiling with a finished appearance. ■ H. H. Robertson Co., Pittsburgh, Pa.

circle 400 on inquiry card

**OPEN OFFICE SCREENS** / Construction details of *Sound Screen II* acoustically-rated office partitions are explained in a 12-page brochure; fire hazard and sound absorption data are also given. Step-by-step photos illustrate installation procedures; all 15 standard colors available in *Dacron* fabric panel surfaces are shown. ■ Owens-Corning Fiberglas Corp., Toledo, Ohio.

circle 401 on inquiry card

**WASHROOM EQUIPMENT** / Colored washroom accessories are pictured coordinated with wall paneling, toilet compartments and counters in this planning guide for large and small public washrooms, locker rooms and club facilities. The "Designer" product line is featured; these accessories have doors of laminated plastic, in colors or woodgrain, mounted on stainless steel recessed cabinets. ■ Bobrick Washroom Equipment, Inc., New York City.

circle 402 on inquiry card

**LOADING DOCKS** / Loading dock productivity as affected by different designs of powered lift equipment is discussed in a four-page product brochure. Included are scissor lifts, both movable and in-place types, ram-type lifts, and trucklevelers; safety features such as an automatic, mechanically actuated kickplate are explained. ■ Autoquip Corp., Guthrie, Okla.

circle 403 on inquiry card

**HOURLY BILLING** / An illustrated brochure presents the *Time/Check* employee time report system, designed to control and record any client service involving professional consultation billed on hourly rates. The *Time/Check* system has letter writing and editing capabilities, and can monitor employee time and productivity, client activity, billing, statements, and cash receipts. ■ Wang Laboratories, Inc., Lowell, Mass.

circle 404 on inquiry card

**VERTICAL CONVEYOR** / Selective vertical conveyor systems, which speed the flow of information, communications and materials from any floor to any other floor in multi-story buildings, are the subject of this brochure. Bulletin 3630 describes how materials such as mail, reference material, books, data processing information, files and X-rays can be carried in lightweight containers capable of handling loads up to 60 lbs. ■ Acco, Bridgeport, Conn.

circle 405 on inquiry card

**PRECISION LIGHTING** / Luminaires manufactured from designs by Sylvan R. Shemitz are described in a 48-page technical catalog. The asymmetric, sharp cutoff luminaires presented provide uniform lighting of a plane from one edge, and have a variety of applications including ceiling and wall washing, desks, counters and displays, pedestrian lighting, signs, museums, and other areas needing precise, even illumination. Lamping and footcandle data are given; prices are listed. ■ Elliptipar, Inc., West Haven, Conn.

circle 406 on inquiry card

**STAGGERED TRUSS FRAMING** / Fundamental design considerations of this building technique are discussed in a 20-page booklet. The literature covers such topics as building configurations, stacking arrangements, floor systems, floor shear transmittal and truss and column design guidelines. It also summarizes the advantages of staggered truss framing over the portal frame system, and makes observations on the economics of the newer system. ■ United States Steel Corp., Pittsburgh, Pa.

circle 407 on inquiry card

**LIGHTWEIGHT TILE ROOFING** / With the appearance of clay roofing tile when installed, but weighing one-sixth as much, *Decramastic Typhoon Tile* offers savings in both structure and labor. A six-page folder describes the roofing product. ■ AHI Roofing, Inc., Santa Fe Springs, Calif.

circle 408 on inquiry card

**DIGITAL PLOTTERS** / Special requirements for replacement plotter points are discussed in a product folder on the "70" plotter point series, which can provide a standard replacement point for many plotters now available that operate at a maximum writing speed of 10 in. per second. Other drafting accessories, inks and films are also described. ■ Koh-I-Noor Rapidograph, Inc., Bloomsbury, N.J.

circle 409 on inquiry card

**INDOOR/OUTDOOR LIGHTING** / A 168-page, full-color lighting catalog presents chandeliers, all-purpose fixtures, bath and vanity lighting, track, recessed and "Value" lighting, and bulbs. Featured in the catalog are the "Old World Classic" fixtures of ceramic and brass, and "Crystal Ice" lights with 25 per cent leaded crystal. Photometric and dimensional data are given for each line. ■ Virden Lighting, The Scott & Fetzer Co., Cleveland, Ohio.

circle 410 on inquiry card

**INSULATED DOORS** / Significant fuel savings are claimed for the "Benchmark" line of insulated steel entries; a color brochure describes the pre-hung units, which come with frame and threshold. ■ General Products Co., Inc., Fredericksburg, Va.

circle 411 on inquiry card

**VINYL ASBESTOS TILE** / A book-form sampler holds actual tiles represented in this line of contract flooring for commercial, institutional, and industrial use. Included are all 1/8- and 3/32-in. gauge through-chip, solid accent colors, and embossed patterns for heavy- and medium-traffic flooring areas. Technical information on performance characteristics, light reflectance values, adhesive recommendations and suggested maintenance are included. ■ Azrock Floor Products, San Antonio, Texas.

circle 412 on inquiry card

**RACQUET SPORTS** / A color brochure illustrates the design potential of pre-engineered building systems for constructing racquet sports facilities. Representative floor plans, design considerations, and a review of planning points are included. ■ Butler Mfg. Co., Kansas City, Mo.

circle 413 on inquiry card

**ELEVATOR/CONVEYOR ENTRANCES** / Detailed information and illustrations of the construction and safety features of the *Smooth One* freight elevator door are given in a 12-page brochure. Also described is such auxiliary equipment as manual and electrical operators. ■ Harris Preble Co., Chicago, Ill.

circle 414 on inquiry card

more literature on page 143

# MUSSON

## DISC-O-TILE™

Safety rubber flooring and

## DISC-O-TRED™

Safety stair treads

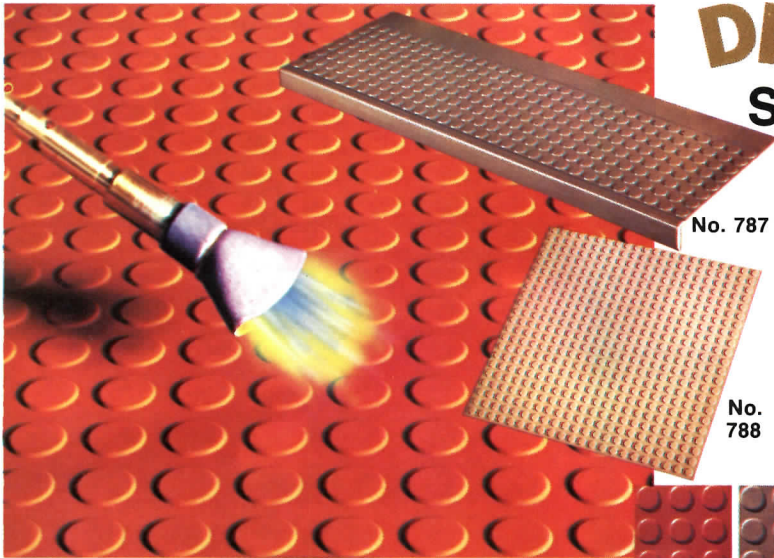

Musson Flame-Retardant Flooring & Treads meet ASTM-E84 Flame Spread Rating of 25 or less.

**DISC-O-TILE**— 24" Square for quick installation. Full 3/16" thick with sanded back. Raised circular discs afford better traction, easier cleaning for lobbies, entrances, hallways, elevators. Resistant to stain and discoloration.

**DISC-O-TRED**— Stair treads 1/4" thick at front, 1/8" at tapered back. Long square nose fits pan-filled or molded concrete steps. Sanded backs. Durable, easy cleaning, nonfading. Prime prerequisite for fire-safety in public buildings or complexes. Matching covered risers.



meets ASTM-E84 flame  
spread rating of 25 or less



**THE R. C. MUSSON RUBBER CO.**

1320 Archwood Ave., Akron, Ohio 44806 Ph: 216/773-7651

Write For Free Brochure & Samples:

For more data, circle 66 on inquiry card

## NOR-LAKE WALK-IN REFRIGERATION

Custom Engineered to your Specifications

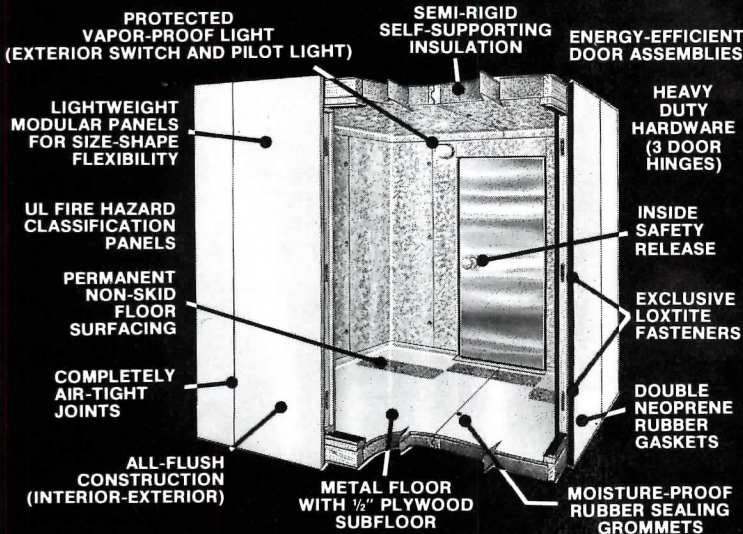

### PLUS THESE ACCESSORIES

- Automatic Defrost Vaporizer • Heated Air Vent • Air Pressure Relief Vent • Piston Action Door Closer • Ramps (Interior-Exterior) • Post and Beam Construction • Track Port Door • Anti-Sweat Heater • Door Heater Control • Port Windows • Glass Doors • Half Doors • Roofs for Outdoor Installations • Dial Thermometers • Heated Threshold • Floor Sealers • Slam Braces • Sweep Gaskets • Package and Remote Refrigeration . . . and more.

For more information see your local Dealer or write for Catalog SW78

**NOR-LAKE INC.**

Second and Elm, Hudson, WI 54016 • Phone 715-386-2323

For more data, circle 67 on inquiry card

## Introducing the bag your plans fit nicely into.

For better mailing, delivery and storage... it's the new Speedi-Pak® bag by Bemis.

Faster than wrapping plans and drawings in plain brown paper. Affords better protection, too.

And if you've ever tried to roll a bulky document to fit into a mailing tube, you'll readily notice that Speedi-Pak bags are much easier to pack.

To close, just staple shut. Your firm name can be imprinted on any of the many sizes available.

Speedi-Pak bags are acceptable to UPS and the U.S. Postal Service.

Write for complete details: Bemis Company, Inc., P.O. Box 308, Crossett, Arkansas 71635. (Telephone 501-364-2103.)

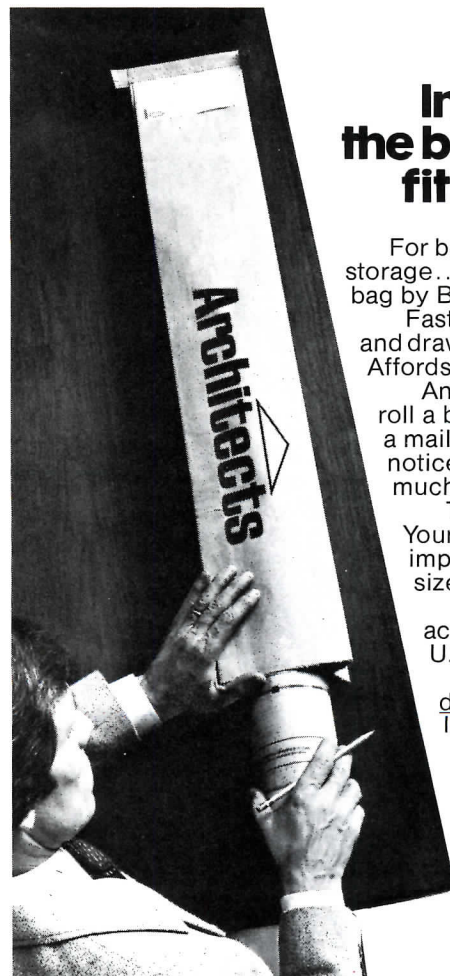

**BEMIS**

For more data, circle 68 on inquiry card

**SHELF FRAMING** / *Latch-On* slotted angle framing material is described in a product flyer, which shows how the system can be used to build stair steps, benches, tables, scaffolds, wheeled carts, etc. ■ Interlake, Inc., Chicago, Ill.

circle 415 on inquiry card

**LAUNDRY PLANNING** / A 20-page booklet, "Planning a Home Laundry Center," discusses design, location, storage, work space and possible pitfalls to be avoided in the layout and equipping of home laundry facilities. ■ The Maytag Co., Newton, Iowa.

circle 416 on inquiry card

**FAUCETS/FITTINGS** / Illustrated with color photographs, product data sheets describe the "Colore" and "Junko" lines of imported bath and basin fittings. ■ Fearless Faucets, Port Chester, N.Y.

circle 417 on inquiry card

**FLUID DUPLICATORS** / The low-cost and ease-of-use characteristics of a line of fluid (spirit) duplicators are discussed in a six-page illustrated folder. ■ A. B. Dick., Chicago, Ill.

circle 418 on inquiry card

**WINDOW TREATMENTS** / Woven wood shades and drapes are shown in a number of commercial and residential applications in a 12-page product booklet. Color photographs illustrate 22 different weave patterns; measuring and installation details are included. ■ Suffolk Woven Crafts, Inc., Lindenhurst.

circle 419 on inquiry card

**ALUMINUM BLINDS** / One-in. wide *Flexalum* tempered aluminum alloy slats are suspended from 1-in. headrails in the *Fine Lines* window blind series, described in a four-page color brochure. Said to be very resilient, crease-resistant and corrosion-free, the narrow blinds are available in 50 standard colors; operation is by twist-wand or battery-powered motor control. ■ Graber, Middleton, Wis.

circle 420 on inquiry card

**GLASS SECURITY WALL** / *ClearGard* is an aluminum-framed glass wall detention and security system designed for use in correctional facilities. Glazing is *Penalgard* glass, 13/16-in. thick, held within the framing by high-durometer neoprene channels. A folder describes the *ClearGard* system's flexibility and illustrates several wall and door installation details. ■ Midwest Architectural Metals, Inc., Eastlake, Ohio.

circle 421 on inquiry card

**PYROLYTIC INCINERATORS** / Non-polluting incinerators capable of up to 250-to-1 waste volume reduction are described in a color brochure. The equipment is specifically designed for the requirements of smaller municipalities, with disposal rates ranging from 4.8 tons per 8-hr day for the smallest model, to 36 tons per 24-hr day for the largest unit. Energy recovery systems for these pyrolytic incinerators, which use solid waste as fuel to produce steam, hot air or hot water for process or space heating, are also described. ■ Kelley Co., Inc., Milwaukee, Wis.

circle 422 on inquiry card

**ACOUSTICAL SCREENS** / The "Prima I" and "Prima II" open office acoustical screens are described in a six-page color brochure. Constructed with a *Fiberglas* sound absorption core and a *Glastrate* outer shell, the screens are available with either square, wood trimmed corners, or with rounded, vinyl-protected edges, and in a modacrylic fabric or COM. ■ Prima Products, Inc., San Leandro, Calif.

circle 423 on inquiry card

**LIGHTING POSTS** / A full-color brochure illustrates 15 different styles of cast iron ornamental lighting posts. Units in heights of from 7- to 20-ft are shown installed; lamping information is given on the variety of light sources possible for low level park or higher-level street illumination. ■ Spring City Electrical Mfg. Co., Spring City, Pa.

circle 424 on inquiry card

**STANDBY POWER SYSTEMS** / A 12-page brochure features the "Fast Response" line of generator sets ranging from 30 to 260 kW, which have built-in short circuit protection and 0.05-second response to voltage transients. Also described is the "Fast Check Tester," an accessory for these standby power systems which verifies that controller units are functional and ready to operate in case of a power blackout. Other generator sets of from 1.75 through 1,000 kW, and gasoline, natural gas, LP, or diesel powered, are listed. ■ Kohler Co., Kohler, Wis.

circle 425 on inquiry card

**RESOURCE RECOVERY** / A 20-page color brochure describes this firm's four-step program which provides total project responsibility for a resource recovery system—turning municipal solid waste or industrial by-products into fuel for electrical generation or heating use. Services offered include analysis and evaluation, system definition and design, systems implementation and supporting services. ■ Combustion Engineering, Inc., Windsor, Conn.

circle 426 on inquiry card

**ERECTING TOOL** / A compact, lightweight (90 or 160 lbs) power hoist, the *Gripwinch* provides 30- to 60-ft per minute rope travel, and unrestricted length of pull in both directions. The unit's power drive offers constant capacity and easy, fast operation, according to product literature. Drive units with 800-, 1000-, and 2000-lb material hoisting capacities are offered. ■ Griphoist Inc., Westwood, Mass.

circle 427 on inquiry card  
more literature on page 145

# Granite.

## Not-so-pedestrian plazas for pedestrians.

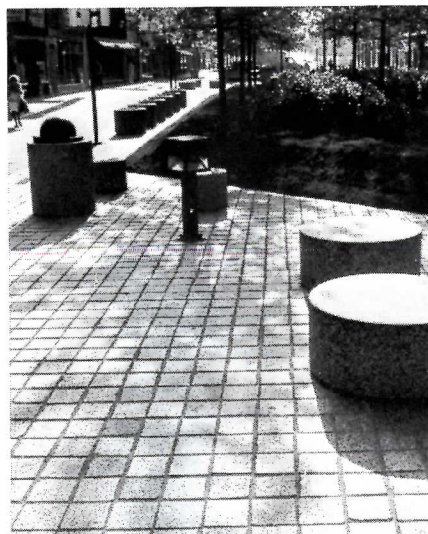

Architect: Joe Karr & Associates, Chicago, IL  
Sturr Young, Associate Architect, Oak Park, IL

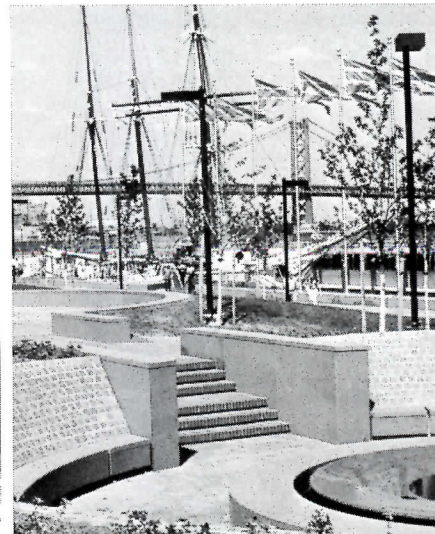

Architect: Murphy Levy Wurman, Philadelphia, PA  
Project Architect: Vincent Maiello, Philadelphia, PA

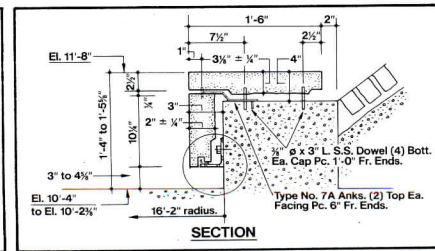
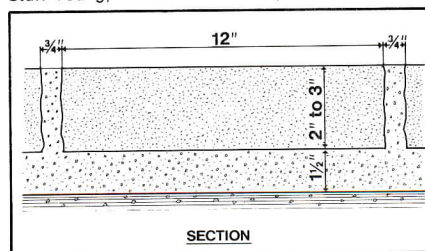

Granite is the elite paving material for plazas, walkways and mall areas where a combination of beauty, durability and ease of maintenance is required.

Granite is a natural building material and it naturally complements the landscaping portions of your architectural design. A wide selection of features including fountains and seating areas are available to enhance the overall appearance of your project. For more information, plus a packet of full color literature illustrating our products in use, call toll free **800-328-7038**. In Minnesota, call (612) 685-3621 or write to the address below.

**Cold Spring Granite Company**, Dept. AR-3 202 South 3rd Avenue, Cold Spring, MN 56320

For more data, circle 69 on inquiry card

# Shoppers to attract, traffic to flow packages to carry. This is the place for Stanley automatic entrances



**SHOPPING HRS**  
MON.-FRI. 9:00-5  
SAT. 9:00-9  
SUN. 12:00-5

Retail stores and shops find it good business to ease the way for busy customers. Bulky packages, umbrellas, children in tow. These are the problems that Stanley automatic doors are designed to answer. They're also engineered to provide broad architectural flexibility and years of trouble-free use. Everything, in fact, you expect from the originator and world's foremost maker of quality automated doors. Stanley Door Operating Equipment, a Division of The Stanley Works, Farmington, CT 06032.

**STANLEY**  
helps you do things right.™

For more data, circle 70 on inquiry card

# The essential one-volume Mumford on Architecture

## LEWIS MUMFORD ARCHITECTURE AS A HOME FOR MAN

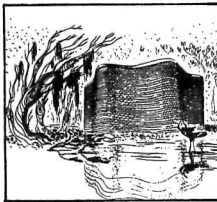
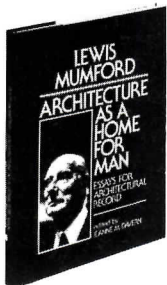

9 x 12", 224 pp.  
Illustrated

Lewis Mumford's complete writings for *Architectural Record* are now collected together in one definitive volume. These 24 important essays span 50 years of the career of America's foremost architectural and social critic, and show the wide scope of concerns that have earned Mumford a unique place among the major thinkers of the 20th century.

Reproduced exactly as they first appeared in the pages of *Architectural Record*, these influential writings are arranged within one handsomely designed volume into five "mini-books":

- *American Architecture Today*
- *Mass Production and the Modern House*
- *The Life, the Teachings and the Architecture of Matthew Nowicki*
- *The Future of the City*
- *Essays, 1937-1968*

The full range of problems now facing America's cities and our built environment as a whole were foreseen by Lewis Mumford long before they became national issues. Mumford's prophetic warnings are now more timely than ever, and the solutions he suggests are just as timely. From mass-produced housing to mass transportation, from urban planning to new towns, from the death of the city to the rise of Megalopolis, the crucial problems of our times are discussed in depth in this one important book.

.....  
Architectural Record Books  
1221 Avenue of the Americas  
New York, New York 10020

Please send me \_\_\_\_\_ copies of *Lewis Mumford: Architecture as a Home for Man* at \$15.00 each.

Name \_\_\_\_\_

Address \_\_\_\_\_

City \_\_\_\_\_

State \_\_\_\_\_ Zip \_\_\_\_\_

Payment must accompany order.

AR-3-78

**ELEVATOR CONTROLS** / Data sheet outlines the vandal-proof features of pushbutton elevator control stations, sized to fit almost any new or existing wall opening. The faceplate is satin-finish stainless steel; jam-resistant push buttons are only 3/16-in. in diameter. ■ C. J. Anderson & Co., Chicago, Ill.

circle 428 on inquiry card

**THERMAL BARRIER WALL SYSTEM** / A color bulletin includes detail drawings and sections, application photos, and full technical data on the *Mirawal* structural wall. Porcelain enamel panels in the system are modular up to 5-ft wide and lengths up to 40-ft; thermal break adapters accommodate thermal windows and doors. Both straight and curved panels are available; fire rated insulation cores meet code requirements. ■ Glasweld International, San Francisco.

circle 429 on inquiry card

**HEAT PUMPS** / Nominal cooling and heating capacities at ARI rating conditions for both condensing units and indoor air handlers are summarized in a 12-page product brochure. Complete performance data for all *Flexhermetic II* split system heat pumps are included; engineering and electrical information is given on various accessories are described. ■ Fedders Air Conditioning Sales Co., Edison, N.J.

circle 430 on inquiry card

**CLASSROOM VENTILATOR** / Full engineering data for the self-contained *UNivent* classroom unit ventilator system are given in a 36-page product bulletin. Capacity, electrical, and basic performance characteristics are included; wiring diagrams, steam and hot water pipe arrangements, sequence of operation, and controls are also described. Different models are shown in detail drawings and exploded views. ■ American Air Filter Co., Louisville, Ky.

circle 431 on inquiry card

**HISTORIC PRESERVATION GUIDE** / "Wallpapers in Historic Preservation" is a new publication prepared for the preservation handbook series of the Office of Archeology and Historic Preservation of the National Park Service. The 60-page book has extensively illustrated and annotated chapters on historic wallpaper technology; a survey of paper styles and their use; and applications and sources for appropriate wallpapers within a restoration project. ■ Priced at \$2.20 a copy, the handbook (#24-005-00685-1) is available from the Superintendent of Documents, U.S. Govt. Printing Office, Washington, D.C. 20402.

**BUILDING SYSTEMS** / A full-color brochure describes such proprietary construction techniques as the *Triodetic* space frame, which provides curved ceiling structures in any mathematically derived geometric shape; *Widespan* rigid framing for a pitched roof profile; and the *Space Grid*, for multi-story, flat-roofed buildings with total rearrangement flexibility of walls, partitions, mechanical and electrical systems. "Architectural Building Systems" is illustrated with installation photos, as well as drawings of framing and roof details. ■ Butler Mfg. Co., Kansas City, Mo.

circle 432 on inquiry card

**CARPET SQUARES** / Illustrated folders describe both needlepunch and tufted-type carpet, available in individual squares for heavy-traffic commercial and institutional applications. All colors of each pattern are pictured; technical specifications, including flammability ratings, are listed. Carpet squares are totally interchangeable, and can be freely rotated from heavy- to light-traffic areas to equalize wear. ■ Heuga U.S.A., Inc., Kenilworth, N.J.

circle 433 on inquiry card

## NEW SITELITE 5

*for the added touch of beauty  
in architectural landscapes...*

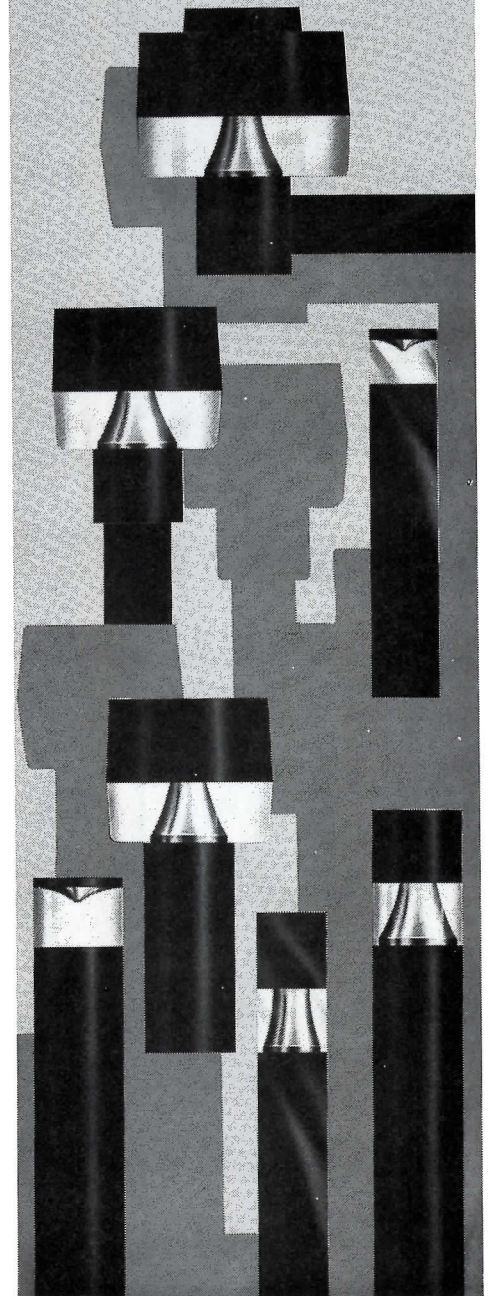

Here's a bright, new design collection of graceful bollards and indirect mid-level post lights... Square and round luminaires and poles, various heights, and companion models for wall mounting. Fresh, harmonious designs to help blend today's newly-created sites with their structures and total environment.

**SITELITE 5** from McPhilben. It's the added touch of beauty from the experts in outdoor lighting.

**mcPhilben**<sup>®</sup>  
mc PHILBEN LIGHTING  
EMERSON ELECTRIC CO.  
EMERSON<sup>®</sup>  
270 LONG ISLAND EXPRESSWAY/MELVILLE, N.Y. 11746  
CANADA: P.O. BOX 150, MARKHAM, ONTARIO

For more data, circle 71 on inquiry card

# STAGGERED TRUSS STEEL FOUR WEEKS CONSTRUCTION







We're checked  
into 243 luxury hotels  
worldwide.

American-Standard Export is supplying sanitaryware products, service and technological back-up to an astonishing number of foreign hotel projects. In South and Central America, Africa, the Far and Middle East.

The reasons are not hard to find. We have the product depth, servicing expertise, and flexible delivery to meet the often exasperating requirements of international building.

If you're anticipating a hotel project on foreign soil, and want some expert help on sanitaryware, call American-Standard Export.

Call or write to Bill Phillips, International Accounts Manager.

American-Standard Export, PO Box 200,  
New Brunswick, New Jersey 08903. (201) 885-1900



*For more data, circle 100 on inquiry card*

You waste  
a lot of water  
when you use flush tanks  
instead of  
Sloan Flush Valves.

Figure it out for yourself.

Number of  
tank toilets in  
your building

Number of gallons  
a Sloan Flush Valve  
saves compared  
to a flush tank

Total number of  
gallons wasted  
by flush tanks  
on every flush

Plus the number  
of gallons wasted  
by unnoticed leaks

$$\boxed{\phantom{000}} \times 0.64 = \boxed{\phantom{000}} + \boxed{?}$$

No matter what figure you got, remember it's only for a single flush. Think of how many times all the toilets in your building are flushed every day. Every month. And since every Sloan Flush Valve uses 0.64 gallon less than a flush tank, think of how much water you could be saving, instead of wasting. What's more, a Sloan Flush

Valve saves you money by using this same minimum water volume with every flush. No more, no less. That's because it completes its cycle, then shuts off automatically. Again, there's less water wasted and a lower water bill. Remember, it takes energy to pump water. The less water you have to pump, the less energy you

have to pay for. So stop wasting water and start saving money. To tell you how, we'd like you to have the test report from an independent laboratory that proves Sloan Flush Valves use 0.64 of a gallon less than tanks. For your free copy, just write to us.



Sloan  
Flush  
Valves.

Anything else  
is a waste  
of money.



**SLOAN VALVE COMPANY**

10500 SEYMOUR • FRANKLIN PARK, ILL. 60131