

DIVISION 1 OFFICE EQUIPMENT & SUPPLIES

COMPUTERS
 INFORMATION SYSTEMS
 INSTRUCTION MANUALS
 MAINTENANCE/OPERATIONAL EQUIPMENT
 OFFICE MACHINES
 OFFICE SUPPLIES
 REPRODUCTION EQUIPMENT

DIVISION 2 SITE WORK

CAISSONS
 DEMOLITION
 EARTHWORK
 FENCES & GATES
 FOUNTAINS & POOLS
 IRRIGATION SYSTEMS
 LANDSCAPING
 MARINE WORK
 PAVING & SURFACING
 PILE FOUNDATIONS
 RAILROAD WORK
 RECREATIONAL FACILITIES
 SHORING
 SITE DRAINAGE
 SITE FURNISHINGS
 SITE UTILITIES
 SOIL TREATMENT
 TUNNELING

DIVISION 3 CONCRETE

CAST-IN-PLACE CONCRETE (Design information only)
 CEMENTITIOUS DECKS
 CONCRETE ACCESSORIES
 CONCRETE FORMWORK
 CONCRETE MATERIALS
 CONCRETE REINFORCEMENT
 PRECAST CONCRETE

DIVISION 4 MASONRY

MASONRY ACCESSORIES
 MASONRY RESTORATION & CLEANING
 MORTAR
 REFRACTORIES
 SIMULATED MASONRY
 STONE
 UNIT MASONRY

DIVISION 5 METALS

EXPANSION CONTROL
 FASTENERS & SUPPORTS
 GRATINGS
 LIGHTGAGE METAL FRAMING
 METAL CASTINGS
 METAL DECKING
 METAL FABRICATIONS
 METAL JOISTS
 METAL STAIRS
 METALS & ALLOYS (includes finishes)
 RAILINGS & HANDRAILS
 STRUCTURAL METAL FRAMING

DIVISION 6 WOOD & PLASTICS

ARCHITECTURAL WOODWORK
 CONNECTORS & SUPPORTS
 LAMINATED & PROCESSED SHEETS
 LUMBER
 PLASTIC FABRICATIONS
 PLASTIC LAMINATES
 PREFABRICATED STRUCTURAL PLASTICS
 PREFABRICATED STRUCTURAL WOOD
 SIMULATED WOOD
 STOCK MILLWORK
 WOOD TREATMENT

DIVISION 7 THERMAL & MOISTURE PROTECTION

CLADDING/SIDING
 COMPOSITE BUILDING PANELS
 FLASHING
 INSULATION
 MEMBRANE ROOFING
 METAL ROOFING
 PREFORMED WALL & ROOF PANELS
 ROOF ACCESSORIES
 ROOFING SPECIALTIES
 SEALANTS
 SHINGLES & ROOFING TILES
 TRAFFIC TOPPING
 VAPOR BARRIERS/RETARDANTS
 WATERPROOFING & DAMPPROOFING

DIVISION 8 DOORS & WINDOWS

ENTRANCES & STOREFRONTS
 GLAZING
 GLAZING ACCESSORIES
 HARDWARE & SPECIALTIES
 METAL DOORS & FRAMES
 METAL WINDOWS
 SPECIAL DOORS
 SPECIAL WINDOWS
 WINDOW WALLS/CURTAINWALLS
 WOOD & PLASTIC DOORS
 WOOD & PLASTIC WINDOWS

DIVISION 9 FINISHES

ACOUSTICAL TREATMENT
 ADHESIVES
 CARPETING
 CEILING SUSPENSION SYSTEMS
 GYPSUM WALLBOARD
 FLOOR TREATMENT
 LATHING MATERIALS
 PAINTING MATERIALS
 PLASTER
 PREFINISHED PANELS
 RESILIENT FLOORING
 SPECIAL COATINGS & SURFACINGS
 SPECIAL FLOORING
 TERRAZZO
 TILE
 WALL COVERING
 WOOD FLOORING

DIVISION 10 SPECIALTIES

CHALKBOARDS & TACKBOARDS
 COMPARTMENTS & CUBICLES
 LOUVERS & VENTS
 ACCESS FLOORING
 FIREPLACES
 FLAGPOLES
 GRILLES & SCREENS
 IDENTIFYING DEVICES
 LOCKERS
 PEDESTRIAN CONTROL DEVICES
 PEST CONTROL
 POSTAL SPECIALTIES
 PARTITIONS
 PROTECTIVE COVERS
 SCALES
 SPECIALTY MODULES
 STORAGE SHELVING
 SUN CONTROL DEVICES
 TELEPHONE ENCLOSURES
 TOILET & BATH ACCESSORIES
 WALL & CORNER GUARDS
 WARDROBE SPECIALTIES

DIVISION 11 EQUIPMENT

ATHLETIC EQUIPMENT
 BANK & VAULT EQUIPMENT
 BUILT-IN MAINTENANCE EQUIPMENT
 CHECKROOM EQUIPMENT
 COMMERCIAL EQUIPMENT
 DARKROOM EQUIPMENT
 DETENTION EQUIPMENT
 ECCLESIASTICAL EQUIPMENT
 EDUCATIONAL EQUIPMENT
 FOOD SERVICE EQUIPMENT
 INDUSTRIAL EQUIPMENT
 LABORATORY EQUIPMENT
 LAUNDRY EQUIPMENT
 LIBRARY EQUIPMENT
 LOADING DOCK EQUIPMENT
 MEDICAL EQUIPMENT
 MORTUARY EQUIPMENT
 MUSICAL EQUIPMENT
 PARKING EQUIPMENT
 REGISTRATION EQUIPMENT
 RESIDENTIAL EQUIPMENT
 THEATER AND STAGE EQUIPMENT
 VENDING EQUIPMENT
 WASTE HANDLING EQUIPMENT

DIVISION 12 FURNISHINGS

ARTWORK
 FABRICS
 FLOOR MATS
 FURNISHING ACCESSORIES
 FURNITURE
 RUGS
 SEATING
 WINDOW TREATMENT

DIVISION 13 SPECIAL CONSTRUCTION

AIR SUPPORTED STRUCTURES
 INTEGRATED ASSEMBLIES
 INTEGRATED CEILINGS
 PREFABRICATED BUILDINGS
 RADIATION PROTECTION
 RADIO-FREQUENCY SHIELDING
 SPECIAL PURPOSE ROOMS & BUILDINGS
 SOUND & VIBRATION CONTROL
 SWIMMING POOLS
 TOTAL ENERGY SYSTEMS

DIVISION 14 CONVEYING SYSTEMS

CONVEYORS & CHUTES
 DUMBWAITERS
 ELEVATORS
 HOISTS & CRANES
 LIFTS
 MOVING STAIRS & WALKS
 PNEUMATIC TUBE SYSTEMS
 POWERED SCAFFOLDING
 TURNABLES

DIVISION 15 MECHANICAL

AIR DISTRIBUTION EQUIPMENT
 AIR TREATMENT EQUIPMENT
 HEAT GENERATION
 COMBUSTION EXHAUST EQUIPMENT
 FIRE PROTECTION EQUIPMENT
 FUEL HANDLING EQUIPMENT
 HEAT EXCHANGERS
 HEAT PUMPS
 HVC TERMINAL UNITS
 LIQUID WASTE EQUIPMENT
 MECHANICAL CONTROLS
 MECHANICAL INSULATION
 MECHANICAL SUPPORTING DEVICES
 MECHANICAL VIBRATION ISOLATION
 PIPING & SPECIALTIES
 PLUMBING FIXTURES & TRIM
 PUMPS & COMPRESSORS
 REFRIGERATION EQUIPMENT
 SELF-CONTAINED HVC UNITS
 TANKS & BASINS -
 VALVES
 WATER SUPPLY & TREATMENT

DIVISION 16 ELECTRICAL

COMMUNICATIONS
 CONDUCTORS
 ELECTRICAL HEATING - COOLING
 ELECTRICAL & ELECTRONIC CONTROLS
 ELECTRICAL SUPPORTING DEVICES
 ELECTRONIC EQUIPMENT
 LIGHTING
 MOTORS & CONTROLS
 POWER GENERATION
 POWER TRANSMISSION
 PROTECTIVE SYSTEMS
 RACEWAYS
 SERVICE & DISTRIBUTION
 WIRING DEVICES

PRODUCT REPORTS 74: BEST NEW AND IMPROVED PRODUCTS, ALL ILLUSTRATED

THINKING ABOUT PRODUCTS AT SELECTION TIME

ARCHITECTURAL ENGINEERING: ENERGY CONSERVATION—NEW PRODUCTS, NEW SYSTEMS

ARCHITECTURAL BUSINESS: SPECIFICATIONS—WHO'S IN THE DRIVER'S SEAT?

FULL CONTENTS ON PAGE 3

ARCHITECTURAL RECORD

MID-OCTOBER 1973

A MCGRAW-HILL PUBLICATION THREE DOLLARS PER COPY





A floor that's practical, quiet, and comfortable can also be beautiful. Quiet Zone™ proves it.

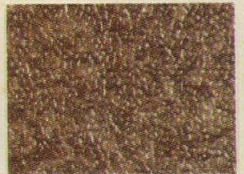
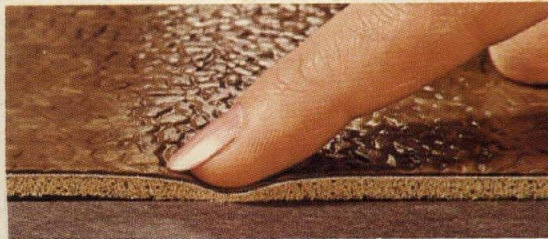

What's so practical about Quiet Zone?

A heavy-duty wear layer of Vinyl Corlon® stands up to heavy-duty traffic. We've even reinforced it with a tough layer of glass-fiber-reinforced vinyl to resist impact damage. And virtually non-porous vinyl has excellent stain resistance. Spills wipe right up. That's what's so practical about Quiet Zone.

What's so quiet and comfortable about Quiet Zone? Look at the inset picture. A 125-mil-thick backing of foam vinyl helps to muffle the sounds of footsteps and falling objects. It makes standing and walking more comfortable. But it isn't too soft, either. Seams stay sealed, and moveable furniture moves easily on it.

OK, fine. Now what's so beautiful about it?

Quiet Zone's new Grand Central design blends nicely into practically any decor. It is richly textured and comes in an appealing selection of colors. What's more, it helps disguise seams, subfloor irregularities, dirt, and traffic marks. That's the beauty of Quiet Zone.

Quiet Zone. So soft and quiet you wouldn't think it's vinyl. So tough and long wearing you know it has to be.

FROM THE  INDOOR WORLD® OF

Armstrong

For more data, write A1 on inquiry card

For more information on Quiet Zone, write Armstrong,
304 Rock Street, Lancaster, Pa. 17604.

NAME _____

COMPANY _____

ADDRESS _____

CITY _____ STATE _____ ZIP _____



Specify interiors like this in half the time.

Devoe Paint® and Devoe CDT® vinyl wall coverings, a color coordinated combination that makes decorating commercial interiors faster and easier. All commercial weight CDT wall coverings are cross-referenced to Devoe interior paint colors. Which means you can now specify a complete interior—vinyl wall covering and paint—in minutes. So if you select the "Raja-Sari" pattern of wall covering, you'll find out in a second that two complementary paint colors are Pink Feather and Burnt Orange; they're all shown together. You can specify all three at once... all from one supplier. Cut your specifying time in half. Write: Devoe Paint, One Riverfront Plaza, Louisville, Kentucky 40202.



CDT™ Vinyl Wall Coverings

IMAGINATION FROM  ELANESE®

For more data, write A2 on inquiry card

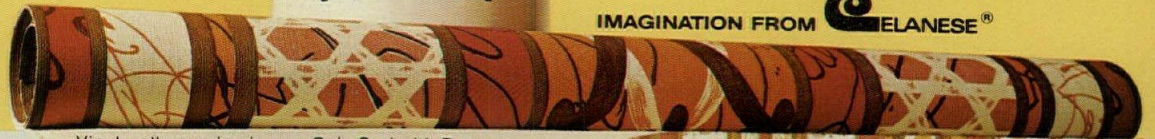

Vinyl wall covering is new Raja-Sari with Devoe Burnt Orange and Pink Feather paint colors.



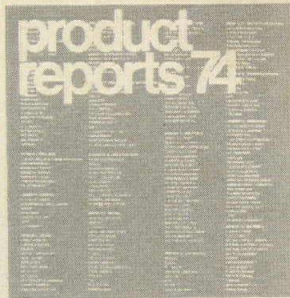

Cover: The 16-division format of the Uniform Construction Index provides the basis of organization of new products in this issue.

EDITOR

WALTER F. WAGNER, JR., AIA

MANAGING EDITOR

HERBERT L. SMITH, JR., AIA

SENIOR EDITORS

ROBERT E. FISCHER
WILLIAM B. FOXHALL
MILDRED F. SCHMERTZ, AIA
ELISABETH KENDALL THOMPSON, FAIA

WASHINGTON EDITOR

ERNEST MICKEL, Hon. AIA

ASSOCIATE EDITORS

BARCLAY F. GORDON
CHARLES E. HAMLIN

ASSISTANT EDITORS

GERALD ALLEN
CHARLES K. HOYT
ANNETTE K. NETBURN

DESIGN

ALEX H. STILLANO, Director
ALBERTO BUCCHIANERI, Associate
ANNA-MARIA EGGER, Assistant
MURIEL CUTTRELL, Illustration
J. DYCK FLEDDERUS, Illustration
JAN WHITE, Consultant

EDITORIAL CONSULTANTS

EDWARD LARRABEE BARNES, FAIA
JONATHAN BARNETT, AIA, Urban design
GEORGE A. CHRISTIE, JR., Economics
ROBERT F. HASTINGS, FAIA
PAUL RUDOLPH, FAIA
DAVID STEWART, Foreign architecture
L'Architecture d'Aujourd'hui, Paris

McGRAW-HILL WORLD NEWS

WALTER A. STANBURY, Director
10 domestic and 8
international news bureaus:
Bonn, Brussels, Buenos Aires,
London, Milan, Moscow, Paris,
Tokyo.

SALES MANAGER

LOUIS F. KUTSCHER

CIRCULATION MANAGER

HUGH S. DONLAN

PUBLISHER

BLAKE HUGHES

THE RECORD REPORTS

5 Editorial

The architect-manufacturer dialogue: the same old beat goes on.

FEATURE

7 Thinking about products at selection time

The ideal system for getting product information would be instant wish-fulfilment. But Miriam Eldar writes about the existing alternates.

ARCHITECTURAL BUSINESS

11 Specifications: Who is in the driver's seat

New research by John Eaton of Sweet's shows that the architect's specs hold up in installation 86 per cent of the time.

ARCHITECTURAL ENGINEERING

13 New products and energy conservation . . . in experimental buildings

Energy conservation is now a pressing problem for everyone. Here is an update on practical progress.

192 Manufacturers' Index

A listing of producers and their addresses, for companies featured in the Product Reports section.

195 Advertising Index

READER SERVICE INQUIRY CARDS

Back inside cover fold-out.
Additional inquiry coupons, page 126.

PRODUCT REPORTS 74

17 Introduction

Tips to help you use this issue.

19 Office supplies & equipment—UCI 1

Time- and money-saving ideas.

27 Sitework—UCI 2

Products to use in open spaces.

31 Concrete—UCI 3

New finishes, formwork and uses.

35 Masonry—UCI 4

New shapes, designs and panels.

41 Metals—UCI 5

Structural and decorative uses.

49 Wood & plastics—UCI 6

New applications and designs.

53 Thermal & moisture protection—UCI 7

Sealants, insulation, cladding.

67 Doors & windows—UCI 8

New safety, design and protection.

87 Finishes—UCI 9

Interior and exterior products.

105 Specialties—UCI 10

Modularity continues an uptrend.

115 Equipment—UCI 11

Labor-savers—new and smaller.

131 Furnishings—UCI 12

Products to answer design challenges.

147 Special construction—UCI 13

Better-performing packages.

151 Conveying systems—UCI 14

Materials- and people-movers.

159 Mechanical—UCI 15

More refinements in climate control.

177 Electrical—UCI 16

Big steps for lighting products.

ARCHITECTURAL RECORD, (Combined with AMERICAN ARCHITECT, ARCHITECTURE and WESTERN ARCHITECT AND ENGINEER) Mid-October 1973, Vol. 154 No. 5. Title ® reg. in U. S. Patent Office © copyright 1973 by McGraw-Hill, Inc. All rights reserved. Published monthly except May and October when semi-monthly, by McGraw-Hill, Inc. EXECUTIVE EDITORIAL, CIRCULATION AND ADVERTISING OFFICES: 1221 Avenue of the Americas, New York, N. Y. 10020. Other Editorial Offices: 425 Battery Street, San Francisco, Cal. 94111; 1249 National Press Building, Washington, D. C. 20004. PUBLICATION OFFICE: 1500 Eckington Place, N.E., Washington, D.C. 20002; second class postage paid at Washington, D. C. and at additional mailing offices. OFFICERS OF McGRAW-HILL PUBLICATIONS COMPANY: John R. Emery, president; J. Elton Tuohig, executive vice president-administration; David J. McGrath, group publisher-vice president; senior vice

presidents: Ralph Blackburn, circulation; Walter A. Stanbury, Jr., editorial; John B. Hoglund, controller; David G. Jensen, manufacturing; Gordon L. Jones, marketing; Jerome D. Luntz, planning & development. CORPORATION OFFICERS: Shelton Fisher, president; Wallace F. Traendly, group president—McGraw-Hill Publications Company and McGraw-Hill Information Systems Company; John J. Cooke, senior vice president and secretary; Ralph S. Webb, treasurer. SUBSCRIPTIONS: Subscriptions solicited only from architects and engineers. Position, firm connection, and type of firm must be indicated on subscription orders; CHANGE OF ADDRESS or subscription service letters should be forwarded to Fulfillment Manager, ARCHITECTURAL RECORD, P.O. Box 430, Hightstown, N. J. 08520. Annual subscription prices: U.S., U. S. possessions and Canada: \$9.00 for architects, engineers and other individuals in the fields served, all others \$20.00. Other countries: \$22.00 to architects, engineers; others

\$30.00. Single copies \$3.00. UNCONDITIONAL GUARANTEE: Publisher agrees to refund that part of subscription price applying to unfilled part of subscription if service is unsatisfactory. ASSOCIATED SERVICES/McGraw-Hill Information Systems Co.: Sweet's Catalog Files (Architectural, Light Construction, Interior Design, Industrial Construction, Plant Engineering, Canadian Construction), Dodge Building Cost Services, Dodge Reports and Bulletins, Dodge/SCAN Microfilm Systems, Dodge Management Control Service, Dodge Construction Statistics, Dodge regional construction newspapers (Chicago, Denver, Los Angeles, San Francisco). POSTMASTER: Please send form 3579 to Fulfillment Manager, ARCHITECTURAL RECORD, P.O. Box 430, Hightstown, N. J. 08520.





Classic Revival

FLOORING AS TIMELESS AS IT IS TIMELY— NEW CLASSIC ELITE™ FROM FLINTKOTE.

A floor of cool, classic beauty. CLASSIC ELITE reinforced vinyl tile by Flintkote has a quality of elegant understatement. Not only does its subtle marble-chip pattern give the floor a continuous flow...it opens new design possibilities as well. Everything from traditional simplicity to modern super-graphics. The smooth, tight, easy-to-clean surface is timeless, too. Enduring under heavy commercial traffic. Incomparable in elegant homes.

FLINTKOTE® FLOORING PRODUCTS
480 Central Avenue, East Rutherford, New Jersey 07073



For more data, write A3 on inquiry card

Architect-manufacturer dialogue: the same old beat goes on

New building products—like any of the nearly 1000 shown on the pages of this issue—do not exist in a vacuum. They are always part of a bigger part or assembly or sub-system or component that in turn is part of a finished building.

Architects and engineers are of course interested essentially in the finished building—though they live every day with the problems of assembling the products and parts and assemblies and sub-systems and components that add up to that building.

Manufacturers on the other hand are concerned first, as they must be, with producing and competing in the marketplace to sell their new products.

And that very simple, perfectly obvious dichotomy is the cause of more talk, more meetings, and much more controversy than, it seems to me, is useful or helpful.

For example . . .

Recently I was chairman of a seminar billed as Design Trends in Architecture—and How They Might Affect Products and Manufacturers. The audience was made up of building-industry executives—most of considerable title and responsibility. I asked three friends to appear on the panel—Lew Davis of Davis, Brody & Associates; Dan Toan of Warner, Burns, Toan & Lunde; and Hugh Jacobsen.

So there, on a podium with microphones and glasses of water, were three fine designers—Lewis Davis, who has gotten more housing built (in New York City, under the most difficult conditions of budget and red tape and racial distress) than any architect I can think of, and who gets it built well, and with design style and with social consciousness.

Then there was Dan Toan, whose firm was deeply involved in an Operation Breakthrough consortium and who—now that the dust has settled and the manufacturer members have (prudently, from a financial point of view) withdrawn—continues to work with the system (known as the Townland system) not because they think it will make them rich but because they think it is a good system (not just because it is technically interesting, but because it creates a whole new living style for urban families—for one thing, providing gardens for each family outside the living room of their apartment three or four or six stories above the street). Toan's firm was also deeply interested in studies relating to living in outer space—a brand-new kind of technology and design problem and, perhaps, product opportunity.

And there was Hugh Jacobsen, who designs some of the handsomest single-family houses in the country, and who has been deeply involved in high-quality development building, who has a great deal of work abroad—and who makes standard products work, through enormous attention to detailing, in very special custom work.

These men were introduced as being there because of those qualifications. And what did we talk about at the meeting?

Who actually specifies building products? Again? Really? (For those who find it difficult to live with the basic old truth that architects specify building products, there's new research—detailed in the Architectural Business section of this issue a few pages back—that shows that architects' specifications hold up, to be exact, 86 per cent of the time.)

Then we got into the question of whether direct sales calls, Sweet's Catalogs, magazine advertising, or direct mail was "the best way to reach architects." After all these years?

Then we got into energy conservation (Yes, architects care about energy conservation but now many clients seem much interested).

And so on. Well, I'm exaggerating of course. And if the session went over the same old ground instead of exploring new ideas, I'm ready to share the discussion leader's share of the blame. But there's a point:

The industry faces serious problems. Costs are still insane. There's a real money shortage for building—and the outlook for anything but high-priced housing ought to be scaring the pants off all of us. The Feds are deep into setting up tough specifications on all kinds of products that conserve energy—and no one but a few of the bigger and more enlightened manufacturers seems interested. Codes and safety standards tighten around us like a noose.

There are all kinds of exciting ideas out there. For just two examples: Lew Davis wanted to talk about encapsulated space—villages under air structures. Dan Toan wanted to talk about the implications for earth-bound design of experiments in space environments.

It seems to me that, when the leadership of the key elements of the building industry get together, that we ought to be talking about those problems. Because—together—we've got to solve them.

The next quarter will be over in three months. What we've got to think about and talk about and struggle with is the future—which will last a long time, and in which we all have to live.

—Walter F. Wagner Jr.

Now you can have better air



with a better look by AAF

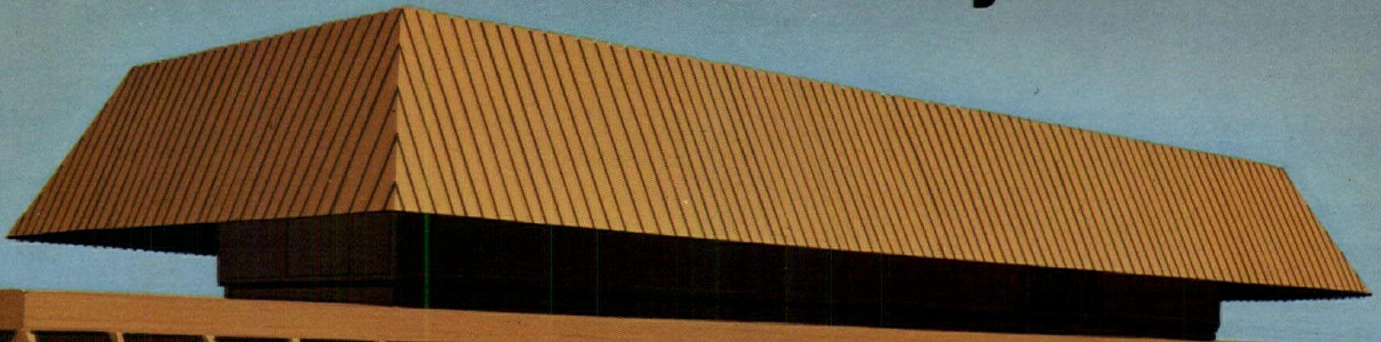

Now there are three roof-mounted HVAC systems from AAF: Mark 9, Mark 13, Mark 20. From 3,000 cfm to 20,000 cfm. Ten tons to sixty tons. And each one offers significant advantages like reheat capability, solid state controls, high efficiency gas furnaces and more filter options than any other HVAC system offered today. That's the inside story.

The outside story is our new AAF exclusive facade system to blend the Mark 13 and Mark 20 into your design environment.

You no longer have to rely on expen-

sive penthouses or roof-penetrating fences to hide the spartan, mechanical appearance of roof-mounted HVAC equipment. With our new architectural facade system, multizone camouflage is simple and economical. Roof integrity is never threatened because facade supports are extensions of the rugged AAF HVAC frame. There is no roof penetration with its accompanying problems.

If our standard corrugated aluminum facade, which is available in ten colors, doesn't meet your needs, you can do it yourself. Use our unique

facade frame with a facia material of your own choice and design.

Choose from a mansard type slope design, or a straight-line look. And, servicing the units is no problem either. There's plenty of room for routine service without removing the facia.

For complete details, write: Air Handling Products and Systems, AAF, Dept. 389, Box 1100, Louisville, Ky. 40201. In Canada: 400 Stinson Blvd., Montreal 9, P. Q.

Better Air is Our Business.



American Air Filter

AIR HANDLING PRODUCTS AND SYSTEMS

Thinking about products at selection time

by Miriam S. Eldar, AIA—manager, Sweet's Guidelines, McGraw-Hill Information Systems

Mrs. Eldar, a practicing architect, has for the last four years been deeply involved in research on various aspects of construction product/process information, toward improved content, organization and coordination.

The ideal way to select products would be on the basis of instant wish-fulfillment. The architect or engineer thinks his requirements into a marvelous sensor device, a series of whirrs and buzzes ensues, and the exact product to match his needs jumps out, its performance specified, documented and guaranteed.

To achieve or at least approximate this situation is not impossible—a central computerized data-bank of componentized handbook information coupled with corresponding manufacturers' data on existing products could do the job. But such a system is surely years away. So it is important to see that whatever steps we take to improve the present situation should be designed to take us in this direction consistently—even if not very rapidly. In the meantime, the search for the right product, its evaluation, selection and specification remain a time-consuming, frustrating and risk-laden chore. It is a chore that becomes less manageable with every passing day, as the number of products increases and their familiarity decreases; as products become ever more complex, more sophisticated in structure and function; and as new products and pseudo-new products multiply. The more complex and more untried a product, the more important is a sound evaluation, yet the less adequate the information available, the fewer and less applicable the tests. Moreover, in dealing with the complex and the new, our own expertise often fails us and we can hardly identify the problems much less evaluate soundly what scant information we have.

Last year ARCHITECTURAL RECORD's PRODUCT REPORTS 73 carried an article that dealt with the problem of making the deluge of product information retrievable. This year we will consider a dual problem:

- How to help the professional approach product selection more effectively to save time and facilitate sound decisions.
- How to generate product information that will not only be retrievable, but worth retrieving.

Let us try to analyze the product selection process to see what should characterize our thinking about products and how that thinking

should be reflected in the content and organization of our product information.

When are new products selected? selection time is anytime

Product selection is far from being a sometime occupation. It is a process which unfolds in tandem with the project—from programming, design and development through to specifications, bidding and sometimes even construction. Product decisions of the broadest nature are made during the preliminary conferences with the client. Product decisions are still made when the project has been completed and is in operation.

However, the kind of broad consideration given products during preliminary design differs from the detailed investigation carried out at specification time, while during bidding and construction yet other factors (usually instant availability) come into play. The kind and depth of information needed at these various points in project development also differs accordingly. Therefore, we need to think about products in various ways at various times and we need information suited in kind and sequence to the development of our thinking.

Product selection is a joint effort —but the decision rests on the architect

Product selection is a responsibility shared by all concerned in the project. Architectural designers, consulting engineers, detailers, specifications and materials specialists, contractors, owners—all contribute toward the final product selection decision, each from his own particular point of view.

In looking at a curtain wall, for example—the architect will focus on appearance, weather-tightness, etc.; the structural engineer thinks in terms of forces, stresses, motion and deflections; the mechanical engineer sees heat-gain and heat-loss and is looking for spaces to get his ductwork in; the lighting expert thinks of light transmission and diffusion patterns—and so on. A sound final selection by the architect—the coordinator and generalist—must allow for and incorporate all these various factors and considerations, and translate them into a full grasp of the total product and of its behavior as a whole. It is only then that the specifications writer, in addition to his over-all contribution to selection, exercises his special function—to wrap up and fully define the consensus and assure its complete, correct

inclusion in the project. Even if we assume that each of the professionals involved carries a complete image of the project in his mind, these will be very different images, stressing different aspects. We must strive toward a common model, a common frame of reference for everyone involved, a frame designed to relate the various points of view and be worked on until a synthesis is arrived at.

The product data to fit this attitude, while adapted to each function separately, will have to provide enough insight into the considerations of all the others to lead toward fuller understanding and cooperation.

A product cannot be judged by itself—but must be seen as part of the project

Any product—particularly the composite product like a curtain wall and the new product about which little is known—must be viewed as a functioning entity within that larger entity which is a building. A thorough investigation of its various components and materials is no assurance of the performance of the whole.

For example, the functioning of a curtain wall (as has been recently demonstrated) cannot be predicted on the basis of the properties of the glass alone, or of the supporting members alone. It will depend upon the interaction of the various components, on the motion of the curtain wall against the building's structural skeleton, on its relative flexibility or rigidity. It will depend on temperature differential between the indoors and the outdoors, on relative humidity and its rapidity of change, on expected wind loads, and on a host of similar considerations. Serious failures of the product in the building are far more likely to be caused by critical conditions resulting from this complex interaction than from product defects.

Here again then, our need is for an integrative tool, for an abstract model that will pinpoint the product within its physical and functional contexts. Once this has been done, identifying the various aspects of the product and of its interaction with other components which need to be investigated, becomes far easier and more reliable.

Performance-orientation is one thing—performance specs are another

So far our requirements of product information to match our thinking have been: 1) completeness and technical precision, and 2) a uniform organization arranged in depth and sequence to reflect the attitudes of the various people involved at various points in the development of the project.

Full descriptive information on a complex product would be so voluminous as to be totally unmanageable. For example, describing a complete facility, even a relatively simple one such as a prefabricated warehouse, would require a full set of contract documents. But if the components of that warehouse have been previously assembled, tested and documented as to performance, then it can be specified more simply as a whole. As we have said, the characteristics of the total product are not necessarily the sum of the characteristics of its parts and materials. For all these reasons, performance-oriented data on the total product are increasingly a "must." But . . .

A clear line needs to be drawn between performance-oriented data and true performance specifications.

The essence of the true performance specification statement lies in that it describes the desired results without defining the means by which these results are to be obtained. Its greatest value is in that it leaves the door wide open to creative innovation. It can be used to greatest advantage in projects with special and unusual requirements, which are large enough to support the cost of innovative design, manufacturing and testing, and which represent a fraction of total construction at present.

A true performance specification describes something that may or may not exist in the real world at the time. However, the moment that performance specification has been met and the object that produces the desired results has been made, the performance specification becomes the performance-oriented proprietary specification for that object.

Performance-oriented information as a rule does identify the object, but attempts to describe it as far as possible in terms of what it does rather than of what it is. At this time none of us is in a position to describe a product fully by its performance, particularly where esthetic performance, is concerned. Nor do we have sufficient reference standards and tests on complete products (rather than on basic materials) to document and assure performance. Performance-orientation, therefore, is a matter of degree—it practices the art of the possible, and fills in the gaps with descriptive information. It should be fostered and developed to the utmost since it is the only path to concise, full and precise data which guides the selector rather than imposing upon him a requirement for expertise he may not possess.

With existing information resources we're a long way from home

Having at least roughly identified what should characterize our mental set in approaching product selection and what we should demand

of our product information, let us turn our attention to the resources available which can help us on our way.

A categorization of products is the first prerequisite toward placing them in the context of construction. This purpose is presently served by the Uniform Construction Index, which has the tremendous advantage of being generally accepted and used. It does not, however, provide a common frame of reference, since simple and complex products are listed side by side and no guidance provided on how they relate to each other, combine into more complex building assemblies, or interact with other products. The complex products, therefore, cannot be readily considered as wholes in any Uniform Construction Index context and closely related, indeed competitive products are "housed" wide apart.

Existing product information, classified by the UCI, is being effectively delivered to the industry by Sweet's Files which offer the largest compendium of product information in hard copy. A number of other services (Showcase, Idac, Spec-Data, etc.) provide collections of information on microfilm/fiche.

However, no matter how effective classification and distribution of information, it is to no avail unless its content and organization answer needs of construction professionals.

Uniform organization and completeness of content are avocated in the AIA and CSI documents on technical information, but not defined or detailed. This has in great measure been achieved by Sweet's GuideLines which call out in detail the specific data needed for each of 230 product categories. But . . . none of these available services provides a complete solution, either alone, or all together.

GuideLines new master organization provides three new basic tools

GL Master Organization, developed as a result of the work done on Sweet's GuideLines, was described on a conceptual basis in the Architectural Business section of the August 1973

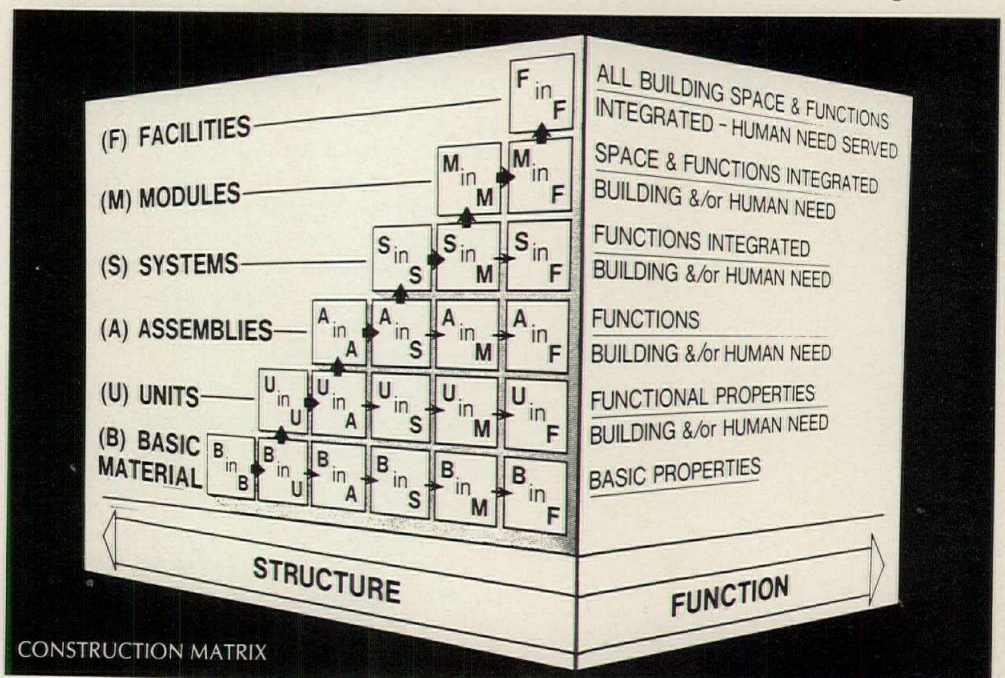

Relates product to project according to its structural and functional complexity. Basic properties—are those inherent in the product; Functional properties—are related to product use; Building functions—those performed to greater or lesser extent by all buildings, e.g., stability; Human need functions—related to human needs served by building, e.g., food service.

issue of ARCHITECTURAL RECORD. At Sweet's we believe, and our belief is shared by a number of professional groups, that this concept offers at least a base for a complete solution, for the achievement of both objectives:

- Systematizing and unifying the approach to product selection for those concerned and;
- Generating product information to fit in with and reflect that intellectual approach.

GL Master Organization offers the following tools:

A Construction Matrix (RECORD, August, 1973 page 65) offers an abstract model of performance-oriented relationships, the necessity for which was discussed above.

The basic GuideLine hierarchy of products according to their complexity in structure and function (from simplest basic material to most complex facility) positions any given product within the project, and defines the function it fulfills within the building. With position and function defined, it becomes clear with what other products any given product will interact, both physically and functionally. It becomes evident, for example, that an enclosure will interact physically and functionally with the structural framework of the building, with lighting, heating, interior facings, finishes, etc. Each of the professionals involved, while pursuing his own particular goals, is constantly reminded of the total, the end-result, the considerations of others which have to be honored and coordinated into final architectural decisions. Throughout the development of a project, starting with the programming and through to completion, the fully developed Construction Matrix can serve as a touchstone against which decisions can be checked and their consequences visualized.

The GuideLine Master Grid (RECORD, August 1973 page 69) provides a graphic summary. Once a product is positioned on the Matrix and its complexity defined, the GuideLine Master Grid graphically summarizes the extent and the major categories of information needed for its full evaluation. The Construction Matrix may be said to represent a simplified model of the end-result to be achieved. The Master Grid may be said to show the general typography and the major way-stations on the road toward the end-result. It also serves to demonstrate the various ways in which the total information can be broken down into separate but coordinated, non-redundant documents, the best to serve various user and marketing needs. From here on, the GL Formats take over.

Only the right questions generate the right answers

As we all know, the success of any search depends mostly on the right questions being asked. The general categories of questions which need to be asked on any construction product are similar enough so that any master outline that allows for the basic differences in products as to structural and functional complexity can serve as a guide to all.

The GL Master Format incorporates six Formats, one for each of the six levels of product complexity. It constitutes a detailed outline of the information needed on a given product as identified on the Grid. The Format maps the

road outlined on the Grid, marks the milestones and the detail configuration. It triggers the selector's mind on the successive sets of questions to be asked, particular characteristics to be looked into at various stages in project development, at points of interaction and compatibility with other products.

The GL concept: an integrative framework

We believe, and again a number of professional groups have agreed, that the GL Master Organization could serve as a unifying framework for all the various information aids and services available and that it could pull them together into a coordinated, compatible whole. It has been increasingly recognized by the professionals involved that the changing design and construction methods and contractual relationships will require some modification of the UCI in the near future. The GL hierarchy of products, offers a way of slowly moving the UCI toward a purer structure-and-function orientation, the only viable orientation in the age of industrialized construction. This could be done without disruption of its present great usefulness or damage to its prestige and acceptance by superimposing the GL dual categorization by structure and function upon the UCI 16 Divisions. All information dealing with the total product and its context would be included under one of the overriding categories. Then the various components and their functions could be dealt with in their respective divisions. If we take an Integrated Ceiling as an example, the total product and its interface could be described under System/Space Division (Lighting, Acoustics, HVAC). Then the ceiling suspension and acoustic lay-in materials would be described in Division 9, the lighting and the distribution network components in 16, the HVAC components in 15. This deceptively simple categorization is a peg upon which many coats can conveniently be hung. For example, the GL hierarchy would be extremely useful as a base for the organization of working drawings and for the coordination of architectural, structural and mechanical sets.

Cost estimating could be organized to the same principle to great advantage—building up from the cost of materials and their manufacture, through parts and components made of those materials and up to the cost of the entire assembled product and its installation.

The same principle, useful and economical effort for any specification, would really come into its own in the development of true performance specifications which cannot be easily cast into any of the existing molds.

The GL Format could also easily generate a CPM Schedule for the selection of products to fit and facilitate project design and development of Contract Documents.

Discrete information blocks have been designed and organized by the GL categorization, to be used independently, or to be combined into documents of various types, according to product, to stage in development of project, to function of professional addressed. They could be developed by cooperative effort to the benefit of all participants.

These are just a few of the applications

which come to mind. There are many more which are certain to emerge as development progresses.

Surely it is time that all the construction professionals band together and collaborate rather than for each group to continue on its own, duplicating effort, without coordination, fragmenting even further an already fragmented industry. By pooling effort, we can utilize what we have to best advantage and develop what we need most efficiently. We can develop the tools for approaching product selection effectively.

Perhaps it is time that all those with responsibility for product selection make clear to the manufacturing community the kind of complete, well-organized information we must have. The manufacturers will see the business advantages of continuing as the main source of product information for the construction professions. After all, whether the manufacturer is addressing an architectural firm, a corporate building department, a government agency or a builder—in the end-analysis it is the architect or another design professional within any of these bodies whom he must reach if he is to have his product selected and specified. If, for lack of adequate information, the professionals are forced to develop their own means of product search, the manufacturer will lose the forum for presenting his product to its best advantage and will see it submerged into the grey area of norms and ranges. The professionals, on the other hand, would have to shoulder the entire burden of developing and running such a search system. Clearly, a situation to no one's advantage.

So let us try and move before it is too late. Let us move consistently toward that comprehensive information retrieval system which would benefit the construction industry and professions so much, and allow the architects to direct more of their precious time to the more creative aspects of their vocation. The Joint Industry Conference, the only truly coordinating agency in the United States has done the industry signal service in its pioneering, integrative work on the UCI. It appears to this writer to be the natural coordinator for the cooperative effort suggested in this article.

We in Sweet's GuideLines would welcome this or a similar framework for cooperation. We hope for a similar response from the industry and the professions.

Let's start the ball rolling.....

Mrs. Eldar welcomes inquiries and discussion pertaining to this article. She may be reached at McGraw-Hill Information Systems, 1221 Avenue of the Americas, New York, New York 10020. Phone (212) 997-2242.

Classic West

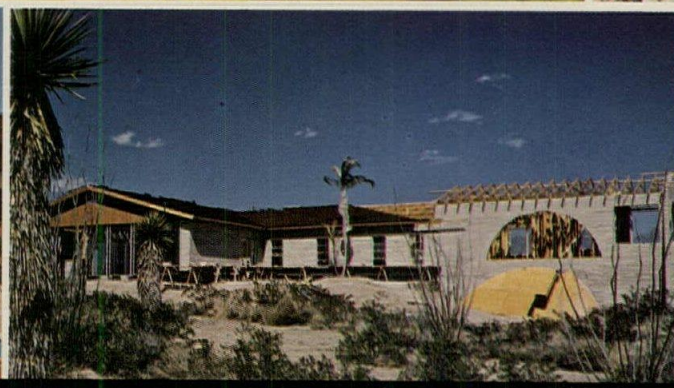
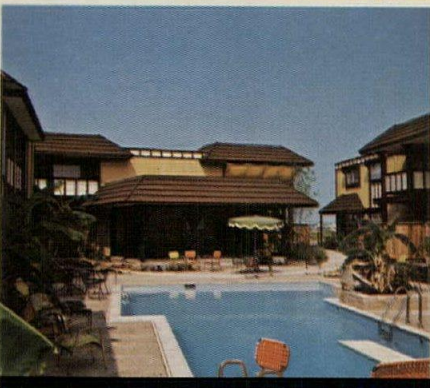
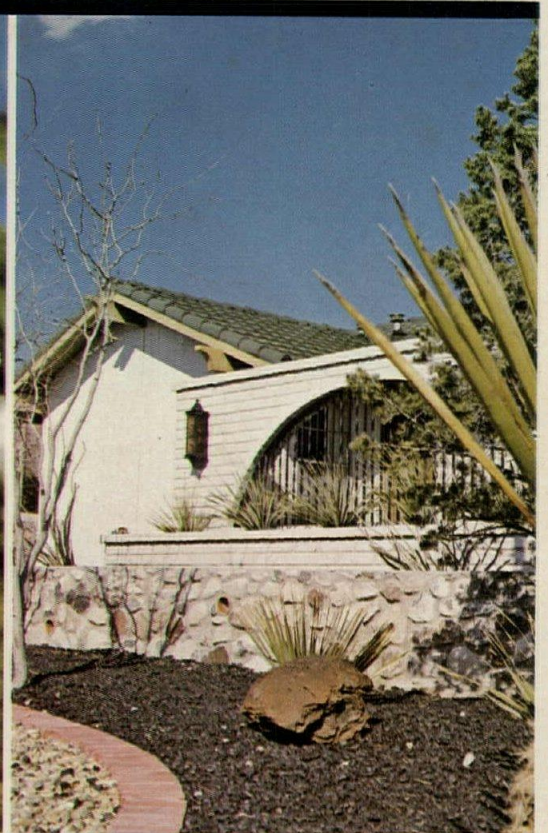

Complementary Classic goes West!

Decramastic Roof Tile, a pioneer in a land of pioneers. A roofing product that has "won the WEST"...a tile as rugged and as enduring as the people who settled this land.

From a vacation cottage weathering a Rocky Mountain Winter, to a luxury home basking on the desert sands, the magic of Decramastic sustains. Commercial buildings, schools, apartments are all aesthetically complemented by this Class A fire rated product which meets all codes.

A classic product embodying the attributes of a multitude of roofing materials,

Decramastic is specified by Architects and Builders throughout the U.S. Decramastic Roof Tile resembles a heavy clay or stone roof, yet is six to eight times lighter. Creation begins with sheets of formed quality galvanized steel which are coated with a specially formulated emulsion. The tiles are then impregnated with colored ceramic chips and treated with a tough fungus resistant sealer.

The result is a lightweight easy to install tile, available in 9 standard colors that range from the rich earth tones of the Painted Desert to gay modern world colors

enriched by a golden sun.

Decramastic's deep butt line catches the sun's rays, creating strong shadow lines while intensifying the appearance of massive weight.

Old Spain quickly blends with the new world when specially designed Decramastic Spanish accessories transform homes into haciendas and meeting halls to missions.

A product of...

Automated Building Components, Inc.
Box 2037 AMF, Miami, Fl. 33159
Telephone (305) 696-0930



a dramatic new way to a lasting visual expression

Decramastic[®] Roof Tile

© Automated Building Components, Inc. 1973 — Protected by U.S. & Foreign Patents

For more data, write A5 on inquiry card

Specifications: Who's in the driver's seat?

Who controls what products are actually used in a building? Do architects' specifications really hold up on the job? Some extraordinary research has just reaffirmed that *architects* control what products are used in a building, and that the brand names specified are actually used in buildings over 86 per cent of the time.

The study was just completed by John Eaton, manager of market research for the Sweet's Division of the McGraw-Hill Information Systems Company. "For the last several years," Eaton points out, "there has been increasing confusion and doubt about the role and importance of architectural specifications." Further, there has also been a lot of talk that the construction manager, or the contractor, or the supplier, or the owner has been nibbling away at the architect's responsibility for determining what products are actually used in the finished building.

To get at the facts, brands mentioned in the specifications for 169 completed projects were assembled by Smith, Stanley & Company, which did the field research for Sweet's. The architect who wrote the specs for each of the 169 buildings was then asked which of the specified brands had actually been installed in his building. If a specification had been broken, the architect was asked who initiated the change, what was submitted, and why.

The 169 projects represented 32 different building types ranging from commercial facilities (50) and educational buildings (52) to residential, medical, industrial, religious buildings, and other types—including one funeral home. The buildings are located in 37 states, and their total construction cost was just over \$175 million. The range of construction costs was from \$75,000 to \$7.5 million.

The results: just 13.7 per cent of brand-name specifications were changed

The Sweet's researchers reported on 13,952 brands mentioned in 6,594 specifications for the 169 jobs. Among these specifications there were only 906 substitutions.

Of all the brand specifications in the survey, 41 per cent were found to be single-brand specifications, 26 per cent were multiple and 33 per cent were "or equal". Among the equal brand specifications an average of 2.4 brands were specified; among the multiple brand specifications the average was 3.6.

(Recent RECORD research indicates that "equal"—specifications are on the decline, and "multiple" specs are being more used by architects.) There seems to be no drastic varia-

tion in the rate of specification-breaking from one type of spec to another. For the single-brand specifications the brands specified were actually installed 89.4 per cent of the time. For the "or equal" specifications one of the brands actually mentioned by name (i.e., not including any unnamed equal) found its way into the finished project 92.1 per cent of the time. Where multiple specifications were used one of the brands named was installed in 96.6 per cent of the reported cases.

Which products are specified by brand, and what type of specification is used?

On a simple numerical basis—in the 169 buildings—the greatest number of brand-name specifications was for UCI Divisions 15, 9, and 8—Mechanical products, Finishes and Doors and Windows. Here is a numerical breakdown of the 6,594 specifications, with a percentage breakdown of the type of spec used:

UCI Section	Number of specifications	Of those specifications percentage that are		
		single	equal	multiple
2 Site Work	73	49%	36%	15%
3 Concrete	260	47	29	24
4 Masonry	223	49	28	23
5 Metals	267	43	39	18
6 Wood & plastics	257	39	35	25
7 Thermal & moisture protection	755	39	37	24
8 Doors & Windows	966	39	34	27
9 Finishes	1,004	32	37	31
10 Specialties	645	39	39	22
11 Equipment	244	64	24	12
12 Furnishings	71	49	35	16
13 Special Construction	56	32	38	30
14 Conveying Systems	35	49	23	28
15 Mechanical	1,111	41	30	29
16 Electrical	627	46	26	28

Single-brand specification occurred most frequently for Equipment (64 per cent of the total), and multiple or equal specifications occurred most frequently for Finishes and for Special Construction (both 68 per cent).

The reasons for substitutions in architects' specifications can be seen in the following numerical and percentage tabulation of the 906

changes recorded in the Sweet's survey:

Total changes	906	100%
Price	265	29%
Availability	175	20
Past experience	115	13
Installer's preference	67	8
Esthetics	39	4
Owner/tenant wanted	20	2
A combination of all	75	8
Others	20	2
Reasons not given	130	14

As for who initiated the specification changes, the tables again give some useful clues:

Contractor-builder	306	34%
Architect	195	22
General contractor	120	13
Sub-contractor	64	7
Engineer	55	6
Owner	45	5
Title not recalled	121	13

The specification changes did vary in number and percentage somewhat according to product type, as the following table illustrates:

UCI Section	No. of specifications	No. of brands specified	No. of specifications substituted	% of specs with a specified brand installed
All	6,594	13,952	906	86%
2	73	119	4	97%
3	260	474	23	91
4	223	412	10	96
5	267	449	37	86
6	257	474	26	90
7	755	1,595	84	89
8	966	2,183	145	85
9	1,004	2,370	143	86
10	645	1,270	135	79
11	244	406	36	85
12	71	108	7	90
13	56	112	9	84
14	35	66	10	71
15	1,111	2,473	144	87
16	627	1,441	93	85

Summary: Architects—not contractors, subcontractors, owners, or construction managers—control specifications. The numbers above ought to stiffen the resolve of architects who are under pressure to approve a substitution, and demonstrate that specifications are—to an architect—an integral part of the design and thus his responsibility.

ECO, today's answer to tomorrow's security problems.

Unobtrusive. Economical. Reliable. Simple to install. Hager's Electronic Control of Openings (ECO) offers a unique, new concept in building security and traffic control. ECO's patented electronic contact and switch hinge now makes it possible to lock, unlock and monitor openings electrically from one central security station. Only slight modification to standard A.N.S.I. door and frame preparation is required. Installation is simple. Electrical contractors can easily incorporate ECO into the building's wiring system. For more information, call your architectural hardware consultant or mail this coupon today.

eco
electronic
control of
openings

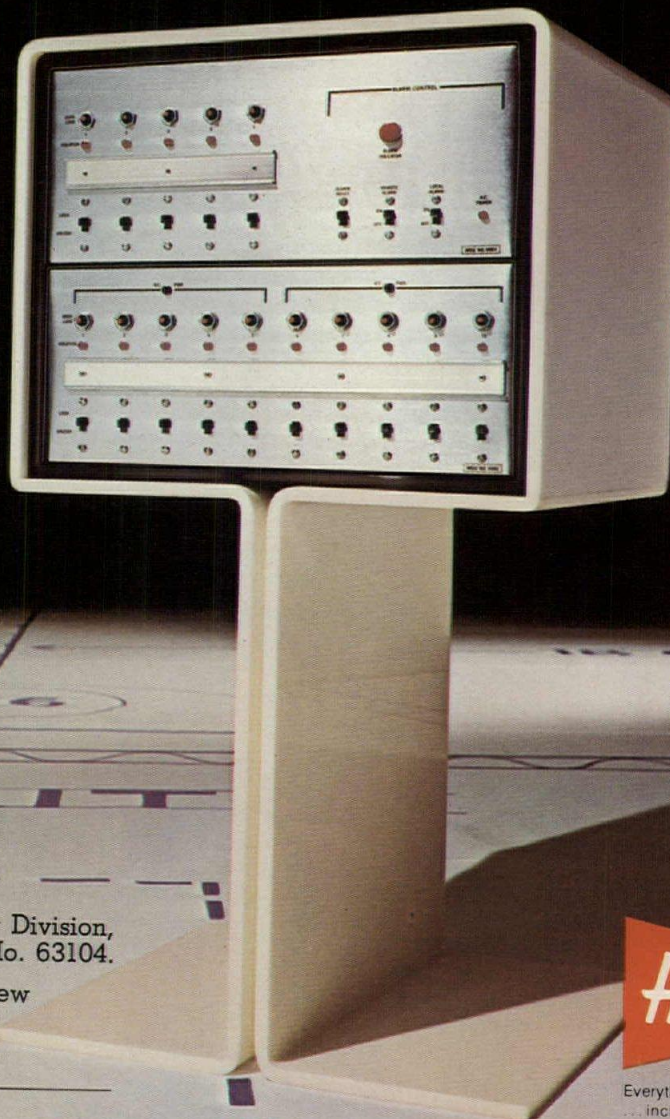

Mail to: Clarence King, FCSI, President—ECO Security Division,
Hager Hinge Company, 139 Victor Street, St. Louis, Mo. 63104.

Please send me more complete information on Hager's new
ECO security system.

Name _____

Company _____ Phone _____

Address _____

City _____ State _____ Zip _____

For more data, write A6 on inquiry card



Everything hinges on Hager
...including security.

Energy conservation: new products, new systems, new commitment

Just two years ago, RECORD ran a Roundtable on Energy Conservation—and that meeting, which attracted some of the country's top architects, engineers, builders, cost consultants, lenders, utility executives, government leaders and manufacturers (nearly 100 of them) was the first formal meeting on the subject ever held. Just two years ago this month.

At that meeting, more than a few of the thoughtful participants were not at all sure that there was indeed an "energy crisis." There was a lot of discussion that lower operating costs were not a sufficient incentive to cause architects and engineers to involve themselves in the problem. And the question of costs was, predictably, a major question for everyone. Architect-builder Frank Whitney summed up a common concern at that meeting two years ago when he said: "I get a chill when we talk about raising initial costs in order to save operating costs [through energy conservation]; I'm having a terrible time convincing clients they ought to build at today's costs." And manufacturer David McNitt summed up for the manufacturers: "As we look at the engineers' improvements which will reduce the energy consumption of a product at a given Btu, we say, 'Who is going to pay the difference, who is going to pay the little bit more that we would have to put into this product to reduce its energy consumption?' And we haven't found the answer."

Said manufacturer (and then-ASHRAE president) Stanley Gilman: "Industry momentum is in the direction of lowest initial cost and not toward energy conservation. It will take a major educational effort, and considerable time, to turn this around."

Where are we two years later? Still talking . . . but starting to act

Since the time, just two years ago, that that first questioning meeting was held, it has become clear that energy is truly a problem. Conservation has become a matter of national policy—bearing on control of industries, affecting our drive towards environmental clean-up, bearing on national and international policy and diplomacy, and showing signs of affecting our lives in a hundred ways.

And if design for energy conservation has not become everyday business for architects and engineers, it has become an important factor in design—and pressures from all sides make it clear that energy use as a design problem and design criteria will continue to grow. The government is starting to lean hard (see

below on the growing pressure for standards), and the number of important experiments in building for greater efficiency is focussing broad attention on what architects and engineers can do. A number of these experiments are described on the following pages.

These pressures are clearly reaching manufacturers—and more than a few are talking "efficiency" now when just a few years ago they were talking cost. We see new emphasis on insulation, solar-reducing glasses, heat-recovery systems, high-efficiency light sources. Heat pumps are being re-examined. Engineers are studying heat recovery (from lighting, equipment and people) and redistribution with loads as low as three watts per square foot. We are surely seeing more flexible controls—for redistributing heat, for permitting more efficient use of lighting. Storage of heat is out of the gee-whiz stage and coming into more common use. We see more emphasis on lighting design tailored to the expected activity—less in hallways and non-working areas, more in internal workspaces, less near perimeter walls. Each month brings new applications of high-efficiency lighting sources. We see more and more applications of variable air-volume systems to improve the efficiency of air conditioning.

Architects, engineers, and manufacturers may soon be living with new standards

Item: The National Chamber of Commerce has warned that "Senator Henry Jackson, with nine cosponsors, has introduced S.2176, National Fuels and Energy Conservation Act of 1973, which would (among other provisions) require labeling major electrical appliances and equipment to show efficiency and operating cost, and would direct the Secretary of Housing and Urban Development in cooperation with the National Bureau of Standards 1) to develop standards for improved lighting and insulation to promote efficient energy use in buildings, 2) to develop model building codes that incorporate the most practicable standards for efficient energy use in different regional environments, and 3) to revise the FHA MPSs to include the most advanced practicable standards for energy use including minimum standards for heating and cooling equipment and major appliances . . ."

The National Bureau of Standards is, in fact, already at work on energy standards

A new project directed at producing a building energy conservation performance standard for

state regulatory reference is on the books. The request came from the executive committee of the National Conference of States on Building Codes and Standards.

The need for such a standard was discussed at length this summer at a joint emergency workshop on energy conservation sponsored by NCSBCS and the NBS.

At that meeting, Joseph Stein, vice president of Tishman Research Corporation and former commissioner of the New York City Department of Buildings, argued that there was a need for a uniform, national, performance-oriented standard—and pointed out that while a purely performance type standard might be preferable, for practical reasons a standard somewhere between a performance and prescriptive standard is more likely. At the meeting, Paul R. Achenbach, chief of the NBS' Building Environment Division, pointed out the need to explore various methods or procedures that might be used by the states to limit use of energy in buildings in an equitable and uniform manner. Like Stein, Achenbach made the point that such criteria must allow flexibility in design and choice of materials, adding that "In addition to technical requirements, any satisfactory set of criteria must be susceptible to effective administration and compatible with other performance objectives for buildings."

The main thrust at NBS in the energy-conservation area, according to NBS Director Richard Roberts, is to "immediately stem the wasteful or inefficient use of energy in residential and commercial buildings." Roberts has told Congress that its studies show a 40 per cent waste factor in heating and air conditioning alone due to design and construction practices. On a more experimental level, NBS has already initiated projects dealing with solar heating, modular integrated utility systems, industrial process conservation, coal gasification, high-temperature gas turbines, and nuclear power.

On the question of standards, Dr. Roberts has testified to Congress that "NBS voluntary industrial standards activities involve test methodology and test concepts to produce the energy-efficiency labeling indicated in the President's message on energy—and the Bureau is already working with voluntary groups in developing the required procedures."

So—for architect, engineer, manufacturer, and owner alike—the incentives grow

Shortages, higher and higher fuel and electricity prices, the growing threat of government intervention in the form of enforceable standards—all these incentives are now adding to the basic incentive for energy conservation through better design and better products.

For as the Roundtable concluded two years ago: "There is much that architects and engineers can do. They can—as professionals with a professional responsibility to society as a whole—work to persuade their clients to choose or accept design, material, and equipment options that will cut down the present profligate waste of energy.

"They can argue—and they should—the immorality of waste of a basic and irreplaceable resource of nature."
—W. W.

Prototype buildings—some government sponsored, some private—are

Probably the most talked-about new "energy-conserving" building is the 175,000-square foot Federal office building at Manchester, New Hampshire, being designed by engineer Fred S. Dubin, of Dubin-Mindell-Bloome Associates of New York. This building, which was an outgrowth of the Roundtable on Energy Conservation in Public Buildings held jointly by the General Services Administration and the National Bureau of Standards, is nearing construction. According to Walter Meisen, assistant PBS commissioner for construction, the design process for this building has evolved with considerable input from the NBS, where computer studies have shown energy saving possibilities through control of building orientation, fenestration, configuration and insulation. When PBS began the Manchester project, it announced a goal of 20 per cent reduction in energy requirements over comparable office buildings. Commissioner Meisen now reports that despite some penalties inherent in the experimental (and multiple) mechanical-electrical systems that are being employed, the agency is convinced it will exceed the 20 per cent savings goal by a wide margin.

This building is one of two major experiments—or demonstration projects—being developed with the active interest and support of GSA Administrator Arthur Sampson and the new PBS Commissioner Larry Roush. The Manchester demonstration was designed to maximize energy conservation, with secondary attention being paid to broad environmental considerations.

In an equally interesting experiment, GSA and PBS commissioned Smith, Hinchman & Grylls to design a building paying maximum attention to environmental concerns—improvement of the neighborhood, ideal working conditions, minimum impact on community systems. But within that format, as in the case of Manchester, resource conservation—and particularly energy conservation—were clearly important.

The design concept by Smith, Hinchman & Grylls incorporates some intensely interesting ideas—and the function-following form of the building (see rendering below) is equally evocative.

It is a Federal Office Building in Saginaw, Michigan, and includes these environment-enhancing, resource-conserving, planning and design ideas:

1. The building is one-floor, to eliminate vertical transportation.

2. The building is partially recessed into the ground, with earth berms built up against all non-window walls.

3. There are deep (17-foot) overhangs on all four sides to shade all openings.

4. The roof is landscaped—so it serves, in its central-city location, as a park, an employee facility, and as an air regenerator. The roof itself is concrete, a foot thick, with one and a half inches of insulation, and two feet of soil to hold the planting.

5. Office planning is open for simpler air circulation and lighting.

6. There is extensive planting around the building.

On the technical side, according to SH&G designers:

1. Lighting is 80 per cent indirect in the general office space, consuming only two watts per square foot, "but with adequate light levels for all tasks."

2. All fenestration is double glazed, tinted.

3. An 8,000-square foot solar-energy flat plate collector, in direct contact with water-filled metal pipes and covered by a dead-air space of two sheets of 1/8-inch tempered plate, heats water to approximately 180 degrees F., and this water is stored in an insulated tank.

4. This hot water is used to operate a decentralized closed-loop heat pump system, which heats or cools circulated air. The system is decentralized to permit maximum flexibility in shutting off unneeded units.

5. When heat pumps are on different cycles, the heat given off by those on the cooling cycle is recaptured and added to that produced by the units on the heating cycle.

In the area of resource conservation, SH&G points to these features:

1. A one-pipe, one-temperature water distribution to all lavatories, which are equipped with spring-loaded shut-off valve fixtures to minimize waste.

2. Storm water is impounded, and retained for use in the site sprinkler system and for watering the roof garden, with an estimated 75 per cent reduction in city water needed.

3. A self-contained mineral-oil waste treatment system is used. It purifies solid waste through filtration, and then returns the oil for reuse. All solid residues are incinerated by initial and secondary incineration, with no smoke

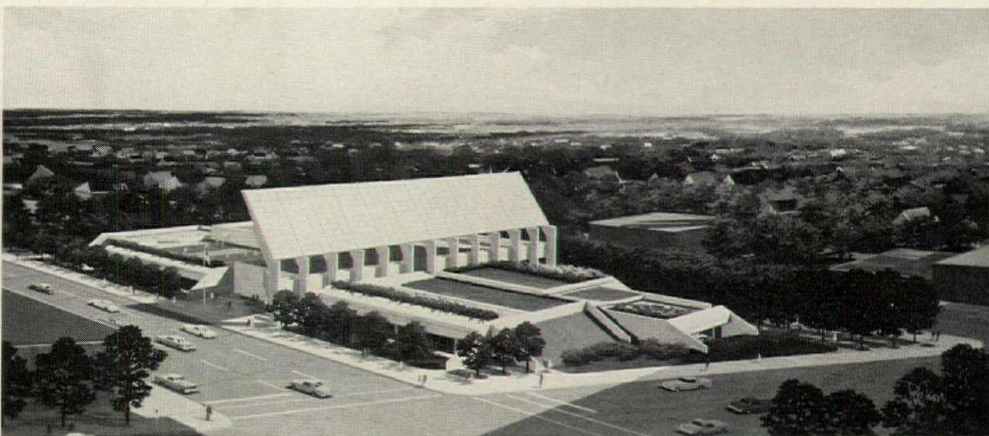

and particulate matter exhausted. This system requires no city water or sewer connection.

4. Old brick from buildings on the site that had to be demolished are to be crushed and reused in paving and in the wall surfacing.

Smith, Hinchman & Grylls' design team evaluated over 140 new sub-systems and techniques for the building, which were evaluated by an interdisciplinary team for effectiveness, feasibility and compatibility. From the ideas and techniques selected for use, and on the basis of the preliminary design shown on page 14, this building—with the other GSA/PBS demonstration building—ought to stir a lot of effective thinking.

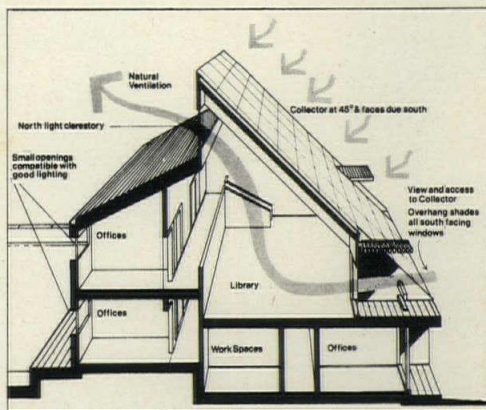

In Boston, a solar-heated office building will soon be in construction

This two-level, 8,000-square foot office building for the Massachusetts Audubon Society, designed by the Cambridge Seven Associates in association with Alan Balfour, an architect with Arthur D. Little, Inc. of Cambridge, may be the first building in the country to be both heated and cooled using solar energy.

A 3,500-square foot solar collector—which it is estimated will cost about \$154,000 of the building's total cost of \$542,000—is made up of modular flat plate collectors, each double-glazed, backed by a black-painted metal pan, and containing water-bearing tubes. Fluid heated in the collector will be stored in a 7,500-gallon tank, which, it is estimated, will be capable of storing enough heat for two winter days.

Arthur D. Little engineers estimate that heat generated and stored by the system will be able to supply from half to 85 per cent of winter heat, depending, of course, upon weather conditions and the number of sunny days to operate the collector. On the cooling side, a 15- to 25-ton lithium bromide absorption unit will supply a "substantial portion" of the air conditioning.

At least two demonstration houses will be built for completion next spring

Westinghouse Electric Corporation plans to build one in Coral Springs, Florida. According to James A. Brown, project director of the company's Community Products and Services Council, "We expect the house, called Electra III, to use 30 per cent less electricity than that required by similar-sized all-electric houses in

Florida. The house, which will have 2900 square feet of enclosed living space and a 2,000-square foot screened patio and pool area, will be carefully sited to take maximum advantage of sunlight, shade, and the prevailing wind; be insulated to maximum standards, make extensive use of fluorescent and mercury vapor lamps, recycle both waste heat and solar heat for heating pool and tap water."

Another demonstration house is under development by the Pennsylvania Power & Light Company, Allentown. The house, a conventional-appearing three-bedroom, bath-and-a-half, two-story unit is expected to be in the \$35,000 market range—but to include a variety of experimental energy-saving systems:

1. A fence-like solar collection unit will provide auxiliary heating capability, and be tied in with a heat reclamation unit designed to capture waste heat from the refrigerator, dryer, and waste line. The panel size of the solar collector has not yet been established. The system will use ethylene glycol, and according to PP & L engineers should have an over-all efficiency (heat transferred to the loop vs. incident radiation) of approximately 50 per cent, with a loop temperature of about 80 degrees F.

2. An electric motor will automatically open and close insulated draperies to admit winter sun during the day but close at night.

3. A fireplace opening to both the living room and the kitchen/family room will be tied into the supplementary heating unit by means of water coils in the fireplace mass.

4. Fluorescent lighting will be used in place of incandescent wherever appropriate.

5. An attempt will be made to capture heat from the bacterial action in the septic system. The main holding tank will be encircled by a coil and valved in such a way that, whenever temperatures are high enough, the heat energy will be used.

The nucleus of the house will be a two-ton water-to-air heat pump. It will exchange energy from the loop picking up heat from the solar collectors, the septic system, the wastewater heat collector, a 1000-gallon storage tank with a 15-kw immersion heater, and the condenser of a two-ton air-to-water heat pump.

In normal operation, the water-to-air heat pump transfers energy from the loop to the house. Should this system not provide enough energy, the air-to-water heat pump can be used.

According to Robert Romancheck, supervisor of PP&L's research and technical services department: "Our energy saving house is an experiment designed to determine the realistic energy optimization possibilities in a single-family house." Franklin Institute Research Laboratory is consultant on the job to PP&L and the architect, Donald W. Duncklee of Allentown.

EFL has just completed a major study of energy conservation in schools

The report (entitled *Economy of Energy Conservation in Education Facilities*, and available

from EFL, 477 Madison Avenue, New York 10022 for \$2) is intended as a consciousness-raiser for school administrators, but nonetheless contains a great many useful checklists—not just in the technical area, but in areas of operation and maintenance that (because they seem so obvious) are often overlooked. Favorite example: analysis of energy use in a Las Vegas high school showed that 30 per cent of the total energy consumed in the school occurred between four in the afternoon and midnight, when the school's population of 1,100 had shrunk to three custodians. (And don't you bet that's common?)

Significantly, the report argues not just for technological improvement, but for two basic policy changes argued in RECORD's Round Table on Energy Conservation two years ago: 1) acceptance of higher first costs in return for lower life-cycle costs; and 2) acceptance of some lower environmental standards. Says the report:

"The current system of awarding contracts on the basis of first cost only is destined to become an ever bigger folly as the energy crisis intensifies and fuel costs rise. In these days of rapidly escalating building costs, the impulse to cut initial costs becomes almost reflexive. [But] a school should be conceived not merely as a physical structure, but as a 'building-people' complex lasting 40 years. Viewed in this context, construction costs . . . fade into the background. First cost constitutes roughly 8 per cent of the total 40-year cost; operation and maintenance costs about 12 per cent, and teaching-administrative costs an overwhelming 80 per cent. Thus a 10 per cent increase in capital cost [for, for instance, energy-conserving products and sub-systems] is only a one per cent increase in total owning cost. And this can often result in far greater reductions elsewhere in a building owner's budget—in reduced O&M costs, or even in improved productivity . . ."

On environmental standards, the report suggests that "Standards of thermal comfort may have to yield a little. . . Significant quantities of energy could be saved merely by lowering interior winter temperatures and raising summer temperatures from the 75F mid-point of the 73F to 78F range defined as 'thermal comfort conditions' by ASHRAE. Raising the summer temperature from 75F to 78F could cut energy consumption for the air conditioning by about 10 per cent in the average building . . ."

And so—in various types of office buildings, in houses, in schools—the real experimentation in the use of products and sub-systems for conserving energy is clearly underway. Architects and engineers have long been interested in this problem; manufacturers are responding—though with an understandable reluctance to commit themselves to energy-conserving products until someone proves there is really a market and that owners will really pay for their change-over and higher costs; and the incentives—in terms of shortages and higher costs for energy—build with each passing month.

Uniform Construction Index

A System of Formats for Specifications, Data Filing, Cost Analysis and Project Filing

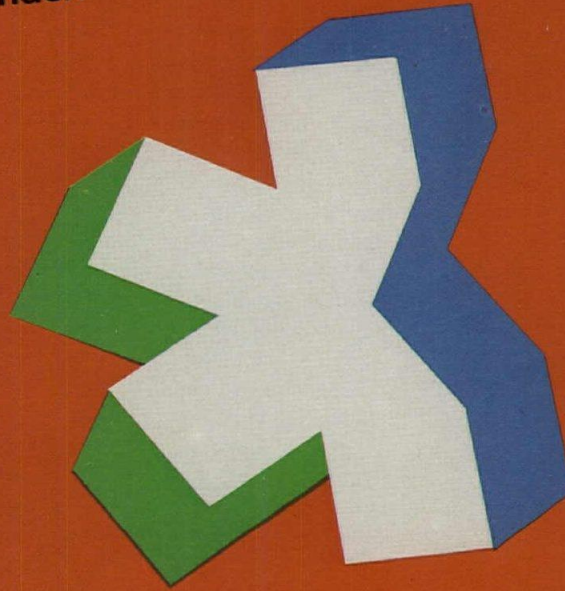

The Uniform Construction Index

1972 Edition

A New Symbol of Coordinated Construction Communications Produced for the construction industry in the United States and Canada

The Uniform Construction Index replaces the Canadian "Building Construction Index" and the United States "Uniform System for Construction Specifications, Data Filing and Cost Accounting".

The 1972 Uniform Construction Index has four distinct parts:

- Specification Format
- Data Filing Format
- Cost Analysis Format
- Project Filing Format

The Index serves the entire construction industry—designers, manufacturers and builders. It is a format for specifications, project cost analysis, and product literature. Coordinated with the four parts is a comprehensive "Key Word Index" of construction terms, locating each item for proper location within the individual format.

The Uniform Construction Index is a system for:

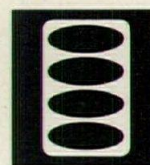

Specifications
Data Filing
Cost Analysis
Project Filing



The Uniform Construction Index was prepared and is supported by the following organizations:

American Institute of Architects
Associated General Contractors of America, Inc.
The Construction Specifications Institute
Council of Mechanical Specialty Contracting Industries, Inc.

Consulting Engineers Council of the United States
Professional Engineers in Private Practice/
National Society of Professional Engineers
Producers' Council, Incorporated
Specification Writers Association of Canada—
Association Des Redacteurs De Devis Du Canada

Association of Consulting Engineers of Canada
Canadian Institute of Quantity Surveyors
Royal Architectural Institute of Canada
Canadian Construction Association
Sweet's Division, McGraw-Hill

Information Systems Co. (U.S./Canada)
National Electrical Contractors Association, Inc.
Sheet Metal and Air Conditioning Contractors' National Association, Inc.

National Association of
Plumbing-Heating-Cooling Contractors

To order your 1972 Uniform Construction Index—See reverse side for list of participating organizations.

American Institute of Architects
1735 New York Ave., N.W.
Washington, D.C. 20006

\$8.00 Non-Member
6.50 Member

Name _____

Street _____

City _____

State _____

Zip _____

Check Enclosed Please allow four weeks for delivery.

product reports 74

On the pages that follow is the second edition of RECORD's Product Reports issue. Its format and its goal is the same as last year's pioneering issue—to show in an organized, easy-to-use-for-reference fashion the most important new products of the year. What is new are the products—every product or product improvement shown in this issue was introduced in 1973 or will be introduced early in 1974.

To develop the material for the issue, this year again we wrote to well over 1500 manufacturers across the country, asking them to submit their products for consideration for the issue. As they arrived, they were reviewed by the editors, the selections made, and the products categorized according to the now well-established Uniform Construction Index—the 16-division format for specification, data filing, and cost analysis.

The introductions to each of the 16 sections were, this year, written for RECORD by professionals with especial expertise in that product area, and are by-lined. And special thanks are due two good friends at Sweet's Division of McGraw-Hill Information Systems Company—Miriam Eldar for her article on page 7 and John Eaton for the research on which the article on page 11 is based. As last year, the lion's share of the editorial task was accomplished by associate editor Chuck Hamlin, with help from his editorial-department friends Bill Foxhall, Bob Fischer, Annette Netburn, Gerry Allen, Joe Wunk, Adell Milton, and Ruth Kevitz.

How to use the issue

The cover of the issue serves as a listing of the 16 Uniform Construction Index (UCI) Divisions, and related product categories or "sections" are grouped under these divisions. The page number for each Division can be found on the Contents page, page 3.

With the pages that follow, the products are grouped under the appropriate section of each division, each with an inquiry number at the start of the text item and under the related picture.

If you wish to obtain more information about any of the products, simply write the number of the item in a space on one of the two inquiry cards on the inside back cover. They fold out so that you can keep a card in front of you as you go through the issue. If both cards have been used, you'll find extra coupons on page 126.

Any product which has been pre-filed in 1974 Sweet's Catalogs is so marked in the text, with an A (Architectural File), I (Industrial Construction File), L (Light Construction File), or D (Interior Design File).

If you know the name of a manufacturer whose product you are interested in, check directly in the Manufacturers' Index, page 192.

Of course, there is no rule against browsing—and we hope you will; and hope you find this issue as valuable as we think it can be. —W.W.

Here's an idea as fresh as a daisy.

New odorless convenience copier for fast engineering check prints.

Now your entire drafting department can breathe easier! That's what Bruning's PD-80 can do for your drafting and check print operations.

No ammonia, no venting problem. That's the beauty of the remarkable Bruning PD Process.

That—plus the PD-80's compact design (64" x 13½" high) — means you can put it anywhere. Make quick check prints right where you make your drawings. No long walks, no long waits. Whether you make just a few prints a day, or dozens, the PD-80 will really pay off in the valuable time it saves your busy draftsmen.

The fast, high-quality PD-80 is the only odorless convenience engineering copier. Turn it on, feed tracings at once, get finished prints in seconds.

Your local Bruning man is ready to show you the remarkable PD-80 in action in your drafting room, using your tracings. And to show you how

easy it is to put this cost-cutting machine to work for you on an attractive rental plan. With no capital investment, no long-term commitment.

Call our office nearest you. Or contact us at 1555 Times Drive, Des Plaines, Ill. 60018.

Once you've had a whiff of this great new idea in check printing, you'll want a PD-80 in your drafting room as soon as possible.



BRUNING DIVISION

ADDRESSOGRAPH MULTIGRAPH CORPORATION

For more data, write A7 on inquiry card

office supplies and equipment

uci 1

Technical aids in the marketplace run the gamut from the most sophisticated computers to the latest refinement of the trusty lead pencil. Calculators, which a number of years ago were cumbersome and costly, are now available in mini-models for modest means. The utilization of technical aids and more specifically, the tools of computer technology available to the architect, engineer and other participants in the building community presents an opportunity to solve the communication problems in the construction industry.

And there are problems, brought about by complexity of building systems, constraints of codes and regulations, control of time, cost and quality and assimilation of the flood of technical information which must be used by the building community in making decisions.

A review of the products presented in this Division will reveal that the technical aids and tools of the computer age are with us. Changing techniques to meet the ever changing new demands thrust upon the building industry team must be explored and utilized. We need to know how to use the "hardware" in an integrated effort to meet this challenge of change. Realizing the need for a vehicle for research necessary for development of programs to use the available "hardware," the Construction Sciences Research Foundation (CSRF) was formed by the Construction Specifications Institute in 1967. CSRF established the CONCOM (Construction Communications) concept as an umbrella of potential communications systems to utilize the capacity of the computer to aid in making decisions. The program proposes research to develop systems under the broad categories of computer-assisted data research, visualization, calculations, graphics, specifications, estimating techniques, scheduling and file storage and recall. Each of these broad categories is broken down further into a number of subsystems. Some of these systems have been introduced with the intriguing acronyms of SPEC DATA (Specifications Data), COM SPEC (Computer-assisted Specifications); others are waiting in the wings—COMVIS, COMCALC, COMGRAPH and more. As they are brought on stage they will be integrated, under the umbrella of CONCOM.

*Larry C. Dean, vice president
Heery & Heery, Architects and Engineers, Atlanta, Georgia*

INTRODUCTORY OFFER!

FOR GOOD LOOKS AND EFFICIENCY...

YOUR OWN PERMANENTLY BOUND VOLUMES OF ARCHITECTURAL RECORD

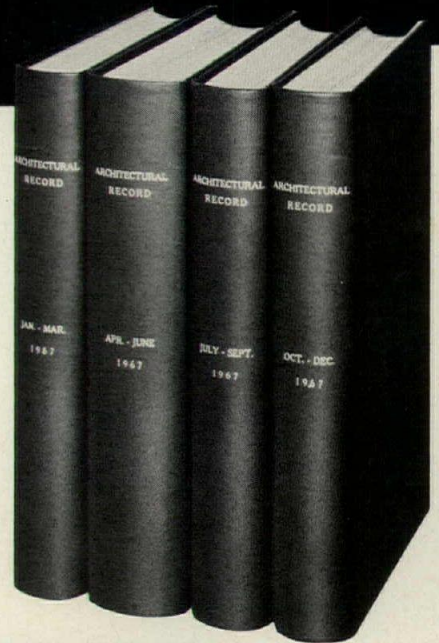

Here's a beautiful and efficient way to keep copies of the RECORD available for reference in your home or office library.

Bound in black cloth and imprinted with your name or the name of your firm in gold, each volume contains four month's issues of Architectural Record. This new service is available starting with the January, 1974 issue...the first volume reaching you in April.

Since we must reserve copies in advance for these bound volumes, your order must reach us prior to January 1, 1974. The \$55 yearly cost includes 4 bound volumes, each complete with gold embossing.

Use the coupon below or send your order to Architectural Record Bound Volumes, 1221 Avenue of the Americas, New York, New York 10020.

PLEASE INCLUDE PAYMENT OR PURCHASE ORDER.

**ORDER TODAY!
USE THIS
CONVENIENT
ORDER BLANK.**

Please send me _____ set(s) of bound volumes of Architectural Record for 1974. I have enclosed a purchase order or payment for \$55 for each set (regularly \$65).

Name _____

Street Address _____

City _____ State _____ Zip Code _____

Imprint on front cover (optional) _____

PR-74



1



2



3



4

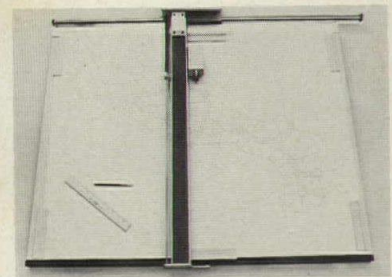

5

COMPUTERS

1 MECHANICAL DRAWINGS / This system permits, according to the maker, the owner to integrate computer speed with the production of complex mechanical drawings. The system comes with hardware and software necessary to construct, store, retrieve, and reproduce graphic or alpha-numeric engineering information. / The Gerber Scientific Instrument Co.

2 GRAPHIC PROCESSING / This multi-station system handles up to eight jobs at once, according to the company. All types of architectural and engineering drawings may be produced at a fraction of the time and cost of conventional drafting methods, the company states. / Applicon, Inc.

3 DATA ENTRY SYSTEM / Direct keyboard-to-diskette operation and the ability to record vast quantities of data on a storage medium are features of this product, according to the company. The diskette storage unit weighs a little more than an ounce and holds 242,000 characters. / IBM.

4 ROLL-ABOUT TERMINAL / This direct numerical control station allows the user to rapidly test and modify the parts programs that control machine tools. This unit can eliminate costs of preparing paper tapes. / IBM.

5 FLATBED PLOTTER / The unit is said to provide continuous line or point plotting of curves and data. In conjunction with the company's programmable calculator, it also provides full alpha-numeric labeling of plots. The calculator uses basic keyboard programming language. / Wang Laboratories, Inc.

6 VIRTUAL STORAGE / This improvement in the company's storage products helps increase programmers' productivity and permits more data processing jobs to be handled concurrently. The new products and programs allow on-line applications to be implemented easily and economically, says the maker. / IBM.

7 COMPUTER DRAWINGS / A run by a "paper" keyboard can convert freehand sketches into fully proportioned drawings, according to the company. Placed at random on a special electronic tablet, a sketch and the paper keyboard are simply touched with an electronic pen to initiate computer. / IBM.

8 FIRST-TIME SYSTEM / Bringing high computing performance to the first-time user is the main feature of this system, according to the company. It can also be used to augment existing systems. Uses a disk device and fast printer. Lowest cost system made by the company. / IBM.



6

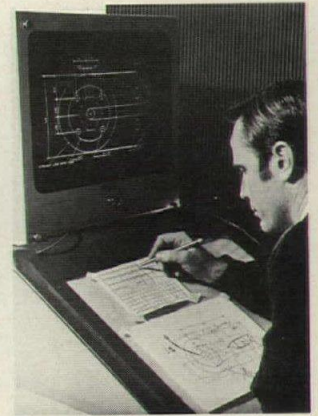

7



8



9



10

9 LOW-COST COMPUTER / This larger capacity model brings added function to the low-cost computer line made by the company. Main memory of up to 131,000 characters and disk storage of up to 91.7 million characters. / IBM.

16 NFPA CODES / Codes, handbook and regulations are available in microfiche format. The National Fire Codes includes 10 volumes of over 9000 pages. All handbook and regulation information is updated quarterly. / Information Handling Services.

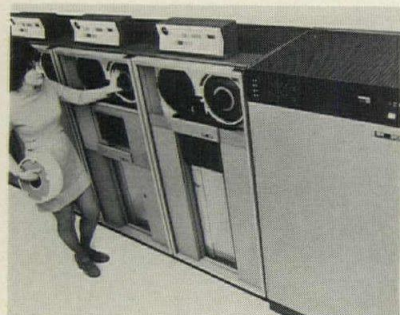

11



10 STRUCTURE SOFTWARE / Computer-like power and calculator convenience characterize this calculator and structural design software. It is said to reduce design time for multi-story moment distributions, reinforced and prestressed concrete designs, and many other structural design computations. / Hewlett-Packard Co.

17 GRAPHICS SOFTWARE / *Fast-draw* is a low-cost, interactive computer graphics system employing video display terminals, according to the company. It permits professionals to build and display structural models for processing on a supercomputer. / McDonnell Douglas Automation Co.



13



14

11 TAPE SUBSYSTEM / Three new tape drive models and a control unit are said to provide the densest data recording capability yet offered by the company. New models can triple the amount of information that can be stored on a single reel of tape. / IBM.

18 DATA TERMINAL / This data communications terminal combines a medium-speed printer with an automatic, high-speed send/receive terminal. A full range of editing keys is offered. Terminals are compatible with standard IBM hardware and software. / Wiltek, Inc.

12 BANK DOCUMENTS / Balancing a check sorting load can be handled with this document processor recommended for banks. The device can enable a bank to process and distribute checks, different in size, at a speed in excess of 125,000 per hour. / IBM.

MAINTENANCE/ OPERATIONAL

19 FILING SYSTEM / For plans, this vertical file can be wall mounted or mobile, and is lightweight and inexpensive, according to the company. The two-piece aluminum binder features a deep clamp. / Plan File Co.

INFORMATION SYSTEMS

13 MECHANIZED FILES / This retrieval system is said to provide more filing capacity per sq ft than any other file of its type. Revolving shelves extending through the ceiling in some cases, utilize overhead space, yet bring records to reference level in seconds at the touch of a button. / Diebold, Inc.

20 LIGHT TABLE / A back-lighted work surface for tracing, scribing negative viewing and film alterations is provided in this table, with transistorized control for variable intensity. Two table sizes are offered, up to 60 in. long and 37½ in. wide. / Hamilton Industries.

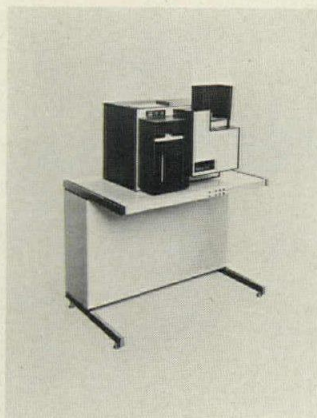

15

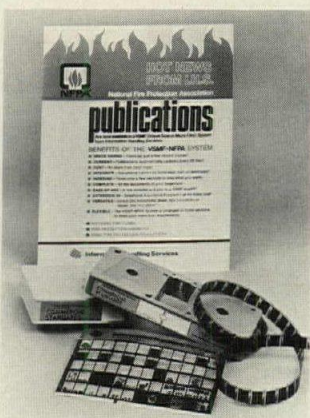

16

14 MECHANIZED FILES / High-speed filing and retrieval, plus large storage capacity is offered with this unit. Operator remains seated while controls bring card-size records to her. Priority pilot causes shelves to revolve through shortest route. / Diebold, Inc.

OFFICE MACHINES

21 MICROFICHE READER / This reader-printer is said to offer crisp image projection and dry printout. It prints in seven seconds and a choice of electrostatic papers makes six copy sizes available. There is a choice of three 11-in. square screen colors. / Micro Design, Inc.

15 DATA TERMINAL / Unit combines a punch card reader with the standard company base to create a high-speed send/receive terminal. Unit reads standard 80-column cards at the rate of 200 cpm. / Wiltek, Inc.

22 LETTERING SYSTEM / High-content carbon letters are printed on translucent polyester-based tape having a matte finish on one side and a pressure sensitive adhesive and peel-away liner on the other. No chemicals or special processes are required. / Pierce Corp.



17



18

23 POCKET CALCULATOR / With nine functions, including automatic square root and full four-function memory, this model is recommended

for engineers and architects. Operates on rechargeable batteries. A large 8-digit display is featured. / Berkey Photo, Inc.

24 LETTER FOLDER / Unit for office letters, forms, etc. will also insert materials as large as 14 by 22 in., at up to 4000 an hour. / Pitney Bowes.

25 PRINTER-PLOTTER / Unit uses 20-in. wide paper in 500-ft rolls and is designed for operation with all computer systems, according to the company. Principal applications will be in computer-aided design of architectural drawings, and plotting geophysical data. / Versatec, Inc.

26 CALCULATOR / This engineering calculator is available in both pocket-size and desk-top models. The pocket-size offers nine addressable memory registers, polar-rectangular coordinate conversion, metric-English conversion, plus the ability to solve more than 48 high level mathematical functions. / Hewlett-Packard Co.

27 POCKET CALCULATOR / With low power digitron display, the unit runs on batteries and provides 100 hours of use per set of batteries. Full calculation ability is claimed. Unit comes with case. / Verax Corp.

OFFICE SUPPLIES

28 PARALLEL RULING / The company claims this improved aluminum-magnesium edge parallel ruling unit offers restringing ease. The cord travels over nylon pulleys fully contained within slip-fit caps. Sizes 36 to 84 in. / Teledyne Post.

29 COLOR-CODED FILE / Color-coded folders encompass a fixed alphabetical range based on pre-determined frequency of appearance. Recommended for any record management operation that involves division of correspondence or other records alphabetically by name. / Diebold, Inc.

30 DRY TRANSFER PRODUCTS / A border system has been developed, based on interchangeable corner elements and decorative motifs. Application is identical to that of conventional dry transfer products. / The C-Thru Ruler Co.

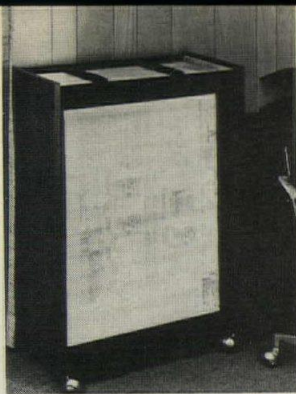

19



20



21



22



23

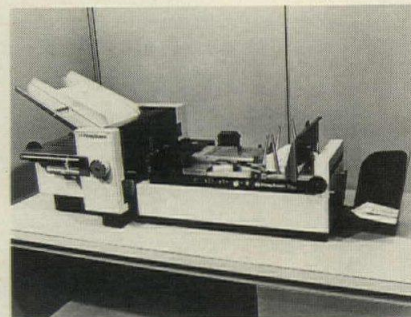

24



25



26

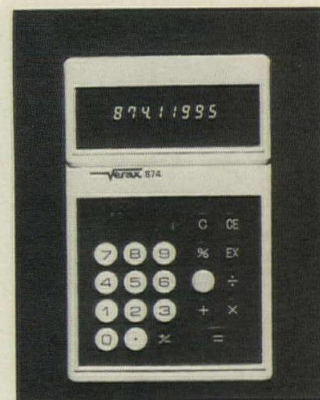

27



28



29

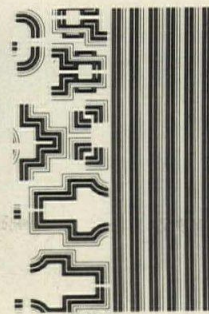

30

*Included in 1974 Sweet's Catalog File(s).



31



32

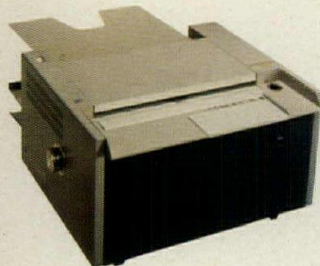

33



34



35

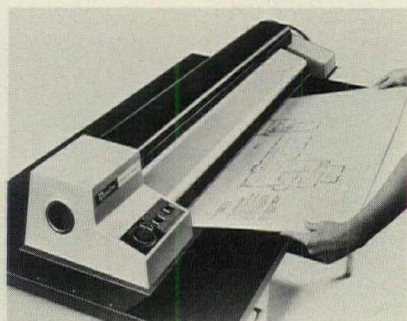

36



37



38



39



40

REPRODUCTION

31 COIN-OP COPIER / This flatbed copier is an electrostatic table-top model which produces six copies per minute when coin-operated and 30 when used as an office copier. The machine can copy originals of any type or color, including books and three-dimensional objects. / Pitney Bowes.

32 DIAZO COPIER / The company claims this table-top unit makes inexpensive copies of a variety of translucent originals up to 18 by 24 in. in size. Offers whiteprints without fumes or chemical mixing. Operates on normal 110-volt power. / Bruning Div., A-M Corp.

33 DESKTOP COPIER / This compact electrostatic copier copies material up to 17 in. wide to any length. Computer printouts, engineering drawings can be copied in one-step operation. Sheet or roll paper is acceptable. / Mita Copystar, America.

34 WHITEPRINTER / The company has announced an improvement in its pump system, reducing the failure rate by 50 per cent, it is said. Odors are also minimized. The simple pump is plugged into the machine and runs on 118 AC. / Teledyne Rotolite.

35 FACSIMILE SYSTEM / Messages are automatically received and transmitted by this unit, using the telephone. As many as 75 documents can be produced without an operator in attendance. The system answers calls, starts sending and receiving, and

hangs up when transmission is complete. Unit can be rented. / Xerox Corp.

36 WHITEPRINTER LEASING / The company will lease a whiteprinter (blueprinter) for up to 36 months, with the option to purchase the unit for 10 per cent of the list price. The unit makes prints up to 42 in. wide by any length and is designed for table-top use. / Teledyne Rotolite.

37 WHITEPRINTER / This improved model is said to feature a faster printer section, increasing speed from 18 fpm to 22. New fabric belts virtually eliminate belt marks. Dry ammonia development. / Diazit Co., Inc.

38 PLAIN COPIER / This low-cost copier is designed to make clean copies, with copy paper fed from a self-storing tray. Maximum copy size is 8½ by 14 in. The copier, recommended for small offices, is a table top version, operating on normal electric power. Copy speed is 10 per minute. Sperry Remington.

39 COPIER / This compact units offers many of the same features of the larger, high-speed models, according to the company. It uses ordinary cut-sheet paper. Copies are produced at the rate of 20 per minute. Unit reproduces halftones and solids. / Xerox Corp.

40 WHITEPRINTER / This 47-in. diazo whiteprinter automatically produces prints to the exact size of the original, and is suited to high-speed, high-volume print production. / Bruning Div., A-M Corp.

The typing crisis in architecture.

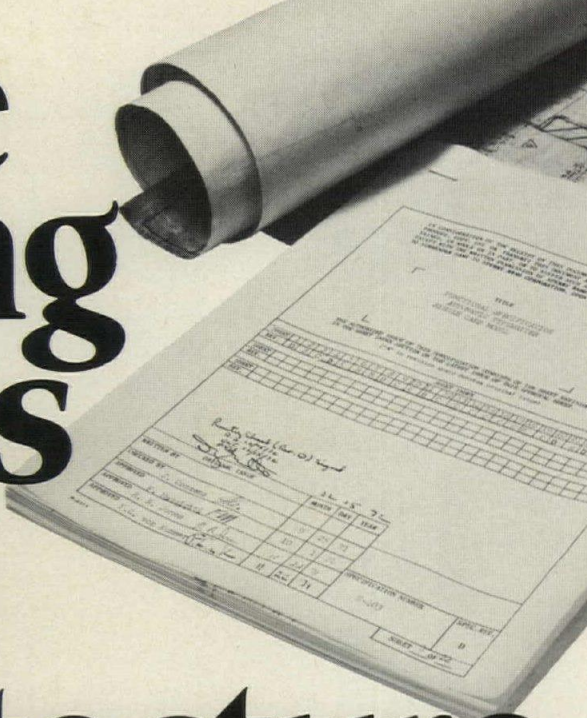

You're due to deliver 24 pages of neatly-typed recommendations for a preliminary bid on a major project, and you're nervously pacing the floor as your secretary frantically retypes the last page. For the third time.

Sound familiar? Then you know the typing crisis: the problem of keeping words flowing smoothly on paper under the pressures of time, work volume and mounting costs.

You can hire more typing help, but that's going to increase your costs. Costs are part of the crisis. A business letter already runs from \$3.00 to \$6.00. Next year you'll pay more.

What can you do about it?

Increase typing productivity. Do it with a word processor — an electric typewriter powered by a small computer.

Many architects are finding word processing saves so much typing time it can free secretaries for administrative duties, and boost office efficiency 50% or more.

Here's how the SPERRY REMINGTON™ word processor works for you. Your secretary types out original text, only once. At rough draft speed. Without worrying about errors. Everything is recorded as she types, either on magnetic tape or cards, both of which are reusable.

The word processor plays back the draft, with the typist

making your noted changes or revisions. Errors are corrected simply by typing back over them.

Because a whole page can be automatically duplicated in seconds, you can feel free to make as many changes as you want. Finished copy is played back as fast as 180 words a minute. Automatically and letter perfect. No need for re-proofing.

Save long hours in the typing of reports, specifications, presentations and documents using standard paragraphs. With our word processor up to 99 such paragraphs can be stored on one tape cassette and recalled automatically in any order. You can personalize standard letters, typing only the paragraph numbers to recall the copy.

The Sperry Remington word processor has more features that can best be appreciated by your secretary. Automatic underlining, electronic tab set and clear, and many others. All standard. Features we offer as standard are either costly options or nonexistent in other word processors. Maybe that's why so many users of word processing equipment are switching over to ours.

Let us put a Sperry Remington word processor in your office. We'll set it up without disturbing your scheme of things, and we can train your staff in your office, on your work.

Call your nearest branch office or use the coupon.

We uncomplicate word processing.

SPERRY REMINGTON	AR 10153
Office Machines, P.O. Box 1000, Blue Bell, Pa. 19422	
<i>Show me how the Sperry Remington word processor ends the typing crisis in architecture.</i>	
Name _____	Title _____
Company _____	
Address _____	
City _____	State _____ Zip _____

SPERRY  **REMINGTON**
OFFICE SYSTEMS AND MACHINES

SPERRY REMINGTON IS A DIVISION OF SPERRY RAND CORPORATION

For more data, write A8 on inquiry card

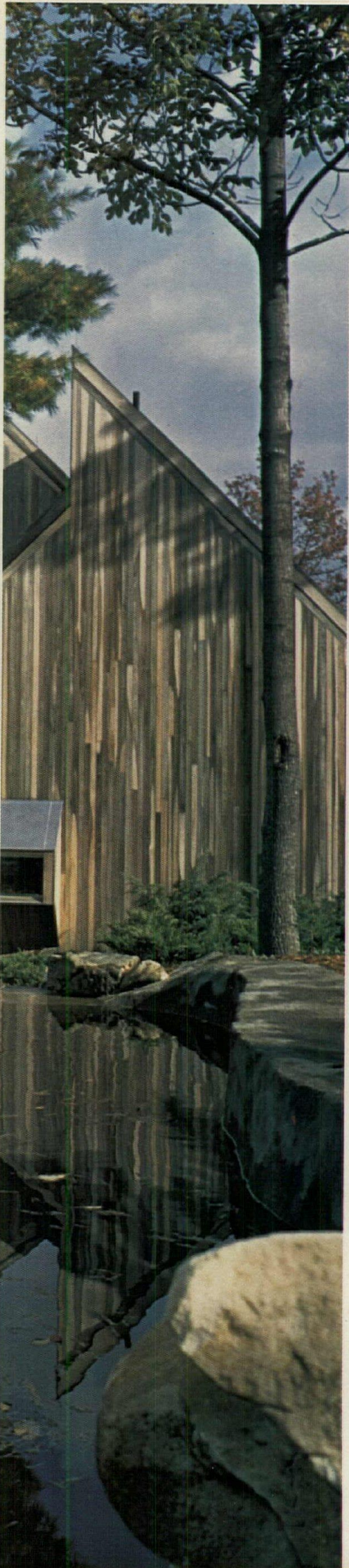
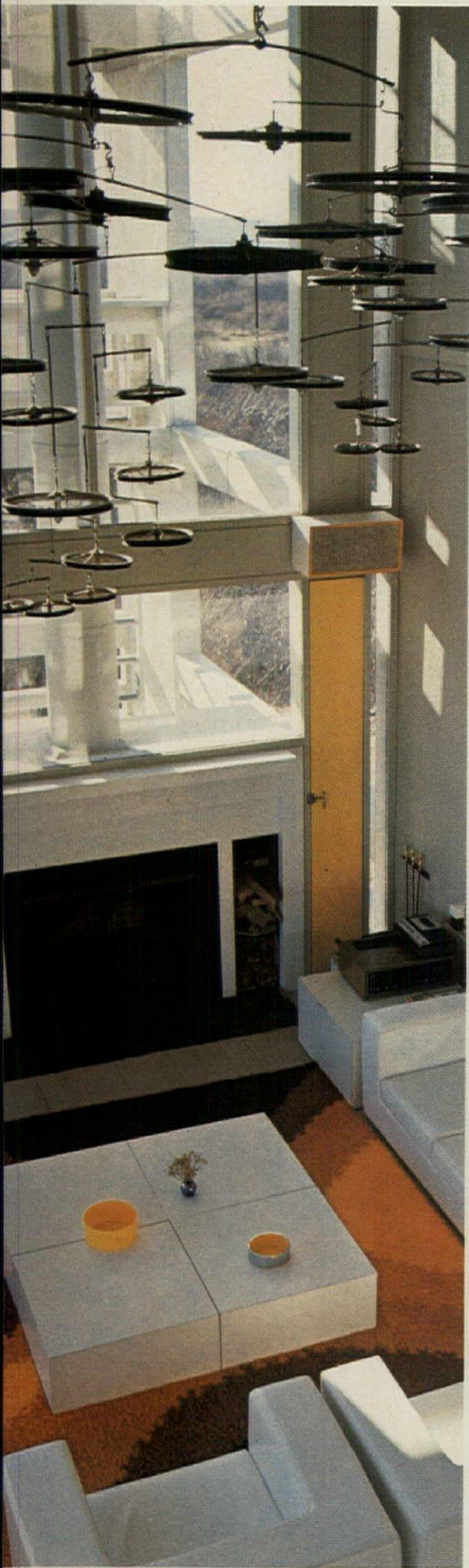

COMING IN MID-MAY. . .
 ARCHITECTURAL RECORD'S IDEA
 ANNUAL OF THE HOUSING FIELD

RECORD HOUSES AND APARTMENTS OF 1974

In mid-May Architectural Record's *Record Houses and Apartments of 1974* offers a timely opportunity for manufacturers of quality building products to exert year-in and year-out influence on those architects and builders who are at the forefront of the housing market. It will reach all major groups of specifiers and buyers in this market:

- over 43,000 architects and engineers who are verifiably responsible for 87 per cent of the dollar volume of all architect-planned residential building.
- 20,000 of the nation's foremost builders qualified by Sweet's on the basis of annual building activity to receive the Light Construction File.
- 4-5,000 leading interior design offices qualified by Sweet's to receive the Interior Design File.
- in addition, bonus bookstore distribution to an influential segment of the house building and buying public.

Record Houses and Apartments offers its advertisers a unique advantage:

The issue has the longest working life of any issue of any architectural magazine! Architects refer to it five, ten, even fifteen years after publication.

Don't miss it! Closing date: April 15.

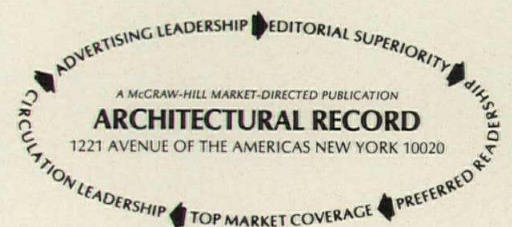

Site products such as furniture and grounds lighting have long been valued by architects and landscape architects as tools for organizing the landscape as well as for their obvious functional uses. This value recognition has pressed the professions to seek two basic quality objectives:

1. A repetitive quality
2. A functional and visual quality

To be used as organizer, products are usually incorporated in substantial repetitive quantities to achieve rhythm, balance, scale, direction and sometimes accent in the plan. This repetitive nature demands simplicity in form and color, and construction to be visually and economically feasible.

Because site products are provided first and foremost to satisfy a function, they automatically become quite visible on the landscape. Therefore, since they are visually prominent, the product itself must be of the highest quality. This usually means stability in form, durability, flexibility, permanence, functional competence and esthetic elegance.

We believe the industry has by and large responded.

For instance:

Visible source lighting products have permitted designers to achieve an identity and priority to circulation systems at night much the same as an alley of trees might do during the day. Sterner Lighting Company's circular globe lamps on black anodized standards are in themselves simple, elegant and economical.

Accent in addition to function is illustrated by Niedermeyer/Martin Timberform Division which has produced some interesting play modules that are also exciting wood sculptures.

Many products such as the planters produced by Architectural Pottery Incorporated, sculptures in themselves, have permitted and encouraged the planting of colorful annuals and shrubs especially in the urban landscape where excavations are problematic. The mobility of planters also permits variety and flexibility in design solutions.

Occasionally there is a desire to make the visible product "invisible" such as in the case of fencing where the function is strictly utilitarian. Colorguard Incorporated produces a cyclone fence with a black vinyl coating that seems to disappear, especially in the wooded landscape.

The following pages illustrate a composite of such products. Select them for their inherent quality, but equally or even more importantly, use them to put order and general organization into the site scene.

*John G. Litynski
Bristol, Leaver, Litynski, Tarbox, Hollister and Moore,
Landscape Architects,
Saratoga Springs, New York*

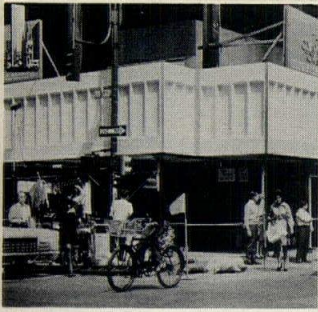

46

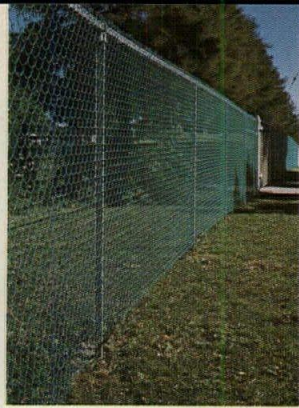

47

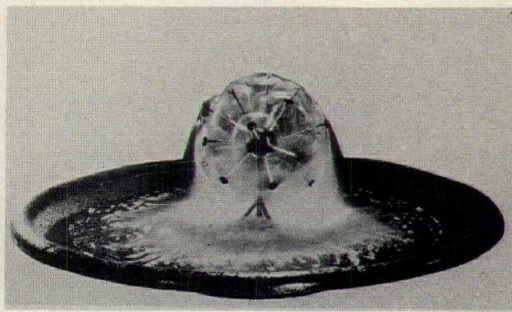

48

FENCES & GATES

46 FIBERGLASS FENCE / The modular fiberglass panels, measuring 5 ft 2 in. wide by 8 ft high are surfaced with a hard, slippery gel-coat that can be easily cleaned of graffiti, according to the company. Integral colors are offered. / MFG Concrete Forms.

47 VINYL COATED FENCE / This chain link fabric never needs painting according to the company and is extremely resistant to abrasion. It has no sharp edges. / United States Steel Corp. A*



49

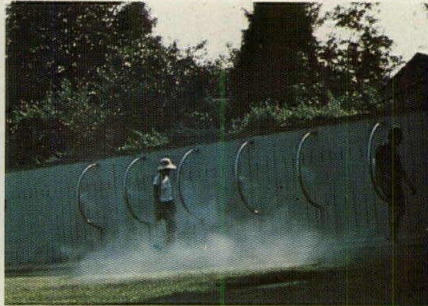

50

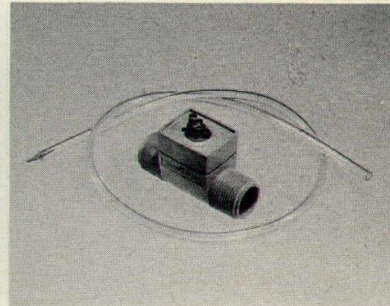

51

FOUNTAINS & POOLS

48 WATER SPHERE / The fountain consists of finely tuned nozzles producing fine sheets of water at the ends of the stems. Available with all necessary piping, pumps and underground fountain lights, ready to place in pools of conventional construction. Shown with fiberglass pool that can be supplied. / Roman Fountains Inc.

49 WATER SCULPTURE / Heavy-duty steel water play and climbing equipment, approved by the New York City Parks and Recreation Department, is recommended for children's playgrounds. / Anita Margrill, Inc.

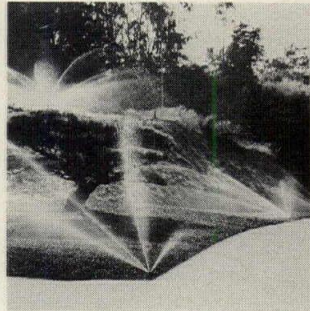

52



53

50 FOG FENCE / That is the name of this fountain of stainless steel pipe, measuring 6 by 24 ft. At timed intervals, the highly polished semi-circles emit billowing clouds in a fine fog-like spray. / Anita Margrill, Inc.

IRRIGATION SYSTEMS

51 FERTILIZER INJECTOR / Liquid fertilizers may be applied through existing sprinkler systems with this product that is said to be made of non-corrosive PVC and screened at one end to prevent clogging. / Rain Bird Sprinkler Mfg. Co.

52 SPRINKLER HEAD / This gear-driven sprinkler head is said to provide accurate coverage of large areas with a low precipitation rate that matches the capacity of the soil to absorb water. Designed for residential and commercial irrigation systems, the product comes in three sizes to cover diameters up to 64 ft. / The Toro Co.

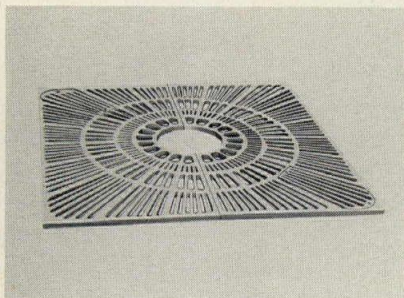

54



55

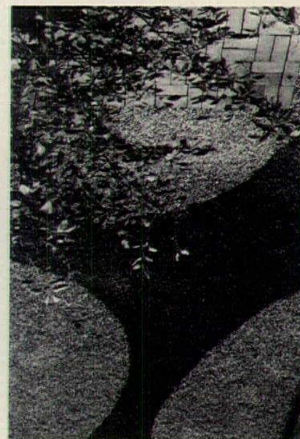

56

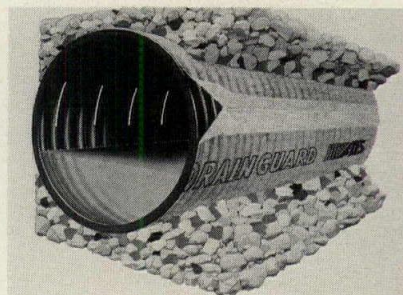

57



58

53 SPRAY HEAD / Wide, 12-ft spacing of these spray head sprinklers is said to keep cost low and the heads have an adjustable diameter. Eight models are offered with patterns varying from full circle coverage to that for a narrow strip. / Rain Bird Sprinkler Mfg. Co.

LANDSCAPING

54 TREE GRATES / Twelve designs have been added to the company's line of tree grates, for a total of 29 types and sizes including round, square, hexagonal, etc. The grates are made in geometric patterns as well as in custom designs. / Neenah Foundry Co. A, L*

55 LANDSCAPE TIMBERS / Timbers of varying length, width and thickness are pressure-treated with a preservative so they can be used for steps, retaining walls, etc. A silvery-green color is imparted by the preservative and wood is non-staining, non-injurious. / Osmose Wood Preserving Co.

56 EPOXY SURFACE / Formed by combining dry stone with epoxy to form the monolithic textured surfacing, the product is said to provide a long-lasting "mulch" around walkways, plants, etc. The aggregate will not erode away and can be used with varied colors to form patterns. / Hallemitte Div., Sterling Drug Inc. A, I*

SITE DRAINAGE

57 SANDY SOIL DRAINAGE / For silty soils, *Drain-Guard* combines corrugated plastic drainage tubing with a factory-applied nylon screen to prevent the drain lines from clogging. Available in 4-, 5- and 6-in. diameters. / Advanced Drainage Systems. A, L*

SITE FURNISHING

58 GIANT PLANTER / Super radius cylinders and squares of molded fiberglass create massive planters from 3 to 8 ft in diameter and from 1 ft 6 in. to 3 ft in height. Available in a variety of smooth matte finish colors. / Group Artec. D*

59 TIMBER BENCHES / Constructed of heavy Douglas Fir timbers and pressure-treated to withstand insects and decay, this line of benches, planters, trash receptacles, signage and lighting standards is available in the same vocabulary as the company's play systems. / TimberForm Div., Niedermeyer-Martin Co.

60 BENCH / Hanging bench modules can be used singly or in multiples of any number. The maintenance-free fiberglass units are hung from existing structures by a system of concealed metal supports. Units are 22 in. wide and 4 ft long, and available in colors. / Reinforced Plastic Industries, Inc.

61 LITTER RECEPTACLES / Lift-off covers of integrally-molded Duranodic bronze aluminum are stain-resistant, according to the company, and offer access to inner containers and optional poly bags supported on an inner ring. Lightweight molded fiberglass receptacles are available in many colors. / Group Artec. D*

62 PLANTER / Fiberglass construction is featured in this line of planters in various sizes from 12 to 32 in. high, with diameters of 21 in. at the top and 12 in. at the bottom. Drainage holes may be added if specified and colors are offered. / Reinforced Plastic Industries, Inc.

63 LITTER RECEPTACLES / Side openings shielding trash from weather and lift-off or swing-away covers are said to make these containers ideal for public areas. Lightweight fiberglass construction will accommodate poly bags supported on integral inner rings. Available in many colors. / Group Artec. D*

64 KIOSK / A system of square, rectangular, cylindrical and triangular elements that serve many purposes such as telephone kiosks, vending machines, lighting units and litter receptacles also provides support for informational or decorative graphics. / Group Artec. D*

65 VANDAL-PROOF BENCH / This bench is available in 4- and 6-ft. lengths, made of California redwood locked into a high-strength aluminum alloy frame. It is offered with members for concrete footing installation or with welded base plate for anchoring. / Colorguard Corp.

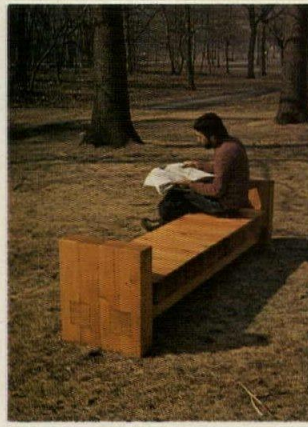

59

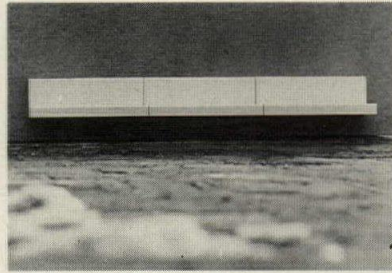

60



61



62

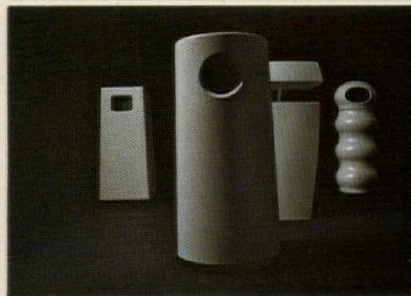

63

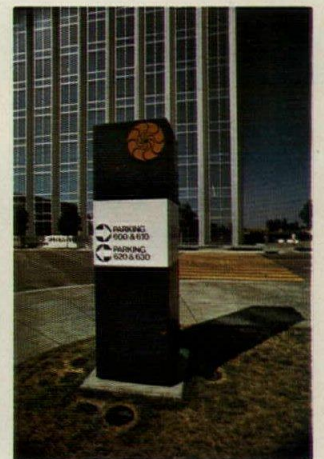

64



65

Beauty That's Much More Than Skin Deep...

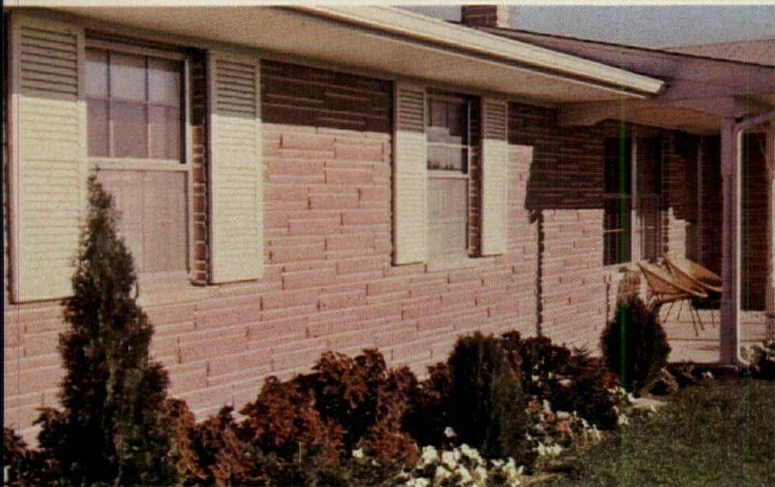

Split Block with Medusa White

It's easy to see that Split Block made with Medusa White Cement is beautiful on the surface! But its real beauty is more than on the surface.

Your economical Split Block wall provides a lasting beauty of fire-safety, sound absorption construction, self-insulation and



freedom from costly, continual maintenance. All of which adds up to more than meets the eye for your building dollar.

It is a strikingly elegant design tool combining practicality that retains inherent wall beauty over many, many years. And one thing more, it's readily available now — nationwide — in a wide assortment of colors and textures.

So satisfy your esthetic and economic values at the same time with one beautiful wall material . . . Split Block with Medusa White. And for matching, contrasting or complementing mortar, specify Medusa Custom Color Masonry Cements . . . in any of a multitude of colors. For more information, write Medusa Cement Company, P. O. Box 5668, Cleveland, Ohio 44101.



For more data, write A9 on inquiry card

MEDUSA CEMENT COMPANY Division of Medusa Corporation

Rumblings are being heard in the concrete industry indicating a period of change.

Awakening to the need to keep up with technological advancement, past practices are being questioned, innovators are gaining a foothold, sophistication is increasing and concrete is entering a new era.

These pages report a few of the changes which have been announced during the year. Because of structural implications, major changes require extended development periods before introduction to the marketplace. It is appropriate here to comment upon the rumblings and to consider their future impact as well as note the immediate achievements.

Systems are being re-analyzed and the successes and failures of earlier housing-related construction evaluated to introduce better approaches for both off- and on-site fabrication. The trend towards multi-family housing is stimulating greater attention to inherent concrete safety and low sound transmission. The energy crisis is furthering attention to development of high strength foamed concrete.

The new product with resulting reduced dead weight, excellent acoustical value and minimum energy input requirement for a controlled living environment will be an important contribution to the builders.

Methods of forming, placing and consolidating the concrete are receiving special attention. Pumps are in production which are of such character as to allow their use with minimum water and sand. The technology of concrete-related chemicals is advancing rapidly. Special forms are becoming increasingly available to those who would design and use modular shapes to overcome the dwindling availability of form lumber and carpentry labor.

There is more acceptance of the use of concrete in architecture. This trend is being forced not only by the architect but also by the environmentalist. The layman is demanding more of his visual environment, necessitating changes from the poorly-held visual image of concrete as used in past structures.

We commend not a single product, but a combination of products and ideas in the form of a structure as the concrete achievement of the year.

The Dallas/Fort Worth Airport, larger than the Island of Manhattan, is a concrete creation on the plains of Texas, which blends with the land to become a part of environment of the Southwest.

*James M. Shilstone, president,
Architectural Concrete Consultants, Dallas, Texas*

When the building is exciting... The paneling is Ar-Lite.



Ar-Lite is constantly developing new techniques to accommodate the paneling needs of contemporary designs in architecture.

As reflected in the new Sculptura technique, architects can now design and create their own textured reliefs.

Whether insulated or facing, Ar-Lite precast resinous concrete panels are functional by their lightweight, dependable design.

Anywhere in the world, we invite your inquiry.

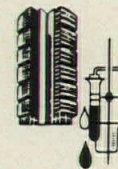

Architectural Research Corporation

AR-LITE

WORLD-WIDE MANUFACTURING FACILITIES

UNITED STATES

Architectural Research Corporation
12068 Woodbine
P.O. Box 5766
Detroit, MI 48239
313/538-4013

Merry Companies,
Incorporated
P.O. Box 1474
Augusta, GA 30903
404/772-6831

AUSTRALIA

Calsil Ltd.
AR-LITE Panel Division
46 Bessemer Street
Blacktown N.S.W. 2148
Australia Phone: 621-1666

BELGIUM

Panelcraft
S.A. Werister Bolte Postale
4610 Beyne-Heusay (Liege)
Belgium Phone: 04/58.56.20
Telex: 41,762

HOLLAND

Panelcraft N.V.
Postbus 8 Kesteren
Holland
Phone: 08886-457

Harvard School of Public Health, Boston, Massachusetts;
Architect: William Kessler & Associates, Inc.
Contractor: The Volpe Construction Company, Inc.

For more data, write A10 on inquiry card

CAST-IN-PLACE CONCRETE

70 DESIGN MANUAL / A comprehensive design manual is said to provide the architect with explicit guidelines to achieve design objectives with precast concrete. Available at \$15 per copy. / Prestressed Concrete Institute.

77 PLASTIC FORM LINING / Offered in 4 by 10-ft sheets, the plastic form liner fits almost any type of forming being used on current highway and bridge construction, according to the company and gives an exposed round aggregate effect to concrete. / Symons Corp. A, L, I*

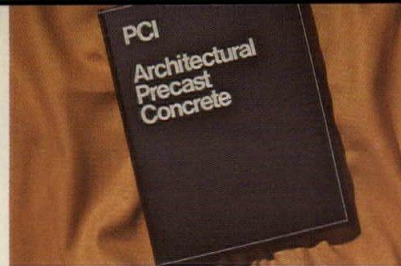

70



71

CONCRETE ACCESSORIES

71 CONCRETE SEALER / This acrylic sealer offers weatherproofing, stainproofing, sealing and dustproofing qualities, according to the company. It may be applied on horizontal or vertical concrete and masonry surfaces, inside or out. / W. R. Meadows Inc. A*

CONCRETE MATERIALS

78 EMULSION BINDER / An acrylic emulsion binder is recommended for improving portland cement mixes for exposed aggregate and stucco. The result is said to produce modified matrices that become self-bonding, self-curing, with stone-popping virtually eliminated. Shrinkage cracking is also said to be reduced. / Larsen Products Corp. A*

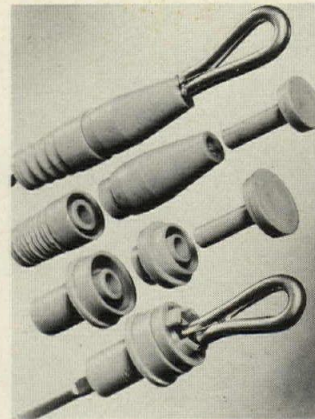

72

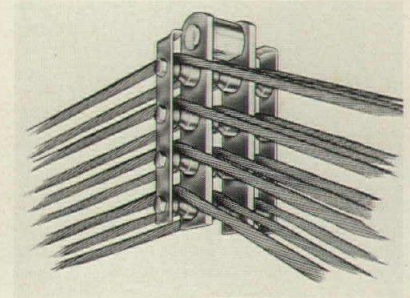

73

72 CONE AND PLUG / A plastic cone and plug for fast removal and attractive wall finish on both residential and commercial concrete applications can be used for gang forms or built-in-place wall forming. Three finishes are available in plugs. / Gates & Sons, Inc.

CONCRETE REINFORCEMENT

79 DOWEL BARS / The company's *Doublecoat* steel dowel bars are said to provide a jointing system for long-lasting highways. The twin coating system consists of a polyethylene outer jacket over mastic. The outer coating will not bond to concrete. / Republic Steel Corp.

73 STRAND HOLD-DOWNS / In prestressing the company's swivel-action hold-down is said to reduce friction through the combination of swivel and free-turning rollers. Friction is reduced in all strands as they are tensioned. Units are offered in single, double and triple rows. / Dayton Sure-Grip & Shore Co.

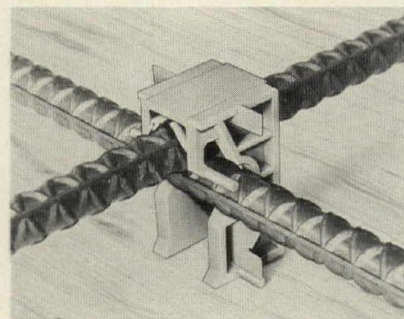

74

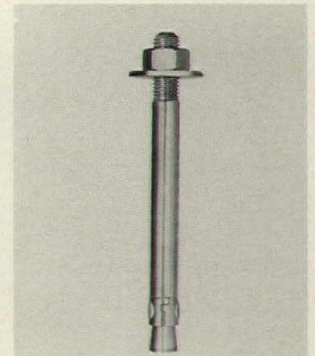

75

74 REBAR SUPPORT / Bars for concrete slabs can be tied in place, spaced and supported on one operation with this product, according to the company. Product is made of plastic and will not rust, while supporting the steel at the required height of the deck. / Gateway Building Products.

PRECAST CONCRETE

80 FLOOR PLANKING / For high-rise and low-rise construction, the system consists of 15 in. by 10 ft metal-edged gypsum planks offering a 2-hour fire rating and sound ratings up to STC 51. The floor planks go in right after steel bar joists, eliminating temporary flooring and job delays, according to the company. / United States Gypsum Co.

75 STUD ANCHOR / This one-piece anchor bolt made of high tensile steel is installed in a hole of the same nominal diameter, saving on installation time according to the company. The one-piece construction is said to have greater shear strength than a common bolt. / The Rawlplug Co., Inc. A*

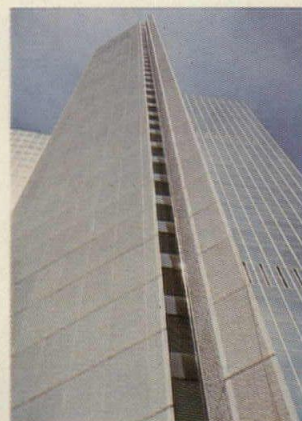

76



77

CONCRETE FORMWORK

76 FORM LINERS / The company's liners are said to offer a low-cost method of reproducing any pattern or texture in poured concrete, because of the elastomeric quality of the liner. Barnwood, bush-hammered, smooth sand finish, wire cut or old brick patterns can be produced. / Styro Materials Co.

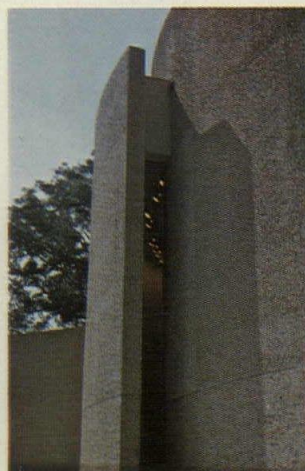

78



79

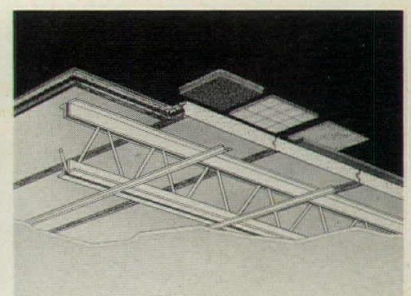

80

Glen-Gery **Panelbrik™**

Here's an economical building material with natural beauty.

The new S. S. Kresge Co., International Headquarters building at Troy, Michigan, is an excellent example of design integration with complementary exterior building materials. The decision to include Glen-Gery *Panelbrik* was based on several considerations.

First of all, *Panelbrik* provides a contemporary answer in masonry walls — blending with the total architectural environment. And, like other genuine fired-clay building units, *Panelbrik* meets the challenge of costs — initially — and for the long term. It requires no maintenance.

Glen-Gery is one of the nation's largest manufacturers of structural clay products. We would like to tell you more about our wide product line. Simply write, Glen-Gery Corporation, Box 206, Reading, Pa. 19607

For more data, write A11 on inquiry card

Owner: S. S. Kresge Company, Troy, Michigan

Architects and Engineers: Smith, Hinchman and Grylls Associates, Inc., Detroit, Michigan.

Photo: Balthazar Korab



The past year has witnessed the introduction of some new products and the greater acceptance of some others which have been available.

Among the new, a concrete block and plaster system which promises to revolutionize the small home foundation by providing a strong watertight basement and will simplify the construction of the neo International Style homes and rowhouses which seem to be leaving the shore for the city. The system consists of a glass fibered cement mix which is plastered on both sides of concrete block, laid up dry.

For those who may have missed the announcements, SCPI, the Structural Clay Products Institute has changed its name to BIA, Brick Institute of America (1972). There are some extremely knowledgeable consultants available through area brick councils, to advise architects and contractors about the fine points of brick design and construction. The Concrete Masonry Association also offers consultant services. Many construction pitfalls can be avoided by talking to the right people.

Large-scale brick is becoming more available and architects, who prefer the scale of the 8- by 8-inch, 12- by 12-inch, etc. brick, are gaining support from builders and contractors who are discovering economic virtues in among the esthetics. Full evaluation of the brick units is not complete, but just as use of jumbo brick represents an economy, it is reasonable to expect economies to result from use of the large-scale units.

There is a trend away from the white or light toned brick, so popular for high-rise construction. Use of darker brick—earth colors—is gaining headway.

The darker masonry looks best when bedded with tinted mortars which can be either slightly lighter or darker than the brick colors, the darker mortars are more often favored by the architects. Quantity mixed mortars using pre-measured dye packets or other proportional controls, assure consistent mortar coloration throughout the work.

Concrete block manufacturers, and the public have finally accepted the idea that concrete block can be shaped, textured and colored. The architect who selects ribbed or split or colored block, is now often successful in finding samples and assistance within his own area, and more than one block manufacturer interested in submitting a bid.

*Alex E. Goldfine, Consulting Editor,
Sweet's Guidelines, New York, New York*



Panel sizes: 8' x 4' and 4' x 8'

Is it or isn't it?

Yes and no. Yes, this beautiful interior wall is brick but it's not hand laid brick. And it went up without the traditional time and expense of hand laid brick.

This brick is ECONOBRICK®—one inch thick panels that “lay” 216 real, honest-to-goodness clay-fired brick 32 square feet at a time. Installation simply consists of positioning the panels on the studs and fastening. Matrix and matching sand are supplied with the panels for concealing the fastener heads. Position, fasten, touch-up—that's all there is to it.

ECONOBRICK panels. Real brick, made from natural clay, available in tones of red, white, antique, gray and brown.

List of approvals sent upon request.

Your dealer has samples and if you would like additional information, please write direct.

ECONOBRICK Division

Merry Companies, Inc.

P.O. Box 1957 / Augusta, Georgia 30903

MASONRY ACCESSORIES

85 CONTROL JOINTS / Extra wide elastomeric vinyl control joints to accommodate walls up to 13 in. wide are designed to fit standard sash blocks and provide a vertical joint for the relief of stress in concrete masonry walls. Available in 4-ft lengths. / AA Wire Products Co.

MASONRY RESTORATION

86 PATCHING COMPOUND / Thorite is said to develop a high compressive strength and does not contain any metallics, so it will not rust. It does not require forming. / Standard Dry Wall Products, Inc. A*

MORTAR

87 MORTARLESS CEMENT / This is a glass fiber mortarless cement to bond block and give a waterproof, decorative finish, according to the company. It can be applied in a variety of textures. Available in white and can be painted. / W. R. Bonsal Co. A,L*

88 MASON'S LIME / A pressure-hydrated mason's lime is formulated to trap air as the mortar is mixed. This entrained air is said to go completely through the mix and take water with it. Lime and mortar will also carry more sand. *Bondcrete* complies with ASTM Standard C 207 Type S and Federal standards. / United States Gypsum Co.

SIMULATED MASONRY

89 MASONRY VENEER / Lightweight and economical according to the company, *Facespan* panels are as thin as 3/4 in. and are said to replace quarried stone and precast panels three to four inches thick. Panels are said to be resistant to adverse environmental conditions. / Johns-Manville. A*

90 SIDEWALL PANELS / Ribbed *Corspan* panels with the characteristics of stone masonry are said to combine high strength and light weight with economy and low maintenance. Cored, tongue and groove construction is featured and panels are durable in all climates, according to the company. / Johns-Manville. A*

STONE

91 GRANITE PAVERS / Thermal finished granite pavers are available in a wide range of the colors and finishes, according to the company. / Cold Spring Granite Co. A*

92 MARBLE SILL / In six colors, this cultured marble can be used for sills, counters and table tops. Because veining and color can be controlled, the marble can be custom-matched to decor. It is said to be four times stronger than quarried marble. / Acorn Marble Products Co.

UNIT MASONRY

93 BRICK WALL PANELS / Using high-strength mortars and high-compression fired brick, each section of these panels is reinforced with steel rods and post-tensioned, according to the company. Up to 12 ft wide and 10 ft high, sections are offered up to 8 in. thick and in several earth colors. / Kurtz Precast Corp.

94 RIBBED MASONRY / *Panelbrik* units are made of fired clay and conform to the ASTM requirements for hollow brick. Measuring 4- by 8- by 8-in. and 4- by 12- by 12-in., the product can be beveled or fluted, lengthened or widened, or made to specific requirements. A range of colors is offered. / Glen-Gery Corp.

95 THROUGH-THE-WALL UNIT / Available in many colors, the unit is made of dense aggregate concrete with no clay used. It divides an 8-inch wall with finished brick face on four sides and is said to exceed FHA and HUD requirements. The brick measures 8 by 12 by 1 1/2 in. / Rus-tique Brick International. A*

96 GIANT BRICK / The company has introduced a brick for hollow masonry construction that is designed for load-bearing through-wall construction. The product is improved to the extent that lighter weight is claimed along with a moisture barrier quality to prevent capillary action from one side of the brick to the other. / Dresser Industries Canada Ltd.

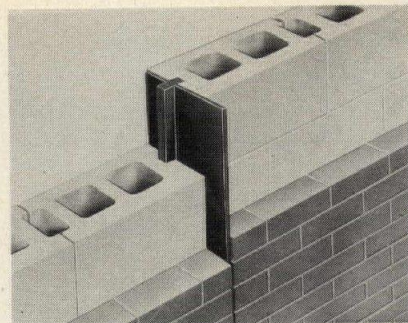

85

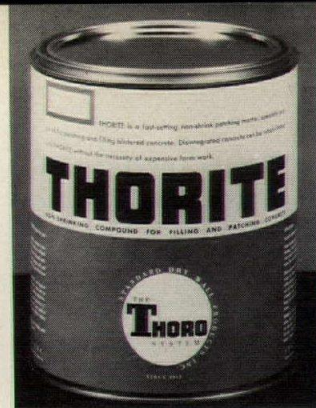

86

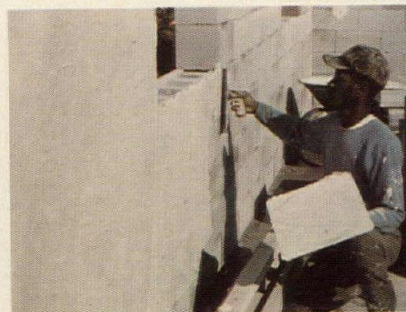

87



88

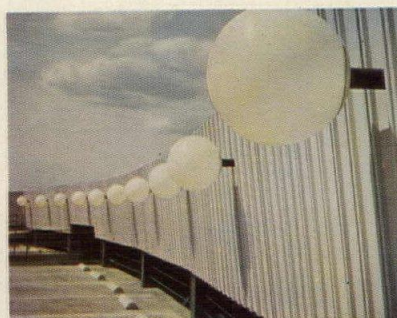

89

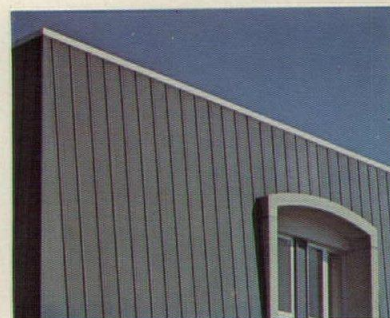

90

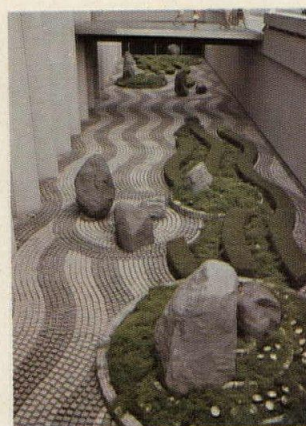

91

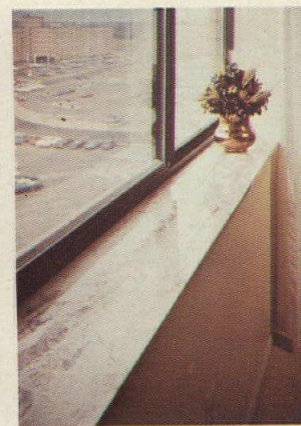

92

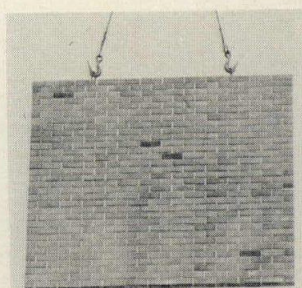

93

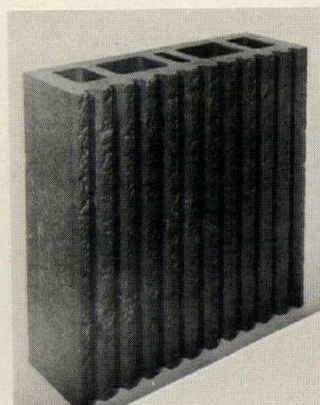

94

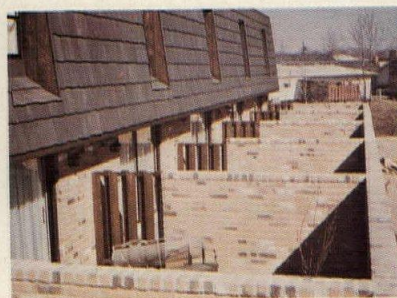

95

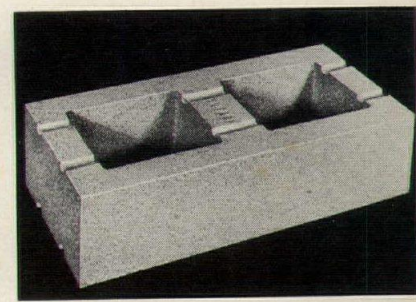

96

Britain's finest international architectural and design magazine

The Architectural Review

The Architectural Review is read and enjoyed in major architectural and planning practices and by people with an interest in buildings and fine design in a hundred countries. It is one of the world's important publications. Each month The Architectural Review is studied, quoted and argued about for its views on topography and townscape and for its thorough and thoughtful criticism of new buildings and their interiors. Then it is kept for future reference.

It has a reputation for superb photo-journalism, for fine detailed drawings and for a positive and creative approach to criticism of significant buildings and the problems of the built environment. Sometimes most of a complete issue is devoted to an interesting complex of buildings or to a single subject. These special issues can become standard works of reference. Years afterwards architects and planners ask us for back numbers on specific subjects. Almost every

month interior design is featured and the current art scene is reviewed. The Review has a long history of encouragement to architectural and planning innovation and is continually searching for new talent. Awards are not usually given to publications in the UK but recently the Italian government's Gold Medal was awarded to The Architectural Review for outstanding international services to the better design of the human environment. The editorial

director in 1971 won the annual Royal Gold Medal of the RIBA (previous holders included Buckminster Fuller, Le Corbusier, Lewis Mumford, Mies van der Rohe, Walter Gropius) and the retiring editor recently won the Royal Society of Arts Bicentenary medal. Recent editorial excellence is, apparently, being maintained as current sales of the Review are higher than ever before in its 76-year history.

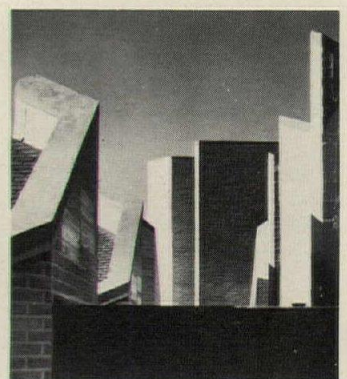
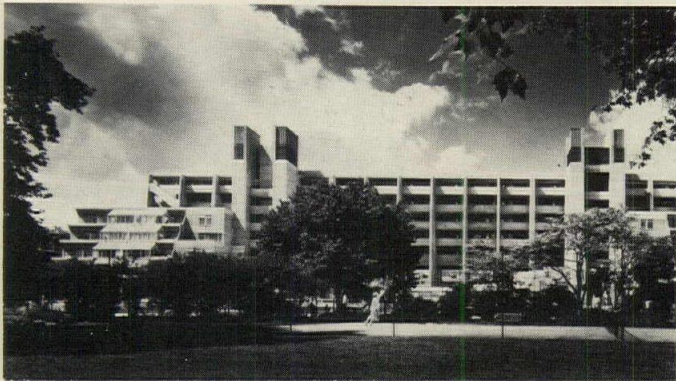

The Architectural Review is a valuable professional aid for busy practices. An annual subscription also makes a memorable all-the-year-round present for friends and colleagues. To see this provocative and professionally-stimulating publication regularly, please fill in and send off this coupon:

Please send me The Architectural Review monthly (12 copies) at the annual post-paid subscription rate of \$30.

MY NAME/POSITION

MAILING ADDRESS

Country

Type of Firm

I understand that the current issue will be despatched on your receipt of my cheque/int. money order/bankers draft.
 Payment enclosed.

Signature

PR-74

Indicate as appropriate.

- Architect
 Engineer
 Other

The Architectural Press Ltd,
 Dept R, Registered Office
 9 Queen Anne's Gate, Westminster,
 London SW1H 9BY, England.

Registered England 75921

Spotlight on Engineering for Architecture

Architectural Record is planning a timely expansion of its editorial services to engineers, architects and the manufacturers who market to them.



ENGINEERING FOR ARCHITECTURE

A Spotlight issue devoted to a highly professional presentation and analysis of the most significant developments in engineering for building—featuring:

- the engineer resources: the right way to use the right people to get the right expertise at the right time.
- the technical resources: an overview of the current state of building technology, with a particular look at the most important developments.

Scheduled for publication in mid-August 1974 and annually thereafter.

A McGraw-Hill Market-Directed Publication

ARCHITECTURAL RECORD

1221 Avenue of the Americas, New York 10020

new! stone-lok^{T.M.}

versatile reinforcing system
ties stone veneer to
backup wall!

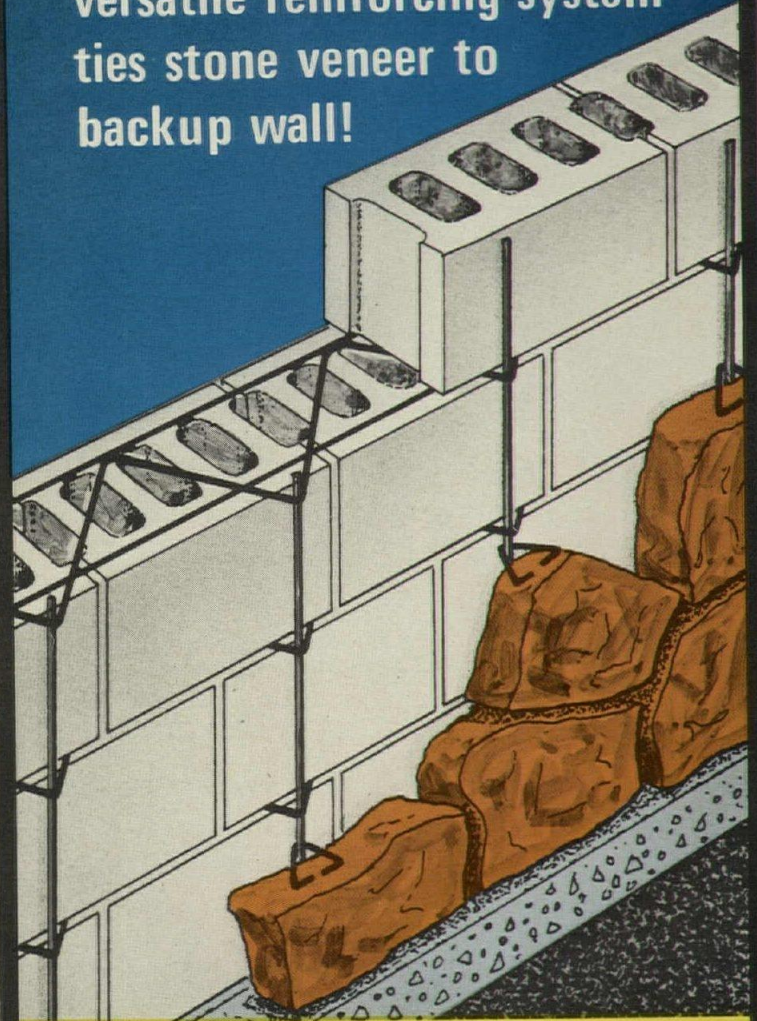

U.S. Patent No. 3309828 Cdn. Patent No. 744135

Complete versatility and simplicity are some of the advantages of Stone-Lok. Ties can be placed at *any* point in the vertical dimension of the wall — *regardless* of varying thickness or shape of stone.

Stone-Lok makes the mason's job easier and ensures that ties can be placed in the most practical manner to meet building codes . . . and Stone-Lok also adds a TRUSS style reinforcing to the backup wall. **GET MORE INFORMATION TODAY!!!**

AA
WIRE PRODUCTS COMPANY

6100 S. NEW ENGLAND AVE. • CHICAGO, ILL. 60638 • (312) 586-6700
MANUFACTURED IN CHICAGO, ILLINOIS • DALLAS, TEXAS • ONTARIO, CANADA

For more data, write A13 on inquiry card

TECHNICAL KNOCKOUTS.

At the World Trade Center...bright new ideas using stainless steel.

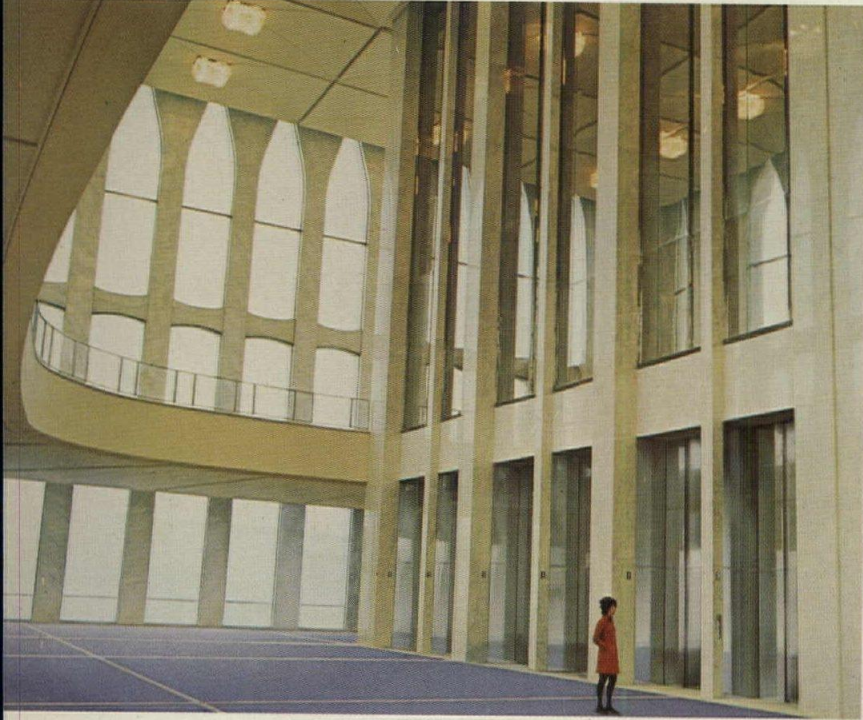

For the seven-story lobbies...

More than 35,000 feet of matched stainless panels without a ripple or a fastener show-through... created by architect Minoru Yamasaki for the new twin-tower World Trade Center in New York City. With the help of the fabricator-erector, the local Steel Service Center, the polishing source, and Republic's mill, the desired result was achieved. A total of 1,000-plus stainless panels in bright #8 mirror finish, soaring seven gleaming stories from the lobby floor. A technical knockout made possible by the cooperation of these suppliers with the architects and builders.

For moving 2,400 people per hour, per door...

196 of perhaps the most advanced revolving doors ever designed. Manufactured by Crane Fulview Glass Door Company, these 9-foot doors feature manual speed control which prevents rapid acceleration of the door, factory set to engage at 12 rpm, and a special panic proof mechanism that causes the wings to fold flat whenever pressure is exerted from two different directions. To meet the aesthetic and durability demands of the job: Republic ENDURO® Type 304 stainless steel with a prebuffed finish. This finish permits better inspection at the mill and at Crane's plant because any surface flaw is immediately apparent.



For serving 6,000 lunches a day...

This kitchen for the State of New York's multimillion-dollar dining room high in the South tower utilizes the newest design ideas in fast food preparation and service. And it will stay bright and gleaming, day after day, cleaning after cleaning, because nearly everything in sight is Type 304 stainless steel.



Other elements of the building interior using stainless steel include curved floor gratings, flashing, curved railings, escalators, and elevators.

Looking for equally memorable achievements? Consider American-made Republic ENDURO stainless steels in sheet, strip, bar, billet, special sections, tubing, pipe, wire, plate. Your choice of finishes, sizes, chemistries, tempers... available from our mill or Steel Service Centers nationwide. It's your guarantee the beauty will last forever.

For "in-depth" information on these unique applications using stainless steel, write Republic Steel Corporation, Cleveland OH 44101.

Republicsteel



Member Steel Service Center Institute

For more data, write A14 on inquiry card

Judging from economic reviews and forecasts, and a scan of new-product literature, the specification of structural and decorative metals in building construction should increase in 1974.

In stainless steel, although accounting for only 1 per cent of all steel produced, the growing cost of maintenance of exposed metal surfaces makes the new alloys, color and surface treatments of stainless steel more competitive, with exposed building materials of lower first cost.

In many other metals, notably copper, new cladding techniques and finishes should encourage experimentation and innovation by architects and building designers in the application of this age-old material.

Probably the greatest advances being experienced in the promotion and acceptance of new metal products is in the area of light gage and lightweight metal framing. The ever increasing expense of field labor skilled or unskilled, and correlating trend to off-site, modular construction, emphasizes the advantages claimed for light gage metal framing as a primary structure for low-rise and intermediate-size buildings. Metal framing is also supplementing the structurals in large steel or reinforced concrete buildings.

Closer tolerances, high load-to-weight ratios, and comparatively stable calendar-year pricing are just a few of the inducements behind the increase in specification of metal framing systems.

In steel, the new lighter and stronger alloys, augmented by new corrosion-resistive and protective coatings, are being employed in basic structural shapes exposed to the elements—often at less cost than stainless steel. More efficient composite and cellular steel roof deck and flooring systems have been developed which result in lighter buildings with more usable inside space.

In aluminum, deep inroads are being made in the competitive marketplace formerly dominated by wood and other non-metal building materials. Light gage, multi-functional aluminum extrusions are surpassing their wood counterparts in many areas and, often, their non-standard structural shapes are designed to permit integral glazing, electrical and mechanical combinations.

The latest developments in color anodizing of aluminum and new shop or field-applied finishes further enhance the position of architectural aluminum.

U.C.I. Section 5 embraces many configurations of metal, ferrous and non-ferrous: grilles, screens, railings, stairwork, gratings, castings, as well as the common structural shapes related to framework and framing, their accessories and fasteners.

The new product development in basic alloys and their finishes are reflected in these metal components—as well as those in other UCI Sections from which metal windows, doors, partitions, roof and siding, fencing and hundreds of other metal products are specified.

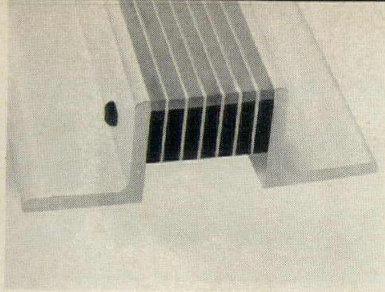

100

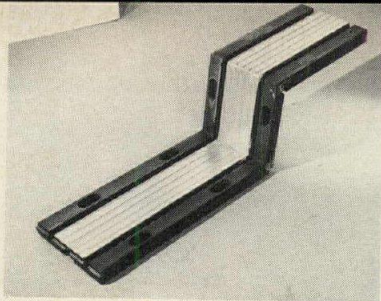

101

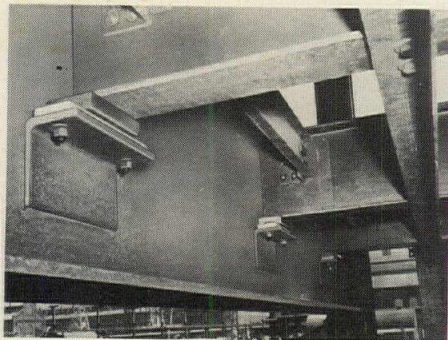

102

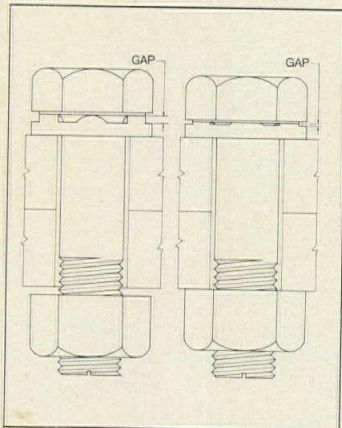

103

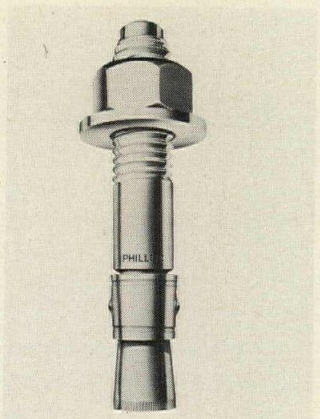

104

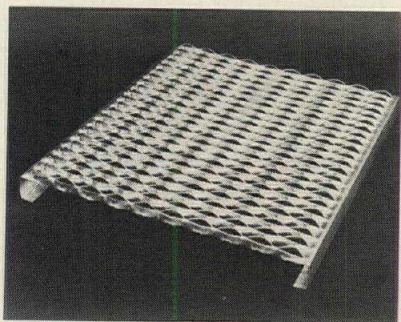

105

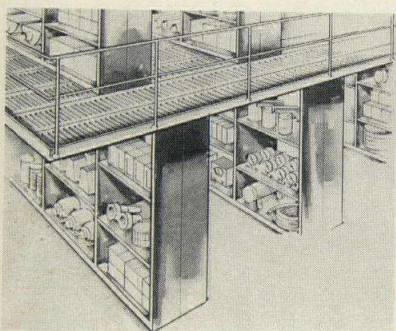

106

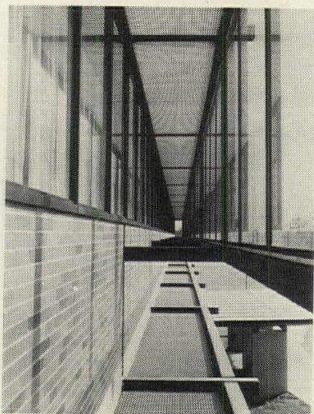

107

EXPANSION CONTROL

100 EXPANSION JOINT / This premanufactured expansion-contraction joint in various widths (increments of 1/4 in.) for horizontal deck surfaces is produced in 6-ft. lengths which are self-aligning, according to the company. Provides for up to 50 per cent expansion. / Marsten Products Co.

101 EXPANSION JOINT / These pre-fabricated curb and gutter units featuring rubber cushion expansion joints in which the neoprene can be bent upwards at a 90 degree angle without being cut. The joint has a continuous section of rubber. / Watson-Bowman Assoc. Inc.

102 EXPANSION PLATES / Bearing plates including types of self-lubricating bronze, Teflon, neoprene, preformed fabric and various combinations of these materials are said to provide support wherever structural members face thermal expansion. / Beeco Products Co.

FASTENERS & SUPPORTS

103 LOAD INDICATOR WASHER / The product is said to be a simple aid to the tightening and inspection of high-strength bolts. Available in sizes to fit maximum diameter 1 1/4-in. bolts used in steel construction. The bolt cannot be over-tightened. / Bethlehem Steel Corp.

104 WEDGE ANCHOR / This stainless steel wedge anchor said to be corrosion resistant was developed for installation in areas where acidic liquids and fumes attack carbon steel. Available in sizes up to 12 in. in length and bolt and drill sizes vary from 1/4 to 1 1/4 in. / ITT Phillips Drill Co.

GRATINGS

105 SAFETY GRATING / The 10-diamond, 24-in. wide grating is said to be suited to all types of working and walking surfaces where safety underfoot and low cost are prime considerations. High load capacity is claimed for spans up to 10 ft. One-piece construction. / United States Gypsum Co. I*

106 OPEN STEEL PLANKS / For double-decking storage areas, the product is said to be lightweight, made of 16-gauge galvanized steel. Sections are 12 in. wide. / United States Gypsum Co.

107 METAL GRATING / Shown is a combination sunshade and maintenance walkway made of the company's lightweight, pressure-formed metal grating, available in many dimensions and strengths, according to the company. The grating is said to provide typically 90 per cent open area without bolts, rivets or acute angles to clutter the grid. / Hendrick Mfg. Co.

108 SAFETY GRATING / Fabricated of 16 gauge steel formed into one-piece channels, this grating features a series of shoe-gripping nibs. Due to the narrow design, wheel carts will not snag when being moved over the grating. Offered in gray only. / Penco Products Inc.

LIGHTGAGE FRAMING

109 STEEL FRAMING / For residential use, this floor and wall framing system requires virtually no fasteners for assembly, according to the company. A snap-lock method is used instead. All system members are compatible with standard residential wood construction. / Bethlehem Steel Corp.

110 METAL STUDS / The truss design in this metal stud system provides extra strength and reinforces the web of the stud with both horizontal and vertical ribs. System accepts screws or glue, to attach wall, floor and ceiling materials. Available in a variety of gauges, widths and lengths. / Vulcan Metal Products, Inc.

METAL FABRICATIONS

111 HVAC BASES / The company will custom fabricate bases for roof-mounted heating and air conditioning units, providing insulation, wood nailer, built-in cant, choice of heights and other optional features. Heavy gauge steel construction. / ThyCurb.

METAL JOISTS

112 ALUMINUM FLOORING / The system that substitutes aluminum beams for wooden ones is said to be easily installed. / Reynolds Metals Co.

METALS & ALLOYS

113 ALUMINUM COATING / A wash-on sealer for anodized aluminum is designed as a replacement for lacquers and clear coatings. The company states that tests show the sealer extends anodized finish life by as much as 10 times, and cost is less than one-third of a cent per sq. ft. / Coricone Corp.



108



109

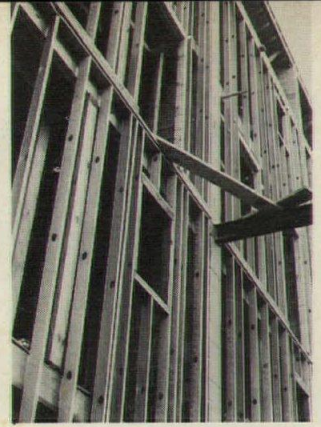

110

114 MOCK STAINLESS / Designed for trim and other applications where the look of stainless steel is desired but impractical. Textured *Chromesteel* is plated with highly ductile nickel and chromium for formability and resistance to corrosion, abrasion and heat. / Apollo Metals, Inc.

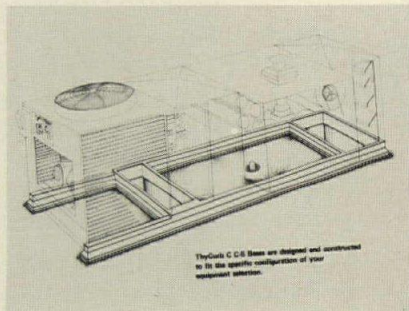

111

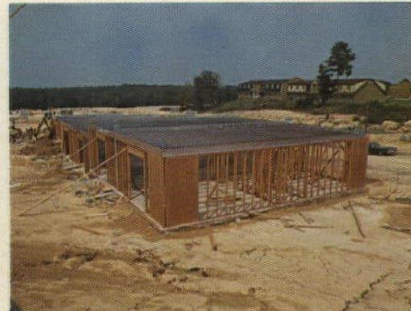

112

RAILINGS & HANDRAILS

115 HANDRAIL-BUMPER GUARD / Made of a vinyl alloy, the product is offered in seven colors, with contrasting end caps and accessories. Handrails are said to provide sure grip. / Construction Specialties, Inc. A*



113

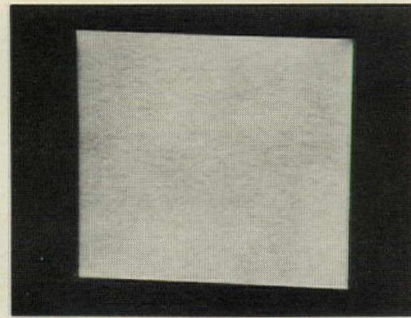

114

116 ALUMINUM RAILING / Available in colors, radius all-aluminum railings are said to be lightweight and feature all-welded construction, with no rivets or bolts. Top rails up to 4 ft wide can be curved, and thermoset acrylic paint in unlimited color selection will not crack or chip, according to the company. / Sun Control Products Co. L*



115



116

117 TOEBOARD SYSTEM / A flange and bracket toeboard system combines toeboard support with a safety rail structure, in both in-line and offset types. Meets OSHA requirements. / The Hollaender Mfg. Co.

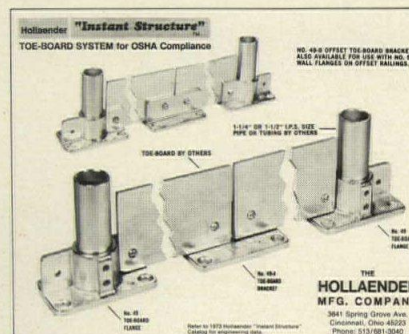

117

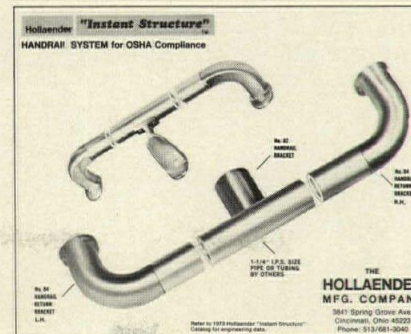

118

118 HANDRAIL / This pipe or tubing handrail combines with new end and center brackets to give a smooth, flush, non-snagging handrail of any required length, according to the company. / The Hollaender Mfg. Co.

There's nothing as powerful as an idea whose time has come.

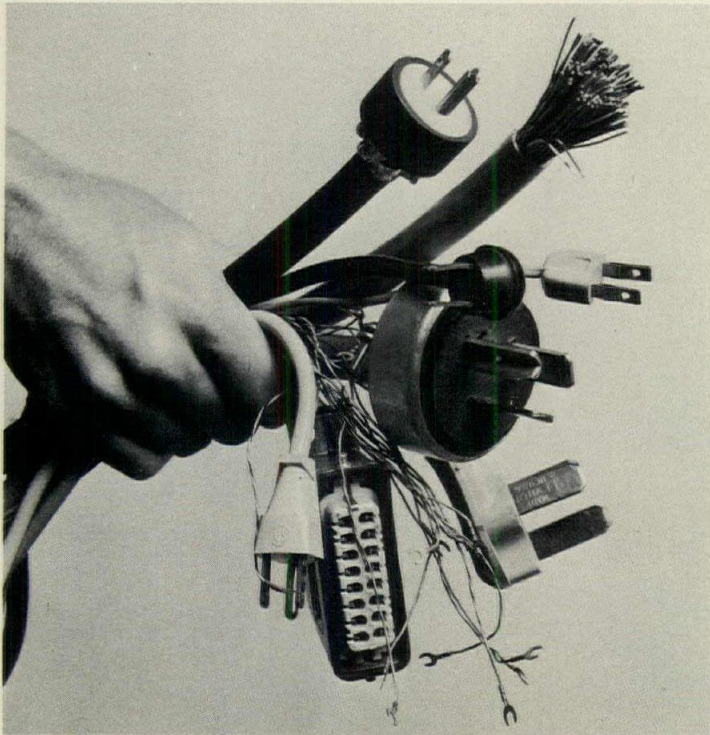

The Age of Electronics is here. And the office, a machine for communicating.

But unless your building anticipates the changes in office equipment, you may be in for a shock. Because not every building has the capacity to economically adapt to changing electrical demands. Changes that directly affect your operating cost, the building's life cycle cost.

When the idea behind change is to get people and ideas together faster, the communications system shouldn't get in the way.

Robertson Q-Floor: the plug-in floor that's actually part of the communications system.

We start with a load-bearing structural floor that offers the most efficient use of metal known in any composite steel floor. This new Composite-Floor/Composite-Beam construction can cut total floor assembly installed costs by up to 20% over noncomposite design.

Into the floor, we engineered the Taproute® system: the complete electrical system needed for power and communications. Ready for any equipment, anywhere, anytime. So while you're planning a traffic pattern above the floor, consider the electrical traffic pattern in the floor.

Whatever the electronic equipment, Robertson Tapway has the capacity.

Tapway® carries the complete wiring and communications systems. It's engineered with extra capacity for future wiring changes. A removable cover plate and pre-punched holes offer 100% accessibility.

No other electrical distribution system offers this capacity, accessibility and flexibility for the future.

Whenever the system is needed, a Tapmate is available.

The more people communicate, the more wiring capacity your building will need. Tapmate® units have 300% more capacity than any tombstone outlet. Tapmate will house three and five amphenol connectors. It carries maximum capacity of wiring or communications cable.

No tombstones, no stumbling blocks, Tapmate fits flush with the floor. It's ideal for open plan and office landscaping.

And a Tapmate unit is never more than the length of a desk away, under the desk, wherever you need it.

Whenever a change must be made, work doesn't stop.

No work interruption. No torn carpet to replace.

No after-hours double-time. Just open the Tapmate, pull-through the wiring needed, connect and close.

The more an office changes, the more the floor should stay the same.

One contract. One supplier. One responsibility.

Robertson supplies the complete electrical system, the complete floor system, engineered, fabricated and installed.

The Robertson Q-Floor with Taproute reduces the cost of change, the cost of space adjustment and the building's life cycle cost.

So, if you're looking for a way to build more electrical capacity into your next building, call a Robertson man today.

Or write H. H. Robertson Company, Dept. 736, Two Gateway Center, Pittsburgh, Pa. 15222.

Sometimes, foresight just means choosing the most versatile system available now.

For more data, write A15 on inquiry card

Robertson

There's nothing like Robertson Q-Floor[®] to anticipate ideas.

Tapway power compartment provides 30% extra capacity for future wiring. It costs 15% less installed than conventional trench header.

Tapmate also offers 300% more wiring space than standard "tombstone" units.

Multi-service Tapmate outlet units offer 100% accessibility to electrical/communications service.

Robertson Q-Floor develops the most efficient use of metal known in any composite steel floor. The Composite-Floor/Composite-Beam construction can reduce installed floor cost by up to 20%.

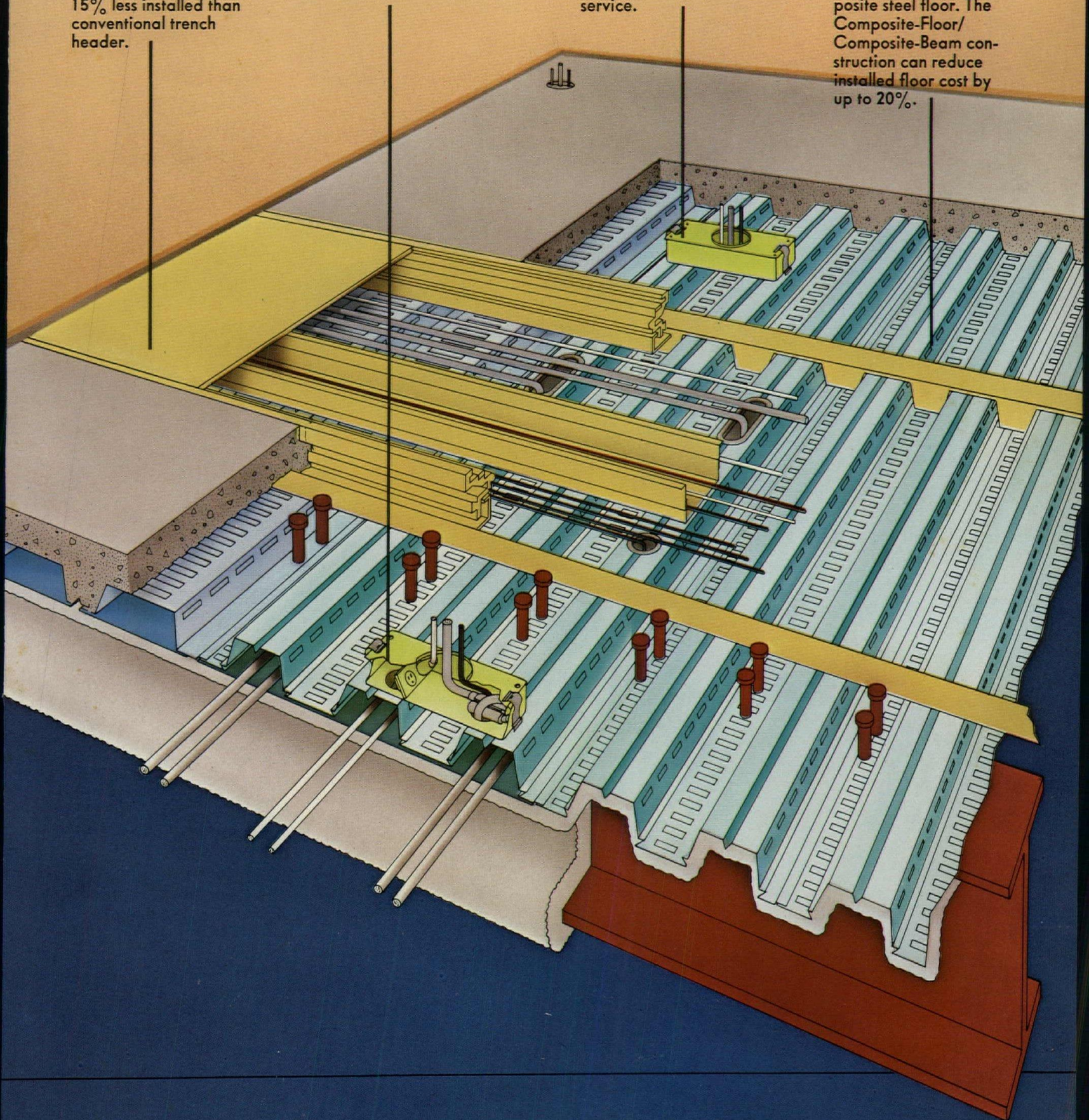

**Alumiframe
system,
the predictable
change.**

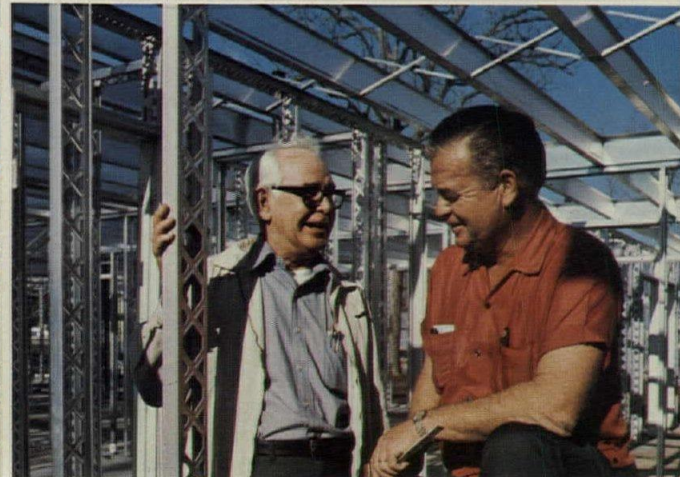
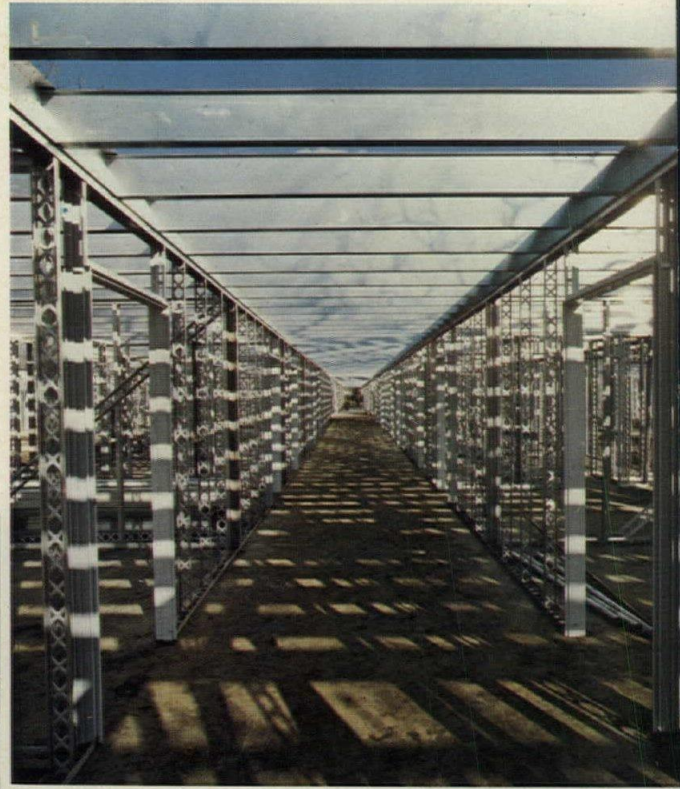

How big can you build with the Alumiframe system? How about light commercial like

Now, using the same Alumiframe* system that's won acceptance in residential construction, you can move into framed construction for the light commercial market.†

Like this 150-bed nursing home at Wharton, Texas. It's one of a series of Cartwheel Lodge Nursing Homes built by McDonnell Enterprises, Inc., a major developer of light construction in the Southwest. And everything the Alumiframe system offers residential builders, it offers light commercial builders.

The price of Alumiframe stays the same the full calendar year.

The conventional tools used in Alumiframe residential construction are also used in light commercial construction: ordinary carpentry tools, pneumatic nailer, portable circular saw with aluminum cutting blade and cartridge operated fastener.

The same fabrication techniques can be used, too. Alumiframe members nest for easy materials storage.

They're lightweight, for easy handling. Pneumatic nailing speeds production. And because wind, rain or sun can't damage Alumiframe members, they can be stacked on site indefinitely.

"We took a month off construction time with the Alumiframe system, compared to any other material," claims Ken Nunley, president of Alumifab Texas Company, an independent panelizing contractor who pioneered Alumiframe commercial construction. "And once

*Registered Trademark of Aluminum Co. of America

†Up to two-story construction for schools, shopping plazas, offices, medical buildings, etc.

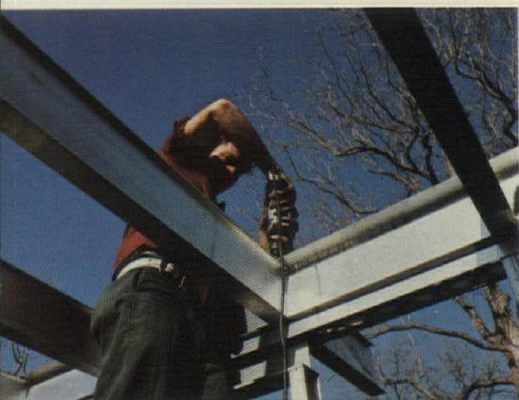

DEVELOPER
McDonnell Enterprises, Inc.
Gonzales, Texas

CONTRACTOR
Alumifab Texas Company
Grand Prairie, Texas

ARCHITECT-ENGINEER
Norman W. Douglas
Arlington, Texas

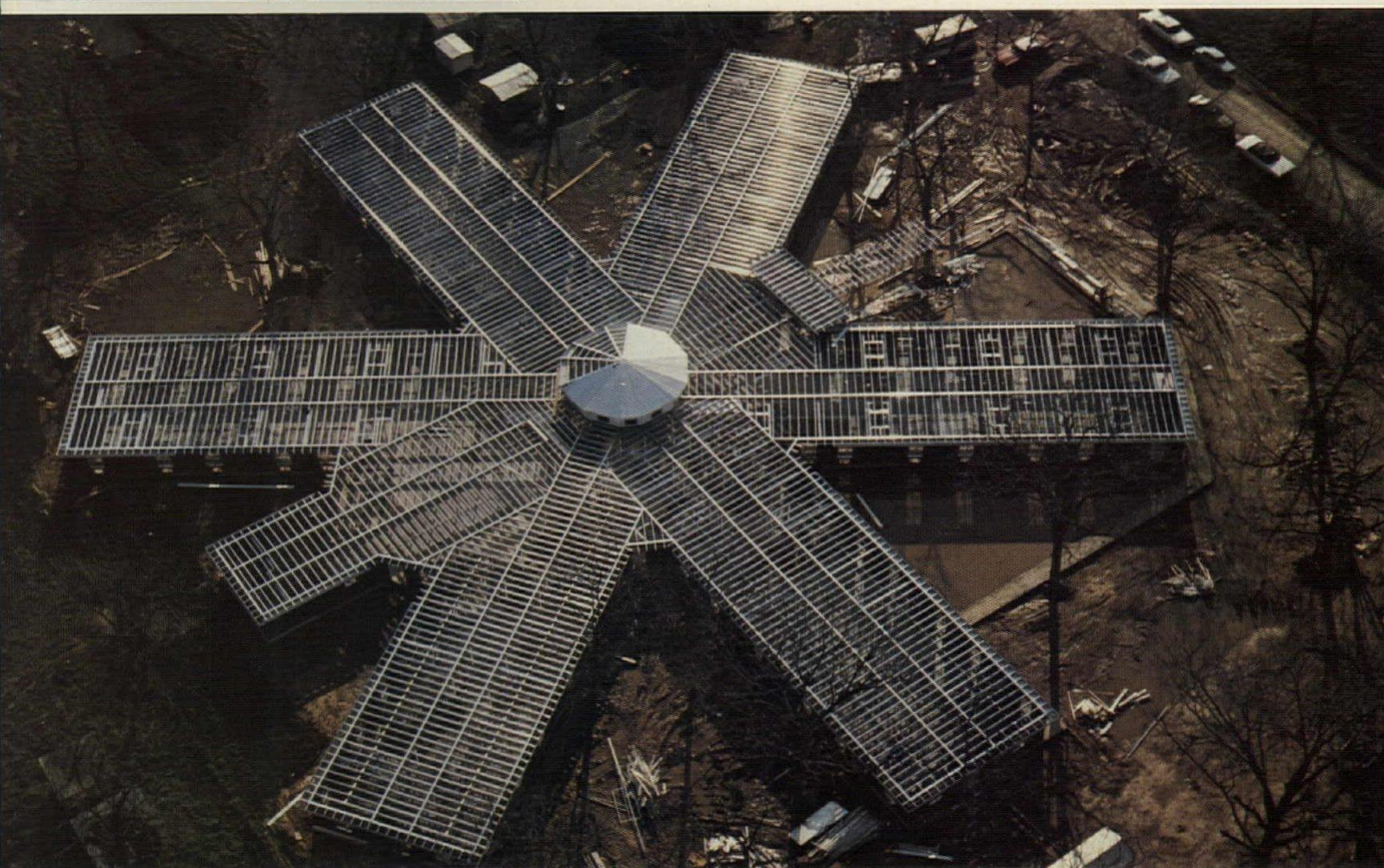

Alumiframe system? this nursing home.

we get lined out, we think work could go even faster."

Because this was the first Cartwheel Lodge nursing home using the Alumiframe system, it required a new code approval. The Alumiframe system meets requirements of the Uniform Building Code for a one-hour fire resistance rating and protected noncombustible construction.

"Because no sprinkler system is required by our codes for protected noncombustible construction," notes

Mr. Nunley, "our client realized a significant installation savings."

Six more Cartwheel Lodge Nursing Homes are planned, all using the Alumiframe system. "Another thing about construction speed," notes Nunley, "the faster each lodge is built, the less interest we pay on borrowed capital."

For more information on the Alumiframe building system, write Ken Lally, national sales manager, Aluminum Company of America, 1089-K Alcoa Building, Pittsburgh, Pa. 15219.

ALCOA
BUILDING
INDUSTRIES
DIVISION OF
 **ALCOA**

Living space...below grade

When you use treated wood foundations, specify Osmose
for complete building service

Wood foundations for residential and light construction is a proven technique for easier, faster all-weather installation. Of the hundreds installed to date, 90% have used Osmose pressure treated lumber and plywood. Most have taken advantage of the unique Osmose complete Building Service which includes

- Help in securing local code, mortgage and insurance approvals.
- A plans drawing service showing required materials and approved construction.
- Structural designs for crawl space or full basement wall treated wood foundations.
- Technical assistance to the manufacturer of the foundation wall panels.

- Audio-visual presentations to educate the builder and crews.
- On site consultation.

For more information on all weather wood foundations, consult with the people who pioneered them. We are totally involved from treating plant to finished construction. Write:



OSMOSE

980 ELLICOTT ST., BUFFALO, N. Y. 14209

SOUTHERN OFFICE, 1016 EVEREE INN RD., GRIFFIN, GA. 30223

*Member Society of American Wood Preservers, Inc.
For more data, write A16 on inquiry card*



On a volume (or surface-area) basis, the incidence of plastics in building will increase geometrically throughout the balance of this century. On a tonnage basis, Stanford Research Institute projects a per-year compound growth rate of 9.2 per cent—putting plastics in construction about 25.5 million metric tons in the year 2000.

That amount of plastics is the volume equivalent of 200 million metric tons of steel. It also is twice as much as all the plastics used this year for everything from telephones and appliances to furniture and a wide variety of bottles, cups, tubs, trays and other packages—not to mention building panels, flooring, pipe, insulation, bathtubs, etc.

But plastics are responsible for more than an endless stream of new materials and building products that challenge the imagination and creativity of architects and engineers. They have also pointed up a serious void in building design: the relative lack of fire safety considerations that reflect today's increasingly dense living and working environments.

Several disastrous fires involving plastics have been cited as heralding a new age of fire hazards in the built environment. Doubtless they also fueled an investigation by the Federal Trade Commission into alleged false advertising of plastics products used in building and furniture, especially urethane and polystyrene foams.

The FTC investigation culminated on May 30, 1973, in a proposed class action complaint that singled out 26 manufacturers of foamed and/or styrenic plastics, the Society of the Plastics Industry, and the American Society of Testing & Materials, which promulgates laboratory tests used to determine the relative flammability of plastics.

In its proposed complaint, FTC wants terms like "self-extinguishing" deleted from advertisements (even though accompanied by qualifying statements such as "according to ASTM D-635") and from ASTM test procedures, which were termed inadequate measures of real-life flammability; and it proposes that plastics manufacturers clearly warn users of potential fire hazards.

What piqued the plastics industry was that it had cooperated fully with FTC, and that FTC was aware of the industry's dissatisfaction with existing small-scale tests—and of several major research projects, launched previous to the FTC action to develop better flammability tests. Such research is now going on, often with financial support from SPI, at the National Bureau of Standards, Factory Mutual, Southwest Research Institute, the National Academy of Sciences, University of Utah, Lawrence Livermore Laboratory, University of California (Berkeley), and several other institutions. Plastics manufacturers are also hard at work,

developing new flame retardants, smoke suppressants, and inherently more flame-retardant polymers.

What's needed, according to the National Commission on Fire Prevention & Control, is a thorough-going total-system approach that recognizes and eliminates many of the hazards which have gradually become commonplace in modern buildings: central air conditioning systems that can circulate smoke and gases throughout a building . . . elevators with call systems that can bring them to the fire scene instead of bypassing it . . . concealed plenums that can allow a fire to spread, perhaps undetected, from one area to another . . . the frequent absence of adequate means of evacuation or refuge . . . the lack of regulations covering furnishings and other combustibles in buildings . . . and, most important, the scarcity of early-detection and suppression systems (automatic sprinklers, especially).

It is therefore over simplistic to look for a single cause for this country's fire losses—higher than any other "advanced" nation. And although plastics have become a convenient scapegoat, that overlooks two significant facts: (1) America's fire losses have declined from 14,000 deaths in 1966 to about 12,000 in the 1970's, during which time the use of plastics in construction and furnishings has more than doubled, and (2) in some European countries with fire safety records superior to the U. S., plastics in construction and furnishings are more prevalent than here.

Consequently, most fire experts agree with SPI: plastics are not an unsafe material intrinsically; rather, it is the manner in which they are used—in the absence of a total-system engineering approach to fire safety—that can be hazardous. How hazardous, relatively, no one can say for certain because, as noted by the head of the National Bureau of Standards, neither this nation nor any other knows enough about the process of combustion and the flammability of any material to design a laboratory test that accurately gauges the real-life fire hazard posed by that material, be it plastics or whatever. And there are doubts that the current round of research will provide the necessary data based to do so. There are some doubts, even, that it will ever be possible.

For the near term, then, it appears that engineering and design will play increasingly crucial roles in fire safety. SPI has endorsed a proposed building code that would require automatic sprinklering in all places of assembly—and even in private homes. Implementation of the code is not apt to happen before 1977, though, and it could be 1980 before sprinklers are mandated in individual dwellings. In the interim, it's hoped that such fire-safety measures will be voluntarily adopted by more architects and builders.

*Otis Port, Senior Associate Editor
Modern Plastics, New York, New York*

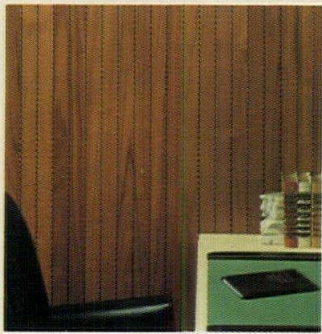

125

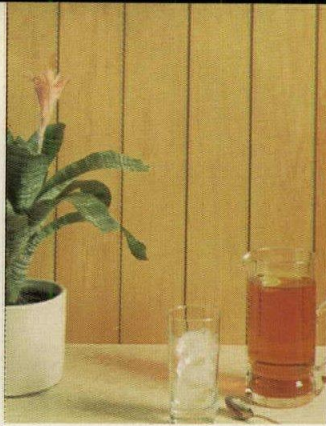

126



127

WOODWORK

125 TEAK PANELING / From the company's *Weldwood* collection, this teak paneling comes with planks separated 2 in. / U. S. Plywood. A, L*

126 HICKORY PANEL / From the company's *Weldwood* collection, the paneling features 4-in. on center planking. Even scoring complements the light close-grained veneer. / U. S. Plywood. A, L*

127 PREFINISHED PANELING / Part of the company's *Weldwood* collection, this light hickory paneling features regular 2-in. planks and slender 1/8-in. grooves. / U. S. Plywood. A, L*

128 HARDWOOD PANELING / Oak, Birch and Elm—each finished in a choice of two colors—are offered in paneling, 4 by 8 ft. The panels are prepared with a penetrating wax and seal. / E. L. Bruce Co., Inc.

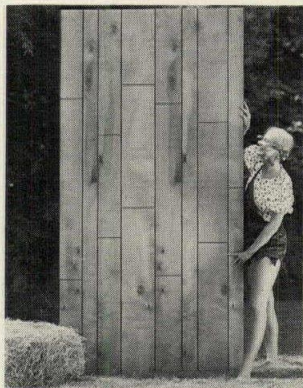

128

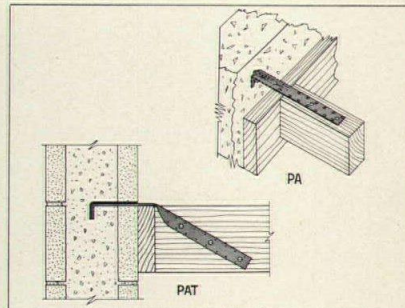

129

CONNECTORS & SUPPORTS

129 PURLIN ANCHORS / Designed for seismic load construction requirements as well as general tie use between wood and concrete, the galvanized steel anchors are offered in three lengths up to 29 in. They are adaptable for horizontal or vertical installation. / Simpson Timber Co.

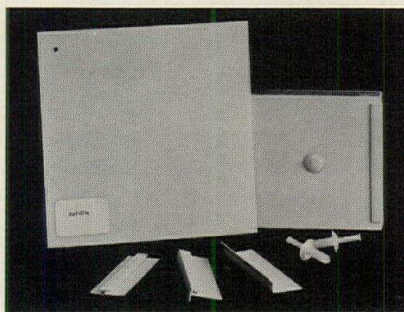

130

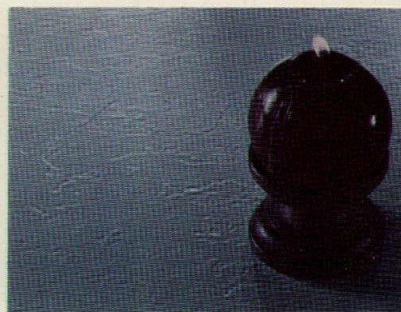

131

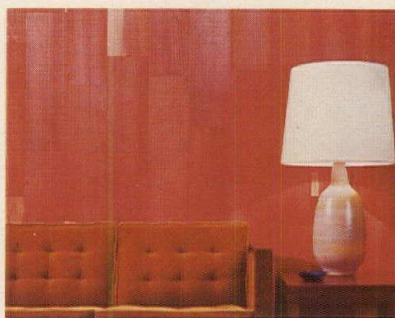

132

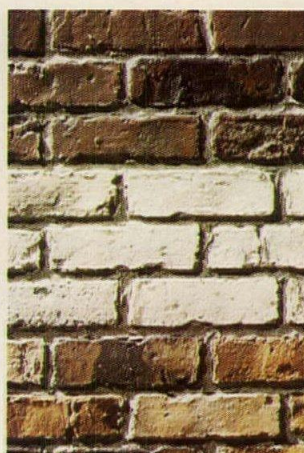

133

LAMINATED & PROCESSED SHEETS

130 FIBERGLASS PANEL / A flat fiberglass panel for window pane replacement, wall paneling and temporary enclosures will withstand impact, according to the company, and is USDA-approved. Product is offered in sheet form up to 5 ft wide with lengths up to 12 ft. / Kalwall Corp.

131 SLATE PATTERNS / The company has announced unique one-of-a-kind slate patterns that can be covered. Offered in white, black and gray in postforming grade as well as general purpose grade with deep sculptured finish. / General Electric Co.

LUMBER

132 FINGER-JOINED REDWOOD / All kiln-dried and clear grade, the lumber is available in sizes up to 24 ft and standard widths to 12 in. Finger joining is a method of end-gluing short lengths, producing a continuous board that is said to be exceptionally straight with high dimensional stability. / California Redwood Assoc. A, L, D*

PLASTIC FABRICATIONS

133 BRICK PANELS / Constructed of fiberglass reinforced polyester, the bricks are offered in three colors and three mortar colors are offered. / Marlite Div. of Masonite Corp.

134 SIMULATED MARBLE / A cast synthetic granite and marble made of plastic is offered in colors and claimed to be weatherproof. Panels may be applied to walls with adhesive or drilled and tapped with ordinary tools. / Lake Shore Markers, Inc. A*

135 CUSTOM PLASTICS / The company is offering an inexpensive custom molding service for architects

who want their own designs made for such items as planters, fountains, etc. The plastic used is usually polyethylene which can be colored easily and resists a variety of abuses. / United Molded Products Corp.

136 EXTRUDED MOLDINGS / Cellular vinyl, prefinished decorative moldings have been introduced in 11 standard shapes and in a choice of seven basic finishes. Product has nail holding ability. / Mastic Corp.

STRUCTURAL WOOD

137 LAMINATED BEAMS / Made of Lodgepole pine, the beams are said to be tight-knotted and take stains and finishes well. In tests, the company states the beams meet design loads anticipated. / Brooks-Scanlon, Inc.

STOCK MILLWORK

138 SPIRAL STAIR / A 6-ft diameter model in all-wood has been added to the company's line, which also includes 4-, 4½- and 5-ft diameter models. The larger size is said to provide at least 20 per cent more room on each tread. / Stair-Pak Products Co.

139 STAIR TREADS / A particle-board tread in a variety of lengths, widths and thicknesses is offered with front edges rounded / Willamette Industries, Inc.



134



135

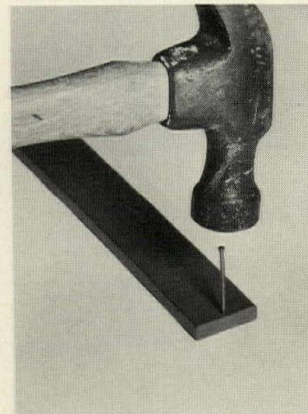

136

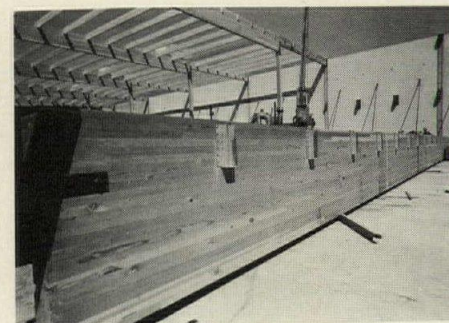

137



138



139



a) Grandstand, Indiana State Fairgrounds, Indianapolis, Ind. b) Kimberly-Clark Warehouse, Fullerton, Calif. c) Berths 80 & 82, Elizabeth-Port Authority Marine Terminal, in Elizabeth, N.J. d) Indoor pool, Kensington Club, Inc., South Bend, Ind. e) Delta Air Lines Hangar, Atlanta, Ga.

This is Alcoa Snug Rib roofing.
It's flat, tight and handsome.

Alcoa® Snug Rib roofing gives you all the advantages and savings of low-pitch construction plus excellent leak resistance. Since slopes as low as ¼ in. in 12 in. are possible, there's less dead space to heat or air condition. The patented Snug Seam® joint holds panel edges securely in place to create a weathertight seal, and there are no through fasteners to penetrate the weathering membrane. Since Snug Rib roofing is a "floating" system, it moves under thermal cycling, so locked-up thermal stresses are eliminated. Install-

tion is fast and easy, and savings continue over the life of the building because aluminum requires so little maintenance. On most buildings end laps can be eliminated because lengths are limited only by shipping conditions. Handsome Alcoa Snug Rib roofing is ideal for swim clubs, industrial and port buildings, warehouses, grandstands and aircraft hangars. For more information on economical Snug Rib roofing, write Aluminum Company of America, 1216 Alcoa Building, Pittsburgh, Pa. 15219.



Change for the better with Alcoa Aluminum



For more data, write A17 on inquiry card

thermal and moisture protection uci 7

There has been more innovative activity among the products of Division 7 than in almost any other UCI classification. Some well-organized R&D during the past few years has resulted in interesting new products and applications.

Built-up roofing has been subjected to re-examination by a number of manufacturers who were intent upon improving the system or at least counteracting some of the inherent weaknesses, such as:

Thermal movement cracking, drying out, etc., has apparently been overcome by a procedure which literally turns the roof inside-out. The membrane of this patented system lies beneath the water-, sun- and weather-resistant plastic foam insulation board. The felt and mastic is protected and the insulation's effectiveness is unchanged.

Cracking and delamination due to trapped vapor pressure, is reduced through use of a gravel coated base sheet. The material is applied dry, gravel face down and covered with the built-up roofing. Trapped vapor migrates between the granular particles until vented at the roofing perimeter.

Tearing and perforation which usually results from walking, dropping tools or dragging machinery along the roof, etc. can be avoided through use of a new puncture-resistant waterproof board with a non-skid topping, which is cemented to the finished roof to create inexpensive work platforms or walkways.

Fireproofing of structural steel has been very much simplified by the introduction of a felted mineral fiber board which meets code requirements for fireproofing materials. The board which is delivered to the job in required widths and thicknesses, is fastened to the steel with wire ties which are punched through the board and shot welded to the steel, all in one step.

Production line metal wall panels which include insulation exterior and interior finish surfaces are now available in colors, profiles and details which make them more acceptable for use on public, educational and commercial structures.

Space limitations curtail further comment on other products such as metal roofing systems, embossed fascias, precast building panels, skylight configurations, etc. which have been re-engineered or otherwise improved and are worthy of attention.

*Alex E. Goldfine, Consulting Editor,
Sweet's Guidelines, New York, New York*

Something **New** from Smith

DYNA SPAN ... a New Dimension in Metal Wall Panels

MASSIVE PROFILE

Bold profile casts strong shadows . . . gives an aesthetic appearance to massive buildings.

SPANS LONGER DISTANCES

DYNA SPAN is super strong . . . spans greater distances between structural supports.

SAVES STRUCTURAL GIRT COSTS

Long span strength reduces number of girts required . . . saves on structural material costs.

SAVES ON ERECTION COSTS

Reducing number of structural girts reduces erection costs.

HOW IT COMPARES . . .

Compare DYNA SPAN with industry-standard V-Beam. Based on 22 gauge galvanized steel at 20 psf loading, DYNA SPAN will span 20'9" in a single span. V-BEAM, same gauge and wind loading, will only span 12'0".

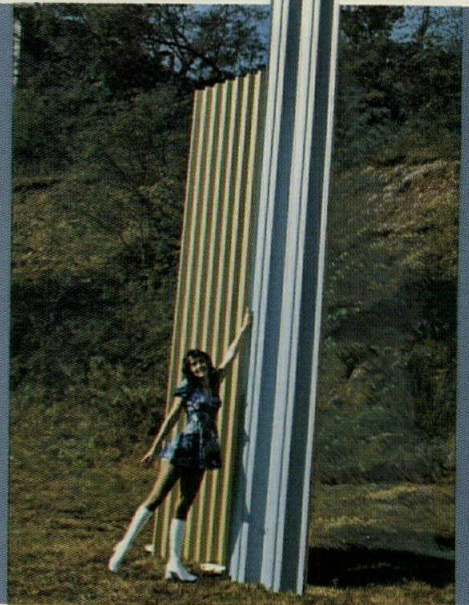
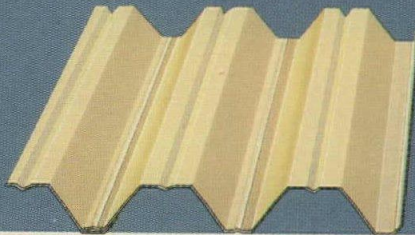

VARISPAN PANEL SYSTEM... for longer spans, greater strength

SPAN COLUMN TO COLUMN

VARISPAN can be installed horizontally on columns to eliminate unsightly structural girts.

PROFILE SELECTION

Choose from 23 exterior profiles.

THERMAL VALUE

Choice of insulation thicknesses from 1½" to 7½".

SAVE MONEY

Installed vertically or horizontally . . . the super strength spanning qualities of VARISPAN save structural steel material and erection costs.

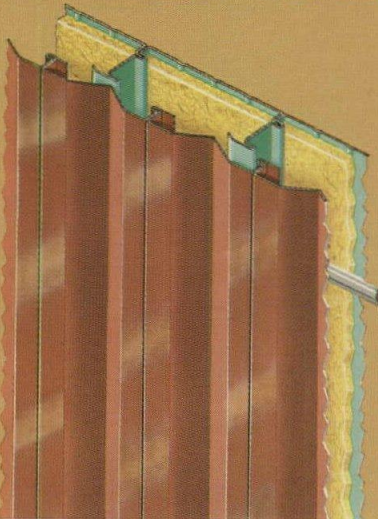

SMITH VARISPAN Panel System provides a new dimension in super strength, longer spanning ability and versatility. Variable depths are available, permitting single spans in excess of 30'0". Various insulation thicknesses, as shown below are available. Write for full details.

4 VARISPAN Panels for wide selection of spanning distance

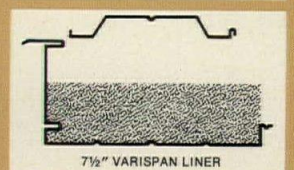
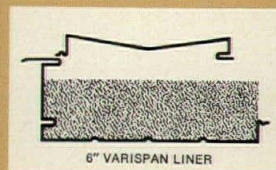
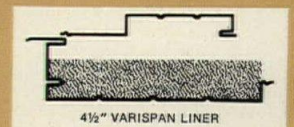
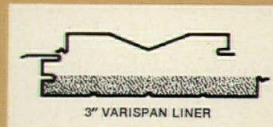

LOUVERS ... a Complete Line for Commercial and Industrial Applications

THE RIGHT LOUVER TO SUIT YOUR NEEDS

Fixed Louvers, Operating Louvers, Mechanical Equipment Enclosures, Sun Control . . . vertical or horizontal . . . standard units custom-fitted to your application.

STURDY, LONG-LASTING CONSTRUCTION

Extruded from aluminum alloy, SMITH Louvers are designed to withstand wind and weather buffeting. Heavy-duty frames hold the blades firmly. Available with bird and insect screens.

MODERN STYLING IS COMPATIBLE

SMITH Louvers are designed for installation into wood, masonry or metal. A wide range of architectural colors and finishes offers harmony or pleasing contrast.

FUNCTIONAL PERFORMANCE

Controlled ventilation, protection against the elements, privacy, aesthetics . . . SMITH Louvers add to the efficiency and beauty of any commercial, institutional or industrial building.



ELWIN G. SMITH DIVISION

100 WALLS STREET, PITTSBURGH, PENNSYLVANIA 15202

EGS 111

For more data, write A18 on inquiry card

CLADDING/SIDING

150 PRESTAINED SIDING / *Cape Cod Red* is one of 26 colors available in the company's prestained textured siding. Shown on *RoughTex* flat panels, the opaque acrylic latex stain is said to achieve exceptional color stability. Prestained battens are also available. / U. S. Plywood. A, L*

151 SHAKE PANELS / An assortment of Western Redwood Cedar shingles is offered in 46¾-in. long panels designed for interior application. The shingles are bonded to ¼-in. insulation board and are self-aligning with a 7¾-in. exposure. The panels can be installed to a nailable surface. / Shakertown Corp.

152 MINERAL FIBER SIDING / *Qasal* is a flat integrally-colored white panel composed of incombustible mineral fibers and cement, according to the company. The structural facing is produced in two finishes—a smooth, veined surface and a lightly textured finish achieved by shotblasting. Available in sizes up to 64¾ by 126 in., the product is guaranteed for building's life. / U. S. Plywood. A*

153 PEBBLE SIDING / Featuring pebbles bonded to plywood panels, the product is offered in sizes up to 4 by 12 ft, with custom sizes up to 60 in wide and 16 ft long. The product is offered in a choice of six color-texture combinations, and specialty panels include tongue and groove and textured two sides, among others. / Sel-Ply Products.

COMPOSITE PANELS

154 WALL SYSTEM / Comprised of light gauge steel framing, paper-backed metal lath and ½-in. modified portland cement plaster, the panels are poured and rodded on the horizontal and are said to be 25 per cent lighter than 4-in. precast units. They meet positive and negative wind load and fire ratings required. / Finestone Corp.

FLASHING

155 FLEXIBLE FLASHING / This product is two 25-mill layers of plasticized polymeric vinyl fused together through woven glass fiber reinforcement. It is said to be dimensionally stable, weather-resistant and com-

patible with asphalt. It is compounded to withstand sun, water, ozone, and fungus damage. / Lexsuco Inc. A, I*

156 ALUMINUM FASCIA / This extruded fascia system for use with galvanized water dams is designed to withstand high winds, hide building irregularities and maintain alignment while allowing freedom of movement between trim and roofing components. / Silbrico Corp.

INSULATION

157 URETHANE SPRAY SYSTEMS / Recommended for metal, wood, brick or other masonry, this cellular foamed plastic combines light weight and strength with thermal insulation, according to the company. Helps reject heat-conducting moisture. / Owens-Corning Fiberglas Corp.

158 INSULATION FASTENER / This system mechanically fastens insulation to steel deck and uses self drilling screws and stress distribution plates. Smooth edge design of plates is said to hold insulation to deck without damage to board or roofing felts. / Grefco, Inc. A, I*

159 URETHANE INSULATION / Tapered *Lexfoam* rigid roof insulation is molded 2 by 4-ft board with a taper of ⅛ in. to the foot. Machine bonded asphalt asbestos skins. The product provides a slope for positive drainage on flat deck and is said to provide high insulation value. / Lexsuco, Inc. A, I*

MEMBRANE ROOFING

160 ELASTOMERIC ROOFING / The chief component of *Trocral* loosely laid roofing is a flexible, rugged elastomeric plastic in sheet form that is welded into a free-floating skin secured at the roof edges and penetrations. Can be used with all forms of roofs and roof decks. No expansion joints are necessary, according to the company. / Dynamit Nobel of America, Inc.

161 ELASTOMERIC ROOFING / A single component, cold-applied elastomeric roofing material is said to be comparable in cost to built-up roofing and is designed as a non-polluting, seamless system. The light-colored material is fireproof and easily repaired if cut. / Contech Inc. A*

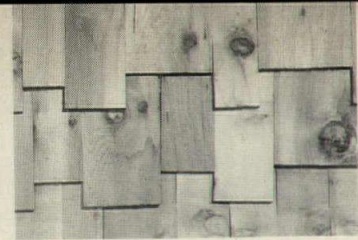

151

150



152

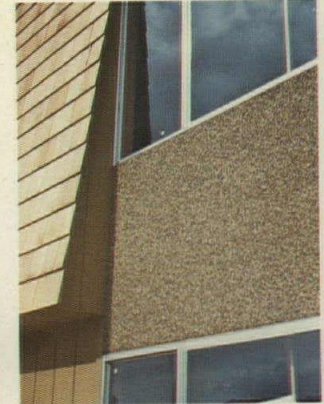

153



154



155

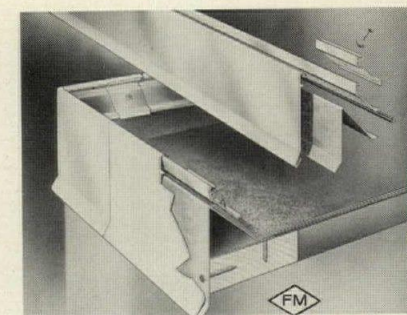

156



157



158



159



160



161



162



163



164

METAL ROOFING

162 STAINLESS SHEET METAL / A copper-clad stainless steel is said to combine the look of copper with the strength of stainless steel at a price less than copper. *Ti-Guard* is available with a stucco embossed or lead-coated finish. / Texas Instruments Inc. A*

163 PREFORMED PANELS / Panels of a zinc titanium alloy are available in six shapes: standing seam, chevron, rib, step rib, paneline and mansard. They come up to 38 ft long. / Matthiessen & Hegeler Co. A*

164 COPPER FLASHING / A high-strength, light-gauge copper sheet is now being made for a broad range of flashing, fascia and roofing applications. *Tough 12* is the name of the product, said to be cost competitive with stainless steel and other flashing. / Copper Development Assoc., Inc.

165 COPPER FLASHING / A high-strength, light-gauge copper sheet is now being offered for a broad range of flashing, fascia and roofing applications. *Tough 12* is said to be cost competitive with stainless steel and available in standard sizes. / Copper Development Assn. Inc.



165

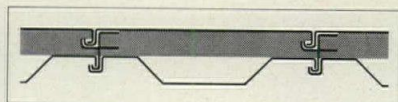

166



167



168

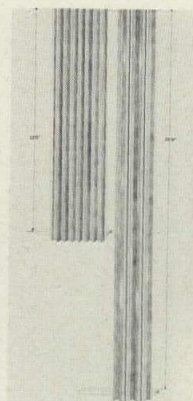

169

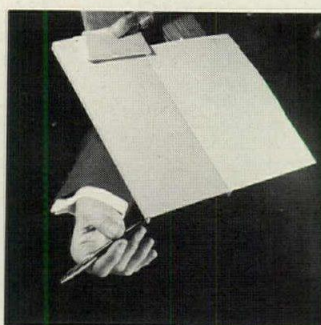

170



171

PREFORMED PANELS

166 INSULATED METAL WALL / The product is said to produce a finished wall 2½ in. thick and will double span 16 ft. A variety of face panel designs are available, 12 in. wide with standing seam interlocks for shedding water. / The Binkley Co.

167 PATIO ROOF PANELS / Striped translucent panels are offered in two patterns: one with bands of yellow and orange on white, the other, parrot green and blue on white. The company claims the product is offered at cost comparable to ordinary fiberglass sheeting. / Vistron Corp.

168 STEEL PANELS / Baked-on mill applied finish over galvanized steel in a variety of colors is featured with this product. No sheathing is required and panels are applied on nailing strips. Factory-formed flashing is said to simplify finishing and panels are furnished to specifications. / Childers Mfg. Co. A*

169 METAL SIDING, ROOFING / *Dyna Span* can be erected as an insulated panel system or an uninsulated exterior sheet, according to the company. / Elwin G. Smith Div., Cyclops Corp. A*

170 PORCELAIN-ON-STEEL / The company has announced a panel that can be formed at angles up to 90 degrees with the porcelain already on, without spalling, chipping or crazing. The flanged panels can be butted. / AllianceWall Corp. A*



172

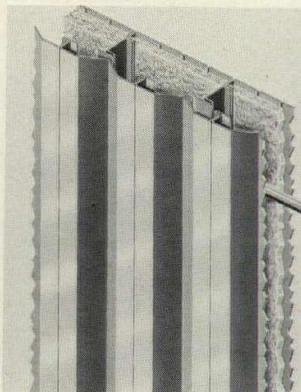

173



174

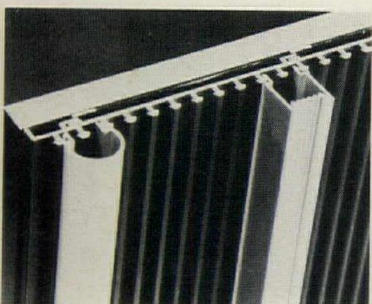

175

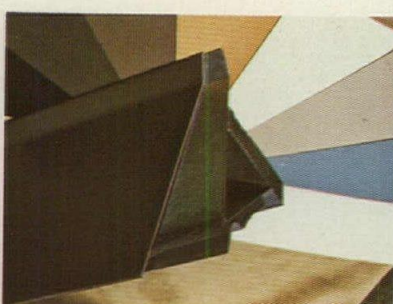

176



177

171 EXTRUDED WALL / The system is designed for facing or refacing low and mid-rise buildings and comes with a textured surface, in painted or duranodic finishes. The panel is said to expand or contract to meet field tolerances. / Aluminum Co. of America. A*

172 INDUSTRIAL ROOFING / Made up of steel-framed, seamless particle board panels, the system uses tapered steel girders for support. Panels are made using a fabricated steel "C" channel frame covered with structural particle board produced in sheets 8 ft wide and up to 30 ft long. / Kaiser Steel Corp.

173 METAL WALLS / Available in a choice of three depths of liner panel—up to 6 in.—*Varispan* panels can cover a single span of over 30 ft. Concealed fastening is featured. Panels may be installed horizontally or vertically in an insulated wall system. All metals can be plain or embossed. / Elwin G. Smith Div., Cyclops Corp. A*

ROOFING SPECIALTIES

174 ROOF SURFACING / Meeting OSHA standards, the roof spray process is said to provide a uniform impenetrable roof coating. / Randustrial Corp.

175 PROFILE FASCIA / A custom front with a choice of five fascia accents features fascia strips that snap into the holding member. The strips may be spaced as close as 1/2 in. or as far apart as desired, in any combination. Strips are offered in corrosion-resistant bronze or black colors. / Amar-lite/Anaconda.

176 GRAVEL STOP / The product is identical to the patented *Safeguard* gravel stop, except that the fascia is formed rather than extruded. The product offers a galvanized water dam, thermally compatible with roofing felts, according to the company. / W. P. Hickman Co. A, I*

177 FASCIA SYSTEM / The *Verti-Panel* system of extruded aluminum offers a choice of panels, painted colors and anodized finishes, according to the company. Vertical fascia, mansard roof, spandrel panels and wall facings can be achieved with the products. / E. L. Burns Co., Inc.

178 PIPE ROLLER SUPPORT / Engineered to allow movement in roof-mounted piping without transferring expansion forces to the roof membrane, the product is said to eliminate roof leak problems caused by make-shift supports. / The Pate Co. A*

179 POST-TENSIONED CABLE / For cable-roof structures, this post-tensioned tendon uses 1/2 in., 270 psi post-tensioning strand in place of the more traditional galvanized cable, ac-

ording to the company. Tendons are composed of 1/2-in. strands greased and coated with a tight plastic jacket and bundled. / Stresstek Copr.

180 ENTRANCE CANOPIES / In anodized extruded aluminum, completely prefabricated canopies offer a flat soffit and rectangular fascia. Installation is by bolting two bolts to the canopy and four to the wall. / E. L. Burns Co., Inc.

181 ROLL ROOFING / Consisting of a laminate of aluminum foil and asphalt roofing felt with acrylic finish, *Reynolok* is installed quickly with an interlocking lap between each course, according to the company. The foil provides reflective insulation. / Reynolds Metals Co.

182 PIPE CURB ASSEMBLY / The 18 gauge galvanized steel curb, unitized with integral base plate, features an acrylic-clad ABS plastic cover, graduated step neoprene boots with stainless steel clamps. Unit accommodates up to 4 pipes. / The Pate Co. A*

183 MANSARD FRAMING / A system for fast framing of mansard and fascia panels involves factory-fabricated galvanized structural steel members and connectors assembled on the site with self-tapping sheet metal screws. / Cheney Flashing Co. A*

184 PATCHING COMPOUND / The product is fibered and, according to the maker, eliminates the need for a reinforcing membrane. It can be used in cold temperatures and on wet surfaces. Recommended for gutters, etc. / The Gibson-Homans Co.

SEALANTS

185 PRIMERLESS SEALANT / This is a line of one-part, primerless, low-modulus silicone construction sealants for sealing building joints. It can bond to concrete, masonry, metal-coated surfaces and wood. A glazing sealant is also offered for glazing glass, plastic and metal. / General Electric Co.

186 SILICONE SEALANT / A one-part low-modulus sealant to withstand extreme building joint movement is said to be permanently flexible and non-deteriorating for 20 years or more. / Dow Corning Corp. A, I*

187 ACOUSTICAL SEALANT / Product is said to help maintain sound transmission values of rated drywall systems in building construction. Flexible, non-staining and non-corrosive. / DAP Inc. A*

188 ACRYLIC CAULK / A 65 per cent solids acrylic emulsion for formulation of high-solids latex caulks is said to provide low shrinkage and good wet and dry adhesion to a wide variety of substrates. / Rohm and Haas Co.

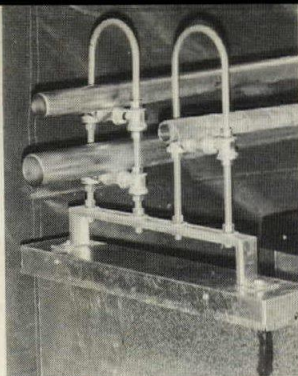

178

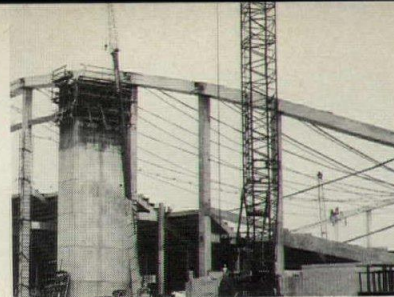

179

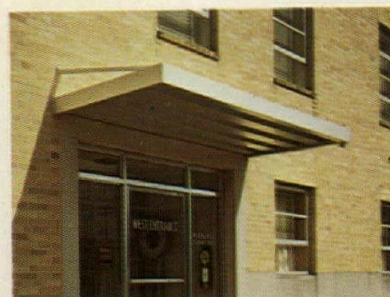

180



181

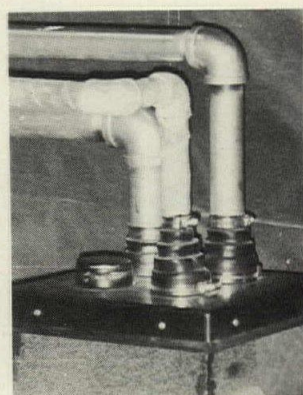

182



183



184



185



186



187



188



189



190

SHINGLES & ROOFING TILES

189 ROOF TILE / These tiles can be applied directly to roof trusses without the need of sheathing or felt underlay, according to the company. The interlocking steel based tiles form a permanent weather-resistant bond and support weight. Two colors are offered. / Automated Building Components, Inc.

190 FIBERGLASS SHINGLES / In this line is a center-cut edge shingle with large ceramic granules. Complete double coverage and self-aligning tabs are said to make for easy application. Available in five colors, with a Class A rating. / Johns-Manville.

191 SHINGLE / According to the company, this shingle offers random edge no-cut design to ensure a double thickness over an entire roof. Five colors, including white are offered. The shingle carries the UL Class C wind resistance label. / Atlas Roofing.

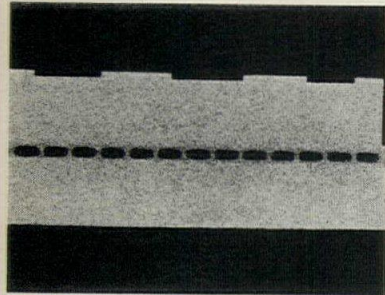

191



192

VAPOR BARRIERS

192 EMBOSSED BARRIER / This vapor barrier is designed to enhance the interior of metal building systems. It is a laminate of rigid vinyl film, a proprietary scrim and aluminum foil that can be bonded to fiberglass insulation blankets. *Ultralam* is said to offer excellent water vapor resistance. / Stauffer Chemical Co.

WATERPROOFING

193 CONCRETE WATERPROOFING / A liquid-applied polymer offers decorative, abrasion- and chemical-resistant waterproofing for traffic-bearing single slab concrete construction. Product can also be used on exterior plywood and other masonry substrates. / The Tremco Mfg. Co. A*

194 WATERPROOFING / A heavy-duty *Bituthene* self-adhesive membrane for bridge decks and highways is applied under the traffic course to prevent water penetration damage to steel or concrete substructure. Membrane

combines plastic mesh with layers of adhesive-consistency rubberized asphalt and bituminous compound. / W. R. Grace & Co. A*

195 WATERPROOF MEMBRANE / Completely free of coal-tar, the product is an elastomeric waterproofing that is liquid-applied and said to offer elongation to a maximum of 800-1000 per cent. / Carboline Co. A*

196 SILICONE RESINS / Introduction of silicones into the company's *Monoseal* is said to produce a complete moisture barrier without altering the appearance of masonry walls. For above-grade applications. / Monroe Co., Inc.

197 ACRYLIC COATING / This emulsion-type polymerized acrylic waterproofing is said to offer color retention and excellent adhesion. Will cover in one coat. / Warth Paint Co.

198 COLOR WATERPROOFING / Available in 22 architectural colors, the all-weather resistant textured decorative waterproof coating is for use on more exterior above-grade masonry surfaces. It may also be used to provide a textured sand float effect to painted or unpainted concrete, stucco, block and brick surfaces. / Contech Inc. A, I*

199 SILICONE TREATMENT / For concrete and masonry walls, *Thoro-clear 777* is said to protect against water and other harmful environmental factors. / Standard Dry Wall Products, Inc. A*

200 ADJUSTABLE PEDESTAL / This all-plastic product for elevated pedestrian paver surfaces permits architects to specify a wide range of paver materials which can be demountable. Offers uniform joints and drainage. / The Tremco Mfg. Co. A*

201 WATERPROOFING POLYMER / A one-part, asphalt-modified product for two-course concrete construction offers cold application and cures to a flexible, seamless blanket, according to the company. Designed for heavy-duty floors. / The Tremco Mfg. Co. A*



193



194



197



196

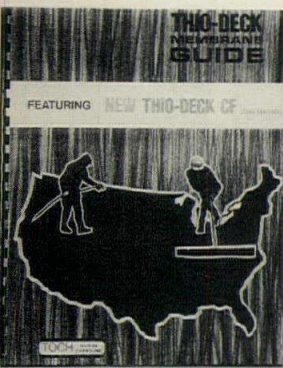

195



198



199

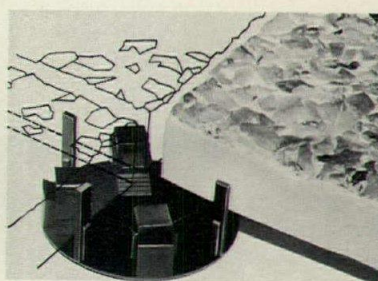

200



201

FROM 40 FEET BELOW GRADE TO 40 STORIES ABOVE, TREMCO KEEPS BALTIMORE'S NEW U.S.F.&G. BUILDING DRY.

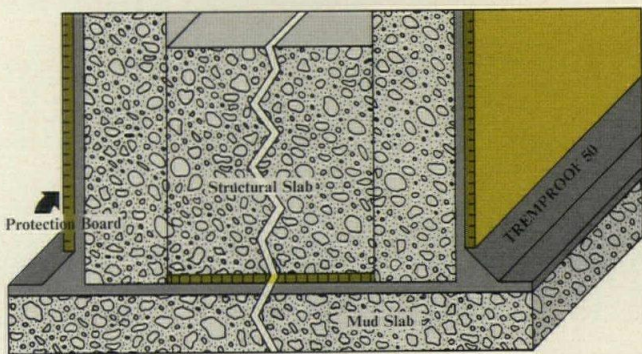
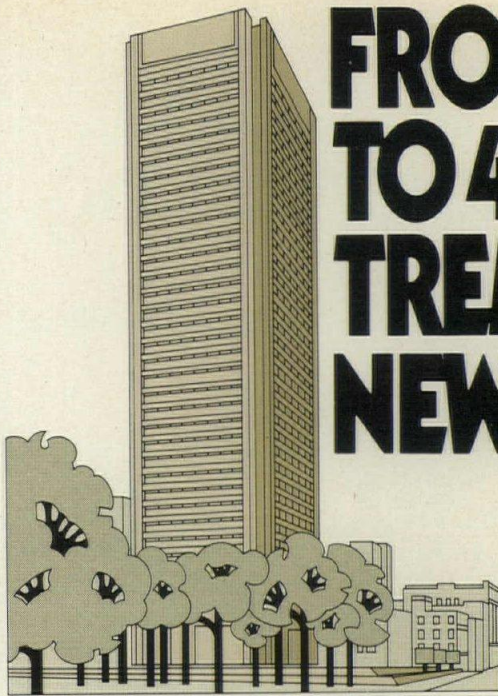

An entire city block was wrapped in a seamless blanket to keep out the saline water of the Chesapeake Bay. A 6-inch concrete working slab and 12-inch foundation walls sealed with a monolithic membrane of Tremproof 50 liquid polymer did the job. The result — no leakage problems whatsoever.

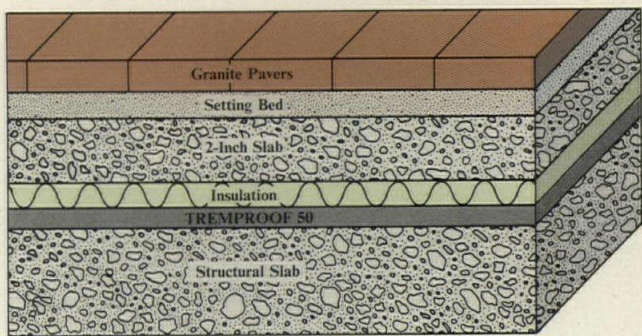

Dry plaza decks used granite pavers and Tremproof 50. There was no compromise between aesthetics and efficiency.

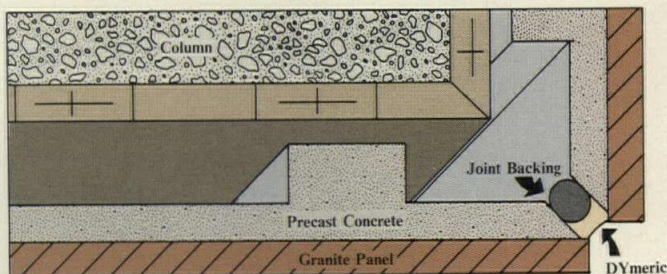

180,000 linear feet of precast concrete panel were caulked with Tremco polymer sealant DYmeric.

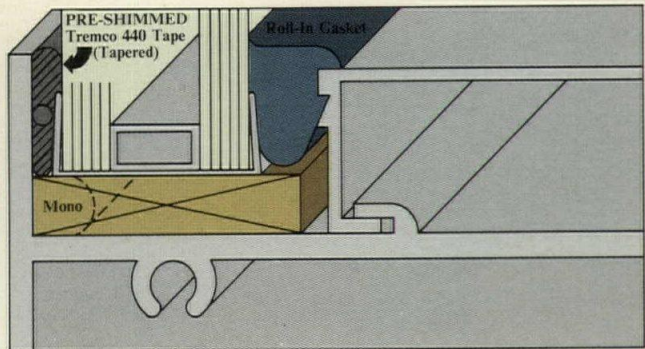

Ten miles of window glazing were done by the Tremco system. Not even the high winds off the harbor will prevent them from being watertight.

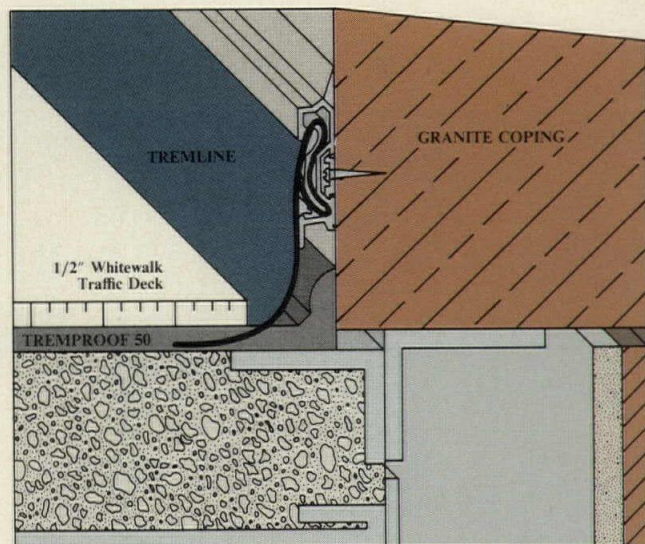

Parapet walls were no problem for the Tremline flashing system. The rest of the roof was made watertight with Tremproof 50 liquid polymer.

A complete system, one source. We solved every waterproofing problem of the United States Fidelity & Guaranty Building. We've been handling jobs like this for over 45 years. That's why we say we're first in making buildings last.

Call your Tremco rep and see firsthand what we can do for you. Tremco, Cleveland, Ohio 44104. Toronto, Ontario M4H 1G7.

TREMCO®

YOURS FOR THE ASKING . . . NEW 1974 FASCIA SYSTEMS CATALOG

GET THE FACTS ON:

- A NEW COPING SYSTEM THAT SNAPS ON—NO EXPOSED FASTENING
- A NEW REGLET SYSTEM THAT'S SO SIMPLE IT'S STARTLING
- A NEW EXTRUDED PANEL SYSTEM—SIMPLY SNAPS TOGETHER
- THE INDUSTRY'S MOST COMPLETE LINE OF FACINGS AND ARCHITECTURAL FINISHINGS

Twenty pages packed with ideas from the designers of the Fascia System with the exclusive LOK-TITE Flashing. Reserve your copy . . . call or write us today.



MISCELLANEOUS MANUFACTURING CORPORATION
4520 Elmdale Drive
Tucker, Georgia 30084
PHONE: 404 / 938-7570

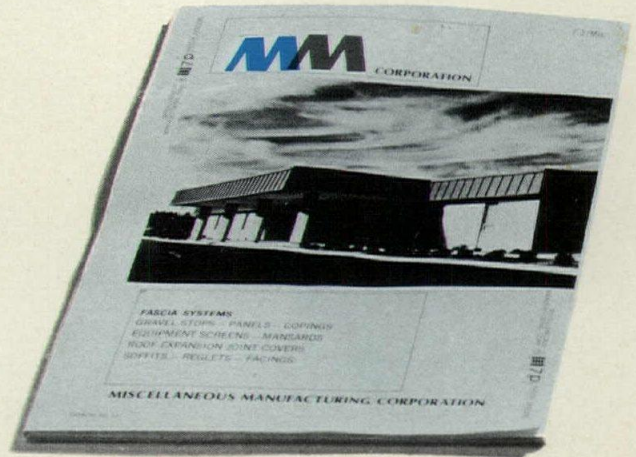

For more data, write A20 on inquiry card

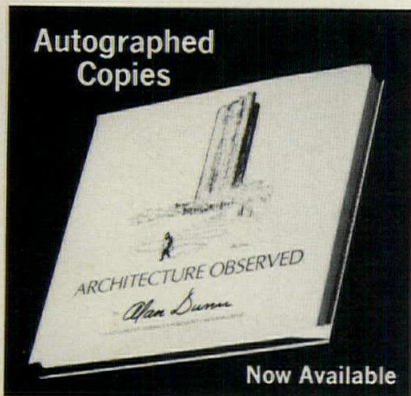

Alan Dunn's ARCHITECTURE OBSERVED

Now Available

Recently Architectural Record published—in hardcover book form—a collection of 139 of Alan Dunn's best cartoons which appeared in the RECORD over the years. The warm reception of this book by architects and others has prompted us to plan a second printing.

In the meantime, Alan Dunn has graciously consented to autograph a limited number of available copies which are being offered at this time on a first-come, first-served basis. The price of these personally autographed copies is \$10 each.

In addition to the autographed copies, unsigned copies are also available at \$6.95 each. These also make excellent gifts for your business associates and friends.

To order your copies, use the coupon below.

Architectural Record Books, 1221 Avenue of the Americas, New York, New York 10020

Please send:

_____ autographed copies of Architecture Observed @ \$10.00 each \$ _____
_____ unsigned copies of Architecture Observed @ \$6.95 each \$ _____
Total \$ _____

Name _____

Address _____

Zip _____

Please enclose payment or your purchase order.

FOR ANYONE WITH A ROLE IN CAMPUS PLANNING AND DESIGN

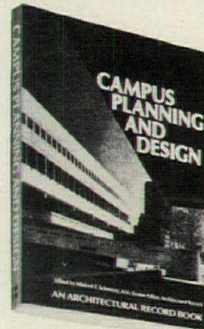

CAMPUS PLANNING AND DESIGN

Edited by Mildred Schmertz, AIA
Senior Editor
Architectural Record

SIX SECTIONS:

- Designing the Single Building
- Designing the Library for the Campus
- The Single Building or Complex Designed as Part of the Campus Master Plan
- Architecture Which Gives the Campus the Unity of a Single Building
- Campus Performing Arts Centers
- Designing Campus Interiors

This 266-page volume brings you practical data and creative ideas on handling such campus architecture problems as: designing well-scaled open space; dealing with existing architectural atmosphere; creating flexible prototypes for specialized buildings; planning expandable systems for an entire campus; organizing functional and aesthetic elements in relation to site and surroundings; integrating the building with interior space design, solving problems of architectural scale posed by the surrounding campus.

ARCHITECTURAL RECORD

1221 Avenue of the Americas, New York, N.Y. 10020

Please send me copies of Campus Planning and Design @ \$22.50 each, plus postage and handling. (Include payment and we'll pay the postage and handling.)

Name _____

Street _____

City _____ State _____ Zip _____

2 new Sanspray sidings.



The best part about this one is what you can't see.

Our Shadowline™ stone-on-plywood Sanspray® siding has a vertical groove pattern so there's no need for battens or mouldings. The shiplapped edges give a smooth fit and appearance which means you could nail up a wall a mile long and virtually never see a joint.

The distinctive look of Shadowline can give a vertical relief to a long horizontal wall. It incorporates a regular stone aggregate with $\frac{3}{8}$ " wide, $\frac{1}{4}$ " deep grooves every 8 inches. And because the look is special, tones are special — 7 of them — ranging from cool white to warm tangerine to a glisteny black. Sizes in 4' x 8', 9' and 10'.

The best part about this one is what you can't miss.

If you're looking for a chunky, rugged look, there's our new Jumbo aggregate Sanspray. We use oversize chips of stone for this texture. It gives you the look of pre-cast concrete without the weight — or the cost. And anything this natural deserves natural colors. Like Gaelic Green, Northern White and Tangerine. Sizes up to 5' x 12' are standard. Special sizes on order.

Besides Shadowline and Jumbo, we also have large- and regular-aggregate Sanspray siding.

Find out more about our extensive line of exterior cladding at your local U.S. Plywood Branch Office. Especially Sanspray — a face of stone, but a heart of wood.

EXTERIOR
CLADDING BY
U.S. Plywood
777 Third Avenue, New York, N.Y. 10017

 **U.S. Plywood** Division of Champion International

For more data, write A21 on inquiry card

**Introducing
the ultimate sealant.**



One part. Low modulus. Silicone. Dow Corning® 790 building sealant.



Now there's a building sealant with unprecedented advantages for both architect and contractor: Dow Corning 790 building sealant.

One part, so it's easy to apply, with no chance of mixing errors.

Low modulus, so there is little chance of joint failure because of sealant splitting or loss of adhesion.

Silicone, so it has superior resistance to aging and weathering.

For 20 years or more.

Joints can expand or contract 50 percent again and again, and the sealant remains intact. And Dow Corning 790 building sealant will recover, at a controlled rate, from either type of stress.

Apply it in any temperature because this sealant has the same consistency from -20 F to +160 F. No primer is needed on concrete, brick, aluminum, ceramic, and marble; and you can use it as either a new or remedial sealant.

Whether you're designing the ultimate building or sealing the ultimate building, you can seal it and forget it with Dow Corning 790 building sealant. For complete technical data on the ultimate sealant, ask for Bulletin 61-207. Write Dow Corning Corp., Dept. D-3315, Midland, Michigan 48640. Or call 517 636-8000.

Construction sealants from

DOW CORNING

DOW CORNING

For more data, write A22 on inquiry card

TITANALLOY® "A" IS UP TO SOMETHING NEW

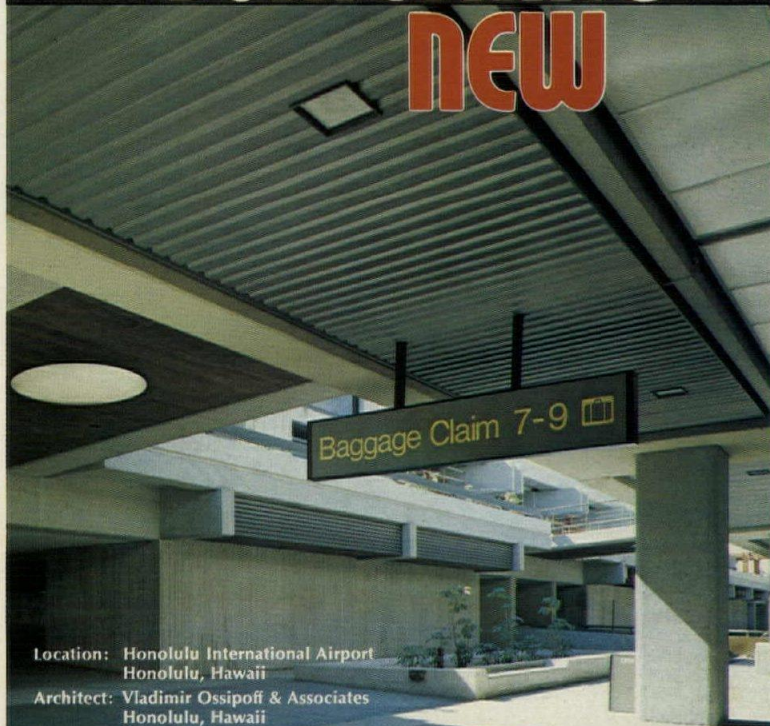

Location: Honolulu International Airport
Honolulu, Hawaii
Architect: Vladimir Ossipoff & Associates
Honolulu, Hawaii

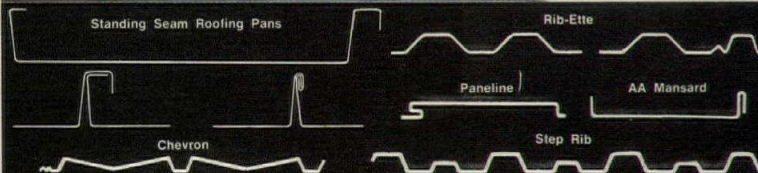

Preformed panels of TITANALLOY "A" now available in six distinctive conformations:

New applications, new designs, new installation procedures, and now new preformed panels that substantially reduce construction costs . . . all warrant your further investigation.

Here, decorative, yet highly functional soffits of preformed TITANALLOY "A" are used at the new Honolulu International Airport. Perforation adds design and texture to the preformed panels while helping to dampen noise.

New installation procedures are fully explained in our new 8 page color brochure. See it in Sweet's Light and Heavy Construction file, 7.2/mat, or write us for your personal copy. We'll send you up to date details on using TITANALLOY "A", truly the most versatile architectural metal in America.

In addition to six new preformed panel designs described above, TITANALLOY "A" is supplied in continuous coils up to 36" in width, for soffits, fascia, trim, or complete roof systems. May we send you samples, case histories, and the names of M&H distributors nearest you? Matthiessen & Hegeler Zinc Company, La Salle, Illinois 61301; New York Office, 233 Broadway, Rm 4015, Phone 815/223-8600, or 212/267-6542.



TITANALLOY "A"
THE ARCHITECT'S METAL

For more data, write A23 on inquiry card

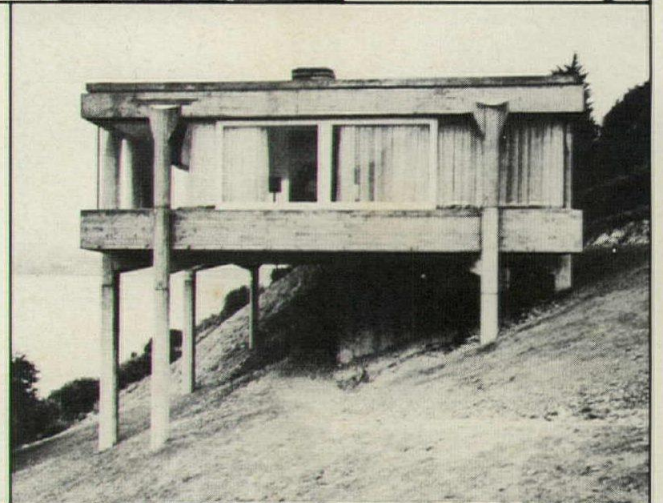
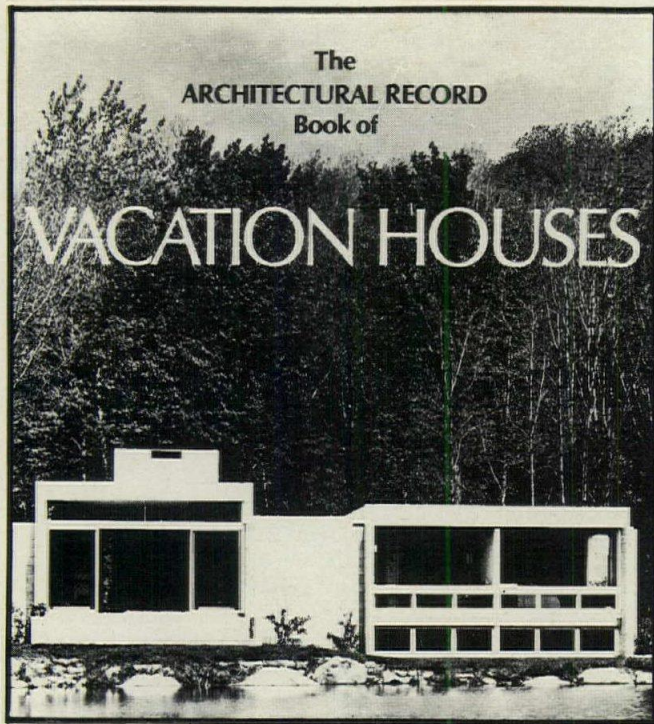

Exciting ideas from 60 different dream hideaways

A sparkling collection of architect-designed vacation houses for all climates and terrains—from a mountain-top chalet in British Columbia to a beach house in Florida. Selected by Architectural Record editors, these houses range in price from less than \$5,000 for a very small two-room cottage to more than \$100,000 for large structures. Each house is fully described with floor plans, site plans, photographs and construction details. For easy reference the book is divided into five sections: beach, mountain, lakeside, resort and country, weekend and summer homes.

256 pages 9 x 12 \$9.95

SEND FOR YOUR COPY TODAY

ARCHITECTURAL RECORD

1221 Avenue of the Americas
New York, New York 10020



Please send me _____ copies of Architectural Record Book of Vacation Houses @ \$9.95 each.

(Include payment and we'll pay postage.)

Name _____

Address _____

City _____

State _____ Zip _____

PR-74

The Student Union at St. Scholastica College, Duluth, Minnesota, provides an education on what keeps insulating glass insulating. All 475 windows in the building were sealed with an LP® polysulfide base compound nearly 10 years ago. No problems ever since.

The Holiday Inn at Ann Arbor, Michigan, is an even older polysulfide application. Its hundreds of large window units have proven our polymer's excellent adhesion, flexibility and resistance to moisture vapor transmis-

How to set insulating glass longevity records.

sion for over a decade of summer sun and winter cold. No problems here, either.

LP polysulfide polymers are just a few of the many products made by our Chemical Division. For aircraft, automobiles, buses, trucks and trains. For joint and window sealants, and insulating glass. For seals, gaskets, printing rollers, hose and industrial tires.

Would you like more information? Write Thiokol Chemical Corporation, Chemical Division, Trenton, N.J. 08607.

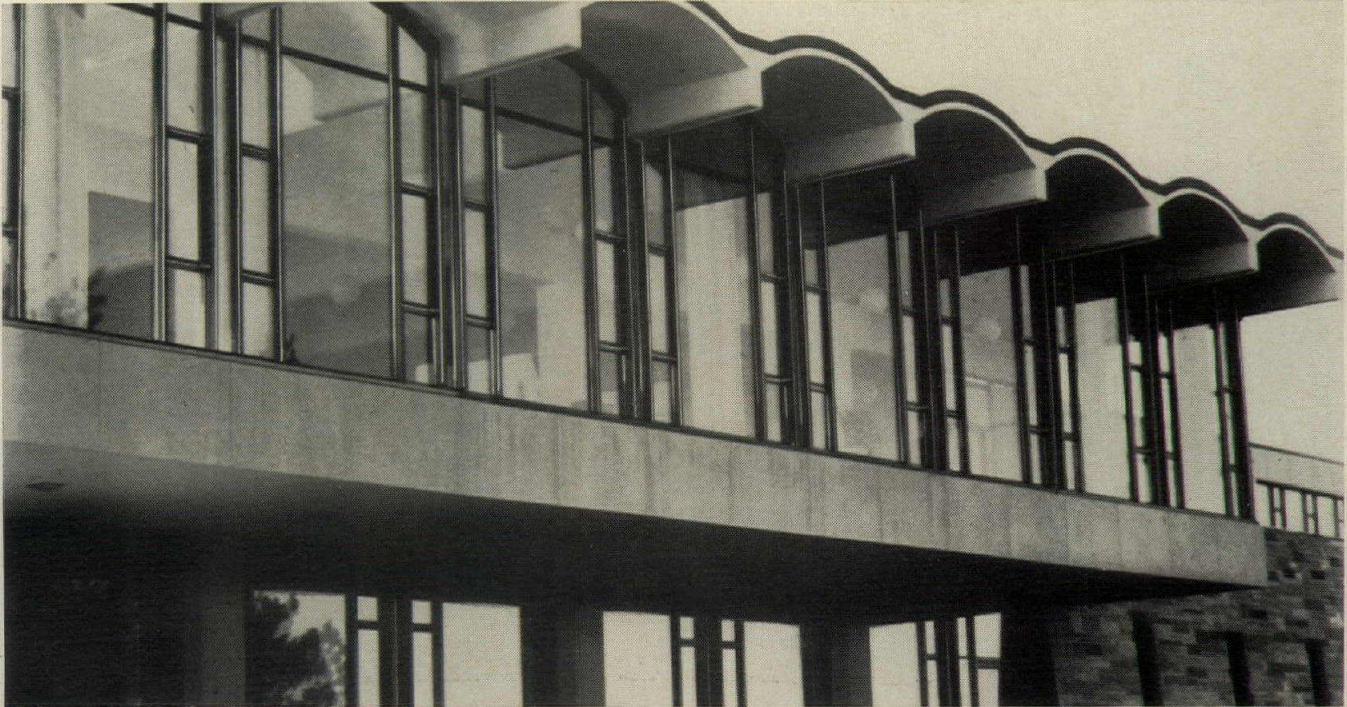

Thiokol

Specialty Polymers • Off-The-Road Vehicles • Synthetic Fibers • Sprayers • Propulsion • Human Development
Friction Materials • Ski Lifts • Pyrotechnics • Closures • Rubber and Rubber Chemicals • Medical Electronics Equipment

For more data, write A24 on inquiry card

You
can do
more things
with
light

Whatever you want your glass to do, C-E Glass has the light, heat, glare, sound or safety control qualities, plus the colors and patterns to blend beauty with function and to open new horizons for structural design possibilities.

POLARPANE® insulating glass units with 20-year warranted moisture-free construction.

POLARPANE® reflective solar insulating units with pure gold or chrome mirror-like coating.

ARM-R-BRITE® insulated spandrel panels, fully tempered and tailored to your color specifications.

ARM-R-CLAD® tempered safety glass. Clear, tinted and textured. Standard thicknesses from 1/8".

SOUND CONTROL POLARPANE® hermetically sealed units for maximum sound transmission loss.

SUN CONTROL POLARPANE® hermetically sealed units with rotating venetian blind between glasses.

MISCO® wired glass listed fire retardant by Underwriters' Laboratories, Inc. Seven popular patterns.

MISSISSIPPI® PATTERNED GLASS in wide variety of general purpose and decorative patterns.

CE GLASS

COMBUSTION ENGINEERING, INC.

For more data, write A25 on inquiry card

See our catalog in Sweet's 8.26 Ce or contact your local C-E Glass office, C-E Glass, 825 Hylton Road, Pennsauken, New Jersey, 08110. (609) 662-0400.

Campbell Centre, Dallas
Architects: Neuhaus + Taylor
Polarpane Gold #2016



doors and windows uci 8

Although we are known for our glass-sheathed skyscrapers, the construction industry has not been especially innovative in use of glass. Many new forms and uses have come to us from Europe where they demand more of glass and seem to get it. The glass-mullion-supported glass show window which is beginning to appear in the U. S. has been in use in Europe for more than 15 years. American invention has been more directed towards reducing the frame, rather than dispensing with it.

With regard to most products under the Division 8 heading, the industry as expected has been busy refining materials and methods. For example:

Improved processes for electro-vacuum plating glass are enabling manufacturers to control reflectivity of reflective insulative glass. The production of a reflective range makes it possible to select reflectivity and coloration suited to the building's heating, cooling and work comfort requirements.

Polycarbonate vandalproof glazing material is available in improved formulations which are, more resistant to abrasion, ultra-violet discoloration and available in sun-control tints or bronze and gray. Manufacturers have also begun marketing brightly colored polycarbonate sheet, which is moldable.

Metal window manufacturers, are relaxing their adherence to so called "standard sizes" and are readily fabricating windows to dimension desired which once involved premium charges. Some manufacturers are getting involved in engineering and fabricating three-dimensional window configurations, which they formerly would not have attempted.

Storefronts, curtain walls and entrances are becoming more sophisticated in design and detail. Thermal break schemes and sliding entrance doors are offered by many manufacturers. New aluminum narrow stile doors would have been considered dangerous or foolhardy not too long ago because of minimal cross-section dimensions.

Wood doors have benefited from recent advances in lamination and edge bonding techniques. Use of the new methods and machinery has resulted in some very attractive and unusual production line doors.

Replacement windows are becoming a very important factor in the rehabilitation of older buildings. Along with other improvements exteriors are cleaned and multi-paned double-hung windows are replaced with single pane pivoted or hinged windows.

*Alex E. Goldfine, Consulting Editor,
Sweet's Guidelines, New York, New York*

Condominiums Enter The Bronze Age



Architect: Stanford G. Brooks, Philadelphia, Penna.
General Contractor: R&H Construction Co., Fort Washington, Pa.
Curtain Wall Contractor: Howard Window Company, Hialeah, Fla.

The new Briar House condominium in suburban Philadelphia is an interesting example of the compatibility of porcelain-on-steel with precast concrete, brick and glass. AllianceWall porcelain-on-steel panels come in four new bronze colors at prices 40% to 60% less than hard coat finishes.

AllianceWall colors remain constant with absolutely no variation. Their smooth, non-porous surface will not retain dirt, grease or stains. They never require painting or expensive upkeep and stay true and new looking without fading or corroding. Panels are both graffiti- and vandal-proof. For complete information write:



Overseas Factories:

Alliance Europe, N.V.
Box 19
3600 Genk, Belgium

Pentagon A/S
Krogagervej 2
5310 Seden, Denmark

AllianceWall[®]

CORPORATION

Box 247, Alliance, Ohio 44601

For more data, write A26 on inquiry card



205

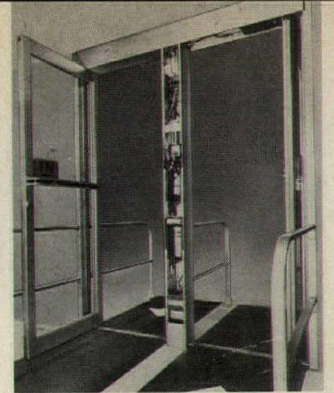

206



207



208

ENTRANCES & STOREFRONTS

205 GLASS FACADES / All-glass assembly entrances and facades are said to provide maximum expanses of glass with minimum visual obstruction. Entrances are available with no metal frame members, and can be used in both interior and exterior applications involving long runs of tempered safety glass. / Virginia Glass Products Corp.

206 CONCEALED OPERATOR / The company has introduced a T-header with integral, vertically-mounted power unit for automatic swing doors. The entire package is offered with clear or bronze anodic hard-coat color. / Dor-O-Matic. A*

207 SAFETY DOOR / The protective cylindrical pivot stile of this door is said to prevent pinched fingers. The flexible vinyl finger protector at lock stile eliminates injury to hands by closing doors. Top and bottom rod locks are offered. / Amarlite/Anaconda. A*

GLAZING

208 GLAZING TAPE / A highly elastic preformed tape with a continuous built-in shim, *POLYshim* is designed for compression glazing of lights or panels in high-rise building curtain wall systems. Prevents squeeze-out or negative loading caused by winds up to 100 mph. / The Tremco Mfg. Co. A*

209 ACRYLIC GLAZING / This high-impact acrylic plastic sheet, when used as a conventional glazing material, is guaranteed against breakage and weather effects for three years, according to the company. / Rohm and Haas Co. A*

210 REFLECTIVE FLOAT GLASS / *Solarcool* bronze and gray reflective glasses use a transparent metal film on heat-absorbing glass to reduce indoor heat build-up and improve visual comfort, according to the company. The products can be used in a single glazing. / PPG Industries. A*

211 SHATTERPROOF MIRROR / Also flame-resistant, the mirror is plastic backed and said to take impacts up to four times that of conventional 3/4-in. glass mirror, without breaking. / Lombardo Assocs., Inc.

212 GLAZING SYSTEM / The company states the product permits installation of multiple lights from the inside when horizontal bays are desired. System combines neoprene gaskets with special aluminum locking sections. / F. H. Maloney Co. A*

213 FLAME BARRIER / The company has been named national distributor of the non-combustible *Palusol Flame-Stop* and *Flame-Seal* sheets and panels for glazing purposes. The melting point of the expanded core of the products is said to be approximately 1850 degrees F, and the panels are said to not transmit heat. / Cadillac Plastic & Chemical Co.

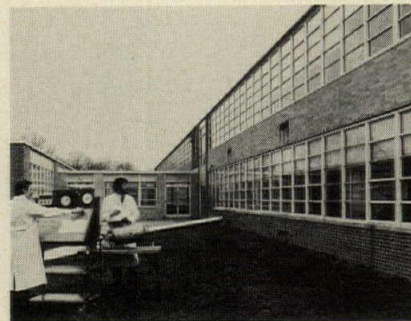

209



210

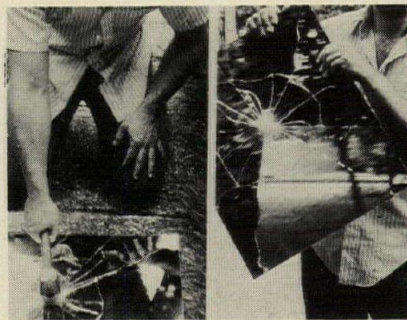

211

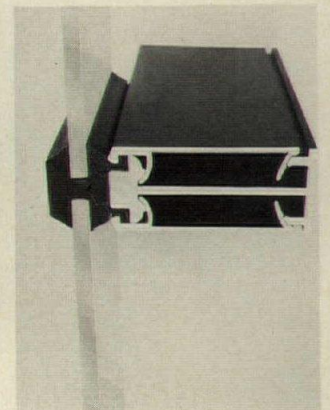

212

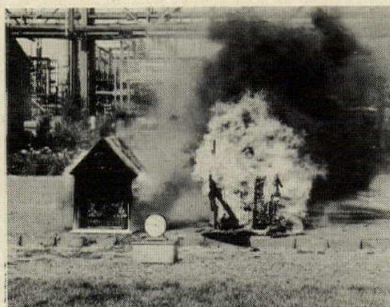

213

HARDWARE & SPECIALTIES



214

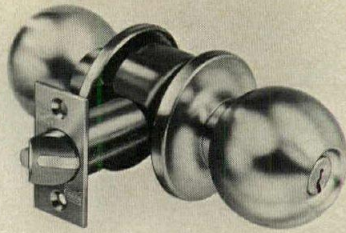

215

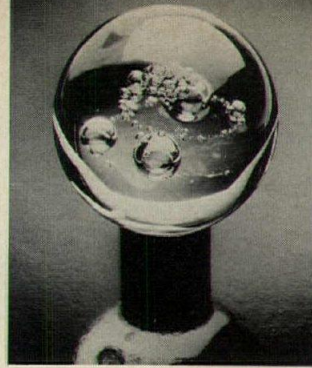

216

214 CYLINDRICAL LOCKSET / The series includes exterior, passage, bedroom and bathroom (pictured) models, all available in a smooth, round *Copenhagen* design. All latchbolts, both plain and deadlatching, are furnished with a 1/2-in. bolt throw, and units are UL-listed. / Eaton Corp. A*

215 CYLINDRICAL LOCKSET / The company's lockset, crisp and clean, is offered in a wide range of finishes and designs. / Russwin. A*

216 CRYSTAL KNOB / Available as a working door knob or pull, this crystal knob, with suspended air bubbles is offered in 3 1/4- and 5 3/8-in. diameters. / J. C. De Jong & Co., Inc.

217 EXIT HARDWARE / This factory-assembled touch bar is said to eliminate customary lever arms and cross bar. Horizontal and vertical roller bearings minimize friction and provide uniformly smooth operation along the entire length of the touch bar, according to the company. Designed for doors 2 ft 6 in. to 4 ft wide, with stiles as narrow as 1 3/4 in. / Von Duprin, Inc.

218 CYLINDER DEADBOLTS / A line of cylinder deadbolts for both new and replacement installations features a free turning hardened steel insert to prevent hacksawing on both 3/8 in. and 1 in. bolt throws. Cylinders are solid brass five pin tumbler with heavy duty brass guard. Self-adjusting for door thickness. / Harloc Products Corp.

219 DEADBOLT / This deadlock utilizes two 1/4-in. heat-treated bolts passing through a solid steel plate on the inside of the door and threading directly into the back of the outer cylinder housing. / Weiser Co.

220 KEY CABINET / A recessed mounted key cabinet is made of cold rolled furniture steel, furnished in gray. This cabinet will hold from 25 to 125 keys, in increments of 25. It is approximately 21 1/4 in. high, 17 in. wide, and 3 1/8 in. deep. / Telkee Inc.

221 WINDOW OPERATOR / A telescoping bar lock operator has been added to the company's *Flex-Pac* window, a low-cost unit. The telescoping feature permits adjustment of the length of the plastic tipped metal arm so that it does not protrude into the room. / Andersen Corp.

222 KEYLESS LOCK / The company's system is activated by a pass key, coded to establish a single combination of tamperproof radio frequencies. A control unit mounted in the

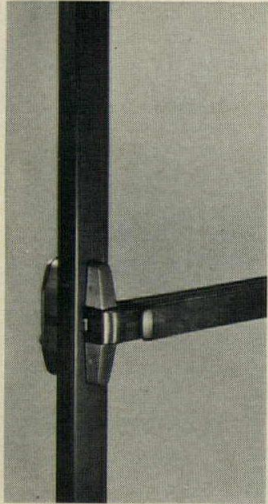

217

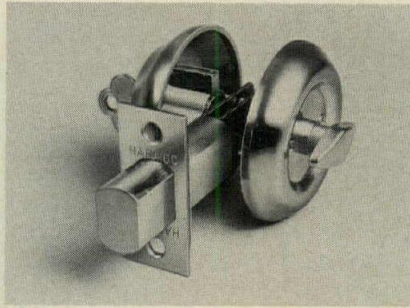

218

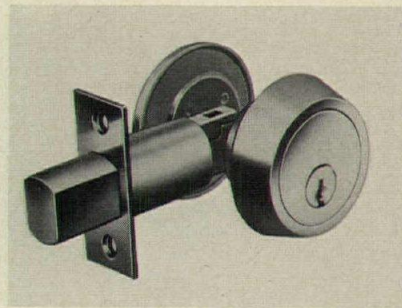

219

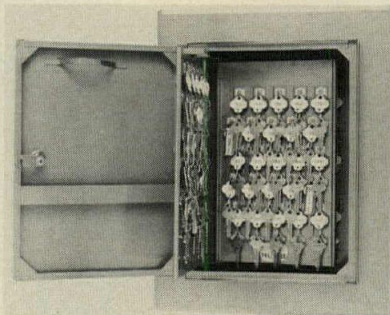

220

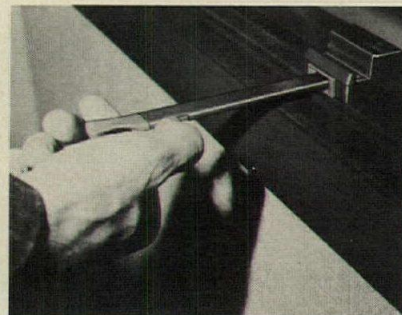

221

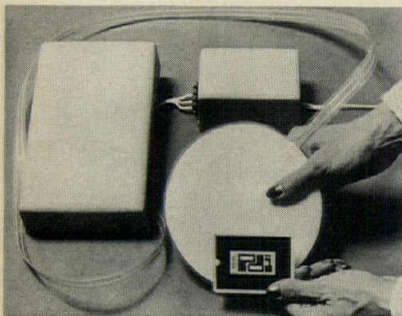

222



223

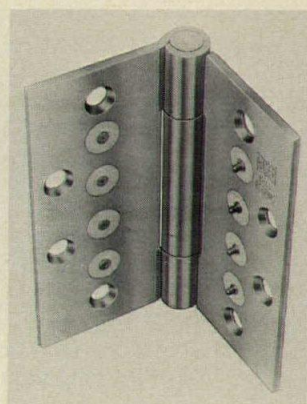

224

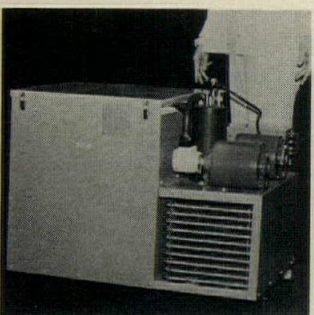

225

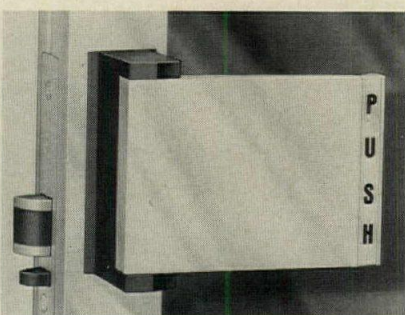

226

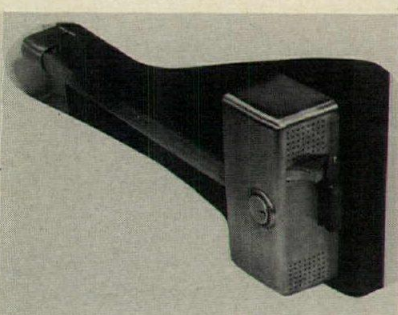

227

wall houses circuitry. Other components are a transformer and a sensor, the location of which can be known only to the code key possessor. / Schlage Lock Co.

223 DOOR OPERATOR / An all-aluminum cylinder for use on the company's pneumatic door operators is calculated to be up to 48 per cent stronger than the old design according to the company. The connection for the compressed air source is through the cylinder cap, reducing possible air leaks. / Air-Lec Industries.

224 ELECTRONIC SECURITY / An electronic security system combines a master control panel with a series of patented electric switch and contact hinges and individual electric locks; all designed for standard ANSI door-frame preparation. / Hager Hinge Co.

225 DOOR OPERATORS / The noiseless operation of this series is said to make them ideal for hospital, hotel and similar applications. Elimination of noise is made possible with an electro-hydraulic pump that uses 110-volt house current. The operator is self-contained in an above-door housing. / Eaton Corp.

226 PADDLE HANDLE / Intended to make passage through a latched door as natural as through an unlatched one, product is pushed or pulled in direction door swings. Works in any type door, from either or both sides. Color finishes are available or the standard satin aluminum finish. / Adams Rite Mfg. Co. A *

227 PANIC EXIT-ALARM / An audible alarm is incorporated into the product, which is equipped with a positive, sawproof deadbolt. It releases with less than 15 lbs pressure on the crossbar. Battery-powered twin horn alarm. Various finishes are offered, including duronatic bronze and dull stainless steel. / Alarm Lock Corp.

228 BRASS PUSHBUTTON LOCK / Offered in a new brass finish, this 4-digit combination lock features a massive bolt, according to the company. Combination can be changed. / Preso-Matic Lock Co., Inc.

229 PUSH-PULL HARDWARE / Aluminum extrusions hold and frame cast aluminum bas-relief insert tiles of original designs, according to the company. Extrusions and mounting brackets are furnished in satin anodized aluminum or medium bronze, dark bronze and black hardcoat colors. / Builders Brass Works Corp.

230 SAFETY CLOSER / A full rack and pinion door closer-holder with an electronic sensor is said to be a fail-safe life safety device that closes smoke barrier doors when electric current is interrupted. It can be used with

all types of new and existing detection systems and meets major building and life safety codes, according to the company. UL-listed. / LCN Closers. A*

231 FROST BARRIER / The product is said to solve the problem of condensation on metal threshold sills. *Frost Guard* is a rigid vinyl cap that slips over the indoor side. / Pemko Mfg. Co.

232 EMERGENCY OPEN DEVICE / When activated by an individual or smoke detector, the unit automatically provides immediate egress without the use of electrical power. Flush-mounted, and installed as part of the rolling grille, unit measures 5½ by 8½ by 3½ in. / North American Door Div., The Celotex Corp. A*

233 SAFETY DOOR CONTROL / The combination hydraulic door closer, electric hold-open and smoke detector can be used in conjunction with other early warning life-safety systems. It measures 2¾ in. high by 11¾ in. deep by 25¾ in. long. Offered in clear anodized and integral color finishes. / Dor-O-Matic Div., Republic Industries, Inc. A*

METAL DOORS & FRAMES

234 BI-FOLD DOOR / This pre-hanging metal door uses a wood frame to which tracks are attached and into which the metal bi-fold door can be placed. The complete unit can then be installed in an opening. The top track and door crack at the jambs are hidden by the frame. Available in several sizes, finishes and styles. / Peachtree Doors, Inc.

235 INSULATED ENTRANCEWAY / A solid core of polyurethane foam is sandwiched between one-piece steel panels, making an entrance that never warps, shrinks or swells, according to the company. Wide choice of designs and sidelight options to match any architectural style. The product eliminates need for storm doors. / Acorn Building Components, Inc.

236 STEEL DOOR FRAME / The 1-in. face of this product offers architects the slim look in a standard frame and is available in all of the company's standard sizes. Options include galvanized, finish paint, unitized weatherstrip and UL fire rating. / Steelcraft.

237 ADJUSTABLE FRAME / This steel frame for drywall and plastered openings comes in three profile sizes, and several heights and widths. The expanding frame is fabricated with 16-gauge and 18-gauge steel miters, precision-fit and reinforced. / Amweld Building Products. A, I*



228

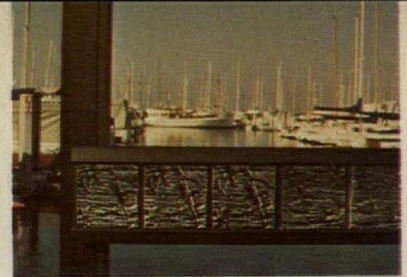

229

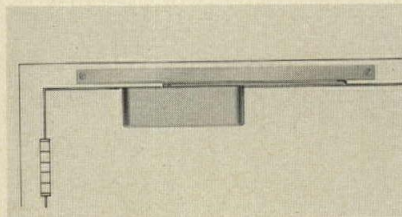

230

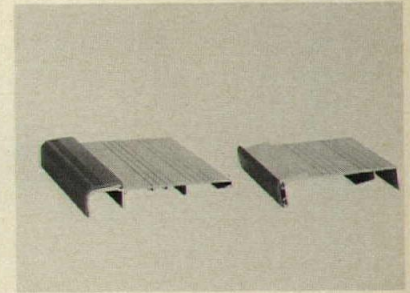

231



232

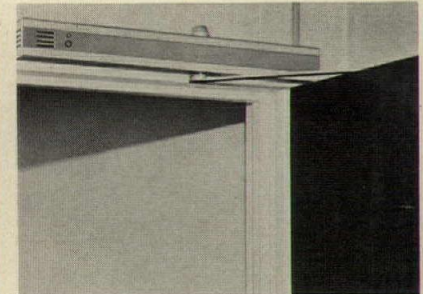

233

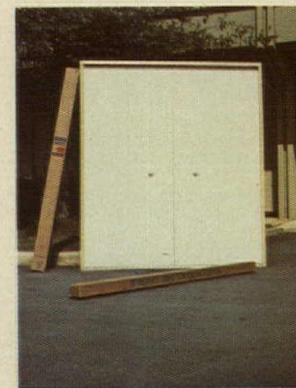

234



235

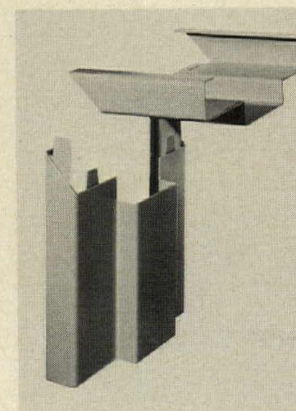

236

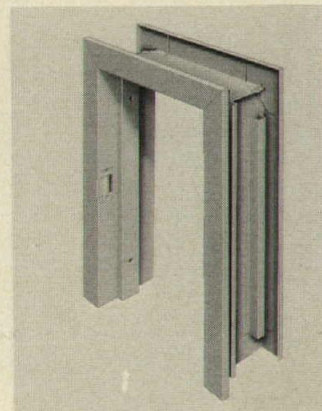

237

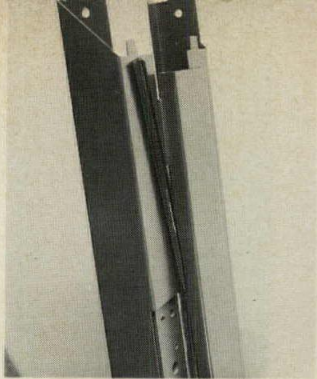

238



239

238 WEATHERSTRIPPED FRAME / This weatherstripped steel frame has an Underwriters Laboratories fire label and is now available for masonry construction only. The weatherstripping is installed at the factory, is impervious to the elements and is not affected by oil base paint, according to the company. / The Steelcraft Manufacturing Co.

METAL WINDOWS

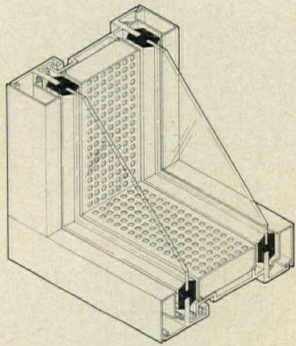

240

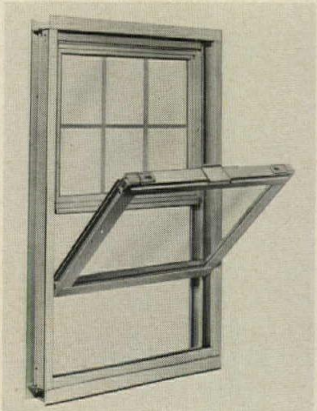

241



242

239 REPLACEMENT WINDOW / This aluminum replacement window is recommended for commercial and institutional buildings. The extruded aluminum surround system caps old wood and steel, enabling the installation of the new window without tearing out old materials. / Inter-Lake Industries, Inc. A*

240 ACOUSTICAL WINDOW / The window is said to provide sound ratings to STC 48 using ordinary glass up to 1/4-in. thick. Higher ratings are offered with heavier glass. Central equipment supplies super dehydrated make-up air at constant pressure to the space between the fixed inner and outer panes, eliminating stress of pressure and temperature changes, etc. / DeVAC, Inc. A, I*



243

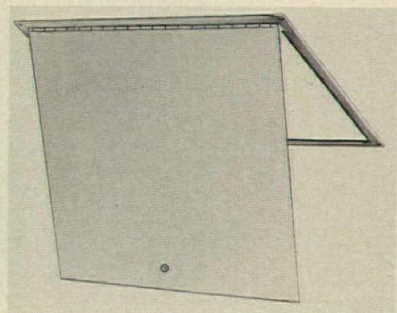

244

241 TILT WINDOW / A single-hung prime aluminum window with a tilt-take out lower sash is available with 1/2-in. insulated glass or other glazing choices. Screens and storm windows can also be supplied. A wide range of sizes can be obtained in white or bronze finish. / Metalume Mfg. Co.

SPECIAL DOORS

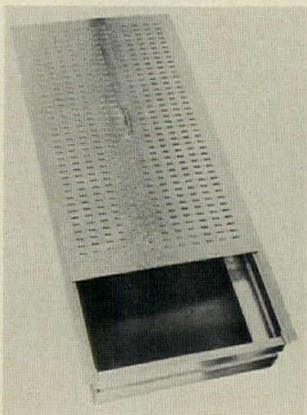

245

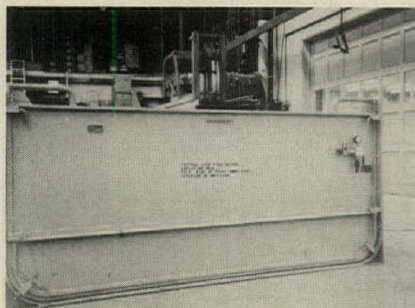

246



247

242 DARKROOM DOOR / For installations requiring a conventional door closure, the company offers a revolving door equipped with a full-length hinge that can be opened and closed for removing bulky material or for instant egress. Sizes to accommodate from one to four darkrooms. / Consolidated International Corp. A*

243 MIRROR DOORS / Wardrobe doors with mirror surface, in both bi-fold and sliding models, are offered in sizes for every door opening. Doors are said to be easily adjustable to align and plumb doors. Glazing is with 3/16 or 1/4 in. shatterproof mirror. / Diston Industries, Inc.

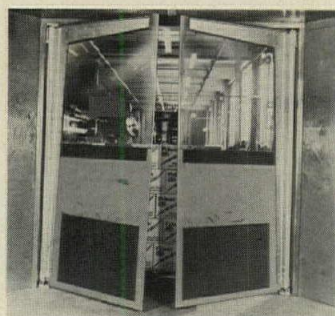

248

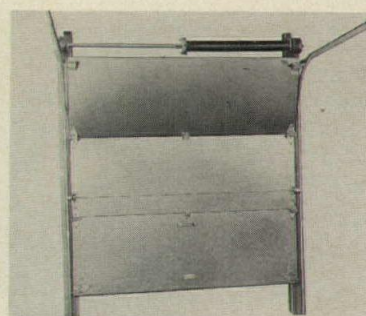

249

244 FLUSH ACCESS DOOR / This surface-mounted access door for use in drywell, thin coat plaster and masonry surfaces is screwdriver-operated, with stainless steel cam and stud. / Karp Associates Inc. A*

245 FOUNDATION ACCESS / This prefabricated door for access through foundation curtainwalls is made of aluminum, with its frame having a built-in lentil with mortar trap. Offered for use with all kinds of masonry foundation construction. Available in two sizes. / Lee Mfg. Co.

246 FLOOD BARRIER / For industrial and commercial buildings, this lightweight, removable panel can be fabricated to any height, any width, with all hardware. The company states the product will effectively seal entries and openings. / Presray Corp. A, I*

247 FOLDING ARM BRACKET / The product permits installing industrial bifold doors in narrower corridors, and in other areas with limited space, according to the company. Conventional bifold brackets usually require cutting a wall opening. / Clark Door Co., Inc. A, I*

248 IMPACT DOOR / A "see and drive through" door is specifically designed for ease of maintenance, according to the company. Custom engineered to fit the opening, each door has built-in weatherproofing and magnetic catches and wind checks. Heavy-gauge steel hardware and sealed hinges that are self-lubricating are offered. / Atlas Industries.

249 COOLER DOOR / This overhead model for use on truck dock openings features adjustable track for proper gasket seal. Door is filled with polyurethane insulation and both door and frame are clad in galvanized steel. / Jamison Door Co. A*

250 FREEZER DOOR / For cooler and freezer applications, the door is offered in bi-parting and single leaf, manual or power operated models. Doors and frames are clad in galvanized steel on all exposed surfaces and door insulation is polyurethane foam, having a K factor of 0.135 at 75 degrees F. / Jamison Door Co. A*

251 SLIDING COOLER DOOR / The company offers a full range of sizes in single and bi-parting electrically-operated sliding doors for refrigerated buildings. UL-listed and constructed with urethane foam against metal skins, the doors come in a choice of finishes. / Bally Case & Cooler, Inc. A*

252 FLEXIBLE DOOR / Called the *Pendador*, the product consists of overlapping transparent *Polar Vitran* strips hung from an overhead rod. The strips are flexible, strong and durable, according to the company. Recommended for human or vehicular traffic, indoor or out. / W. B. McGuire Co., Inc. A*

253 PATIO DOOR / Standard features include factory finishing, tempered insulating glass, screen panel, key lock and vinyl boot glazing. / Malta Mfg. Co.

254 STORM-SCREEN DOOR / The design features tempered safety glass and is available in several colors. Electro-static finish is guaranteed not to chip, crack or peel. Product meets AAMA specifications. / Season-all Industries, Inc. A*

255 FIRE DOOR / Finger tip closing is featured on this horizontal sliding model with a Class A, three-hour rating, according to the company. The manually-operated door's panels are zinc-coated bonderized steel and its leading and trailing edges are protected by heavy armored channels. Ball bearing trolleys. / Clark Door Co., Inc. A, I*

CURTAINWALLS

256 GRID WALL SYSTEM / An all-steel, grid-type curtain wall system features all-welded grids up to 8 by 40 ft. Factory-installed infill panels are available in many materials. Narrow sight lines, simple details and a wide choice of colors are claimed. The system is adaptable to steel frame or concrete construction. / Inland-Ryerson Construction Products Co. A*

257 WINDOW WALL UNIT / A variety of window styles to fit the company's curtainwall systems for industrial, commercial and similar buildings is offered, with heavy-duty aluminum extrusion frames designed to fit into metal wall, wood or masonry construction. Many finishes and colors are available. / Elwin G. Smith Div., Cyclops Corp.

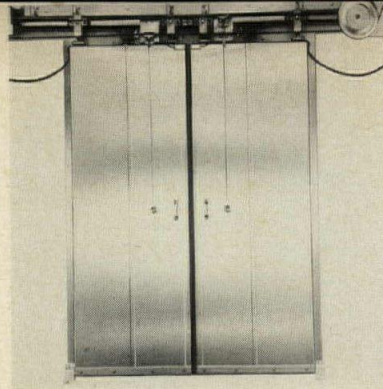

250

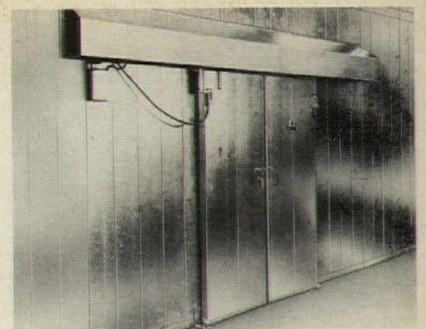

251



252

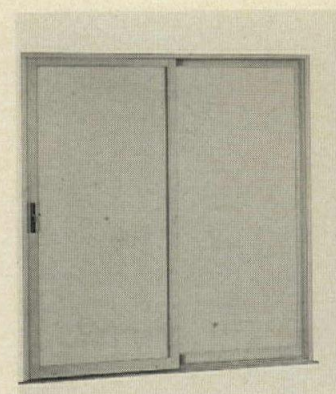

253

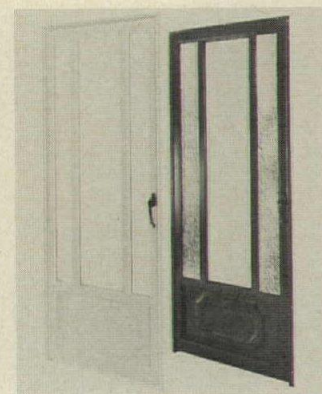

254

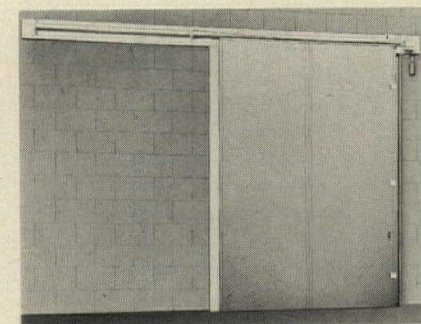

255

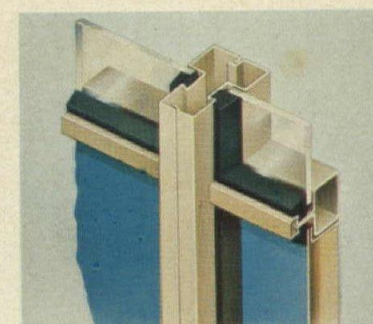

256



257

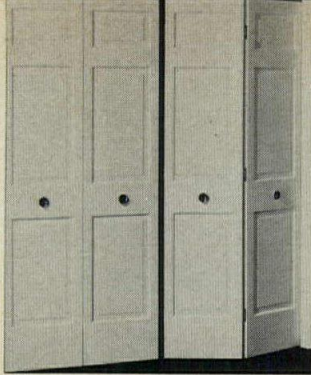

258



259

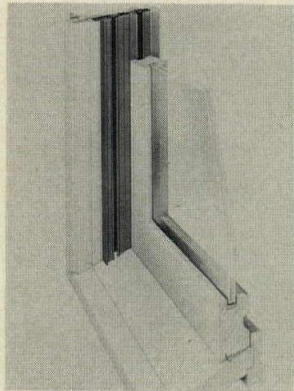

260



261

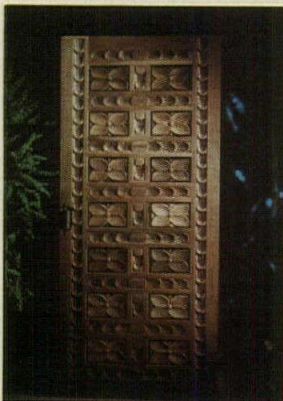

262

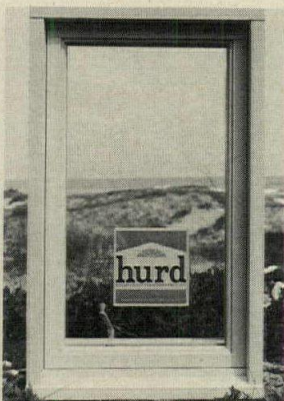

263

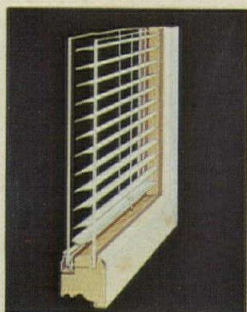

264



265

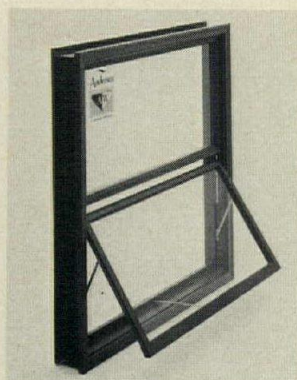

266

WOOD & PLASTIC DOORS

258 BI-FOLD DOORS / Structured polymer doors are available in two heights up to 6 ft 8½ in. and in six widths, with a lasting white factory prime finish. Doors may be painted. Trimability in length and easy installation are claimed. / C-E Morgan. A, L*

259 METALLIC DOOR SET / The look of gold, pewter and bronze is said to be achieved with this product which comes completely finished and ready to apply to wood or metal doors. / Formel, Inc.

260 TILT WOOD WINDOW / The exterior wood surfaces of this unit are completely and permanently laminated with a white, waterproof sheath, according to the company. On the interior, the natural wood is retained to be finished per choice. / Rodman Industries, Inc. L*

261 KNOT BLOCK DOOR / Weighing 6 lbs per sq ft, the door features ball bearing hinges. Laminated for strength and scratch-resistant, the door is available in four assembled designs, finished or unfinished, rough textured or smooth. / Whittlewood Corp. A*

262 WALNUT DOOR / This hand-carved door is one of many from a solid walnut collection. They are available with one or two sides carved and in all standard and custom sizes. Matching laterals and transoms are offered. / Pinecrest Inc. A, L*

WOOD & PLASTIC WINDOWS

263 VINYL-CLAD WINDOW / This casement window offers overlap design to eliminate the possibility of broken or ruptured joints, according to the company. All exposed surfaces are vinyl-clad to seal out moisture. Glazing is with ⅝-in. insulated glass. / Hurd Millwork Co.

264 SEALED-IN BLINDS / The company's windows can be fitted with a blind that fits into the 13/16-in. air space between the exterior glass and inside double glazing panel. A built-in dial tilts the slats from full open to closed. In summer, the shade is said to reduce solar heat gain by up to 82 per cent compared with unshaded glass. / Pella Rolscreen Co. A, L*

265 CASEMENT WINDOW / The company claims an improved hinging method allows the window to swing to the center of the opening for washing from the inside. Windows are all-wood on the inside and clad in aluminum on the outside. The outside finish comes in three colors. / Pella Rolscreen Co. A*

266 PREFINISHED WINDOW / The company's factory-assembled *Flex-Pac* window is now available in white and *Terratone*, finished with two coats of applied urethane. No on-site painting is required and all hardware is installed at the factory. / Andersen Corp.

Like its Clear and Gray brothers, new *Solarcool* Bronze Glass is a beautiful way to stay economical.

Depending on lighting conditions and the nature of nearby objects, the glass will produce a variety of intriguing visual effects, from very assertive to subtle. Its neutral character imparts neither warm nor cool tonality to the natural reflection.

It's also beautiful in modest performance situations.

A permanent, durable metallic-oxide coating on the outdoor surface of this 1/4-inch *Solarbronze*® substrate glass reflects approximately 35% of incident light. This results in a shading coefficient of

.43 and a visible transmittance of 21%.

Solarcool Glass is one of the few reflective glasses that can be field cut or fabricated. Or PPG can supply it in the heat-strengthened and tempered conditions.

Harmony *Solarcool* Bronze *Spandrelite*® Glass is also available. It matches the vision lights in the building below to produce a uniformly reflective facade.

Look into *Solarcool* Glass for your next building. Early in the design stages. Contact your PPG Architectural Representative or write PPG Industries, Inc., One Gateway Center, Pittsburgh, Pa. 15222.

PPG Environmental Glasses. Where good sense and good looks get together.

Project: 911 Big Beaver Road Building, Troy, Michigan
Owner: Kimberly Scott Corp., Detroit, Michigan
Architect: Rossen/Neumann Associates, Southfield, Michigan
Glass: PPG *Solarcool* Bronze Glass and Harmony *Solarcool* Bronze *Spandrelite* Glass

PPG: a Concern for the Future



For more data, write A27 on inquiry card

With PPG's new *Solarcool*® Bronze reflective glass, the sky is really down to earth.



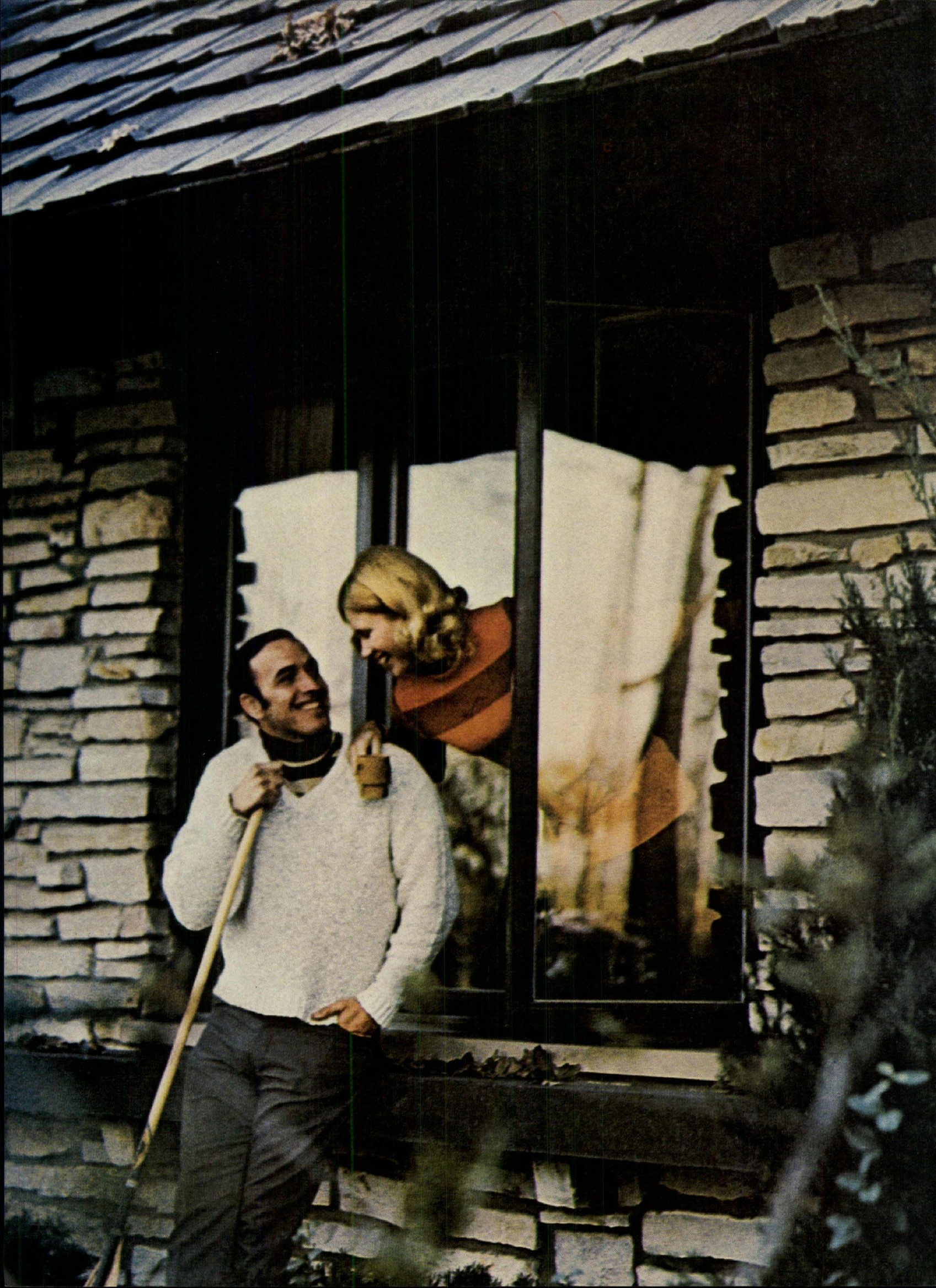

Provence—French Provincial styling with deep-fluted dimensional insets.

Deerfield—Early American paneling, boldly highlighted by the hand-tooled pattern in the wainscot area.



Masonite announces the Historic Series, four new hardboard panels with the look and feel of classic hand-carved wood designs of the past.

Authentic and convincing to the touch, this new collection reproduces in minute detail the finest work of European and Early American artisans.

Designed to complement the four most popular decorating categories,

they are as functional as they are elegant.

Time-tested Royalcote finish. Excellent sound attenuation. (A standard 2 x 4 wall faced and backed with 1/4" hardboard paneling has essentially the same STC as an 8" concrete block wall.) Underwriters Laboratories flame spread rating of under 200.

The Historic Series is available

now in easy-to-install 4' x 8' panels. Also available: matching pre-finished hand-crafted moldings.

For literature and professional samples, please write us. Masonite Corporation, Dept. A, 29 North Wacker Drive, Chicago, Ill. 60606.

Masonite and Royalcote are registered trademarks of Masonite Corporation. Man-made finishes on real Masonite hardboard.



First Impressions Are Important!

GET TO KNOW US!

128-page permanent
Encyclopedia XVIII
available by professional
request.

UNPRECEDENTED COLLECTION of

Doors, window panels, bifolds,
screens, dividers, grilles, patio
folds and paneling

30 styles Traditional Louvers

18 styles Ante Bellum Plantation
Louvers (2½" - 3½" louvers)

Vertical Louvers

Louvers & Curtains

Spindles & Curtains

64 styles Window & Door Panels
with decorative inserts

56 styles Decorative Inserts:
genuine canes, multicolored
plastics, ornamental metals,
Austrian poufs, shirred cur-
tains, laminations, ramma
frats, wood grilles, decora-
tive glass, and more

17 styles Shoji Panels

38 styles Grilles and Dividers

20 styles Folding Screens

56 styles Carved Panels

91 styles Hand-Carved & Solid
Panel Doors

Bamboo

Shell & Mahogany Panels

Hand-Carved Crests



PINECREST INC.

Designers
and
Manufacturers
of Premium Custom
Woodworking

RUSSELL H. UNDERDAHL
President
2710 Nicollet Avenue
Minneapolis, Minnesota 55408
phone: 612/827-5481

For more data, write A30 on inquiry card

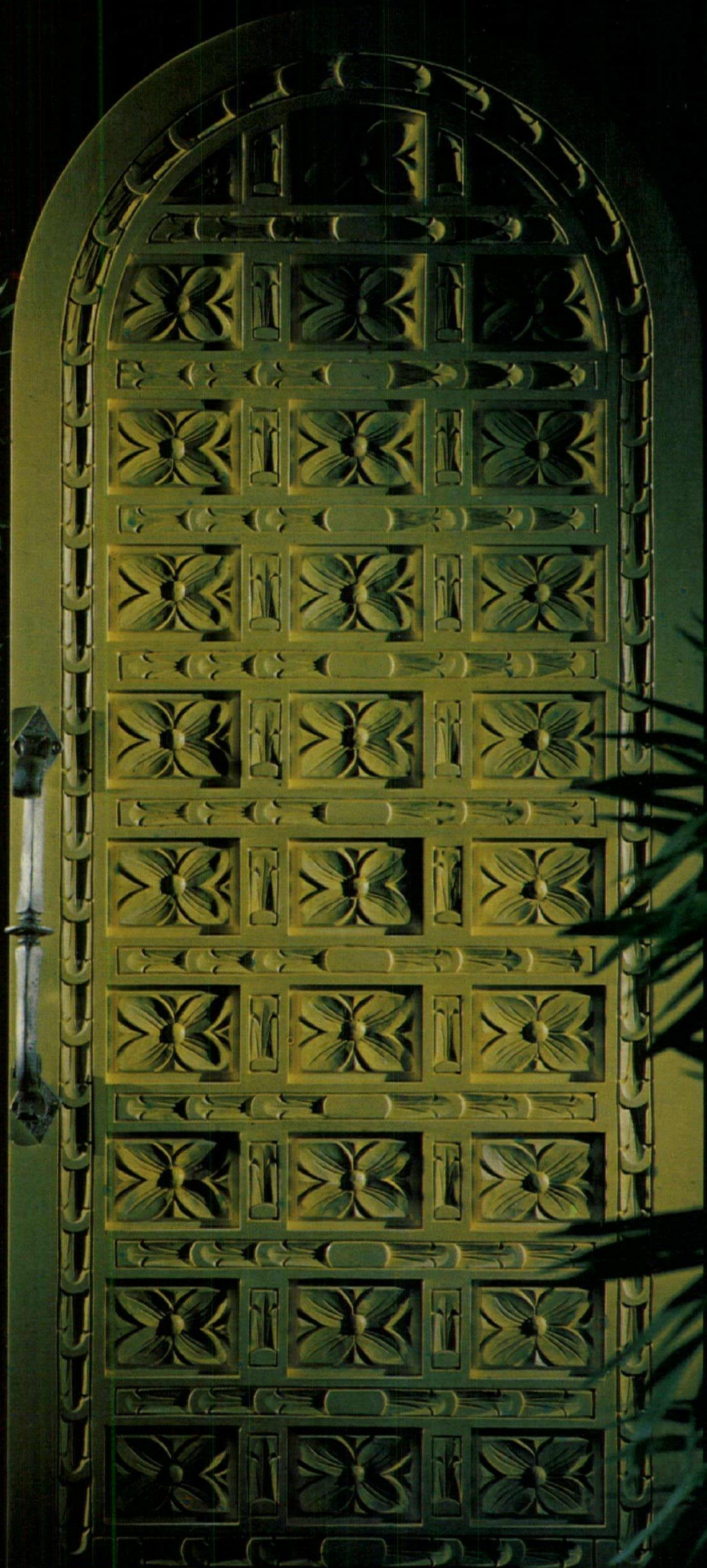

Kydex™ wallcovering: tough enough for hockey rinks... tough enough for you



Kydex wallcovering, the latest material used to face hockey rink dasher boards, can now be used to give truly rugged protection to your walls.

Available in pleasing decorator colors, Kydex gives walls exceptionally high resistance to scuffs, dents, gouges and the effects of most commonly used chemicals. Easy to install and easy to clean, rugged Kydex in the standard wallcovering thickness of .028" meets the requirements for a Class I interior finish under most building codes. Write for a brochure and the names of suppliers near you.



For more data, write A31 on inquiry card

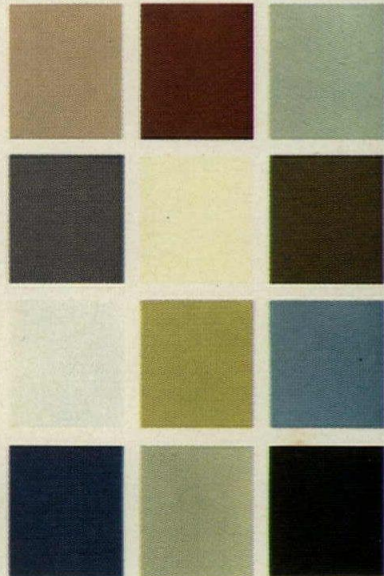

Kydex Sheet
For Class I interior finish, bond .028" KYDEX permanently to non-combustible substrate with contact cement or mastic adhesive. Flame spread and smoke ratings of .028" and thicker panels depend upon thickness, adhesion and substrate. UL ratings available. Colors may not be outdoor stable. Avoid exposure to heat. For handling and application information, consult Rohm and Haas bulletins.

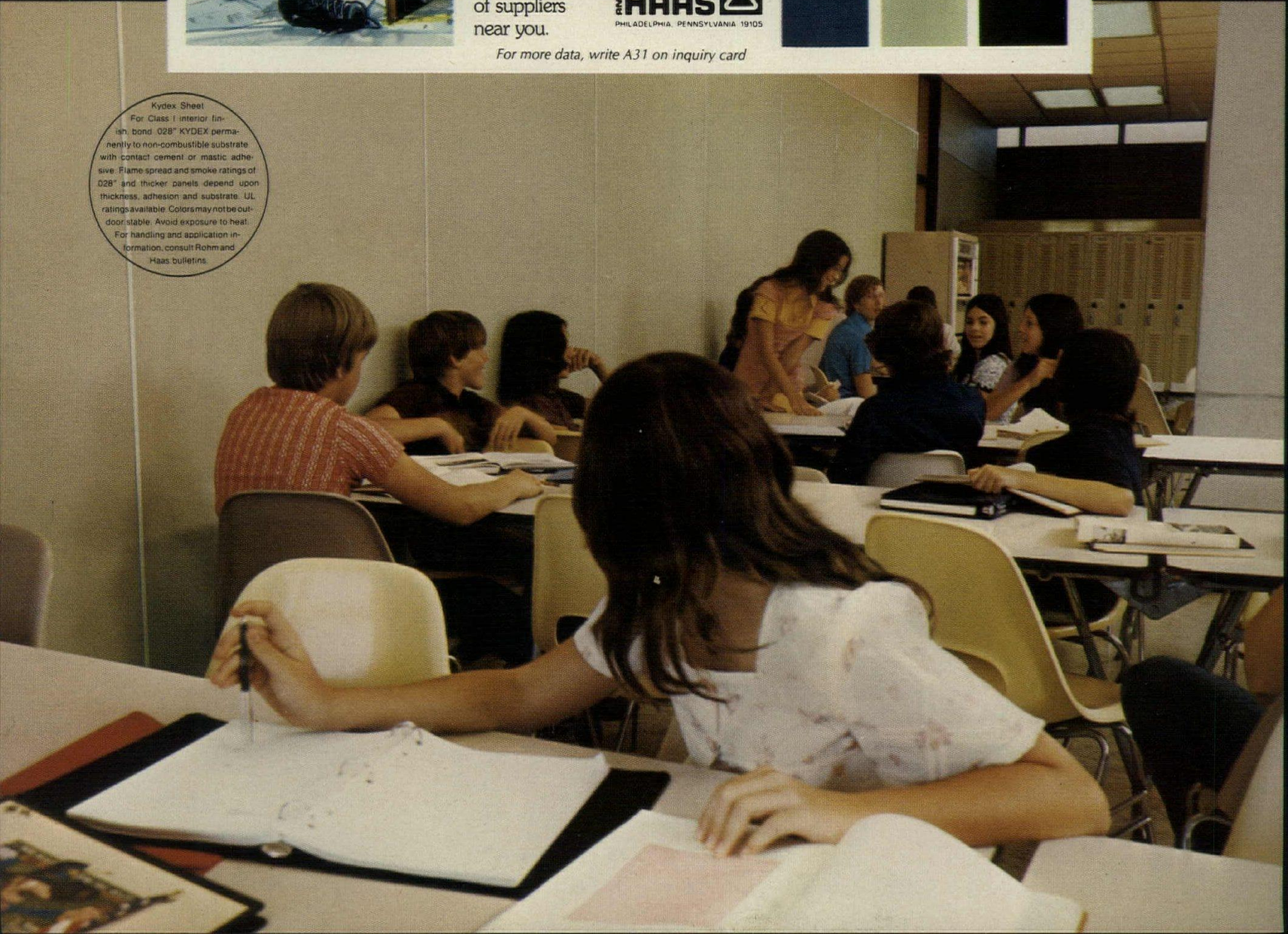



PRECEDENCE

SMOK-CHEK III:

a major breakthrough in fire/life safety door control...economically combines early-warning fire detection with automatic door release and closing...for patient sleeping rooms, cross-corridor applications, stairwell enclosures, high-rise areas of refuge, and elevator lobbies...to swiftly confine lethal smoke, save lives.

SMOK-CHEK III:

developed by fire protection professionals and proven in extensive fire testing*...meets or surpasses every applicable code or guideline...establishes improved detector positioning...and sets new standards for others to follow.

From Firemark, the fire/life safety specialists:



RIXSON-FIREMARK, INC.

9100 W. Belmont Ave.
Franklin Park, IL 60131

In Canada: Rixson-Firemark (Can.) Ltd.

*California State Fire Marshal's "Project Corridor" facility and I.I.T. Research Institute, patient room study

For more data, write A32 on inquiry card

WHILE THE CITY SLEEPS..



PROTECTIVE DEVICES ADD TO THE SECURITY OF LEADING BUILDINGS!

FOR OVER 44 YEARS.. LEADING ARCHITECTS AND ENGINEERS have recommended our broad range of protective devices, including the famous all stainless steel, visible and invisible Ace Magnetic Door Switches.

Ace burglary and holdup devices are used on the worlds finest buildings — office buildings — banks — universities — institutions — industrial complexes. All carry Underwriters Laboratory approval.

Telephone or send for a catalog showing our total capability.



A.W.FRUH

● ● ● ● ● COMPANY ● ● ● ● ●

1815 ORCHARD STREET
CHICAGO, ILLINOIS 60614
TELEPHONE (312) 642-4565

For more data, write A33 on inquiry card

A. W. Fruh & Company
1815 Orchard Street
Chicago, IL 60614

Name _____

Firm _____

Title _____

Address _____

City _____

State _____

Zip _____

Telephone: _____



A GRAND
OPENING
EVERY TIME

Introducing the smart, sleek Von Duprin 33 rim exit device . . . the nicest thing that can happen to a door.

Handsome, straight line touch bars replace customary lever arms and crossbars, adding neatness and distinction to every installation. Touch bars have a vertical surface of 2 1/8" for easier opening . . . a slight pressure at any point along the touch bar provides uniformly smooth operation. The entire solid assembly actually helps stabilize narrow stile doors.

The sophisticated engineering and advanced design of the Von Duprin 33 offer you a new dimension in exit hardware. For full details, write for Bulletin 733.

Von Duprin, Inc.

400 West Maryland Street Indianapolis, Indiana 46225
In Canada: Von Duprin, Ltd.



NEW! Push-button outside operation is a standard function on 333 outside trims. Futuristic pulls complement the entire opening design.

NEW! Wider contact surface for easier, safer operation. A slight pressure—anywhere along the touch bar—retracts the latch bolt.

NEW! One point cylinder dogging optional at slight additional cost. Standard one point dogging takes just one-eighth turn of dog key.

Von Duprin®

For more data, write A34 on inquiry card

Architects for the new PNB Plaza (prime tenant, Philadelphia National Bank) know how to save money. They specified terra cotta-colored window frames and vertical trim that will stay like new without expensive maintenance.

That's because they are aluminum extrusions, factory-finished with DURANAR® from PPG. These fluoro-polymer coatings are noted for their

color integrity and durability. In fact, DURANAR coatings have a 20-years-and-longer rated service life.

They also have a high degree of resistance to dirt and mildew, plus excellent cleanability. Which means you're combining color, long life, and low maintenance when you write DURANAR color coatings into the specs.

It's a good investment in the future. For any building. For data on PPG color coatings, check Sweet's Architectural or Industrial Construction Files 9.10/PPG.

Or contact the Market Manager, Extrusion Coatings, PPG INDUSTRIES, Inc., Dept. 13S, One Gateway Center, Pittsburgh, Pa. 15222.

PPG: a Concern for the Future

For more data, write A35 on inquiry card

EXTRUSION COATINGS FROM PPG. A SOLID INVESTMENT FOR THIS NEW BANK BUILDING.



PNB PLAZA, Philadelphia, Pennsylvania Architect: Ewing Cole Erdman & Eubank Consulting Engineer: Synergo, Inc.
Window fabricator: George Habgood & Company DURANAR coating applicator: Alcoa, Cressona, Pennsylvania

3A1



The architect facing the selection of finish materials has almost an *embarras du choix*, a superabundance of choice. Successful research and competitive pressures have brought forth products whose properties are a challenge to the architect's understanding, and whose usage are a challenge to his professionalism. Epoxies, silicones, vinyls and acrylics are some of the families of new products to be mastered. And in addition, the woods, stones and plasters that have been with us since the Middle Ages, are now subject to use in new technologies that require care in selection and use.

Architects have mistakenly used super-hard epoxies over soft substrates. Architects have unwisely used chemical coatings, whose manufacturers refuse to name their contents, and which have formed dilute acids when rained-on (nicely etching glass and dissolving metal edging). Architects have sadly used tongue and groove wood floor plank, with joints left open, to allow warm air supply from basement plenums. The large amount of newspaper publicity about building errors, and high costs of professional liability insurance are a measurable indication of these problems. Not ordinarily open to public view, unless one is personally involved, are the many lawsuits, material misuses and owner dissatisfactions.

How may one trend safely in these paths? Note the safeguards required when using a material for the first time:

- Inquiry of other architects that have used the material;
- Visiting existing buildings that use the material;
- Requiring manufacturers' or independent laboratory tests of properties of the material;
- Inquiring about manufacturers' and installers' guaranty terms.

Also, there are some basic considerations for selection of any finish material:

- How does one take care of the materials' expansion and contraction caused by temperature and humidity changes;
- Is it compatible to its surrounding materials;
- What will the effect be on the material of its normal use and wear;
- Is the material subject to normal wear and stress;
- How are the joints in the material to be treated;
- Is the material to be used for interiors only;
- How clean or dry, and at what temperature must base materials be for successful application of the finish material;
- Is material to be sprayed, troweled, broomed, or brushed on;
- Are there any problems in the installation of material, such as fastenings, mil thickness required, or separation or protection courses.

You don't have to look far to get color, long life, and cleanability for your metal buildings. New DURACRON Super 850 enamel from PPG has it all to offer, and at a moderate price.

That's why the DURACRON Super 850 coating you see on this steel building in Texas is the fastest growing premium siliconized finish in the metal building industry.

DURACRON Super 850 enamel combines long-life pigmentation with

an advanced siliconized-acrylic resin for maximum service life.

So you can bet this PPG coating will stand up to the worst weather mother nature can dish out. (Like the blazing-hot Texas sun. Or sub-zero weather up north.)

At the same time, DURACRON Super 850 gives the metal building a finish that's extremely hard. Won't chip, flake, or peel. And a finish that has superior resistance to dirt and mildew. Which

helps protect your reputation for bright, clean, low-maintenance buildings.

Find out why DURACRON Super 850 enamel is building a name so quickly in the metal building industry. For information, contact the Market Manager, Coil Coatings, PPG Industries, Inc., Dept. 13S, One Gateway Center, Pittsburgh, Pa. 15222.

PPG: a Concern for the Future

For more data, write A36 on inquiry card

NEW DURACRON® SUPER 850 COATING FROM PPG. IT'S BUILDING A REPUTATION.

RALPH WILSON PLASTICS COMPANY, Temple, Texas Coil Coater: U.S. Steel Corporation
Fabricator: Engineered Components Incorporated, Stafford (Houston), Texas Contractor: B-F-W Construction Co., Inc., Temple, Texas

4-9

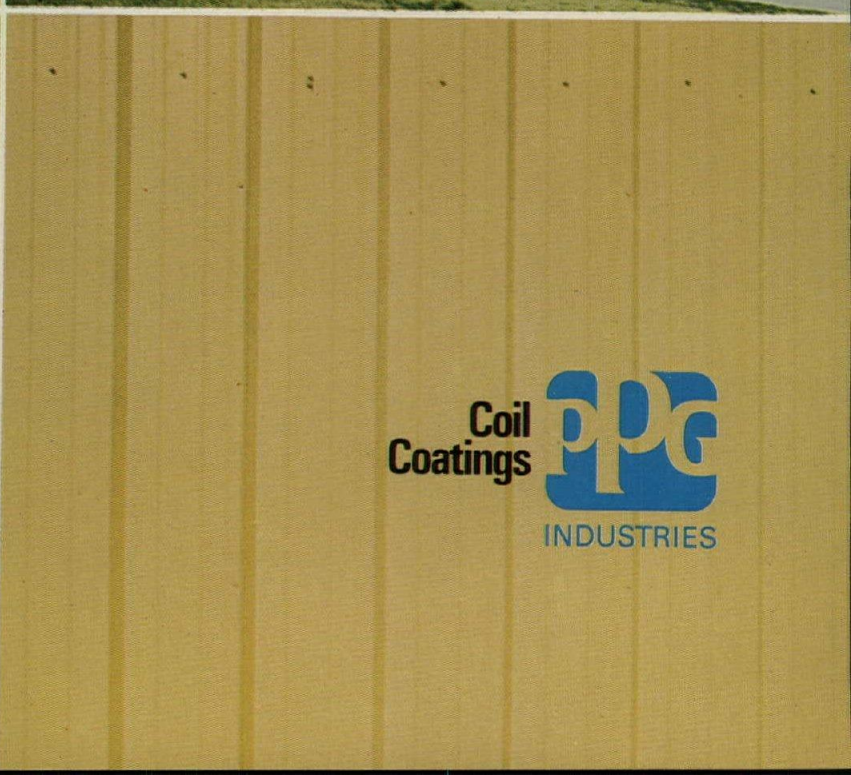
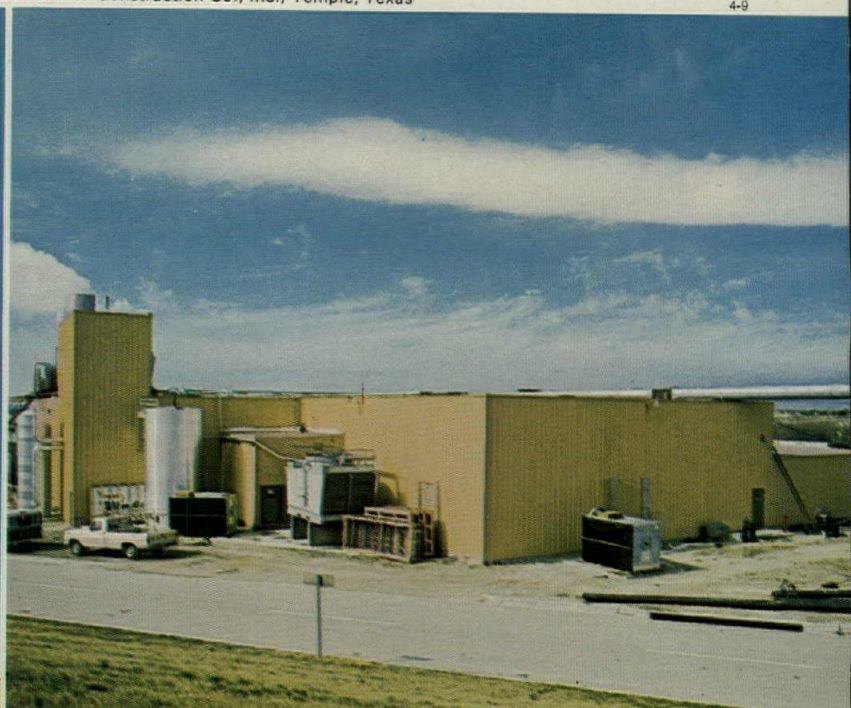
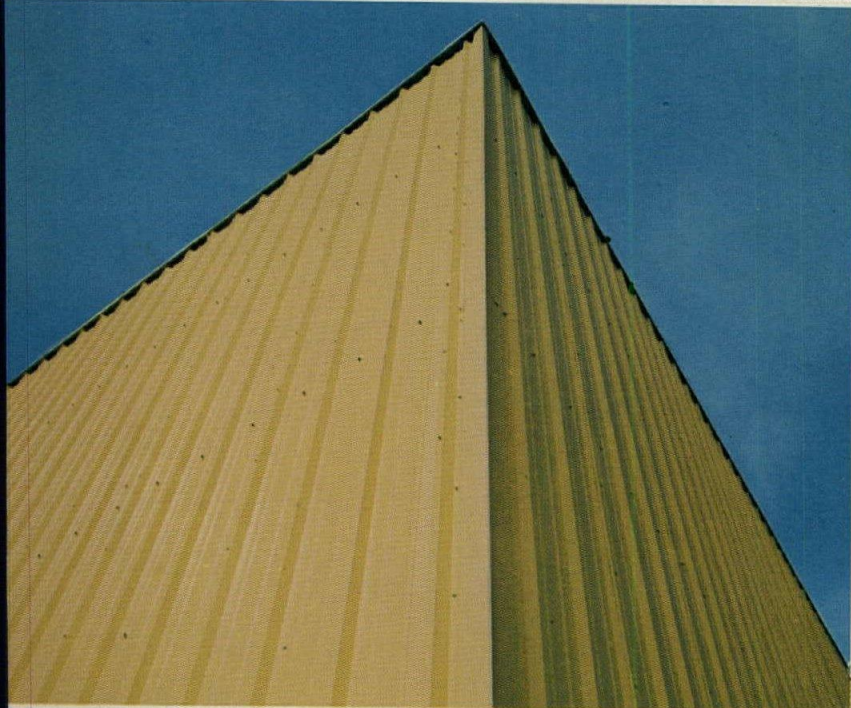

Coil
Coatings 
INDUSTRIES

ACOUSTICAL TREATMENT

280 ACOUSTICAL PANEL / To meet machinery noise isolation standards, these panels are said to offer an STC rating of 27 and NRC rating of .87. The 4 by 8-ft panels come with prefinished surfaces and the facing is fire rated. / Conwed Corp.

281 ACOUSTIC TACK PANEL / A Class I fire rating accompanies this tack surface with acoustical properties. Panels in various sizes up to 10 by 5 ft are recommended for lining walls in industrial plants. / Conwed Corp.

CARPETING

282 ANTI-STATIC FIBER / *Anso-X* is a polymer-based, anti-stat nylon that is being used by major mills in heavy weight, cut-pile fabrics—prints, plushes, solids and moresques—for contract use. The company guarantees the anti-stat protection for the carpet life. / Allied Chemical Corp. A, D*

283 CUT PILE PRINT / Made of tufted *Anso-X* nylon, the carpet is available in four colorations: blue-green, burnt orange, gold, red; in 12-ft widths. / Monarch Carpet Mills.

284 CUT PILE / The carpet shown features cut pile face yarns tufted of 100 per cent *Anso-X* nylon. Four colorways are offered and the carpet will be sold with a jute backing. / E. T. Barwick Mills.

285 PRINTED LEVEL-LOOP / This carpet is made with a dyeable 1800 denier olefin fiber. The yarn offers soil-hiding properties according to the company, and the level-loop prints made from the yarn are expected to be available in three-color styles. / Hercules, Inc. A, L, D*

286 BERBER-TYPE YARNS / These acrylic yarns are a blend of coarse-spun, primitive-type thick and thin fibers in natural shades which in finished loop pile carpeting closely resemble the hand-crafted look of traditional Moroccan carpet. / Monsanto Textiles Co.

287 CARPET / *Academic* is offered in 100 per cent *Antron II* nylon, in a textured looped pile. Fourteen colorways are stated by the company and rubber or jute backing is available. / E. T. Barwick Mills.

288 UNDERLAY / Made in seamless widths up to 12 ft, this urethane carpet underlay is said to insulate against noise, cold and heat, while resisting mold. It is non-allergenic and said to be priced competitively with conventional waffled felt underlay. / Tenneco Chemicals.

289 PLUSH CARPET / Made of 70 per cent continuous filament and 30 per cent *Herculon*, this carpet resists static build-up and traffic wear, according to the company. Available in 14 colors. / Gulistan Carpet Div., J. P. Stevens & Co., Inc.

290 RIBBED CARPET / A tightly-woven carpet of 70 per cent acrylic and 30 per cent modacrylic yarn, this carpet is offered in six neutral heather blends of greys, browns and beiges. / Gulistan Carpet Div., J. P. Stevens & Co., Inc.

291 OFFICE CARPET / This carpet is a combination of special machine construction and solution dyed *Acrilan 2000*. It shows resistance to static electricity build-up and resists dirt and stains, according to the company. The carpet weight is 90.5 oz per sq yd and several backings are offered. / J & J Industries, Inc.



280

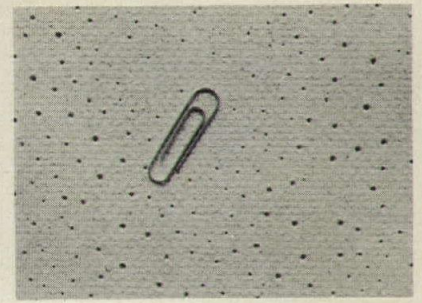

281



282

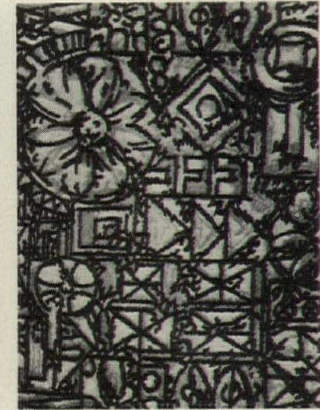

283

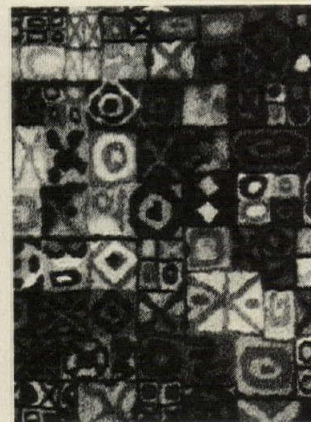

284

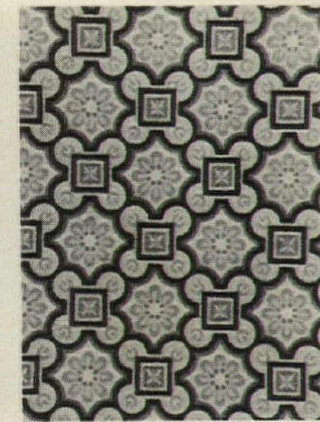

285

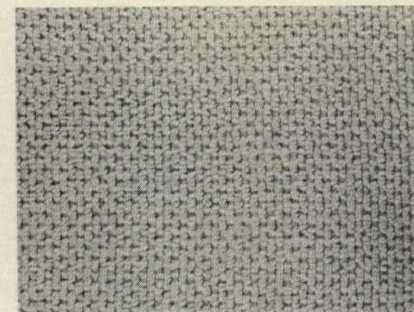

286

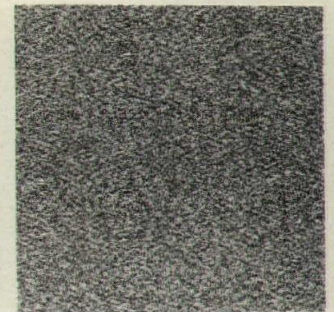

287



288



289



290

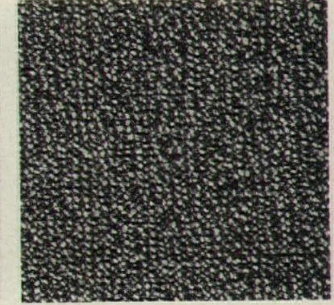

291



292



293



294



295



296



297

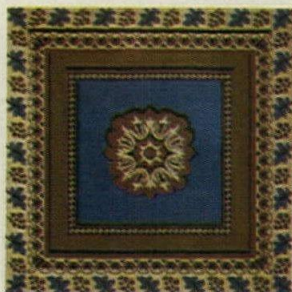

298

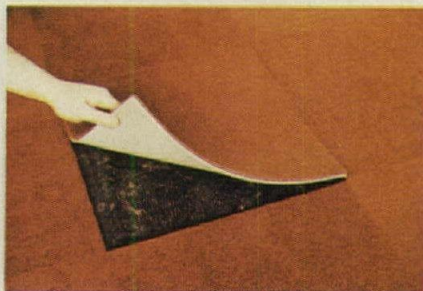

299



300



301



302

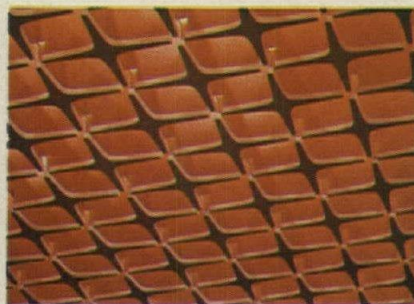

303



304

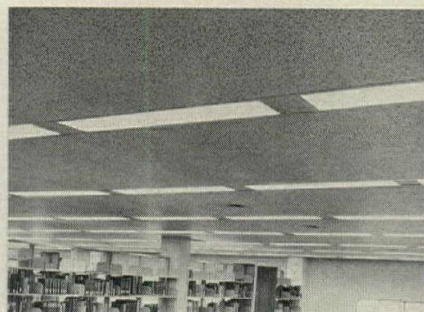

305



306

292 CUT LEVEL PILE / The carpet, woven in 12-ft widths, features a 6-ply *Zelran* blend acrylic-modacrylic fiber. A double heddle woven velvet, loop and cut level pile is featured for heavy traffic as qualified in the FHA "use of materials" bulletin UM-44b. Flame spread rating is under 75. / C. H. Masland & Sons. A, D*

293 PRINTED CARPET / Designed to stand up to heavy wear, the carpet has pile yarns of continuous filament *Antron* nylon and a static-reducing element. Dense foam back. Five designs in the series with a selection of colors. / Burlington Industries, Inc.

294 NYLON CARPET / This contract line in textured stripes is made of *Antron* nylon. Stripes can be used alone or with contrasting island, border effects. / Philadelphia Carpet Co.

295 CARPET SQUARES / In ten colors, and with a mephalt backing, the squares can be lifted easily and replaced for underfloor access, according to the company. Size is 19¹¹/₁₆-in. square, with a weight of 7.54 lbs per sq in. / Heuga-tile Corp.

296 CUSTOM NYLON CARPET / A heavy-duty acrylic-nylon carpet is offered in an extensive range of custom colors, with tightly woven, high-loop construction. Integral static control. / Commercial Carpet Corp.

297 CUSTOM TUFTED CARPET / The company offers 34 textures and qualities, with yarns skein-dyed to match samples submitted. Widths up to 25 ft. / Philadelphia Carpet Co.

298 CUSTOM PATTERNS / Available in unlimited pattern and color latitude, in several pile fibers and blends, this carpeting can be produced in any color combination. A library of existing designs is available. / Philadelphia Carpet Co.

299 CARPET MODULES / The pile surface consists of anti-static *Anso-X* nylon, imbedded in a three-layer backing of PVC and fiberglass reinforcement for dimensional stability, according to the company. The 18-in. squares require no adhesives. / Carpets International-Georgia, Inc. D*

300 WOOL CARPET / This loop texture woven wool carpet is offered in 15 colors, including earth tones. Special custom colors available. / Philadelphia Carpet Co.

CEILING SUSPENSION

301 PRISMATIC PANELS / Made of sculptured fiberglass finely textured with a white vinyl paint finish, the panels are 4-ft square in-lay types, with an overall depth of 8 in., extend-

ing 4 in. above and below the ceiling plane. Flat panels are offered for borders, fixtures and vent areas. Excellent sound absorption is claimed. / Johns-Manville. A*

302 CEILING SYSTEM / The company claims this system adapts to change easily, permitting lighting, air or partitioning requirements to be changed periodically. The vaulted design is said to provide excellent lighting quality, and the system carries up to two hours of UL-rated fire protection. / Conwed Corp. A*

303 LUMINOUS CEILING / The star design created by an architect is uninterrupted by supporting grids, tracks or rails. Louvered sections of the ceiling are suspended by a self-spacing hanging system installed on the building ceiling. The 30-in. square sections, which can be swung down for access, are suspended from rods. / Litecraft/Luminous Ceilings. A*

304 RESIDENTIAL CEILING / A three-dimensional ceiling for the home includes 2-ft square white panels supported by a recessed black grid. The panels have beveled edges and flanges recessed 1/4 in. on all sides. The flanges rest on and are concealed by the grid system. The *Tegular* panels are acoustical. / Armstrong Cork Co.

305 ACOUSTICAL CEILING / Panels are available in fissured and non-directional fissured patterns, 12 in. wide and in lengths up to 96 in. The system meets Class I interior finish flame spread requirements. / Simpson Timber Co. A*

306 CEILING SYSTEM / Two *Vari-Tec* ceiling systems with UL, time-rated design assemblies of up to two hours are said to provide UL fire resistance ratings for floors and ceilings. / Celotex Div., Jim Walter Corp. A*

307 INTEGRATED CEILING / This flat system provides for a minimum of plenum depth and combines lighting, air diffusion and acoustical control in the one unified assembly. The module is 60 in. square. / Conwed Corp. A*

308 SUSPENSION SYSTEM / Override crimping is said to provide complete visual security at all intersections of this system. All main beams lock integrally and cross tee sections now carry the double lock action, and are self-indexing. / Flangeklamp Corp.

309 SUSPENSION SYSTEM / A special stud with hanger wire attached is welded to the underside of a fire-proofed deck or structural members by workmen standing on the floor. The company claims studs are welded fast and respaying of fireproofing near weld is rarely needed. Welding can take place late in construction. / Nelson Stud Welding. A, I*

GYPHUM WALLBOARD

310 FIRE BARRIERS / A fast-erecting drywall partitions system for fire barriers in multi-family housing features lightweight non-bearing gypsum assemblies. Panels are attached to specially-designed steel studs and runners. Units are offered in cavity type and solid. / United States Gypsum Co.

311 DEMOUNTABLE PARTITION / This battenless partition system is said to offer ease of installation, combined with the advantages of prefinished surfaces. Currently being test-marketed, it will be available early in 1974. / Gold Bond Building products Div., National Gypsum Co. A, D*

312 VINYL-SURFACED GYPHUM / The panels are designed to be used as writing, projection and tack surfaces, possessing a fine lenticular surface. Recommended for schools and businesses. / Lenwall, Inc.

FLOOR TREATMENT

313 CARPET FOR ACCESS / The company has developed a system of carpeting that permits easy access to subfloor systems. Technique uses special adhesives and tapes and eliminates vinyl or metal edging, while preventing carpet raveling. / Commercial Carpet Corp.

LATHING MATERIALS

314 BARN BOARD STAIN / For interior application, this stain is said to produce the weathered-gray effect of barn boards. It is a very transparent stain that accents the variations and irregularities of all types of wood. / Samuel Cabot Inc. A, L*

315 MASONRY COATING / The *Pro-Hide* line of paints is an epoxy ester to provide texture, filling, hardness and durability according to the company. One coat exterior application on cement, concrete and masonry block gives stipple effect. Many colors offered. / Pratt & Lambert, Inc.

316 SOLID COLOR STAINS / Stains in 31 colors are opaque to hide the grain, but not the texture of the wood, according to the company. One coat application can be applied to all woods, but is also effective on metal and masonry. / Samuel Cabot Inc. A, L*

317 ACRYLIC HOUSE FINISH / The *Poly-X* line of house and trim finishes offers a low sheen, and can be applied over wood, stucco and metal. Eight standard colors are offered and over 1000 custom colors can be produced. Flat, gloss and semi-gloss finishes are available and the paint comes with a seven year guarantee. / Pabco Paint Corp.



307

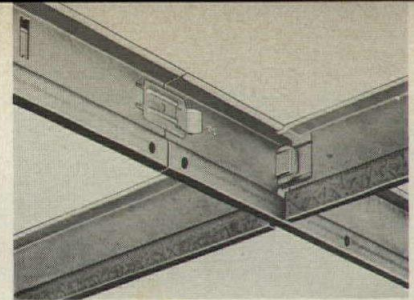

308



309

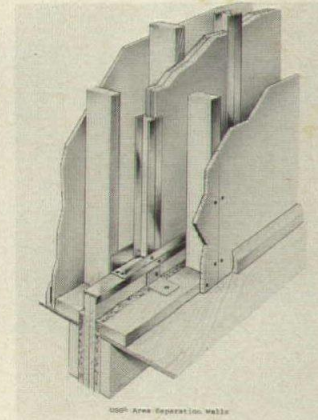

310



311



312

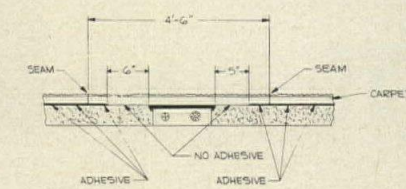

313



314

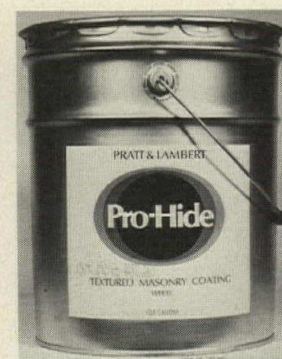

315



316

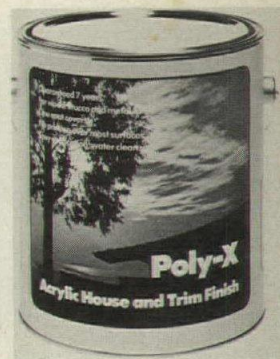

317



318

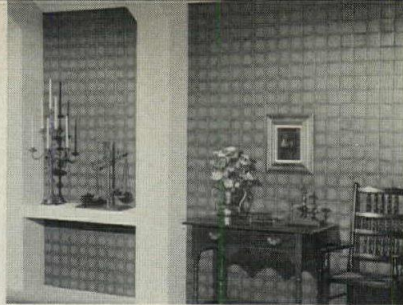

319

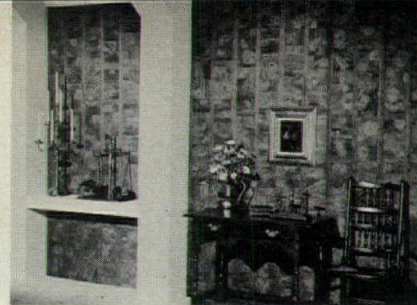

320



321

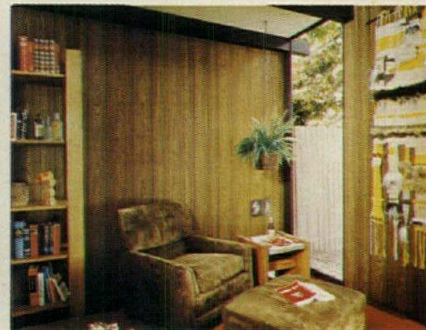

322



323



324



325

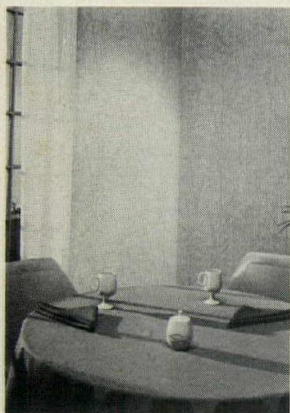

326



327



328

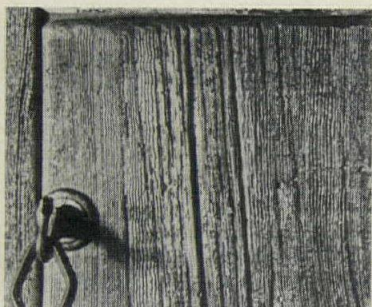

329

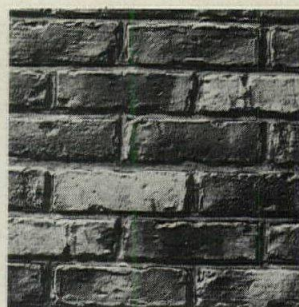

330



331

PREFINISHED PANELS

318 CLASS II PANELING / With a Class II rating, Rosewood and Teak architectural veneered panels are treated with a clear, colorless fire retardant surface impregnation. Bookmatched panels therefore offer 26 to 75 Flame-spread ratings, according to the company. / Tech Sales Co. A, L, D*

319 TILE-LIKE HARDBOARD / Pre-finished 4-by-8 ft panels have a glazed-like finish in earthen tones, while simulating 4-in. tile squares. / Masonite Corp. A, L, D*

320 WOOD BLOCK PANELS / These hardboard panels measuring 4 by 8 ft are a reproduction of wooden blocks set between matching strips. Knotty grains and a brownish color achieve a massive look with texture. / Masonite Corp. A, L, D*

321 HARDBOARD PANELS / In a Spanish motif, these 4-by-8 ft panels have the look of being made up of 18 individual wooden blocks in three vertical rows of six. Deep textured graining is featured and panels come with a dark chestnut color finish. / Masonite Corp. A, L, D*

322 VINYL PANELS / A choice of grains and colors is offered in this line of panels with thermal fused vinyl surface. Class C fire rated, the panels are said to resist water, staining and fading. The 3-ply panels cut easily for fitting around doors and windows and can be nailed. / DG Shelter Products.

323 GYPSUM WALL PANEL / The decorative cork surface in a parquet design is factory-laminated to 1/2- and 5/8 in.-thick gypsum wallboard or Fire-Shield board. All panels are 4 ft wide and manufactured in lengths from 6 to 14 ft. The panels can be installed with nails, adhesives or used in a demountable partition. / Gold Bond Building Products Div., National Gypsum Co.

324 COLONIAL PANELS / The 4-by-8 ft hardboard panels are replicas, each with five simulated planks with a deep-embossed motif in the wainscot area. Done in walnut tone. / Masonite Corp. A, L, D*

325 PANELING / V-groove joints concealing aluminum moldings create imperceptible joints, with 48-in. wide panels, according to the company. Shown is one of 150 solids and patterns available in laminated plastics. / Ralph Wilson Plastics Co.

326 PLYWOOD PANELS / Prefinished in bright colors and designs, the nine panels in the series are said to withstand many household hazards, and cost less than wallpaper in comparable designs. Panels are installed with nails or adhesive. / E. L. Bruce Co., Inc.

327 HARDBOARD REPLICAS / A reproduction of an 18th century French design, these 4-by-8 ft panels are available in off-white. Each panel has three long, narrow panel sections, with dimensional detailing. / Masonite Corp. A, L, D*

328 PLYWOOD PANELS / *Bright-Ons* come ready to install in a range of solid colors. Panels feature a washable, fade-proof and scuff-proof surface, according to the company. / Evans Products Co. L*

329 SIMULATED BARNSIDING / Featuring random width planks individually-applied, the product has a weathered look similar in color and texture to real barnsiding. / Kalwall Corp.

330 BRICK PANELS / Lightweight, hand-finished panels of fiberglass reinforced polyester are offered in three antique brick colors. After installation, mortar is applied with a caulking gun. / Marlite Paneling.

331 OAK PANELING / A replica of old oak paneling, *Briarcliff* comes in 4-by-8 ft sheets of hardboard. The texture and detail in panel insets has the look of handcrafting. Applied with adhesive or by nailing. / Masonite Corp. A, L, D*

RESILIENT FLOORING

332 SLATE-LIKE VINYL / A solid vinyl tile with the look of slate is offered for commercial installations. The tile measures 12 by 18 by $\frac{1}{8}$ in. and can be used in a variety of ways—herringbone, square, ashlar or random. / Kentile Floors Inc. A, L, I, D*

333 MULTICOLOR VINYL TILE / A sharp straight-line pattern with scroll motif is available in this vinyl asbestos tile with embossing and a deep pebbly grout. The tile is offered in four color combinations; it measures 12 by 12 by $\frac{1}{16}$ in. / Kentile Floors Inc. A, L, I, D*

334 VINYL ASBESTOS TILE / Available in four colors, this resilient tile is $\frac{1}{16}$ in. thick and measures 12 in. square. The tile is said to be grease-proof and resistant to common household stains and alkaline moisture. / Azrock Floor Products.

335 CUSHIONED VINYL / For commercial and institutional interiors, "Grand Central" is the latest in the company's line of *Quiet Zone* vinyl flooring. The pattern extends through the entire wear surface. Impact resistant and stain resistant. / Armstrong Cork Co. A, L, I, D*

336 SOLID VINYL TILE / This tile features the bright baked clay look. The tiles are framed in solid vinyl planks, available in earth colors, along with the tiles. / Kentile Floors Inc. A, L, I, D*

COATINGS & SURFACINGS

337 STUCCO ROLL / A flexible, exterior, color-impregnated, masonry wall surfacing furnished in rolls is said to harden with normal weathering, and a special mastic acts as the bonding agent and catalyst to harden the finish to its stucco state. / Wall & Floor Treatments, Inc.

338 CEMENTITIOUS CEILING / A sprayed, textured ceiling material is applied over drywall to provide, according to the company, a low-cost, abrasion-resistant surface that softly reflects light. Product can be applied to interior walls and ceilings in a variety of textures, and is said to be a durable weathering surface for exterior applications over most masonry surfaces. / Finestone Corp. A*

339 SEALER / A multi-purpose sealer for a variety of surfaces, including concrete and wood produces a tough, abrasive-resistant surface which will prevent dusting in heavily traveled areas, according to the company. *Zerok 200* is recommended for interior application. / Atlas Minerals & Chemicals Div., ESB Inc.

340 FLOOR, TANK COATING / An epoxy polysulfide compound suitable for applications where resistance to abrasion, impact and mild chemicals is needed, this product can produce a non-skid, tough surface according to the company. / Atlas Minerals & Chemicals Div., ESB, Inc.

341 FLOOR MEMBRANE / A two-part elastomeric waterproof and corrosion-proof floor membrane for concrete, metal or wood is said to be equally good with monolithics, tile and brick floor construction. Product is non-volatile and does not require a primer, according to the company. / Atlas Minerals & Chemicals Div., ESB Inc.



332



333



334



335



336

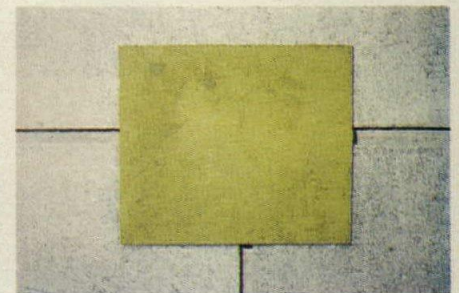

337



338



339



340



341

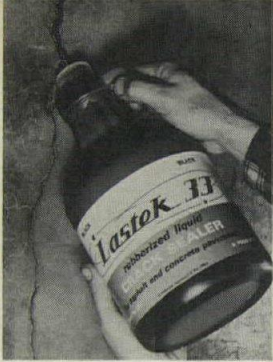

342

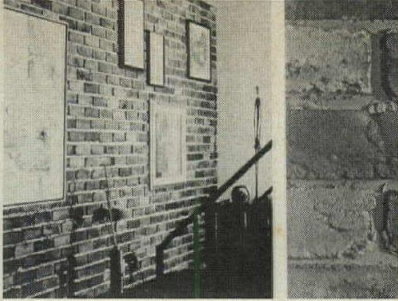

343



344

342 LIQUID CRACK SEALER / For asphalt and concrete pavements, the material is said to bond firmly, while remaining elastic to permit expansion and contraction. It resists water and weather. / Maintenance, Inc. A*

343 SIMULATED BRICK / The bricks are made of fiberglass reinforced plastic and offered in three colors. Mortar is applied to the wall, then to the back of the brick which is pushed into place. / Kalwall Corp.

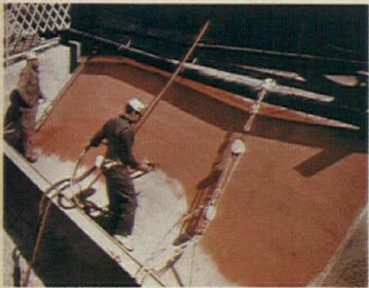

345

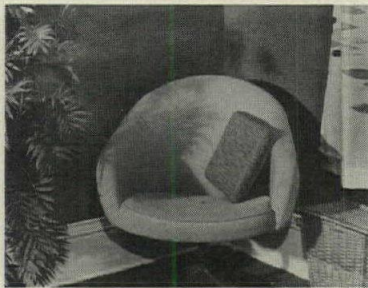

346



347

344 SIMULATED STONE / Stones of reinforced plastic are offered in three colors: natural, grey and white. Mortar is applied to the wall and stones are pushed into place. / Kalwall Corp.

345 EPOXY COATINGS / Made of 100 per cent solids, these coatings are said to protect and decorate dry and underwater surfaces, creating a tile-like finish. Decorator colors are offered and the product is USDA-approved for food plants. / Sika Chemical Corp. A*



348



349



350

346 TEXTURED WALL COVER / *Erana-Plast* is a blend of homogenized acrylic, polymer and modified aggregate materials which adhere to almost any interior or exterior surface with one application, according to the company. Waterproof and impervious, it comes in many colors. / North American Products, Inc.

347 FIREPROOFING / The *Structo-Gard* system of structural steel fireproofing is designed to replace sprayed fireproofing, an environmentally suspect method, according to the company. The fire-tested and UL-rated system consists of mineral fiberboard which is applied to steel with a stud welding gun. / Johns-Manville.

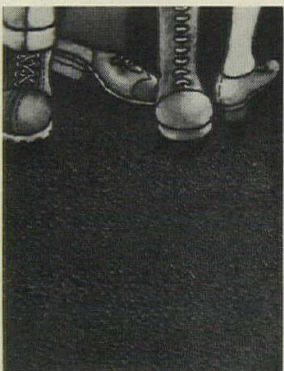

351

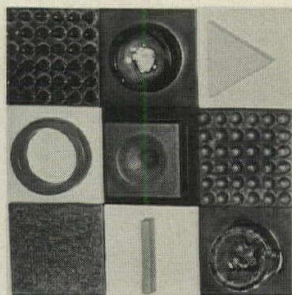

352



353

348 HEAVY-DUTY SEALER / A rubberized extra-heavy duty sealer for high traffic areas of concrete pavements and parking decks, the product prevents absorption of moisture and dripping through to lower areas. Provides a skid-proof surface. / Maintenance, Inc. A*

349 BLACKTOP SEALER / Recommended for areas where freeze-thaw cycles are accelerated through use of salt, or other ice-melting chemicals, this product is said to seal in vital oils of the asphalt mix. Product protects against sun and gasoline. / Maintenance, Inc. A*

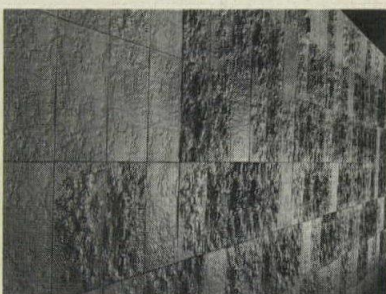

354



355



356

350 MASONRY COATING / This non-cementitious textured coating seals cracks and pores in concrete or masonry construction and is offered in 16 colors. Recommended for both interior and exterior use. / Standard Dry Wall Products, Inc. A*

SPECIAL FLOORING

351 NON-SKID FLOOR / The product, according to the company, fills the need for a low-cost, medium-grain, heavy-duty floor coating for use indoors or out. The product will apply to any surface, damp or dry, and resists many stains. Seven colors. / Falcon Safety Products, Inc.

TILE

352 TILE FACADE / Several designs have been added to this company's line of three-dimensional wall tiles, in earth shades or bright tones. / Progressive Designs, Inc.

353 GLAZED CERAMIC TILE / Sixteen colors are offered in this rectangular tile for floors and walls. A variety of sizes includes 3 by 6 in., 4 by 8 in., 4 by 9 in., and more. Colors are said to not fade and the tile needs no waxing or polishing. / Interpace Corp. A, D*

354 CERAMIC WALLS / Made to order in a range of natural clays, the 9 by 18-in. units can be finished in matte, glossy and metallic glazes and can be used in exterior and interior applications. / Design-Technics Ceramics Inc. A*

355 SEMI-VITREOUS TILE / *Earthstone* is a 1/2-in. glazed, hand-molded tile of natural, redburning shale, available in six shapes and colors. Recommended for interior residential and commercial wall and floor applications, the tile needs no waxing. / Florida Tile Div. of Sikes Corp. A*

356 CERAMIC TILE / Available in a 3 by 6-in. size featuring intense, bright colors with matte glaze finish, the tile is sold in 14 non-reflective and six designer colors, states the company. / Florida Tile Div. of Sikes Corp. A*

357 CERAMIC TILE / Floor and wall tile in 8 colors, and textures range in size from 2 1/2 by 10 in. to 12-in. square. Custom shapes are available also. Controlled variation from tile to tile produces a handcrafted look. Tiles can be used indoors or out. / Group Artec. D*

358 CERAMIC TILES / In 5-in. hexagon and 5 7/16-in. valencia shapes, these tiles are offered in 21 colors with a glaze the texture of crystallized sugar. Suitable for wall and floor use. Also available in other shapes. / American Olean Tile Co. A*

359 CERAMIC WALLS / Each job is produced to order, according to the company. The artist designs each 9 by 18-in. unit in many related textures, and the tiles are glazed in matte finish. The wall is then laid out and numbered. Each wall is an original work. / Design-Technics Ceramics Inc. A*

360 CERAMIC UNIT / *Swirling Squares* is a single 18-in. ceramic unit which, when installed butted closely with others, with no grout, seems to swell and recede. Shown are four units in taupe clay with gunmetal inlay; all walls are made to order and may be used indoors or out. / Design-Technics Ceramics Inc. A*

361 CERAMIC TILE / According to the company, this tile—while appearing to be ordinary—has improved properties for better coloration, with fewer shading problems. The tile is uniformly controlled for great strength and is said to have excellent cutting and nipping properties. / United States Ceramic Tile Co. A*

362 CEILING TILES / The 6-in. square gold design is imprinted on a soft white background with no-glare washable surface, according to the company. These noncombustible tiles have a UL Class I flame spread rating. A 12-in. square tile is also offered. / Simpson Timber Co.

363 CERAMIC TILE / For wall and floor use, the tile comes in four color combinations and in two shapes; 4 1/2 in. square and a Mediterranean-inspired shape. / Wenczel Tile Co.

364 CERAMIC TILE / Eight bright colors in five designs ranging from contemporary to traditional make up this collection of ceramic tiles. Each design is fired into the glaze rather than applied, so the surface will resist abrasion. / United States Ceramic Tile Co. A*

365 COLORED EPOXY GROUT / For tile or paver floors, the grout is available in seven standard colors (shown). The company claims the grouts possess excellent chemical resistance and physical properties. / Atlas Minerals & Chemicals Div., ESB Inc.

WALL COVERING

366 VINYL WALLCOVERING / The line of 54-in. wide wallcoverings is available in six patterns and a total of 76 colorways. With a clear *Tedlar* coating, the wallcovering requires little maintenance and resists stains, soil, mildew. / General Tire & Rubber Co.



357



358



359

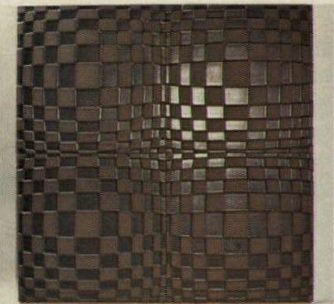

360

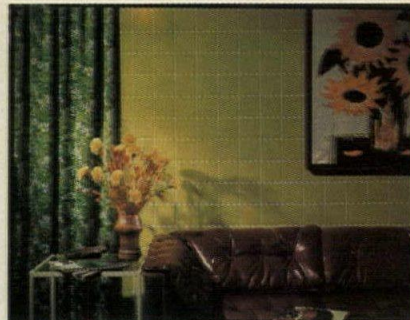

361

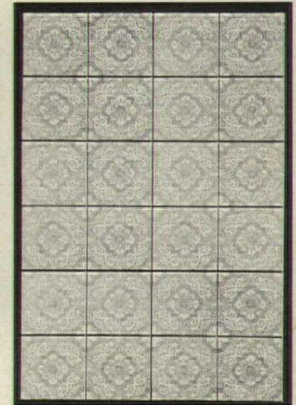

362



363



364

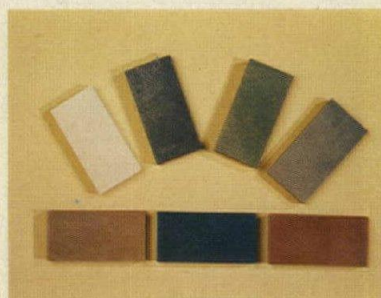

365

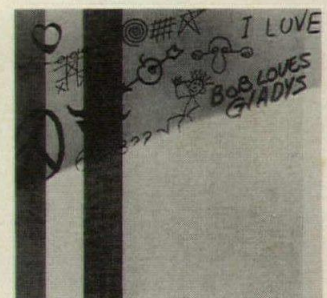

366



367



368

367 CERAMIC TILE / For floor and wall applications, the 6 by 3 by $\frac{7}{16}$ -in. tiles are offered in bright colors, with five dappled glazes. Trim pieces are available in surface bullnose and outside angles. / American Olean Tile Co.

368 BATHTUB WALL KIT / Cultured marble panels are offered in six colors, precut to fit around a standard 5-ft tub recess. The tile is said to resist stains. The marble is smooth finished and eliminates the grout lines of tile. / Acorn Marble Products Co.

this stain-resistant wallcovering comes in a variety of geometrics, damasks, scenics and soffits for residential use. Coordinated fabrics are available for 24 designs. / Imperial Wallcoverings.

374 WALL COVERINGS / Twenty-seven designs and 105 colorways are offered in this collection in vinyls, flocks and *Mylars*, pretrimmed, graveure-printed and fabric-backed. / James Seeman Studios, Inc.

375 PLASTIC SHEETS / For wall applications, *Noryl* sheet is said to resist chemicals and scuffing, and is offered in a wide range of grades and colors. / General Electric Co. A*

WOOD FLOORING

376 TEAK PARQUET / This wood's natural oils are said to make it exceptionally good for high traffic areas. It comes in the Haddon Hall pattern, prefinished in two shades of brown. Blocks measure 12-in. square by $\frac{5}{16}$ in. and are held together by cotton mesh. Can be installed over concrete, tile and wood sub-floors. / E. L. Bruce Co., Inc. L, D*

377 HARDWOOD PARQUET / Available in Thai teak and Asian Ironwood or a combination of both, this new pattern offers a variation of tones from light tawny to deep brown, and is recommended for areas of heavy traffic. Each pattern measures 10 $\frac{3}{4}$ in. square. / Bangkok Industries, Inc.

378 TEAK PARQUET / Also available in red and white oak, or black walnut, this parquet flooring is recommended for residential, institutional and commercial use. / Harris Mfg. Co. A, D*

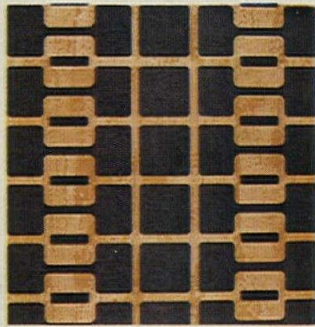

369

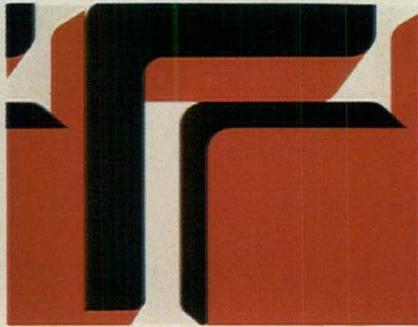

370

369 GEOMETRIC WALLPAPER / In acrylic-coated wallcoverings, this soft geometric look is offered with two colorways: blue and beige; orange and beige. Background and top colors

370 ACRYLIC WALLPAPER / A giant geometric with an inverted L and block motif, 21 in. wide, is part of a collection of the company's acrylic coated wallpapers. Available in two colorways: brown and silver; gray and silver. / Wall Trends, Inc.



371

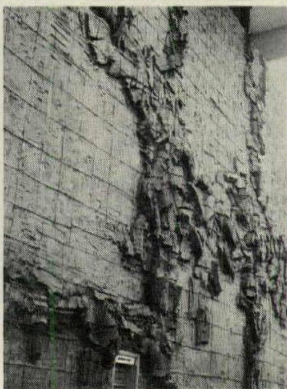

372

371 GEOMETRIC WALLS / This wallcovering is offered in 11 designs, screened on a variety of grounds including paper, vinyl and foils. / The Jack Denst Designs, Inc.

372 SCULPTURED CERAMICS / Wall murals 4 by 8 ft and individually sculptured in 24-in. square units can be supplied for specific projects, to required dimensions. A special blend of high and low fire clays has been developed for interior and exterior use, with units installed as masonry with ungrouted joints. / Forms & Surfaces.

373 VINYL WALLCLOTH / Prepaste and offered with a vinyl surface,



373



374

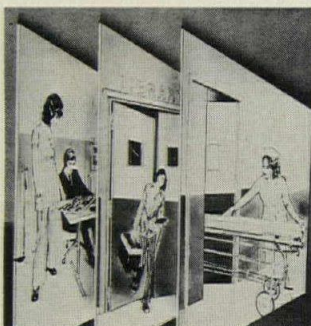

375



376

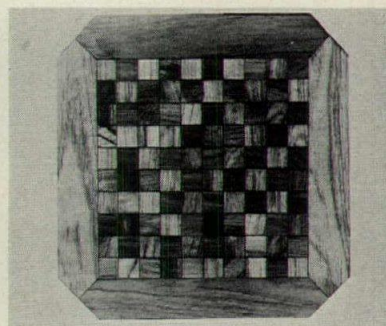

377

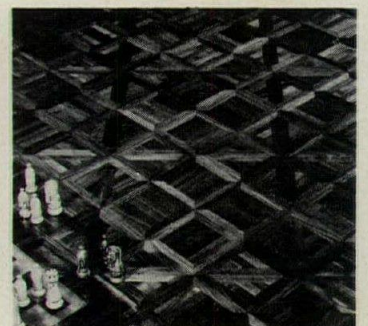

378

Ford revisited 8 years later!

Pioneer carpet glue-down installation with Jute backing unqualified success



In 1965, Ford Motor Company cemented double Jute-backed carpet to concrete subflooring in their new Ford Motor Credit Company building in Dearborn. No separate padding, no attached cushion. Gained were carpet's acoustic, aesthetic, thermal and easy maintenance advantages. "Bonuses" were lower initial cost, protection for seams, easy mobility for cart wheels and secretarial chair casters without floor pads. Ford office planning personnel report all anticipated benefits realized, with no problems evident. They give much credit to the double Jute backing, which has held fast to the floor and at seams through heavy traffic and rigorous maintenance. Not even chair casters riding 8 years in the same paths daunted the Jute backing!

- Jute's mesh weave and fibrous composition absorb and retain adhesive, for secure bond.
- When carpet is rolled out, some floor adhesive penetrates Jute to the primary backing, for greater tuft bind and delamination protection.
- Jute, over twice as thick as other no-pad backings, prevents cracks in old flooring from being felt or outlined.
- Jute doubles seam sealing area.
- Jute's dimensional stability is essential for floor cut-outs.
- Jute backing facilitates clean carpet removal, intact for re-installation.
- Jute works with all standard multi-purpose and release adhesives.
- Jute helps qualified carpets meet fire codes.

WRITE FOR ARCHITECTURAL GUIDE SPECIFICATION AND CASE HISTORIES

JUTE CARPET BACKING COUNCIL • 25 Broadway • New York, NY 10004

American Industries, Inc. • Bemis Co., Inc. • BMT Commodity Corp. • C. G. Trading Corp. • Cosmic International, Inc. • Delca International Corp. • Dennard & Pritchard Co., Ltd. • A. de Swaan, Inc. • Robert F. Fitzpatrick & Co. • Gillespie & Co. of N. Y., Inc. • Guthrie Industries, Inc. • Hanson & Orth, Inc. • O. G. Innes Corp. • Jute Industries Div., Sidlaw Industries, Ltd. • Lou Meltzer Co. • William E. Peck & Co. of N. Y., Inc. • R. L. Pritchard & Co. • Revonah Spinning Mills • Stein, Hall & Co., Inc. • White Lamb Finlay Inc. • Willcox Enterprises, Inc. • WLF Inc.

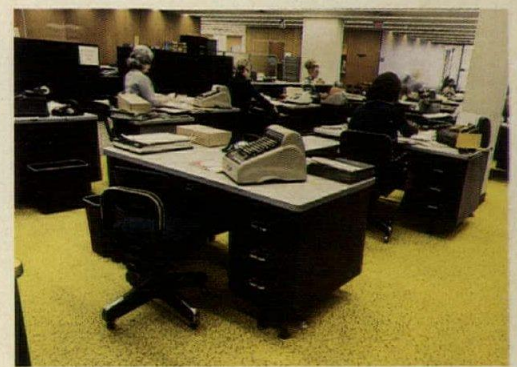
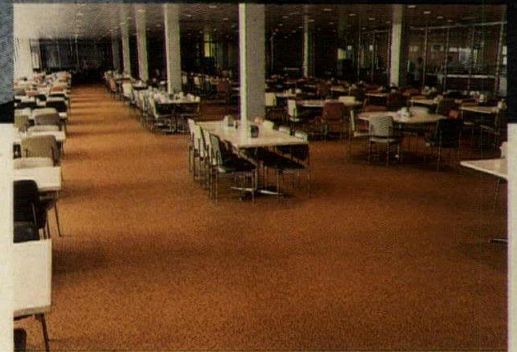

Top — double Jute-backed carpet in below-grade computer center, 8 years later. • **Middle** — carpet in below-grade cafeteria, 8 years later. With double Jute backing, remained intact through a flood without mildew, shrinkage. • **Bottom** — double Jute backing helps resist casters 8 years.

The Holophane Designer Ceiling System.™

Elegant design. Superb engineering.
Advanced lighting options.

Now one ceiling system offers you all three.

THE HOLOPHANE DESIGNER CEILING SYSTEM opens up the full potential of suspended ceilings. It's the first to integrate all the important benefits of ceiling systems, and give you the design flexibility you need to create the ceiling you want.

Elegant design. Our contemporary 5'x5' module offers you a choice of dramatic pyramidal shape or the clean, open look of a totally seamless, flat square.

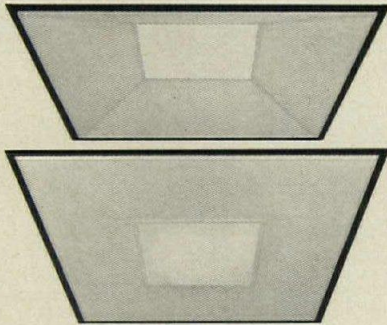

Pyramidal and seamless flat modules.

There are several acoustical panel surface textures to choose from. And for further design freedom, both modules accept many different luminaire sizes and shapes, with a variety of clear and subtly tinted lenses.

Superb engineering. We designed our system to go up in minimum time. At minimum cost. The easy-to-assemble SNAP-TRACK™ runners, for example, greatly reduce the number of man-hours it takes to get the job done.

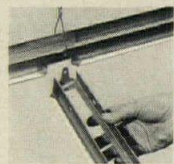

Snap-Track runners join without tools.

Slots along the center of the runners make it possible to conceal air handling boots anywhere on the 5'x5' grid. These runners also mate with moveable partitions, giving the designer great flexibility in organizing work space.

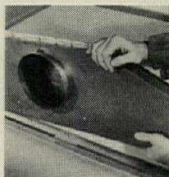

Standard air boot slips into runner effortlessly.

Advanced lighting options. Now for the big news about the system—a range of luminaires and lenses that offers you real lighting flexibility.

For example, there's our H.I.D. (High Intensity Discharge) luminaire, MERCULUME™, the preferred, modern choice. Holophane engineers have tamed the powerful mercury and metal halide light sources and made them as comfortable as conventional fluorescents.

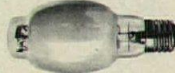

Now you can have H.I.D., too.

Which brings us to the REFRACTIVE GRID™ CONTROLENS®. You can use this remarkable new low-brightness lens with our H.I.D. or fluorescent luminaires to reduce high-angle brightness by as much as 70% as compared with conventional lenses—while actually increasing the amount of useful light.

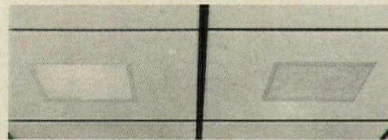

Conventional lens

Refractive Grid

If you've been using coffered modules to hide bright, conventional lenses, you can now use REFRACTIVE GRID with our economical seamless flat modules and achieve the same high level of visual comfort.

Our system also offers you PERCEPTA™, the revolutionary fluorescent luminaire that enables you to design offices, classrooms, and other working areas that are virtually free of veiling reflections (reflected glare).

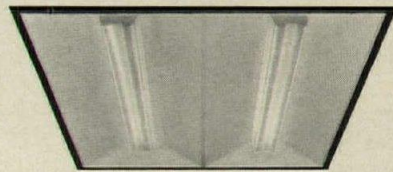

Percepta, for better seeing and energy conservation.

PERCEPTA makes printed tasks easier to read. And, surprisingly, it actually helps conserve energy and cut the electric bill, too.

Lighting options that give you real flexibility. Engineering that gets your ceiling up faster. Elegant styling designed to let you vary the mood.

Ask your local Holophane representative for all the details. Or write Dept. PR-74, Holophane Co., Inc., Montvale, N.J. 07645.

Holophane®
A Johns-Manville Company

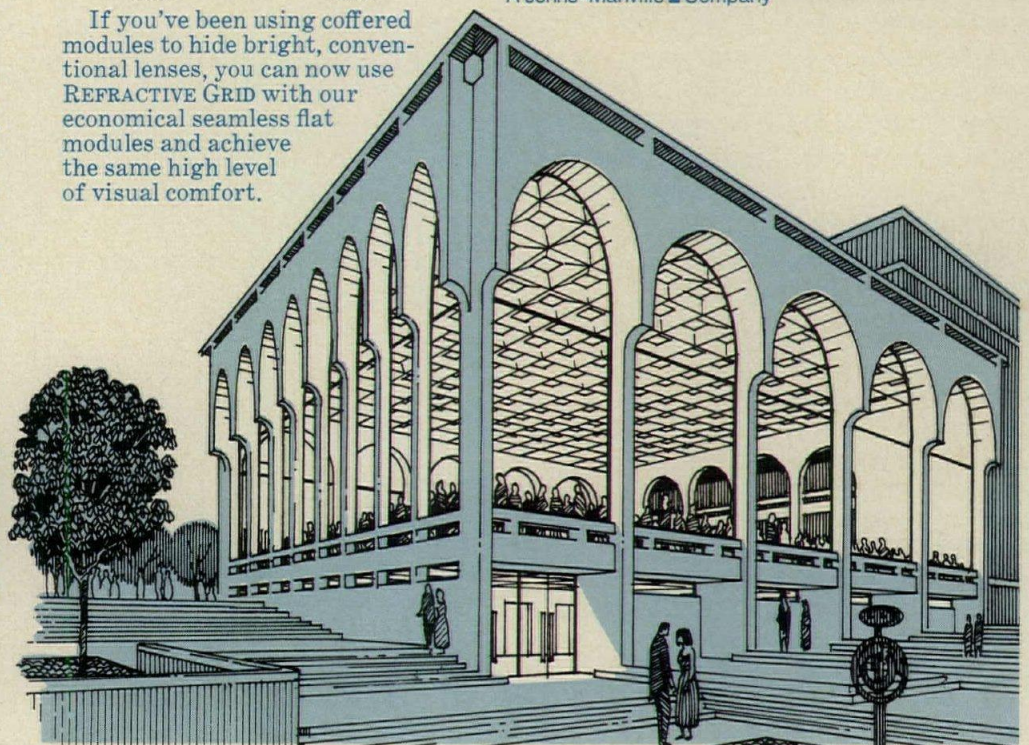

For more data, write A38 on inquiry card

you can Bank on

Karastan[®]
AMERICA'S FINEST POWER-LOOMED RUG

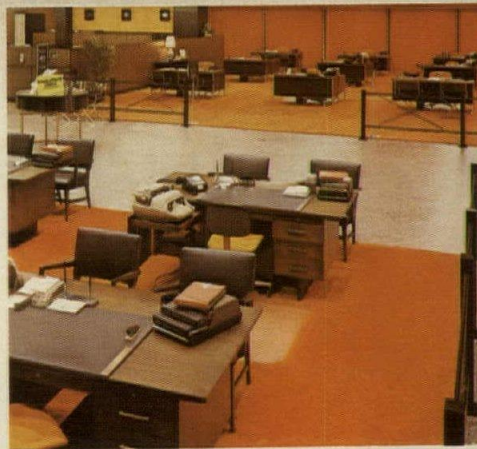

Bank of Santa Monica,
Santa Monica, Calif.

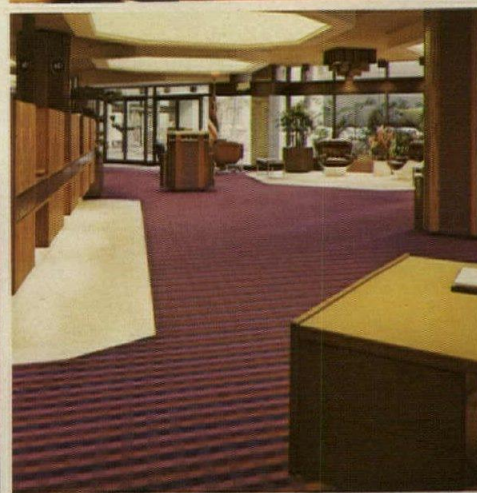

Bank of Honolulu,
Honolulu, Hawaii



United National Bank of Dadeland, Miami, Fla.

...the public carpet with the private look

Bank interiors enjoy a high interest rate from the public when they feature carpets by Karastan. There's a unique "de-institutionalized" private look of style, quality and quiet elegance that is so right for the lobby and offices areas of a bank or any other prestige public space. Karastan carpets and rugs can be seen today in some of the nation's most distinguished banks, hotels, offices and country clubs. America's buildings of distinction deserve the beauty and performance of Karastan.

- For additional information phone our National Contract Sales Manager in New York at (212) 980-3434

Karastan Rug Mills / A FIELDCREST COMPANY - 919 Third Ave., New York, N.Y. 10022

- Regional Sales Offices: Merchandise Mart, Chicago, Ill. 60654—Phone: (312) 527-2380
Western Merchandise Mart, San Francisco, Calif. 94103—Phone: (415) UN 3-0200

For more data, write A39 on inquiry card

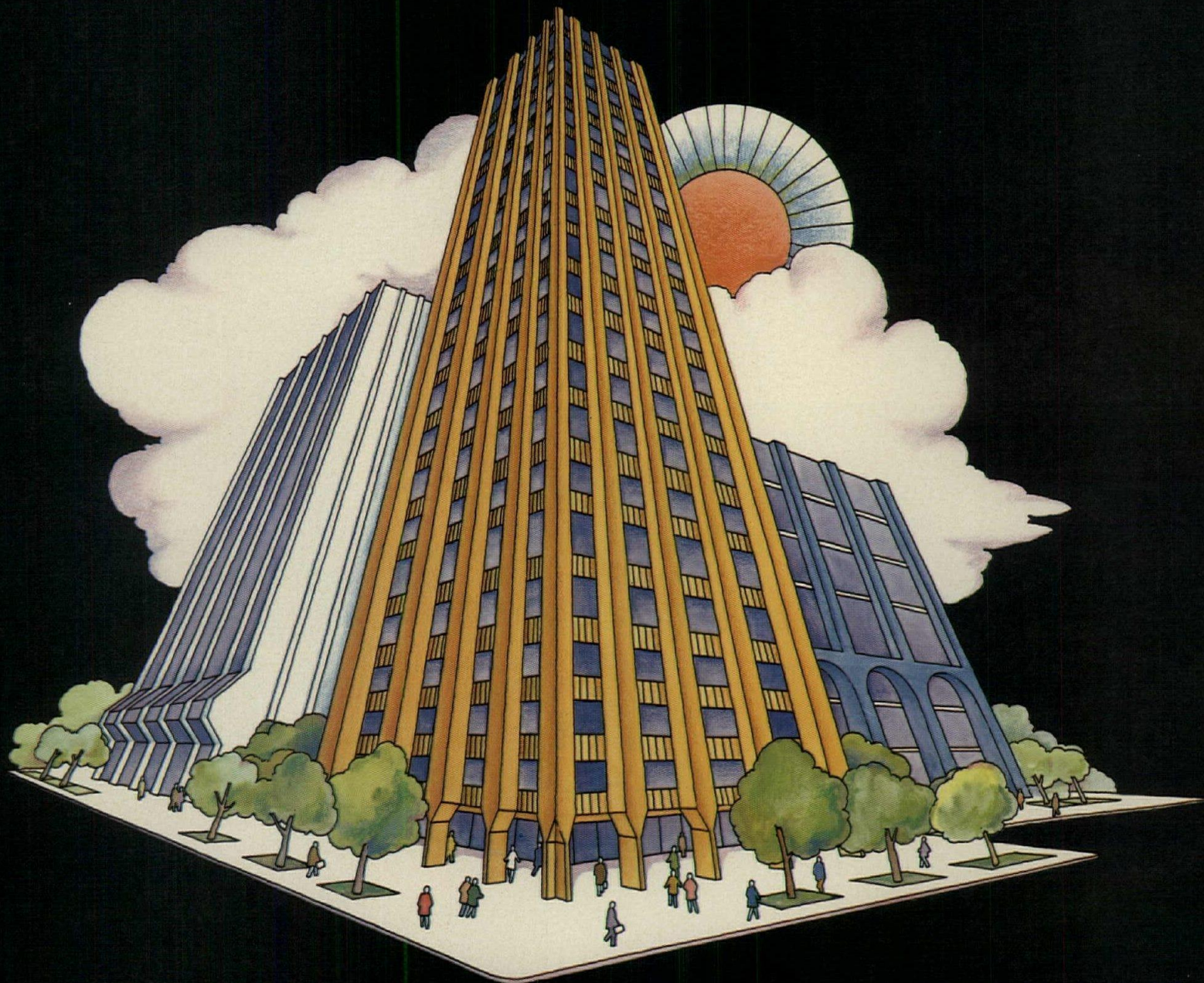

Bold, contemporary hi-rises need a bold, contemporary finish.

Hi-rise metal buildings offer uniquely different finishing challenges. DeSoto answers the challenge with uniquely different Fluropon!

More colors Fluropon offers more than the standard amber-bronze family colors. Fluropon means bright whites, brilliant blues, gregarious golds, and gorgeous garnets that hold their "like-new" freshness.

More color consistency Fluropon gives batch-to-batch, year-to-year color consistency. No inconsistency in intensity . . . ends worry about color parameters of acceptability. Fluropon® offers a "dead-on" match. Curtain walls can have and hold a total unit look that makes for high dramatic impact. Fluropon's color match and durability means damaged panels can be replaced and not show "old" and "new."

More color intensity Fluropon's a full-strength fluorocarbon with long-life color retention. Virtually maintenance free. Non-static . . . rain washes away

dirt that could dull your high-rise construction's true colors.

Consider & compare Fluropon offers: • wide variety of colors • consistency in color and coating thickness • non-static • longer life expectancy • fewer production, on-site, or durability headaches.

Consider the cost, color, consistency and life expectancy . . . then consider the alternatives.

For hi-rise metal construction—buildings that weather weather better—you owe it to yourself, to them, to be bold, contemporary—to go Fluropon.

Write or call for our "Think Exciting Fluropon" color chart brochure:



DeSoto, Inc.

Chemical Coatings Division, 1700 South Mt. Prospect Road
Des Plaines, Illinois 60018 (312) 296-6611

When a job calls for beautiful, textured doors with better durability than wood . . .

Next to the three prefinished embossed hardboard door facings in the Legacy Series from Masonite Corporation, any other door facing is out of its depth.

No flat surface door with a mere grain finish has the deep-textured feeling of Legacy or its deep-rooted durability.

Legacy comes closer to nature than competitively priced doors. The texture is embossed into the substrate before the durable finish is applied. It won't scratch off. The total effect mirrors that of an actual wooden planked surface, each plank with

its own personality.

Mar-resistant Legacy won't split, splinter, crack or check. It can be easily repaired on site in event of damage. Legacy's high dimensional stability and great structural strength make it suitable for use with both solid and hollow core doors.

And the price is right.

Want the names of some quality door manufacturers currently using Legacy? Write Masonite Corporation, 29 North Wacker Drive, Chicago, Illinois 60606.

Legacy and Masonite are trademarks of Masonite Corporation.

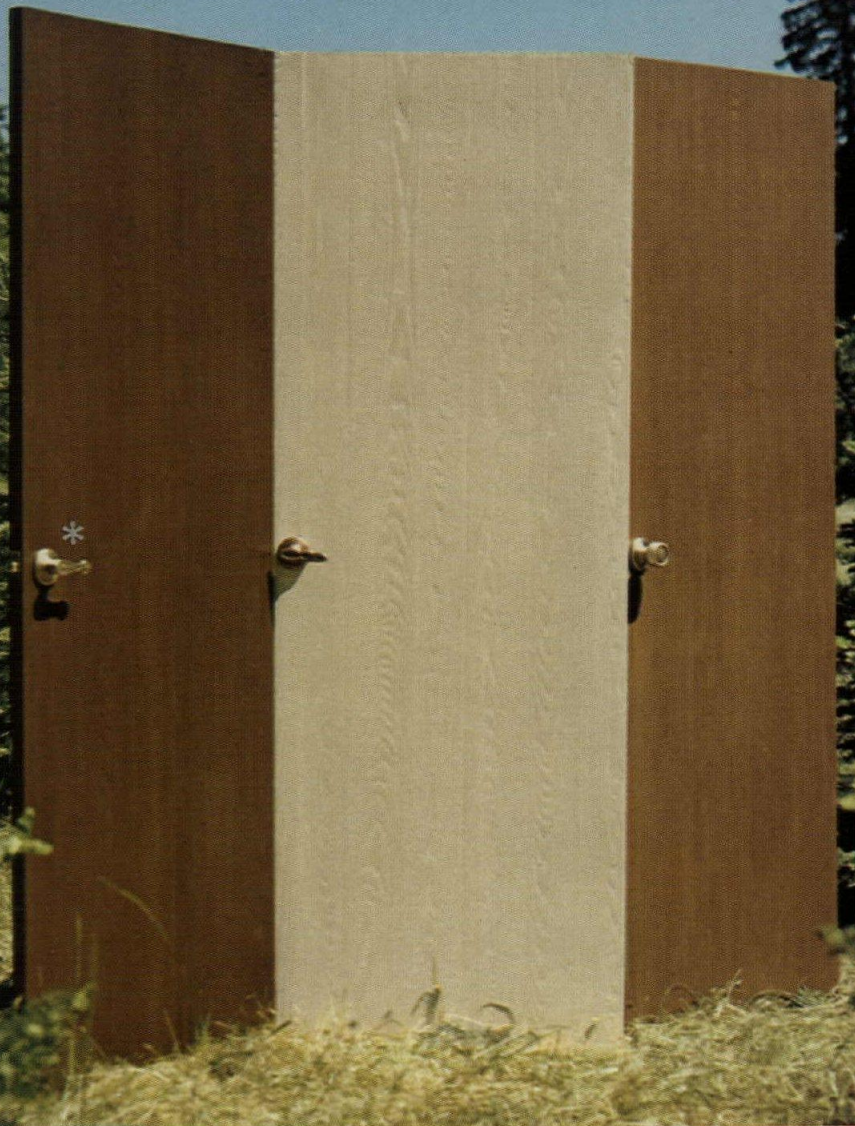

Legacy series of embossed hardboard door facings: Walnut tone, New White and Oak tone.

*Locksets by Kwikset®.

**...Legacy™
stands alone.**

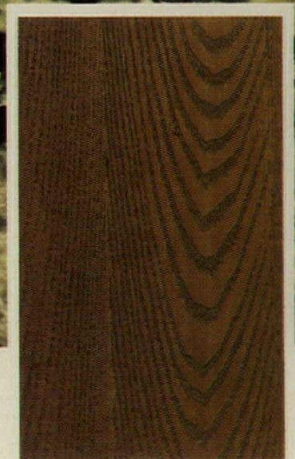

The closer you get
the better Legacy looks.

For more data, write A41 on inquiry card.

ARCHITECTURAL RECORD

A MCGRAW-HILL PUBLICATION

PRESENTS

**... a special two-day
conference
examining the
exciting profit
opportunities
available in this
new vista**

How the Architect and Engineer can Profit as a Builder/Developer

All over the United States, pioneering architects and engineers are starting to capitalize on their expanding opportunities in development building. In doing so, they are entering new areas of profitability. These opportunities bring with them involvement in a whole range of problems with which the professional practitioner has had little or no previous experience. Now, for the first time, Architectural Record has developed a special conference designed to help cope with these problems and to take full advantage of emerging opportunities.

The faculty for these conferences includes not only successful architect/engineers-developers but attorneys, CPA's, mortgage bankers, contractors, marketing experts and brokers as well.

DECEMBER 13-14—NEW YORK / JANUARY 14-15—SAN FRANCISCO / FEBRUARY 14-15—CHICAGO

Conference Highlights

- Feasibility Studies—how to determine the potential marketability and profitability of a project
- Land acquisition—how to choose the right land—how to secure favorable zoning
- Project financing—an evaluation of the alternative methods of real estate financing—how to find the money
- Legal and ethical implications of the architects involvement in development building
- Professional liability
- How to organize for success and choose the kinds of partners you need
- Case studies in various building opportunities



Management Concepts International, Inc.

505 Park Avenue, New York, N. Y. 10022 • 212 759-5830

Please rush additional registration information on How the Architect and Engineer Can Profit as a Builder/Developer.

Name _____

Company _____

Address _____

City _____ State _____ Zip _____

Phone (A/C) _____ Number _____ Ext. _____



Trainable Mentally Retarded Center, Clark County School District, Las Vegas, Nevada. Architect: Moffett & McDaniel

The Pyrotex 100 Ceiling System increases ceiling design flexibility.

Pyrotex 100 is made specifically to eliminate the design restrictions imposed by ordinary ceiling panel dimensions. With lengths of up to 8', Pyrotex 100 panels provide much more flexibility in placement of lighting and ventilation troffers, while the 1' width allows instant accessibility to any part of the plenum.

Created to be used in conventional and semi-con-

cealed (one-directional) systems. Pyrotex 100 panels are kerfed and rabbeted on the long edges, with ends trimmed to lay on exposed system members. Pyrotex 100 has an AIMA Flame Spread rating of Class I (0-25 range) and provides excellent acoustical efficiency.

For more detailed information contact: Simpson Timber Company, 2000 Wash. Bldg., Seattle, WA 98101.

Simpson

For more data, write A42 on inquiry card



THE SUPER SEATS

DESIGNED FOR BEAUTY... BUILT FOR WEAR. BEMIS makes toilet seats you can specify with confidence, whether it's a heavy duty, solid plastic industrial seat or a high fashion decorator model. Available in 175 fixture matching colors or lustrous new solid plastic vivid colors, every BEMIS seat is made with the same careful attention to detail. All bumpers are generous size and color-matched to seat. Hinges and mounting posts are designed for extra strength and easy installation. In the BEMIS line you'll find sizes and models to fit every installation... regular and elongated... with open or closed front... and even special small bowl sizes. All value priced and shipped to suit your needs. Why not specify the seats that guarantee customer satisfaction? Write for the complete catalog or contact your BEMIS representative now.

BEMIS MANUFACTURING COMPANY
 Sheboygan Falls, Wisconsin 53085 Phone 414-467-4621

be seated by...



For more data, write A43 on inquiry card

No fuss is wanted from specialties by the architect. And largely, the manufacturers have caught the message and responded. The products displayed here have quick, sturdy and simple installation, and show a marked trend toward clean-lined, simple design that does not attempt to overdo the product's visual importance. This trend deserves to be encouraged, with perhaps the addition of a standard option of eliminating company names and symbols from finished surfaces.

Additional considerations for selection and use of specialty products should include some of the following:

- Type of support or fastening required;
- The level or location of fastening (at subfloor or finished floor; at rough wall or finished wall surface);
- Finish required at exposed fastenings;
- Should exposed fastenings be vandalproof;
- Should exposed fastenings be flat-head, counter sunk;
- Finish surfaces: shop primed, shop finish, etc.;
- What keying is required on keyed items;
- What treatment at joints;
- Should manufacturers identification be eliminated;
- At urinal screens: what supports and what finish for supports;
- At toilet partitions: what type of hardware (forged or cast brass, or bent metal and what finish);
- What accessories at chalkboards: trays, map rails, trim;
- What accessories at louvers: bird screen, insect screen;
- At lockers: are benches, closures or end pieces required;
- At access flooring: are cutoffs, floor grilles or ramps required;
- At access flooring: what choice between aluminum and steel panels;
- At access flooring: what finish floor material;
- At rolling partitions: has access to hangers for adjustment been provided;
- At rolling partitions: is locking required;
- At electric powered specialties such as automatic flagpoles, and motor-operated projection screens, chalkboards, and partitions; where are switches and controls to be located.

Specialties are a small but necessary part of the total building picture, but some taste and care in their selection, and some explicitness in their indication in contract documents will make for a more successful building.

Philip H. Seligson
Chief Specification Writer, Edward Larrabee Barnes, New York, New York

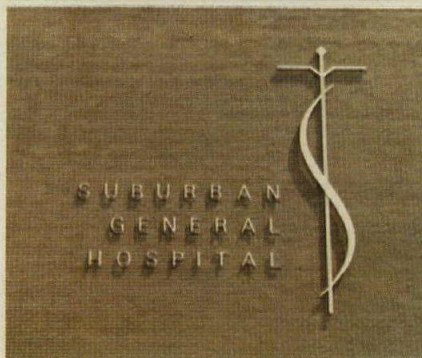
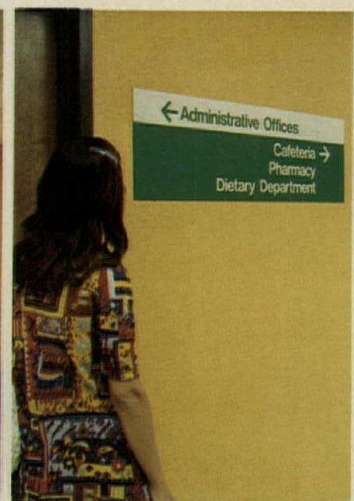
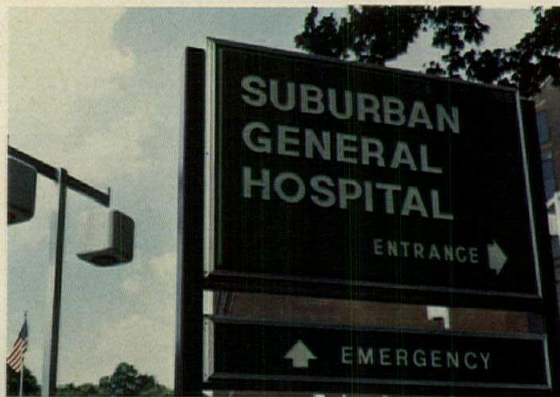
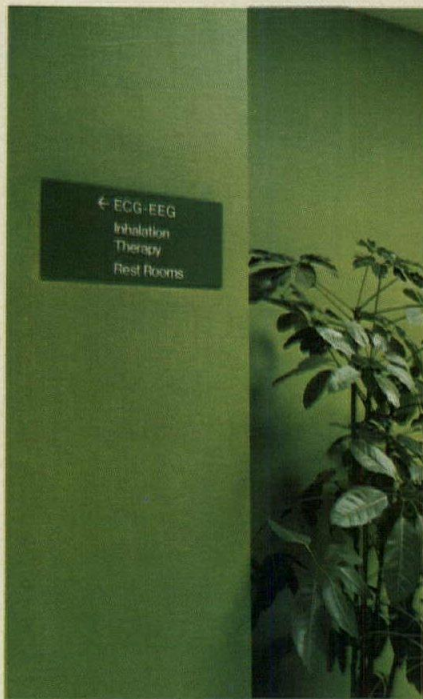

MATTHEWS IDENTIFICATION SYSTEMS:

Beautiful way to communicate, inside and out.

Matthews Identification Systems are designed to speak out clearly and impressively. They can announce, direct, describe, instruct, inform, urge, or influence. Indoors and out. From desk top to roof top. Reception room to board room. Throughout a building. Or a company.

Give every client a practical, total, visual communications program... with Matthews Identification Systems Carried out in materials, sizes, colors and styles to meet the most specific requirements for visibility, and durability and beauty. With a choice of 25 different styles of bronze and aluminum lettering. Plus handsome cast tablets and plaques, signs, and nameplates. Even exquisite limited-edition bronze sculpture.

On your next project, let Matthews Identification Systems work for you... and for your client. In the meantime, write for our catalog on Identification Systems.

JHM JAS. H. MATTHEWS & CO.
Identification Systems

1315 W. Liberty Ave., Pittsburgh, Pennsylvania 15226

Plants in PITTSBURGH, PENNSYLVANIA; SEARCY, ARKANSAS; MILTON, ONTARIO; SUN CITY, CALIFORNIA; SENECA FALLS, NEW YORK; EL MONTE, CALIFORNIA.

For more data, write A44 on inquiry card

CHALKBOARDS

385 LIQUID CHALK WRITING / A white writing surface on this model can be used as a projection screen in addition providing a surface for the company's liquid chalk in colors. Board is shown mounted on the company's room divider, featuring a parabolic lighting system. / Claridge Products and Equipment, Inc. D*

LOUVERS & VENTS

386 METAL LOUVERS / For industrial, commercial and institutional applications, the line includes fixed louvers, operating louvers, mechanical equipment enclosures and sun control louvers. The units are designed for installation into wood, masonry or metal and are offered in many colors and finishes. / Elwin G. Smith Div., Cyclops Corp.

387 HOME VENTILATING FANS / A line of bathroom ventilators, ceiling heaters and ventilator-light combinations feature cfm ratings from 50 to 110. All units operate at low sound levels according to the company. Grilles are of unbreakable plastic, in off-white. / Broan Mfg. Co. L*

388 FIRE-SMOKE VENT / A full range of sizes is offered in a line of fusible-dome fire vents. Heat from a fire causes the PVC dome to shrink out of its frame, fall through and permit the exhausting of heat. The dome gives 50 per cent diffused light transmission and is protected from weathering. Meets OSHA provisions. / A P C Corp. A*

389 FOUNDATION VENT / Made of molded polyethylene, the vent is said to be lightweight, easy to operate and unbreakable. It will not rust and is vermin-proof. Molded-in aluminum screen. / Ralide, Inc.

ACCESS FLOORING

390 LARGE ACCESS MODULE / A 30-in access floor system will permit large ductwork as well as electrical and telephone service. The company

claims this larger cell capacity will permit fast installation for enhanced economy. / Liskey Aluminum, Inc.

391 FLOOR FITTINGS / For access flooring, the company offers service fittings, ranging from a pedestal-mounted duplex to a flush-mounted combination duplex and telephone service box mounted directly to the panels for quick relocation. / Liskey Aluminum, Inc.

392 ACCESS FLOOR CARPET / A wide range of carpets for access flooring is available, made of the best face fibers, according to the company. Carpet is available with or without panel trim edge and is also offered in free-lay tiles for instant access. / Liskey Aluminum, Inc.

FIREPLACES

393 GAS FIREPLACE / The unit certified AGA for zero clearance installation, can be faced to any design specifications, according to the company. Venting is provided through a 4-in. flue pipe and a variable flame pattern can be achieved with the units. / American Fireplace Co.

394 FIREPLACE / This line of prefabricated fireplaces is said to be inexpensive and includes free-standing, built-in and no-chimney models, with a wide variety of gas logs for use with natural or LP gas. / Arkla Industries, Inc.

395 FRANKLIN FIREPLACE / This is a stove, fireplace and barbecue grill all in one. There is an adjustable swing-out grill for broiling, and the unit also features cast iron construction, with firebox of heavy steel plate to withstand cracking. A built-damper is offered. / United States Stove Co.

396 SELF-CLEAN FIREPLACE / Available in ten colors or black matte finish, the unit is offered in an 18- or 24-in. size and features almost 100 per cent combustion due to the glass enclosure that makes the unit burn very hot. / Malm Fireplaces, Inc.

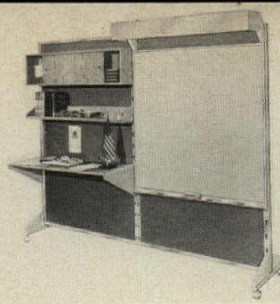

385

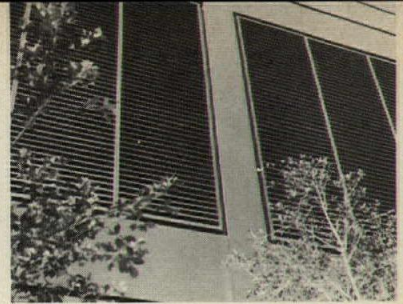

386

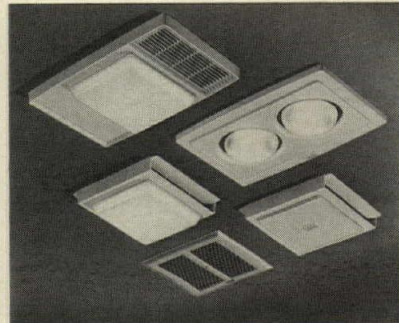

387

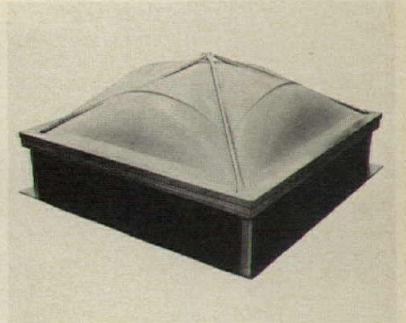

388

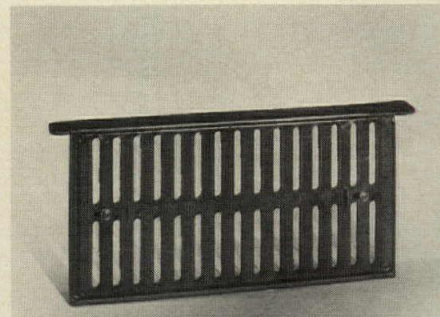

389

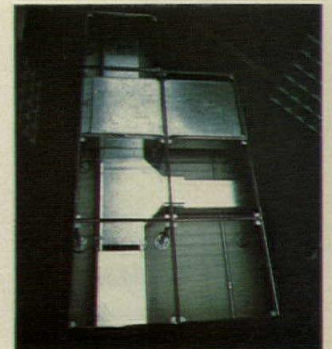

390

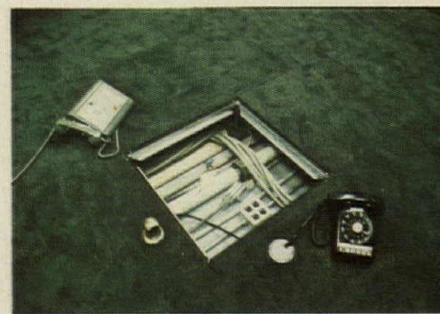

391



392

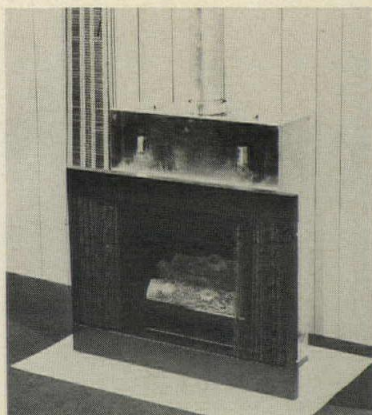

393



394



395



396

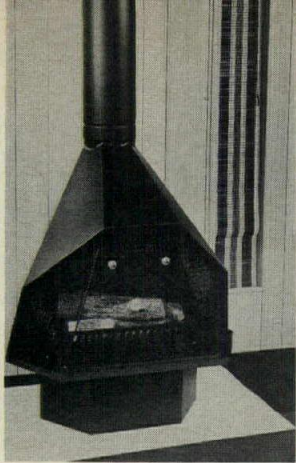

397

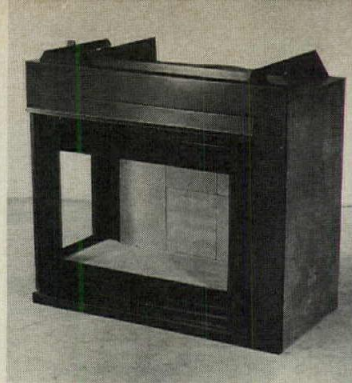

398

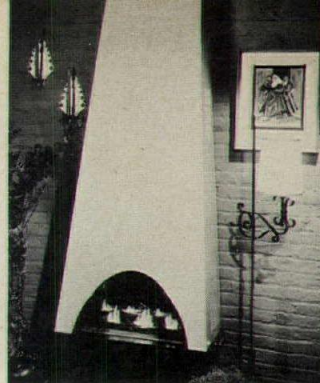

399



400

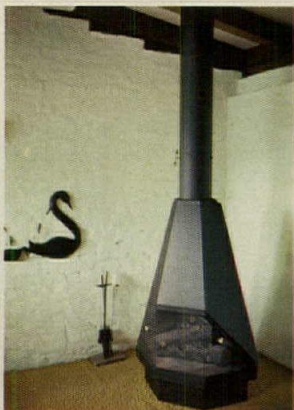

401



402



403

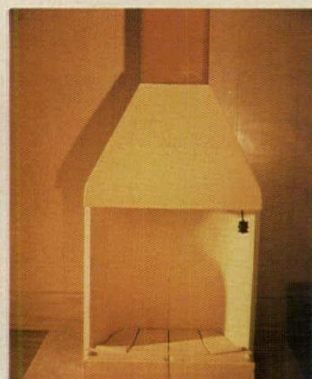

404



405

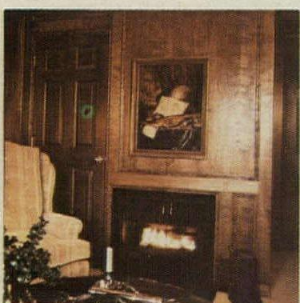

406

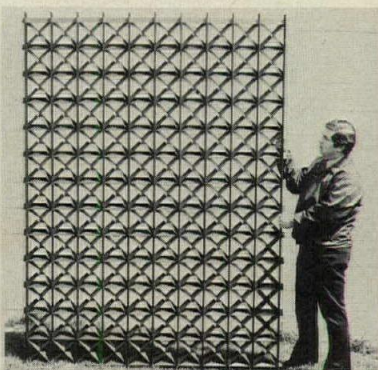

407

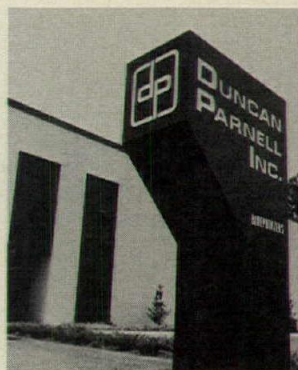

408



409



410



411

397 WOODBURNING FIREPLACE / A free-standing unit with hexagon design is offered with a 32- or 37-in. firebox. It is designed to burn wood, but can be converted to gas. Available in matte black or in four colors, according to the company. / American Fireplace Co.

398 BUILT-IN FIREPLACE / The unit will offer both right and left corner openings and comes equipped with a knock-out for a gas log or log lighter. Zero clearance is required for installation and chimney offset is permitted. Dimensions are 47 1/4 in. wide, 44 3/8 in. high, 24 in. deep. / Preway Inc. A, L*

399 GAS FIREPLACE / With space heating capacity of 55,000 Btuh input, the unit is thermostatically controlled. / Temco, Inc.

400 MARBLE FIREPLACE / According to the company, this cultured marble is impact and abrasion resistant. It is available in six standard colors and can be special ordered in custom colors with veining. / Acorn Marble Products Co. A*

401 WOOD BURNING FIREPLACE / The black satin finished fireplace is suited for corner installation and needs only 16 in. clearance from combustibles, according to the company. The hexagon-shaped unit has a 32-in. opening and is 33 in. high, 26 in. deep. / A. R. Wood Mfg. Co.

402 ELECTRIC FIREPLACE / Designed as a portable, this unit can be hung on any wall and requires no structural changes. Fits any ceiling height. A thermostatically-controlled fan circulates air from lower louver, through heating element and into the room. Unit may be painted any color and operates on 115-volt service. / Heatilator Div., Vega Industries, Inc. A, L*

403 CONTEMPORARY FRANKLIN / The unit measures 36 in. wide, 30 in. high and 21 in. deep and is totally insulated. A cast ceramic hearth with built-in ash stop is featured, along with a choice of five porcelain colors for the cabinet. The unit comes complete for 8-ft. ceilings; can be equipped for gas. / Martin Stamping & Stove Co. L*

404 BRICK FIREPLACE / Simple, fast erection is claimed for this system that consists of a one-piece backbrick, one-piece smoke chamber with built-in damper, and the base bricks. The smoke-free fireplace can be built in ten minutes and gives a refractory brick unit, according to the company. Any color can be supplied, and three sizes are offered. / National Refractories, Ltd.

405 FIREPLACE / The free-standing unit features heavy insulation and can be placed with zero clearance against combustibles, according to the com-

pany. It burns a variety of fuels and is offered in a range of styles, sizes, colors and trims. UL-listed. / Viking Universal Co.

406 GAS-FIRED FIREPLACE / This large-size unit, with 2100-Btu input, measures 42 in. across its front opening and installs in minimum depth, according to the company. The gas supply may be plumbed through the floor, side or back to the factory-installed control valve. / The Majestic Co.

GRILLES & SCREENS

407 GRILLE / Called *Myriad XXX*, the product features cells in varied sizes, with either a zero-degree or 45-degree slope. Sixteen C/S Kynar 500 colors are offered with a 20-year guarantee. Recommended for building re-facing and screening. / Construction Specialties Inc. A*

IDENTIFYING DEVICES

408 SIGNAGE SYSTEMS / A completely interchangeable system allows the architect to use any panel system, any extruded aluminum framing system and any mounting system of the company in whatever combination he chooses. / Andco Industries Corp. A*

409 SYMBOLIC GRAPHICS / Designed by Paul Arthur, several hundred designs for industry, airports and many other types of buildings are available in fiberglass tile or elastomeric film. A series in line with OSHA requirements. / Architectural Graphics Inc.

410 INFORMATION CUBE / This is a low level or medium level luminaire with interchangeable panels that provide the message. Cast aluminum construction and *Lexan* panels resist vandalism, according to the company. / ElSCO Industries.

411 SIGNAGE / Integrated signage for offices and institutions is now offered by the company, in a simple peel-off system of lettering. Plaques in five sizes come in a choice of seven colors and are made of polystyrene. Hardware varieties permit mounting in numerous ways. Type style is Helvetica Medium. / Herman Miller, Inc.

412 GRAPHICS MONOLITHS / Modular systems have been developed to cover a variety of sizes, depths, colors, textures, lettering and mounting devices for architectural graphics. Custom designs can also be produced. Illumination can be exterior or internal fluorescent. / Architectural Graphics Inc.

413 HIGH INTENSITY SIGN / For drive-in banks, the sign is said to be legible in bright sunlight. Changes to "Open" or "Closed" message on the same sign, with alternate message

being totally blanked out. Weather-proof stainless steel construction is featured. / Elec-Tro-TeC, Inc.

414 CLOCK-DIRECTIONAL SIGN / With digital clocks, one- or two-faced, the signs are custom sized, with arrows light in color and copy in white. Framed polished chrome and other finishes. Standard clocks are used. / Copley Mfg. Co.

415 SYSTEMS SIGNAGE / A complete range of signage products and broad areas of expertise from design to manufacture are claimed by the company, which coordinates size, design, color and finish to create graphics. / Jas. H. Matthews & Co. A*

LOCKERS

416 EXPANDED METAL LOCKERS / A complete line, including team lockers is available in a choice of 18 colors. Single, double, triple and multiple tier lockers are offered in a range of sizes, with no protrusions to cause injury. / Lyon Metal Products, Inc. A*

417 STEEL LOCKERS / Called the *Quiet Locker*, these units have been proven in tests extremely quiet according to the company. A special closing mechanism, and insulated louverless door (perimeter ventilation) stops metal clang. Units are made of high-grade domestic steel, with 20-gauge bottom. Available in all sizes. / Interior Steel Equipment Co. A*

PEST CONTROL

418 INSECT EXTERMINATOR / Meeting OSHA standards and recommended for food processing areas, this insect electrocuting unit is UL-listed and provides control of flying pests, according to the company. Safe operation is claimed. / Gardner Mfg. Co.

POSTAL SPECIALTIES

419 ENVELOPE DEPOSIT / For after-hours use by department stores, financial institutions, etc., this unit can take envelopes measuring 6 in. wide and 5/8 in. thick, sending them to a safe inside the building. The steel unit can be installed in either through-the-wall or in-the-wall configurations. / Security Corp.

420 CENTRALIZED MAIL / In high-rise structures, the carrier does not have to leave mail at each floor. Rather, he deposits it in large parcel lockers, enabling the tenant to retrieve all his mail at one time. / American Locker Co., Inc.

421 MAIL BOXES / The pedestal-mounted units contain 18 individually locked compartments and weather-proof doors are made of solid extruded aluminum with concealed security hinges. Clear anodized finish. / American Device Mfg. Co. A*



412



413



414



415

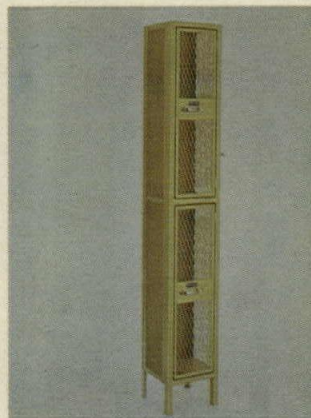

416



417

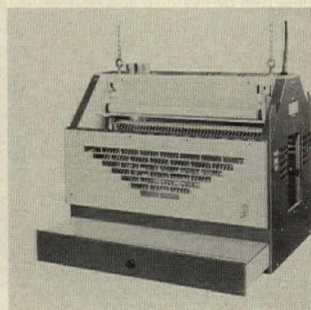

418

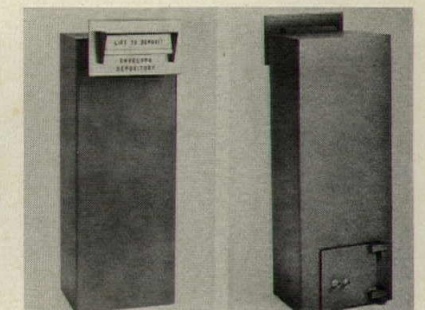

419



420

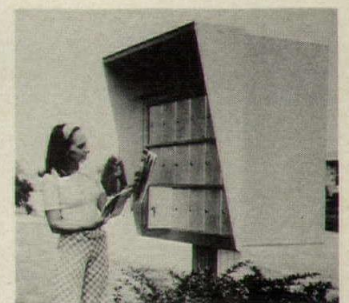

421



422



423

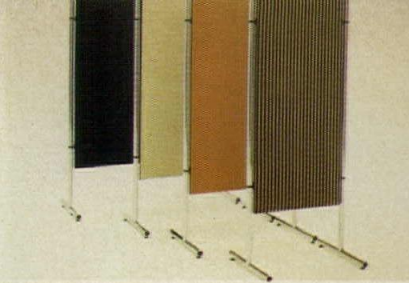

424



425



426

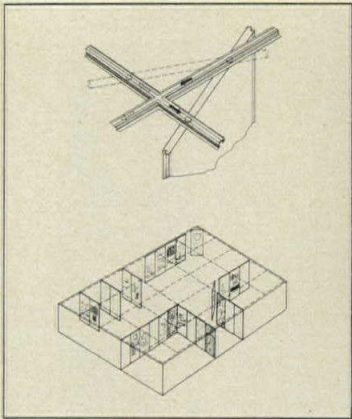

427



428

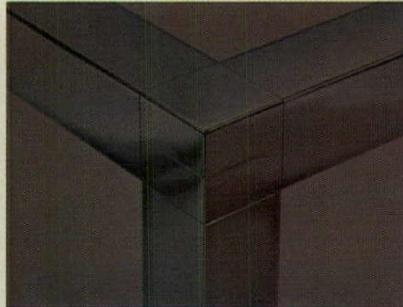

429



430



431



432

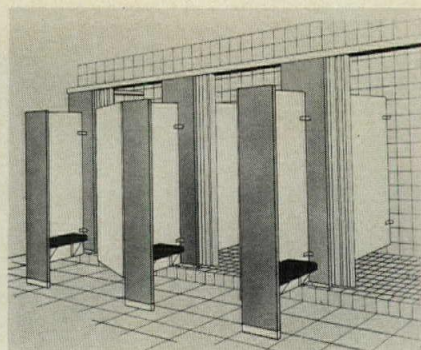

433



434

PARTITIONS

422 SPACE DIVIDER / The *Add-a-Panel* system is portable and recommended for learning or office areas in an open plan. Supported by heavy-gauge extruded aluminum posts, the boards are covered in cork-like fabric in a variety of colors. Panel wings are available in heights of 4½ and 6 ft, and widths up to 48 in. / Claridge Products and Equipment, Inc. D*

423 PARTITIONS / This low rail movable partition can be installed over carpet or tile and is self-supporting with no permanent floor connections. Factory fabricated to fit any layout and finished with vinyl films. / Vaughan Walls, Inc.

424 ACOUSTICAL SCREENS / The free-standing units feature panels suspended from 60-in. chrome plated tubular steel posts on legs. Panel widths are offered up to 48 in., and available in the company's fabrics. / Herman Miller, Inc.

425 OFFICE SCREENING / Utilizing tubing and connectors, this office partition system has a very low cost per person, according to the company. / Structural Concepts Corp.

426 ACOUSTICAL WALL / *Audio-Wall 15M* features outer panels of roll-formed steel, hinged with steel connectors to create wall-to-wall metal. System provides sound privacy with a sound transmission class (STC) of 44, according to the company. Vinyl surfacing in woodgrains and colors is offered. / Modernfold. A*

427 OPERABLE WALL PANELS / The *Moduflex 4801* wall panels are carried on discs in overhead track to any point in an open plan, one at a time, according to the company. Panels can be placed flat or at 45 or 90 degree angles to create complete walls or screens. Panels are offered in full height chalk and tackable surfaces, in wood and vinyl. The 2½-in. thick panels are nominally 48 in. wide. / Panelfold Doors Inc. A,D*

SPECIALTY MODULES

428 MODULAR SERVICE WALL / A fully recessed modular service wall system that can be integrated with any building decor includes drinking fountains, fire equipment, clocks, direc-

atories, waste receptacles and other equipment. The 18 by 31¼-in. panels are available in stainless steel, bronzetone stainless or baked-on enamel colors. / Halsey Taylor Div., King-Seely Thermos Co. A*

429 DISPLAY SYSTEM / For stores, the chrome tubing system that is 2 in. square is joined by a special locking device, according to the company. / Kason Hardware Corp.

STORAGE SHELVING

430 STORAGE RACK / A heavy-duty storage rack designed in high-yield steel is said to accommodate both pallet and bulk storage, and loads up to 30,000 lbs per upright frame, and 7,552 lbs per 4½ in., two-piece beam. To assure stability, post have slanted locking devices. / Penco Products Inc.

431 STEEL-ROD SHELVING / The system of heavy-gauge steel grillwork is coated with a smooth permanent white vinyl, according to the company. A variety of shelving needs can be met with the system. / Closet Maid Corp. A, L*

TOILET & BATH ACCESSORIES

432 UNITIZED BATH/SHOWER / Called *Versa-Bath*, the unit consists of a bathing section and three walls with acrylic finish. Construction includes acoustical foam and fiberglass reinforcing. Unit installs in a standard 5-ft. alcove. Four colors and white are offered. / Borg-Warner Plumbing Products. D*

433 PLASTIC SHOWER DIVIDERS / These laminated plastic dividers are ½ in. thick with 1-in. thick pilasters. The headrail connecting pilasters has a concealed track with hooks for shower curtains. All hardware is concealed and made of stainless steel. / Bobrick Washroom Equipment, Inc.

434 BATH CABINET / Finished in gold, the cabinet has two adjustable glass shelves, and the recessed model fits a rough opening 14 by 18 in. / Nutone, Div. of Scovill. A*

435 SPRAY BATH SYSTEM / Available in 20 and 40 gal. sizes, the system delivers a jet of cleansing liquid in group showers, eliminating bars of soap. Fifty persons per minute can be served by the 40-gal. size unit. / Huntington Laboratories, Inc.

436 MIRROR-SHELF / The combination soap dispenser, shelf and mirror is fully assembled in stainless steel and measures 20 by 26 in. One or two soap dispensers can be supplied, each with a ⅝-gal. capacity. / American Dispenser Co., Inc. A*

437 RECESSED WALL URN / For recessing in wall openings 3 in. deep, the flush front design has a large capacity receptacle and measures 12 in. wide by 9½ in. high. Constructed of stainless steel in one piece; no mitered corners. Cabinet door pivots at top. / Bobrick Washroom Equipment, Inc. A*

438 RECESSED PAPER TOWEL / For recessing in 4-in. walls, the compact design will fit in a wall opening 11¼ in. wide by 15¾ in. high. Exposed surfaces are 22 gauge stainless steel, with satin finish. / Bobrick Washroom Equipment, Inc. A*

439 BATH CABINET / The cabinet and fixtures come with a durable black finish highlighted with chrome strips. The four-light wall bracket is 17 in. high and 14¼ in. wide. The cabinet measures 20½ by 26½ in. and features ¼-in. plate glass mirror. / Thomas Industries Inc.

440 DUAL ROLL DISPENSER / Constructed of satin-finished stainless steel, the dispenser features wrap-around design, eliminating edges and seams at corners. After the first roll is exhausted, the second is automatically placed in use by a lever. / The Charles Parker Co.

WALL & CORNER GUARDS

441 BUMPER RAIL / This bumper guard strip for hand rails protects rails and walls from hand carts, according to the company. The snap-in flexible PVC strip permits choice of colors to match decor and for safety visibility. Aluminum channel and brackets can be finished with paint or anodized. / Pawling Rubber Corp. A*

442 CORNER GUARDS / These corner bumper guards are all-rubber and feature tapered tops which fit snugly against the wall for a clean appearance. The high lustre finish makes maintenance easy, according to the company. Available in four colors. / Johnson Rubber Co. A*



435

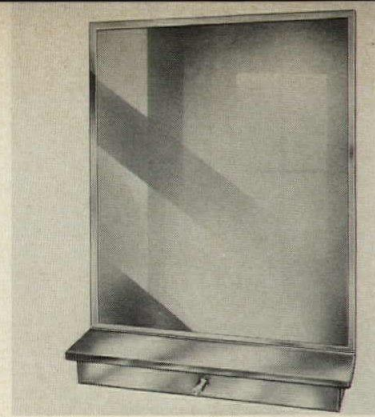

436

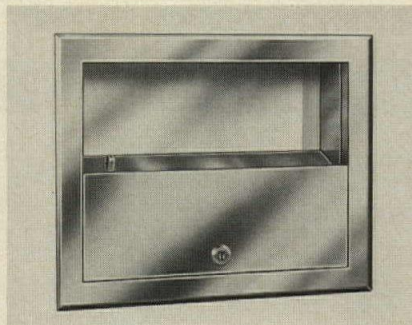

437

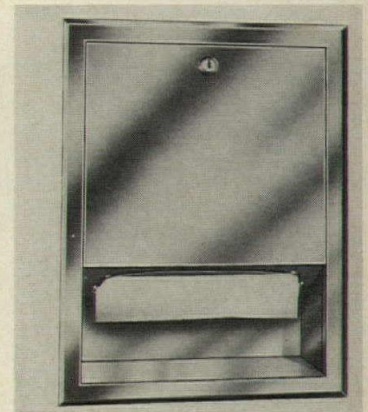

438

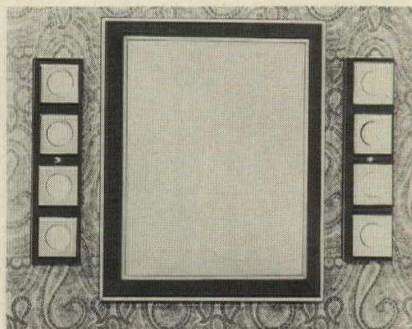

439

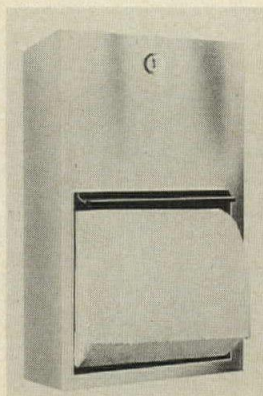

440

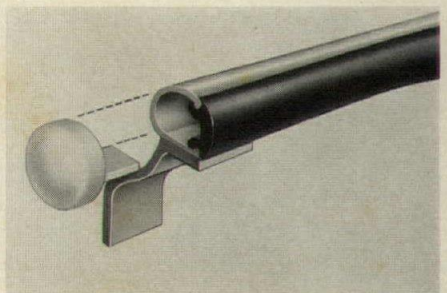

441

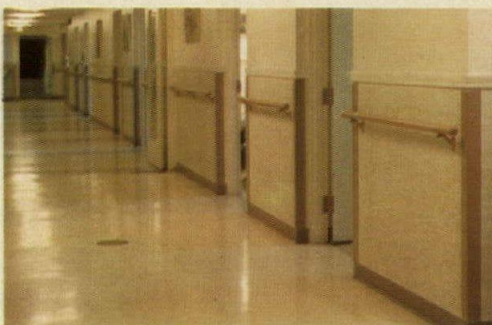

442



Downtown Shopper's Mall in Wilmington, North Carolina showing extruded aluminum Walkway Covers with Hardcoat Dark Bronze anodized Verti-Panel Fascia and Mansards and anodized aluminum Railings. Henry Von Oesen & Associates

**Imaginative
Solutions for '74**

CUSTOM DESIGNS WITH BURNS "STANDARD" EXTRUSIONS.

This attractive walkway utilized a standard Burns walkway cover of extruded anodized aluminum in combination with Burns extruded aluminum fascia. Rails are also Burns standard aluminum extrusions.

A single source of supply, Burns will assist in design, engineering, production of materials and furnish turnkey erection service.

Send for your "Imaginative Solutions For '74" walkway detail kit. It's free from Burns.

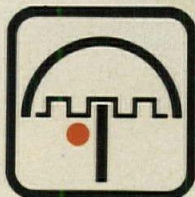

E. L. BURNS CO., INC.

**P. O. BOX 9166 SHREVEPORT, LOUISIANA 71109
PHONE 318 636-2722**

Vogel-Peterson gets the most out of your space...

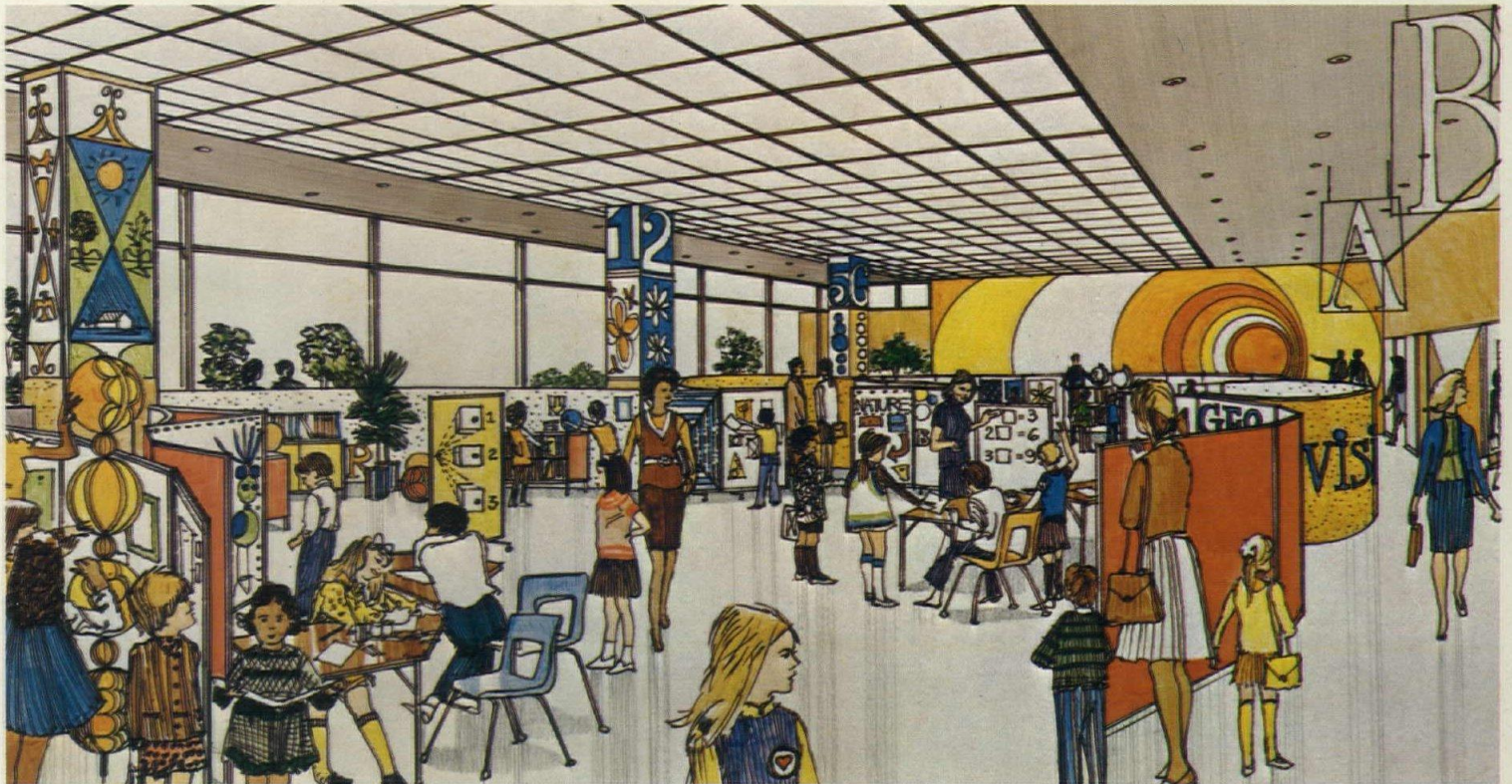

Vogel-Peterson installation at Educational Facilities Center, Chicago

even when you've got the least!

The open-plan concept in schools today is great. But, unfortunately, most of us have to work within a traditionally built classroom and over-crowded classes. That's where Vogel-Peterson can help. We've designed dozens of multi-purpose units that can divide work areas; act as a chalkboard, tackboard or film projection surface or accommodate neatly the coats, hats, books and belongings of as many as 32 kids — all in one unit! You'll just have to see our full-line brochure to appreciate it. Designed for the open-plan concept, but just great for yours.



Send FREE color catalog Also, have your rep contact me

Name _____

School _____ Phone _____

Address _____

City _____ State _____ Zip _____

VOGEL • PETERSON CO.

P.O. Box 90 • Dept. K-8 • Elmhurst, Ill. 60125

For more data, write A46 on inquiry card

Books from McGraw-Hill on today's architecture

SYMBOL SOURCEBOOK: An Authoritative Guide to International Graphic Symbols

By **HENRY DREYFUSS**. This handbook, compiled by the world's foremost industrial designer, is the first single reference to graphic symbols used internationally in business, industry, the sciences, and in all walks of life. Valuable in symbol identification, design, and standardization, the book includes symbols used in Architecture, Business, Communications, Engineering, Handling of Goods, Manufacturing, Mathematics, Physics, Safety, Traffic, many other fields.

320 pages, illustrated, \$28.50

MODEL BUILDING FOR ARCHITECTS AND ENGINEERS

By **JOHN TAYLOR, AIA**. This step-by-step working guide shows you how to build professional models of your architectural, engineering, and interior designs with *minimum effort and expense*. Photographs, drawings, diagrams, and plans demonstrate the steps to follow and the materials to use (including many new materials and synthetics.) It also shows how to represent a large number of traditional and contemporary building materials and effects.

160 pages, 185 illustrations, \$15.75

MANUAL OF BUILT-UP ROOF SYSTEMS

By **C. W. GRIFFIN** for the American Institute of Architects. This volume discusses in detail each of the built-up roofing components: structural deck, vapor barrier, thermal insulation, membrane (including the new elastomeric membrane materials), and flashing. It reports the latest views on vapor barriers and examines new roofing specifications using coated base sheets. Focusing primarily on conventional built-up, multiply, felt-and-bituminous roofs, the book consolidates much vital information in convenient form.

256 pages, illustrated, \$15.50

ARCHITECTURAL DELINEATION

A Photographic Approach to Presentation

By **ERNEST E. BURDEN**. This book shows you how to use photography—right at your drawing board, workbench, and in the field—to depict architectural projects in true perspective and to create an authentic relationship between proposed buildings and their surrounding environment. In easy-to-follow fashion, the author shows the actual workings of the photographic system and gives practical, proven solutions to every problem you might encounter.

288 pages, illustrated, \$18.50

JOINT VENTURES FOR ARCHITECTS AND ENGINEERS

By **DAVID R. DIBNER**. Written primarily for architects, engineers, and contractors, this book discusses the *do's* and *don'ts* of temporary partnerships (generally called joint ventures) which are undertaken by several firms who are, individually, too small to take on a particular project by themselves. The book describes the relationships involved in this type of organization and discusses the advantages (and pitfalls) of joint ventures.

192 pages, \$16.50

ENVIRONMENTAL ACOUSTICS

By **LESLIE L. DOELLE**. Created for professionals who are not experts in sound or noise control, this guide shows how everyday acoustic problems can be solved in practice. Keeping mathematics and physical details to a minimum, the book details simple, practical applications, with references to actual installations. The coverage ranges from basic principles and "how-to" information to follow-through procedures in actual construction.

288 pages, over 200 illustrations, \$18.50

ANATOMY OF A PARK

By **ALBERT J. RUTLEDGE, ASLA**. This lively book presents a practical and analytical discussion of the essentials of good park design. It presents a system for evaluating the worth of a park design plan and a broad-scaled view of design criteria based upon behavioral science findings, relating to people's needs, both aesthetic and functional.

180 pages, 150 illustrations, \$15.95

BETTER BUILDINGS FOR THE AGED

By **JOSEPH D. WEISS, AIA**. Here is the most timely and valuable book ever published on housing for the aged. It contains 77 successful, idea-packed designs for nursing homes and residences for the elderly by pace-setting architects in the United States, Canada, and Europe. Written by one of the nation's leading authorities on the subject, the book provides a practical guide on why, how, when, and what to build. A treasure-trove of photographs, renderings, site plans, and floor plans are included.

288 pages, 625 illustrations, \$22.50

HOSPITAL MODERNIZATION AND EXPANSION

By **E. TODD WHEELER**. Written by the architect whose innovations in hospital planning and construction have won him international recognition, this book describes methods, both analytical and creative, by which the problems of expanding and modernizing hospital facilities can be successfully attacked. This master guide covers every step from the initial survey of needs to actual construction and equipment requirements.

288 pages, illustrated, \$22.50

TOTAL DESIGN: Architecture of Welton Becket & Associates

By **WILLIAM DUDLEY HUNT, JR., FAIA**. This book describes the philosophy and inner workings of a well-known architectural firm that, over the years, has developed a system of defining its client's needs and then imaginatively and creatively fulfilling those needs by following the "Total Design" concept. The author discusses and visually demonstrates how all aspects of architecture (i.e., programming, design, engineering, production, interior design, etc.) are effectively coordinated and handled.

244 pages, 546 illustrations (62 in color), \$22.50

— 10 Days' Free Examination —

Architectural Record

1221 Avenue of the Americas, New York, N.Y. 10020

Send me the following book(s) for 10 days' examination. I will either remit—plus local tax, postage, and handling costs—or return book(s) within 10 days. (Remit in full with coupon, plus local tax, and McGraw-Hill pays postage and handling costs.)

- 17837-2 — Symbol Sourcebook \$28.50
- 62938-2 — Model Building for Architects and Engineers 15.75
- 01489-2 — Manual of Built-Up Roof Systems 15.50
- 08924-8 — Architectural Delineation 18.50
- 16760-5 — Joint Ventures for Architects and Engineers 16.50
- 17342-7 — Environmental Acoustics 18.50
- 54347-X — Anatomy of a Park 15.95
- 69071-5 — Better Buildings for the Aged 22.50
- 69520-2 — Hospital Modernization and Expansion 22.50
- 31298-2 — Total Design 22.50

Name _____

Address _____

City _____

State _____

Zip _____

Order good only in the U.S. and subject to acceptance by McGraw-Hill.

PR-74

In selecting equipment for buildings, architects have always been concerned with the equipment's design and detailing, wanting each item to fit in well with the over-all design of a particular building. Another traditional consideration has been the range of finishes available and the manufacturer's ability to match finishes and assume compatibility.

To these concerns many architects are now adding new areas of interest which reflect recent technological and philosophical developments.

For example, the growth in medical teaching facilities and hospital construction has been paralleled by some new thinking about laboratory equipment and casework. Owners and architects are demanding increasing flexibility and interchangeability so that replanning can take place more easily as changing uses require. Cantilevered casework systems reflect this need as well as the need to interface more easily with other building systems. An even more significant effort is the attempt to unify medical casework systems and decrease the impact of unique requirements imposed by dental and other specialties in large medical and teaching complexes. The result should be a more universal system of casework and easier interchangeability.

Another large area of concern is the hazard potential of building equipment. The Federal Trade Commission and other Federal agencies and consumer groups have been drawing more architects' attention to product safety and use. As a consequence, new questions are being asked. How much combustible foam plastics are we putting into buildings in equipment? What is the equipment's content of lead and other hazardous substances accessible to the user? What is the equipment's rating under the Occupational Health and Safety Act, especially food services and laundry equipment?

Along with such questions, many architects now consider important the energy cost of the equipment as well as its environmental pollution effects. These factors alone have far-reaching implications for equipment designers and producers.

Accessibility of equipment to use by the physically handicapped has become an important consideration too. Beyond ramp and elevator access, can a handicapped person use the equipment after he gets into the building is a question being asked more often these days, and manufacturers are giving more thought to how equipment can be designed or modified to eliminate physical barriers.

What these new trends mean is that building equipment is being looked at from totally new points of view and with new design and performance criteria in mind. We should therefore expect considerable change in equipment characteristics and manufacturers respond to these new requirements.

All the options to build kitchen ventilation precisely the way you need it.



UL listed ventilators for any kitchen layout

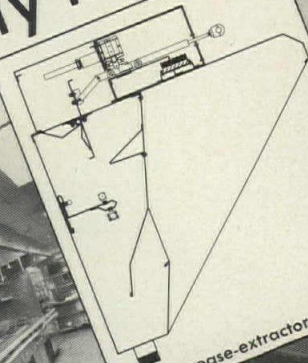

Listed grease-extractor ventilators

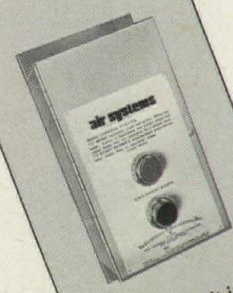

Push-button built-in wash

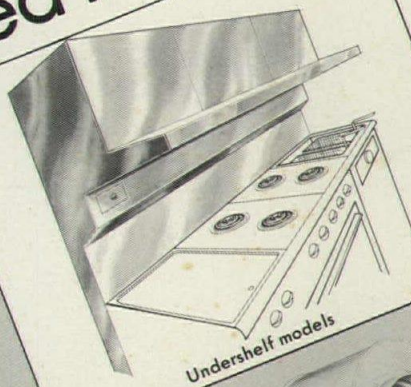

Undershelf models

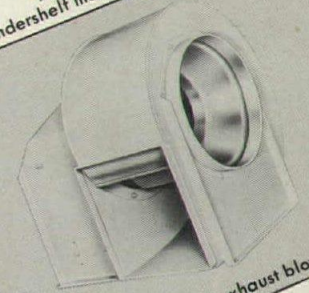

System-matched exhaust blowers



Automatic fire extinguishing

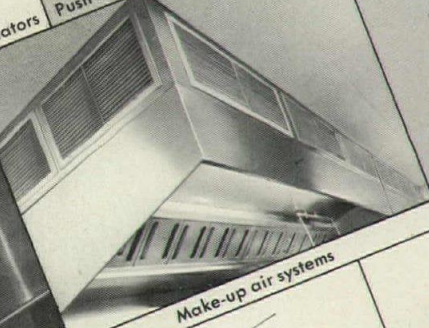

Make-up air systems

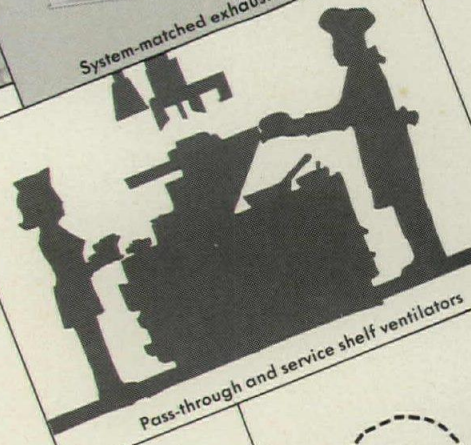

Pass-through and service shelf ventilators

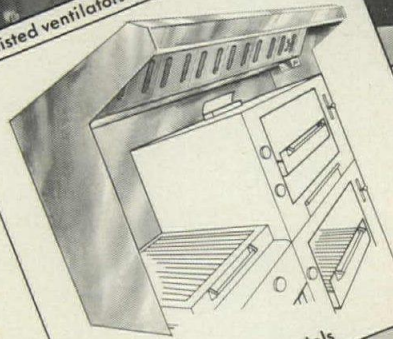

Hi-Vent models

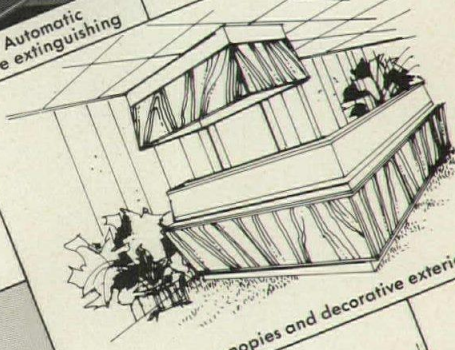

Custom canopies and decorative exteriors

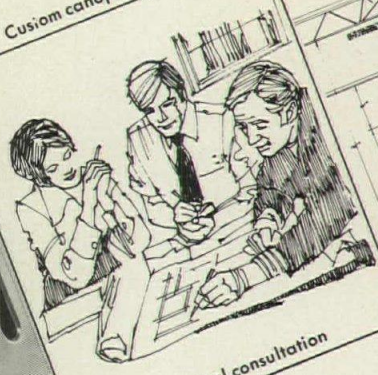

Technical consultation

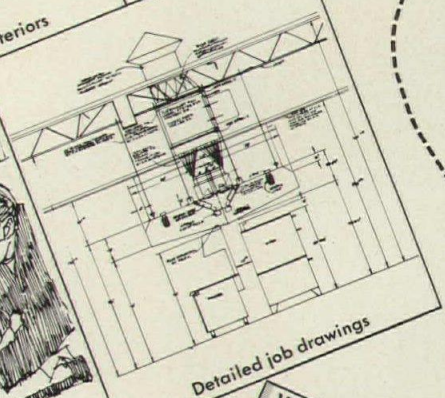

Detailed job drawings

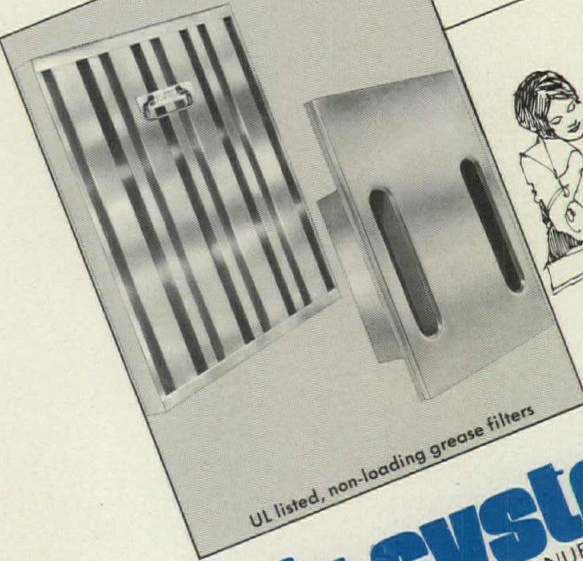

UL listed, non-loading grease filters

air systems
 DIV. DOANE MANUFACTURING CO.
 1200 S. Willis Avenue, Wheeling, Illinois 60090, (312) 537-6880

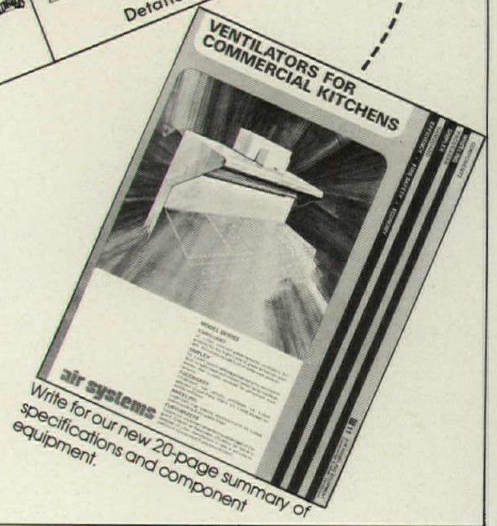

Write for our new 20-page summary of specifications and component equipment.

For more data, write A47 on inquiry card

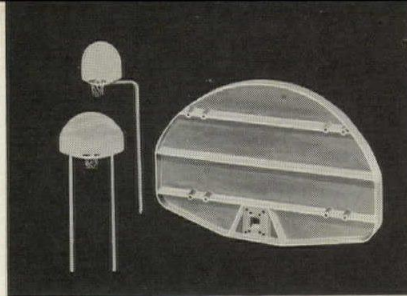

460

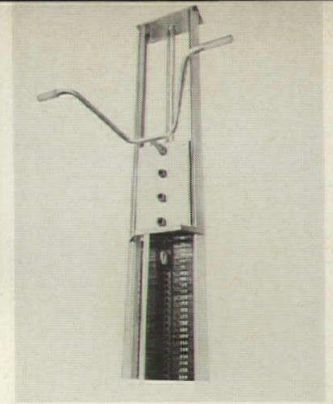

461

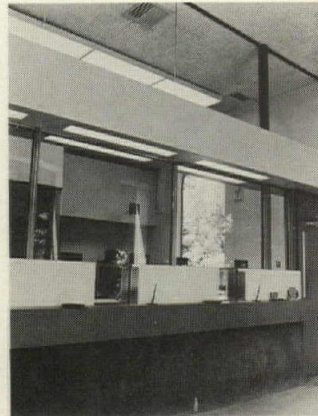

462

ATHLETIC EQUIPMENT

460 BACKBOARD / A solid-cast aluminum basketball backboard that needs no painting or maintenance, according to the company, is provided with a universal mounting system to accommodate all standard back posts and goal rings. Official-size. / Playground Corp. of America.

461 BARBELL MACHINE / A wall-mounted machine has a pressing module of 260 lbs and an adjustable three-position lifting arm. The unit is designed for apartment health spas. Unit requires a space of 6½ by 37 by 80 in. for operation. A safety head guard prevents possible accidents, it is said. / Marcy Gym Equipment Co.

BANK & VAULT EQUIPMENT

462 PROTECTED WORK POST / The company has integrated its financial furniture counter line with bullet-resistant glass and steel to provide protection against small arms, yet retain a normal-appearing atmosphere. / Mosler. A*

463 DRIVE-IN TELLER / A fully automatic direct vision loose carrier for drive-in transactions features a high-fidelity audio system and multiplex

switching to allow one teller to transact business with up to six customers at once. / Mosler Safe Co. A*

464 DRIVE-IN TELLER / The system is a direct vision loose carrier type, delivering materials through a single 4½-in. pneumatic tube. High fidelity audio communication is claimed. / Mosler Safe Co. A*

465 WALK-UP TELLER / The TV walk-up transaction system shown here permits teller stations to be located in safe areas because business is conducted over a remote audio-visual network. Drive-in systems are also available. / Mosler Safe Co. A*

466 COMPUTERIZED ALARM / Integration of the computer, according to the company, greatly extends the versatility of present alarm systems for remote audio-visual surveillance, hold-up detections, access, fire alarm and environmental monitoring. / Mosler. A*

467 TV TELLER / Unit offers walk-up banking anywhere, with teller located in a remote, secure room. Direct vision TV, two-way audio system and telephone for private conversation are included. A pneumatic tube carries transaction materials between customer and teller and illuminated panel instructs customer on system use. / Diebold, Inc. A*



463



464



465



466



467

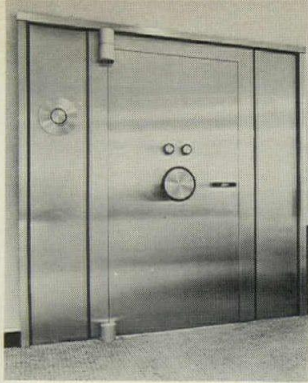

468



469



470

468 VAULT DOOR / This 7-in. model qualifies for a 9R rating. A 3½-in. model qualifies for a 6R rating. Both are available with a standard shadow box or optional deluxe architrave. / Mosler. A*

469 CARD ACCESS / The product automatically controls access to restricted areas by means of magnetically-coded ID cards. Accessor consists of a card reader, encoded cards and a processing unit. / Mosler. A*

470 CASH TERMINAL / A teller can cash a check as fast as pushing a button, according to the company. *DACT* dispenses the exact amount of the check in currency and coin as required and records the amount on the back of the check, keeping a running total on all transactions at the register. / Diebold, Inc. A*

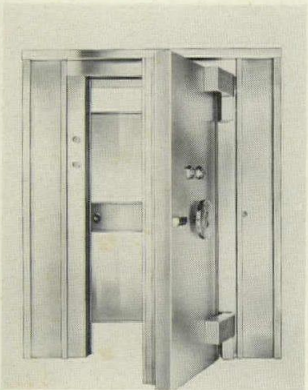

471

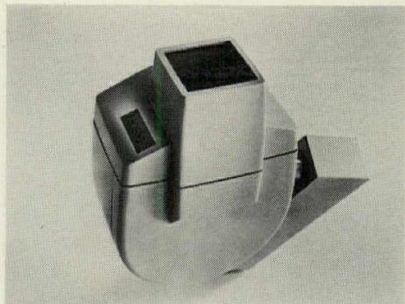

472



473

471 VAULT DOOR / Measuring 3½ in. thick and meeting all requirements set forth in the Bank Protection Act, the door also conforms to specifications established by the National Bureau of Casualty Underwriters. All edges and surfaces are stainless steel. Two locks. / Hamilton Safe Co.

472 PHOTOSURVEILLANCE / Three-way photosurveillance capability in this unit provides a film record of transactions, suspicious individuals and full hold-up coverage. A 16 mm programmed sequence camera is featured. / Mosler. A*



474



475

473 SAFE DEPOSIT BOXES / New stocking and numbering systems enable the company to offer off-the-shelf delivery on its *Stock 200* safe deposit boxes. Ability to order in small increments lets customer buy for current needs, expand as demand increases, according to the company. / Diebold, Inc. A*



476



477



478

474 AUTO TELLER / This remote banking system permits the customer to remain in his car, sending transaction materials through a pneumatic tube system to the teller. The company claims the teller can serve several customers at once. / Diebold, Inc. A*

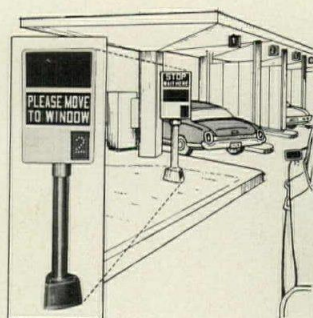

479



480

475 DRIVE-IN TELLER / This model can serve two customers and is oriented to ensure the customer and teller are always in direct visual contact. A high-fidelity audio system is claimed. / Mosler Safe Co. A*

476 AUTOMATIC TELLER / For maximum security, according to the company, this device is a self-contained unit with a minimum of 3/4-in. stainless steel topped with bullet-resistant glass. A motorized rotating box permits transaction materials to pass from customer to teller. / Watson Mfg. Co., Inc.

477 TELLER SYSTEM / This automatic system permits institutions to extend services 24 hours a day. Up to three withdrawal options are offered and seven funds transfer, bill payment or depositing options. The system uses encoded cards. / Mosler. A*

478 AUTOMATIC BANKING / The TABS 500 system uses bank card and simplified push-button principle to provide customer service 24 hours a day. Video display leads customer through transaction and unit operates on-line or off to produce machine-processable records. / Diebold, Inc. A*

479 BANK TRAFFIC CONTROL / The system is designed for maximizing efficiency at drive-in banks and is said to permit overall bank design to be tailored to take advantage of site peculiarities. Control provides equal teller use. / Elec-Tro-teC, Inc.

480 PROPRIETARY ALARM / The system is said to report the status of 60 to 30 security-sensitive areas and can be extended to monitor any number of remote facilities, providing audible and visual alarms at guard console and to the police. / Diebold, Inc. A*

BUILT-IN MAINTENANCE

481 VACUUM INLET VALVE / This inlet valve has been introduced in Lexan which will not chip, crack, peel or rust, according to the company. The valve is the same size as electrical receptacles and the textured lid can be painted, papered or finished to suit. / H-P Products, Inc.

COMMERCIAL EQUIPMENT

482 MERCHANDISER / The system has six basic frame parts that support bunkers and decks. It assembles without tools, according to the company, and is available in a choice of 17 colors for frame panels and bunker doors. / Reflector Hardware Corp.

483 DISPLAY SYSTEM / Designed by an architect, this system consists of telescoping stainless steel components that can be assembled without tools. The basic 40-in. module is designed for eye-level viewing, centering the display area at a height of 5 ft. / Metals Mfg. Co.

DARKROOM EQUIPMENT

484 ROLL FILM DRYER / A filtered, temperature-controlled air flow from the unit sweeps film dry, free of dust and drying marks according to the company. Unit will accommodate three 120-reels or five 35mm reels. / Matrix Systems, Ltd.

EDUCATIONAL EQUIPMENT

485 TEACHER'S CHAIR / With arm rests, the chair is offered with a choice of sled base or four-on-the-floor chassis. The thermoplastic shell features an arched back and open vent area. Upholstered on the seat and back, the chair is offered in bright colors. / Peabody.

486 LANGUAGE LAB / A 24-student system features three selector channels to access programs centrally stored in main dial-access system; two integral reel-to-reel decks are also included, with one integral cassette deck, one record player, student selector panel and intercom panel. / Scott Engineering Sciences.

FOOD SERVICE EQUIPMENT

487 MOBILE CAFETERIA / Unit includes hot food stations, refrigerated or cold pan station, utility, cashier and tray and service carts. Units lock together and have adjustable tray slides. The open back provides for storage. / The Vollrath Co.

488 CIRCULAR SERVER / A complete 12 ft 8 in. diameter serving unit features eight customer serving stations and is designed for fast food pre-packaged service. Various heated and chilled sections of the lower stainless steel rotating counter are flanked by rotating displays. / B/W Metals Co.

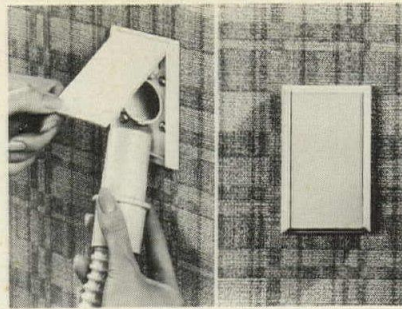

481

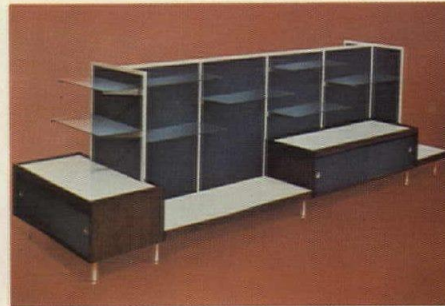

482



483

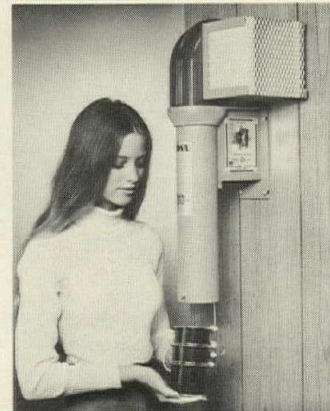

484



485



486



487

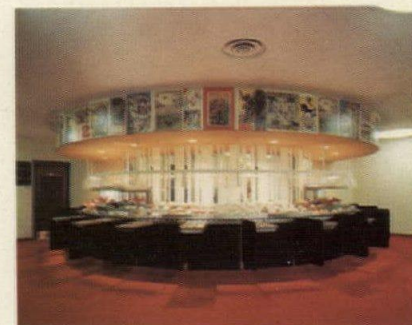

488

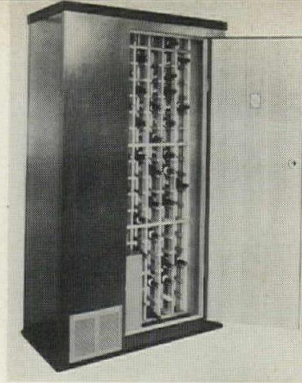

489



490



491

489 WINE STORAGE / Providing lock and key security plus mobility, this unit is lined in California redwood and uses normal house current with minimal current consumption. It maintains constant cool temperature and each bottle is stored lying down. / The Wine Vault, Inc.

490 SOLID METAL SHELVES / For use in the food service industry, the solid metal shelving comes with three surfaces—flat, embossed and louvered. Two corrosion-resistant finishes are offered, along with a range of sizes up to 24 by 60 in. / Metropolitan Wire Goods Corp.



492

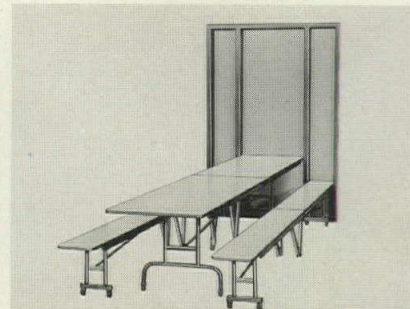

493



494

491 DRINK DISPENSER / A self-contained compact unit, this 4-flavor dispenser refrigerates, mixes and serves cold drinks in less than 3 sq ft, according to the company. Water and drain lines must be supplied, as well as electricity. A laminated bar top is included. / Kenco Products Corp.

492 ICE CUBER / Up to 600 lbs of ice cubes can be produced with this unit featuring stainless steel exterior or grey enamel baked on. The interior is stainless steel also. Unit measures 42½ in. wide and 23½ in. deep. / Uni-flow Mfg. Co. A*



495

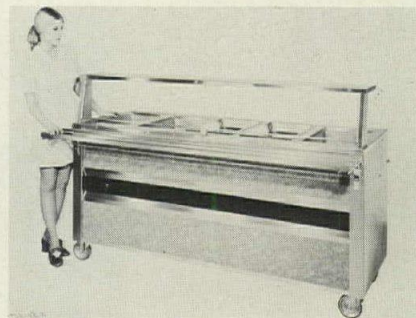

496



497

493 CABINET-STORED TABLE / Bench and supports are now provided with low-positioned, square steel cross-members, each mounting two casters. Heavy-duty, contoured, vinyl cushioning is supplied to protect against damage to table and bench edges. / Mitchell Mfg. Co.

494 RANGE-DISHWASHER / Measuring 30 in., the unit combines a vent hood, oven, cooktop and dishwasher. Recommended for apartments, the unit is available in either electric or gas models, and a ductless unit is offered also. / Modern Maid, Inc.

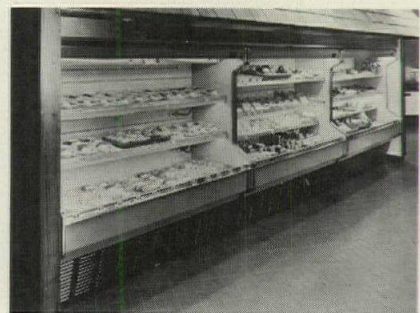

498

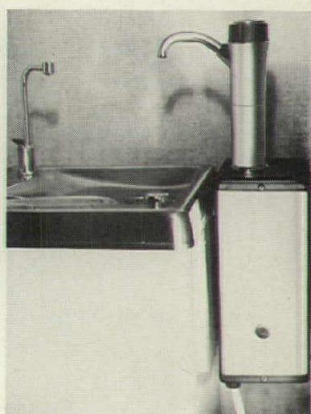

499

495 ICE MAKERS / The company states its line of low-priced, compact refrigerators includes 2.2-cu ft and 5-cu ft models in white and walnut and freezers in chest type sizes. For table top or under the counter use, the models are suggested for home and commercial applications. / U-Line Corp.

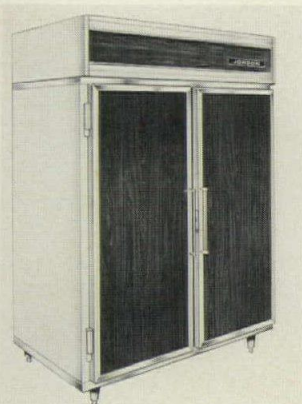

500



501



502

496 MOBILE CAFETERIA / The company states that this and other components, when locked together, form a complete cafeteria installation in seconds. A wide selection of panel colors and textures is offered and stainless steel construction is featured. Hot and cold food can be stored. / Carter-Hoffmann Corp.

497 - CHEF'S UNIT / The company claims the same benefits of costlier custom-made units are offered in this one, which is offered in stainless steel or paint grip steel with baked-on gray silicone enamel. Many storage possibilities are offered. / Duke Mfg. Co. A*

498 FOOD MERCHANDISER / For hot and cold foods, this unit for the fast food service business displays food on 4- or 6-ft modules which can stand alone or be mixed and matched. Each module is a self-contained unit needing only an electrical outlet. Shelves, wire racks and dividers are adjustable. / Tyler Refrigeration Div., Clark Equipment Co.

499 HOT WATER DISPENSER / Designed to be mounted on any existing water cooler, the product will provide up to 100 cups of 190-degree F water per hour. The 1300-watt, self-contained unit weighs 9 lbs. / In-Sink-Erator Div., Emerson Electric Co. A*

500 REFRIGERATORS / Available in one-, two- and three-door models in addition to a sliding door display model, this line is offered in depths of 32 in. and 24 in. Standard features include self-closing doors, automatic condensate evaporation, security locks, and adjustable shelves. Aluminum, stainless steel and vinyl-clad metal are cabinet choices. / Jordon Commercial Refrigeration Co.

501 KITCHEN EQUIPMENT / A complete line of kitchen fabrications, including baker's table, dish tables, etc. is offered to complement the company's line of modular cafeteria and fountain lines. / Stanley Knight Corp.

502 CAFETERIA UNITS / Designed in the moderate price range, hot and cold serving units are constructed of stainless steel, with frames of box beam extruded aluminum. Casters are included. Black is the standard finish color and optional shelves can be ordered. / Precision Metal Products, Inc.

503 FLAKE ICE MACHINE / The basic machine can produce up to 600 lbs of ice each 24 hours and can store up to 250 lbs. Machine measures 38 1/4 in. wide, 28 in. deep and 34 7/8 in. high, without legs. Ice storage bins are stainless steel and insulated with polyurethane. A second model can be equipped with four drink faucets. / Liquid Carbonic Corp.

LABORATORY EQUIPMENT

504 LAB CABINETY / A full line of cabinetry in plastic laminates is offered by the company, a manufacturer of wood laboratory cabinets. Colors are available. / Conco Industries, Inc.

LAUNDRY EQUIPMENT

505 COMPACT LAUNDRY / A washer and dryer pair for apartments requires 4 sq ft, according to the company. Units measure 24 in. wide when used with the optional stack stand. Available in three colors and wood grains. Operates on 208- or 240-volt service. / Sears, Roebuck and Co. A*

506 COMMERCIAL DRYER / A dryer designed specifically for self-service laundry use, this single-load capacity unit is recommended for apartment buildings, dormitories, etc. A choice of three separate control centers makes the dryer adaptable to any kind of installation, according to the company. / The Maytag Co.

507 MODULAR LAUNDRY / The basic modular 200-lb capacity units can be bolted together into an automatic system that produces up to 400 lbs per washer per hour, or 2400 lbs per system per hour. System uses wet belt conveyor. / American Laundry Machinery Div., McGraw-Edison Co.

508 WASHER, EXTRACTOR / The company describes this unit as a hospital-type bacteria control laundry for effective control of staph. Available in models that range from 230 to 900 lbs dry-weight input capacity, the units provide synchronized volume production ranging from 4000 to 8000 lbs of input per hour. / G. A. Braun Inc. I*

509 WASHER-EXTRACTOR / This 275-lb capacity unit is recommended for a medium-sized commercial, institutional or industrial laundries, but can be combined in modular fashion to meet many requirements. The 52-in. diameter cylinder provides a big "drop" for excellent washing action, according to the company. / Pellerin Milnor Corp. A*

510 IRONING CENTER / This metal unit, finished in baked enamel of harvest gold or butterscotch, is said by the company to be fire-proof and practically indestructible. Recommended for home and institutional use. / Iron-A-Way, Inc. A*

511 WASHER-DRYER PAIR / For commercial applications, this laundry pair features a high security meter case as standard equipment. Both coin meter case and coin vault have been redesigned to make vandalism more difficult. / Speed Queen. A, L*



503



504



505



506



507

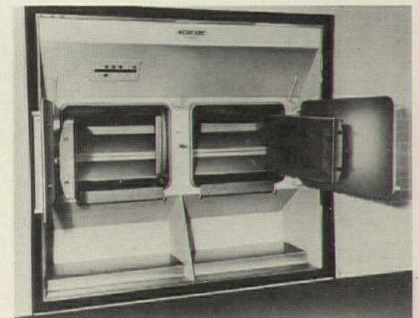

508

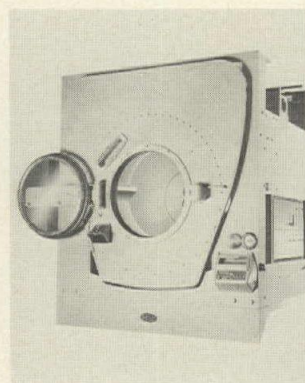

509



510



511

LIBRARY EQUIPMENT

512 LIBRARY FURNITURE / Bookstacks in chrome-plated T-base or closed base and a selection of finishes for shelves, top and end panels are featured. Carrels are offered in a variety of styles, along with exhibit cases, tables and chairs, with dimensions to meet specification requirements. / Reflector Hardware Corp.

LOADING DOCK

513 DOCK LEVELER / Mechanically or hydraulically operated recessed levelers are self-forming, providing a savings in concrete of \$180 to \$200 per unit, according to the company. Levelers are fully-adjusted at the factory and ready for use when installed. / Ellis Industries.

514 MOBILE DOCK LIFT / The lift has a 3000-lb capacity and features a 6-ft square platform and 30 by 60-in. approach ramp. Electric hydraulic unit complies with OSHA requirements, NEC Code and has a weatherproof pushbutton control, according to the company. / Autoquip Corp. A*

515 DOOR SEALS / For loading dock doors, this seal uses hollow rubber cushion which will compress against the truck on contact, according to the company. There are no blowers required for inflation and the seal will return to its proper shape. Cushion absorbs shock and pressure from trucks. / W. B. McGuire Co. A, I*

516 TRUCK BARRIER / A movable barrier for truck and rail loading docks, platforms and pits is made of highly visible polypropylene rope, with rails at 42 in. and 21 in. Safe-T-Line requires no maintenance, according to the company and complies with OSHA. / Ellis Industries.

MEDICAL EQUIPMENT

517 HOSPITAL BED / Winner of a Design in Steel Award, this bed features a pneumatic safety control that uses air only to trip switches that start the bed's motors. This eliminates potentially dangerous electrical controls for the patient. / InterRoyal Corp.

518 PATIENT CARE UNIT / The system is said to be a complete centralized patient care unit, prefabricated, prewired and providing for all major nursing services, eliminating the need for complex built-in equipment. / Joerns Furniture Co.

519 FLOOR-LOAD AERATOR / This floor-loading aerator removes residual EtO gas from loads processed in the company's gas and gas/steam sterilizers. It is said to program easily and



512

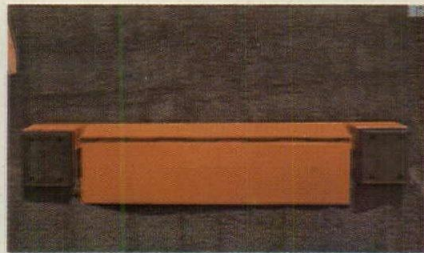

513



514

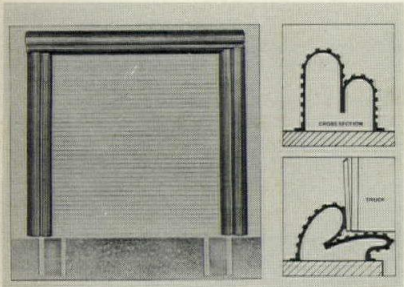

515



516



517

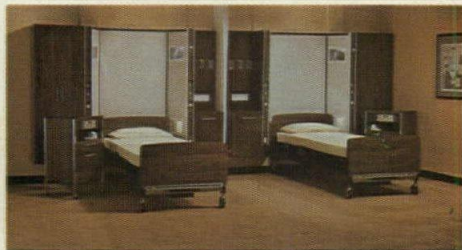

518

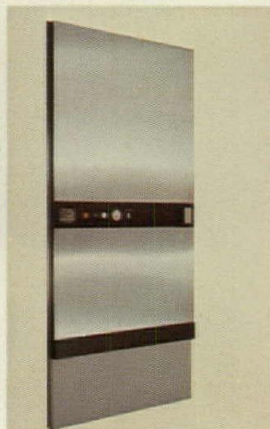

519



520



521

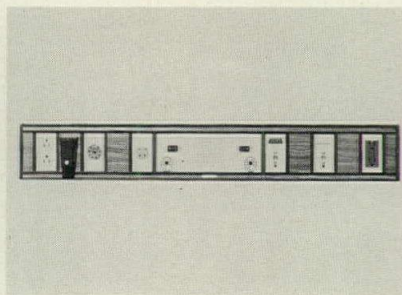

522



523



524

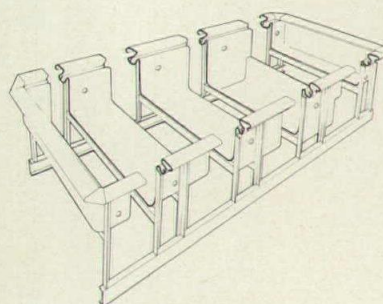

525

shuts off automatically at end of cycle. Stainless steel construction. / American Sterilizer Co. A*

520 PNEUMATIC DISPATCH / Laboratory blood samples can be transported by pneumatic tube without significant red cell damage in the enzyme area, according to the company. Carrier sizes are 6 and 8 in., and system can also be used to distribute medicines, messages, etc. / American Sterilizer Co. A*

521 AUTOPSY TABLE / Plumbing fixtures including mixing faucet and hydro-aspirator are deck-mounted and move with the table top on this unit, with electric height adjustment, 32 to 38 in. The top features 180-degree manual rotation. Center drain has basket strainer and standpipe overflow. All-welded polished stainless steel construction is offered. / The Jewett Refrigeration Co., Inc. A*

522 PATIENT CONSOLE / A wall-mounted system in almost unlimited finishes, according to the company, may accommodate from 1 to 58 service outlets as dictated by specific patient requirements. Audio-visual nurse call stations, medical gas, monitoring connections, emergency outlets, etc., can be included. / Vista Lighting Co.

523 HOSPITAL STORAGE / A material handling system for hospitals uses *Noryl* containers which can be stacked, placed on wall hangers, stored or transported. Designed for manual or automated transportation equipment. / American Sterilizer Co.

524 OVERHEAD TRANSPORT / This rail transport system is designed for hospitals and can save up to 5000 sq ft of space in a typical 500-bed installation, according to the company. Fully-automated or semi-automated models and a variety of carts are offered. / American Sterilizer Co. A*

525 THERAPY POOL / Pool consists of 12 by 4 ft aluminum sections which come in 8-in. increments. The modular sections are coated with PVC color coding for depth demarcation. Each pool section has self-contained plumbing fixtures and removable skirt for access. / Overly Mfg. Co.

PARKING EQUIPMENT

526 BIKE PACK / The rack is designed to foil theft by housing the frame and rear wheel assembly of the bicycle. Constructed of 3/8-in. formed steel plate coated with a finish to protect the bike's, the rack is anchored to the ground with a special nut and collar. Can be installed individually or in groups of six on a free-standing bracket. / Rally Enterprises Inc.

527 TRAFFIC DELINEATOR / *Flexopost* is a polyethylene marker with bounce-back capability, return-

ing to its full upright position even after being repeatedly struck at turnpike speeds, according to the company. Offered in all-white finish. / Proven Products Inc.

RESIDENTIAL EQUIPMENT

528 PORTABLE DISHWASHER / Push-button activated full cycle operation and a 1/2 hp motor are offered with this unit that comes with a five-year guarantee. / The Hobart Mfg. Co.

529 MICROWAVE DUO / Available in a range unit (shown), this microwave oven is also offered in a tabletop unit that can be built in. The oven has an output of 650 watts. / Brown Stove Works, Inc.

530 SMOOTH TOP RANGE / Two models—a built-in surface unit and a set-in range—feature ceramic glass tops with no ridges to catch dirt. A computer-designed surface element provides even heat. Low profile control knobs. / Whirlpool Corp. D*

531 TOUCH CONTROL RANGE / A touch of the finger on the control panel will initiate cooking on this model, said to feature a computer-based control system. The range eliminates some of the conventional electro-mechanical controls, replacing them with integrated circuits, solid-state components. / Frigidaire. A, L*

532 MICROWAVE OVEN / This budget unit can be built-in and provides 450 watts of cooking power, using 10 amps. No special wiring is needed. A see-through door with piano hinge is included. / Magic Chef.

533 MODULAR RANGE / Available in sizes from 21 to 36 in. wide, this range can be supplied in either gas or electric models. Ranges are available in decorator colors and feature a full 17-in high oven as a standard. / Athens Stove Works, Inc.

534 DISHWASHER-SINK / This combination is 48 in. wide and is offered in a steel storage cabinet. A hot water dispenser and food waste disposer from the company can be added and a wide range of popular colors is offered. / The Hobart Mfg. Co. L*

535 MICROWAVE OVEN / Cutting cooking time as much as 75 per cent, according to the company, this unit features swing open door with window and oven light. / Tappan Appliance Group.

536 TOUCH CONTROL RANGE / An electric range with "touch" controls operates on solid-state circuits, eliminating electro-mechanical components used in conventional controls. *Ceramatop* surface and smooth controls provide maintenance ease. / Frigidaire. A, L*

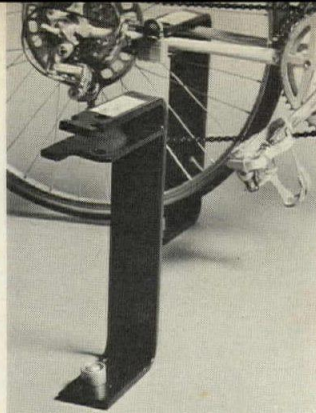

526



527



528



529



530



531



532

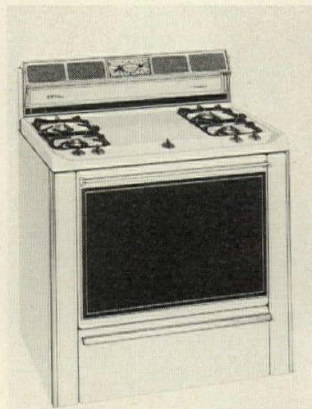

533



534



535



536

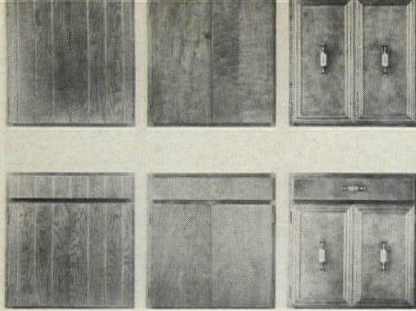

537

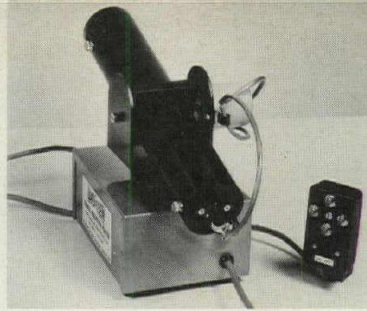

538

537 CABINET LINE / A grooved plank surface, a smooth surface and others are offered in this line of kitchen cabinets with a range of base, wall and peninsula units. Multi-coat finishes are offered, with site-adjustable hinges. / Louisiana-Pacific Corp.

THEATER & STAGE

538 PROJECTION POINTER / Remote controlled spot of light pinpoints specific screen areas, according to the company, and is made for use with rear-screen projection. Remote controls and low-voltage requirements are featured. / Polacoat, Inc. A*

539 GRILL-RANGE / This electric convertible cooktop grill-range features an optional plug-in cook cartridge making the unit a four-element range. The conversion takes less than 30 seconds, according to the company. Built-in ventilation. / Jenn-Air Corp. L*



539



540

WASTE HANDLING

540 TRASH COMPACTOR / This small unit measures 12 in. wide, 15 in. deep and 23 in. high, and can be located beneath the sink in most kitchen cabinets, according to the company. Powered by regular 110-volt house current, the unit will mash all waste, including cans and bottles. Unit features welded steel construction, and is offered in four colors. / VSI FilteX Div. of Natter Mfg. Corp.

541 SOLID WASTE COMPACTOR / Designed for use in townhouses, institutions and schools, the unit measures 68 in. high, 17 in. deep and 42 in. wide. It can be flush-mounted or stand alone and each receptacle can hold 15 cu ft of trash. / G & W Auto Pak. A*

542 SMALL PACKER / For small and medium size industrial plants and institutions, this solid waste compactor is said to handle up to 118 cu yds of refuse per hour.

Panels remove easily and the power unit includes all electrical and hydraulic components, incorporating an oil filter. / The Heil Co.

543 COMPACTOR / This automatic multi-receptacle stationary solid waste unit uses a conveyor system for assembly-line compacted trash filling. Overflow and spillage is prevented, according to the company. Each receptacle holds 75 lbs. / G & W Auto Pak. A*

544 DISPOSER / Long-life guarantees accompany this stainless steel unit with patented jam-free swivel impellers. Metal-to-metal contact and vibration are eliminated for quiet operation, according to the company. / Waste King Universal.

545 SMALL COMPACTOR / Low cost operation is claimed for this unit which can be chute-fed or hand-fed. Compaction ratio is 4 to 1. Models have a 30-in. throat which accommodates a standard 24-in. chute. / G & W

546 TRASH COMPACTOR / A stationary unit with built-in compactor instead of the traditional roll-off container is available in several capacities. The company claims unit requires little maintenance. / Maxon Industries, Inc.

547 SOLID WASTE UNIT / Food, paper and plastic can be turned into a semi-dry pulp reducing waste volume by 85 per cent, according to the company. Water conveys the pulp slurry to a press which extracts the water. Free-standing units or under counter models are offered with capacities up to 1500 lbs per hour. / The Hobart Mfg. Co. A*

548 SOLID WASTE DISPOSAL / Auger action replaces hydraulic-operated ram on this unit recommended for large installation. The unit can accommodate refuse from up to 200 families. Equipped with manual and fully automated controls. Compacted waste is deposited into refuse cans or side and front-loading containers. / Jeffrey Heinz Mfg. Co. I*

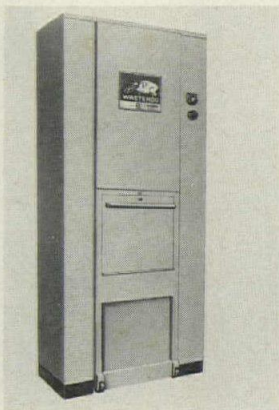

541



542

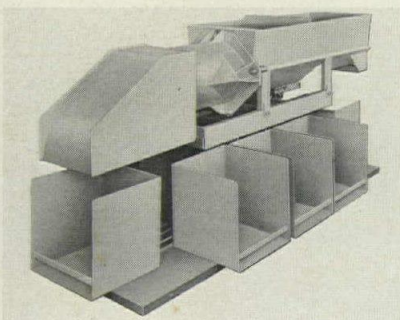

543



544

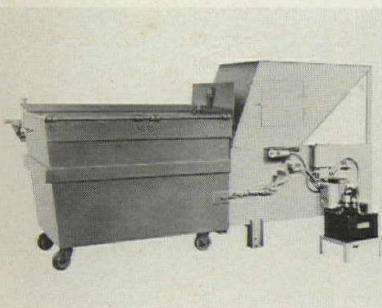

545

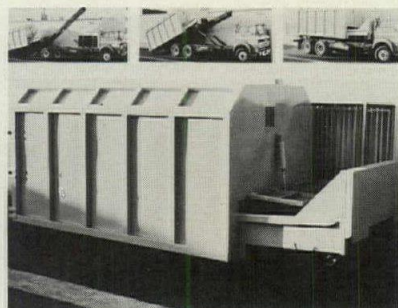

546

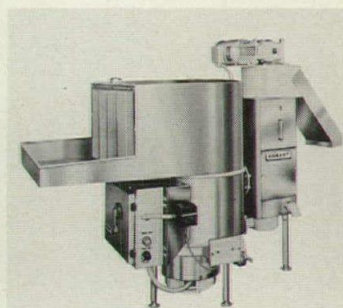

547

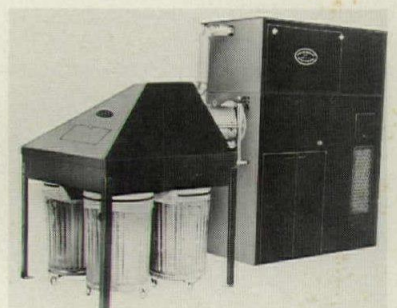

548



Jewett equipment measures up to your requirements

- Cylindrical and counter top blood banks
- Biological and Pharmaceutical refrigerators
- Wall-mounted refrigerators
- Small capacity over and under-counter refrigerators
- Nurses' station and utility room refrigerators
- Walk-in refrigerator and freezer doors
- Explosion proof refrigerators
- Temperature Monitoring Systems for all temperature controlled spaces and equipment
- Recording Thermometers with Mark-a-Matic continuous flow inking system
- Free standing and built-in mortuaries
- Autopsy tables
- Air Sentry — air purifier and deodorizer

Write for further information and name of the Jewett representative in your area

THE JEWETT REFRIGERATOR CO., INC.
2 LETCHWORTH STREET
BUFFALO, NEW YORK, 14213

For more data, write A48 on inquiry card

ARCHITECTURAL RECORD READER SERVICE

If you need additional coupons,
photocopy this page as many times as necessary.

Product information for the asking!

If the postpaid inquiry cards on the inside back cover have already been used, you can use these handy coupons to obtain more information on the products and services described in this issue, including . . .

- Advertised materials, equipment and services.
- New products described in the "Product Reports" pages.

How to use the inquiry coupons

- 1 Clearly write the product's *complete* key number (include letter where one appears) in one of the boxes on the coupon. Only one product per box, please. It is important that the number be completely contained in the box and written legibly.
- 2 Clearly print or type your name, title, firm and business address—including ZIP code—at the bottom of the coupon.
- 3 Check box indicating your profession or business.
- 4 Put the coupon in an envelope and mail to Architectural Record, Reader Service Department, P.O. Box 7524, Philadelphia, Pa. 19101.

Note: Coupons are valid until April 15, 1974.

Write Key Numbers in the boxes and TYPE OR PRINT name
and address on this Inquiry Card

(Good until 4-15-74) Issue 14

OCCUPATION (Please Check)

- A Registered Architect
- B Engineer — Structural
- C Engineer — Mechanical
- D Engineer — Electrical
- E Engineer — Other
- F Other (please specify)

Do you subscribe to Architectural
Record Yes No

Name

Title

Company

Business Address

City State Zip

Write Key Numbers in the boxes and TYPE OR PRINT name
and address on this Inquiry Card

(Good until 4-15-74) Issue 14

OCCUPATION (Please Check)

- A Registered Architect
- B Engineer — Structural
- C Engineer — Mechanical
- D Engineer — Electrical
- E Engineer — Other
- F Other (please specify)

Do you subscribe to Architectural
Record Yes No

Name

Title

Company

Business Address

City State Zip

Winchester OAK



Your very own kitchen...

RUSTIC CHARM...TRIM ELEGANT STYLING...VIBRANT WOOD TONES



For the "Now Generation"
Custom designed solid furniture core doors with the unique Connor sculptured design to complement any decor.



CONNOR
FOREST INDUSTRIES
WAUSAU, WISCONSIN 54401
715/842-0511

101 Years of Experience

Today we blend this old world craftsmanship with new world technology to bring out the best in wood.

SEE OUR CATALOG IN SWEET'S

For more data, write A49 on inquiry card

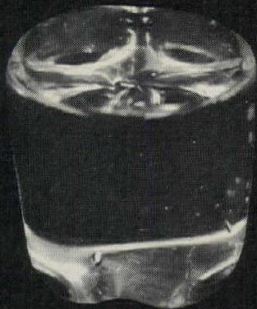

gourmet ice
cubes for kitchens,
wet bars and
family rooms...
whenever you want it

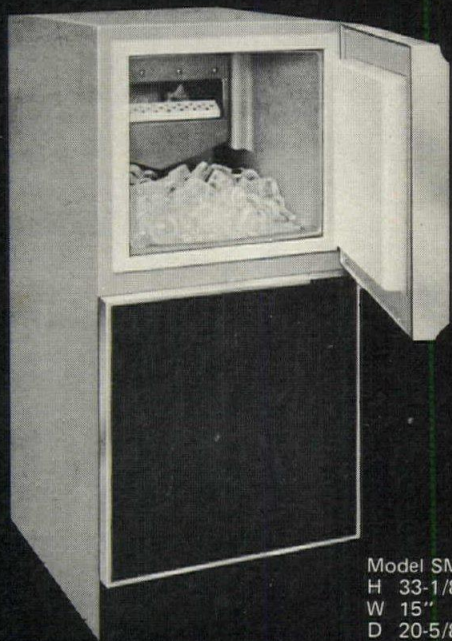

Model SM18
H 33-1/8"
W 15"
D 20-5/8"

SCOTSMAN
makes 480 cubes per day
stores 670 cubes

Scotsman, the world leader in commercial ice making equipment, presents the new compact, home icemaker. It produces clear, pure, round, upside down cubes of slow melting ice. A unique process produces Scotsman cubes that are actually purer than the water they are made from. Now you can design and specify a source of gourmet ice in abundance for food, beverages and entertaining.

Dependable design has been proven in thousands of commercial installations. Icemaker shuts off automatically when the bin is full. The Scotsman is also ideal for office, staff dining rooms, executive suites and employee lounges.

Get the full details on the Scotsman plan for model homes, apartments, condominiums and custom homes. Write SM18 CUSTOM CUBES



COMMERCIAL ICE SYSTEMS / HOME ICE MAKERS

Queen Products Division
King-Seeley  Thermos Co.
10810 Front St., Albert Lea, Minn. 56007

For more data, write A50 on inquiry card

Spotlight on Engineering for Architecture

Architectural Record is planning a timely expansion of its editorial services to engineers, architects and the manufacturers who market to them.



ENGINEERING FOR ARCHITECTURE

A Spotlight issue devoted to a highly professional presentation and analysis of the most significant developments in engineering for building—featuring:

- the engineer resources: the right way to use the right people to get the right expertise at the right time.
- the technical resources: an overview of the current state of building technology, with a particular look at the most important developments.

Scheduled for publication in mid-August 1974 and annually thereafter.

A McGraw-Hill Market-Directed Publication

ARCHITECTURAL RECORD

1221 Avenue of the Americas, New York 10020

Designers recommend Spencer central vacuum systems for economy and practicality.

With labor cost sky rocketing and with increasing need for frequent and more thorough cleaning, a Spencer central vacuum system makes more sense than ever before. And results in happy clients who reap the benefits.

Any or all of the brochures illustrated here are yours for the asking. Plus personal consultation if you like.

Write or phone.

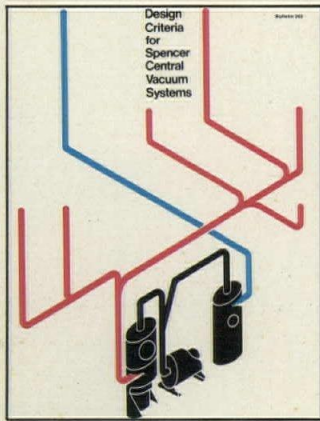

260 Design Criteria for Central Vacuum Systems

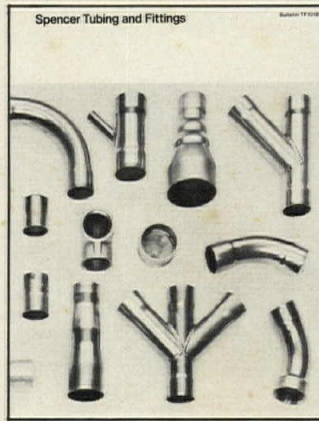

TF101 Tubing and Fittings



200 Industrial Vacuum Systems



126 Turbo Compressors

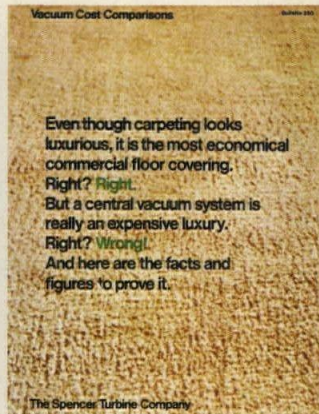

250 Vacuum Cost Comparisons

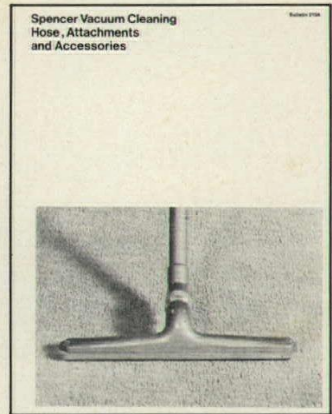

210 Vacuum Cleaning Hose, Attachments & Accessories



142 Aerating Blowers

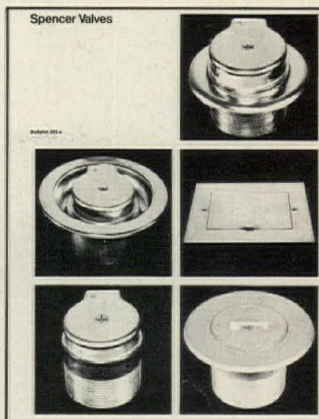

205 Valves

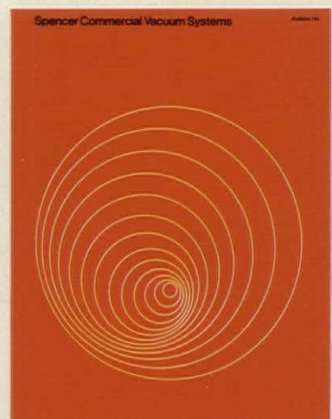

195 Commercial Vacuum Systems



190 Self-Contained Vacuum Systems

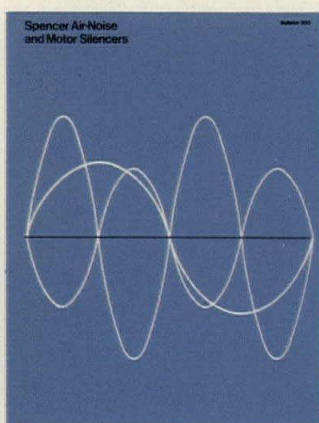

300 Air-Noise and Motor Silencers

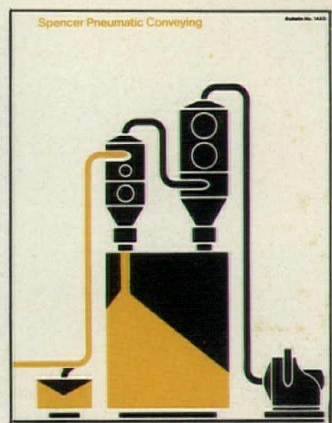

143 Pneumatic Conveying

The Spencer Turbine Company

Drawer E, Station A
Hartford, Connecticut 06106

For more data, write A51 on inquiry card

Four sensuous new reasons to keep in touch with Harter



870



2613



2600



2610

Furniture design: Earl Koepke

In Canada:
Harter Furniture, Ltd., Guelph, Ontario

Harter Corporation
1005 Prairie, Sturgis, Michigan 49091

Showrooms and sales offices
in principal cities.

For more data, write A52 on inquiry card

I was delighted by the first edition of ARCHITECTURAL RECORD's PRODUCT REPORTS issue last year—sufficiently so to quote from Walter Wagner's quote from Robert Fischer: "Improvement in the physical performance of building components can advance much faster if the communication between architects and engineers and product manufacturers is more intense and their collaboration more effective." Hear, hear!

In my role as a principal in a firm devoted to the design of architectural interiors, I will address myself to all of the groups that Mr. Fischer mentioned.

For the designer of architectural interiors, the physical task is often strictly limited. This is so because the architect's vision of the whole design (and the clients' views of their own finances) can tend to obscure one of the real points: that their buildings are meant to be habitable. All too often the architect is caught up in trying to pull off the design on time and within the budget, the engineers are called in second-hand to make the proposed design work, and interior designers are hired to make the given spaces not only functional but "pretty" as well.

Unfortunately, too, the product manufacturers are caught up in an admirable but bewildering exercise of developing, year by year, new items for us to specify. How good are they? How are they better than last year's versions? Will they maintain? When will they be delivered? Why are they thought to be better than those traditional materials, like natural fibers versus synthetics, or crafted wood versus molded plastic? Which ones will acquire the attractive patina of age? Which ones will simply look shabby? One hopes that the product manufacturers will take up the gauntlet and answer many of these questions with which we all are being confronted. One trusts, for instance, that the development of scratch-resistant plastics is an indication that certain product manufacturers are as concerned as we are.

At the risk of being immodest on behalf of my profession (but with Mr. Fischer at my side) I would propose a more gentle and general communication between all the people involved in making buildings—from the bottom up to the top down, from the outside in to the inside out. Mutual respect for our own specialties will allow us all to proceed without rancor to the common goal.

Our task as interior designers is to influence the configuration of interior spaces, insofar as is possible and reasonable, and then to assemble in those spaces manufactured products which will make them convenient to be in, good to be in, satisfying—that is, habitable.

*Louis M. S. Beal, executive vice president
ISD Incorporated, New York, New York*

SHAW-WALKER



Shaw-Walker's advanced Modular Work Stations are a beautiful way to achieve more effective use of office space and personnel — regardless of how big or how small your office, or what kind of work you do.

Flexibility is the keynote — to fit today's needs, tomorrow's changes.

All desk tops, desk drawers, files, and storage units can be interchanged, relocated . . . expanded or contracted. This lets you individualize all work areas to obtain greater productivity.

Each Station can also be planned to achieve *any degree of privacy* needed for confidential or creative work.

Stations can be aligned or repeated in a grid pattern, staggered in random arrangements, or clustered in groups, to fit any office layout.

To see our wide choice of modular components, phone your Shaw-Walker branch or dealer today. Home office: 41 Division St, Muskegon, Mich. 49443

ARTWORK

561 AUBUSSON TAPESTRIES / Ranging in size from 3 by 4 to 7 by 12 ft, the tapestries are contemporary examples of 13th and 14th century hand weaving techniques. They are made in France and designed by 27 leading artists. / Art Vivant, Inc.

562 ACRYLIC GRAPHICS / Original acrylic paintings made by hand are available in many designs to complement commercial interiors. Mounted on kiln-dried stretchers with canvas around the edges, units are lightweight. / Artifax Systems Ltd.

563 STEEL SCULPTURE / Scaled for use in interior and exterior display, these large, boldly colored serpentine forms are made of double-ribbed 14-in. diameter galvanized tubing. Each module weighs 150 lbs. / Brewster Corp.

FABRICS

564 VINYL UPHOLSTERY / The fabric features a soft and supple look of smooth grained leather, and is available in 12 colors. It is said to resist abrasion and is suited to contoured furniture. A non-woven foam backing is laminated. / Stauffer Chemical Co.

565 PATCH FABRIC / Woven in contemporary colors, this patchwork-like fabric is a combination of cotton, wool and rayon. It is offered in various sizes of the pattern. / Stendig Inc.

566 WOOL FABRIC / This 100 per cent wool fabric is 51 in. wide and offered in solid color warp with contrasting filler, with a striped effect in the weave. It is mothproofed and imported from West Germany. Fabrics may be purchased by the yard or used to cover the company's furnishings. / Stendig Inc.

567 FABRIC / Imported upholstery fabric is made of 60 per cent wool and

40 per cent rayon, finished with acrylic backing and mothproofing. Natural colors. / Stow/Davis Textile Div.

568 UPHOLSTERY FABRIC / Checks and stripes in deep textures are offered in small-scale motifs, in weaves reminiscent of gobelin stitching. In 52-in. widths, fabrics are woven in worsted wool in earth tones. Tightly woven for upholstery applications. / Isabel Scott Fabrics Corp.

569 IMPORTED FABRIC / Natural in coloring, and heavily textured, this imported fabric is primarily virgin wool with the addition of cotton and rayon, according to the company. Quick delivery from stock is promised. / Stow/Davis Textile Div.

FLOOR MATS

570 VINYL MAT / A lightweight, durable surfacing made of non-woven vinyl is said to trap dirt and let it filter through, keeping the surface clean. The material is an anti-slip surface type, recommended for either outdoor use in commercial and industrial applications. / 3M Co.

571 COMMERCIAL MATS / Monogrammed mats in 10 pile colors are offered, some in nylon and others in continuous filament olefin pile. All mats have solid vinyl backing which lays flat on any surface. The mats can be supplied in sizes up to 4 by 8 ft. / Crown Industries.

FURNISHING ACCESSORIES

572 CORK WALL COVERING *Houndstooth* is one of eight natural cork wall coverings, executed somewhat in the marquetry method, with tissue-thin sections of cork hand-cut and positioned on colored background paper. It is available in metallic gold or black. / Katzenbach & Warren, Inc.



561



562

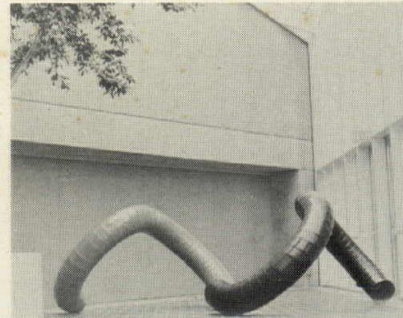

563

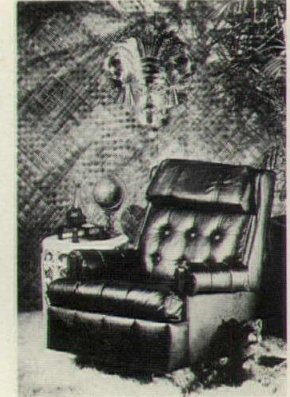

564

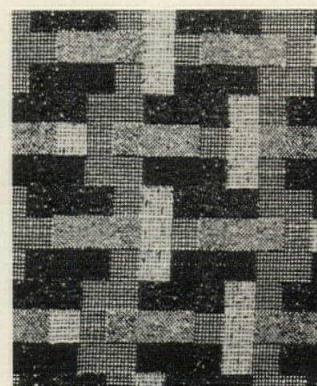

565



566

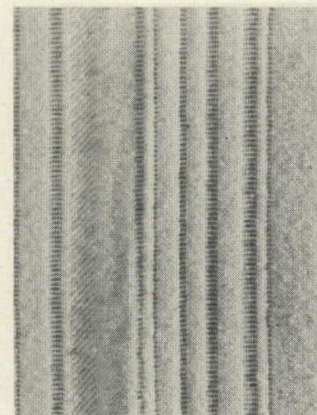

567

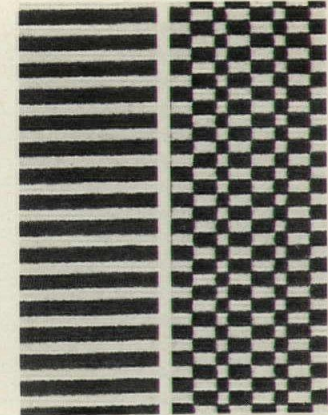

568



569



570



571

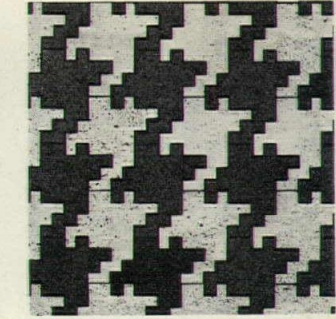

572

*Included in 1974 Sweet's Catalog File(s).

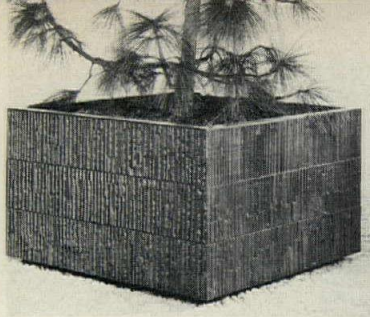

573

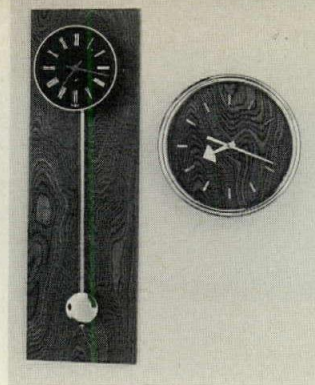

574

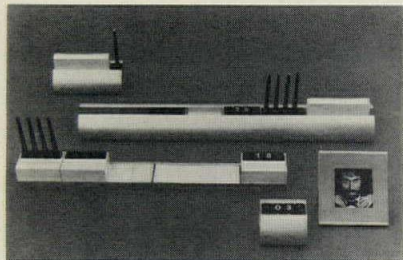

575



576



577

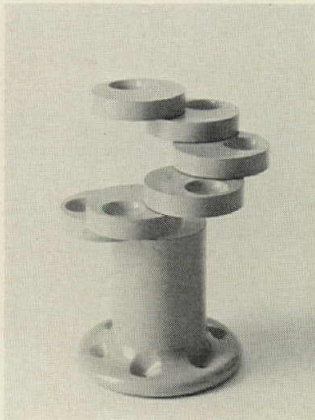

578



579

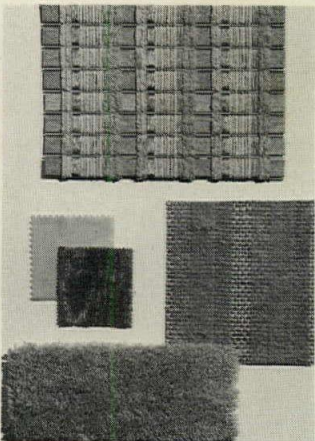

580

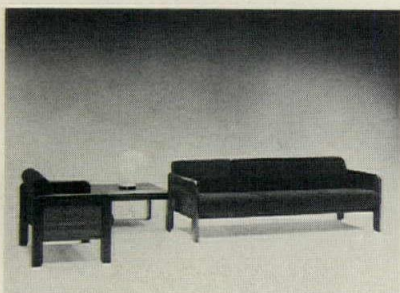

581



582

573 BRONZE PLANTERS / Offered in a wide range of sculptured textures and standard sizes from 24-in. square to 60-in. diameters, these planters may also be made to custom sizes. Interiors are sealed with fiberglass for water tightness. The planters can also be made in other metals, for interior and exterior use. / Forms & Surfaces.

574 ROSEWOOD CLOCKS / Rosewood teamed with chrome and aluminum produces these clocks designed by Arthur Umanoff. The pendulum model features a black dial with white numerals and red hour and minute hands. It is a wind clock and the other is battery operated. / Howard Miller Clock Co.

575 DESK SET / Designed and made in Italy, the set comes in brushed aluminum and in injection-molded ABS plastic and brushed aluminum. Through a combination of the components, numerous accessory functions can be accommodated. / Atelier International, Ltd.

576 CERAMIC PLANTERS / Accompanying saucers are introduced here for use with the company's line of cylindrical planters. Available in matte colors and brilliant reflective glazes. / Architectural Pottery, Div. of Group Artec. D*

577 PEDESTAL BASES / Strong polyethylene bases, with and without steel cores, are offered in diameters up to 30 in., in virtually any color. Bases are said to support 5,000 lbs. and offer wear resistance. / United Molded Products Corp.

578 UMBRELLA STAND / Made of plastic in five colors, the product consists of a column fitted with six rings which revolve when opened and each ring can be used to hold an umbrella. / Castelli Furniture Inc.

579 WALL HANGINGS / Part of a series of hangings called *Space Banners I*, this is a design of abstract flowers in two colorations: rust, scarlet, yellow and nutmeg on almond ground; or lilac, burgundy and dark brown on a cream ground. Banner measures 47 in. square. / Karl Mann Assocs.

580 CUSTOM WEAVING / This service is for designers who want a special woven pattern for window treatments. Executed in woven wood, designs can be open or close weave, with a variety of yarns and finished wood slats. / Del Mar.

FURNITURE

581 SEATING / With complementing occasional tables, the *Series 1000* is constructed of American Black Walnut with oil finish. A wide range of textiles and vinyl is offered. Square and rectangular tables come with walnut or laminate insert top. / Stow/Davis.

582 MODULAR OFFICE / A free-standing office system features walnut veneer units in heights up to 80 in. Case goods and work surfaces are 36 in. on center. The solid wood backs are said to form a sound barrier, but acoustical screens are also offered. / Nucraft Furniture Co.

583 DESK / Stainless steel, glass and stainless steel, glass and upholstery are featured in this desk with 4-in. wide bands of metal that can also be brass, aluminum, bronze and statuary bronze. Desk is 60 by 28 by 29 in. high, and can be covered in leather or vinyl. / Axius Designs, Inc.

584 WOOD DESKS / Three choices of wood desks are offered in varied pedestal heights and with matched veneers. Cube has optional chrome base. / Cramer Industries, Inc.

585 U-BEND TABLES / The table is a single sheet of 1/2-in. clear plate glass measuring 17 in. high, 40 1/2 in. wide and 24 in. deep. It is also available in a few special sizes, and in bronze and solar gray glass. / John Strauss International.

586 TABLE BASE / Made of beech wood, these bases are adjustable to several heights and each has two rubber pads on top to keep glass or wood top in place. Base size is 20 in. wide, 33 3/8 in. deep and 25 3/8 in. high. / ICF, Inc.

587 DESK / Designed by Davis Allen of Skidmore, Owings & Merrill, this desk consists of a unitized frame onto which panels are applied and into which drawers are inserted. An optional recessed back is offered. Matching pieces complement the desk which can be ordered in wood and steel. / GF Business Equipment, Inc. D*

588 DINING TABLE / The marble slab top appears to float above the base of this 40-in. square table. The top is actually held aloft by a base of solid stainless steel cross supports joined to tubular legs capped top and bottom with solid stainless. All grinding and polishing is by hand. Various top materials are offered. / Scope Furniture, Inc.

589 WOOD OFFICE / Contemporary wood desks and credenzas combine with metal in panel styling. Stainless steel bases and trim strips are optional on this series, with flush or re-

cessed three-quarter height back panels. Walnut and oak veneers are used. / Steelcase Inc.

590 SPACE SAVERS / Over 100 desks, credenzas and storage units are said to save space and can accommodate every work function, in standard or landscape offices. Walnut, teak and white plastic laminates are available. / Cramer Industries, Inc.

591 OCCASIONAL TABLE GROUP / A revival of the classic Bauhaus designs of Marcel Breuer, these tables are offered in chrome-plated tubular steel, with tops of smoked glass or plastic laminate. The tables are available in three sizes up to 20 by 48 in. wide and up to 21 in. high. / Thonet Industries, Inc.

592 PEDESTAL TABLE / Center pedestal models are said to accommodate virtually any size square or round top, and end leg models are offered for conference table size tops, both rectangular and oval. / Fixtures Mfg. Corp.

593 CONFERENCE TABLE / The flat-cut oak top with solid oak bull-nosed edge is supported on a heavy-gauge stainless steel column base. Table is available in several heights, sizes and top materials. / Scope Furniture, Inc.

594 POKER TABLE / Standing on legs of stainless steel is a top in gambler's green cloth carpet; each corner has rotating tables for drinks, noshery and the like and each table has an ash tray. Legs are 4 in. in diameter. / ICF, Inc.

595 DESK GROUP / Seven basic desk configurations are said to contain a range of combinations in groupings, materials, and colors. Wood, molded fiberglass, leather, chrome and nickel can be used to create an executive suite with a customized look, according to the company. / Directional Contract Furniture.

596 FILING CABINET / The cabinet comes with a pull-and-latch mechanism flush with the drawer front. Offered in 2-, 3-, 4- and 5-drawer models, in both legal and letter widths. Numerous finishes can be specified. / GF Business Equipment, Inc.

597 GLASS AND STEEL / This cocktail table, part of a glass and steel collection, features a top of 3/4-in. plate glass with 1-in. bevel, resting on a stainless steel cylinder. / John Strauss International.

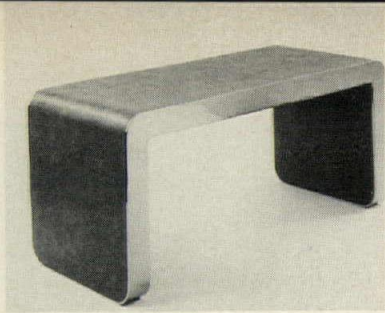

583



584

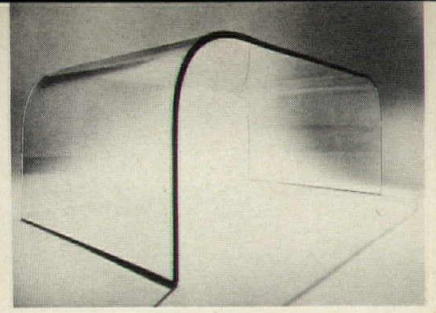

585

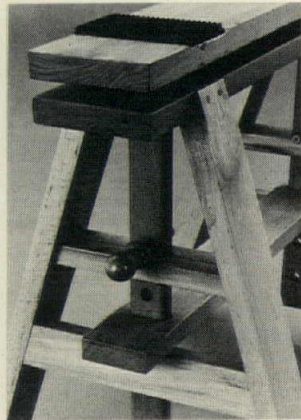

586



587



588



589



590

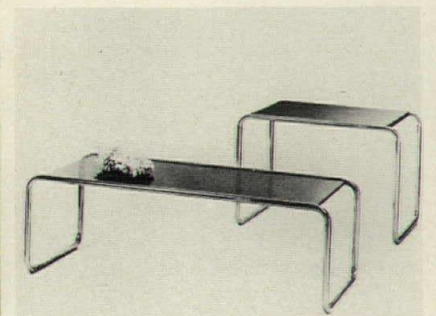

591

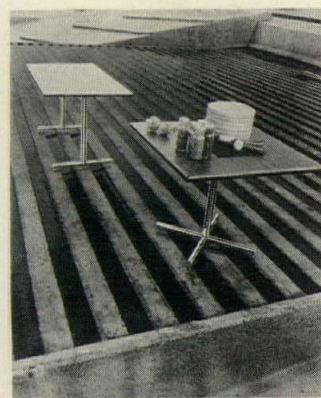

592



593



594

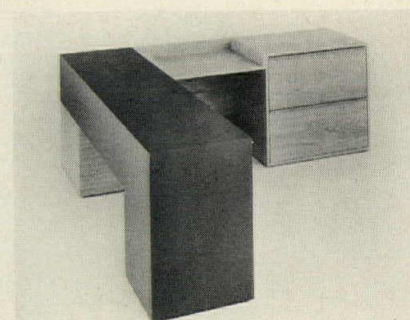

595



596

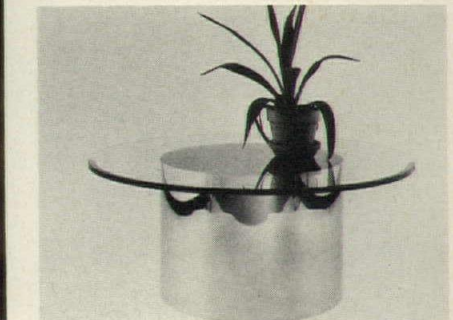

597



598



599



600

598 CREDENZA / Part of the "slab" series, this cabinet features a reveal outlining the doors. Unit is finished in a high-gloss polyester enamel in reflective jet black or pure white. Available in single, double, triple or quadruple modules in heights up to 30 in. A wardrobe height is offered at 59 in. / Harvey Probbler Inc.



601

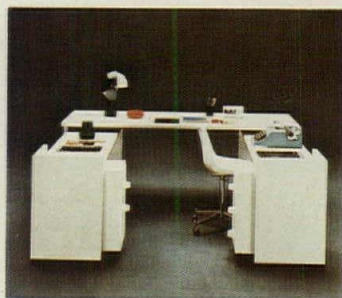

602



603

599 OFFICE SYSTEM / This modular system of unit assemblies is based on work surfaces and storage units supported by a set of end panels. Such innovations as tops that tilt and a choice of working surface heights are offered, along with many adjustment options and concealed wiring systems. / Steelcase.

600 WORK STATION / This 100-sq ft ensemble can accommodate a range of users from managerial through executive levels, according to the company. The free-standing conference table is backed up by an 80 by 100-in. work station unit composed of an 8-ft work surface, file drawers, storage and display components. Offered in oak veneer. / Herman Miller Inc.



604



605



606

601 BUTCHERBLOCK OFFICE / In 1½- and 2-in. widths, butcherblock laminates with radius edges are fitted together in this office series and a lounge group not shown. Hard edges can also be supplied on pieces and conference tables to match can be ordered. / Buckstaff Co.

602 DESK SYSTEM / The system is composed of plastic laminate desk tops and return panels; enameled structural steel "L" shaped bases; enameled steel file cabinets, stationery and mobile; and steel modesty panels for the cube appearance. A number of storage options can be added. / Atelier International, Ltd.

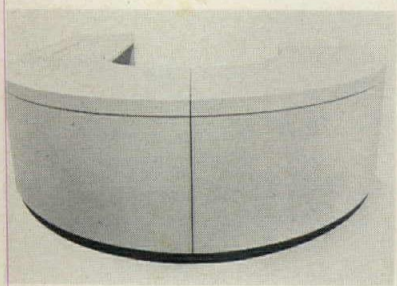

607

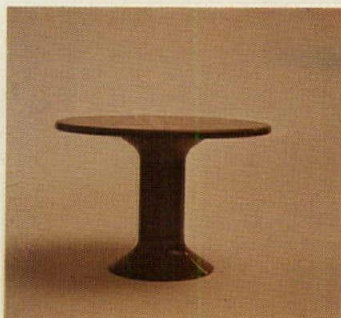

608



609

603 TABLE GROUP / The *Solar* group comes in round, rectangular or square shapes in many top patterns and colors in *Melamine*. There are also four slate and marble options. Tops rest on 2¼-in. triangular steel columns, with adjustable leveling glides. / American Seating Co.

604 WORK STATION / This modular group of sectional desks, with floor-deep pedestals, combines with the firm's sectional lateral files to make work stations like the open plan group shown. A wide variety of configurations exists. / The Shaw-Walker Co.

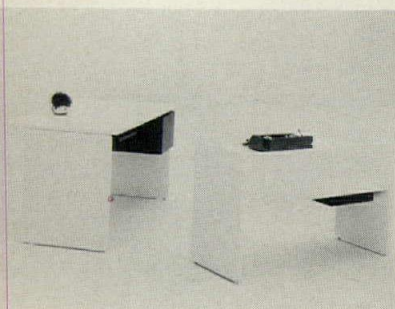

610



611



612

605 OFFICE MODULES / A line of free-standing and mobile tables is offered, with construction of high density particle board and high pressure laminates in neutral and wood grain finishes. The full line includes execu-

tive desks, credenzas and typing tables. Surfaces are said to be scratch-resistant and vinyl bumper and trim moldings are offered. / Modern Partitions, Inc. D*

606 OFFICE SYSTEM / Based on a system of metal space frames, the system consists of changeable non-structural panels available in a range of materials, plus work surfaces and storage cabinetry which lock into slotted frames. / Arcon Furniture. D*

607 SEGMENTED DESK / A reception desk of two joined quarter circle segments in white laminate features 1/8 in. reveal strips and a black laminate plinth base. The desk accommodates various pedestals, executive height or typing as shown. / JG Furniture Co., Inc.

608 SPOOL TABLE / Molded fiberglass components in a wide range of colors form several sizes of a strong table, with matching benches and stools for outdoor and indoor use. Table is offered in two diameters, 24 or 42 in. and in heights up to 28 1/2 in. / Arcon Furniture. D*

609 EXECUTIVE TABLE / Charles Eames has designed this table in round and oval shapes, with Italian white marble tops mounted on polished metal bases. The round model comes in four diameters up to 60 in. The oval model comes in two sizes up to 78 in. long by 42 in. wide. Heights on both shapes are 26 1/4 or 29 1/4 in. / Herman Miller Inc.

610 MINI-TABLES / Designed to provide rigid and free-standing work surfaces, which could be used separately or with the company's other lines, these tables can be easily knocked down and measure 60 by 30 or 48 by 24 in. Numerous configurations are claimed. / Sunar Ltd.

611 DESK / Available in decorator colors the desk features pedestals that extend to the floor, with two file drawers or four box drawers. A range of pedestal arrangements is offered. Flush drawer pulls and double-wall construction are featured. / Cole Div., Litton Industries.

612 OFFICE SYSTEM / With both straight and curved acoustical screens, the system includes a free-standing desk, a two-leg desk and a panel-supported desk. Tubular and T-leg styles are offered. / InterRoyal Corp.

613 WOOD FURNISHINGS / The company claims this line features optimum space utilization in delta and octagonal concepts. A complete wood line is offered. / Wood Design.

614 LATERAL FILES / This is said to be the nation's first fire-insulated lateral file. It is offered in six models, all

bearing the UL one-hour label. Letter, legal and print-out sizes are offered, for materials up to 12 by 15 1/4 in. / The Shaw-Walker Co.

615 PLATFORM BED / For dormitory use, this bed features all steel interior construction with laminate exteriors. Storage drawers operate on ball bearings. / InterRoyal Corp.

616 AXLE TABLE / Measuring 24 in. in diameter by 17 in. high, the table is available in clear 1/2-in. plate glass only, with satin finished stainless steel fittings. Also available in special sizes for conference and dining. / John Strauss International.

617 HOTEL BEDDING / Individually-pocketed coil construction with gold and white pathe quilt are features of this bedding on a plinth base box spring covered in vinyl. Eighteen vinyl colors are offered. / Simmons Co.

618 TABLE REPLICA / In mahogany with leather inset, this exact replica of a circa 1795 table-desk may be supplied with three drawers on the back as well. A pen tray is supplied in the center drawer and all drawers lock. / Kittinger Co.

619 FIBERGLASS LOUNGE / Molded sofas and chairs feature reflective mirror bases to give a floating illusion. Tables, planters, and other chair shapes are offered in many colors. / Cramer Industries Inc.

620 SPACE MAKER / For use in dormitories, the design features a red butcherblock desk, chest and bookcase which can be used separately or grouped for a continuous work surface. Conventional bed uses space below for optional drawers or trundle. / John Adden.

RUGS

621 WOOL RUG / This 100 per cent wool rug features red, black and white stripes, although custom colors are available. The curving stripes are incised, giving the rug depth. / V'Soske, Inc.

622 ENGLISH CARPETING / Made of 80 per cent wool and 20 per cent nylon, carpets in this collection are designs reproduced from antique documented warp prints from the Near East. Available in 30-yd minimums for residential and commercial use, the 14 designs all have matching borders. / Stark Carpet Corp.



613



614



615

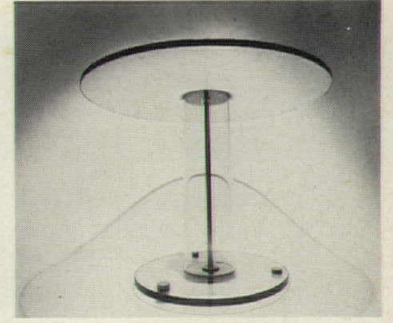

616

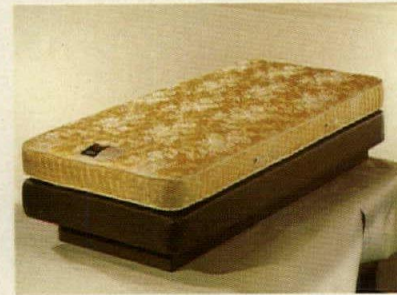

617

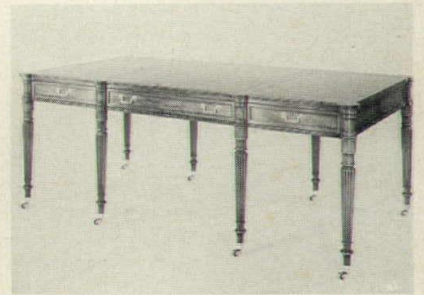

618



619



620



621

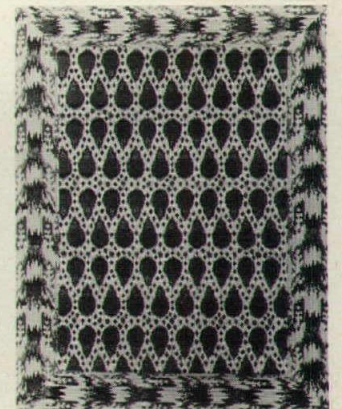

622



623



624



625



626



627

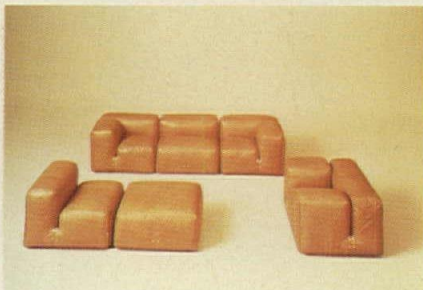

628

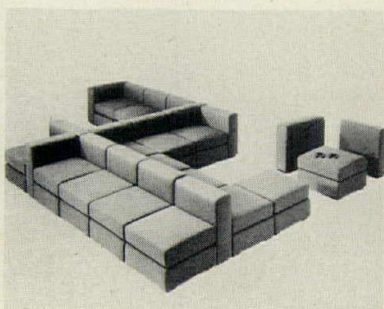

629



630



631



632

623 WOOL RUG / This is a 100 per cent wool product that interprets an old Middle Eastern design in a flat tapestry-like stitch. Light colors are used. / V'Soske, Inc.

SEATING

624 GANG-CHAIR / To stack or gang, this centilevered chair features a continuous steel frame in two sections. Plywood molded with phenolic resin under heat and pressure make up the shell, with upholstery clamped between the two panels. / American Seating Co.

625 SWIVEL ARM CHAIR / This chair is of molded urethane with a steel internal structure in the base, seat and arms. The upholstered seat and back are available in leather, vinyl or soft fabric. Fitted with casters. / Thonet Industries, Inc.

626 OFFICE CHAIR / A wide variety of seating configurations can be created from the many subassembly parts of this chair. A chair that stacks or gangs can be made, along with one with or without a tablet arm. The shell of molded nylon is anti-static and resists wear, according to the company. All bases are stainless, polished aluminum. / Atelier International, Ltd.

627 SECRETARIAL CHAIR / A choice of white, nutra, gray or walnut outer shell is offered with this contoured chair with chrome, brushed or mirror base. A selection of vinyls and fabrics is available, with or without tufting. / All-Steel Inc.

628 LOUNGE GROUP / The *Le Mura* collection consists of an armless chair, chair with left or right arm, two-arm chair, ottoman, single- and double-bed. Made of urethane foam, the collection can be covered in fabric, vinyl and leather. / Atelier International, Ltd.

629 MODULAR SEATING / Seating can be ordered as separate seats, backs and arms which are connected in the desired way, for continuous seating. Molded polyurethane construction, with reinforced nylon connectors. / ICF, Inc.

630 SOFT SEATING / Polyurethane injection molding combines with fabric to form the structure of this seating, with modular sofa components. Full range of coverings is offered. / Atelier International, Ltd.

631 SHOE FITTING STOOL / This stool of polished chrome—upholstered in soft fabrics and vinyls—measures 61½ in. wide, 20 in. deep and 18 in. high. / Thonet Industries, Inc.

632 SWIVEL CHAIR / A contemporary version of the Bank of England chair with slat back is made with arms and frame of curved 21-ply laminated oak plywood. The seat cushion is 3-in. thick urethane foam. / Harter Corp.

633 BODY CHAIR / A high-backed chair with fully upholstered arms has button tufting. Two shells of structural fiberglass are clamped together into a unitized construction. Ballbearing casters and a selection of fabrics are offered. / GF Business Equipment, Inc.

634 ADD-ON SEATING / *Digit* is a system of single elements of molded foam connected one to the other, until the desired length is achieved. Strong and comfortable, according to the company, this is an Italian design. / Stendig Inc.

635 EXECUTIVE CHAIR / The chair is offered with a choice of chromed steel or laminated wood base, with urethane seat cushions 6 in. thick. A higher-backed version is also available. / Harter Corp.

636 SWIVEL ARM CHAIR / A molded unitized polyurethane shell gives this chair rigid strength and contoured comfort, according to the company. *Scotchgarded* fabrics and vinyls are offered, along with a cast aluminum swivel base in several styles. / Consolidated Burris International.

637 CHAIR GROUP / Architect Warren Platner has designed this chair group, including both high- and low-back desk, conference and side chairs. Each back, seat and arm has an individually molded and upholstered inner cushion and outer shell. / Steelcase Inc.

638 HIGH-BACK CHAIR / Two-piece back and contoured seat are said to provide comfort in this chair. Choices of fabric and four outer shell materials are offered. Padded arms and tufting are optional. / All-Steel Inc.

639 SOFT SEATING / Low seating covered in a wide selection of fabrics, leathers, etc., this group features foam over wood construction. Chairs and two- and three-seat sofas are offered. / Stendig Inc.

640 SEATING GROUP / For residential and commercial use, this soft seating is offered in several sizes in a variety of leather, vinyl and fabric coverings. Foam over wood construction is featured. / Stendig Inc.

641 DINING CHAIR / Part of a line of natural pine seating and tables, this chair is made from random-width pine planks, with urethane seat and back. It can be upholstered in vinyl and fabric. / Thonet Industries, Inc.



633

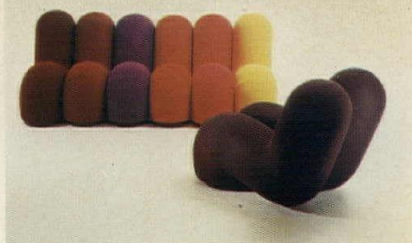

634



635

642 FEMALE CHAIR / The chair was designed to conform to the posture of the female body, resulting in fewer back problems, according to the company. One-piece shell construction, permanently bonded upholstery and nylon base bushings result in low maintenance, it is claimed. / Bridge-A-Back Inc.



636



637



638

643 EXECUTIVE CHAIR / Designed with ample proportions, this chair features two cushions hooked together for the seat and back, each with varying densities of rubber to provide support as needed. Frame is hardwood and base is solid stainless steel, mirror polished. / Scope Furniture, Inc.

644 SWIVEL CHAIR / These chairs have a two-piece back to give comfort and support, according to the company. Contoured seats and backs, double action torsion bar control and adjustments for individual comfort are featured and a choice of outer shell, base finish and upholstery is offered. / All-Steel Inc.

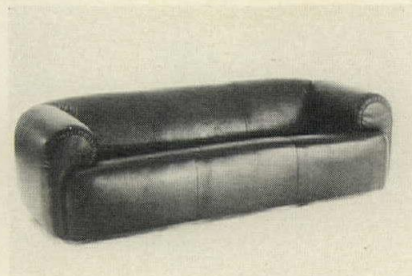

639



640

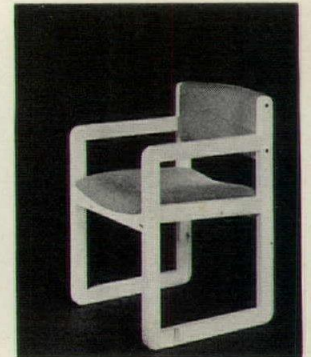

641

645 LOUNGE SYSTEM / A system of plug-ins, this group features arms that may be plugged into the ends of seat units without tools. Constructed of internally supported, layered foam. / Vecta Contract Co.

646 SECRETARIAL CHAIR / With five simple adjustments, according to the company, this chair by Charles Eames will become customized to the user. A fiberglass reinforced seat and back comes with molded urethane foam cushioning. / Herman Miller Inc.



642



643



644

647 CONTRACT SEATING / A complete contract seating program consists of the Nova shell and various hardware support elements with tables and other accessories. Chrome-plated heavy gauge steel framing combines with a durable polypropylene shell, offered in white, orange, tan and bottle green. / Atelier International, Ltd.



645



646



647

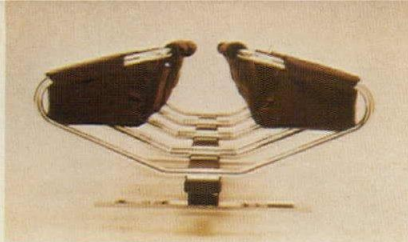

648



649



650



651



652



653



654



655

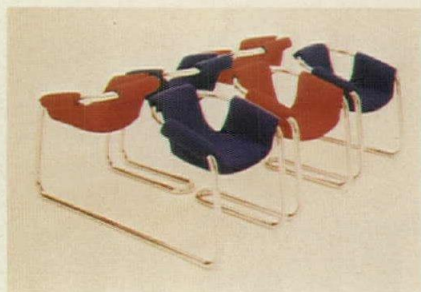

656

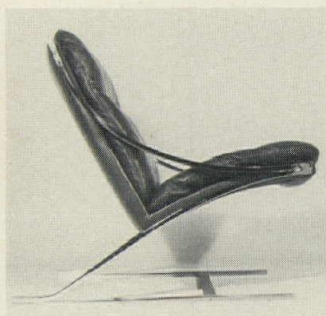

657



658



659



660



661



662

648 CANTILEVER SEATING / This public seating features frames cantilevered from a single black beam. Recommended for mass seating applications. / Vecta Contract Co.

649 STACKER / A sled base stacking chair features a chromed tubular steel frame and tilt-up seat. The copolymer seat and back can be upholstered with nylon or vinyl over foam rubber in a wide selection of colors. Stacking increment permits 25 chairs to a dolly. / American Seating Co.

650 LOUNGE CHAIR / For use in hotels, or anywhere the rustic look is desired, this lounge group is offered in natural pine in simple box-like shaping. Pine planks are joined together by exposed bolts. Urethane cubes can be covered in vinyl or fabric. Tables and dining chairs to match are offered. / Thonet Industries, Inc.

651 FOLDING ARMCHAIR / The frame is made of polished aluminum tubing, with a matching self-locking pivot. The shell is in neutral or smoke transparent plastic or in black and red non-transparent ABS plastic. The shell can also be covered in six colors of vinyl. / Castelli Furniture Inc.

652 ARMCHAIR / Another revival of the now-favorite Wassily chair, named by its designer Marcel Breuer for artist Wassily Kandinsky, this version is offered in black or natural leather, on tubular steel. / Thonet Industries, Inc.

653 SOFA, LOVESEAT / An armchair joins this group with solid oak exposed frames. Glides are adjustable. Polyurethane-filled backs and seats feature double needle stitching for long wear in public areas, according to the company. The table top is finished in brown suede laminate. / Thayer Coggin Institutional, Inc.

654 CONFERENCE GROUP / Part of the company's *Straessle* collection from Switzerland, the *Zeta* group features chair and table bases of polished chrome plating. Chairs are upholstered in soft leather. / Thonet Industries, Inc.

655 SECRETARIAL CHAIR / This three-adjustment chair has a mirror-chrome finish and is available in any of the company's standard upholsteries. / GF Business Equipment, Inc.

656 CONTINUOUS SEATING / This modestly priced system converts the company's *Zermatt* chairs into connected seating, permitting quick rearrangement or conversion to indi-

vidual chairs without tools. Seat slings may be replaced in minutes, according to company. / Vecta Contract Co.

657 LEATHER CHAIR / Designed by Paul Tuttle for the *Straessle* collection of Switzerland, this chair has a base made of bar stock steel with highly polished chrome plating. Soft leather seat and back cushions. / Thonet Industries, Inc.

658 SIDE CHAIR / Imported from Italy, this chair for conference or dining features a cantilevered base of steel tubing, chromed and mirror-polished. Upholstery: foam on plywood. Chair can be covered in fabrics, leathers, suedes or COM. Seat height is 18 in. / Stendig Inc.

659 LOUNGE GROUP / Plump urethane cushions are strapped to a chrome-plated tubular steel frame in this group, with a chair, and two- and three-seat sofas. Vinyl and fabric upholstery is offered. / Thonet Industries, Inc.

660 WAITING ROOM CHAIR / In the semi-lounge height, this Swiss design features a solid steel, chrome-finished frame, with foam over wood construction. A side chair and arm chair are available, covered in leather and suede only. Chair is 30 in. high. / Stendig Inc.

661 RIETVELD CHAIRS / Both *Red and Blue* (shown) and *Zig Zag*, the classic chair designs by Dutch architect Gerrit Thomas Rietveld are being reproduced in solid beechwood, with or without clear polyurethane finish and polychrome aniline stains. These are exact reproductions. / Atelier International, Ltd.

662 PUBLIC SEATING / Islands of seating modules in a wide range of fabrics can be created with this fiberglass seating. Dividers and tables can accommodate built-in ashtrays. Recommended for heavy-duty areas. / Arcon Furniture. D*

663 ISLAND SEATING / Designed for infinite possibilities in omnidirectional seating, *Hexabloc* features foam molded around welded steel frames. Foam is said to be flame-retardant and self-extinguishing. An ebonized wood hexagonal plinth base is optional and coordinating tables are offered. / Harvey Probbler Inc.

664 PULL-UP CHAIR / This slat-back chair is made of solid Appalachian oak, with legs rounded and arms curved and rounded except on top. The seat is cushioned with 3 in. of urethane foam. The chair is offered in natural oak, medium dark oak or dark oak finish. / Harter Corp.

665 WORK CHAIR / The incorporation of pneumatic cylinders combined with the pentapod base provides, according to the company, maximum stability and support and prevents strain and fatigue by allowing instant adjustment to fit the posture of the user. / Designcraft.

666 LOUNGE SEATING / Upholstered seating designed by Milo Baughman is foam and polyester fiber-filled, with double needle stitching for durability. Glides are adjustable. A self-extinguishing foam is offered. / Thayer Coggin Institutional, Inc.

667 TRACTOR SEAT / The structure is chromium-plated steel and the springy seat is lacquered steel in several bright colors. The base is wood. / ICF, Inc.

668 CHAIR & POUF / From Italy, this ensemble is made of foamed polyurethane, with a cover that can be removed for cleaning. Available in a selection of fabrics, leathers suedes or COM. / Stendig Inc.

669 PRIMATE SEATING / As the name implies, the chair is meant for sitting in a "natural" position, with knees on the lower cushion and the posterior propped on the cushion above. Polyurethane is the stuffing and structure, with black polystyrene base. Leather or vinyl coverings are offered. / ICF, Inc.

670 BAUHAUS CHAIR / Designed for the company by Mies van der Rohe, this polished chrome cantilever style features natural woven reed seat and back. Circa 1930. / Thonet Industries, Inc.

671 TANDEM TABLE, SEAT / A simple clamping device enables any one of four table top shapes to be attached to the company's line of tubular seating. The whole group can be arranged in configurations of varying degrees. Table tops come in black or grey plastic laminated with black vinyl edges. / Herman Miller Inc.

672 OFFICE CHAIR / This line features a concealed spindle and resilient ABS outer shell with protective vinyl molding over fiberglass reinforced rigid urethane inner shell. An armless chair and secretarial model is also offered, all in a variety of fabrics and vinyls. / Emeco Industries, Inc.

673 ARM CHAIR / A fully-upholstered closed back, angled legs and an "X" support frame in lieu of stretchers are design features of this pull-up solid oak chair. Chair is offered with urethane cushioning and in a choice of natural, medium dark and dark oak finishes. / Harter Corp.

663



665



667



669



671

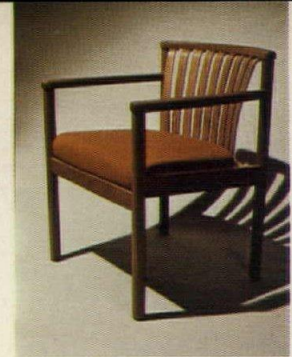

664



666

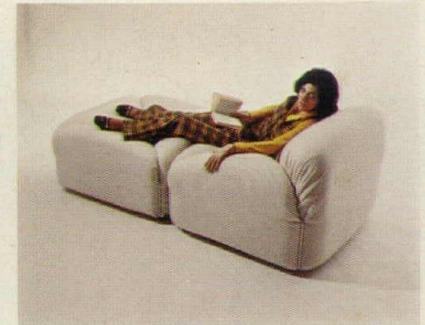

668



670



672



673

*Included in 1974 Sweet's Catalog File(s).



674



675

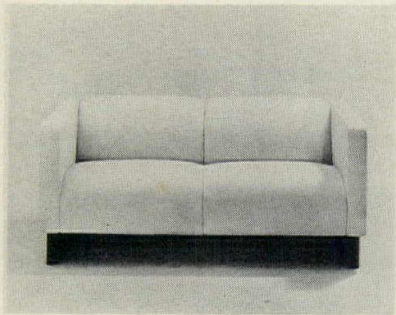

676



677



678

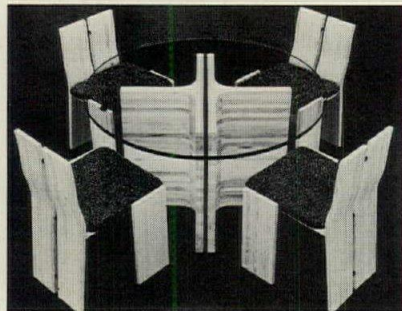

679



680

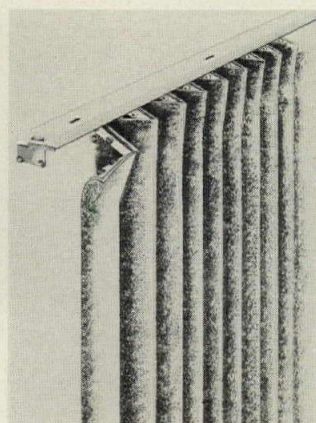

681

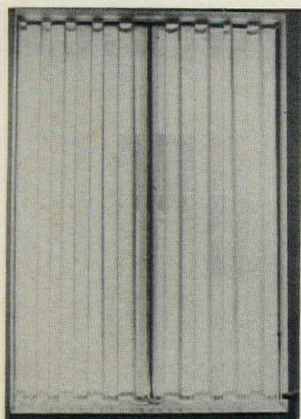

682

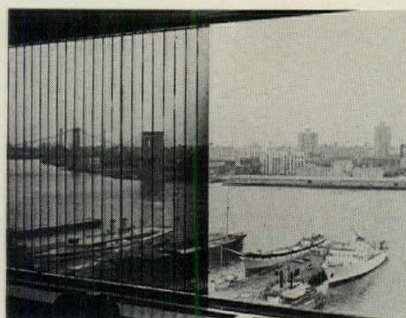

683

674 ARMCHAIR / This fiberglass armchair comes with an optional upholstered foam seat shell within a molded outer shell. Available in five high-gloss colors plus black and white. / Arcon Furniture. D*

675 ARMCHAIR / A Bauhaus revival of this Breuer design features chrome-plated tubular steel, with natural woven cane seat and back. Armrests are steam-bent natural beech. / Thonet Industries, Inc.

676 MODULAR SEATING / Arms can be used at either end of the unit, inserted between seats or eliminated. Construction features a hardwood frame, with latex foam rubber and no-sag springs. / Scope Furniture, Inc.

677 BAR STOOL / A raised "X" of molded fiberglass supports a bar height column of stainless steel on which sits a square seat upholstered in leather or vinyl. A small but explicit back rest is included. / ICF, Inc.

678 BUTCHERBLOCK SEATS / A simple box form is executed in natural butcherblock wood, with loose Dacron-wrapped polyurethane foam cushions. The open frame is strapped with Pirelli rubber webbing. Seat height is 14 in. A complementing table is available. / John Adden Assocs.

679 DINING GROUP / Natural pine in 1-in. strips is fashioned into chairs and a table base in this series. The T-shaped table base can take either a 55-in. round glass top or a rectangular one. The group is also offered with an aniline red dye finish. / Thonet Industries, Inc.

WINDOW TREATMENT

680 BLINDS / This product features 1-in. headrail and slim slats with narrow bottom rail, "invisible" cord tapes and over 40 colors, according to the company. Custom colors are offered. / Marathon Carey-McFall Co. A, D*

681 DRAPERY HEADING / This system of custom-cut, ceiling-mounted traverse track is equipped with pre-spaced snap carriers. Pleats form automatically when drapes are hung. The system is said to save up to 8 in. of fabric per panel over regular pleated drapes. / Kirsch Co. A, D*

682 SOLAR CONTROL / The *Vari-Lux* system features a drapery construction of fabric integrated with vertical louvers, that on one track, open all the way or provide almost complete light block-out. Open weave fabrics in wool, fiberglass and synthetic combinations are offered. / Isabel Scott Fabrics Corp.

683 VERTICAL BLINDS / Reflective perforated *Solar Mist*, with hundreds of holes per sq in., is a material used to impart a see-through quality to these vertical blinds. The material is PVC with a metalized polyester film laminated to each side, forming a vane with reflective surfaces. / Verticals Inc. A, D*

684 DRAPERY TRACK / Recommended for heavy-duty use, the system uses a cord-free PVC channel with nylon hangers. The system is 3/16 in. thick and can be used for curves, angles, corners or straight runs and fits any window, according to the company. / Proven Products, Inc.

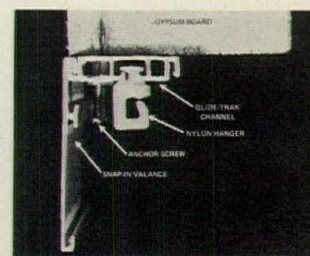

684



NEW!
PLANTS & PLANTERS

Bring the outdoors inside with our interesting, verdant plantings. In round and rectangular planters. Eight warm colors in fiberglass. Or warm walnut solid hardwood.

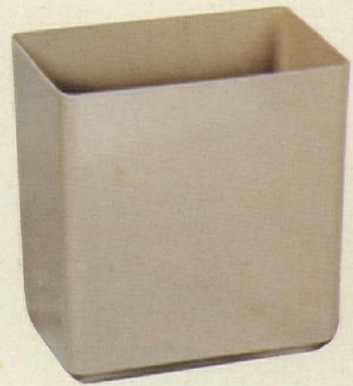

NEW!

WASTEBASKETS

Modern, crisp, clean-line look. Unbreakable in five decorator colors, three super sizes. All exceed government specifications for fire resistance.

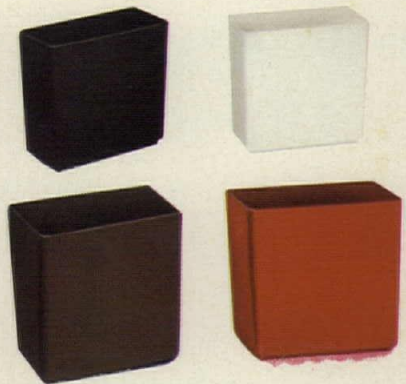

NEW!

UMBRELLA STANDS

Round and rectangular. Constructed of tough Cycolac®. Five fair weather colors. Unbreakable, leakproof and rustproof.



\$21.50 list, or less

Check out the newest FROM McDonald Products.

NEW!

ASH RECEPTACLES FOR WALL AND CHAIR MOUNTING.



\$5.50 list, or less

Wall unit
Put 'em up! Fast! Adhesive or bolt-on style. Slim functional design. In basic black.



\$3.90 list, or less

Chair unit
Neatness counts!
Economical way to furnish fingertip convenience. Fits various size tubular-leg chairs.



Write for complete, full-color catalogs
McDONALD PRODUCTS CORP.
721 SENECA STREET • BUFFALO, NEW YORK 14210

SUBSIDIARY OF
insilco

For more data, write A53 on inquiry card



**INNOVATORS IN OAK SINCE 1850
COMMERCIAL**

by buckstaff

oshkosh, wisconsin

showrooms: chicago, merchandise mart; dallas, oak lawn plaza



**INNOVATORS IN OAK SINCE 1850
COMMERCIAL**

by buckstaff

oshkosh, wisconsin

showrooms: chicago, merchandise mart; dallas, oak lawn plaza

Spotlight on Engineering for Architecture

Architectural Record is planning a timely expansion of its editorial services to engineers, architects and the manufacturers who market to them.



ENGINEERING FOR ARCHITECTURE

A Spotlight issue devoted to a highly professional presentation and analysis of the most significant developments in engineering for building—featuring:

- the engineer resources: the right way to use the right people to get the right expertise at the right time.
- the technical resources: an overview of the current state of building technology, with a particular look at the most important developments.

Scheduled for publication in mid-August 1974 and annually thereafter.

A McGraw-Hill Market-Directed Publication

ARCHITECTURAL RECORD

1221 Avenue of the Americas, New York 10020

For more data, write A54 on inquiry card

In 1970, in response to the upsurge of activity and interest in design of interiors by architects around the country, ARCHITECTURAL RECORD established a new editorial awards program—RECORD INTERIORS.

Recently completed architect-designed interiors of all building types will be considered—remodelings and renovations as well as new structures—anywhere in the United States. Selections will be made by the editors on the basis of the excellence of the design solution for the particular client's individual program. Submissions from architects of new, unpublished work will be welcomed through November 15, 1973. No formal presentations are required, though materials submitted should include plan, photographs or snapshots, and brief description of program.

RECORD INTERIORS of 1974 will be published in the January 1974 issue of ARCHITECTURAL RECORD.

Write or telephone:
Barclay Gordon
ARCHITECTURAL RECORD
1221 Avenue of the Americas
New York, New York 10020
Telephone (212) 997-2334

RECORD INTERIORS

to be featured in the January 1974 issue



Corporate dining at Squibb & Sons, Inc. Headquarters, Lawrenceville, N.J. Architects: Hellmuth, Obata & Kassabaum, Inc. Alexandre Georges photo.

Every architect registered in the United States may submit material for consideration in RECORD HOUSES and Apartments of 1974 awards program. Single-family houses and multi-family buildings that represent today's wide variety of design approaches will be featured in the nineteenth issue of the magazine. Include the following: 6 to 10 clear informal photographs, black-and-white preferred, fully describing the architectural intent, both on the exterior and the interior (35 mm. slides must be in 8½ x 11 in. clear envelopes); relevant plans and sections and a descriptive sheet including the architect's name and location of building. Do not send originals or other material which must be returned before issue appears. Deadline is November 15, 1973.

Send material to:
Barclay Gordon
ARCHITECTURAL RECORD
1221 Avenue of the Americas
New York City 10020
Telephone: (212) 997-2334

RECORD HOUSES AND APARTMENTS

for the 1974 Mid-May issue



Schwaikert House, Salisbury, Connecticut. Architect Hugh Newell Jacobsen. Robert Lautman photo.

All-Steel makes
more than good furniture.



It makes good business sense, too.

Whether your requirements call for conventional or open space planning consider All-Steel. Your clients will appreciate the economies of investing in quality furniture they'll never outgrow. You'll like the contemporary design and the way All-Steel fits into your plans . . . no matter how many times they change to meet your client's growing needs.

Write All-Steel Inc., Aurora, Illinois 60507. Showrooms in New York, Los Angeles, Chicago, Aurora. In Canada, All-Steel Canada Ltd., Montreal, Toronto.

All-Steel[®]
one of the **CFT** companies

For more data write A75 on inquiry card

Architects, engineers and builders alike are facing new design criteria which increase their already complex responsibilities and affect building design, construction techniques and costs.

The building materials industry is similarly affected. Most leading manufacturers are expanding their research facilities and staff to meet the demand for new materials and systems required in the changing construction market place.

The Occupational Safety and Health Act (OSHA) which promulgated stringent Federal safety regulations caused one of the new criteria facing our industry today. The OSHA criteria are involved with virtually every aspect of building design ranging from the silencer on an air compressor to the cover on a circuit breaker junction box.

In the field of noise control alone, completely new approaches to the human environment have had to be taken. Source, path and personal noise abatement techniques are now a design consideration in virtually every new industrial plant and in many commercial buildings as well. A maximum permissible noise level of 90 dB-A has become a minimal specification with many owners; some expect 85 dB-A and others as low as 78 dB-A.

New faces at the building design and construction meetings are appearing in the person of the corporate safety engineer, the industrial hygienist and even the client's medical director.

New building materials and systems are available to meet these requirements, ranging from sound absorption systems which provide anechoic properties ($NRC = .99$) to massive acoustic movable wall systems ranging over 40 feet in height and 300 feet in width (NIC 35-45). Complete systems are also being furnished on a modular basis which include all electrical, plumbing and ventilation services, intake and exhaust silencers plus sound and weather proof housings delivered assembled on a turn key basis where quick turn around and one-source, one-responsibility are design requirements.

*John M. Hanley
Vice president, Industrial Acoustics Co., Inc., Bronx, New York*

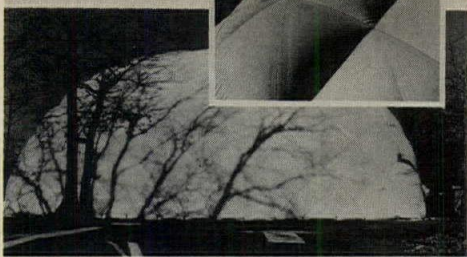

693



694



695



696

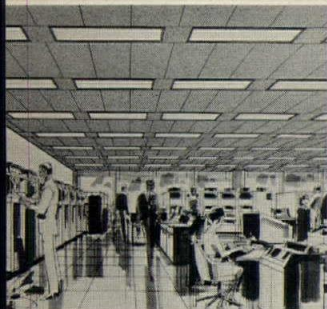

697

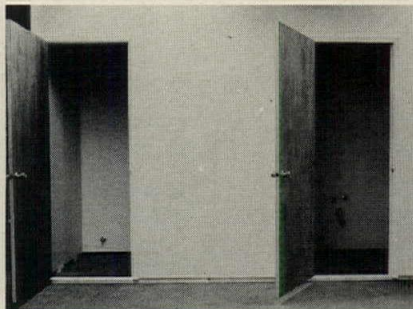

698



699

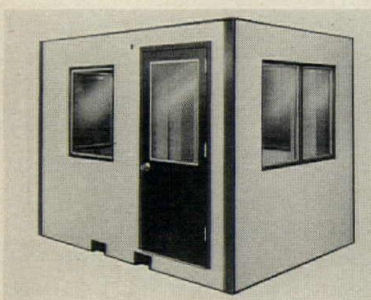

700

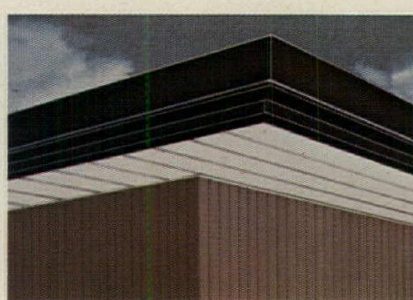

701

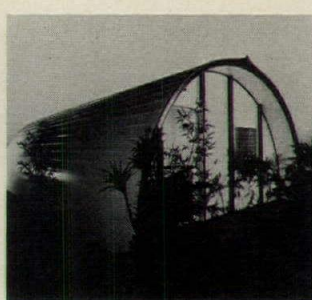

702

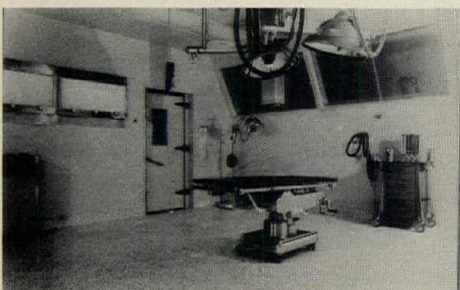

703



704

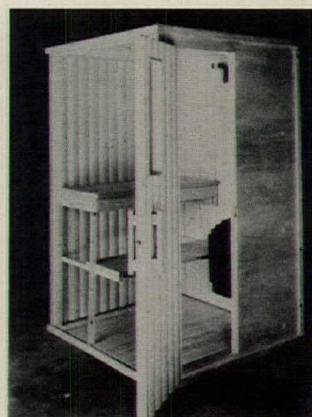

705

AIR SUPPORTED STRUCTURES

693 HARNESS SYSTEM / For air-inflated structures, this harness system consists of ground-anchored, prestressed vinyl-coated metal cables criss-crossing on the bias. The small tension-free sections created are said to prolong fabric life. / Air Tech Industries, Inc.

INTEGRATED CEILINGS

694 CEILING SYSTEM / *Levelok* attaches directly to metal deck and has been designed specifically for use with the Robertson *Q-Lock 99* decking. It provides a wall-to-wall monolithic appearance with no exposed grid work. Three panel tile patterns are offered in a 12 by 48 in. size. / Armstrong Cork Co. A*

695 MODULAR CEILINGS / *Envelite* modular ceilings are ready-to-hang panel and frame systems, with handmade multi-colored and translucent panels. System may be used as an illuminated ceiling or as island inserts. Fluorescent or incandescent lamps may be used. / Envel Design.

696 LIGHTING-CEILING SYSTEM / A complete 5- by 5-ft system, this incorporates acoustics and air distribution. The *SPEC 100* system was designed to offer appearance at a cost lower than similar individual components; 40-watt U-lamps are used. / Keene Corp. A*

697 INTEGRATED CEILING / A flat ceiling system features a concealed grid and an efficient lighting fixture that measures 1 by 4 ft. The configuration of the system is based on a 5-ft module and ceiling panels measure 20 by 48 in. Air handling and acoustical control are included. / Armstrong Cork Co. A, I*

PREFABRICATED BUILDING

698 BATHROOM CORE UNIT / A low-cost unit consists of walls with vinyl surfaces, in which the plumbing is built-in, along with sprinkler system, doors, window, and moldings. Can be furnished with standard fixtures, factory or site installed. / Stahl Industries, Inc.

699 SPACE GRID / A 5-ft modular system offering maximum space use flexibility and climate control is said to be adaptable to any shape building, even multi-story. Air distribution-lighting elements are located in the ceiling. Partition arrangement or expansion can be accommodated. / Butler Mfg. Co. A*

700 PORTABLE ENCLOSURE / This factory-finished unit complete with pre-painted metal panels and steel framing may be delivered with lighting, power, air-conditioning and double-glazed windows. The unit can be easily moved by fork lift truck. / Flangeklamp Corp.

701 FLAT-ROOF BUILDING / With a minimal slope of $\frac{1}{8}$ to 12, the roof of this building appears flat. The series is available in standard interior clear spans from 40 through 80 ft widths. With 20-, 25-, 30- and 35-ft bay spacing options, the buildings come with 5- or 10-ft overhangs. A choice of metal or built-up roofing is offered. / Stran-Steel Corp. A, I*

702 PLASTIC HOME / Measuring 16 ft wide by 32 ft long and 9½ ft high, this thermoplastic house can accommodate seven, according to the company. It includes three bedrooms, bath, kitchen and living room and is completely furnished in appliances, plumbing fixtures, etc. Structural changes for customizing can be made. / Universal Housing Systems of America.

RADIO-FREQUENCY SHIELDING

703 RADIO SHIELDING / For operating rooms this prefabricated modular construction system protects against X-ray radiation and radio frequency signals, according to the company. / Ray Proof Corp. A*

SPECIAL PURPOSE ROOMS

704 GREENHOUSE / This is a portable, modular, starter greenhouse that can be extended as long as 20 ft. It is basically 8 ft high, 6 ft wide and 4 ft deep, with rigid tubular plastic framework that snaps together. / Casaplanta.

705 FINNISH SAUNA / Featuring half-round white logs of pine wood, the product is pre-wired to U. S. standards and available in a variety of styles and sizes. Fully equipped from stove to bucket. / Helo Marketing, Inc. A*

706 HOME SAUNA / This two-person sauna is redwood lined and operates on regular house current. No special drains, wiring or flues are needed. Four pre-built units range in size up to 6- by 12-ft. Complete with benches and UL-approved. / Viking Sauna Co. A*

707 SOUNDPROOF OFFICE / This portable structure comes in modular sections with many options, according to the company, to meet strict noise control regulations. Full height or half height windows, doors, ventilation, power and lighting are included. / Ray Proof Corp. A*

708 PACKAGE SUBSYSTEMS / Designed for use in multi-family housing, these systems are said to fit any type of building system and are plumbed and wired. Individual kitchens, baths, utility rooms or a combination of these are offered, each delivered in a single weatherproof package. / Westinghouse Home Systems Dept.

709 SOUND CONTROL UNIT / A portable sound control building in a variety of sizes features heavy-duty steel panels, 360 degree vision, vinyl flooring, acoustical ceilings, single or double glazing, etc. Many options are offered on this unit, to solve implant noise problems. / Keene Corp.

SOUND & VIBRATION

710 CEILING HANGER / These ceiling isolation hangers combine steel springs and neoprene isolation elements for maximum sound and vibration attenuation. The hanger rods can swing a full 30 degrees with short circuiting, and are furnished with eyes for attachment to rods or straps. / Mason Industries, Inc. A*

711 FLOATING FLOOR JACKS / These isolators are said to eliminate formwork when pouring concrete floors. The bell-shaped screw jacks containing neoprene elements are tied to the reinforcing steel and rest on plastic sheeting during the pour. The entire floor is lifted by turning the adjusting bolts to establish an isolated air gap of 1 to 4 in. / Mason Industries, Inc. A*

SWIMMING POOLS

712 POOL COPING / This pool coping provides continuous overflow along the entire pool perimeter, according to the company. Product is said to eliminate make-up water tanks and has no buried piping. Available in a selection of patterns, textures and colors. / Kinematics Ltd.

713 SAUNA POOL / This one-piece fiberglass pool features a water jet that mixes water with air for a massaging effect, according to the company. Jets in various sizes are offered for combination with the pool, which can be ordered in sizes up to 8- by 10-ft. / Holiday Pools Corp. A, L*

714 LEARNER POOL / Uniform water depth and heating are featured on this learning pool in which the water can be adjusted from a few inches to 2½ ft. The pool is 5½ ft wide, 35 ft long and 3 ft high. Made of fiberglass, it comes with heater, filter, circulating pumps and accessories. / Miracle Recreation Equipment Co.

715 POOL DECKING / The company's interchangeable plan for one-meter and three-meter deck equipment is said to permit the architect to order new or replacement pool deck equipment in thousands of variations of materials, lengths, pedestals, superstructures and accessories. / KDI Paragon Inc.

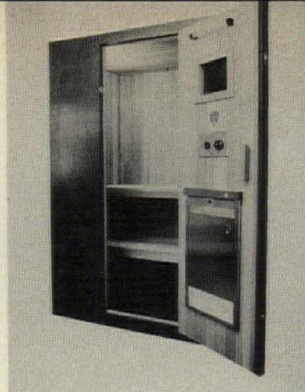

706

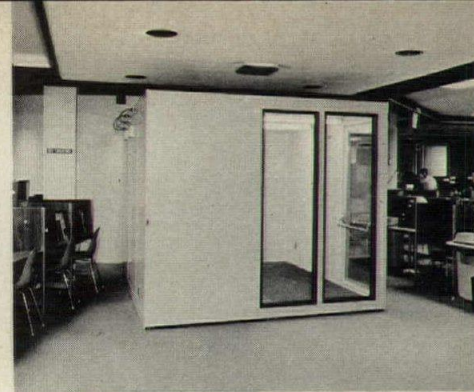

707

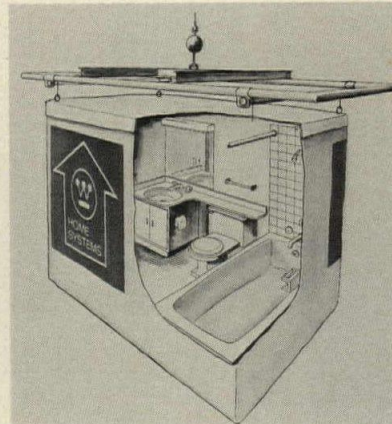

708



709

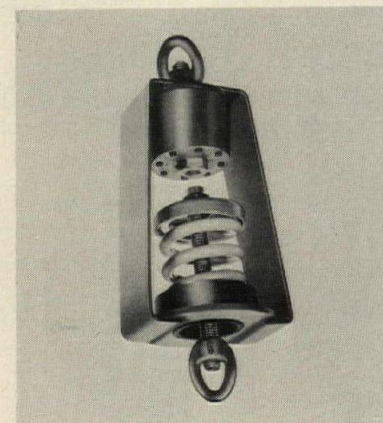

710

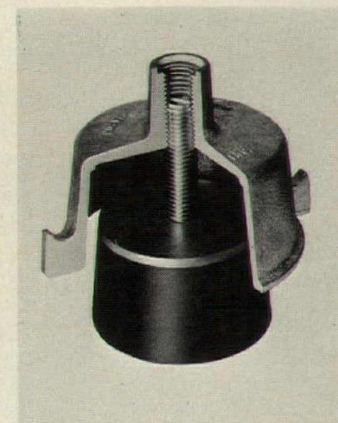

711



712



713



714

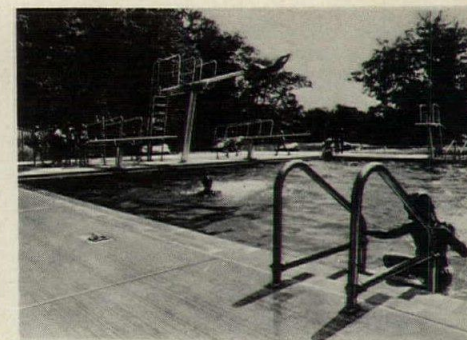

715

DIEBOLD® rally post ...delivers

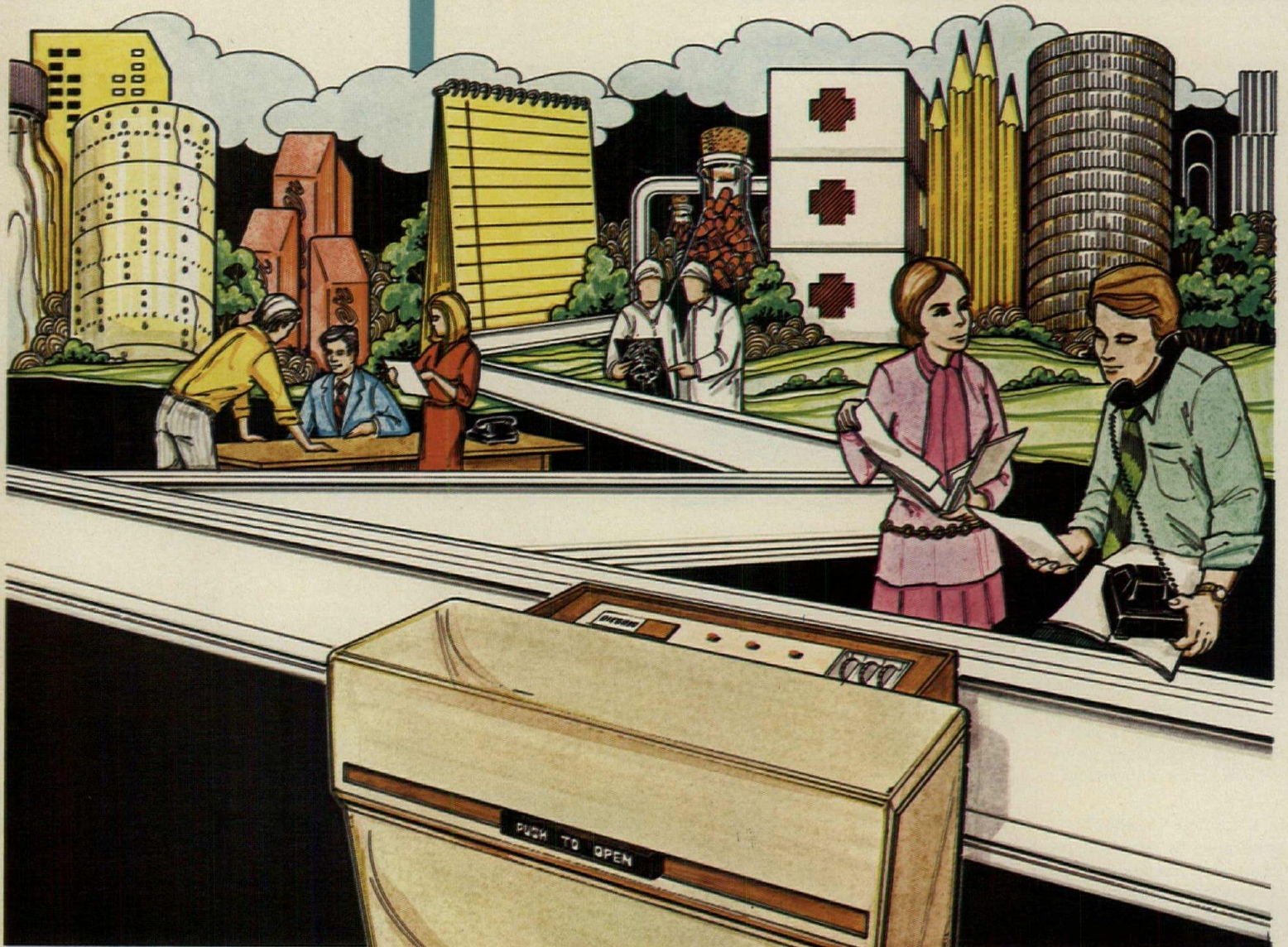

... mail, supplies, files,
EDP media, checks, reports,
x-rays, liquids.

Diebold® Rallypost delivers with
self-powered cars that travel a network
of vertical and horizontal track connecting
various user points.

Rallypost delivers 24-hour dependability (even
during power failures), low maintenance, easy
installation and modification, and quiet operation.

Above all, Rallypost delivers economical, efficient materials
distribution to your doorstep.

And Diebold delivers too ... with people, equipment, technical
know-how, and service, all working together for you.

*If you want to know more
about Rallypost, your request
will bring detailed information.*

DIEBOLD
INCORPORATED
LAMSON DIVISION
SYRACUSE, N.Y. 13201

"We know how to help you"

For more data, write A56 on inquiry card

conveying systems uci 14

The field of conveying systems is one of the most aggressive in the building industry in terms of change. Three trends in this regard deserve special mention:

1. *Industrial consolidation and integration*

Major industrial firms in the conveying system industry tend to absorb more segments of the industry, and to develop products and processes which generate conveyance demands. Conversely, firms concerned with processing products extend their activity to include conveyance equipment for integrated performance.

2. *Technological change*

American and foreign industry continues to increase the array and diversity of conveyance systems with improved performance characteristics. Better loading, dispatch and control systems permit application of conveying systems to broader areas of use. Individualization of conveyance systems, both for goods and people is increasing rapidly, for such diverse needs as airport people movement and small parcel delivery within building complexes. Research and development continues with the computer as integrator of conveyance control and inventory, and with linear motor and air cushion systems.

3. *Conveyance system design tools*

The demands for conveyance, particularly where complex and multiple systems are involved require more accurate portrayal for design resolution. Better tools for movement data, movement simulation, system design and system integration with complex building types are developing, permitting the building designer and user more assurance of performance.

All of these trends produce cost increases irrespective of escalation, and reversal cannot be reasonably expected, though specific products may not conform to this generality. In this situation, it can be expected that cost-effectiveness of conveying systems will be an increasing area of study, as more data are generated as to performance costs.

What is not visible, to the building designer's regret, is a trend toward equivalent systems, that is, the development of conveyance systems of different manufacture which are sufficiently similar, given the task and the environment, to permit more direct comparison and evaluation, as well as easier integration into building design. Whether this is feasible remains to be determined. But at this time the prevailing situation except those pertaining to elevators, dumbwaiters, escalators and pneumatic tubes, precludes development of widely accepted standards for conveyance systems.

THE LONG DISTANCE RUNNERS

A perfected team of reliable delivery systems to fulfill almost every distribution need.

Telelift and **Airmatic** systems go the distance in providing total dependability, time proven reliability and operating economies with energy to spare, in hundreds of installations throughout the world.

and **MOSLER** makes them!

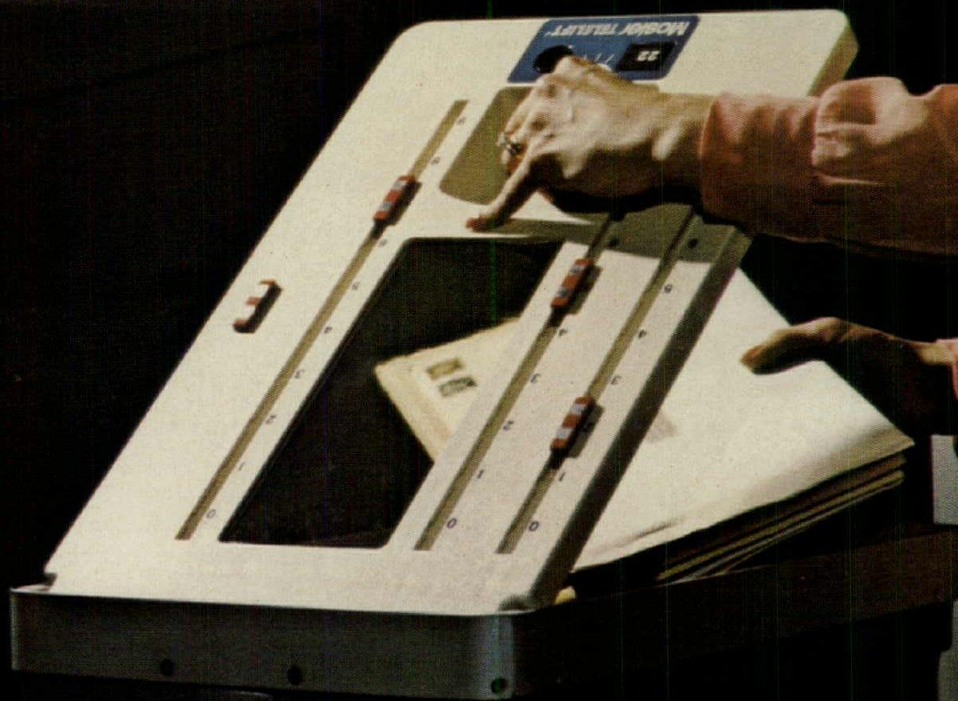

Mosler

An American-Standard Company

MOSLER/AIRMATIC SYSTEMS DIVISION, 415 PATERSON HAMBURG TURNPIKE, WAYNE, NEW JERSEY 07470

TELEPHONE: (201) 278-6300

For more data, write A57 on inquiry card

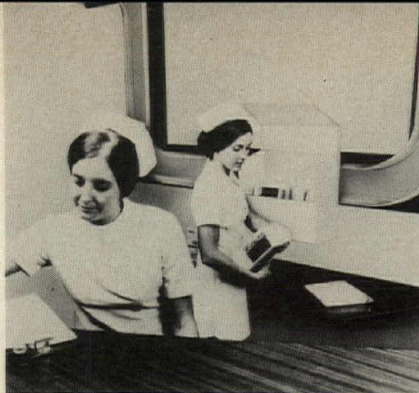

718

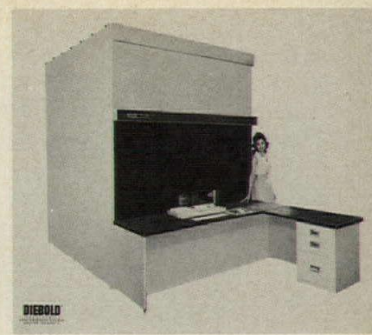

719



720

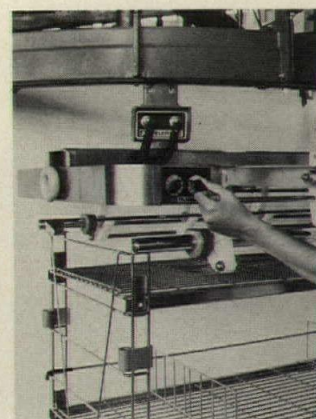

721

CONVEYORS & CHUTES

718 MATERIALS HANDLING / This system, in which self-powered cars track horizontally, vertically and around corners at 140 fpm is capable of handling cargos up to 20 lbs. Systems was designed for mail, EDP media, office supplies and containerized liquids. Recommend for hospitals, banks. / Diebold, Inc. A*

719 RETRIEVAL SYSTEM / System houses records or other materials such as X-rays or tape reels, in mobile containers. At a touch of a button, a conveyor brings container to the operator. It is returned in the same manner. The 7500 system is said to offer capacities equivalent to 26 file cabinets in 75 sq ft of space. / Diebold, Inc.

720 AUTOMATED DISTRIBUTION / This distribution network uses quiet, efficient components, according to the company. Vehicles are powered by isolated 24-volt DC and 20-lb payloads may be delivered to 1000 stations in any vertical and horizontal track configuration. / Mosler Airmatic Systems Div. A*

721 CART TRANSPORT / A transporter unit has been developed to automatically send food and supply carts around hospitals, according to the company. Controls are now easily reached and the carts can be programmed from either side. Entire transporter unit is made of stainless steel. Carts may move horizontally or vertically throughout the system. / Acco Chain Conveyor Div.

722 FREIGHT CONVEYOR / This inclined freight conveyor is designed for between-floor handling needs, with loads up to 6000 lbs. The unit complies with OSHA requirements and is installed at angles of 30-70 degrees. / M-B Co., Div. of Evans Indust., Inc.

723 CART HANDLING / This automatic health care handling system accelerates and decelerates carts gently as they move in and out of the lift. Systems can be operated by anyone. / Security Fire Door Co.

724 VERTICAL CONVEYOR / The Recordlift selective conveyors feature dampening pads between the conveyor and the building structure for quiet operation. Solid-state controls have no clicking relays, no contacts to maintain and snap-out, snap-in circuit cards. / Standard Conveyor Co. A*

725 REVOLVING BINS / Bins that come to the user can be stacked up to 9 ft high and are said to cut storage space by 50 per cent for the same amount of materials. Average retrieval time is 10 to 20 seconds. The wire bins can hold up to 600 lbs each. / White Machine Co.

726 MINI ELEVATOR / The company's residential elevator has been adapted to meet the needs of inspecting such large equipment installations as sewage pumping equipment and pollution control devices. The car can be built to any size, with any material, location of gates, power, safety equipment. / Inclinator Co. of America. A*



722



723



724



725

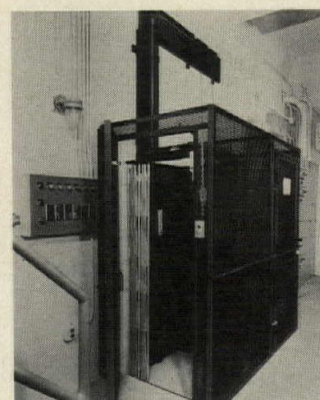

726

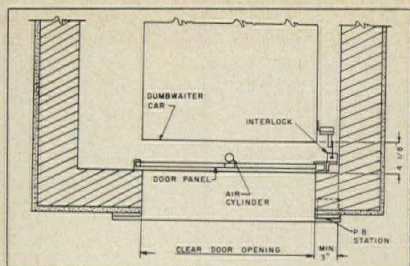

727

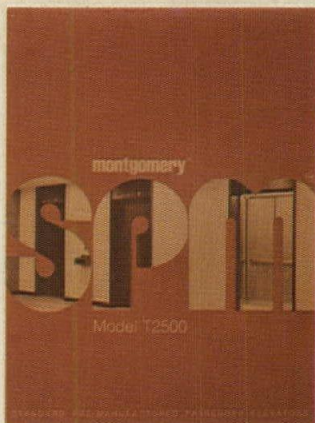

728

DUMBWAITERS

727 DUMBWAITER DOOR / This air-operated dumbwaiter door is designed for simplified field installation. Constant closing torque is safe. The door can be added to existing vertically-sliding or bi-parting dumbwaiter doors. / Sedgwick Machine Works, Inc.

ELEVATORS

728 TRACTION ELEVATOR / This pre-manufactured package is designed for low-to-medium rise buildings. It is rated at 2500-lb capacity with a choice of 200 or 350 fpm speeds, and is designed for single or multi-car use. / Montgomery Elevator Co. A*

729 ELEVATOR DISPATCHER / According to the company, this mini-computer can operate any number of elevators, dispatching them exactly where and when needed. The product is recommended for high-speed elevators and gives a print-out for each cab daily, permitting changes in the program to meet new passenger needs. / U. S. Elevator Corp. A*

730 LOW-RISE ELEVATOR / Models in this line of pre-manufactured hydraulic elevators hold down initial costs and conserve energy according to the company. Standard models range from 1500- to 4000-lb capacity, for service up to five stories. / Otis Elevator Co. A*



729



730



731

MOVING STAIRS & WALKS

731 MODULAR ESCALATOR / With this design, the company states, unlimited rise is possible because each modular stairway, regardless of the rise, uses the same drive machine, and all other components. Smooth, vibration-free, quiet operation is claimed and speeds can be achieved up to 120 fpm. Glass or opaque ballustrades are offered. / Westinghouse Electric. A*

PNEUMATIC TUBE SYSTEMS

732 PNEUMATIC TRANSPORT / Packaged systems are available in 3-, 4½- and 4 by 7-in. sizes as part of the *Modulair* line. The fluidic air control is said to eliminate almost all electrical installation, reduce noise and lower operating costs. / Mosler Airmatic Systems Div. A*



732

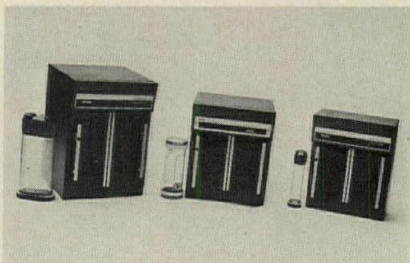

733

733 COMPUTED PNEUMATIC / A line of computer-controlled 4-, 4 by 7-, and 6-in. pneumatic tube systems features single line operation for send-receive functions and cushioned handling of a lightweight carrier. Modular system is readily expandable and utilizes techniques that route carriers with maximum reliability, according to the company. / Mosler Airmatic Systems Div. A*



OTIS
ELEVATOR COMPANY

Otimotion*

*Otimotion is 24 hour-a-day, around-the-world maintenance service. It's experienced installation crews meeting construction deadlines. It's seven, new, pre-engineered hydraulic elevators to help meet construction budgets. It's ten escalator models with a range of options and prices. Otimotion is VIP-260/CL, a new, computer-controlled elevator system that cuts passenger waiting time to a minimum, and it's innovative double deck elevators. Otimotion is a company in motion.

why do
so many
more
architects
and engineers
subscribe to

Architectural Record. Over 43,000 paid architect and engineer subscribers—the largest such audience ever made available to advertisers. Almost 30 per cent larger than the second magazine's.

And, significantly, these subscribers pay the highest subscription price in the field . . . by far. And renew their subscriptions at the highest rate . . . by far.

Moreover, these Record subscribers are responsible for planning over 90 per cent of the total dollar volume of all architect-planned building—a fact documented by Dodge Reports. They're at work wherever buildings are designed and products specified . . . in architectural offices, consulting engineering offices, corporate and governmental building departments.

What's behind Architectural Record's subscriber leadership? Strong editorial leadership and reader preference. Architects and engineers have voted the Record number one in 247 out of 266 studies sponsored by building product advertisers and their agencies over three decades—and recently by margins of better than 50 per cent!

Building product manufacturers are impressed by this preference. They are placing far more advertising pages in Architectural Record than any other magazine in the world!

ONE

When one magazine is strongly preferred by the readers you must reach and the companies you must compete with—shouldn't you do the best possible advertising job in THAT ONE?

architectural
magazine?

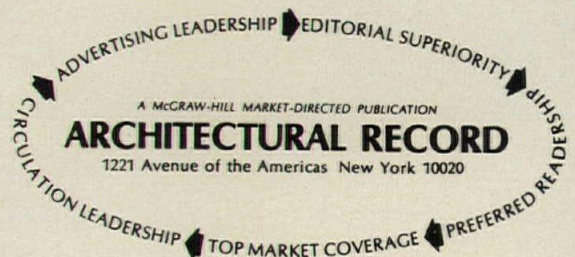

when one advertising value leads to another...and another...and another...you've located the leader

perfect complement
to any building design ...
Crystal 2000 escalator
by **montgomery**

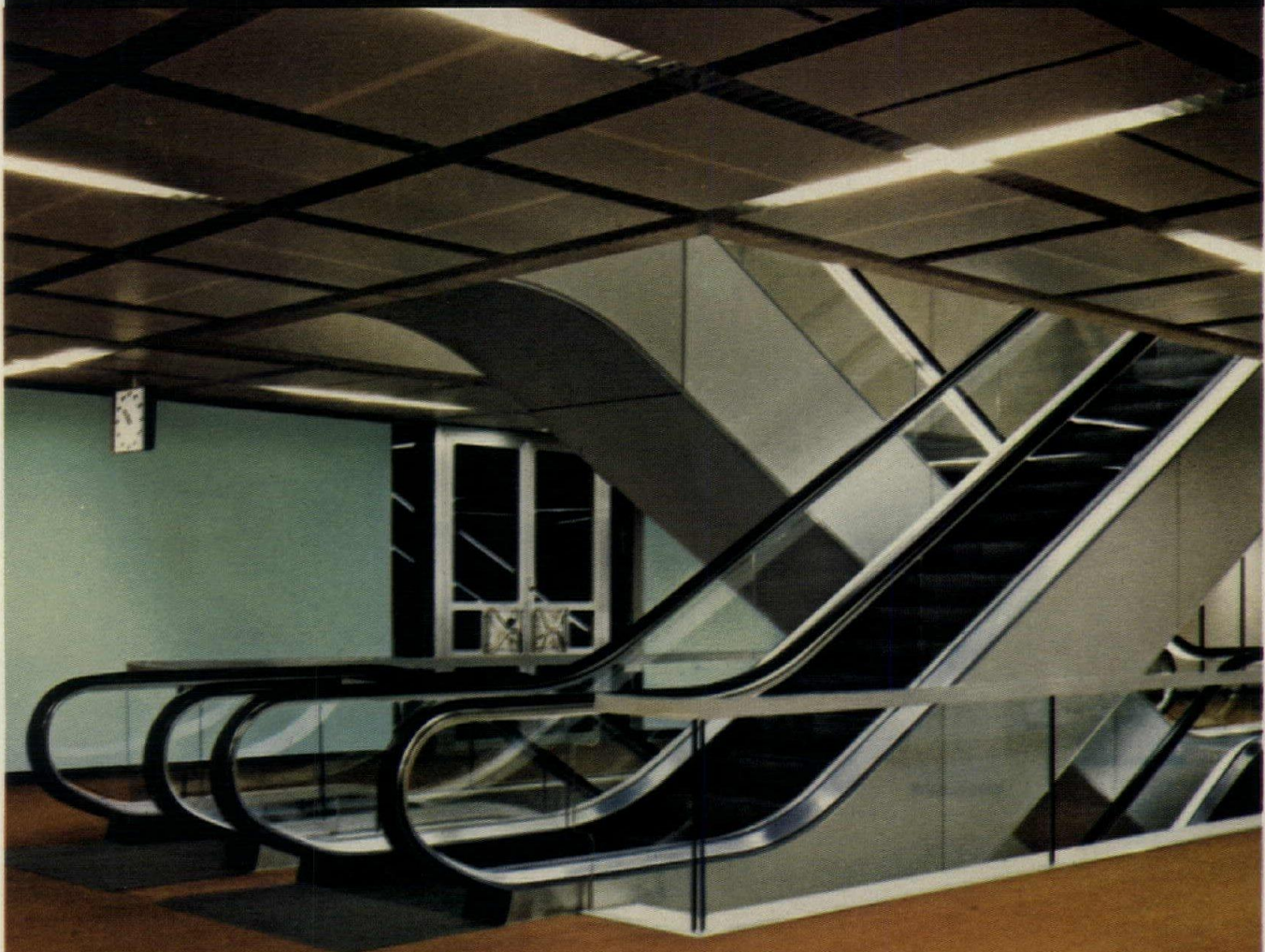

Excitingly beautiful, artistically designed, the Montgomery Crystal 2000 escalator will adapt beautifully in contemporary or traditional office, retail, school or plaza locations. Constructed of 1/2 inch structural glass, Montgomery's Crystal 2000 has completely transparent balustrading without obstructions from top to bottom. Its clean design lends itself to both new construction and modernization.

Architects, engineers, contractors, owners and developers throughout North America have learned they can rely on Montgomery for quality workmanship and expert installation. As an extra bonus, Montgomery's "PM" maintenance program assures smooth operation and long equipment life.

For complete details on the new Crystal 2000 escalator contact our general office or look in the Yellow Pages for the location of one of our 170 offices. You'll find we're not very far from anywhere in North America.

montgomery[®]
ELEVATORS/ESCALATORS
POWER WALKS & RAMPS

Montgomery Elevator Company, Moline, Illinois 61265
Montgomery Elevator Co. Limited, Toronto, Ontario M9B3S5
Offices in Principal cities of North America

montgomery moves people

For more data, write A59 on inquiry card

Patina bronze-tone
stainless outside...

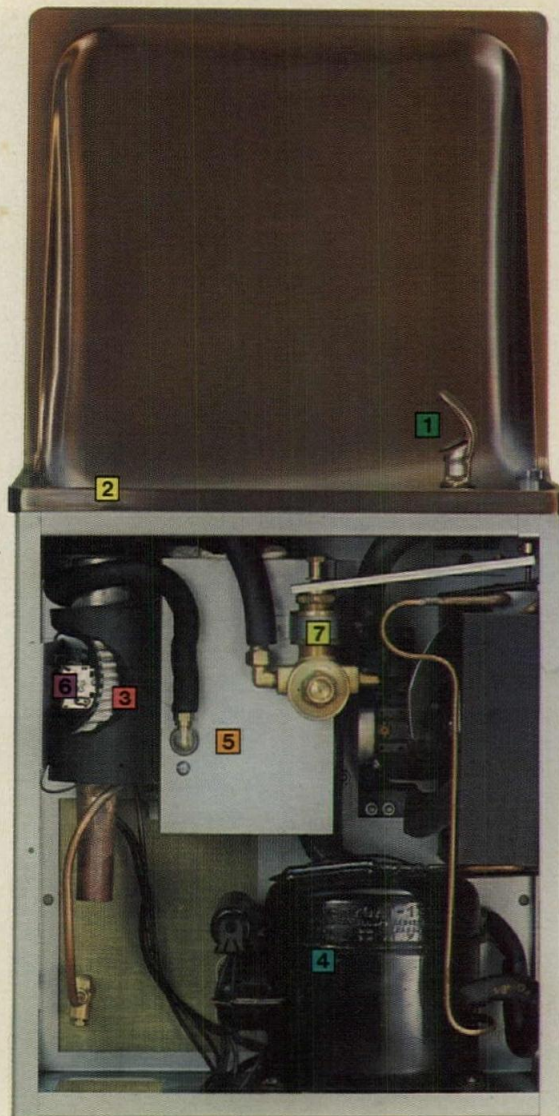

Incomparable
workmanship inside

Here's a case where "or equal" isn't equal.

Halsey Taylor has a pretty good name. But it's not because we make the best-looking water coolers in the world. It's because we put a lot more quality workmanship on the inside of our coolers—where hardly anyone ever looks, or needs to.

We honestly don't believe Halsey Taylor water coolers have an equal.

Do us a small favor. Look carefully at the inner workings of this simulated semi-recessed cooler. Compare its craftsmanship, technical ingenuity and performance with any other brand of water cooler.

We work too hard at building the best to accept the idea that anyone else's product is just as good.

- 1 Exclusive 2-stream bubbler.** Builds a large, drinkable mound of water. Squirt-proof and vandal resistant. One-piece bronze-plated brass forging prevents contamination.
- 2 Cooler top.** Patina stainless steel or satin finish stainless steel, polished and buffed for beauty and ease of cleaning. Separate drain strainer removable for easy cleaning without removing cooler top.
- 3 Pre-cooler (cutaway).** Incoming water line coiled around and tin-bonded to cold water drain. Boosts cooling capacity by 60%.
- 4 Condensing unit assembly.** Hermetically sealed, lubricated for life. Automatic re-set overload protector prevents overheating. Capacitor insures compressor startup. All components designed and coordinated for top efficiency and long life.
- 5 Cooling storage tank.** All copper, hot-dipped pure tin lining. Incoming coil is tin-bonded to refrigerant coil to cool water before it enters tank.
- 6 Dual temperature controls.** Two thermostats, primary and secondary, provide double protection against freeze-up.
- 7 Automatic regulating/operating valve.** Maintains constant stream height under line pressures varying from 20 p.s.i. to 90 p.s.i. Easy to service. Tamper-proof. Large orifices resist deposits and clogging. All parts are corrosion-resistant.

Halsey Taylor Division,
1554 Thomas Road,
Warren, Ohio 44481.



Halsey Taylor
KING-SEELEY **KST** THERMOS CO.

For more data, write A60 on inquiry card

This division includes a wide variety of disparate products, their commonality being that they belong in the mechanical systems of a building. For this reason, there are not, frequently, similarities in the impetus for change from year to year—though economies of first cost and operating cost, sometimes tied in with energy conservation, appear in several of the categories.

With HVAC systems, the trend continues of roof-top air conditioners and multizone units being made larger and larger and more sophisticated in design and operation—with an eye to energy-conserving features. All of the recognized manufacturers are making this type of equipment, now, in standard sizes, while several manufacturers will put together rooftop HVAC equipment of much higher tonnage for the larger buildings.

Because the design trend has been to reduce the solar load of buildings, it is becoming increasingly more economical to use all-air systems instead of air-water systems. The all-air systems provide longer periods of free cooling with outside air, which helps in reducing energy consumption. Within the last five years, many more manufacturers are producing variable-air-volume terminals in a variety of types. Some terminals by-pass the air supply into the return plenum, while others throttle the air flow in response to the load. Several terminals are marketed with modular or linear air diffusers. Also, several of the VAV terminals are being offered with self-contained controls—the controls using the air stream itself as the actuating means.

Because of their low first cost, the demand continues for through-the-wall packaged terminal air conditioners, and some manufacturers are now offering higher-efficiency refrigeration cycles in response to the energy situation.

Several manufacturers have been making packaged chillers and chiller-heat generator units designed for outdoor installation—saving valuable space that would have been required for an interior machine room.

In the plumbing category, many of the lavatory and sink units employ plastics as the base material. Fiberglass-reinforced polyester and ABS are employed for these fixtures, and acid-resistant polypropylene has been used for a laboratory sink.

Special-purpose plumbing fixtures are also on the increase—witness some of the units included here this year: 1) vandal-resistant drinking fountains, 2) multi-purpose lavatory for doctors' offices, 3) wheel-chair-level water cooler, 4) a w.c.-lavatory-cabinet combination for intensive-care patients, 5) a kitchen sink with a funnel-shaped opening near the garbage disposer.

In the more garden-variety type of plumbing, new cast-iron fittings are available to realize savings in the fittings used for w.c.'s, tubs and vents.

Energy recovery is not confined to HVAC systems, but is being applied to retrieve heat from the burning of waste in incinerators.

The Chicago System...

giving the right answers since 1913

The Chicago System has been solving plumbing problems for over fifty years. Chicago Faucet initiated the Chicago System in 1913 with the introduction of the revolutionary Quatern operating unit that closes with the pressure of the water, not against it. Since then, the Chicago System has developed around a product standardization program that provides an almost unlimited variety of interchangeable faucet parts. That's why Chicago Faucet can offer

the widest selection of special fittings tailored to your specific requirements.

The Chicago System also makes the maintenance job a lot easier, cuts down on parts inventory and all but eliminates faucet obsolescence. Product standardization and parts interchangeability means that the fittings you install today will not be obsolete in ten, twenty or even thirty years.

But the most important element of the Chicago System is reliable product performance. We take great pride in our reputation for quality products. Our reputation is no accident, it's founded on over fifty years of outstanding product performance and service.

If you need some new answers to some old problems, send for our catalog and put the Chicago System to work for you.



**CHICAGO
FAUCETS** 
THE SYMBOL OF QUALITY

The Chicago Faucet Company
2100 S. Nuclear Drive
Des Plaines, Illinois 60018

For more data, write A61 on inquiry card

AIR DISTRIBUTION

735 FILTER CABINET / This side-loading cabinet for use with extended area filters is factory-assembled with predrilled mounting flanges. Modularly sized up to 72 in. high, 144 in. long. Access at either or both ends is offered. / Air-Maze Div., Rockwell International.

736 AIR OUTLET / For industrial worker comfort, according to the company, the unit features adjustable air pattern, direction and volume. The unit is designed for individual work stations. / United Sheet Metal Div., United McGill Corp.

737 BATH EXHAUST FANS / Three wall-ceiling units are said to operate quietly and are offered in capacities up to 70 cfm. / Chromalox Div., Emerson Electric Co.

738 FLEXIBLE DUCT / This aluminum duct for heating and air conditioning is available in sizes from 3 to 22 in. in diameter. The butterfly seam is said to be economical and the duct eliminates many costly fittings and can be used in rigid or flexed form. / Johns-Manville.

739 BASEBOARD DIFFUSERS / In lengths up to 48 in., these units can be complemented by return air grilles in the same sizes. Pushbutton damper control is featured. / Lima Register Co.

740 DUCT COMPONENTS / The company's line of internally insulated duct components now includes solid metal inner liners to improve the insulation performance. Field installation is said to be easy and the fittings prevent forced convection through the insulated layer. / United Sheet Metal.

741 AIR DIFFUSION / This high-volume diffuser delivers more air from fewer outlet locations according to the company. One size module handles from 100 to 2500 cfm and is used in multiples to form different models. Units fit standard suspended ceiling systems. / Bertin Industries, Inc.



743

AIR TREATMENT EQUIPMENT

742 BAG-TYPE FILTERS / Extended area filters are designed for use where a high degree of clean air is required. Self-supporting ultra-fine fiberglass media is arranged in rows of air pockets. Capacities range from 800 to 2500 cfm. / Air-Maze Div., Rockwell International.

743 AIR FILTER / This heavy-duty, automatic air filter can be used either horizontally or vertically. Standard 2-in. thick fiberglass media roll is designed for maximum net face velocities up to 600 cfm. Available with air flow ratings up to 65,000 cfm. / Air-Maze Div., Rockwell International.

744 AIR CLEANER / The efficiency of this unit is said to reach up to 99 per cent on pollen and spores. Unit can be installed with any type of central heating and cooling forced air system, and is recommended for home application. / Research Products Corp.

745 FILTER PANELS / Multi-velocity air filter panels with a choice of polyurethane foam or fiberglass media are offered in a range of sizes and thicknesses. Designed for large air volumes with heavy dirt loads. / Air-Maze Div., Rockwell International.

746 AIR CLEANER / An electronic cleaner designed for use in air handling systems with a single return is said to remove up to 95 per cent of the airborne dirt and 99 per cent of the pollen. Capacity for the one-cell unit ranges up to 1000 cfm. A two-cell unit can handle up to 2000 cfm. / Honeywell. A*



744

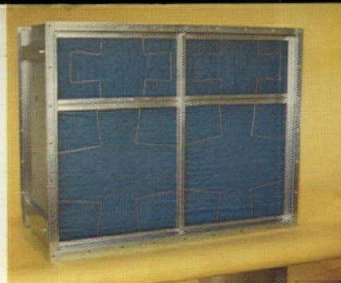

735



736

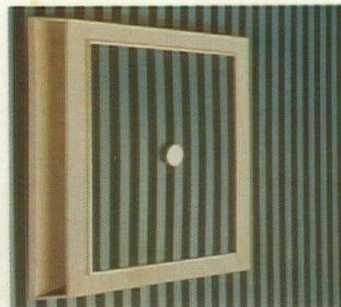

737

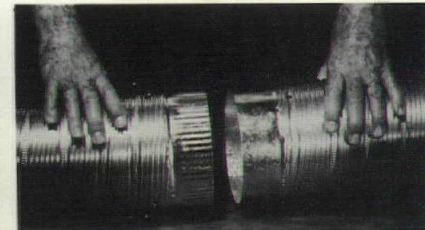

738

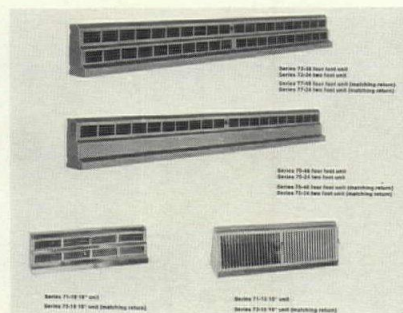

739

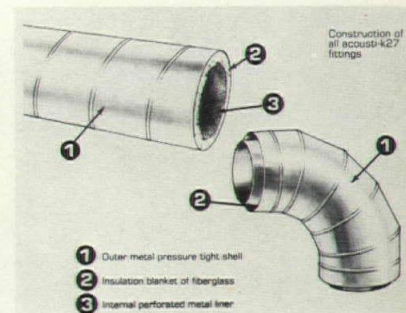

740

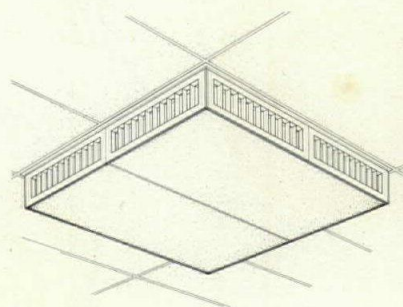

741

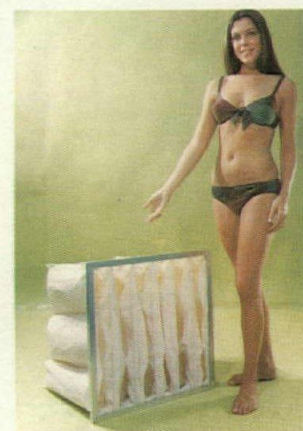

742



745

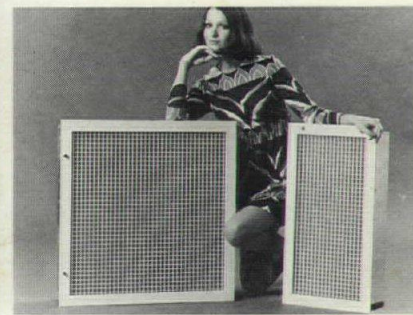

746

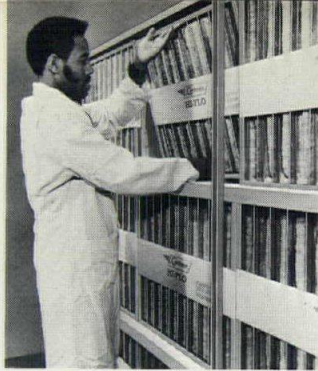

747



748



749

747 FILTER BANK / According to the company, convenience and speed of assembly and servicing are the main advantages of this system of extruded aluminum, with factory-gasketed members to prevent dirty air bypass. Product is offered in sizes up to 12-ft square and can be combined to form larger units. / Cambridge Filter Corp.

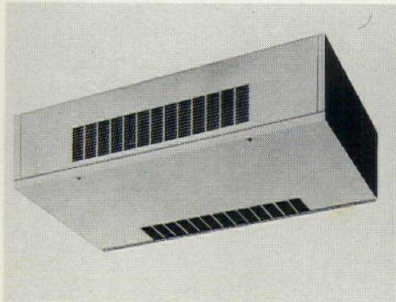

750

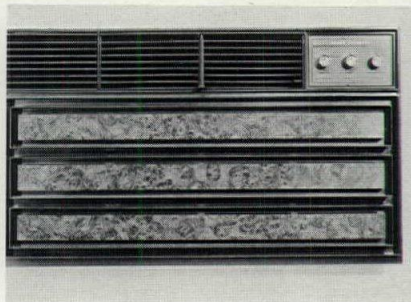

751



752

748 HYDRONIC CHILLER / This chiller-heater includes five models from 3 to 5 tons for cooling and from 100,000 to 180,000 Btuh input heating. The air-cooled, gas-fired series is designed for outdoor installation. / Arkla Industries, Inc.

749 SLOPE COIL / This cased slope coil is designed for the company's gas and electric furnaces and is the first in a family of all-aluminum evaporated coils. Sizes from 14,000 to 48,000 Btuh. / Bryant Air Conditioning Co.

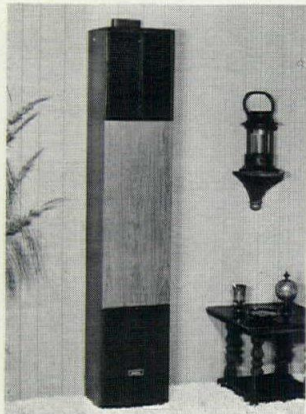

753

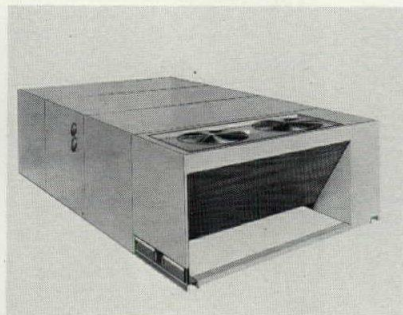

754

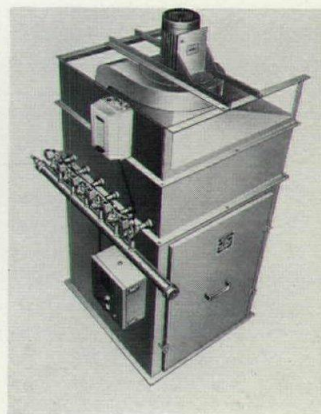

755

750 FAN COIL UNITS / In 200 to 1100 cfm capacities, the *Model F* line consists of 17 vertical models for floor or wall mounting and 7 horizontal units for concealed or ceiling suspended applications. All models can be installed to meet 2, 3 or 4 pipe applications. / Mueller Climatrol Corp.

751 THROUGH-WALL AC / Designed for schools, motels, apartments, etc., the *Wall Temp* series offers cabinets 32 in. wide, with depths of either 14 $\frac{1}{4}$ or 16 $\frac{3}{8}$ in., front to rear. Cooling capacities range up to 13,500 Btu and heating capacities are up to 15,000 Btu. Some units offer cooling only. / Sears, Roebuck and Co. A*

752 HOT WATER HEAT / Designed for heating, fresh air ventilation or make-up air applications where steam or hot water is available and floor space minimal, this unit is offered in ten sizes. Capacities range from 2500 to 40,000 cfm. / Buffalo Forge Co.

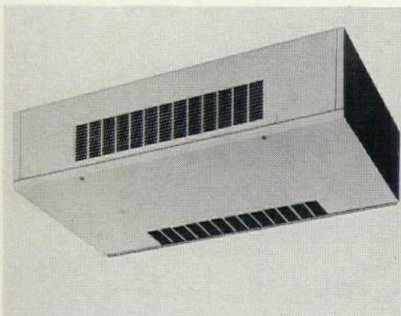

756

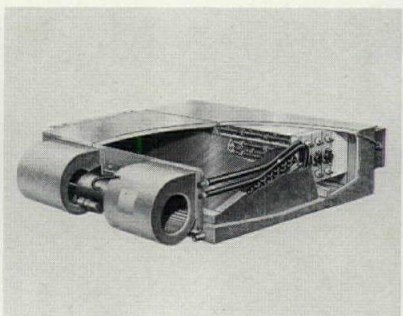

757

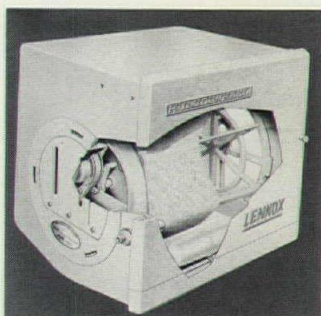

758

753 GAS FURNACE / This counter flow furnace is designed to be installed in full view, and features a wall-mounted thermostat. Unit can be vented directly through the wall. Available in two sizes: 35,000 and 45,000 Btu. / United States Stove Co.

754 SINGLE ZONE UNIT / The rooftop unit is self-contained and offers heating and cooling or cooling only, in 12 $\frac{1}{2}$ - and 15-ton capacities. Units are completely factory-piped, wired and assembled. Available with gas, electric, steam or hot water heat, the unit offers a low silhouette. / McQuay-Perfex Inc.



759



760

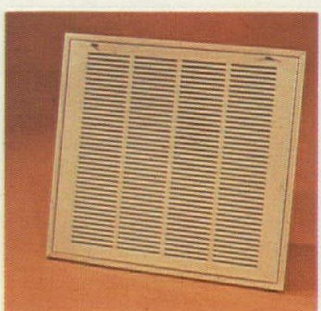

761

755 DUST COLLECTION / Shipped with bags, control panel, blower, motor starter, air header, and solenoid valves wired to unit-mounted control panel, this unit comes in two models, up to 6200 cfm. / Dusty Dustless Inc.

756 FAN COIL UNITS / Units in 200 to 1100 cfm capacities are offered in 17 vertical models for floor or wall mounting and 7 horizontal models for concealed or ceiling suspension. All models will meet 2, 3 or 4 pipe applications. / Mueller Climatrol Corp.

757 BLOWER-COIL / This line of blower-coil units comes in 1½, 2- and 2½-ton nominal cooling capacities and with heating options, units are recommended for apartments, hotels and motels. The basic model—10% in. high, 30 in. wide and 26% in. deep—can be applied horizontally, suspended from the ceiling, or hung vertically. / Lennox Industries Inc.

758 HUMIDIFIERS / Several models have been introduced for plenum mounting on central ducted warm air systems. One model is rated 19 gallons per day evaporation. Unit has a nozzle assembly and a solenoid water valve which produces a fine jet water spray over absorbent media. / Lennox Industries Inc. A, L, I*

759 ELECTRONIC AIR CLEANER / For homes and small commercial applications, this two-stage cleaner is for forced air heating and cooling systems. Available in capacities of 800, 1200 and 1600 cfm. UL-listed, unit operated on 115 volts. / Carrier Air Conditioning Co.

760 HUMIDIFIER / Designed for mounting on horizontal duct work as small as 12 in. wide, the unit has an ARI rated capacity of 15 gallons per day. Standard equipment includes all mounting hardware, self-piercing saddle valve and 6 ft of electrical service cord. / Bryant Air Conditioning Co.

761 AIR CLEANER / This filter grille model is available in three sizes up to 1600 cfm with air handling capabilities for 2, 3 and 4 tons of cooling. The filter grille electronic air cleaner uses a dry media type collector section and requires no washing, according to the company. / Bryant Air Conditioning.

762 OIL-FIRED FURNACE / Available in six beltless and belt-driven models, units range from 105,000 to 168,000 Btu input. Factory-installed burner means the only connections required are oil line and wiring. / Lennox Industries Inc. A, L, I*

763 ROOFTOP HVAC / A custom-designed system for heating and cooling, the *Specipak* unit is said to provide up to 100 per cent make-up air. It is pre-packaged and offered with capacities up to 395,000 Btu heating.

Sizes of cooling are offered, from 15 to 40 tons capability. The systems use natural gas or propane as fuel. / ITT Reznor.

764 TWO-SPEED COMPRESSOR / A 15-ton air conditioning compressor is said to save energy with its unique two-speed design, which provides economical operation at 7½-ton capacity. For packaged roof-top systems when only light cooling loads are required. / Lennox Industries Inc. A, L, I*

765 BLOWER COIL / This series of up-flow units is designed for small-space applications, such as apartments or single family homes. The *CG9* comes in three sizes, up to 2½-ton capacity and measures 38 by 23 by 18 in. Can be wall mounted. / Lennox Industries Inc. A, L, I*

766 DIRECT-VENT HEATER / This compact unit provides gas heat and can be installed through the wall, with no flues or chimney. Sealed combustion chamber draws in only outside air for burning. Available in 20,000-, 30,000- and 45,000-Btu sizes. / United States Stove Co.

767 UNIT COOLERS / Packaged refrigeration systems in sizes from ½ to 15 hp are designed to achieve the lowest possible silhouette without sacrificing ease of service, according to the company. Outside enclosures are heavy-gauge galvaneal sheet steel and units are UL-listed. / Dunham-Bush, Inc.

768 INDUSTRIAL ELIMINATOR / For spot air cleaning in industrial applications, two air cleaner models deliver from 1200 to 2400 cfm. The units can be suspended directly over the areas to be cleaned. Each unit has a two-speed blower control. / Electro-air Div., Emerson Electric Co.

769 ELECTRONIC AIR CLEANERS / The *Skyline* series of rooftop units updated to meet installation situations feature a double walled cabinet with glass batting insulation and large collection cells for increased dirt loading capacity. Six are available from 1200 to 4000 cfm. / Electro-air Div., Emerson Electric Co.

770 EVAPORATIVE COOLERS / A compact, low-cost evaporative cooler for industrial make-up air, process cooling and other applications is said by the company to achieve efficiencies up to 98 per cent. Air flows at velocities up to 700 ft per minute. / Buffalo Forge Co.

771 STOWAWAY FURNACE / This horizontal gas furnace offers single-piece cabinet construction, compact size, a slide-out burner assembly, right or left hand air delivery and a wide blower selection. Seven models range up to 140,000 Btu heating input. / Lennox Industries Inc. A, L, I*

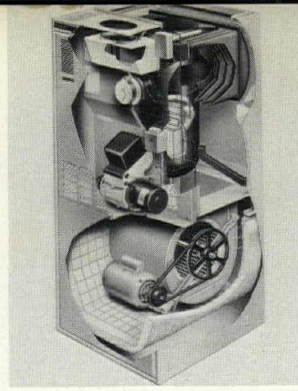

762

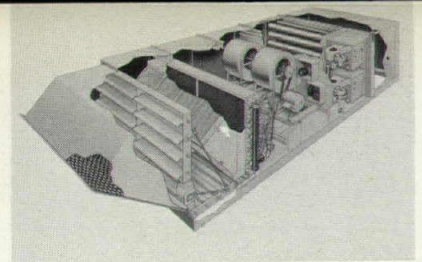

763

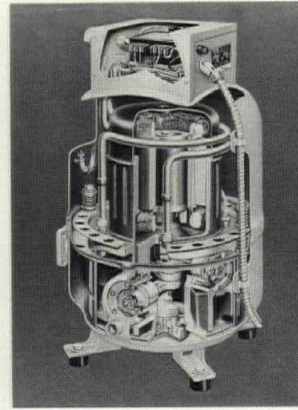

764

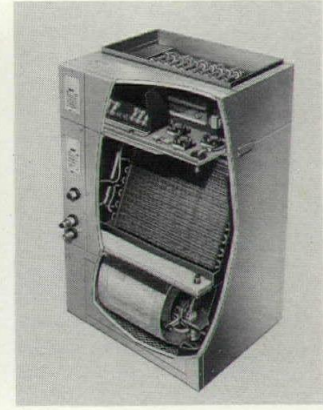

765

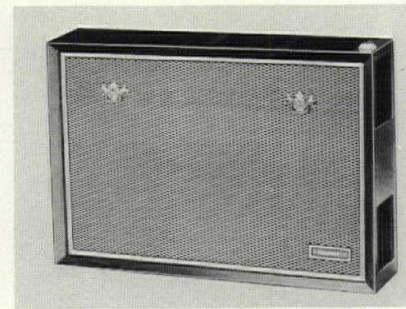

766

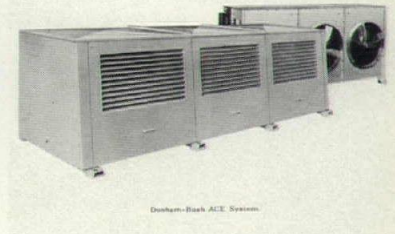

767

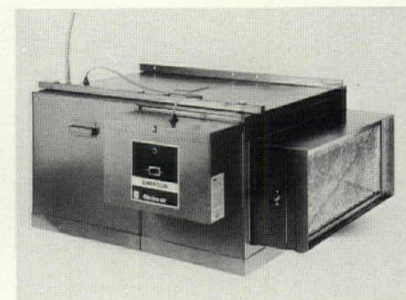

768



769

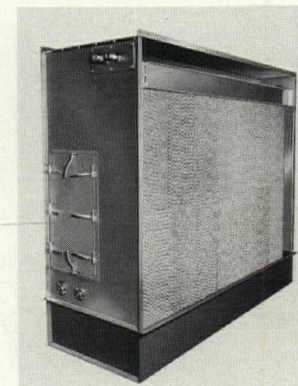

770

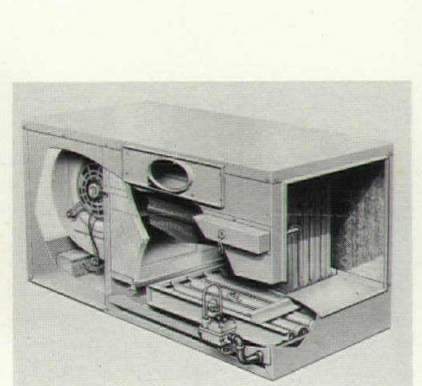

771

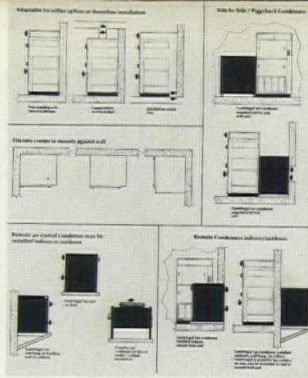

772



773



774

772 COMPUTER COOLING / Air conditioning for computer room applications provide from 43,000 to 61,500 Btu/h of total cooling at sensible-to-total heat ratios well above 80 per cent. Units are available in air-cooled, water-cooled and glycol-cooled versions. / Blazer Corp.

773 CENTRAL HUMIDIFIER / A rotary-type central furnace humidifier has been designed to fit virtually any size central duct including smaller 12-in. ducts without overhang. The unit can add 15.6 gallons of moisture per day to indoor air and ARI-rated conditions. / Carrier Air Conditioning Co.

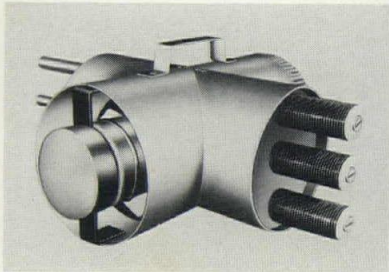

775

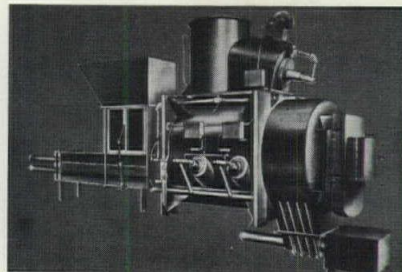

776

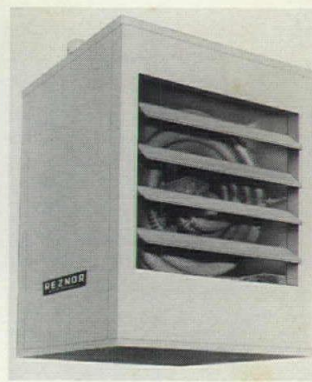

777

HEAT GENERATION

774 OIL-FIRED BOILER / Improved energy conservation is a major feature of this product, according to the company. The V-3 is available in 2, 4, 5 or 6 sections and can be adapted to hot water or steam. Front-mounting controls provide maintenance ease. / American-Standard Inc.

775 HEAT RECLAMATION / Heat normally lost in flue gas is reclaimed for home heating systems, according to the company. The unit recovers from 5000 to 15,000 Btu/hr from an oil-fired system, enough to heat an extra room. / Isothermics, Inc.

776 HEAT RECOVERY / This energy system bakes waste, burning the smoke to provide power for heating and air conditioning needs, while producing an EPA-approved means of trash removal. Unit comes with automatic loading and ash removal system. / Waste Combustion Corp. A*

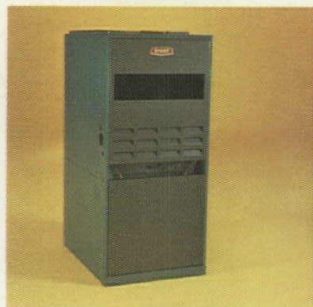

778

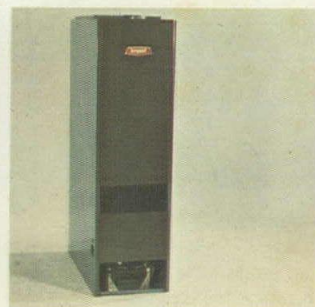

779

777 ELECTRIC UNIT HEATER / Electrically powered models designed for commercial and industrial applications are available in ranges from 34,120 through 204,720 Btu/Hr. Units can be suspended, either singly or in multiples. / ITT Reznor. I*

778 GAS FURNACE / Available in seven sizes up to 200,000 Btu/h, these heating and cooling models are recommended for residential and light commercial applications. All models are offered for natural or LP gas. / Bryant Air Conditioning Co.

779 COUNTERFLOW FURNACE / This gas model is available in five sizes up to 150,000 Btu/h. Heating and/or heating-air conditioning models are offered in each size. All models are equipped with multi-speed direct drive blowers, and can be supplied for either natural or LP gas. / Bryant Air Conditioning Co.

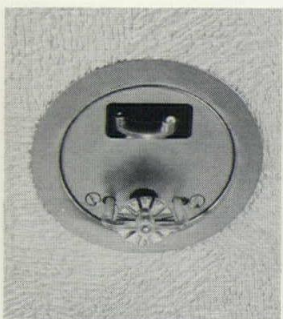

780

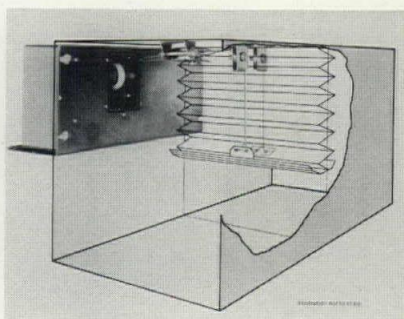

781

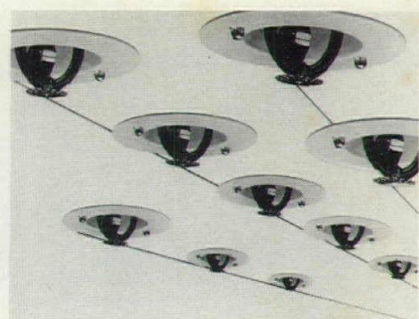

782



783

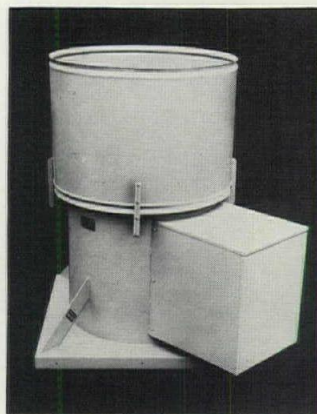

784

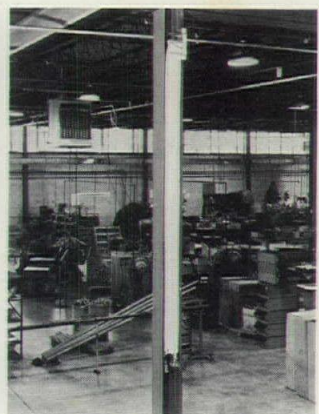

785

FIRE PROTECTION

780 RECESSED SPRINKLER / Available in an automatic on-off model, this recessed sprinkler is designed for use where appearance is important. It can be integrated with existing systems or placed in new construction. Unit is chrome-plated and UL-listed. / Grinnell Fire Protection Systems Co., Inc.

781 FIRE DAMPER, OPERATOR / This UL-listed device, electrically-operated, is made to remotely and automatically control listed curtain or interlock slat-type fire dampers. Holds damper in normal open position until released to close by signal from either remote smoke or ionization duct detector. / Rixson-Firemark, Inc.

782 SPRINKLER ESCUTCHEONS / To allow standard sprinkler heads to appear recessed, this product is UL-listed. They are offered in white. / Metcalfe Industries.

783 FIRE WARDEN STATION / Designed to meet new high-rise fire safety codes, unit can be used to establish verbal communication between a floor warden and the building fire command station. The unit can also be connected directly to the floor public address system. / Sentracon Corp.

784 ROOF VENTILATOR / An improvement to this product published here last year is said to be a control package that automatically operates the ventilator in case of fire, making it an emergency smoke and heat venting unit. Unit is electronic to ensure dependable operation according to the maker. / American Coolair Corp.

785 HOSE RACK / This in-column hose rack permits the hose to be stored inside the column, protected from fork lift trucks, while making more floor space available. Product will hold 100 ft of 1½ in. fire hose in five folds. Fits 10-, 12- and 14-in. columns. / Seco Mfg. Co. I*

786 FIRE HOSE CABINETS / For when fire fighting equipment is needed near fire hydrants, these units can be wall or yard mounted. Available in steel, aluminum and stainless steel. Cabinets will hold up to 350 ft of 2½-in. hose, and measure 60 by 42 by 15 in. Full-hinged doors. Units are finished in red enamel. / Star National Products.

HEAT EXCHANGES

787 HEAT RECOVERY UNIT / Heat from trash is possible with this recovery unit, said by the company to convert trash into steam, hot water or thermal fluid, while reducing the need for trash handling facilities, and fuels. / Waste Combustion Corp. A*

HVC TERMINAL UNITS

788 HEATING-COOLING UNIT / A thru-wall packaged terminal heating-cooling unit in the economy price range features integral cabinet-chassis design to assure safe installation and reliable performance, according to the company. Model JK units are offered in 7500, 9000, 12,000 and 15,000 Btu capacities with electric, steam or hot water heating. / Slant/Fin Corp.

789 PACKAGE COOLER / This packaged terminal air conditioner model series in 9,200- and 12,000-Btu capacities is designed for commercial use, such as motels and office buildings. Individual room control, low initial cost and architectural versatility are claimed. / General Electric Co. A*

LIQUID WASTE EQUIPMENT

790 VACUUM SEWAGE UNIT / The system uses air instead of water for transport of sewage. For offices, home, apartments, etc., the unit is said to reduce water flushing by 90 per cent. Low-cost PVC piping can be laid horizontally or in sharp inclines and venting is unnecessary. / Colt Industries.

MECHANICAL CONTROLS

791 GAS FLAME MODULATION / The *Selectra series 9* electronic gas flame modulation is designed primarily for residential and light commercial heating. The system is solid-state. / Maxitrol Co.

792 PNEUMATIC THERMOSTAT / Designed for package air conditioning systems, the thermostat fits troffers, aspiring boxes, ducts, and diffusers. The unit is said to easily handle variable-air-volume units rated at 3200 cfm, has rolling neoprene diaphragm for long life, smooth performance. / Honeywell Commercial Div.

793 VENTILATOR CONTROL / The company is offering a line of solid-state controls for ventilator applications. The new actuator has a built-in bridge/amplifier and all connections are made with plug-in wiring harnesses. The solid-state sensor eliminates the mechanical controller. / Barber-Colman Co.

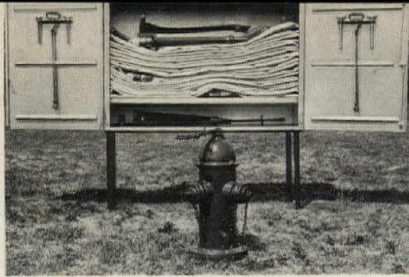

786

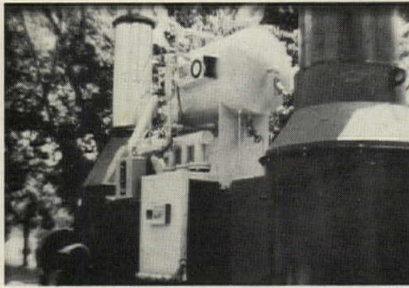

787

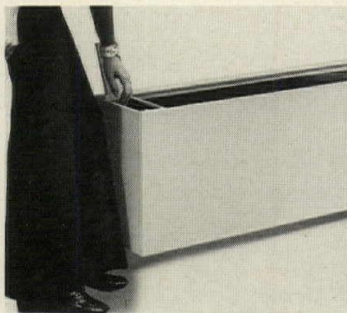

788



789



790



791

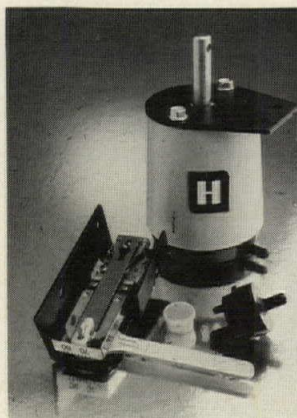

792

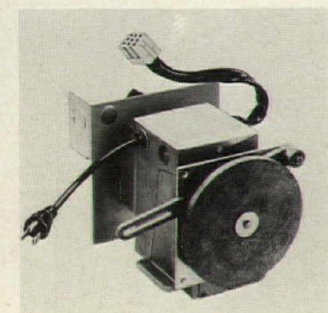

793

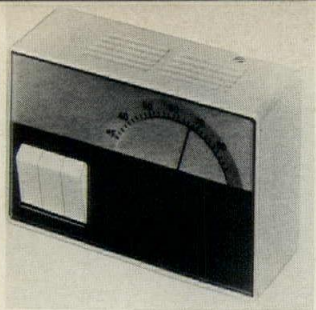

794

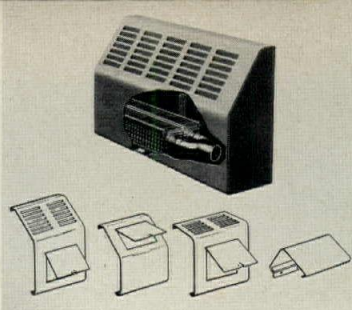

795



796

794 ZONE CONTROL / This zone temperature control is recommended for one-, two- or three-zone applications in conjunction with circulators or zone valves or damper motors. More economical fuel use is a claimed result of use. / Ammark Corp.

795 VALVE ENCLOSURE / Complementing a line of enclosures that fasten to the cover and become an integral part of the entire baseboard assembly, this unit has a swing-out door for full access to the valve. For use with hydronic baseboard radiation, the product comes in beige only. / Edwards Engineering Corp.

MECHANICAL INSULATION

796 PIPE INSULATION / Designed for all piping, duct and equipment applications, hot or cold, *Fiberglas 25 ASJ* is jacketed with a vinyl-coated and embossed vapor barrier of aluminum foil and kraft which is reinforced with glass-fiber yarns. UL-rated and non-combustible, the systems will serve from -65F to 150F. / Owens-Corning Fiberglas.

PIPING & SPECIALTIES

797 SPRINKLER SHUT-OFF / For positive shut-down of a fire-actuated or damaged head, the product is offered for most makes of sprinkler heads in use today, according to the company. The flush-type may be used with flush-mounted heads. / Fire Sprinkler Control Co.

798 PVC WATER PIPE / The pipe meets the commonly-accepted design requirements of the water works industry, according to the company. Pipe provides for a minimum, long-term hydrostatic strength capacity of 600 psi, a 4-to-1 safety factor based on 150 psi operating pressure. / Johns-Manville.

799 IN-WALL FITTINGS / For use with no-hub couplings, these fittings are said to eliminate many of the fittings and much of the pipe required in the established systems. Included are closet fittings, vent by-pass fittings and double-tub fittings. / Cast Iron Soil Pipe Foundation.



797



798

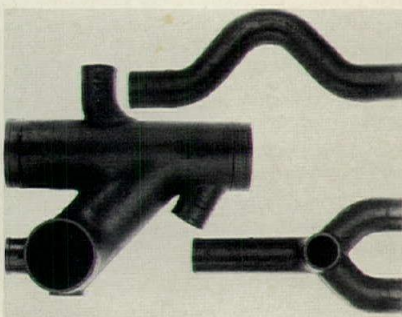

799

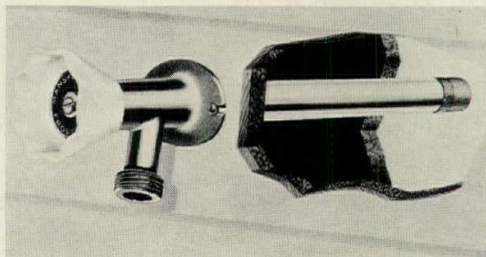

800



801



802

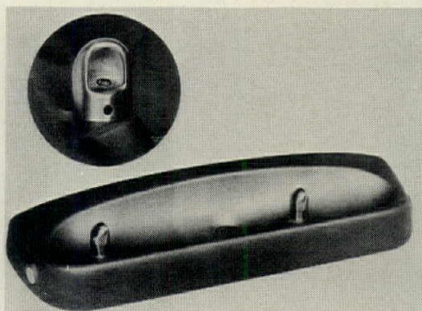

803



804

PLUMBING FIXTURES, TRIM

800 FROST-PROOF FAUCET / Through an elongated stem, the faucet turns off inside the building and eliminates the need to be shut off in winter. Available in 4- to 8-in. lengths, units are equipped with unbreakable handles. / Mansfield Sanitary, Inc.



805



806

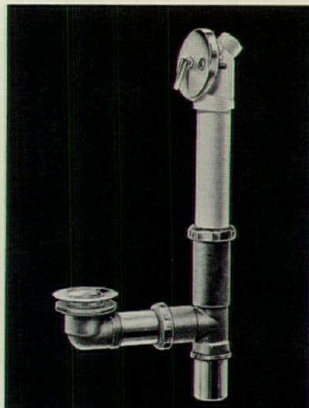

807

801 BASIN FAUCET / This chrome-plated faucet features a stream solidifier and is available with a cross handle or lever handle compression, and with either a self-closing unit, push button or "tip-tap" slow self-closing unit. / The Chicago Faucet Co.

802 TUB-SHOWER CONTROL / A chrome-finished single-handle thermoplastic control is lubricated internally and has just one moving part. Kitchen and lavatory faucets are included in the line also. / Bradley Corp.

803 WALL MOUNTED FOUNTAIN / Hard anodized cast aluminum with abrasion and impact resistant finish is featured on this model with vandal-resistant qualities. A heavy-duty chrome-plated bubbler locks to receptor, and push button valves are flush-mounted. Concealed mounting brackets. / Haws Drinking Fountain Co. A*

804 CHINA LAVATORY / This vitreous china lavatory features a front self-draining soap rest located below the rim. The design allows easy access to the soap. Hidden overflow drain and sculptured look are also stated by the company. / Borg-Warner Corp.

805 DISPOSER SINK / The unit has a funnel-shaped opening located in the right rear corner, providing a feeder facility to the disposer. Offered in double or single compartment models, the sink is made of nickel-bearing stainless steel. Receives all standard disposers. / Elkay Mfg. Co.

806 LAVATORY FAUCET / A line of low silhouette faucets in chrome, gold and avocado features 4-in. center mounting. A choice of handles is offered and both pop-up and chain-type stopper models can be obtained. / Mansfield Sanitary, Inc.

807 LOW-COST DRAIN / According to the company, this drain eliminates hair clogging through construction of a striker that allows hair to flow into the water line. Product fits all company tubs and those of most competitors. Simple installation is claimed. / American-Standard.

808 KITCHEN FAUCET / A 360 degree swivel aerator is featured on this faucet made of solid brass bar stock and available with two handle designs. / Harcraft.

809 PLASTIC LAVATORY / Made of solid ABS plastic, this unit is molded in a 20 by 17-in. oval, self-rimming with a lustrous high gloss finish. It is said to be chip-proof, unbreakable and scratch-resistant. Available in three colors, unit comes with or without overflow. / Bemis Mfg. Co.

810 WATER CLOSET / A one-piece ventilated, low-silhouette design is made of vitreous china and comes in seven colors. / Crane Co.

811 FIBERGLASS TUBS / Three oversized tubs are offered in heavy-duty fiberglass reinforced polyester, and gel-coated to provide a smooth surface. The tubs are said to retain bath water temperature longer than materials. / American-Standard.

812 MIXING VALVE / A washerless valve for shower and tub use is capable of adjustment to prevent the hot temperature zone from being reached, if desired. Unit features an optional pressure balance mechanism to guard against fluctuations. A crystal-look or chrome blade handles can be ordered. / Delta Faucet Co.

813 COMPACT TOILET / Known as the *Spacette*, this reverse trip unit measures 17½ by 25½ in. overall. It is constructed of high-fired mirror china. Twin siphon jet action and wide trapways provide immediate, rapid flushing on less water, according to the company. / Mansfield Sanitary, Inc.

814 LIGHTWEIGHT FOUNTAIN / Made of polyester, highly polished to a smooth finish, this fountain can be wall-mounted and is offered in five colors. It weighs 30 lbs. A chrome-plated bubbler is locked to a receptor with vandal-resistant lugs. / Western Drinking Fountains.

815 ACRYLIC VANITY / The line of molded acrylic vanities features a self-rim oval bowl and sculpture soap trays. Bowl measures 17 by 20 in. and the surface is smooth and hard to resist stains and chemicals, according to the company. Available in colors. / Formco, Inc.

816 LAB SINKS / Extra deep, as well as flanged-style sinks are made of acid-resisting polypropylene and offered in 13 sizes and 7 colors. The new flanged sink measures 19 by 16½ in. and up to 24 in. deep. / R & G Sloane Mfg. Co., Inc.

817 SAFETY SHOWER / A line of emergency drench showers meet OSHA requirements for industrial and institutional use, according to the company. The free-standing model delivers a drench column of water 12 to 14 in. in diameter and meets Federal requirements for spread of water cone. / Bradley Corp.

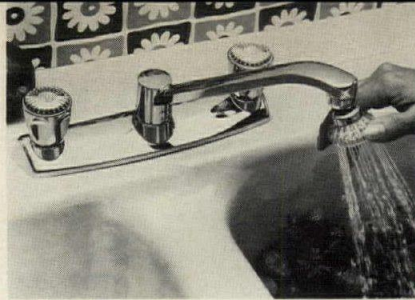

808



809



810

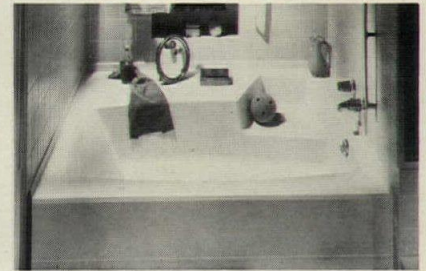

811

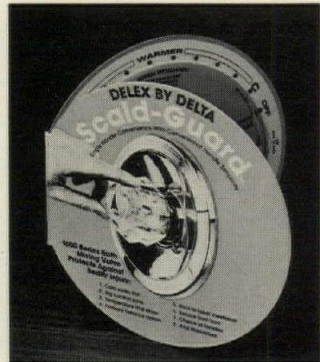

812



813



814

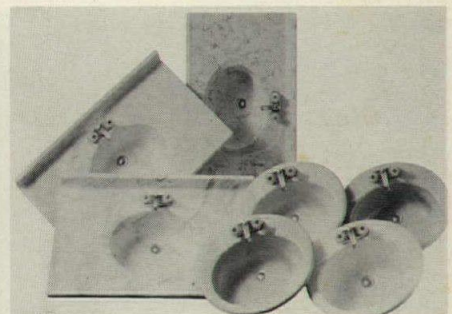

815

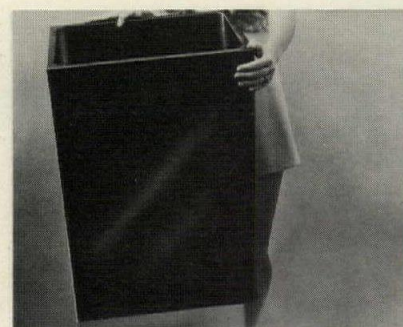

816

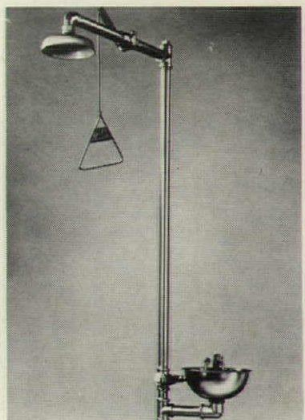

817

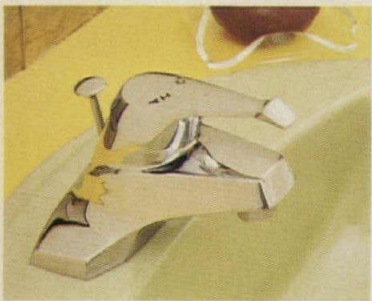

818

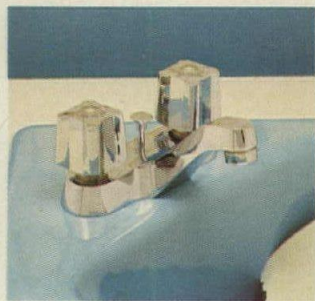

819



820

818 LAVATORY FAUCET / With all-ceramic components instead of washers, the lav piece is a single-handle control model, with finger-tip operation according to the company. / Symmons Industries Inc.

819 FAUCETS / A choice of polished chrome or clear acrylic handles is offered in this line of economy faucets. The valving system has renewable seats. Available for lavatory, kitchen sinks and tub-shower installations. / Kohler Co.

820 PINK FIXTURES / The company has introduced the color pink into its line of plumbing fixtures. / Kohler Co.



821



822



823

821 WATER COOLER / A simulated semi-recessed water cooler can be mounted on any wall without recess cut out. Wall-hung, it is completely self-contained and the electric refrigerated cooler projects 9½ in. from the wall. It is available in 9 panel colors. / Elkay Mfg. Co. A, I*

822 CONSERVER TOILET / This two-piece water closet is said to operate on 30 per cent less water than most ordinary comparable units. In two syphon jet models, elongated or round front design, the unit comes in 12 colors, including black. / Briggs.



824

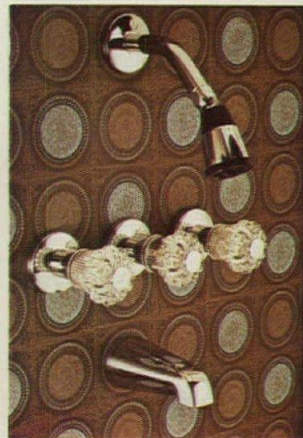

825

823 NOSTALGIC BATH / The tub is 6 ft long and 37½ in. wide, with lustrous enameled interior bonded to cast iron. The tub is offered in red, black or white, with antique faucets in gold electroplate or chromium. Ball and claw feet. / Kohler Co.

824 OVAL LAVATORIES / Acrylic-faced lavatory models feature fiberglass backing for strength and light weight. Ovals measure 19½ by 16½ in. A 19-in. diameter round model is offered and both shapes have a rear-fitting ledge and concealed overflow. / Universal-Rundle Corp.



826

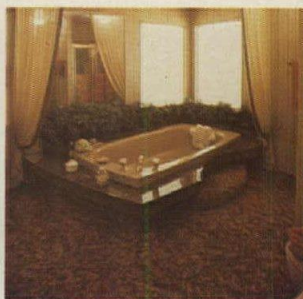

827



828

825 FITTINGS / Available in 18 models for lavatory, tub, shower and sink, these fittings are said to be rust-proof and guaranteed for five years. Washerless, all-in-one cartridge is featured and all are equipped with an aerator. / Universal-Rundle Corp.

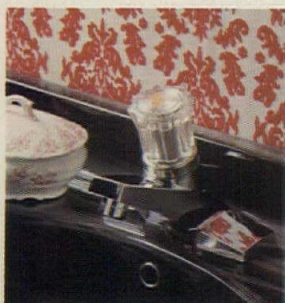

829

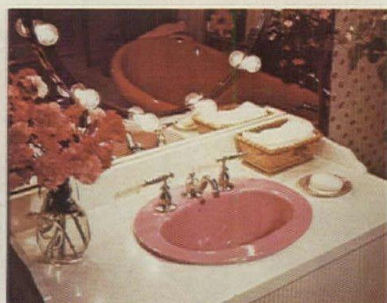

830



831

826 MARBLE VANITY / In single or double bowl models in six colors, these cultured marble vanities are said to be highly abrasion-resistant and unaffected by many household chemicals. Sizes range from 17 to 19 in. to 22 by 96 in. / Acorn Marble Products Co. A*

827 SUNKEN TUB / A free-standing fiberglass sunken tub can be installed indoors or out, as a conventional bathtub or equipped with water therapy units. Unit is self-supporting and comes in standard colors, with custom colors available. / Fiberglass Fabricators, Inc.

828 WIDE-SPREAD FAUCET / This lavatory set available in chrome or 23-carat gold is adjustable from 8 to 15 in. and reinforced flexible tubing is said to provide ease of installation on tops up to 1 1/4 in. thick. Also available for fixed 8-in. center drilling. / Harcraft Inc.

829 LAV FAUCET / This chrome-plated single-handle thermoplastic lavatory faucet features cartridge control for water temperature and volume. Clear plastic knobs are standard, with optional chrome finish. / Bradley Corp.

830 LAVATORY FITTING / This antique-like fitting is available in polished chrome or gold electroplate. Mounting is on 12-in. centers adjustable to 8-in. centers. / Kohler Co.

831 SINGLE CONTROL FAUCETS / Interchangeable single lever or push-pull controls are offered on this line for the bath or kitchen. A washerless cartridge is self-contained, non-corroding and provides 180 degree turn for temperature adjustment. / Kohler Co.

832 LAV-TOILET / A combination stainless steel fixture for intensive care patients consists of a swing-away water closet, a complete lavatory and cabinet with utility top. Unit will be available in a vinyl-clad model and measures 38 3/8 in. high, 38 in. wide and 15 1/4 in. deep. / Heintz Div., Kelsey-Hayes.

833 KITCHEN FAUCETS / A dual control, swing spout, deck-mounted faucet is offered with either a square or tubular spout, chrome-plated. A choice of lever or round, crystal-type on-off handle is offered, and units are available with or without rinsers. / Mansfield Sanitary, Inc.

834 SAFETY SHOWER / A simple outdoor shower for industrial use features induction heating with simple thermostatic control, according to the company. It is connected to water and power lines and is ready for use. Works in sub-zero weather. / Speakman Co.

835 WHEELCHAIR-LEVEL COOLER / Model HWC-6 mounts at wheelchair-user height and has a receptor that extends out from the wall. An easy-to-operate lever valve is supplied. Sandalwood acrylic finish with stainless steel receptor is standard. A glassfiller model is also available. / Haws Drinking Fountain A*

836 PEDESTAL FOUNTAIN / A cast concrete drinking fountain, Model 3030 includes vandal-resistant features such as a bubbler locked to a stylized stainless steel receptor, special access plate and push-button valve with automatic stream regulation. Matching concrete step is optional. / Haws Drinking Faucet Co. A*

PUMPS & COMPRESSORS

837 ROTARY COMPRESSOR / For high-energy-conserving residential central air conditioning applications, this unit is said to have few moving parts, so maintenance problems are few. / Fedders Corp.

838 SUMP PUMP / A submersible sump pump is rated at 1/2 hp and weighs 12 lbs, according to the maker, because of construction using lightweight copolymer materials. Wear- and impact-resistance are claimed. Water-cooled and oil-filled, it is internally protected from thermal overload. / Fluitron.

839 CONDENSATE RETURN / This pump designed to collect steam condensate returned by gravity to a receiver has a pumping rate and receiver capacity equal to three times the boiler condensing rate according to the company. Capacities range from 1.5 to 22.5 gpm. / Weil Pump Co.

REFRIGERATION

840 PACKAGED CHILLERS / Chillers with 30 to 190 ton capacities feature an industrial duty open drive compressor, air cooled condensers, factory-wired controls and ASME shell and tube evaporators, and are built on hot dipped galvanized structural channel bases for commercial hydronic jobs. / Webster Div., Andro Corp. 1*

832

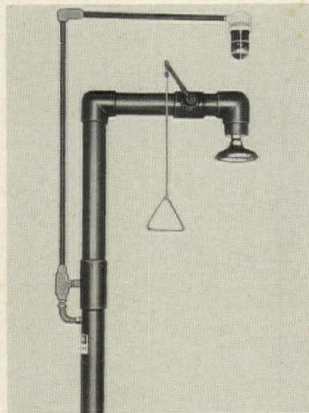

834

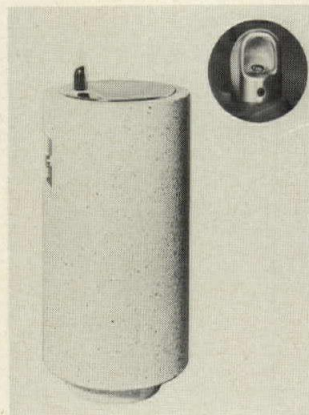

836



838

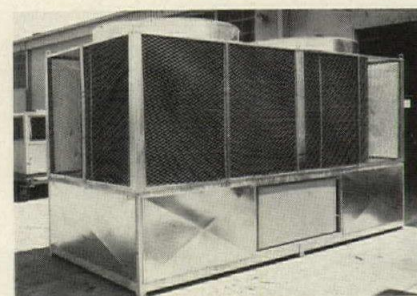

840

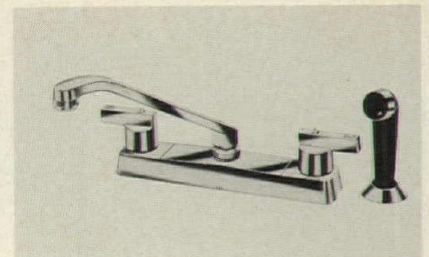

833

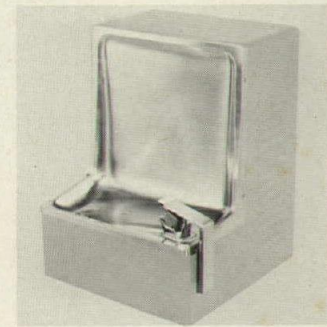

835

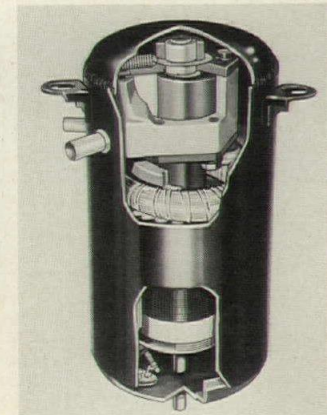

837

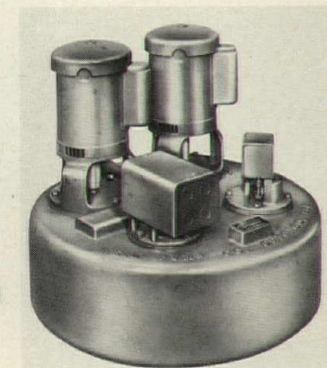

839

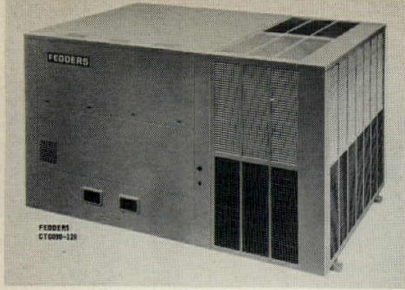

841

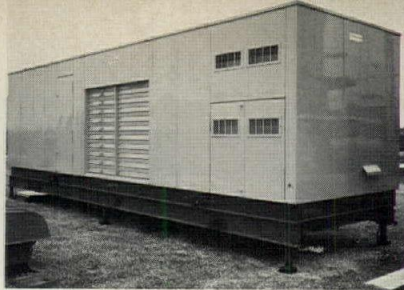

842

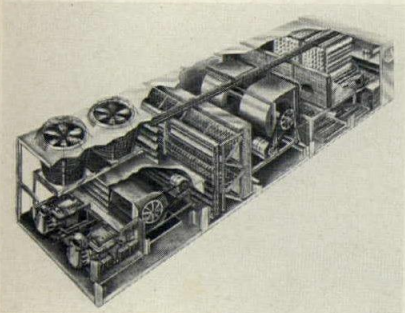

843

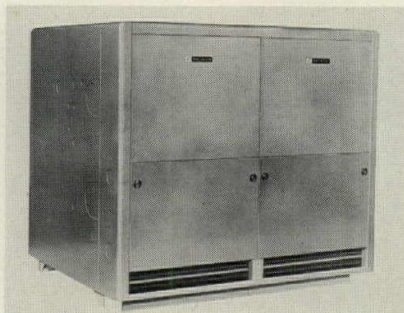

844

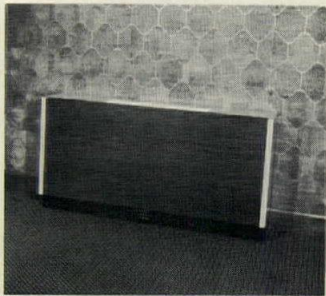

845



846

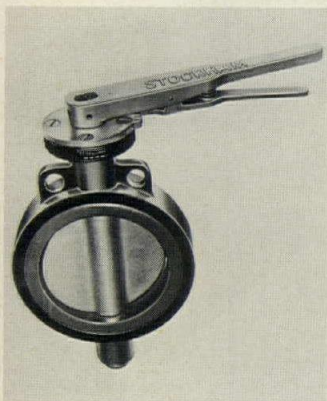

847

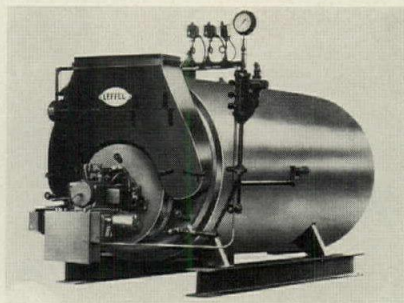

848



849

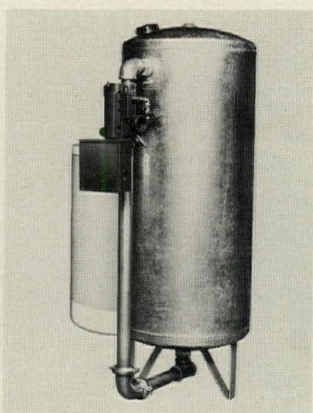

850

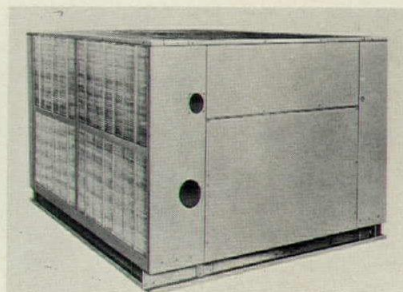

851

SELF-CONTAINED HVC

841 ROOFTOP PACKAGE / Heating and cooling systems with dual gas capabilities are offered in cooling capacities from 8 to 25 tons. Integral provision for operation on natural or propane gas permits continuous operation on utility interruptible basis. Changeover is manual or automatically controlled by a preset outdoor thermostat. / Fedders Corp. A, I*

842 PENTHOUSE AC / Self-contained, central station air conditioning penthouses are said to replace built-up penthouses or built-up equipment rooms of 100,000 cfm and/or 300 tons or less, according to the company. Service areas are lighted and headroom is over 6½ ft. / Miller-Picking Corp.

843 ROOFTOP HVC / This modular single- or multi-zone series can be ordered through 70 tons, 28,000 cfm or to exact specifications. Natural, LP gas, multi-stage electric, steam or hot water heating is offered, with Class I, II supply and return air blowers. / Webster Div., Andro Corp. I*

844 GAS BOILER / A cast iron commercial atmospheric gas boiler, for hot water or steam is offered in 34 sizes with ratings to 4,373,000 for hot water, and to 16,270 sq ft for steam. Unit measures 57½ in. wide. / Weil-McLain Hydronic Div.

845 ENERGY-SAVING COOLING / According to the company, high-rise building operators can save \$35,000 per year on a typical 50,000-sq ft space by using this air conditioning system applicable to both old and new construction. Requiring no through-the-wall openings, or other sources of outside air, each unit contains a complete refrigeration circuit, a fan and controls that provide heating or cooling as required. / American Air Filter Co., Inc. A*

TANKS & BASINS

846 HOSPITAL WASH CENTER / A stainless steel wash-up center combining towel, soap and cup dispenser and an integral lavatory is designed for doctors' offices and other similar applications. The recessed unit measures 16 in. wide and 29¼ in. high, and can be installed in 4-in. walls. / Bobrick Washroom Equipment, Inc. A*

VALVES

847 BUTTERFLY VALVE / In cast and ductile iron, 150-lb lug and wafer type valves come in sizes from 2 to 12 in. The floating disc design employs upper and lower stems with no external fasteners. The standard disc materials are bronze and ductile iron, with other alloys available. Stems are normally stainless steel. / Stockham Valves & Fittings.

WATER TREATMENT

848 PORTABLE BOILER / The unit features 3-in. diameter seamless drawn fire tubes for maximum corrosion resistance and long life, according to the company. Oil-fired model illustrated is joined by gas- and coal-fired units, with ratings from 6 to 600 hp. / The James Leffel & Co.

849 WASTEWATER TREATMENT / The system is said to be a high efficiency aerobic method, employing venturi action to assure maximum oxygenation. Product can be installed in unlined earthen basins, concrete tanks or almost any tankage. / Ralph B. Carter Co.

850 WATER SOFTENER / An industrial and commercial grade unit, this water softener features all-brass construction with only one moving part (plunger). The underdrain system is molded of all non-corrosive materials. Capacities range up to 951,000 gals. / Sta-Rite Industries, Inc.

851 LIQUID CHILLER / Nine new units range from 22 to 87 nominal tons and are factory assembled. Rooftop or ground level models are included. Quiet operation and low silhouette are claimed and units are designed for 35 degree F mild ambient operation. / Mueller Climatrol Corp.

ELKAY®

designed their water coolers to...
do the job better...

look the best...

install the easiest...here's how!



Fountain Top. Exclusive Cascade design basin has multi-level decks. Tested most splash resistant. Water flows to built-in vandal proof drain.*

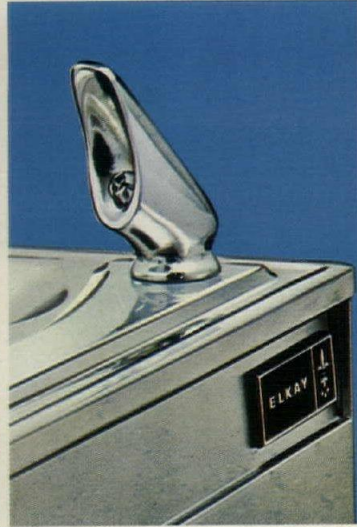

Stream Projector. The most sanitary hooded stream projector, designed to produce correct amount of water flow. Separate push button control. (On most models.)



Foot Pedal Control. Heavy duty pedal with positive linkage assures instant on-off water action, works in conjunction with separate push button control on most floor models.

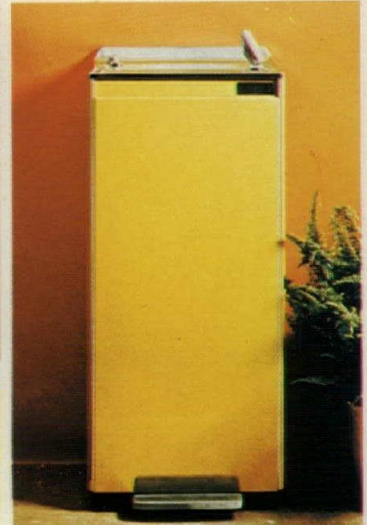

Elkay Styling. Designed in the classic square concept that compliments every building interior. No exposed fasteners or screws on panels to mar appearance.



Sectional Concept. Operating components and plumbing connections are separated. Mechanical system is attached to upper chassis. Plumbing and electrical connections easily made in lower chassis.



Removable Panels. Water coolers shipped with front and side panels in separate container in the master carton. Saves time—no need to remove panels before plumbing hook-up.



12 Decorator Colors. Colored panels available in nine vinyl colors and two colors in baked enamel at no extra cost. Panels set carried in stock for immediate delivery. Stainless steel panels available at extra charge.

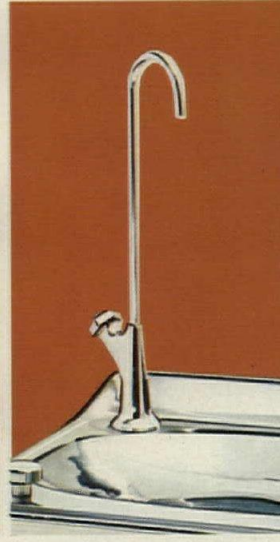

Glass Fillers. Available for most models. Three styles: Push button; push back and push down. Can be field installed on most models.

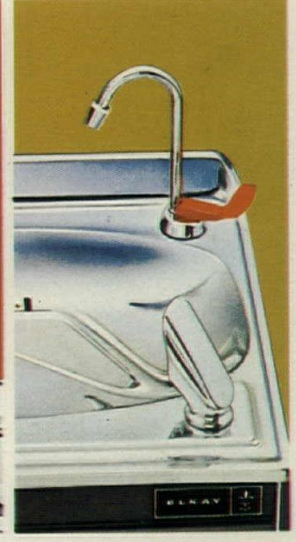

Hot water dispenser to provide hot-cold service is a factory installed option. (On most models.)

Elkay has a style and Capacity for every Commercial... Industrial... and Institutional Application

For Complete Information

Write for Catalog No. DFC-4 or call Customer Service Dept. (312) 681-1880

ELKAY. MANUFACTURING COMPANY 2700 SOUTH 17TH AVENUE • BROADVIEW, ILLINOIS 60153

For more data, write A62 on inquiry card

Introducing
the new Briggs

CONSERVER™



Briggs brings you an everyday answer to the growing pressure for cutting costs, saving water, reducing waste.

The idea of a closet using less water has been around. And now Briggs has found the way to make it work . . . simply . . . most efficiently.

The secret of the new Briggs Conserver two-piece water closet is in its "balanced" design . . . the balance of less water *and* positive flushing action.

The volume of water needed has been reduced, yes . . . actually 30% less than most ordinary two-piece closets. Yet because of the way Briggs has designed the Conserver, there's *no* loss in operating efficiency.

The Conserver saves. And it works! Already it's an important factor where saving water is not only desirable, but required. It's ideal for institutions, motels and hotels; and for high density apartment areas where less waste is important. You'll install it in single family homes, too . . . especially in areas of high water and sewage rates. *Everybody* likes the everyday savings (water and money) the Briggs Conserver offers.

Choose from two syphon jet models, elongated front or a round front design. Both are available in all Briggs decorator colors, and black or white.

For more data, write A63 on inquiry card

What a beautiful idea!



Briggs

5200 WEST KENNEDY BOULEVARD,
P. O. BOX 22622, TAMPA, FLORIDA 33622

a Jim Walter company



Narrower tank uses less water with no loss of efficiency



Think of what just one company can do to stop pollution. We have.

**WHAT
INDUSTRY
IS DOING
TO STOP
POLLUTION**



Keep America Beautiful, Inc.
99 Park Avenue
New York, New York 10016

Please send me a free copy of
"What industry is doing to stop pollution."

Name _____

Street _____

City _____

State _____ Zip _____

Twenty years ago some farsighted businessmen had an idea. To establish an organization to combat littering. They called it Keep America Beautiful, Inc.

Since then, KAB, Inc. has led a national movement to stop not just littering. But pollution as well. A movement that involves

almost 70 million Americans.

To show you what companies like yours are doing to fight pollution, we've put together this folder, "What industry is doing to stop pollution."

It's a special way to celebrate our first twenty years.

People start pollution. People can stop it.



A Public Service of
This Magazine &
The Advertising Council

Keep America Beautiful

99 Park Avenue, New York, New York 10016



specify for today's market . . . with

Speakman

Anystream[®]

**Shower Heads
with AutoFlo[®]**

Speakman's Anystream Shower Heads with Autoflo answer today's demand for water conservation. From the standpoint of ecology or economy . . . from the viewpoint of residential or commercial and institutional clients . . . the emphasis is on the *more efficient* use of water. And here's the beautiful way to do it. All models in the distinctively styled Anystream line are available with Speakman's patented water-saver. Autoflo is tamper-proof and maintenance-free . . . assures a satisfactory water flow rate . . . yet it can save thousands of gallons (and dollars) on each unit in the course of a year. Write for our new Anystream flyer and complete information.

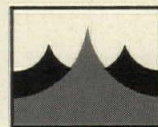
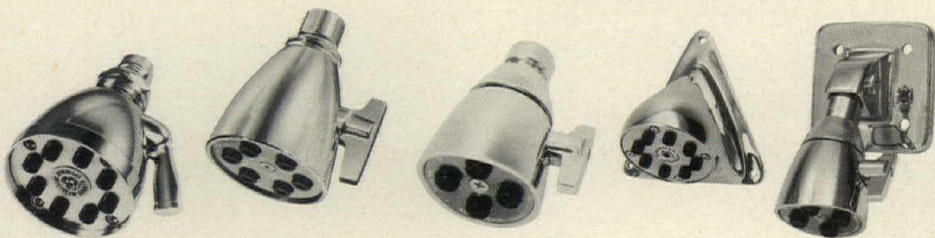

Speakman Company

WILMINGTON, DELAWARE 19899

For more data, write A64 on inquiry card

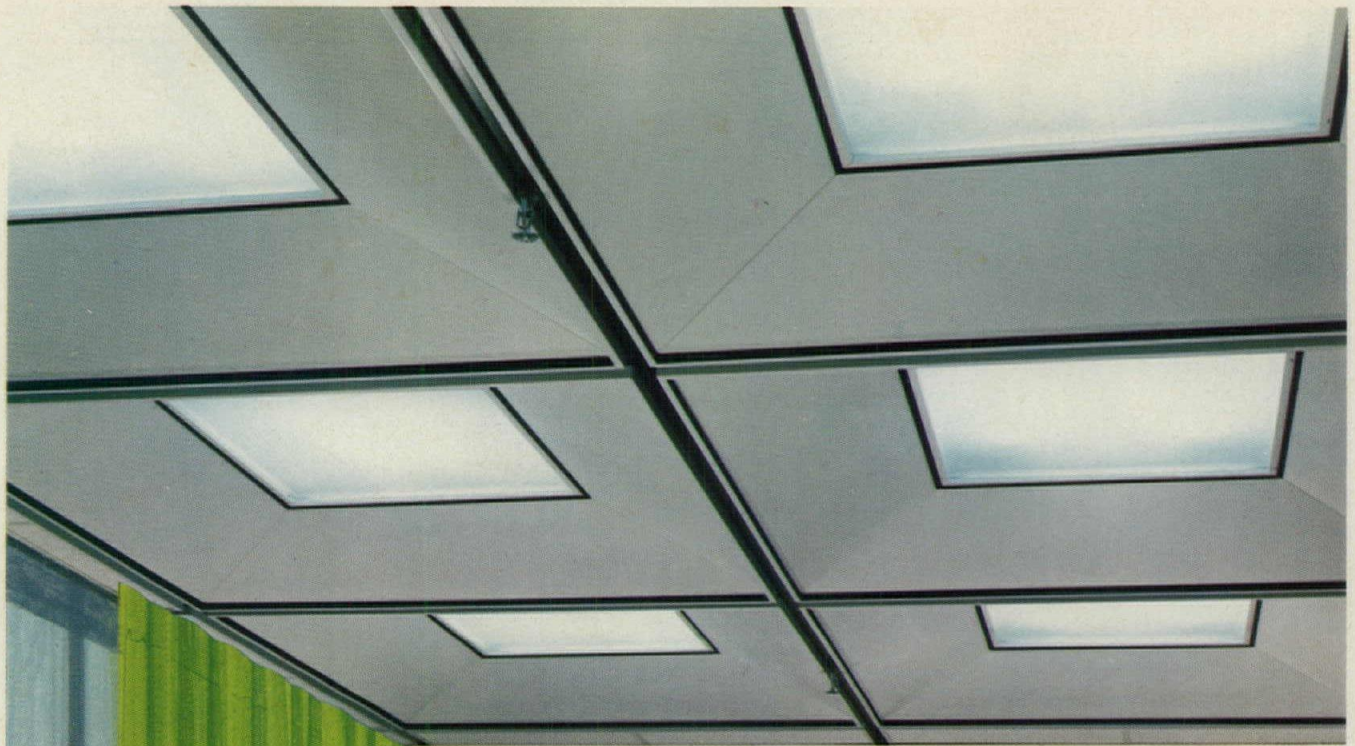

GUTH LIGHTING's NEW ENVIRONMENTAL CEILING:

DELIBERATELY DESIGNED TO BE THE BEST

With things like environmental ceiling systems, getting on the market early isn't as important as getting on the market with the *ultimate* system.

Such a system is GUTH LIGHTING's new "PROJECT EC"™ environmental ceiling—a simple and easily-installed four-component system that leaves *nothing* to be desired.

Provisions for heat removal, air conditioning, and acoustical control are all designed-in for maximum efficiency. The 5-by-5 grid system provides ideal dimensional combinations for installing or rearranging partitions as required, *without affecting airflow or lighting*. And PROJECT EC units can be mixed with flat panels in rows or checkerboards for additional design flexibility.

And options! Four sizes of fluorescent fixtures . . . choice of lens designs . . . flush or regressed full- or picture-frame doors . . . incandescent and H.I.D. fixtures . . . sound attenuation pans . . .

Get the PROJECT EC catalog. It provides a detailed description as well as technical specifications. You'll agree that GUTH LIGHTING did it right the first time.

GUTH LIGHTING



P.O. Box 7079
St. Louis, Mo. 63177
(314) 533-3200



SOLA BASIC DIVISIONS: ANCHOR ELECTRIC • BISHOP ELECTRIC • DIELECTRIC COMMUNICATIONS • DOWZER ELECTRIC • GUTH LIGHTING
HEVI-DUTY ELECTRIC • LINDBERG • NELSON ELECTRIC • SIERRA ELECTRIC • SOLA ELECTRIC • TEMPRESS WARREN G-V COMMUNICATIONS

For more data, write A65 on inquiry card

The energy crisis and the growing ritual of hot weather power reductions and failures have presented the electrical products industry with the responsibility of re-examining all available products in terms of functional needs and efficient operation.

Many buildings in the planning stage are to be supplied with alternate electrical systems for emergency operation or devices which will make economical use of power available.

Standby generators have dispensed with brushes and commutators in favor of solid state circuitry. Turbine drives are replacing reciprocative engines. The turbines are more efficient, quieter and compact.

Emergency lighting is available in a line of fluorescent luminaries in which one tube, powered by a compact self-contained battery, is illuminated upon any disruption of service.

An innovative heating system, depends upon electrical heat mats buried 12 inches beneath the slab of a one-story building. The powering of the mats during off-peak hours creates a heat reservoir five or six feet deep, which slowly gives up its heat to the slab, and does not require frequent replenishment. This system results in a relatively even heating profile and reduced power consumption by comparison with direct slab heating.

Metal halide, metal vapor and other lamp types are replacing incandescents and fluorescents for interior commercial and residential installations. A major advantage of these light sources is economical operation, also they can be corrected to deliver light in the incandescent color range, which fluorescents have yet to accomplish. One very efficient new 100 watt lamp contains its own ballast and is small enough to be screwed into any household lamp socket.

Railings with concealed lights have been rediscovered as an outgrowth of designer preoccupation with multi-level plazas. The railings are particularly well suited to locating boundaries and connecting links without illuminating the entire area.

The industry could perform a major service if it would seriously re-examine the question of light needs for all work and living situations. Footcandle recommendations which continue to increase have not greatly improved seeing conditions.

*Alex E. Goldfine
Consulting Editor, Sweet's Guidelines, New York, New York*

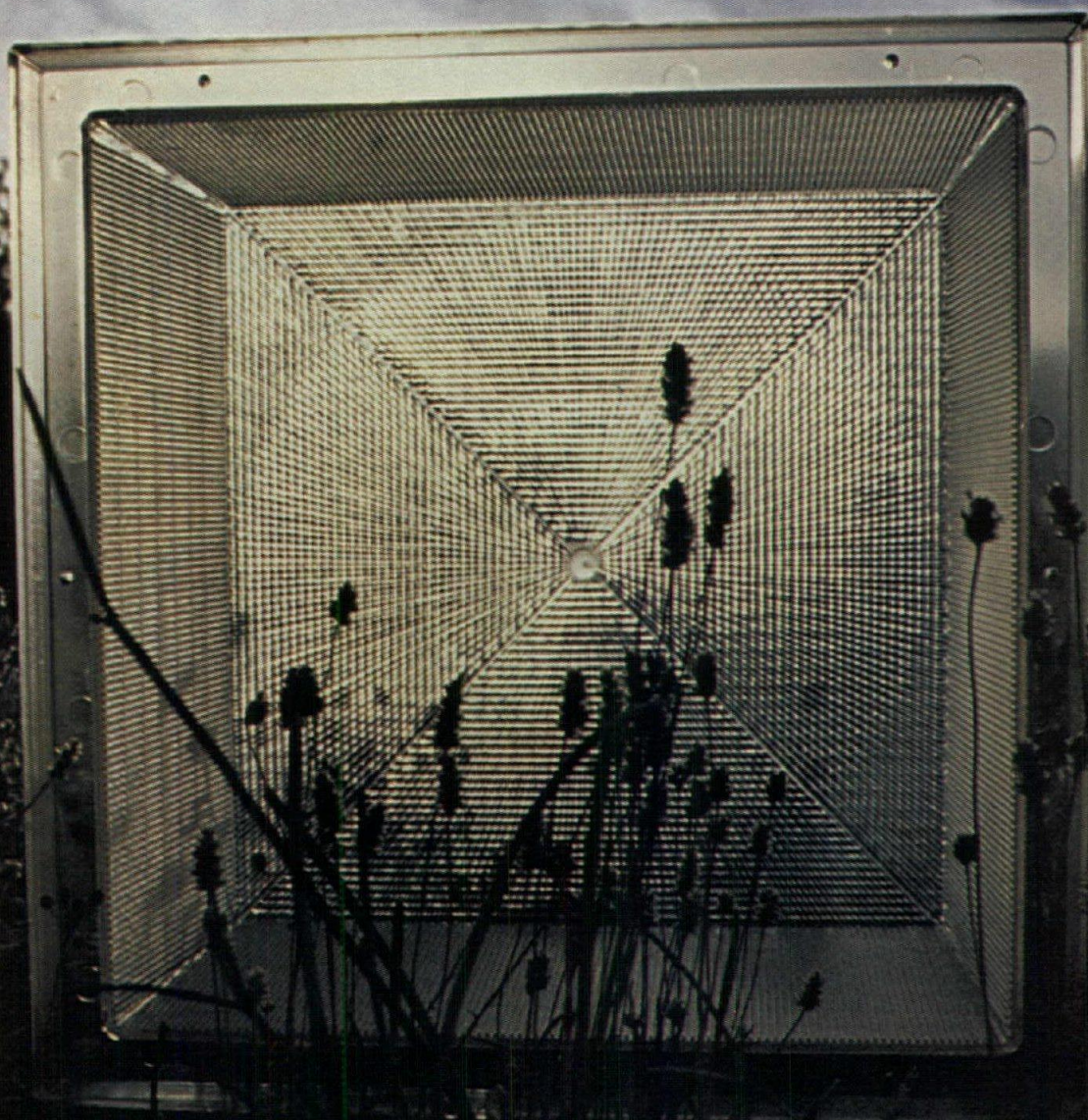

Durability is a beautiful thing...

Marco proves non-destructible lighting need not come in ugly little shapes. Mercury vapor, incandescent and fluorescent—over one hundred and fifty aesthetically appealing designs. Clear prismatic refractors or translucent opal diffusers of non-breakable G.E. LEXAN® photometrically engineered for performance. Durathon II, engineering specification lighting by Marco. Full color catalog available, write:

NON-DESTRUCTIBLE

Durathon II
SERIES

MARVIN ELECTRIC MANUFACTURING COMPANY • 6100 SOUTH WILMINGTON, LOS ANGELES, CALIFORNIA 90001

For more data, write A66 on inquiry card

A DIVISION OF
LCA
CORPORATION



857

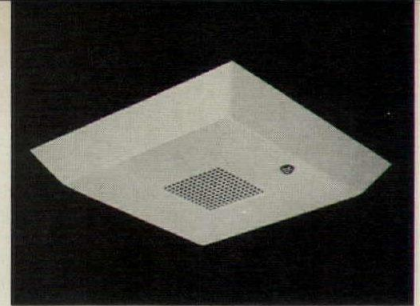

858

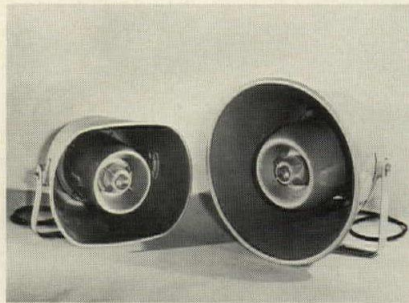

859

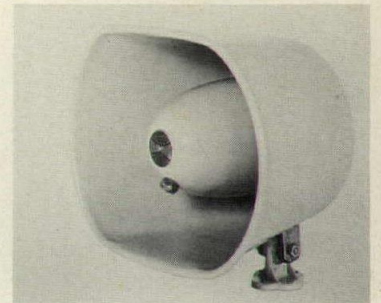

860

COMMUNICATIONS

857 MOBILE RADIO / A compact 2- or 4-watt, 1-to-6 channel portable two-way radio includes dual phase lock loop receiver circuitry and temperature compensated transmitter crystals for stability. The unit meets or exceeds EIA and military specifications for shock resistance. / E. F. Johnson Co.

858 FIRE DETECTOR / Permanent installation to house wiring is said to be unnecessary with this early-warning system with plug-in transformer. It senses products of combustion even in the incipient stages before smoke or flame appear, according to the company, activating a horn alarm. UL-listed. / BRK Electronics.

859 ALL-WEATHER SPEAKER / Full frequency-range reproduction of music and voice at high power is a major feature of these coaxial outdoor-indoor reflex speakers, according to the company. Designed for application in medium and high ambient sound level areas such as shopping malls. / Atlas Sound.

860 ALL-WEATHER SPEAKER / Designed for both indoor and outdoor applications, this music speaker has a continuous power rating of 10 watts, full range frequency response of 225-12,000 Hz and is recommended for sound reproduction in medium ambient noise level areas, such as shopping centers. / Atlas Sound.

861 VIDEO RECORDER / This compact set measuring 12 by 5 by 8 in. and weighing 14 lbs operates on AC or batteries while recording for 20 min-

utes. Stop motion, slow motion and operation with standard video camera are other features. / Sanyo Electric Inc.

862 APARTMENT INTERCOM / This voice-actuated system produces, according to the company, private lobby-to-apartment communication without possible inadvertent switching due to background noise. The entrance door is actuated by a push button on the apartment phone. / American Device Mfg. Co. A*

863 INTERCOM / Master stations are offered in 10-, 20- and 30-station capacity, with or without light annunciation. Modular add-ons permit expansion to 90 or more stations. A full 12-watts undistorted audio output is claimed. / Rauland-Borg Corp.

864 PROJECTION SCREEN / For either rear or front projection, the screen is made of 1-in. square hard alloy structural aluminum tubing. It is offered in three sizes up 96 in. square. It is said to be lightweight and portable. Three surfaces are offered. / Da-Lite Screen Co., Inc. A*

865 HAND-HELD RADIO / A compact single-channel 1.5-watt citizens' radio measures 8.9 in. high and 3.6 in. wide. Unit includes built-in antenna and speaker/microphone, and a pen cell battery pack. / E. F. Johnson Co.

866 MIXER-PREAMP / Unit features nine individually-controlled input channels and has provisions for an optional ultra-fast attack (30 micro-second) limiting-compressor module. Control interaction is absolutely zero, according to the company. / Rauland-Borg Corp.

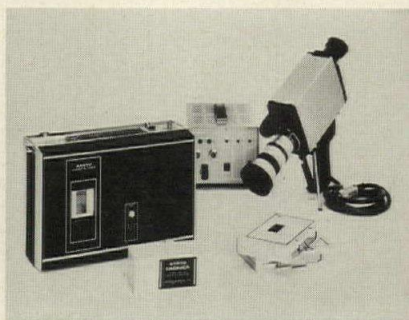

861

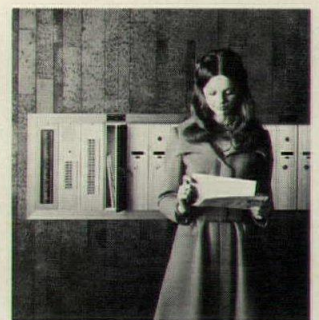

862

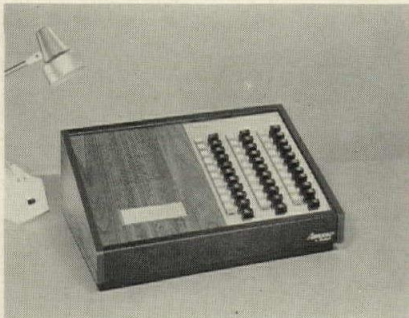

863

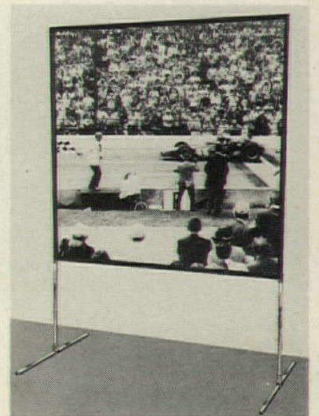

864



865



866

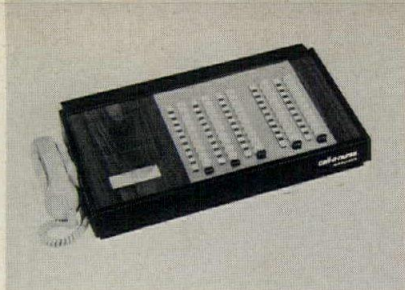

867



868



869

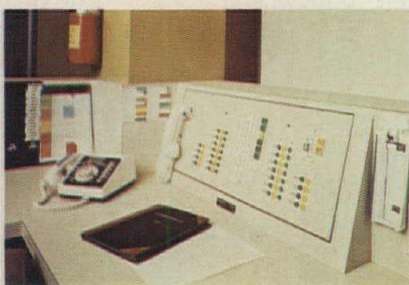

870



871

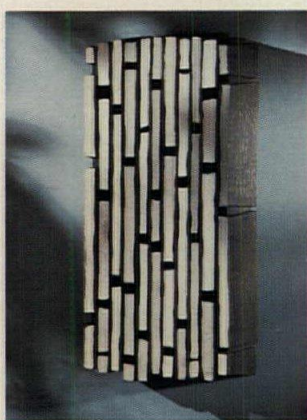

872

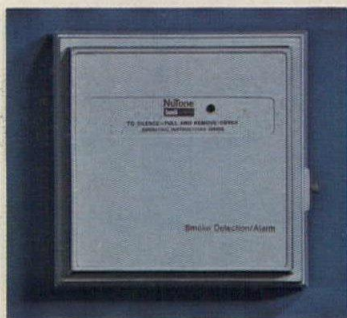

873



874

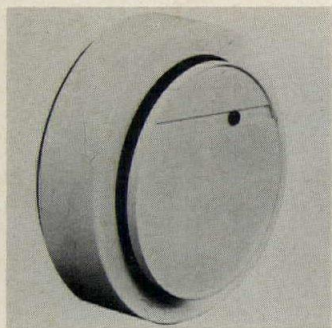

875

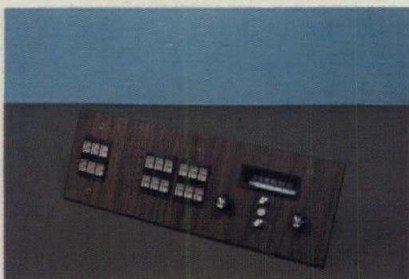

876

867 CALL-A-NURSE / A new line of audio-visual nurse call equipment provides for up to 120 patient stations with provisions for emergency signaling. All components are solid-state for minimum maintenance. Expansion potential is built-in, according to the company. / Rauland-Borg Corp.

868 RADIO INTERCOM / Seldom-used controls are concealed in the front of this unit with 6-wire centralized master with FM/AM. All-call paging with hands-free answering is offered, along with input jacks for record changer and tape player. Light and dark burl finish. / Nutone, Div. of Scovill. A*

869 PHONE INTERCONNECT / This system uses a specially-designed telephone instrument to provide many call-handling benefits not available on conventional phone systems, according to the company. This system offers locating features, and is maintained by local distributors. / Executone, Inc.

870 NURSE CALL / Audio-visual communication is provided with this system which allows open conversation as over a telephone—no push-to-talk buttons. A nurse-follower feature shows locations of all nurses and aides, and where they are needed. / American Zettler, Inc.

871 NURSE-CALL EQUIPMENT / Audiovisual equipment designed specifically for the health care market includes this nurse-call system, with two-way voice communication and emergency signal. Simplified wiring requirements reduce installation costs, according to the company. / Rauland-Borg Corp.

872 DOOR CHIMES / This contemporary design comes with face finished in bright, brushed, patterned and hammered silvers. Two notes for one door, one for second. The unit measures 16 3/8 by 8 by 3 1/4 in. deep. / Nutone, Div. of Scovill. A*

873 SMOKE DETECTION / The detector-alarm comes in built-in and plug-in models to provide early warning. Photoelectric cell activates horn alarm when smoke obscuration is from 2 to 4 per cent. UL-listed. / Nutone, Div. of Scovill. A*

874 PUBLIC ADDRESS AMPLIFIER / Four amplifiers and a preamplifier mixer are included in the CHS-A series rated up to 100 watts. All are solid-state and include an electronic compressor. High or low impedance microphone inputs are featured. / Bogen Div., Lear Siegler Inc.

875 SMOKE DETECTOR / A smoke detector is said to meet Federal standards for single station residential smoke detectors, and minimizes false

alarms with special air filters. An alarm is sounded when photocells sense smoke before it reaches the dangerous level. / Emerson Electric Co.

876 INTERCOM, HIFI CONTROL / For remote control of hifi units, this intercom master is available in many finishes and assemblies, according to the company. Shown is an 18-circuit master on a walnut wood grain-finished 7-gang flush-plate with black trim frame. / Touch-Plate, Inc.

877 HOTEL INTERCOM / A totally automated, guest-activated message center incorporates maid-request, wake-up and music. All services are offered to up to 10,000 rooms with this system, states the company. / Montgomery Data Systems, Inc.

878 CCTV CAMERAS / This series of closed circuit TV cameras is said to feature operation ranging from high performance in daylight to full darkness with interchangeable, fixed or zoom lenses. Common characteristics of all cameras are dual isolated video outputs and solid-state scan failure protection. / Moxon Inc.

879 TELEPHONE INTERCOM / The system includes facilities for multiple simultaneous conversations, paging, secretarial intercept and connection to an outside line. Up to 16 master phones or 15 plus any number of remotes may be included in the system. / Bogen Div., Lear Siegler Inc.

HEATING—COOLING

880 ROOFTOP HVAC / This fully-curved commercial rooftop unit offers heating capacities up to 600,000 Btuh and cooling up to 30 tons. Bottom supply and return construction is featured. / Bryant Air Conditioning Co.

881 SNOW MELTER / A double-sealed termination is said to increase reliability of factory connections between mineral-insulated heating cable systems and the cold leads. The patented termination eliminates the need for NEMA 4 cast iron accessible splice boxes used traditionally, according to the company. / Delta-Therm, Inc.

882 ROOFTOP COOLER / With bottom supply and return air duct connections, this unit will afford simple installation, according to the company. The model is available in cooling capacities up to 30 tons and can be used in multiples. / Bryant Air Conditioning Co.

883 WALL HEATERS / These forced air wall heaters, measuring 6 by 16 in., can be recessed horizontally or vertically and range from 660 to 1500 watts. Single or double pole thermostat kits are available. / Markel Electric Products, Inc.

884 ELECTRIC HEATING / This vertically-mounted system combines the advantages of both electric and hot water heat, according to the company. A permanently sealed fluid is circulated through the unit, with heat radiating. Constructed of aluminum, the unit is offered in many sizes, colors and wattage capacities. / American Stabilis, Inc.

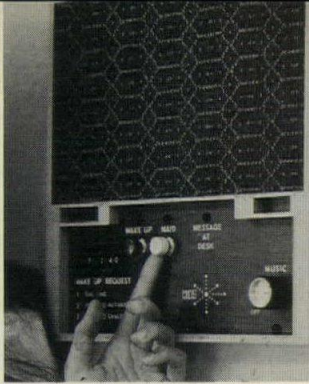

878

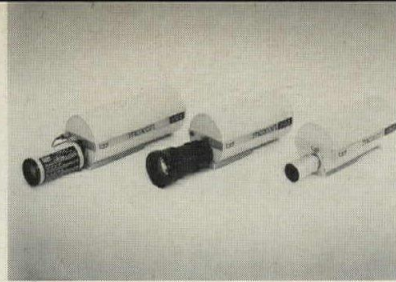

879



885 ELECTRIC BASEBOARD / This hot water electric systems does not require plumbing, because a permanently-sealed-in solution of water and antifreeze never needs replenishing, according to the company. Operation is controlled by thermostat. / Inter-therm Inc.

877

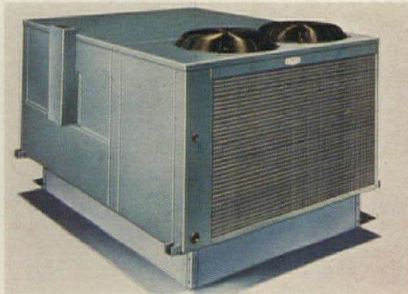

880

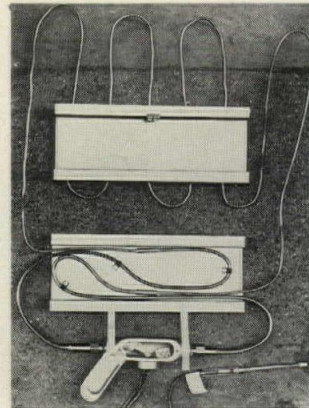

881

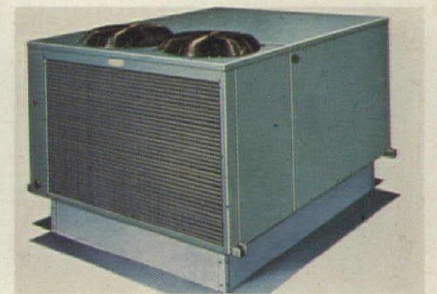

882

886 ELECTRIC FURNACE / UL-listed, the furnace is offered in four sizes with maximum cooling capacities up to 5 tons, and electric heat options from 5 to 35 KW. The unit is compact and said to meet NEC standards. / Bryant Air Conditioning Co.

CONTROLS

887 REMOTE DIMMING / this control provides on-off switching, preset light level intensity control and variable light travel selection. A rate control determines how long light intensity change occurs, from 1½ minutes to instantaneous. Fluorescent variations are offered. / Hunt Electronics Co.

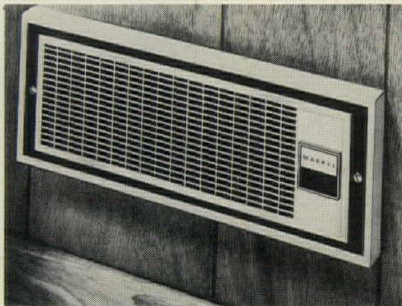

883



884

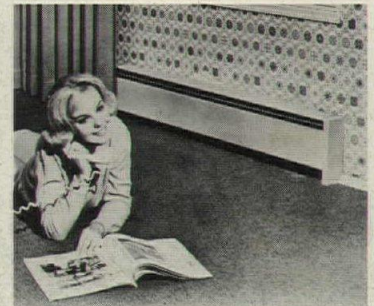

885

888 ELECTRIC THERMOSTAT / These thermostats have locking covers to prevent unauthorized changes of the set-point. A wrench is provided for the two Allen head screws which lock the cover. Two models are offered, both UL-listed. / Sunne Controls.



886

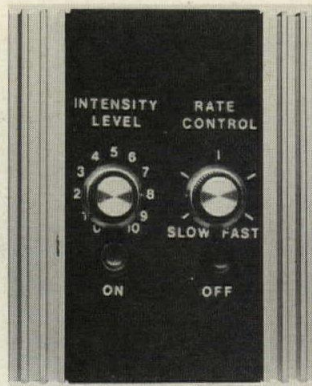

887



888

889 HUMIDISTATS / Electronic, pneumatic humidistats feature slim-line design. Two inches wide, they fit on ultra-thin mullions and include snap-on covers. Optional setpoint scales are offered. Available in chrome, brass, and prime finishes, they can be mounted horizontally or vertically. / Honeywell Commercial Div.

890 HEAT CONTROL / A solid-state, weather-actuated control is a remote indoor sensor designed for apartments, offices, etc., and automatically regulates heat based on outdoor weather and on actual building requirements. / Heat-Timer Corp.

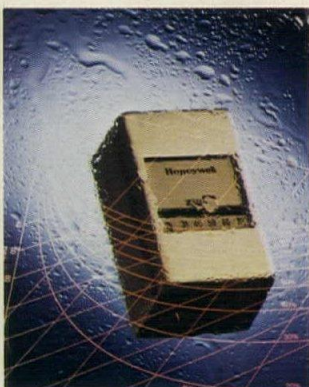

889

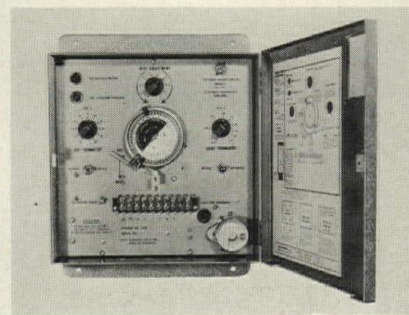

890

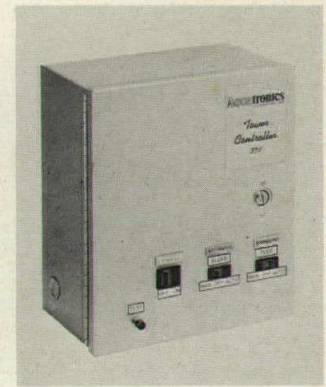

891

*Included in 1974 Sweet's Catalog File(s).

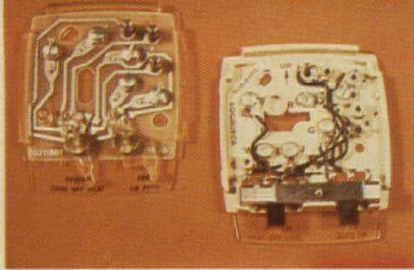

892

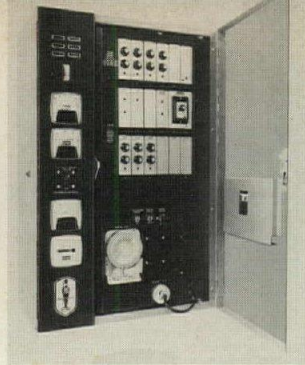

893

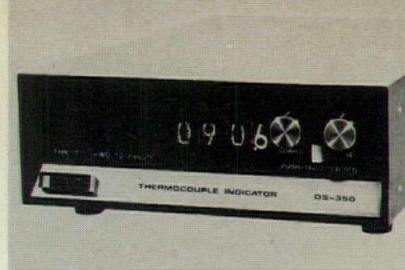

894

892 THERMOSTAT / For heating and cooling the unit is available with a printed circuit board sub-base to increase the reliability over thermostats with hand-wired and soldered wiring systems, according to the company. This unit will work with the company's gas and electric HVAC units. / Bryant Air Conditioning Co.

893 TRANSFER SWITCHES / A line of automatic transfer switches is designed to operate with the company's electric generator sets or with other engine-generator sets to make up a system of continuous power supply. / Onan Corp. A, I*



895

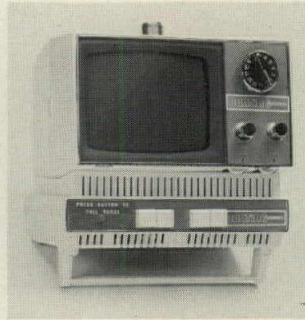

896

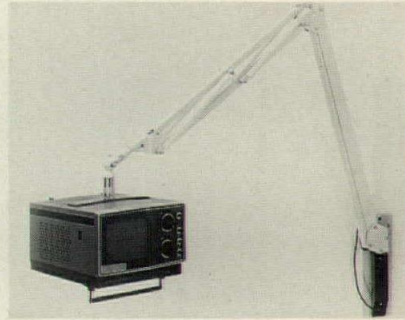

897

ELECTRONIC EQUIPMENT

894 TEMPERATURE TRANSFER / Unit provides a continuous display of temperature equivalents to millivolts. It is recommended for easy calibration of types of digital thermometers. / Doric Scientific Corp.

895 ALARM SCANNER / Unit will measure display, print and indicate alarm or shutdown conditions in any process where critical parameters can develop low-level DC voltage or current signals. / Doric Scientific Corp.

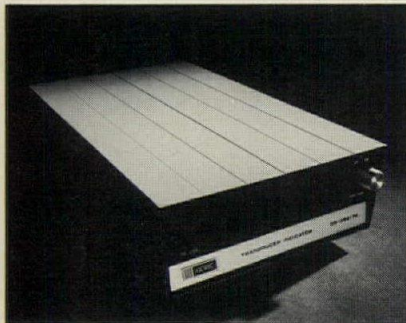

898



899



900

896 PATIENT CONTROLS / The hand-held bed control used with most electric beds, according to the company, is replaced with a set of controls integral with the company's television receiver. The control will work the bed, call the nurse and run the TV over a single, low voltage coaxial cable. / Bunting SteriSystems, Inc.

897 PATIENT TV ARM / A Sony 5-in. low voltage personal TV is connected to an elbow arm with safe triax connection, according to the company. The set may be moved with finger-tip control and will remain in its position until moved. / Bunting SteriSystems, Inc.

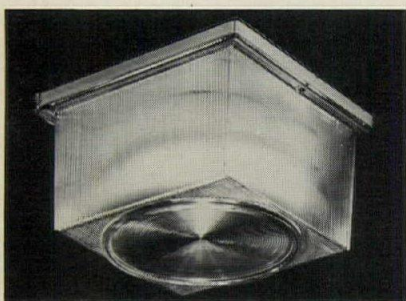

901

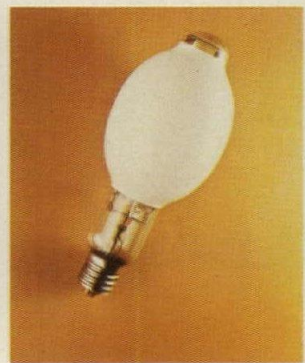

902

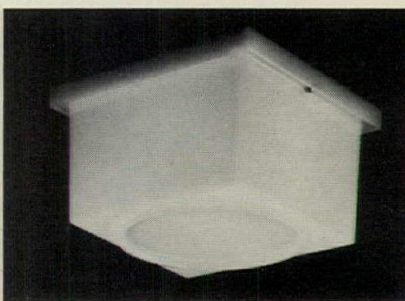

903

898 DIGITAL CONTROL UNIT / For use in industrial scales and weighing systems, this model is used to process digital data after analog-to-digital conversions by the indicator. Recommended for truck scales, batching and blending systems, and tank, hopper, and bin weighing systems. / Doric Scientific Corp.

899 DIGITAL THERMOCOUPLE / With 12-point input switch, the product features an analog-to-digital converter which minimizes scalar drift with time and temperature, according to the company. / Doric Scientific Corp.

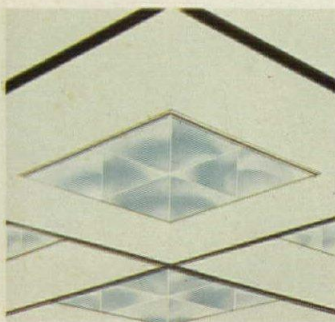

904

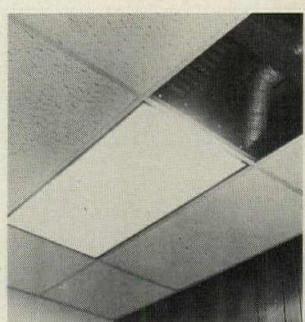

905

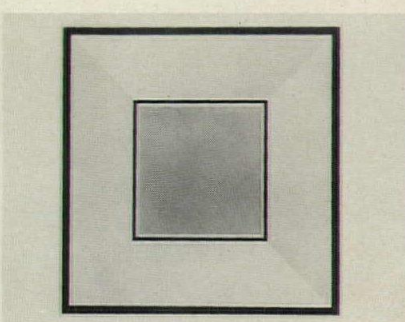

906

LIGHTING

900 ILLUMINATED CEILING / A see-through illuminated ceiling permits the polished metal reflections of ornamental G-lamps to be seen through acrylic shielding elements. There are 20 variations, and choices include chrome, bronze or aluminum pans; clear or tinted lamps; and 1/2-in. thick horizontal or vertical shielding. / Neo-Ray Lighting Systems, Inc.

901 CLEAR LUMINAIRE / A vandal-resistant clear prismatic luminaire is designed for continuous lamp operation under extreme physical abuse, according to the company. Unit accommodates 100-watt incandescent lamps. It is UL-listed for indoor/outdoor use and all metal parts are concealed to resist weathering. / Art Metal Lighting.

902 SELF-BALLAST LAMP / Designed to replace incandescent lamps of the same wattages in industrial applications, these self-ballasted mercury lamps come in a variety of wattages. / General Electric Co.

903 OPAL LUMINAIRE / Virtually indestructible and non-corrosive according to the company, this luminaire will accommodate 100-watt incandescent lamps and continue to operate under abusive conditions. / Art Metal Lighting.

904 MODULAR CEILING / Compact, featuring flat modules of perforated metal, is a 28-in. square parabolic louvered fixture which provides efficient low brightness with low wattages per sq ft, according to the company. Sound absorption and air supply and return are included. / Day-Brite Lighting Div., Emerson Electric Co.

905 TROFFER / A series of troffers is said to have the capability of handling the total air capacity deliverable by the air chamber in every type of commercial ceiling. Several sizes are offered in all popular types, according to the company. / Smithcraft Lighting Div., Keene Corp.

906 CEILING SYSTEM / This system is designed for illumination, thermal recovery, air conditioning and acoustical treatment for either new or remodeling applications. The 5-by 5-ft units have a 30-in. square fluorescent lighting fixture. / Guth Lighting.

907 PARKING LUMINAIRE / The cubic shroud houses a 24-in. diameter aluminum reflector. Unit combines peak candlepower at 70 degrees with good beam cut-off for low glare optics, according to the company. Standard color is bronze and cylindrical shroud is also offered. / Crouse-Hinds Co.

908 FLOODLIGHT / High intensity discharge fixtures offer a choice of beam patterns and five standard mounting arrangements, according to the company. The cylindrical housing is said to be vandal-resistant. Two, three or four units may be mounted in a line atop a standard 2-in. pipe tenon or four may be cross-mounted. Units are integrally-ballasted. / Holophane Co., Inc.

909 PRISMATIC LENS / This flat lens is said to eliminate veiling reflections, and has the potential of achieving a 25 per cent reduction in electrical power requirements for the lighting system of a building, while providing the proper level of illumination. / J. W. Carroll & Sons.

910 WOOD LIGHT POLE / Select grades of Idaho White Fir are laminated and pressure-treated with preservative to create these lighting poles in many sizes and heights. Poles permit up to five luminaires each. / Harvey Hubbell, Inc.

911 HID FLOODLIGHT / Ellipsoid styling plus photometric efficiency are featured on this exterior floodlight. Ground-mounting unit uses a separate but integral ballast. Mounting can occur in single or cluster configurations and bronze or color finishes are offered. / Wide-Lite Corp.

912 LUMINAIRE / Designed as a replacement for lights on the Golden Gate Bridge, the luminaire complements the original bridge design using a high pressure sodium lamp in a dropped square acrylic lens tinted yellow. / Gardco Mfg. Co.

913 AREA LIGHT / This heavy-duty light with all-aluminum construction is available in single, twin, triple or quadruple light models. The complete assembly includes square-shaped pole and bracket arm, and 400- and 1000-watt mercury vapor or metal halide lamps can be used. / ElSCO Industries.

914 STREET LIGHTING / This 1000-watt EKG series with sharp cut-off provides major highway and parking lot light, according to the company. The reversed lamp position increases the luminaire's efficiency and units can be equipped with all 400- and 1000-watt HID lamps. Self-contained ballast assemblies. / Kim Lighting, Inc.

915 POLE LIGHT / Said to fit easily into surrounding wooded areas, the wood pole and white opal lens accentuates the outline of the cast corner braces. / Gardco Mfg. Co.



907

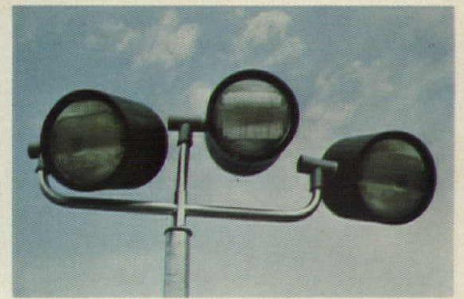

908

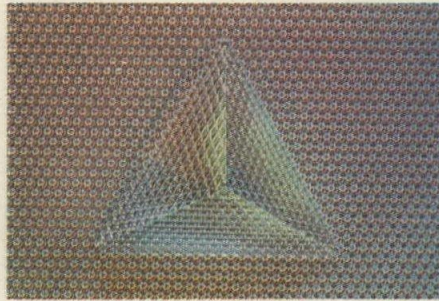

909



910

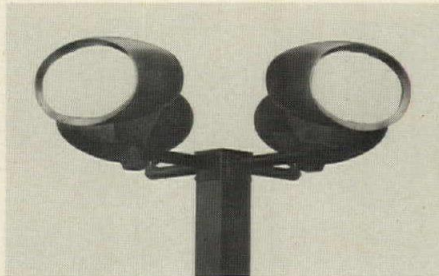

911



912



913

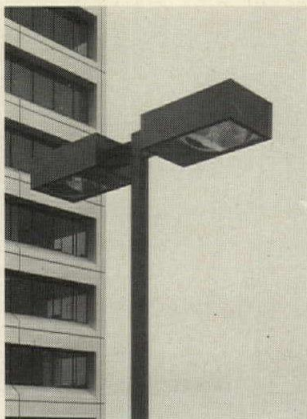

914

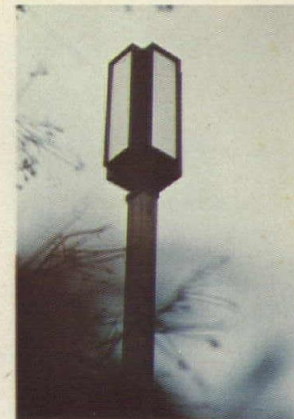

915



916



917

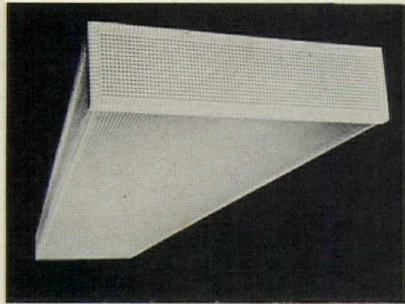

918

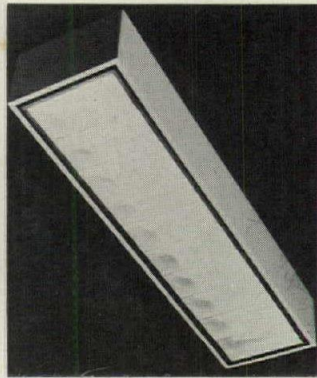

919

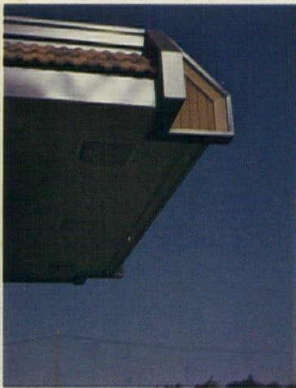

920

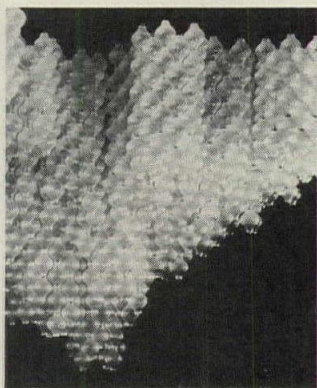

921

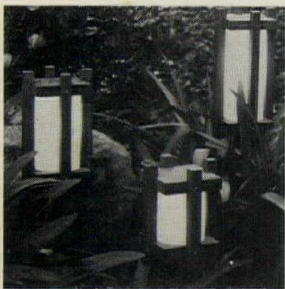

922



923



924



925

916 LUMINAIRE / The square appearance of this unit is accentuated by white opal panels and cast corner rails. The metal can be painted any color, according to the company. / Gardco Mfg. Co.

917 AREA LIGHT / *Form 10* makes use of wood cross arm and pole to blend with the landscape. Earth tone anodizing of the luminaire furthers this design objective. / Gardco Mfg. Co.

918 WRAP-AROUND LENS / An injection-molded wafer-thin lens is designed to make fluorescent fixtures look built-in. It consists of uniform, square base, male conical prisms which are said to assure high efficiency and effective light control. Clear and opaque end caps snap into place. / American Louver Co.

919 LOW-BRIGHT FIXTURE / A surface-mounted low-brightness fixture that provides "batwing" distribution is available in 1 by 4-ft and 2-ft square sizes, with an overall depth of 6 1/8 in. Aluminum baffles provide the low brightness. / Keene Corp., Smithcraft Lighting Div.

920 CANOPY LIGHT / For indoor or outdoor applications, the light has a built-in reflector to deliver great lumen output and brightness control, according to the company. Choice of mercury vapor or metal halide in prismatic glass or drop panel plastic lenses. All-aluminum body construction. Surface, stem or recessed mounting is offered. / ElSCO Industries.

921 LIGHTING GLASS / Free-form glass shapes composed of hand-blown Venetian glasses, these many configurations scatter illumination throughout the composition, according to the company. Many groupings and colors are offered. / Lumen Design Co.

922 OUTDOOR LIGHTING / A series of redwood-accented 12-volt lights is offered for low-voltage outdoor applications. The redwood is treated to protect against weather. Company claims the product is safe and recommended for residential use. / Sylvan Designs, Inc.

923 PATIENT CARE UNIT / *Com-Core* is a comprehensive patient care system with integrated arterial distribution. It features general room illumination, patient reading/examination light, patient/staff communication, electric power, telephone, medical gases and vacuum. / Day-Brite Div., Emerson Electric Co.

924 LUMINOUS CEILING / Two new opaque finishes are available with the company's acrylic cube ceiling system. The opaque white and black finishes form an uninterrupted ceiling plane on an invisible grid. The ceiling features a 1 by 2-ft louver module. / Integrated Ceilings, Inc.

925 AREA LIGHTING / This 16-in. square cube will fit any of the company's step-tenon or plain bases and can be used with incandescent lamps to 300 watts, or mercury lamps to 175 watts. Units can also be wall-mounted and multiple-mounted. / McGraw-Edison Co.

926 INCANDESCENT CEILING / The addition of incandescent lighting to what was previously an all-fluorescent luminous ceiling system produces a soft light with two-lamp indirect fixtures for mounting within the coffers. / Integrated Ceilings, Inc.

927 MERCURY VAPOR DOWN-LIGHTS / In both cylinder and square shapes, these fixtures are available in either ceiling or wall bracket assemblies. Heavy gauge aluminum construction and a variety of finishes are offered. Sizes include 8- and 12-in. units. / Prescolite.

928 SURFACE CYLINDERS / A series of flared cylinders have been added to the company's line of lighting fixtures. They are furnished in brushed aluminum, bronzotic, matte white or black, with various liner combinations. Sizes range from 3 1/2 to 8 in. in diameter and all units fit 3/4 or 4 in. outlet boxes. / Prescolite.

929 FLUORESCENT EMERGENCY / Available in 120- and 277-volt models, the system can be ordered as a conversion unit for existing fixtures or on new units. The system is said to restore no-glare light up to 90 minutes. A pre-wired push-to-test indicator light confirms the battery is charging. / General Electric Co.

930 FLUORESCENT DIMMER / Lamps are said to dim or brighten smoothly in unison over the complete dimming range from full brightness down to 0.05 per cent of maximum intensity. The UL-listed system is capable of operating 100 dimming auxiliaries, and compensates for voltage fluctuations. / General Electric Co.

931 EMERGENCY LIGHT / This twin-head unit is said to provide up to 1 1/4-hour operation and meets NEC and OSHA standards. Unit is designed for permanent conduit connection to 120-volt power. Batteries are sealed gelled lead acid electrolyte type. / Tel-edyne Big Beam.

932 EMERGENCY LIGHTING / This battery-powered unit features a maintenance-free battery and charger, according to the company. Sealed batteries never need filling. / Tork Time Controls, Inc.



926

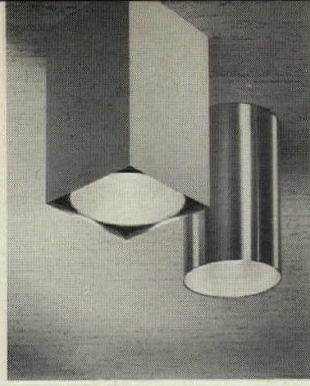

927



928

933 EMERGENCY LIGHTS / The company claims the 12-volt solid-gel electrolyte battery with this unit never needs water. The *Reddi-Lite* features 18-watt sealed beam lamps that adjust vertically and horizontally. Up to five hour operation is claimed. Total weight with battery is 14 lbs. / American Dryer Div., Utah-American Corp.

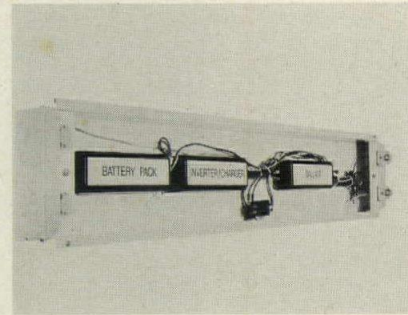

929

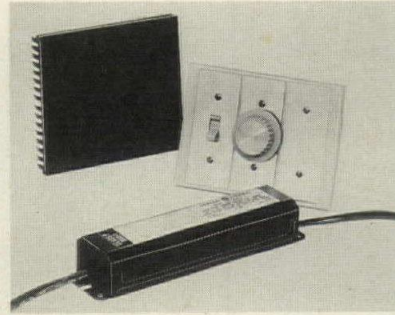

930

934 INDUSTRIAL HID UNITS / For operation with mercury vapor, metal halide and high pressure sodium lamps, the *Industra II* line features a power pack capable of operating either mercury or metal halide lamps. Mounting arrangements include a plug assembly for quick connection or removal. / Day-Brite Div., Emerson Electric Co.

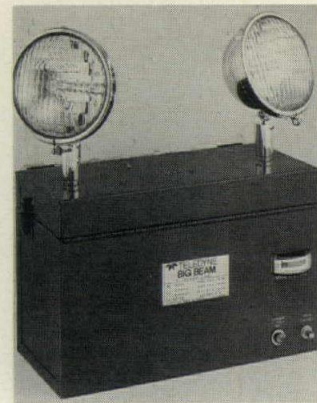

931

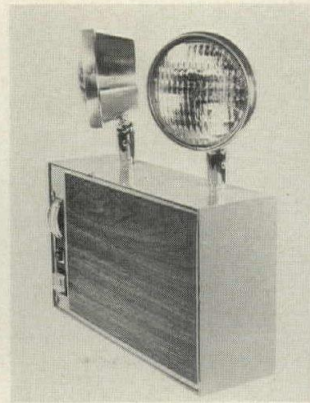

932



933

935 SHOW LIGHTS / Designed for home or office, these table, wall and floor lamps feature professional lighting "barndoors" that adjust the amount of light needed. Available in chrome and four colors. / Berkey Colortran, Inc.

936 HID FIXTURE / This indoor luminaire offers a high-strength *Teflon* lens for what the company claims is extremely high photometric efficiency. An optional plug-in connector permits the entire integral ballast and luminaire to be quickly connected. / Wide-Lite Corp.

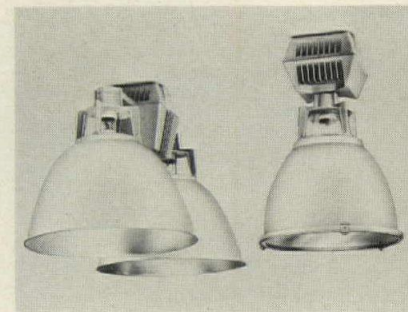

934



935



936

937 ILLUMINATED CEILING / Of uniform or irregular length, randomly or regularly spaced, clear or colored, the acrylic crystals of this ceiling offer numerous design opportunities in wall-to-wall ceiling treatment, according to the company. Crystals blend with supporting grid. / Neo-Ray Lighting Systems, Inc.



937

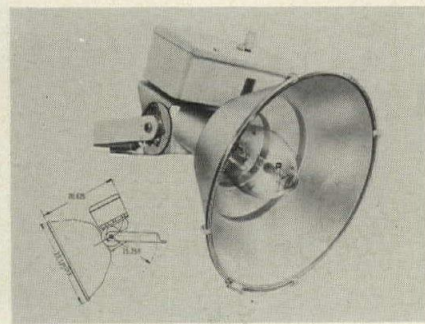

938

938 FLOODLIGHT / Recommended for sports fields and work areas, this floodlight is designed with emphasis on heavy-duty construction and long-throw capability (over 250 ft). Unit is meant to be mounted 30 to 120 ft high. For use with high-wattage HID lamps. / Westinghouse Electric Corp.



939



940

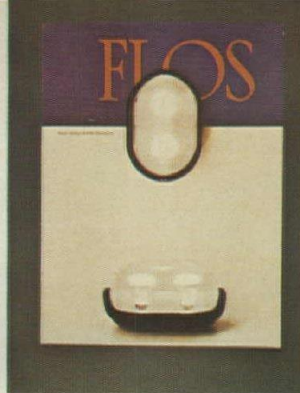

941

939 DIFFUSER MATERIAL / Designed for HID applications, this new grade of *Lexan* is recommended for diffusers and shields because its service life is said to exceed that of previous UV-stabilized grades of plastic and approaches or surpasses mercury vapor lamp life. At 265 degrees F, *Lexan 303* provides continuous service. / General Electric Co.

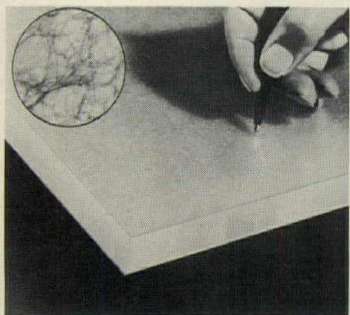

942

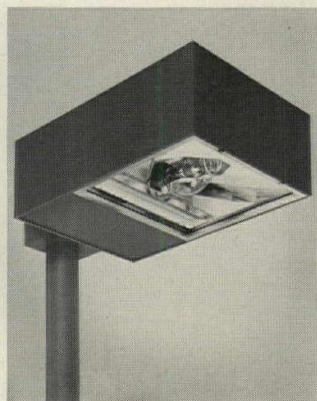

943

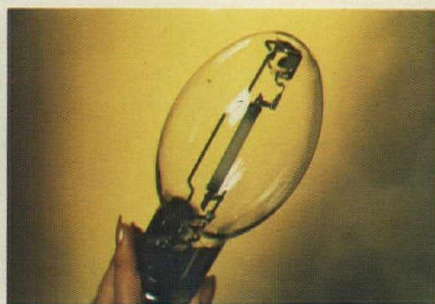

944

940 LIGHT DIFFUSER / An acrylic, light polarizing panel producing symmetrical distribution of vertically plane light can be incorporated into fluorescent commercial, industrial and institutional luminaires. The company claims a savings in energy of 25 per cent minimum, compared with other light shielding materials. / Polrized Corp. of America.

941 ALL-PURPOSE LAMP / For wall, table and floor use, the *Noce* lamp is constructed of cast aluminum, with baked enamel finish and tempered glass diffuser. Up to 150 watts of illumination can be provided. / Atelier International, Ltd.

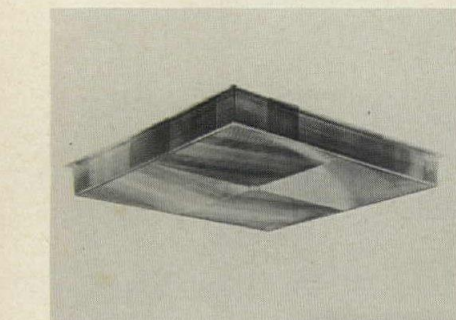

945

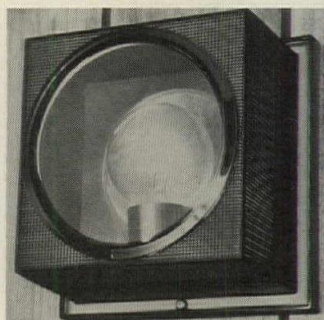

946



947

942 LIGHTING SHIELDS / The company now has a *Plexiglass DR* acrylic plastic for extrusion and injection molding into high-impact fluorescent lighting lenses and diffusers. Primary potential is seen in outdoor applications, subways, schools and prisons. Clarity and weatherability are also claimed. / Rohm and Haas Co.

943 CUTOFF FLOOD / The polished reflector assembly in this luminaire projects light forward. The back-side cutoff can be located at the base of the pole by using a houseside shield. The product is recommended for tennis courts, perimeter parking lots or close to buildings where no spill light is desired. / Gardco Mfg. Co.

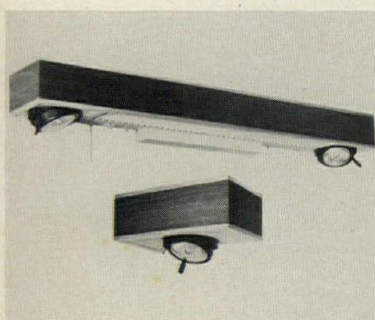

948



949



950

944 ENERGY-SAVING LAMP / Development of this 150-watt *Lucalox* lamp is said to contribute to energy conservation and reduce lighting costs. Light output is 16,000 lumens (106 lumens per watt) and lamp has an average life of 12,000 hours. Mogul base. / General Electric Co.

945 DROP LENS / The 20-in. square multiple use lens for indoor/outdoor applications features a 2½-in. deep, vertical drop of molded acrylic for discoloration-free use. Various light distributions are possible by rotating the refractor. / LexaLite Corp.



951

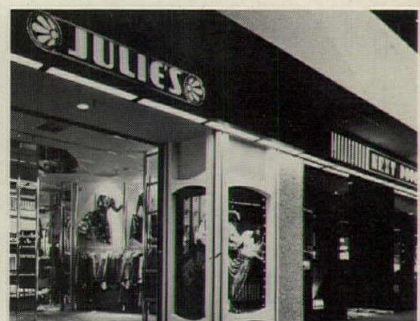

952

946 BRONZE-TINTED LUMINAIRE / A vandal-resistant luminaire featuring tinted polycarbonate, will accommodate decorative lamps of any

wattage, as well as 100-watt incandescents. UL-listed for indoor/outdoor applications, the unit is fully gasketed. Available in clear plastic. / Art Metal Lighting.

947 SODIUM LAMP / The company has developed a high pressure sodium lamp which they claim will produce 70 per cent more average lumens consuming 10 per cent less energy in many mercury vapor lighting systems without changing ballasts or fixtures. / GTE Sylvania Inc.

948 EXAMINATION LIGHT / A physician's examination light offers high intensity lighting that is adjustable, non-glare and cool according to the company. The system utilizes 12-volt, 50-watt PAR 36 spot lamps. Lights are gimble-ring mounted with dual axis directional control. / The Miller Co.

949 FLUORESCENT EMERGENCY / A battery-powered inverter system is said to permit existing fluorescent lighting to be used as emergency lighting. The company's product, using a small inverter, changes a battery's DC power to AC, the type required for fluorescent operation. / Exide Power Systems Div., ESB Inc.

950 MINIATURE LIGHTS / For accent lighting applications, primarily in residential buildings, the track and lampholders have been reduced in size and are available in black and teak, polished aluminum and paint. / Halo Lighting, McGraw-Edison Co.

951 SELF-POWERED EXIT / An integral emergency power pack will automatically keep this exit light illuminated for a minimum of 1½ hours, according to the company. Normal life of the unit's replaceable batteries is six years. / Sechrist Lighting Div., Keene Corp.

952 STOREFRONT LIGHTS / A method of interior lighting and signing is recommended for malls. It provides low-level interior lighting for the arcade, while projecting a wall wash of light on the front of the store. Sign circuitry ties in with tenant's lighting. / Thomas Industries, Inc.

953 LIGHT POLE / This is claimed to be a stronger model of the company's original glass filament light pole, offered in a full range of environmental colors. The pole is said to be lightweight, non-conductive, chemical- and weather-resistant. / W. J. Whatley, Inc.

954 CENTRAL POWER SYSTEM / A battery-powered system for critical alternating current loads provides an uninterruptible power supply, according to the company. It is designed to automatically feed no-break AC power to selected critical loads as well as to emergency fluorescent lighting. / Exide Power Systems Div., ESB Inc.

955 LOW CEILING FIXTURES / With matching wall sconce, this unit is available in polished chrome or brass, as well as in six decorator colors and white. Fixtures hold 100 watt bulbs. / A. W. Pistol Inc.

956 LONG-LIFE BULBS / For the bare-bulb look, these Scandinavian-inspired bulbs come in 40, 60 and 100 watts and are said to deliver 4000 user hours of light and fit standard fixtures. / Duro-Test Corp.

957 TWIN BEAM LIGHT / The acrylic enclosure of this product directs illumination to the side, reflecting away from the normal viewing angle and improving the contrast, according to the company. Offered in sizes up to 1- by 8-ft, at a depth of 1¾ in. / Guth Lighting.

958 EMERGENCY LIGHTING / Battery-powered, this system operates a single 40-watt fluorescent lamp for 1½ hours at 20 per cent of its rated lumen output, according to the company. Designed to comply with OSHA regulations. / Guth Lighting.

959 REDWOOD POLE LIGHT / This California redwood pole holds a polyethylene globe 96 in. above the ground, and is said to cast a wide area of light. / Victor Mfg. Co.

960 MODULAR LIGHTING / Identical in design, three lines of fluorescent, incandescent and HID recessed lighting fixtures are offered so that applications can look uniform regardless of illumination requirements. Sizes range up to 4-ft square. / Guth Lighting.

MOTORS & CONTROLS

961 LOAD BANKS / A line of low-cost packaged load banks with capacities from 6KW to 800 KW use the engine cooling air for load element cooling, and can be mounted on the engine or in an air exhaust duct. According to the maker, they require no external power or cooling water. / Avtron Mfg. Co.

PROTECTIVE SYSTEMS

962 HOME BURGLAR ALARM / Wireless sensors are used in this low-cost residential system. Alarm is triggered by light pulses. Recommended for perimeter (door and window) protection. Self-powered. / Flashguard Inc.

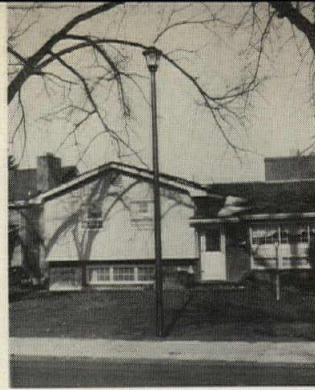

953

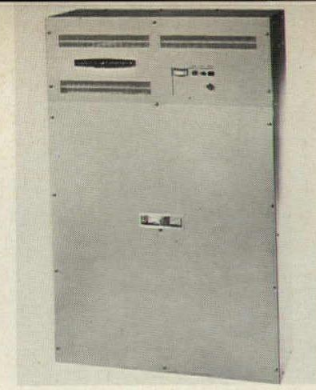

954

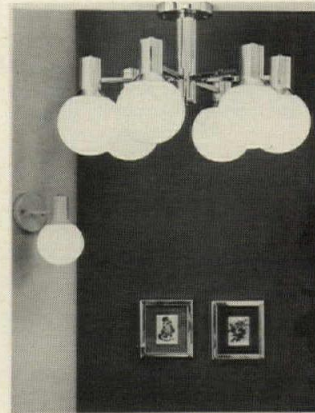

955

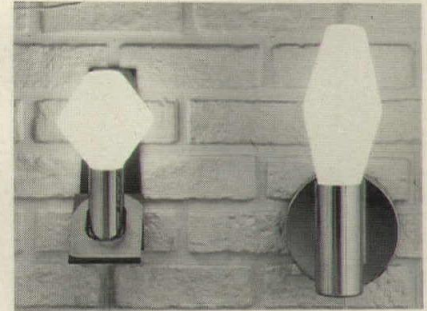

956

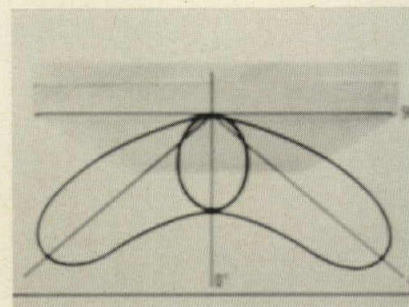

957

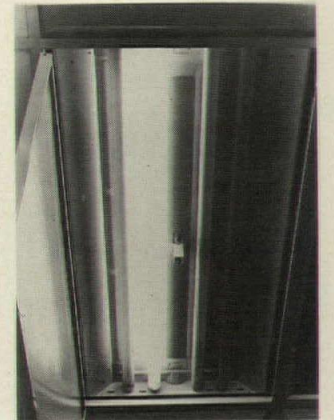

958

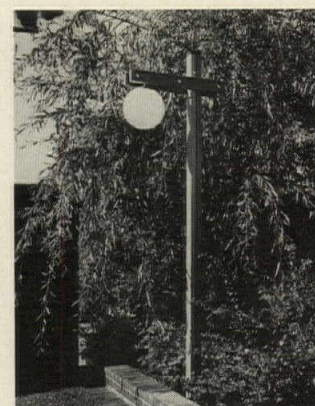

959

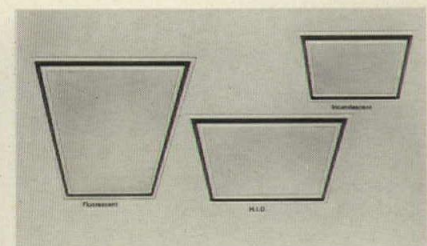

960

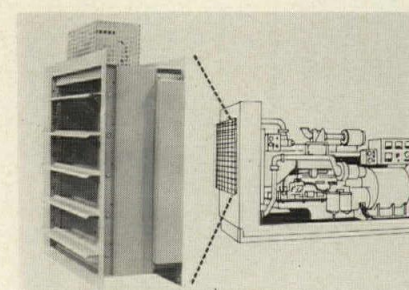

961

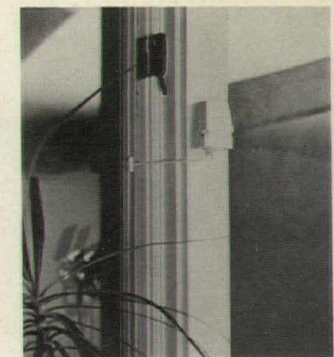

962

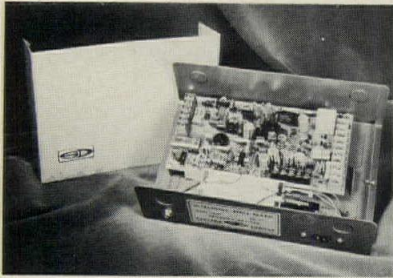

963



964

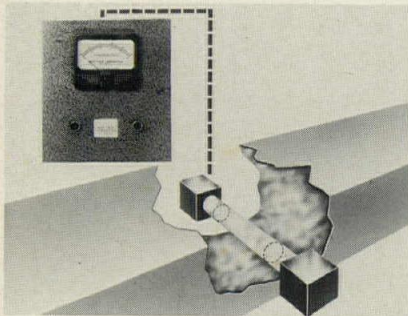

965



966



967

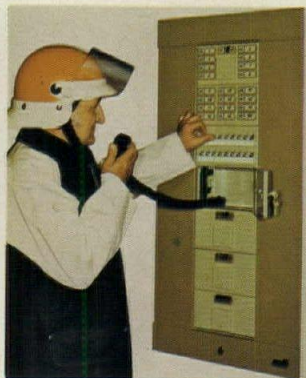

968

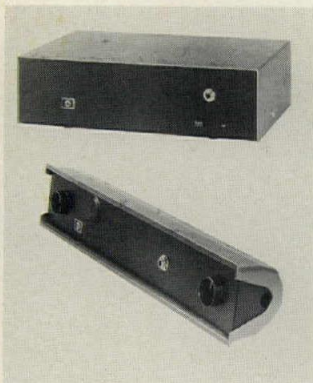

969

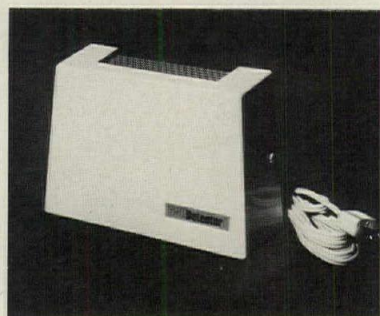

970

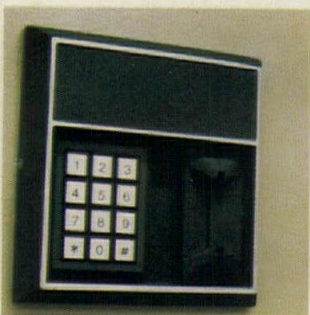

971

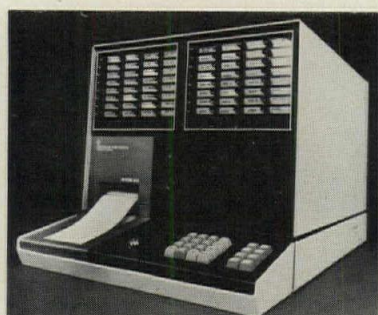

972

963 ULTRASONIC ALARM / Designed for large-scale ultrasonic detection systems, the product features radio frequency interference rejection circuitry. Combined with the company's transducers, system can protect an area of up to 18,000 sq ft, according to the company. / Systron-Donner Corp.

964 ELECTROLYTIC GROUND / This primary electric ground provides low resistance grounding capability and complies with OSHA regulations under revised UL standards, according to the company. Operates automatically by barometric, temperature and humidity changes. / Xit Rod Co.

965 SMOKE ALARM / A solid-state indication alarm continuously measures and indicates smoke density, which if exceeds a limit, actuates the alarm. Designed to show inefficient boiler operation, unit helps save on fuel according to the company. / Heat-Timer Corp.

966 SECURITY MONITORING / For medium to large public and private facilities, this system can monitor up to 600 points of security and fire, covering every type of problem, according to the company. All information is directed to in-house personnel and records data. / Gamewell.

967 ACCESS CONTROL / The company claims this is a low-cost system offering instant cancellation of access cards from a central console. The system controls up to 4 entrances and up to 1000 card holders. Hard copy printout of every entrance is provided. / Rusco Industries, Inc.

968 FIRE ALARM / For high-rise structures, schools and many types of buildings, the *DirecTone* couples a distinctive fire alarm alerting signal and a voice command communication for directing occupants to safe areas. System can be zoned. / Federal Sign & Signal Corp.

969 INTRUSION DETECTOR / An automatic digital signal processing detector consists of up to 20 transceivers which will cover an area of up to 15,000 sq ft, according to the company. A sound inaudible to the human ear, if interrupted, will start the alarm and signal the guard. / Detection Systems, Inc.

970 GAS-SMOKE DETECTOR / This self-contained plug-in unit is an ionization-type detector with a loud built-in alarm horn. Detects gases and fumes such as those from combustion and fire. / Flashguard Inc.

971 ENTRANCE CONTROL / Card, push-button or combination readers for entry control are weatherproof, according to the company and programs

can be changed quickly. Numerous coding variations are possible and the system is low cost. / Notifier Co.

972 ACCESS CONTROL / A card reading security control system is designed to monitor and control all security access from a central location and can be interfaced with a company computer for automated timekeeping and payroll purposes. / Sentracon Corp.

973 ACCESS CONTROL / This total access control is said to provide automatic recorded control for up to 100 entrances, up to 5000 card holders, at any distance, using telephone lines. Itemized printout of every entrance is offered. / Rusco Industries, Inc.

RACEWAYS

974 SURFACE RACEWAY / This vinyl surface-mounted electrical raceway permits wiring to go around the door and continue in the company's baseboard raceway. The trim is mar-and dent-resistant and can be painted. / Johnson Rubber Co.

SERVICE & DISTRIBUTION

975 POWER POLE / A portable power-pole consists of a 1 3/4-in. diameter, stainless steel, telescoping pole completely pre-wired with electrical outlets and matching ceiling receptacle. The unit distributes power from a special ceiling box to floor level locations. Available in single and multiple circuit models. / Avtec Industries, Inc.

WIRING DEVICES

976 METER CENTERS / Designed for apartment and light commercial service, these breaker-meter units stack up to six high or 60 in. tall. Units will accept standard four-jaw meters. Stacks are two and six high. Permits safe servicing without shutting down power to other apartments in set-up. / Bryant Electric Co.

977 PANELBOARD / A tamperproof electrical panelboard meeting OSHA requirements can save owners on maintenance according to the company. The *Kwik-Latch* panel can be provided with most circuit breaker components specified. Whole front panel is hinged. / Electric Panelboard Co., Inc.

978 LOAD CENTER / Unit combines fusible mains with circuit breakers for branch protection. The branch breakers are available with interrupting capacity of 5000 or 10,000 amperes and provide economy and convenience, according to the company. Models can accommodate up to 40 branch circuits. / ITE Imperial Corp.

979 ROCKER SWITCHES / *Decora* switches, receptacles and wall plates are offered in matching or contrasting colors and are UL-listed. All meet NEMA standard dimensions and have smooth rectangular faces. Switches are AC quiet type and CSA certified. / Leviton Mfg. Co.

980 FAULT PROTECTOR / UL-listing is now available on the company's ground fault sensing system which detects and interrupts ground faults before damage to equipment occurs. A selection of sensor sizes to match various bus configurations, four time delay settings and adjustable pick-up settings from 200 to 1200 amps are offered. / Square D Co.

981 FLUORESCENT DIMMER / Units meet UL standards for single gang wall box type dimmers. The line, according to the company, enables the user to have 1 to 30 matching models of incandescent and fluorescent lamps. Slide control gives immediate indication of light level. / Lutron Electronics Co., Inc.

982 LIGHTED SWITCH / Lighted toggle switches feature *Lexan* handles that are lighted by long-lasting neon, according to the company. The toggle switches have red, ivory, clear and green lighted handles. They can be wired back or side and are available in up to 30-amp ratings. / Harvey Hubbell Inc.

983 SURFACE WIRING / Covered in components shown) now includes a 4 by 4 by 1-in. unit which adheres to a wall and plugs into an existing single gang receptacle. There is also a 220-volt 20-amp transformer, a 277-volt 20-amp transformer (for fluorescent use) and an insulated version of the thin conductor wire which can be used underground for outdoor lighting. / Switchpack Systems, Inc.

984 SWITCHES, RECEPTACLES / A line of *CO/ALR* switches and receptacles has been introduced with restraints that lock the aluminum conductors firmly in place and prevent the wire from loosening, according to the company. Units meet UL requirements for use with aluminum, copper or copper clad wire and cable. / Slater Electric Inc.

985 SPLIT WALL PLATE / Stainless steel split-metal wall plates are said to conceal cables and multi-pin connectors behind the wall and eliminate surface-mounted boxes. Openings of $\frac{13}{32}$ or $\frac{5}{8}$ in. are available in 55 colors and finishes. / Sierra Electric.

986 RISER PANELS / With built-in safety barriers and fiber shield over tap lugs, this product is provided with two gutter heights. The gutter is 8 in. wide and up to 3 $\frac{3}{4}$ in. deep. Accommodates up to 24 circuits. Panels may be installed to the right or left of the gutter box. / Cutler-Hammer.



973



974

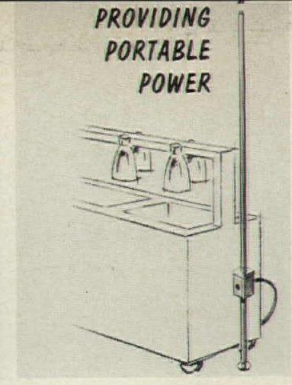

975

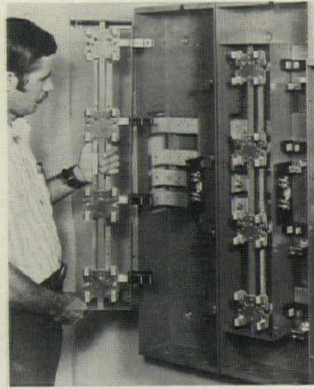

976

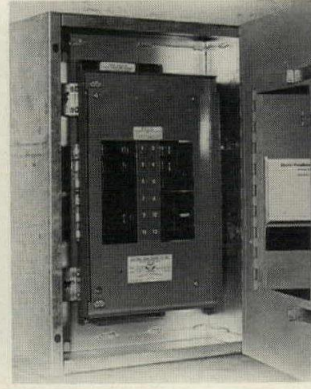

977

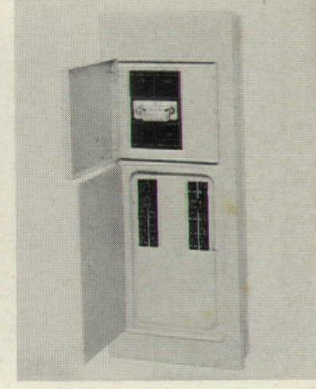

978

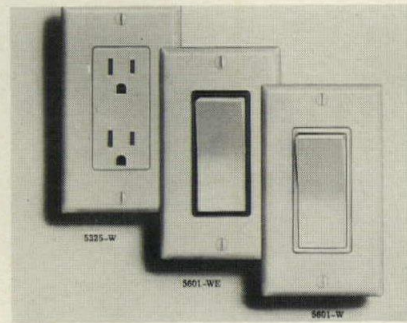

979

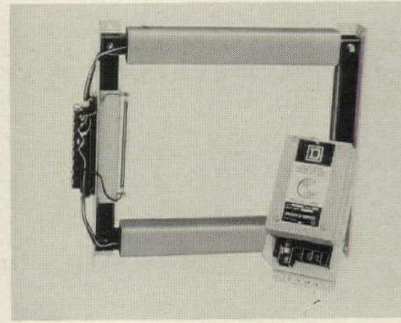

980

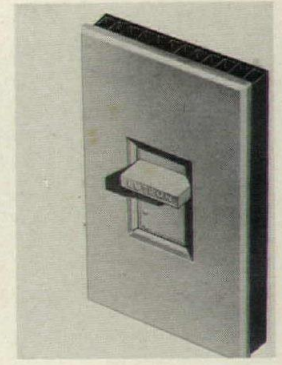

981

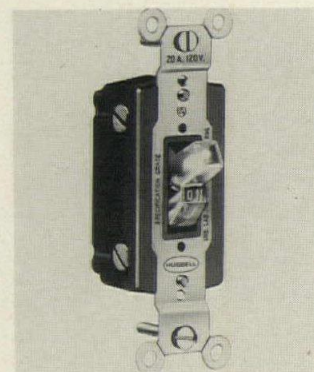

982

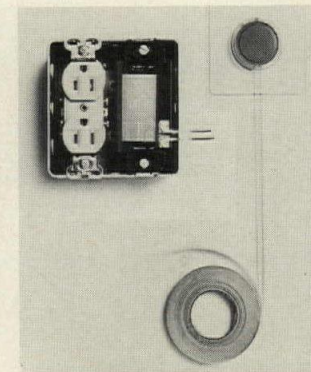

983

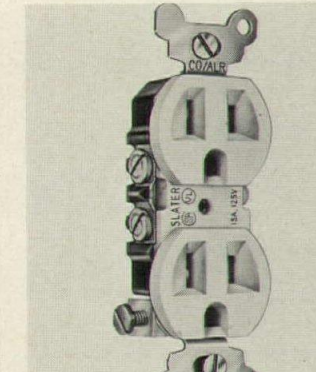

984



985

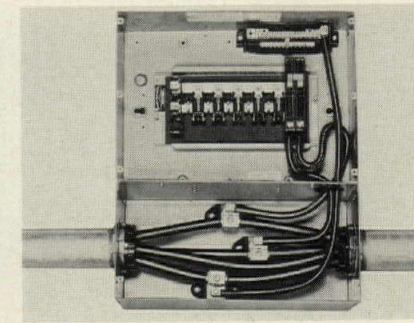

986



GE Duraglow Regressed provides lighting punch to enhance the appeal of merchandise.

Don't just turn on lights, turn on your customers.



Easy installation and maintenance with the plug-in ballast module. Ceiling appearance is enhanced by the regressed panel. Reduce glare and hot spots with the faceted reflector.

460-91

There's something exciting about a store illuminated with General Electric high intensity discharge (H.I.D.) lighting. There's a cheery feeling about the whole place. Merchandise takes on a sparkle that conventional lighting can't provide. The ceiling is more spacious, clean, and non-distracting. And the total effect just naturally lets shoppers see products more favorably. Explore this new and economical method of merchandising.

Hot spots, glare and garish streams of light are held to a minimum. You get uniform

*Trademark of the General Electric Co.

illumination that helps merchandise call attention to itself. You get optimum lumen efficiency. And you get to choose from a family of luminaires for all types of commercial lighting applications: regressed or recessed, open or enclosed, and for low or high mounting heights. The names are Panelglow*, Duraglow Regressed, Econoglow® Recessed, and Low-mount® Regressed. We call them The Show Offs, because that's what they do to your merchandise.

See your GE Representative or write for the complete story. GE Lighting Systems, Hendersonville, N.C. 28739.

The
show
offs

GENERAL  ELECTRIC

Yesterday.

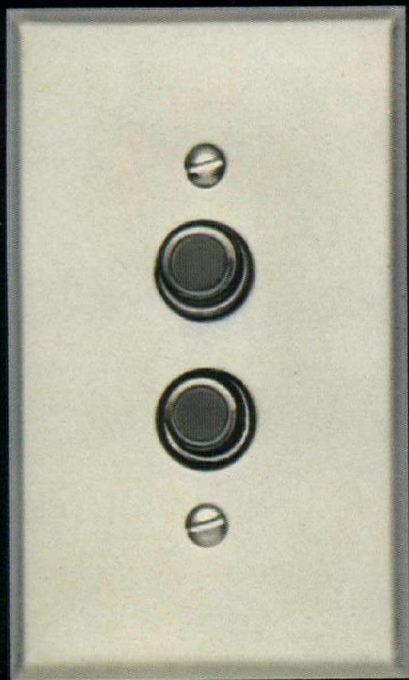

Today.

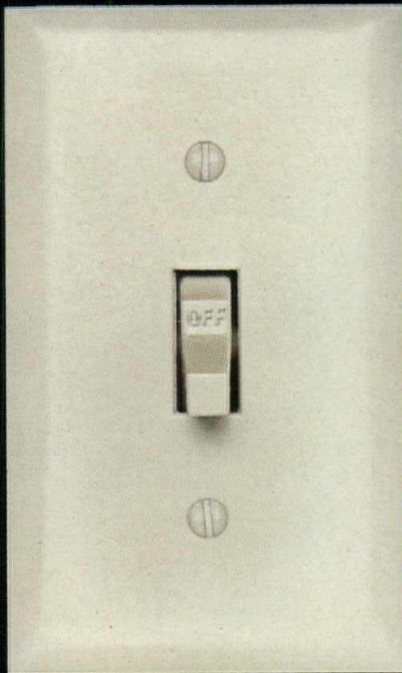

Today.

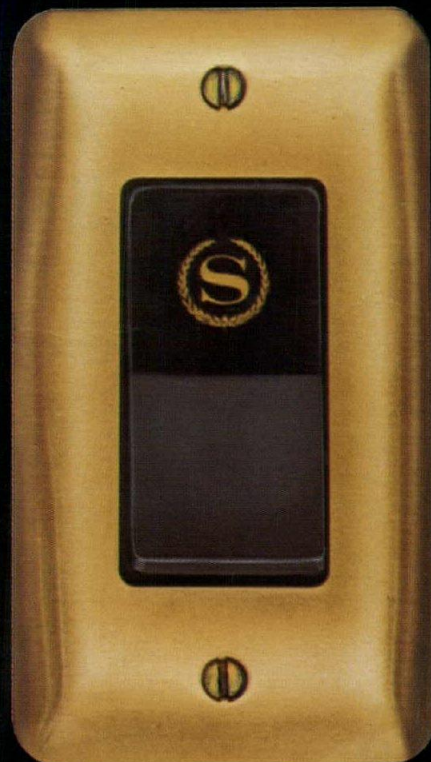

Tomorrow is today when you specify Slater switches, receptacles, and combination devices. We've long been known and respected for our technical excellence, as evidenced by the wide acceptance of our Medalist specification grade wiring devices. And when Medalist is combined with our new Decorator design, we get noticed for our looks, too.

Let's face it, the only part of the wiring installation that the customer sees is the devices installed on the wall. At Slater we are full of ideas to make your jobs look good so you look good.

For example, all our Decorator devices are modular designed to fit the same wall plates. The devices are available in eight colors, and you can select from a dozen different plate finishes to match or contrast so the devices can become decorative factors in room design.

To dress up a job even more, Slater can supply the touch switches with personalized embossing with a company logo, a hotel or motel name (such as the Sheraton Hotel switch shown), switch functions, or most anything else. Sixteen imprinted functions are available for immediate delivery, and we can produce custom designs as well.

Decorator face receptacles are available with the same features found in all of Slater's popular Medalist conventional duplex receptacles, such as the 5242, 5252, 5262, etc.

And naturally, all Slater wiring devices carry a lifetime replacement guarantee. The Medalist series has a call back labor guarantee.

 **Slater**
GLEN COVE, L.I., N.Y. 11542
HEAVY DUTY AND RESIDENTIAL GRADE
WIRING DEVICES

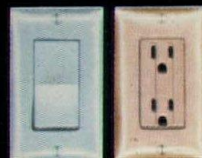

MANUFACTURERS' INDEX FOR PRODUCT REPORTS SECTION

Names and addresses of companies whose products appear in the Product Reports section. Index of advertisers is on page 195.

A	Page
AA Wire Products Co.	37
6100 S. New England Ave., Chicago, IL 60638	
A P C Corp.	107
44 Utter Ave., Hawthorne, NJ 07506	
Acco Chain Conveyor Div.	153
929 Connecticut Ave., Bridgeport, CT 06602	
Acorn Bldg. Components, Inc.	71
12620 Westwood, Detroit, MI 48223	
Acorn Marble Products Co.	37, 96, 108, 169
2077 Easy St., Walled Lake, MI 48088	
Adams Rite Mfg. Co.	71
1425 Grand Central, Glendale, CA 91201	
Adden, John	137, 142
10 Thatcher St., Boston, MA 02113	
Advanced Drainage Systems	29
1880 MacKenzie Dr., Columbus, OH 43220	
Air-Maze Div., Rockwell Intl.	161
2500 Miles Rd., Cleveland, OH 44128	
Air-Lec Industries, Inc.	71
3300 Commercial Ave., Madison, WI 53741	
Air-Tech Industries, Inc.	148
Clifton, NJ	
Alarm Lock Corp.	71
5411 Telegraph Rd., Los Angeles, CA 90022	
Alcoa	57
1501 Alcoa Bldg., Pittsburgh, PA 15219	
All-Steel Inc.	138, 139
Rt. 31 & Ashland Ave., Aurora, IL 60507	
Alliance Wall Corp.	56
P. O. Box 247, Alliance, OH 44601	
Allied Chemical Corp.	89
One Times Square, New York, NY 10036	
Amarlite/Anaconda	57, 69
4785 Fulton Industrial Blvd., SW, Atlanta, GA 30301	
American Air Filter Co., Inc.	170
P. O. Box 1100, Louisville, KY 40201	
American Coolair Corp.	165
3604 Mayflower St., Jacksonville, FL 32203	
American Device Mfg. Co.	109, 179
P. O. Box B, Steeleville, IL 62288	
American Dispenser Co., Inc.	111
325 Gotham Pkwy., Carlstadt, NJ 07072	
American Fireplace Co.	107, 108
Walled Lake, MI 48088	
American Laundry Machinery, Mc-Graw-Edison Co. Div.	121
5050 Section Ave., Cincinnati, OH 45212	
American Locker Co., Inc.	109
Jones & Gifford Ave., Jamestown, NY 14701	
American Louver Co.	184
7700 Austin, Skokie, IL 60076	
American Olean Tile Co.	95, 96
1000 Cannon Ave., Lansdale, PA 19446	
American Seating Co.	136, 138, 140
901 Broadway NW, Grand Rapids, MI 49504	
American Stabilis Inc.	181
400 Mason Rd., Fairport, NY 04240	
American Standard Inc.	164, 167
Box 2003, New Brunswick, NJ 08903	
American Sterilizer Co.	122, 123
2424 W. 23rd St., Erie, PA 16512	
American Zettler Corp.	180
697 Randolph Ave., Costa Mesa, CA 92626	
Ammark Corp.	166
12-22 River Rd., Fair Lawn, NJ 07410	
Amweld Bldg. Products	71
603 Plant St., Niles, OH 44446	
Andco Industries Corp.	109
Sellers Ave., P. O. Box 7366, Greensboro, NC 27407	
Andersen Corp.	70, 74
Bayport, MI 55003	
Apollo Metals, Inc.	43
6550 S. Oak Park Ave., Chicago, IL 60638	
Applicon, Inc.	21
154 Middlesex Trnpg., Burlington, MA 01803	
Aquatronics, Inc.	181
4th & Cumberland Sts., Philadelphia, PA 19133	
Architectural Graphics Inc.	109
#3 Koger Executive Center, Norfolk, VA 23502	
Architectural Pottery Div., Group Artec	134
2020 S. Robertson Blvd., Los Angeles, CA 90034	
Arcon Furniture Div., Group Artec	137, 141, 142
2020 S. Robertson Blvd., Los Angeles, CA 90034	
Arkia Industries Inc.	107, 162
400 E. Capitol, Little Rock, AR 72203	
Armstrong Cork Co.	91, 93, 148
Lancaster, PA 17602	
Art Metal Lighting	183, 186
Box 195, Vermilion, OH 44089	
Art Vivant, Inc.	133
173 Highridge Rd., New Rochelle, NY 10804	
Artifax Systems Ltd.	133
1429 Erie Blvd., Syracuse, NY 13210	

Atelier International, Ltd.	134, 136, 138, 139, 141, 186
139 E. 57th St., New York, NY 10022	
Athens Stove Works, Inc.	123
Athens, TN 37303	
Atlas Industries	73
3437 N. Halstead St., Chicago, IL 60657	
Atlas Minerals & Chemicals, Div. ESB Inc.	93, 95
Mertztown, PA 19539	
Atlas Roofing Div., Masonite Corp.	58
Box 5777, Meridian, MS 39301	
Atlas Sound	179
10 Pomeroy Rd., Parsippany, NJ 07054	
Automated Building Components, Inc.	58
7525 NW 37th Ave., Miami, FL 33147	
Autoquip Corp.	122
1140 S. Washtenaw, Chicago, IL 60612	
Avtec Industries, Inc.	188
5402 Janes Ave., Downers Grove, IL 60515	
Avtron Mfg., Inc.	187
10409 Meech Ave., Cleveland, OH 44105	
Axius Designs, Inc.	134
160 E. 56th St., New York, NY 10022	
Azrock Floor Products	93
500 Frost Bank Bldg., P. O. Box 531, San Antonio, TX 78292	
B	
BRK Electronics	179
525 Rathbone Ave., Aurora, IL 60538	
B/W Metals Co.	119
22 Donald Dr., Fairfield, OH 45014	
Bally Case & Cooler	73
Bally, PA 19503	
Bangkok Industries	96
1900-10 S. 20th St., Philadelphia, PA 19145	
Barber-Coleman	165
1300 Rock St., Rockford, IL 61101	
Barwick E. T. Mills	89
5025 New Peachtree Rd., Chamblee, GA 30341	
Beeco Products Co.	42
Industrial Park, Ft. Washington, PA 19034	
Bemis Mfg. Co.	167
300 Mill St., Sheboygan, WI 53085	
Berkey Colortran	185
1015 Chestnut St., Burbank, CA 91502	
Berkey Photo Inc.	22
2 Keystone Pl., Paramus, NJ 07652	
Bertin Industries, Inc.	161
Box 25, Limington, ME 04049	
Bethlehem Steel Corp.	42
701 E. Third St., Bethlehem, PA 18016	
Binkley Co.	56
331 Thornton Ave., St. Louis, MO 63119	
Blazer Corp.	164
400 Paterson Plank Rd., E. Rutherford, NJ 07073	
Bobrick Washroom Equipment Inc.	111, 170
11611 Hart St., N. Hollywood, CA 91605	
Bogen Div., Lear Siegler, Inc.	180
P. O. Box 500, Paramus, NJ 07652	
Bonsal, W. R. Co.	37
Lilesville, NC 28091	
Borg-Warner Plumbing Products	111, 167
201 E. Fifth St., Mansfield, OH 44902	
Bradley Corp.	167, 169
P. O. Box 348, Menomonee Falls, WI 53051	
Braun G. A. Inc.	121
461 Brighton Ave., Syracuse, NY 13205	
Brewster Corp.	133
50 River St., Old Saybrook, CT 06457	
Bridge-A-Back Inc.	139
150 E. Mound St., Suite 302, Columbus, OH 43215	
Briggs	168
5200 W. Kennedy Blvd., Tampa, FL 33622	
Broan Mfg. Co. Inc.	107
926 W. State St., Hartford, WI 53207	
Brooks-Scanlon, Inc.	51
P. O. Box 1111, Bend, OR 97701	
Brown Stove Works Inc.	123
Cleveland, TN 37311	
Bruce E. L. Co., Inc.	50, 93, 96
2185 Democrat Rd., Memphis, TN 38116	
Bruning	24
1834 Walden Sq., Schaumburg, IL 60172	
Bryant Air Conditioning Co.	162, 163, 164, 180, 181, 182
7310 W. Morris St., Indianapolis, IN 46231	
Bryant Electric Co.	188
1421 State St., Bridgeport, CT 06602	
Buckstaff Co.	136
1127 S. Main St., Oshkosh, WI 54901	
Buffalo Forge Co.	162, 163
Buffalo, NY 14240	
Builders Brass Works Corp.	71
3474 Union Pacific Ave., Los Angeles, CA 90023	
Bunting SteriSystems, Inc.	182
46 Beatrice St., Bridgeport, CT 06607	
Burlington House Carpets	90
240 Peachtree St., N. W. Atlanta, GA 30303	
Burns E. L. Co., Inc.	57
Box 9166, Shreveport, LA 71109	
Butler Mfg., Co.	148
P. O. Box 917, Kansas City, MO 64141	
C	
C-Thru Ruler Co.	23
6 Britton Dr., Bloomfield, CT	
C-E Morgan Div. Combustion Engineering Inc.	74
601 Oregon, Oshkosh, WI 54901	
Cabot, Samuel Inc.	91
1 Union St., Boston, MA 02108	

Cadillac Plastic & Chemical Co.	69
15841 Second, Box 810, Detroit, MI 48232	
California Redwood Assoc.	51
617 Montgomery St., San Francisco, CA 94111	
Cambridge Filter Corp.	162
7th N., Clay, NY 13201	
Carboline Co.	58
350 Hanely Indust. Ct., St. Louis, MO 63144	
Carpets International-Georgia	90
P. O. Box 1503, La Grange, GA 30240	
Carrier Air Conditioning Corp.	163, 164
Carrier Pkwy., Syracuse, NY 13201	
Carroll, J. W. & Sons, Div. U.S.I.	183
22600 S. Bonita St., Wilmington, CA 90744	
Carter-Hoffmann Corp.	120
1551 McCormick Ave., Mundelein, IL 60060	
Carter Ralph B., Co.	170
192 Atlantic St., Hackensack, NJ 07602	
Casaplanta	149
9489 Dayton Way, Beverly Hills, CA 90210	
Cast Iron Soil Pipe Foundation	166
Box 452, Los Angeles, CA 90028	
Castelli Furniture Inc.	134, 140
1251 Ave. of the Americas, New York, NY 10020	
Celotex	91
P. O. Box 22602, Tampa, FL 33622	
Cheney Flashing Co.	57
623 Prospect St., Trenton, NJ 08605	
Chicago Faucet Co.	167
2100 S. Nuclear Dr., Des Plaines, IL 60018	
Childers Mfg. Co.	56
3620 W. 11th St., Houston, TX 77008	
Chromalox Comfort Div., Emerson Electric Co.	161
8100 W. Florissant, St. Louis, MO 63136	
Clark Door Co.	73
69 Myrtle St., Cranford, NJ 07016	
Claridge Products & Equipment Inc.	107, 110
Box 910, Rt. 65, Harrison, AR 72601	
Closet Maid Corp.	111
720 SW 17th St., Ocala, FL 32670	
Cold Spring Granite Co.	37
Cold Spring, MN 56320	
Cole Div., Litton Industries	137
640 Whitford Rd., York, PA 17405	
Colonguard Corp.	29
One Johnson Dr., Raritan, NJ 08869	
Colt Industries	165
701 Lawton Ave., Beloit, WI 53511	
Commercial Carpet Corp.	90, 91
10 W. 33rd St., New York, NY 10001	
Conco Industries Inc.	121
30 Water St., W. Haven, CT 06516	
Consolidated Burris International	138
P. O. Box 735, Lincolnton, NC 28092	
Consolidated Int'l. Corp.	72
4501 S. Western Blvd., Chicago, IL 60609	
Construction Specialties, Inc.	43, 109
55 Winans Ave., Cranford, NJ 07016	
Contech Inc.	55, 58
7711 Computer Ave., Minneapolis, MN 55435	
Conwed Corp.	89, 91
2200 Highcrest Rd., St. Paul, MN 55113	
Copley Mfg. Co.	109
505 Albany St., Boston, MA 02118	
Copper Development Assoc., Inc.	56
405 Lexington Ave., New York, NY 10017	
Coricone Corp.	43
1098 S. Milwaukee Ave., Wheeling, IL 60090	
Cramer Industries Inc.	134, 135, 137
625 Adams St., Kansas City, KS	
Crane Co.	167
300 Park Ave., New York, NY 10022	
Crouse-Hinds Co.	183
Wolf St., Syracuse, NY 13201	
Crown Industries	133
1615 Croghan St., Fremont, OH 43420	
Cutler-Hammer	189
P. O. Box 463, Milwaukee, WI 53201	
D	
DAP Inc.	57
P. O. Box 277, Dayton, OH 45401	
D G Shelter Products	92
Box 25448, Portland, OR 97225	
Da-Lite Screen Co., Inc.	179
Rd. 15 N., Warsaw, IN 46580	
Day-Brite Lighting Div.	183, 184, 185
8100 W. Florissant Ave., St. Louis, MO	
Dayton Sure-Grip & Shore Co.	33
721 Richard St., Miamisburg, OH 45342	
De VAC, Inc.	72
10130 State Hwy. 55, Minneapolis, MN 55441	
De Jong, J. C. Co.	70
130-15 91st Ave., Richmond Hill, NY 11418	
Del Mar	134
7130 Fenwick Lane, Westminster, CA 92683	
Delta Faucet Co.	167
P. O. Box 31, Greensburg, IN 47240	
Delta-Therm, Inc.	180
22 W. Madison St., Chicago, IL 60602	
Denst Jack Design Inc.	96
7355 South Exchange Ave., Chicago, IL 60649	
Design-Technics	95
160 E. 56th St., New York, NY 10022	
Designcraft	141
Kero Rd., Carlstadt, NJ 07072	
Detection Systems Inc.	188
400 Mason Rd., Fairport, NY 14450	
Diazit Co., Inc.	24
Rt. U. S. 1, Youngsville, NC 27596	
Diebold, Inc.	22, 23, 117, 118, 119, 153
818 Mulberry Rd., S.E., Canton, OH 44711	

MANUFACTURERS' INDEX

Directional Contract Furn. 135
979 Third Ave., New York, NY 10022
Diston Ind., Inc. 72
3293 E. 11 Ave., Hialeah, FL 33013
Dor-O-Matic, Div. of Republic Industries
Inc. 69, 71
7350 W. Wilson Ave., Chicago, IL 60656
Doric Scientific Corp. 182
76 Convoys, San Diego, CA 92111
Dow Corning Corp. 57
Midland, MI 48640
Dresser Industries Canada Ltd. 37
10655 NE, Fourth St., Bellevue, WA 98004
Duke Mfg., Co. 121
P. O. Box 5426, St. Louis, MO 63160
Dunham-Bush, Inc. 163
175 S. St., Hartford, CT 06110
Duro-Test Corp. 187
Kennedy Blvd., N. Bergen, NJ 07047
Dusty Dustless, Inc. 163
1 Ecology Park, Baldwinsville, NY 13027
Dynamit Nobel of America, Inc. 55
Northvale, NJ 91873

E

Eaton Corp., Lock and Hardware Div. 70, 71
P. O. Box 25288, Charlotte, NC 28212
Edwards Engineering Corp. 166
101 Alecander Ave., Compton Plains, NJ 07444
Elec-Tro-tec, Inc. 109
71 Gordon St., Elk Grove Village, IL 60007
Electro-Air Div., Emerson Electric Co. 163
Oliva & Sproul Sts., McKees Rocks, PA 15136
Electric Panelboard Co., Inc. 188
10 Pixley Industrial Pkwy, Rochester, NJ 14624
Elkay Mfg. Co. 167, 168
2700 S. 17th Ave., Broadview, IL 60153
Ellis Industries 122
10917 E. Fawcett Ave., S. El Monte, CA 91733
Elco Industries 109, 183, 184
633 San Juan Ave., Stockton, CA 95204
Emeco Industries, Inc. 141
805 Elm Ave., Hanover, PA 17331
Emerson Electric Co. 180
141 Lanza Ave., Garfield, NJ 07026
Envel Design 148
1940 Cotner Ave., Los Angeles, CA 90025
Evans Products Co. 93
1121 S.W. Salmon St., Portland, OR 97208
Executone, Inc. 180
29-10 Thomson Ave., Long Island City, NY 11101
Exide Power Systems Div., EBS Inc. 187
Rising Sun & Adams Ave., Philadelphia, PA 19120

F

Falcon Safety Products Inc. 95
1137 Rt. 22, Mountaintside, NJ 07092
Feddres Corp. 169, 170
Edison, NJ 08817
Federal Sign & Signal Corp. 188
Shelby, OH 44875
Fiberglass Fabricators, Inc. 169
Box 20905, Phoenix, AZ 85036
Finestone Corp. 55, 93
11846 E. McNichols, Detroit, MI 48205
Fire Sprinkler Control Co. 166
Box 1143, 343 W. Foothill Blvd., Monrovia, CA 91016
Fixtures Mfg. Corp. 135
1645 Crystal, Kansas City, MO 64126
Flangeklamp Corp. 91, 148
1971 Abbott Rd., Buffalo, NY 14218
Flashguard Inc. 187, 188
927 Penn Ave., Pittsburgh, PA 15222
Florida Tile Div., Sikes Corp. 95
P. O. Box 447, Lakeland, FL 33802
Fluitron 169
715 Taylor St., Elyria, OH 44035
Formco Inc. 167
7745 School Rd., Cincinnati, OH 45242
Formel Inc. 74
1233 Burlington Ave., N.K.C., MO 64116
Forms & Surfaces 96, 134
Box 5215, Santa Barbara, CA 93108
Frigidaire 123
300 Taylor, Dayton, OH 45442

G

GF Business Equipment Inc. 134, 135, 138, 140
Youngstown, OH 44501
GTE Sylvania Inc. 187
Lighting Center, Danvers, MA 01923
G & W Auto Pak 124
P. O. Box 127, Red Lion, PA 17356
Gamewell 188
1238 Chestnut St., Newton, MA 02164
Gardco Mfg., Co. 183, 184, 186
2661 Alvarado St., San Leandro, CA 94577
Gardner Mfg., Co. 109
P. O. Box 147, Horicon, WI 53032
Gates & Sons Inc. 33
90 S. Fox, Denver, CO 80223
Gateway Bldg. Products 33
3233 W. Grand, Chicago, IL 60651
General Electric Co. 51
1350 S. 2nd St., Coshocton, OH 43812
General Electric Co. 165
Appliance Pk.-53, Louisville, KY 40225
General Electric Co. 184
1430 E. Fairchild St., Danville, IL 61832

General Electric Co. 183, 186
Nela Park, Cleveland, OH 44112
General Electric Co. 96, 186
1 Plastics Ave., Pittsfield, MA 01201
General Electric Co., Silicone Products 57
Waterford, NY 12188
General Tire & Rubber Co. 95
979 Third Ave., New York, NY 10022
Gerber Scientific Instrument Co. 21
83 Gerber Rd., S. Windsor, CT 06087
Gibson-Homans Co. 57
2366 Woodhill Rd., Cleveland, OH 44106
Glen-Gery Corp. 37
P. O. Box 206, Reading, PA 19607
Gold Bond Bldg. Products, Div. National
Gypsum Co. 91, 92
325 Delaware Ave., Buffalo, NY 14202
Grace, W. R. Co. 58
62 Whittemore Ave., Cambridge, MA 02140
Graphic Structures Div., Group Artec. 2020 S. Robertson Blvd., Los Angeles, CA 90034
Grefco, Inc. 55
2111 Enco Dr., Oakbrook, IL 60521
Grinnell Fire Protection Systems Co.,
Inc. 165
10 Dorrance St., Providence, RI 02901
Group Artec 29, 95
2020 S. Robertson Blvd., Los Angeles, CA 90034
Guth Lighting 183, 187
P. O. Box 7079, St. Louis, MO 63177

H

H-P Products, Inc. 119
512 W. Gorgas St., Louisville, OH 44641
Hager Hinge Co. 71
139 Victor St., St. Louis, MO 63104
Hallemite/Div., Sterling Drug 29
225 Summit Ave., Montvale, NJ 07645
Halo Lighting Div., McGraw Edison Co. 187
9301 W. Bryn Mawr Ave., Rosemont, IL 60018
Halsey Taylor Div. 110
1554 Thomas Rd., Warren, OH 44481
Hamilton Industries 22
Twin Rivers, WI 54241
Hamilton Safe Co. 118
P. O. Box 395, Fairfield, OH 45014
Harcraft 167, 169
19110 S. Western Ave., Torrance, CA 90509
Harloc Products Corp. 70
Campbell Ave., West Haven, CT 06516
Harris Mfg. Co. 96
Box 300, Johnson City, TN 37601
Harter Corp. 138, 141
Prairie Ave., Sturgis, MI 49091
Harvey Hubbell Inc. 183, 189
State St. & Bostwick Ave., Bridgeport, CT 06602
Haws Drinking Faucet Co. 167, 169
4th & Page Sts., Berkeley, CA 94707
Heat-Timer Corp. 181, 188
115 Fifth Ave., New York, NY 10003
Heatilator Div., Vega Industries 108
Box 409, Mt. Pleasant, IA 52641
Heil Co. 124
3000 W. Montana St., Milwaukee, WI 53201
Heinz, Jeffrey Mfg. Co., Inc. 124
23 N. Division St., Auburn, NY 13021
Helo Marketing, Inc. 149
27 Westerly Lane, New York, NY 10594
Hendrick Mfg. Co. 42
Dundaff St., Carbondale, PA 18407
Hercules Inc., Polymer Dept. 89
910 Market St., Wilmington, DE 19899
Heuga-tile Corp. 90
185 Sumner Ave., Kenilworth, NJ 07033
Hewlett-Packard Co. 22, 23
P. O. Box 301, Loveland, CO 80537
Hickman, W. P. Co. 57
2520 Industrial Row, Troy, MI 48084
Hobart Mfg., Co. 123, 124
World Headquarters, Troy, OH 45374
Holiday Pools Corp. 149
Bldg. 18, Spokane Industrial Park, Spokane, WA 99214
Hollaender Mfg. Co. 43
3841 Spring Grove Ave., Cincinnati, OH 45223
Honeywell Commercial Div. 161, 165, 181
2727 S. Fourth, Minneapolis, MN 55408
Holophane Co., Inc. 183
Montvale, NJ 07645
Hunt Electronics Co. 181
2639 Manana, Dallas, TX 75220
Huntington Laboratories, Inc. 111
P. O. Box 710, Huntington, IN 46750
Hurd Millwork Co. 74
520 S. Whelen Ave., WI 54451

I

IBM 21, 22
1133 Westchester Ave,
White Plains, N.Y. 10604
ICF Inc. 134, 135, 138, 141, 142
145 E. 57th St., New York, NY 10022
ITE Imperial Corp. 188
Springhouse, PA 19477
ITT Phillips Drill Co. 42
P. O. Box 364, Michigan City, IN 46360
ITT Reznor 163, 164
Mercer, PA 16137
Imperial Wallcoverings 96
3645 Warrensville Center Rd., Cleveland, OH 44122

In-Sink-Erator Div., Emerson Electric Co. 121
4700-21 St., Racine, WI 53406
Inclinor Co. Of America 153
2200 Paxton St., Harrisburg, PA 17105
Information Handling Service 22
Denver Tech. Center, Box 1154, Englewood CO 80110
Inland-Ryerson Construction Products Co. 73
P. O. Box 393, Milwaukee, WI 53201
Integrated Ceilings, Inc. 184
2231 Colby Ave., Los Angeles, CA 90064
Inter-Lake Industries Inc. 72
25460 Novi Rd., Novi, MI 48050
Interior Steel Equipment Co. 109
2352 E. 69th St., Cleveland, OH 44122
Interpace Corp. 95
2901 Los Feliz Blvd., Los Angeles, CA 90039
InterRoyal Corp. 122, 137
One Park Ave., New York, NY 10016
Intertherm, Inc. 181
3800 Park Ave., St. Louis, MO 63110
Iron-A-Way Co., Inc. 121
220 West Jackson St., Morton, IL 61550
Isothermics, Inc. 164
291 River Rd., Clifton, NJ 07014

J

JG Furniture Co., Inc. 137
121 Park Ave., Quakertown, PA 18951
J & J Industries Inc. 89
P. O. Box 966, Dalton, GA 30720
Jamison Door Co. 73
P. O. Box 70, Hagerstown, MD 21740
Jenn-Air Corp. 124
3035 Shadeland, Indianapolis, IN 46226
Jewett Refrigeration Co., Inc. 123
2 Letchworth St., Buffalo, NY 14213
Joerns Furniture Co. 122
600 Shaurette St., Stevens Point, WI 54481
Johns-Manville 37, 58, 90, 94, 161, 166
Box 5705X, Denver, CO 80217
Johnson, E. F. Co. 179
299 Tenth Ave. SW, Waseca, MN 56093
Johnson Rubber Co. 111, 188
16025 Johnson St., Middlefield, OH 44062
Jordan Commercial Refrigerator Co. 121
2200 Kennedy St., Philadelphia, PA 19137

K

KDI Paragon Inc. 149
12 Paulding St., Pleasantville, NY 10570
Kaiser Steel Corp. 57
9550 Clair Dr., El Monte, CA 91731
Kalwall Corp. 51, 93, 94
88 Pine St., Manchester, NH 03105
Karp Assoc. Inc. 73
54-54 4300 St., Maspeth, NY 11378
Kason Hardware Corp. 111
39-06 Crescent St., Long Island City, NY 11101
Katzenbach & Warren Inc. 133
155 E. 56th St., New York, NY 10022
Keene Corp., Sechrist Lighting Div. 187
4990 Acoma St., Denver, CO 80216
Keene Corp., Smithcraft Light Div. 183, 184
Industrial Way, Wilmington, MA 08540
Keene Corp., Porta-Fab Div. 149
2319 Grissom Dr., St. Louis, MO 63141
Keene Interior Systems 148
Rt. 1, Service Cntr., Princeton, NJ 08540
Kelsey-Hayes, Heintz Div. 169
Front St. & Olney Ave., Philadelphia, PA 19120
Kenco Products Corp. 120
153 S. Dean St., Englewood, NJ 07631
Kentile Floors Inc. 93
58 Second Ave., Brooklyn, NY 11215
Kim Lighting Inc. 183
16555 E. Gale Ave., City of Industry, CA 91749
Kinematics Ltd. 149
166 Broadway, Amityville, NY 11701
Kirsch Co. 142
Sturgis, MI 49091
Kittinger Co. 137
1893 Elmwood Ave., Buffalo, NY 14207
Knight, Stanley Corp. 121
1600 E. Birchwood Ave., Des Plaines, IL 60018
Kohler Co. 168, 169
Kohler, WI 53044
Kurtz Precast Corp. 37
930 Pointview Ave., Ephrata, PA 17522

L

LCN Closers 71
Princeton, IL 61356
Lake Shore Markers Inc. 51
654 W. 19th St., Erie, PA 16512
Larsen Products Corp. 33
5420 Randolph Rd., Rockville, MD 20852
Lee Mfg., Co. 73
313 Huntington, Jonesboro, AR 72401
Lefell James & Co. 170
426 E. St., Springfield, OH 45501
Lennox Industries Inc. 163
200 S. 12th Ave., Marshalltown, IA 50158
Lenwall Inc. 91
610 Mohawk Ct., Carmel, IN 46032
Leviton Mfg., Co. Inc. 189
59-25 Little Neck Pkwy, Little Neck, NY 11362
Lexalite Corp. 186
Charlevoix, MI

Lexusco 55
33095 Bainbridge, Solon, OH 44139
Lima Register Co. 161
1150 N. Cable Rd., Lima, OH 45802
Liquid Carbonic Corp. 121
135 S. LaSalle St., Chicago, IL 60603
Liskey Aluminum Inc. 107
P. O. Box 8748, Friendship Airport, Baltimore, MD 21240
Litecraft/Luminous Ceilings 91
P. O. Box 22601, Tampa, FL 33601
Lombardo Assoc., Inc. 69
411 E. John St., Lindenhurst, NY 11757
Louisiana-Pacific Corp. 124
324 Worcester Rd. N., Barberton, OH 44203
Lumen Design Co. 184
P. O. Box 5172, Beverly Hills, Ca 90210
Lutron Electronics Co. Inc. 189
Coopersburg, PA
Lyon Metal Products Inc. 109
Aurora, IL 60507

M

M-B Co. 153
1615 Wis Ave., New Holstein, WI 53061
MFG Concrete Forms 28
Ashtabula, OH 44004
Magic Chef 123
Cleveland, TN 37311
Maintenance, Inc. 94
1051 W. Liberty St. Ext., Wooster, OH 44691
Majestic Co. 109
345 Erie St., Hunting, IN 46750
Malm Fireplaces Inc. 107
368 Yolanda Ave., Santa Rosa, CA 95404
Maloney F. H. Co. 69
2301 Texas Ave., Houston, TX 77001
Malta Mfg. Co. 73
Box 397, Malta, OH 43758
Mann, Karl Assocs. 134
232 E 59th St., New York, NY 10022
Mansfield Sanitary, Inc. 166, 167, 169
150 First St., Perrysville, OH 44864
Marathon Carey-McCall Co. 142
2156 E. Dauphin St., Philadelphia, PA 19125
Marcy Gym Equipment Co. 117
1736 Standard Ave., Glendale, CA 91201
Margrill, Anita Inc. 28
151 W. 13th St., New York, NY 10011
Markel Electric Products, Inc. 180
601 Amherst St., Buffalo, NY 14207
Marlite, Div. of Masonite Corp. 51, 93
Dover, OH 44622
Marsten Products Co. 42
P.O. Box 9472, San Jose, CA 95157
Martin Stamping Stove & Co. 108
3414 Governor's Dr., Huntsville, AL 35807
Masland C. H. & Sons 90
Spring Road, Carlisle, PA 17103
Mason Industries Inc. 149
92-10 182nd Place, Hollis, NY 11423
Masonite Corp. 92, 93
29 N. Wacker Dr., Chicago, IL 60606
Mastic Corp. 51
131 S. Taylor St., South Bend, IN 46601
Matthews, Jas. H. 109
1315 W. Liberty Ave., Pittsburgh, PA 15226
Matthies & Hegeler 56
9th & Sterling St., LaSalle, IL 61301
Matrix Systems Ltd. 119
408 W. Grand, Chicago, IL 60610
Maxitrol Co. 165
2355 Telegraph, Southfield, MI 48075
Maxon Industries Inc. 124
1960 E. Slauson Ave., Huntington Park, CA 90255
Maytag Co. 121
403 W. 4th St. N., Newton, IA 50208
McDonnell Douglas Automation Co. 22
Box 516, St. Louis, MO 63116
McGraw Edison Co. 184
P. O. Box 1205, Racine, WI 53405
McGuire Co., W. B. 73, 122
P. O. Box 636, Hudson, NY 12534
McQuay Div., McQuay-Preflex Inc. 162
P.O. Box 1551, 13600 Industrial Park Blvd., Minneapolis, MN 55440
Meadows, W. R., Inc. 33
2 Kimball Street, Elgin, IL 60120
Metals Mfg. Co. 119
330 W. 1st South, Salt Lake City, UT 84101
Metalume Mfg. Co., Inc. 72
957 Rt. 37 W., Toms River, NJ 08753
Metcalfe Industries 165
P. O. Box 815, Palm Beach, FL 33480
Metropolitan Wire Goods Corp. 120
Wilkes-Barre, PA 18705
Micro Design Inc. 22
857 W. State St., Hartford, WI 53027
Miller Co. 187
99 Center St., Meriden, CT 06450
Miller, Herman Inc. 109, 110, 136, 137, 139, 141
Zeeland, MI 49644
Miller, Howard Clock Co. 134
Zeeland, MI
Miller-Picking Corp. 170
Box 130, Johnstown, PA 15907
Miracle Recreation Equipment Co. 149
P. O. Box 275, Grinnell, IA 50112
Mita Copystar America Inc. 24
17831 Sky Park Circle, #12D, Irvine, CA 92707
Mitchell Mfg. Co. 120
2740 S. 34th St., Milwaukee, WI 53246

Modern Maid Inc.120 E. 14th St. & Belt Rd., Chattanooga, TN 37401	Prestressed Concrete Institute33 20 N. Wacker Dr., Chicago, IL 60606	Sta-Rite Industries, Inc.170 293 S. Wright St., Delavan, WI 53115	Uniflow Mfg. Co.120 1525 E. Lake Rd., Erie, PA 16512
Modern Partitions, Inc.136 545 E. 32nd St., Holland, MI 49423	Preway Inc.108 1430 2nd St. N., Wis. Rapids, WI 54494	Stahl Industries Inc.148 Realty Bldg., Youngstown, OH 44503	United Molded Products Corp.51, 134 Yennickock Ave., Port Washington, NY 11050
Modernfold110 P. O. Box 310, New Castle, IN 47362	Prober, Harvey Showrooms Inc.136, 141 979 Third Ave., New York, NY 10022	Stair-Pak Products Co.51 Union, NJ 07083	United Sheet Metal Div.161 200 E. Broadway, Westerville, OH 43081
Monarch Carpet Mills89 5025 New Peachtree Rd., Chamblee, GA 30341	Progressive Designs, Inc.95 1024 Edison Ave., Jacksonville, FL 32204	Standard Conveyor153 2266 N. Second N. St. Paul, MN 55109	United States Steel Supply Div.28 13535 S. Torrance Ave., Chicago, IL 60633
Monroe Co., Inc.58 10795 Quebec Ave., Cleveland, OH	Proven Products Inc.123, 142 7560 SW Laview Dr., Portland, OR 97219	Standard Dry Wall Products, Inc.37, 58, 94 7800 N.W. 38th St., Miami, FL 33166	United States Stove Co.107, 162, 163 S. Pettsburg, TN
Monsanto Textile Co.89 1114 Ave. of the Americas, New York, NY 10036	R	Stanley Knight Corp.121 1600 E. Birchwood Ave., Des Plaines, IL 60018	Universal Housing Systems of America, Inc.149 360 E. 65th St., New York, NY 10021
Montgomery Data Systems, Inc.180 6815 Convoy Ct., San Diego, CA 92111	Rain Bird Sprinkler Mfg. Co.28, 29 7045 N. Grand Ave., Glendora, CA 91740	Star National Products165 1323 Holly Ave., Columbus, OH 43216	Universal-Rundle Corp.168 217 N. Mill St., New Castle, PA 16103
Montgomery Elevator Co.154 Moline, IL 61265	Ralide Inc.107 Box 131, Athens, TN 37303	Stauffer Chemical Co., Plastics Div.58, 133 216 Du Pont Ave., Newburgh, NY 12550	Utah-Amer. Corp., Amer. Dryer, Div.185 1124 E. Franklin St., Huntington, IN 46750
Mosler117, 118, 119 1561 Grand Blvd., Hamilton, OH 45012	Rally Enterprises Inc.123 P. O. Box 601, Mill Valley CA 94941	Stark Carpet Corp.137 979 Third Ave., New York, NY	V
Mosler Airmatic Systems Div.153, 154 415 Hamburg Turnpike, Wayne, NJ 07470	Randustrial Corp.57 1311 Union Ave., Cleveland, OH 44120	Steelcraft71, 72 9017 Blue Ash Rd., Cincinnati, OH 45242	VSI Fillex Div.124 9440 Gidley St., Temple City, CA 91780
Moxon Inc.180 2222 Michaelson Dr., Irvine, CA 92664	Rauland-Borg Corp.179, 180 3535 W. Addison St., Chicago, IL 60618	Steelcase Inc.134, 136, 138 Grand Rapids, MI 49501	Vaughan Walls, Inc.110 11681 San Vicente Blvd., Los Angeles, CA 90049
Mueller Climatrol Corp.162, 163, 170 2005 W. Oklahoma Ave., Milwaukee, WI 53215	Rawplug Co., Inc.33 200 Petersville Road, New Rochell, NY 10801	Stendig Inc.133, 138, 141 410 E. 62 St., New York, NY 10021	Vecta Contract Co.139, 140 740 W. Mockingbird Lane, Dallas, TX 75247
N	Ray Proof Div., Keene Corp.149 50 Keeler Ave., Norwalk, CT 06856	Stevens, J. P. & Co., Inc.89 1185 Ave. of the Americas, New York, NY	Verax Corp.23 8235 Santa Monica Blvd., Los Angeles, CA 90046
National Refractories Ltd.108 Port Robinson, Ont., Los IKO	Reflector Hardware Corp.119, 122 1400 N. 25th Ave., Melrose Park, IL 60160	Stockham Valves & Ftg's170 4000 10th Ave., N. Birmingham, AL 35212	Versatec Inc.23 10100 Budd Rd., Cupertino, CA 95014
Neenah Foundry Co.29 500 Winneconne Ave., Neenah, WI 54956	Reinforced Plastic Industries, Inc.29 7079 Peck Rd., Marlette, MI 48453	Stow/Davis133, 134 25 Summer Ave. NW, Grand Rapids, MI 49502	Verticals Inc.142 704 E. 133 St., Bronx, NY 10454
Nelson Stud Welding91 Toledo Ave. & E. 28th St., Lorain, OH 44055	Republic Steel Corp.33 P. O. Box 6778, 14410 GH Bldg., Cleveland, OH 44101	Stran-Steel Corp.149 P. O. Box 14205, Houston, TX 77021	Victor Mfg., Co.187 1020 Terminal Way, San Carlos, CA 94070
Neo-Ray Lighting Systems, Inc.183, 185 537 Johnson Ave., Brooklyn, NY 11237	Research Products Corp.161 1015 E. Washington Ave., Madison, WI 53701	Strauss, John International134, 135, 137 160 E. Erie St., Chicago, IL	Viking Sauna Co.149 909 Park Ave., San Jose, CA 95105
North American Door/Div. Celotex Corp.71 P. O. Box 510, Linderhurst, NY 11757	Reynolds Metals Co.42, 57 6601 W. Broad St., Richmond, VA 23261	Stresstek57 8000 Indian Head Hwy., Oxon Hill, MD 20022	Viking Universal Corp.108 P. O. Box 512, Pittsburg, CA 94565
North American Products Inc.94 1690 Grand Ave., St. Paul, MN 55105	Rixson-Firemark Inc.165 9100 W. Belmont Ave., Franklin Park, IL 60131	Structural Concepts Corp.110 P. O. Box 696, Grand Haven, MI 49417	Virginia Glass Products69 P. O. Box 5431, Martinsville, VA 24112
Notifier Co.188 P. O. Box 4584, Lincoln, NE 68504	Rodman Industries74 2525-4th Ave., Rock Island, IL 61201	Styro Materials Co.33 2519 Walnut St., Denver, CO 80205	Vista Lighting Co.123 5941 Clara St., Bell Gardens, CA 90201
Nucraft Furniture Co.134 1444 Michigan NE, Grand Rapids, MI 49503	Rohm and Haas Co.57, 69, 186 Independence Mall West, Philadelphia, PA 19105	Sun Control Products Corp.43 1000 Hialeah Dr., Hialeah, FL 33010	Vistron Corp.56 12333 S. VanNess Ave., Hawthorne, CA 90250
Nutone, Div. of Scovill111, 180 Madison & Red Bank Rd., Cincinnati, OH 45227	Roman Fountains Inc.28 Box 10190, Albuquerque, NM 87114	Sunar Ltd.137 915 King St., W., Toronto 150, Ont.	Vollrath Co.119 1236 N. 18th St., Sheboygan, WI 53081
O	Rus-tique Brik International37 P. O. Box 7603, Tulsa, OK 74105	Sunne Controls181 4771 SE 17 Ave., H. O. Box 02156, Portland, OR 97202	Von Duprin, Inc.70 400 W. Maryland St., Indianapolis, IN 46225
Onan Div., Onan Corp.182 1400-73rd Ave N. E., Minneapolis, MN 43654	Rusco Electronic Systems188 953 S. Raymond Ave., Pasadena, CA 91105	Switchpack Systems, Inc.189 P. O. Box 670, Del Mar, CA 92014	V'Soske, Inc.137, 138 155 E. 56th St., New York, NY 10022
Osmose29 980 Ellicott St., Buffalo, NY 14209	Russwin70 225 Episcopal Rd., Berlin, CT 06037	Sylvan Designs, Inc.184 21420 Valerio St., Canoga Park, CA 91303	Vulcan Metal Products, Inc.42 Box 6788, Birmingham, AL 35210
Otis Elevator Co.154 260 11th Ave., New York, NY 10001	S	Symms Industries Inc.168 31 Brook Dr., Braintree, MA 02184	W, X
Overly Mfg. Co.123 Greensburgh, PA 15601	Sanyo Electric Inc.179 1200 W. Artesia Blvd., Compton, CA 90220	Symons Corp.33 200 E. Touby Ave., Des Plaines, IL 60018	Wall & Floor Treatments, Inc.93 300 University Ridge, Greenville, SC 29601
Owens-Corning Fiberglas Corp.55, 166 Fiberglas Tower, Toledo, OH 43659	Schlage Lock Co.70 P. O. Box 3324, San Francisco, CA 94119	Systron-Donner Corp.188 6767 Dublin Blvd., Dublin, CA 94566	Wall Trends, Inc.96 979 Third Ave., New York, NY 10022
P	Scope Furniture, Inc.134, 135, 139, 142 407 W. 13 St., New York, NY 10028	T	Wang Laboratories Inc.21 836 N. St., Tewksbury, MA 01876
PPG Industries69 One Gateway Center, Pittsburgh, PA 15222	Scott Engineering Sciences119 1400 SW 8th St., Pompano Beach, FL 33060	T C I, Inc.140, 141 S. Rd., High Point, NC 27262	Worth Paint Co.58 1923 Ponce de Leon Blvd., Coral Gables, FL 33134
Pabco Paint Corp.91 Box 8502, Emeryville, CA 94608	Scott, Isabel Fabrics Corp.133, 142 979 Third Ave., New York, NY 10022	Tappan Appliance Group123 Tappen Park, Mansfield, OH 44901	Waste Combustion Corp.164, 165 P. O. Box 6295, Richmond, VA 23230
Panelfold110 10700 NW 36th Ave., Miami, FL 33167	Sears, Roebuck and Co.121, 162 Sears Tower, Chicago, IL 60684	Tech Sales Co.92 310 W. Fourth Ave., Portland, OR 97204	Waste King Universal124 3300 E. 50th St., Los Angeles, CA 90058
Parker, Charles Co.111 290 Pratt St., Meriden, CT 06450	Seco Mfg. Co.165 Box 378, Wauseon, OH 43567	Teledyne Big Beam184 290 E. Prairie St., Crystal Lake, IL 60014	Watson Mfg., Co. Inc.119 Jamestown, NY 14701
Pate Co.57 2625 S. 21st Ave., Broadview, IL 60153	Security Corp.109 2055 SE Main St., Irvine, CA 92705	Teledyne Post23 200 E. Northwest Hwy., Des Plaines, IL 60016	Watson-Bowman Associates Inc.42 1280 Niagara St., Buffalo, NY 14213
Pawling Rubber Corp.111 157 Maple Blvd., Pawling, NY 12564	Security Fire Door Co.153 3044 Lambdin Ave., St. Louis, MO 63115	Teledyne Rotolite24 328 Essex St., Stirling, NJ 07980	Webster Div./Andro Corp.169, 170 1402 S. 69th E. Ave., Tulsa, OK 74115
Peabody119 802 W. Fourth St., Manchester, IN 46962	Season-All Industries, Inc.73 Indiana, PA 15701	Telke Inc.70 Glen Riddle, PA 19037	Weil-McLain Hydronic Div.170 Blaine St., Michigan City, IN 46306
Peachtree Doors, Inc.71 Box 700, Norcross, GA 30071	Sedgwick Machine Works154 Box 630, Poughkeepsie, NY 12602	Temco Inc.108 4101 Charlotte Ave., Nashville, TN 37202	Weil Pump Co.169 1530 N. Fremont St., Chicago, IL 60622
Pella Rolscreen Co.74 100 Main, Pella, IA 50219	Seeman, James Studios, Inc.96 50 Rose Place, Garden City, NY 11040	Tenneco Chemicals89 640 W. 134th St., New York, NY 10031	Weiser Co.70 4100 Ardmore Ave., S. Gate, CA 90280
Pellerin Milnor Corp.121 P. O. Box 398, Kenner, LA 70062	Sel-Ply Products55 P. O. Box 2212, White City, OR 97501	Texas Instruments Inc.56 34 Forest St., Attleboro, MA 02703	Wenzel Tile Co.95 P. O. Box 5308, Trenton, NJ 08618
Pemko Mfg. Co.71 5755 Landregan St., Emeryville, CA 94607	Sentracon Corp.165, 188 80 Wilson Way, Westwood, MA 02090	Thomas Industries Inc.111, 187 207 Broadway, Louisville, KY 40202	Western Drinking Fountains167 Glen Riddle, PA 19307
Penco Products Inc.42, 111 Brower Ave., Oaks, PA 19456	Shakertown Corp.55 4416 Lee Road, Cleveland, OH 44128	Thonet Industries, Inc.135, 138, 139, 140, 141, 142 York, PA 17405	Westinghouse Electric Corp.154 21 Bleeker St., Milburn, NJ 07041
Philadelphia Carpet Co.90 Cartersville, GA 30120	Shaw-Walker136, 137 20 Division St., Muskegon, MI 49443	3 M Co.133 St. Paul, MN 55133	Westinghouse Electric Corp.185 P. O. Box 5817, Cleveland, OH 44101
Pierce Corp.22 6238 Oasis Ave., N. Stillwater, MN 55082	Sierra Electric189 P. O. Box 85, Gardena, CA 90247	ThyCurb Div., ThyBar Corp.42 913 S. Kay Ave., Addison, IL 60101	Westinghouse Home Systems Dept.149 Gateway No. 6, Pittsburgh, PA 15222
Pinecrest Inc.74 2710 Nicollet Ave., Minneapolis, MN 55408	Sika Chemical Corp.94 875 Valley Brook Ave., Lyndhurst, NJ 07071	TimberForm29 1727 NE 11th Ave., Portland, OR 97212	Whatley, W. J. Inc.187 4915 Niagra St., Commerce City, CO 80222
Pistol, A. W. Inc.187 8-10 Drake Ave., New Rochelle, NY 10805	Silbrico Corp.55 6300 River Rd., Hodgkins, IL 60525	Tork Time Controls, Inc.185 Mt. Vernon, NY 10551	Whirlpool Corp.123 Administrative Center, Benton Harbor, MI 49022
Pitney Bowes23, 24 Stamford, CT 06904	Simmons Co., Contract Div.137 1870 Merchandise Mart, Chicago, IL 60654	Toro Co., Irrigation Div.28 5825 Jasmine, Riverside, CA 92504	White Machine Co., Inc.153 50 Boright Ave., Kenilworth, NJ 07033
Plan File Co.22 8305 Hindry Ave., Los Angeles, CA 90045	Simpson Timber Co.50, 91, 95 2000 Washington Bldg., Seattle, WA 98101	Touch-Plate Inc.180 16530 Garfield Ave., Paramount, CA 90723	Whittlewood Corp.74 P. O. Box 26208, Albuquerque, NM 87125
Playground Corp. of America117 29-24 40th Ave., Long Island City, NY 11101	Slant/Fin Corp.165 100 Forrest Dr., Greenvale, NY 11548	Tremco Mfg. Co.58, 69 10701 Shaker Blvd., Cleveland, OH 44104	Wide-Lite Corp.183, 185 P. O. Box 191, Houston, TX 77001
Polacoat, Inc.124 9750 Conklin Rd., Cincinnati, OH 45242	Slater Electric Inc.189 45 Sea Cliff Ave., Glen Cove, NY 11542	Tyler Refrigeration Div.121 1329 Lake St., Niles, MI 49120	Willamette Industries, Inc.51 P. O. Box 428, Albany, OR 97321
Polarized Corp. of America186 8921 Quartz Ave., Northridge, CA 91324	Sloane R. & G. Mfg. Co., Inc.167 7606 Clybourn Ave., Sun Valley, CA 91352	U	Wilson, Ralph Plastics Co.92 600 General Bruce Dr., Temple City, TX 76501
Pratt & Lambert, Inc.91 P. O. Box 22, Buffalo, NY 14240	Smith Elwin G. Div., Cyclops Corp.56, 57, 73, 107 100 Walls St., Pittsburgh, PA 15202	U-Line Corp.120 8900 N. 55th St., Milwaukee, WI 53223	Witek Inc.22 Glover Ave., Norwalk CT 06850
Precision Metal Products, Inc.121 Box 248, Tamiami Station, Miami, FL 33144	Speakman Co.169 Wilmington, DE 19899	U. S. Ceramic Tile Co.95 1375 Raff Rd., SW, Canton, OH 44701	Wine Vault Inc.120 909 Park Ave., San Jose, CA 95150
Preso-Matic Lock Co., Inc.71 8228 W. 47th St., Lyons, IL 60534	Speed Queen, McGraw-Edison Div.121 Ripon, WI 54971	U. S. Elevator Corp.154 9233 Balboa Ave., San Diego, CA 92112	Wood, A. R. Mfg. Co.108 Box 218, Luverne, MN 56156
Prescolite184 1251 Doolittle Dr., San Leandro, CA 94577	Sperry Remington24 P. O. Box 1000, Blue Bell, PA 19422	U. S. Gypsum Co.33, 37, 42, 91 101 S. Wacker Drive, Chicago, IL 60606	Wood Design137 Beechwood Ave., French Lick, IN 47432
Prsray Corp.73 159 Maple Blvd., Pawling, NY 12564	Square D Co.189 Lexington, KY 40505	U. S. Plywood50, 55 777 Third Ave., New York, NY 10017	XIT Rod Co.188 P. O. Box 1314, Covina, CA 91722

INDEX TO ADVERTISING

AA Wire Products Co.	39	Marvin Electric Mfg. Co.	178
AllianceWall Corporation	68	Masonite Corporation	78-79, 101
All-Steel Equipment Inc.	145	Matthews & Co., J. H.	106
Aluminum Co. of America	46-47, 52	Matthiessen & Hegeler Zinc Co.	63
American Air Filter Co.	6	McDonald Products Corp.	143
American Olean Tile Company	4th cover	McGraw-Hill Books	114
Architectural Record	26, 36, 128, 144, 146, 156	Medusa Corp.	30
Architectural Record Books	20, 60, 64	Merry Companies, Inc.	36
Architectural Research Corp.	32	Miscellaneous Manufacturing	60
Architectural Review	38	Montgomery Elevator Co.	157
Armstrong Cork Co.	2nd cover-1	Mosler/Airmatic Systems Division	152
Automated Building Components, Inc.	10		
		Osmose Wood Preserving Co.	48
Bemis Mfg. Co.	104	Otis Elevator Co.	155
Briggs	172-173		
Bruning Division—Addressograph Multigraph Corporation	18	Pinecrest, Inc.	80
Buckstaff Company	144	PPG Industries, Inc.	86
Burns Company, Inc., E.L.	112	PPG Industries, Inc.—Coatings & Resins	88
		PPG Industries, Inc., Commercial Glass	75
Caradco Division of Scovill Mfg. Co.	76-77	Queens Products Division, King Seeley Thermos Co.	128
Celanese Coatings Co.	2		
Chicago Faucet Co.	160	Republic Steel Corp.	40
Combustion Engineering—C-E Glass Division	66	Rixson-Firemark, Inc.	82
Connor Forest Industry	127	Robertson Co., H. H.	44-45
		Rohm & Haas Company	81
DeSoto, Inc.	100	Shaw-Walker Co.	132
Diebold Inc.	150	Simpson Timber Co.	103
Doane Mfg. Co.	116	Slater Electric, Inc.	191
Dow Corning Corp.	62-63	Smith, Elwin G. Div. Cyclops Corp.	54
DuPont De Nemours & Co., Inc., E.I.	196-3rd cover	Speakman Company	175
Elkay Mfg. Company	171	Spencer Turbine Co.	129
Flintkote Co.	4	Sperry Remington, Office Machine Div.	25
Fruh, A. W. Company	83		
General Electric—Lighting Systems	190	Taylor Co., The Halsey W.	158
Glen-Gery Corp.	34	Thiokol Chemical Corp.	65
Guth Lighting—Div. Sola Basic Industries	176	Tremco Mfg. Co.	59
Hager Hinge Company	12	Uniform Construction Index	16
Harter Corporation	130	U. S. Plywood Corp.	61
Holophane Co., Inc.	98		
Jewett Refrigeration Co., Inc.	125	Vogel-Peterson Co.	113
Jute Carpet Backing Council, Inc.	97	Von Duprin Inc.	84-85
Karastan Rug Mills Div.—Fieldcrest Mills	99		

ARCHITECTURAL RECORD

McGraw-Hill, Inc, 1221 Avenue of the Americas,
New York, New York 10020
Advertising Sales Mgr.: Louis F. Kutscher
(212) 997-2838
Eastern Sales Mgr.: Robert G. Kleisch
(215) 568-6161
Western Sales Mgr.: James A. Anderson
(312) 751-3770
Advertising Services Mgr.: Joseph R. Wunk
(212) 997-2793
Marketing Services Mgr.: Elizabeth Hayman
(212) 997-2858
Research Mgr.: Camille Padula (212) 997-2814
Classified Advertising: (212) 997-2557

District Offices:

Atlanta 30309

Edward G. Graves
100 Colony Square, 1175 Peachtree St., N.E.
(404) 892-2868

Boston 02116

Robert L. Tagen
607 Boylston St., (617) 262-1160

Chicago 60611

Robert T. Franden, Edward R. Novak
645 N. Michigan Ave., (312) 751-3770

Cleveland 44113

Willis W. Ingersoll
55 Public Square, (216) 781-7000

Denver 80202

Harry B. Doyle
1700 Broadway, (303) 266-3863

Detroit 48202

Richard D. Thielmann
1400 Fisher Bldg., (313) 873-7410

Los Angeles 90010¹

Richard R. Butera
3200 Wilshire Blvd.—South Tower, (213) 487-1160

New York 10020

Ted Rzempoluch
(212) 997-3584

Philadelphia 19102

Robert G. Kliesch, George T. Broskey
Three Parkway, (215) 568-6161

Pittsburgh 15222

Edward C. Weil III
4 Gateway Center, (412) 391-1314

St. Louis 63011

Richard Grater
Manchester Rd., (314) 227-1600

San Francisco 94111

Richard R. Butera
425 Battery Street, (415) 362-4600

EXTRA COPIES ARE AVAILABLE

A limited number of extra copies of Product Reports 74 are available on a first come first-served basis at \$3.00 each (plus 50¢ postage and handling). Send your order to Mrs. Pauline Krane, P.O. Box 430, Hightstown, New Jersey 08520

“Our carpet of Antron® has

Parkway Hospital, North Miami Beach, Florida.

