

ARCHITECTURAL RECORD

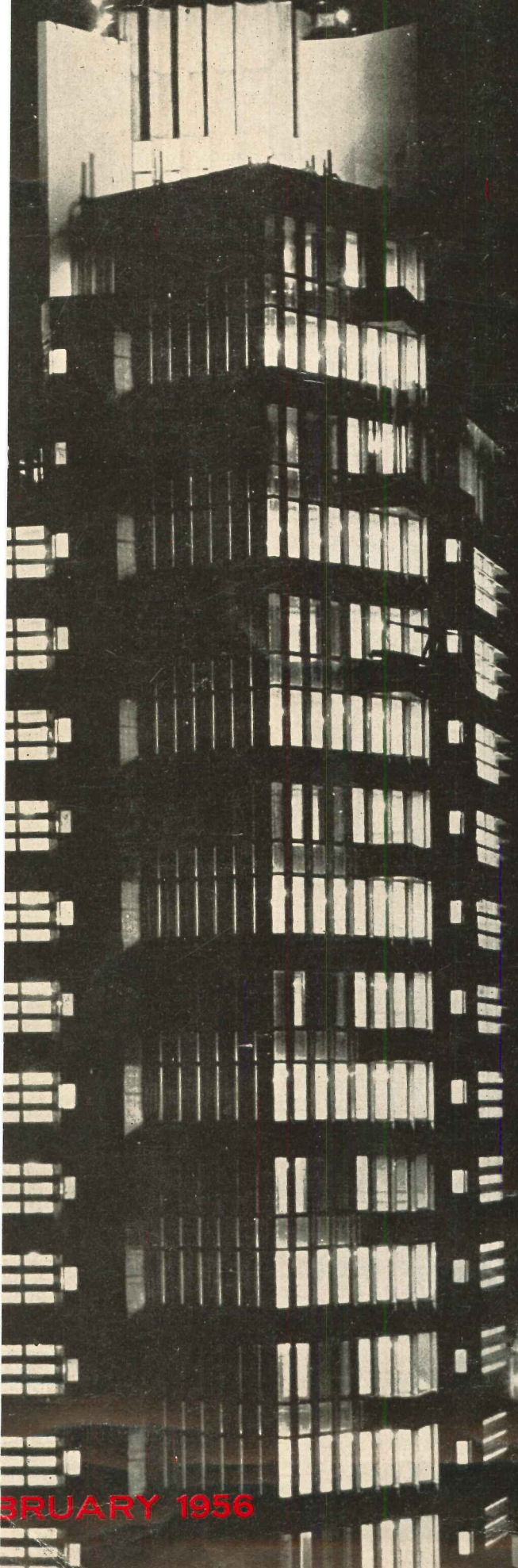

BUILDING TYPES STUDY

INDUSTRIAL
BUILDINGS

231

FEBRUARY 1956

Dramatic new
downtown store
depends on . . .

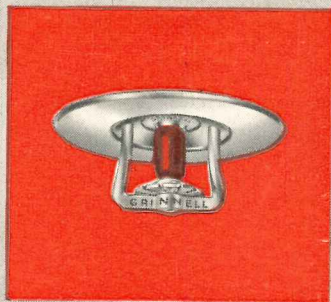

GRINNELL Ceiling-Type SPRINKLERS

When the management of Rich's, Inc. decided to construct its new department store "downtown" in Knoxville, it was a momentous decision—one taken in the face of a strong, continuing move to the suburbs. But experience has proved the wisdom of that action.

Of course, no small factor in the success of Rich's new store were such design innovations as a 450-car attached garage, outside pool and planting strip; and a built-in warehouse. The installation of Grinnell Sprinklers was still another move taken to create a relaxed atmosphere and to build customer confidence.

Grinnell Ceiling-Type Sprinklers are unobtrusive. They do nothing to mar the decor of modern interiors. And yet, should fire occur, they operate quickly, automatically to strike fire at its source, anywhere—anytime, night or day. Moreover, they make impressive insurance savings possible.

The time to plan Grinnell Protection is while your buildings are in the blueprint stage. For advice on the best system for you, invite a Grinnell Fire Protection engineer to call. Grinnell Company, Inc., 269 W. Exchange St., Providence, R. I.

◀ Rich's Department Store in downtown Knoxville. Long, corrugated canopy of concrete heightens the dramatic quality of brick and glass construction.



Modern lighting and automatic ceiling sprinklers give a clean, uncluttered appearance to various departments.

GRINNELL PROTECTION AGAINST EVERY FIRE HAZARD



Manufacturing, Engineering and Installation of Automatic Sprinklers Since 1878

ARCHITECTURAL RECORD (Vol. 119, No. 2, February, 1956) is published monthly by F. W. Dodge Corporation, 10 Ferry Street, Concord, N. H., with editorial and executive offices at 119 W. 40th St., New York 18, N. Y. \$5.50 per year; Foreign, \$20.00.

Entered as second-class matter at the Post Office, Concord, N. H., March 16, 1946, under the Act of March 3, 1879.

ARCHITECTURAL RECORD

February 1956 Vol. 119 No. 2

Copyright 1956 by F. W. Dodge Corporation, with all rights reserved. ARCHITECTURAL RECORD (combined with AMERICAN ARCHITECT and ARCHITECTURE) is published monthly by F. W. Dodge Corporation, 10 Ferry Street, Concord, New Hampshire, with editorial and executive offices at 119 West 40th Street, New York 18, New York. Western editorial office, 2877 Shasta Road, Berkeley 8, California.

STAFF OF ARCHITECTURAL RECORD

F.W.DODGE CORPORATION H. Judd Payne, *Publishing Director*; Robert F. Marshall, *General Manager*; John Knox Shear, A.I.A., *Editor-in-Chief*; Marshall T. Ginn, *Circulation Manager*. . . Emerson Goble, *Managing Editor*; Frank G. Lopez, A.I.A., *Senior Editor*; James S. Hornbeck, A.I.A., *Senior Associate Editor*; Elisabeth Kendall Thompson, *Senior Associate Editor and Western Section Editor (Berkeley, California, Office)*; Robert E. Fischer, *Associate Editor (Engineering)*; Florence A. van Wyck, *Associate Editor*; Jeanne M. Davern, *Associate Editor (News)*; Daniel M. Kelley, *Associate Editor (Engineering Assistant)*; Herbert L. Smith, Jr., *Associate Editor*; Ernest Mickel, *Dan Street (Washington)*, John Caulfield Smith, M.R.A.I.C. (Canada), *Contributing Editors*; Marjorie Blake, Grace M. Anderson, *Assistant Editors*; Helen E. Cook, *Editorial Assistant (Production)*; Ruth Watson Martin, Louise Sweeney, *Editorial Assistants*; Eugene H. Hawley, *Design Director*; Douglas R. Steinbauer, *Design*; Sigman-Ward, *Drafting Consultant*; Thomas S. Holden, *Industry Relations Consultant*; Clyde Shute, *Statistical Consultant*; George Cline Smith, *Economics Consultant*; Clifford Dunnells, Jr., *Field Research Consultant*; Samuel C. Pace, *Public Relations Consultant*.

TABLE OF CONTENTS

The Record Reports

Perspectives	9
Buildings in the News	10
Meetings and Miscellany	15
Views of Current Periodicals	24
A Washington Report: Construction and the State of the Union. <i>By Ernest Mickel</i>	26
News from Canada. <i>By John Caulfield Smith</i>	30
Washington Topics	44
Redevelopment Promotion: Zeckendorf in New York	48
Construction Cost Indexes	54
Required Reading	58
Reviewing the Record	306
Calendar and Office Notes	318
Current Trends in Construction	376

Wright's Skyscraper

The master asserts some favorite theories, especially the idea that the skyscraper belongs in the open spaces, not in the congested city.
The Price Tower, Bartlesville, Okla.; Frank Lloyd Wright, Architect 153

Contemporary Architecture of Finland

A selection of examples from the comprehensive exhibition — now on tour — covering postwar achievement 161
"Finland Builds." An article by Göran Schildt 163

Evolution of a House

An architect and his client review the planning and design of a summer residence
Dr. Alice McNiff house, Stockbridge, Mass.; John MacL. Johansen, Architect 169

Workshop for Exercises in Home Economics

Home Economics Building, University of California at Davis; Hervey Parke Clark, John F. Beuttler, Architects 177

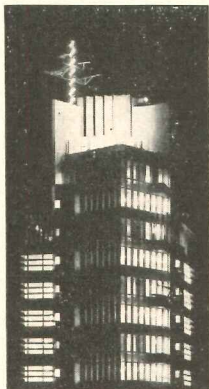

COVER: Price Tower, Bartlesville, Okla.; Frank Lloyd Wright, Architect; Joe E. Price, Photographer

Continued on next page

ARCHITECTURAL RECORD

Continued from page 5

Building Types Study Number 231 — Industrial Buildings: Factories — Warehouses

The popular word "automation" suggests the over-riding importance of materials handling in industrial buildings. In distribution buildings, or "warehouses," the science of handling goods also is affecting building concepts and designs. This study focusses directly on materials handling systems and their importance as design factors.

Introduction by <i>Emerson Coble</i>	181
Johnson & Johnson Take a Larger Look Manufacturing Center, North Brunswick, N. J.; Walter Kidde Constructors, Inc., Designers and Builders	182
Materials Handling and Industrial Architecture; by <i>Irving E. Ingraham</i> of Giffels & Vallet, Inc., L. Rossetti, Engineers and Architects	190
The Growing Science of Warehouse Design; by <i>William H. Meserole</i> , President Ballinger-Meserole Company Food Distribution Center for Penn Fruit Co., Inc., Philadelphia, Pa.; The Ballinger Co., Architects and Engineers	194
Modern Warehouse for Food Distribution Abner A. Wolf, Inc. Warehouse, Detroit, Mich.; Louis G. Redstone, Architect	199
Offices and Warehouse for Michigan State Liquor Commission, Detroit, Mich.; Louis G. Redstone and Otis Winn Associates, Architects	202
Sales and Warehouse building for Central Electric Supply Company, Denver, Colo.; Stanley E. and Jared B. Morse, Architects	206

Prefabs or Proprietary Plans for Schools?

I. "Prefabricated Schools in Britain", by <i>Antony Part</i>	
II. Prefabricated and Proprietary Concepts for American Schools	209

Architectural Engineering

Water Conditioning. An article by <i>Warren D. Calhoun and J. William Moffett</i>	220
Roundup	226
Product Reports	227
Office Literature	228
Time-Saver Standards — Thermal Insulation — 14: Floors; 15: Concrete Floor Slabs; 16: U Factors for Glass and Wood Doors; by <i>Laurence Shuman</i> , Consulting Engineer	231

Index to Advertising

378

OFFICERS OF THE F. W. DODGE CORPORATION

James McV. Breed, *Chairman of the Board*; Paul Abbott and Thomas S. Holden: *Vice Chairmen of the Board*; Howard Barringer, *President*; Irving W. Hadsell, Chauncey L. Williams: *Executive Vice Presidents*; Howard M. Thompson, *Vice President and Treasurer*; Julius T. Little, Robert F. Marshall, T. Oliver Morgan, O. O. Paulsell, H. Judd Payne, George Cline Smith: *Vice Presidents*; Carl S. Bennett, Clinton C. Bennett, Ralph M. Hairston, Roy J. Hard, Richard H. Ray, John M. Williams: *Regional Vice Presidents*; Edwin H. Freed, *Assistant Vice President and Comptroller*; Walter F. DeSaix, Clifford C. Dunnells, Jr., Clyde Shute, Marc Wayne: *Assistant Vice President*; Sanford D. Stockton, Jr., *Secretary*; William C. Breed, Jr., George W. Morgan, Jr.: *Assistant Secretaries*; Irving B. Satin, *Assistant Treasurer*.

OTHER F. W. DODGE SERVICES

Dodge Reports — Dodge Statistical Research Services — Sweet's Catalog Services — Dodge Books — Dodge Mailing Service — Chicago Construction News — Daily Pacific Builder — Denver Daily Journal — Real Estate Record & Builders' Guide.

Member of Audit Bureau of Circulations and Associated Business Publications. Architectural Record is indexed in Art Index, Industrial Arts Index and Engineering Index.

Every effort will be made to return material submitted for possible publication (if accompanied by stamped, addressed envelope), but the editors and the corporation will not be responsible for loss or damage.

Subscription rates in U. S., U. S. Possessions, and Canada: \$5.50 for one year, \$9.00 for two years, \$11.00 for three years. Elsewhere, subscriptions from those who by title are architects or engineers, \$6.50 for one year, \$11.50 for two years, \$15.00 for three years; subscriptions from all others outside U. S., U. S. Possessions and Canada, \$20.00 a year. Single copy price, \$2.00. Circulation Manager: Marshall T. Ginn. Change of Address: Subscribers are requested to furnish both old and new addresses, sending if possible the stencil impression from magazine wrapper. Allow four weeks for change.



THE RECORD REPORTS

P E R S P E C T I V E S

TWO CARS FOR EVERY GARAGE is not a slogan but a prospect to conjure with these days, and Universal C.I.T. Credit Corporation, the nation's largest independent automobile financing firm, says the building industry should consider the two-car garage or carport the standard for any new rural or suburban home. The company's expectation is that nearly 7,500,000 American families will be in the "multiple-car class" by 1960; it says the growth in the number of "prime prospects" for a second car is "one of the brightest expectations in the future automobile market." In 1955, 4,500,000 families had more than one car, compared with 1,100,000 in 1948.

GENERAL MOTORS GETS THE POINT: "I see no reason," said GM Vice President Roger M. Kyes recently, "why we should not have two-refrigerator families as well as two-car families." Mr. Kyes, who felt that about 10 million two-refrigerator families would not be an unrealistic goal, expected some of the impetus toward it to come from "dynamic obsolescence," a state he explained is achieved by bringing out new and improved models every year, as the automobile industry does, and thus persuading the customer that "he is better off investing in the new product, compared to keeping his money in the savings bank and struggling along with the old." Mr. Kyes, who said the appliance industry over the next decade or so could become as important a factor in the economy as the automobile industry, also predicted that 60 per cent of American homes will be air conditioned by 1965 (today's figure for central home air conditioning systems is about one per cent) and foresaw "tremendous things on the horizon" through advances in electronics, atomic energy and other fields of technology: "We have hardly begun to explore the possibilities for making the American home truly a good place to live in."

TWO BATHTUBS FOR EVERY HOME: That most famous son of Paris, Ill., William Zeckendorf, met his match last month in an earnest gentleman who spoke up from the audience at New York's Cooper Union, where Mr. Zeckendorf had given the second in a current series of lectures on "How to Build a Better-Looking New York." Mr. Zeckendorf's comments were, not unnaturally, devoted to the latest (and of course the biggest) project of his firm of Webb & Knapp to improve New York — the proposed \$500 million, 40-acre West Side Redevelopment Project (see page 48). In the question period that followed, he was his usual genial, imperturbable self with all of the heterogeneous questioners who turn up for Cooper Union's free lectures — until there came the boobytrap. "Mr. Zeckendorf," said the earnest gentlemen, "a lot of people don't even have a bathtub. Do you think it's right to spend all this money on a project like this when some people still don't have bathtubs?" The audience laughed, and Mr. Zeckendorf smiled, faintly and — it first appeared — imperturbably, but all he said was, "You can use one of my bathtubs."

AND SWIMMING POOLS BOOM: a record total of \$325 million will be spent for new pool construction and equipment in 1956, according to the annual market study of the trade publication *Swimming Pool Age*. "New construction in 1956 alone will more than triple the total number of pools existing in the U. S. up through the end of 1945," according to the publication, which reports its survey revealed only 8000 pools had been built in this country by the end of World War II. In 1955, the previous record year for swimming pools, approximately 20,000 pools were built at a cost of \$220 million. Main factor underlying the boom, says *Swimming Pool Age*, has been lower cost, reflecting keener competition, new building methods and new types

of pools. Most common material for permanent installations is concrete, followed by steel, plastic and aluminum. Of 56,000 existing pools, residential pools comprise 35,000 of the total, with approximately 8800 in "Y's", schools, hotels and motels; 7400 municipally owned; 3600 private club pools; and 1200 commercial pools. Of the 20,000 pools built in 1955, 80 per cent were paid for in cash, but *Swimming Pool Age* notes that the "potential that can be opened up by installment financing is tremendous"!

ALSO AVAILABLE: dinosaur footprints on slabs of stone quarried from the South Hadley, Mass., premises of the C. S. Nash Dinosaur Foot-Print Co., sometimes (as on the company's letter-head) known as "Dinosaurland." A company leaflet called "Petrified Footprints for Moderns" suggests varied applications: "Add these fascinating and humorous conversational pieces to your fireplace, terrace, garden walk, bird bath, or use for novel book ends, ash trays, paper weights, door stops." How it began: "Carleton Nash, a young geologist, discovered a stony ledge in South Hadley, Massachusetts, which contained 'some imprints' left by the ponderous pre-historic dinosaurs that dominated life on this planet during this early geological period. After completing studies in geology at Amherst college, and several misfortunes, he purchased the area containing his secret find." And now, the company's stationery proclaims it "Furnishers of Tracks" to a list of customers that ranges from Lowell Thomas and Gene Autry to the Northwest Mounted Police (Saskatchewan, Canada) and the Notre Dame Band. Says the dinosaur, to quote "Petrified Footprints" once more: "Come with me; this may be our final visit, for with our going now we may not come again. We have left our foot-prints indelibly on the 'Sands of Time'."

THE RECORD REPORTS

BUILDINGS IN THE NEWS

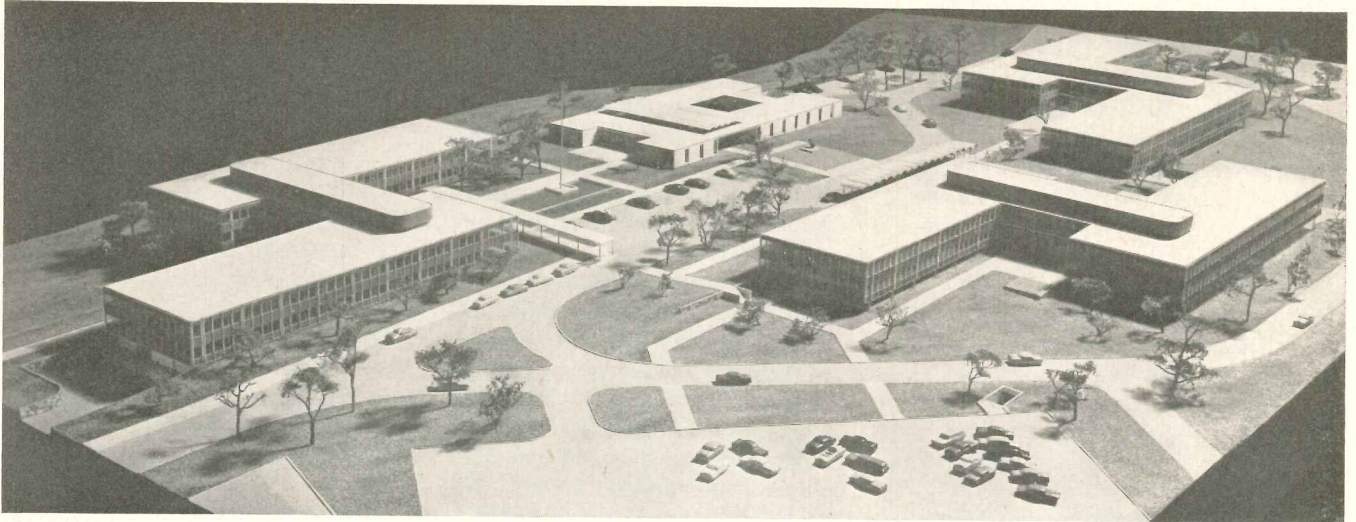

VINCENT KLING DESIGNS AN OFFICE CAMPUS FOR MONSANTO

The new general headquarters of the Monsanto Chemical Company will be built on a 252-acre site in Creve Coeur, St. Louis County, Mo. Monsanto explains that this should not be regarded as a move *away* from St. Louis, but rather as an expansion of its activities in the St. Louis area; expansion programs will continue at the two large manufacturing plants Monsanto operates in the City of St. Louis itself.

The headquarters development at Creve Coeur (model photo above, site plan below) will be comprised of three general office buildings, an executive building (one-story building in photo) and a utility building (not shown); Vincent G. Kling of Philadelphia is the architect. Also on the Creve Coeur site, Monsanto will build a laboratory for its Inorganic Chemicals Division which it is promised will incorporate the largest application of plastic building materials ever used in a single project; Holabird & Root & Burgee of Chicago are the architects.

In the headquarters scheme, the desire was to avoid high-rise buildings and to provide parking for employees reasonably close to their work destinations, also to take full advantage of the country setting. So there will be a group of buildings around a garden center, with

peripheral parking areas, also landscaped. Interlocking tunnels beneath the campus will take care of personnel circulation in bad weather; they will also serve for distribution of supplies and to house utilities lines.

The shape of the buildings was determined by Monsanto's wish to avoid the "bullpen" kind of office area without sacrificing efficient use of space. The bar of the H is both a receiving center, with employees' and visitors' entrances on opposite sides, and a service core, containing stairs, elevators, toilets, etc.

The mechanical penthouses atop the three main buildings have been designed with an effort to give some visual ele-

gance to structures bound to be so prominent on low buildings; their positions relate them to those building areas having the heaviest mechanical runs, and they will be lifted two ft above the roof level so air can be admitted from beneath them, thus eliminating the need for exposing unsightly equipment.

Construction will be a cellular steel structure, with Monsanto plastics used, in the architect's words, "for all prudent applications." According to present plans, there will be a good many of these, including exterior finishes, flooring, wall covering, partitioning, acoustic treatment, paint and some piping.

Exteriors will combine panels composed of double sheets of glass separated by a gray-green plastic laminate, for sun, glare and heat control, and green-blue glass-on-steel panels (fused high-temperature glazing on steel), with base and retaining walls of Missouri stone of an earthy Indian-red color.

The executive building will be a plastic-coated concrete structure with a shell roof over its major fixed space (containing lobby and board room).

Cost of the headquarters project is estimated at \$7.5 million. Approximately 300,000 sq ft of floor space will be provided. Occupancy is set for late 1957.

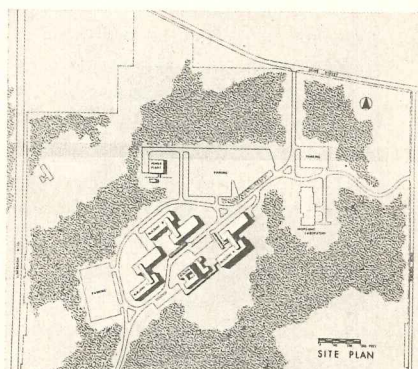

EIGHT BUILDINGS GIVEN 1955 GULF STATES A. I. A. AWARDS

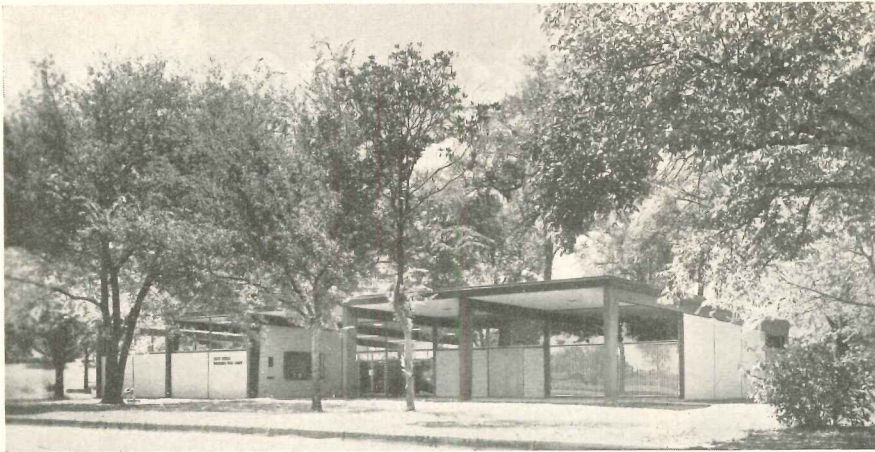

FIRST HONOR AWARD went to Ensey Branch, Birmingham, Ala., Public Library; Shaw & Renneker, architects.

The building, which cost \$84,413 including shelving and furniture, is 100 ft by 60 ft, has assembly room for community use,

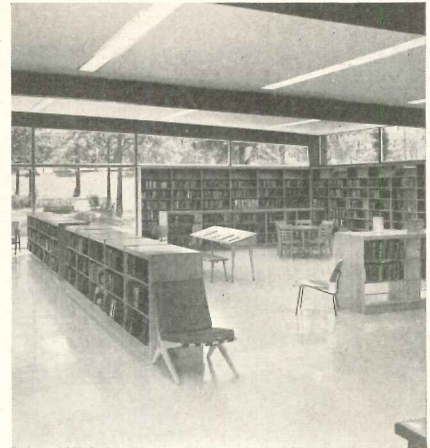

shelf space for 17,500 books, newspaper and magazine section, work room; it is air conditioned. Exteriors: brick and glass

FIRST MERIT AWARD was given for the Richardson residence, Harahan, La.; Curtis and Davis, architects-engineers, Waller J. Rooney Jr., associate in charge

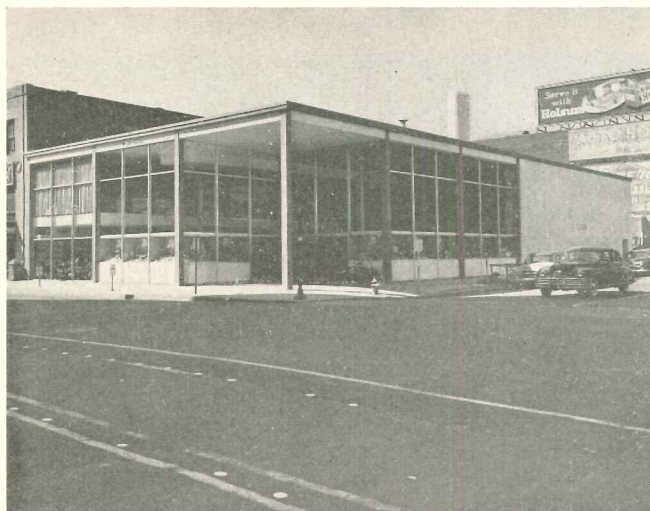
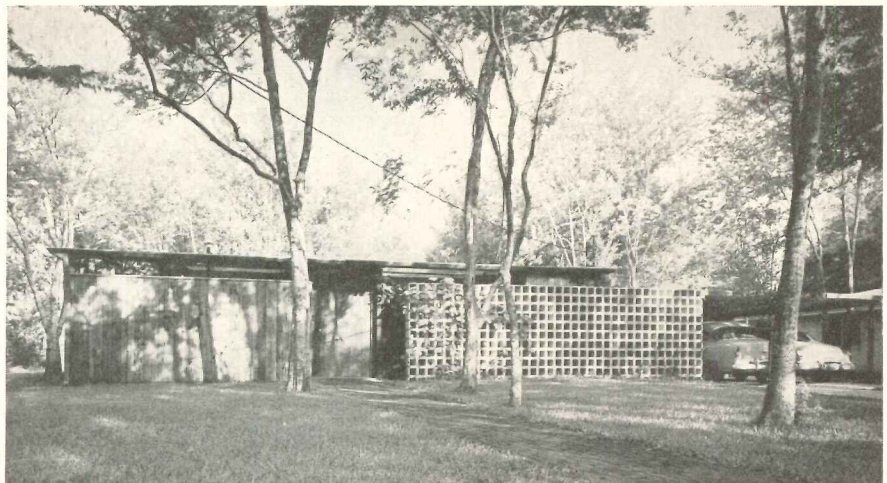

MERIT AWARD — the only store to receive one was (above) Riders Jewelry Store, Baton Rouge, La.; A. Hays Town, architect



MERIT AWARD — Li Rocchi Building, Baton Rouge; Short & Murrell, architects. Rental offices for two tenants; cost \$20,000

(Continued on page 12)

THE RECORD REPORTS
BUILDINGS IN THE NEWS

(Continued from page 11)

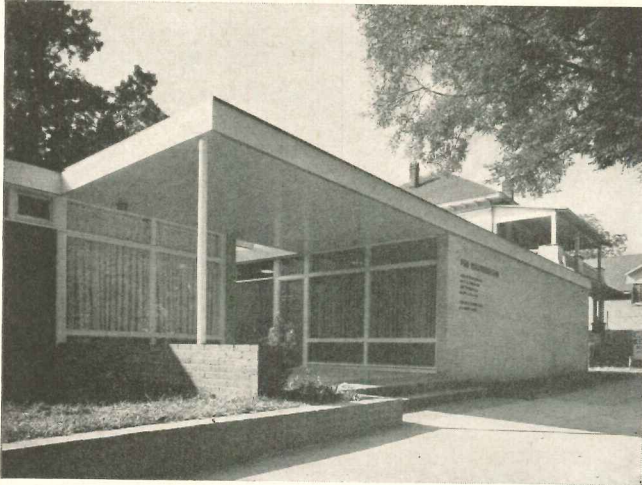

MERIT AWARD — Medical Office Building, Montgomery Ala.; Donald L. Horton & Albert L. Williams Jr., architects

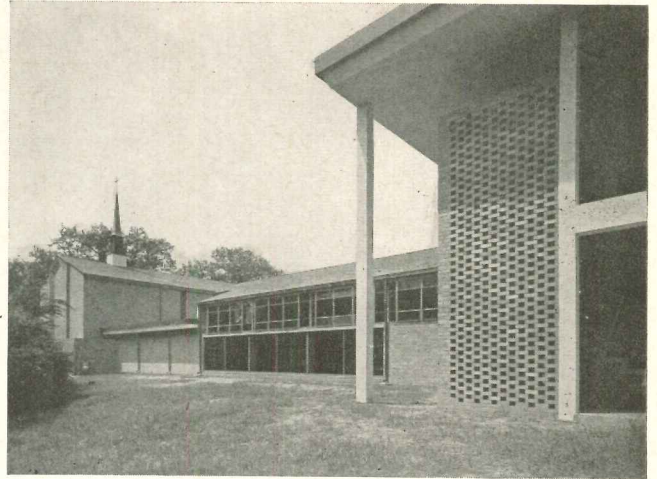

MERIT AWARD — First Presbyterian Church, Arkadelphia, Ark.; Ginocchio, Cromwell and Associates, architects

MERIT AWARD — St. Bernard Methodist Church, New Orleans; Dinwiddie, Lawrence and Saunders, architects. Chapel and social hall (right) are first phase of complete program for church in new neighborhood. Cost: \$31,889

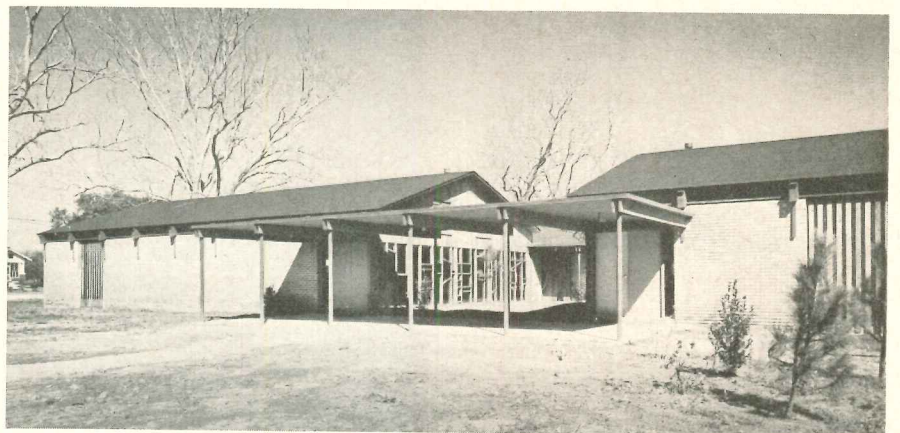

MERIT AWARD — St. James Parish Hospital, Luther, La.; Curtis and Davis, architects-engineers

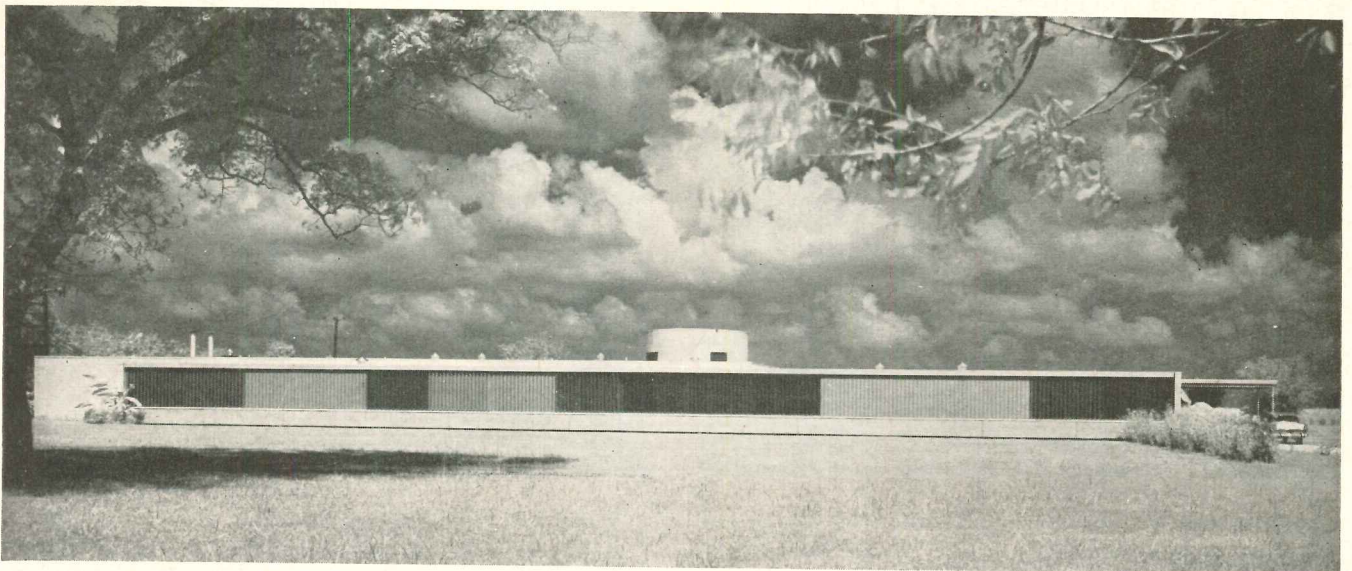

The State of Construction

More new records — latest figures from F. W. Dodge (see page 376) set new dollar highs for the month and for the year 1955, thus winding up the tenth successive year of new record volumes. Not only the total for the month but the nonresidential and heavy engineering categories set new records; residential contracts, off seven per cent for the month, reached the second highest December total on record. . . . On the subject of residential construction, Dodge economist Dr. George Cline Smith, addressing the convention of the National Association of Home Builders in Chicago last month, noted that contract awards for construction of single-family homes in the 37 eastern states have almost exactly doubled in the past four years. Doctor Smith pointed out that total figures on housing starts or valuation tend to obscure the rapid growth in single-family homes, because of an off-setting decline in multi-family buildings. He pointed out that the \$8.5 billion total of contract awards for single-family houses reported by Dodge in 1955 represented a gain of 21 per cent over the previous record set in 1954 and an increase of 97 per cent since 1951, whereas the increase for total residential building from 1951 to 1955 is only 64 per cent. Doctor Smith thought the "absolute minimum" figure for hous-

ing starts in the next ten years would be 12 or 13 million; he said that, even though the number of 1956 nonfarm housing starts is expected by Dodge to drop about 10 per cent from 1955, the dollar volume should be supported at a high level by the trend toward "larger and more expensive homes."

Los Angeles, May 15-18

The Southern California Chapter of the American Institute of Architects plays host to the Institute's 88th annual convention at the Hotel Biltmore in Los Angeles May 15-18; and the host chapter committee headed by Charles O. Matcham is by now bursting with plans to exploit this role to the greater glory of its proud locale and the greater pleasure of convention visitors. From Washington, A.I.A. convention manager Arthur B. Holmes reports preliminary plans for the 88th are well under way. This year's convention special train will be assembled at Chicago for a highly scenic trip to Los Angeles via Grand Canyon. There will also be a convention special returning to Chicago; but the major post-convention tours will go to Hawaii and Japan. "Architecture for the Good Life" is the convention theme; it will provide the general framework for the major addresses and the seminars. Members of the host chapter committee, besides Mr. Matcham: *guidebook* — Douglas Hon-

nold; *publications and program* — William Schinderman; *tours* — Cornelius M. Deasy; *budget and finance* — Herbert Powell; *reception and hospitality* — Samuel E. Lundin; *exhibits* — George E. Russell; *public relations* — Ulysses Floyd Ribble; *cultural events* — John Rex; *Western gala show* — Charles Luckman; *reservations and tickets* — Henry Wright; *symbol and competition* — Francis Merchant; *allied professions* — John Landon; *transportation* — Robert Field; *decorations* — Paul R. Hunter; *student activities* — Edward Fickett; *women's activities* — Mrs. Stewart Granger; *Orange County Chapter chairman* — Gates Burrows; *Pasadena Chapter chairman* — Wallace Bonsall; and *ex officio* — A.I.A. first vice president Earl T. Heitschmidt and regional director Donald B. Kirby.

Mysterious California

The way California manages to walk away with what sometimes seems like "most" of the awards in the A.I.A. Honor Awards Program every year has been the talk of many an A.I.A. convention. (Actually, it's not as bad as it may appear: of 22 First Honor Awards and 109 Awards of Merit in the first seven years of the program, the Californians accounted for seven of the former and 58 of the latter.) How do they do it? Well, one statistic out of the Eighth Annual Honor Awards Program, for which registration closed last month, is at least suggestive: of some 250 entries, an even 100 this year come from California.

British Honor Gropius

The 1956 Royal Gold Medal for Architecture has been awarded by Queen Elizabeth II to Walter Gropius. The former chairman of the Department of Architecture of Harvard's Graduate School of Design and founder of the Bauhaus will go to London in April for the presentation ceremonies. The award is made on recommendation of the Royal Institute of British Architects and is the British equivalent of the A.I.A. Gold Medal, the Institute's highest honor.

Worth the Winning

Aluminum Company of America and the National Association of Architectural Metal Manufacturers are co-sponsoring a competition with prizes totaling \$25,000 to uncover new design and construction ideas for aluminum curtain wall buildings. The com-

(Continued on page 16)

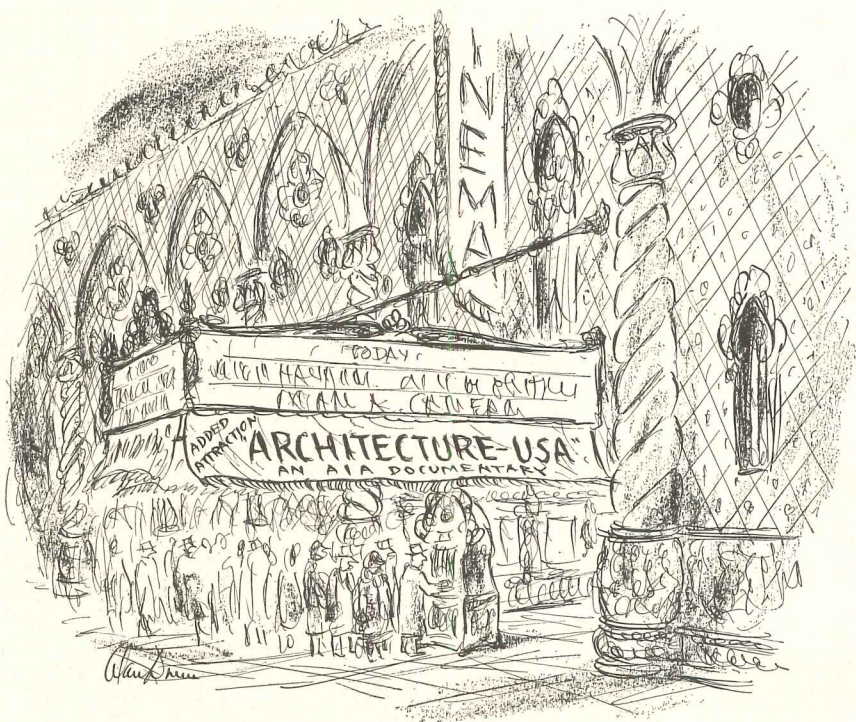

— Drawn for the RECORD by Alan Dunn

THE RECORD REPORTS

MEETINGS AND MISCELLANY

(Continued from page 15)

petition, with 18 prizes ranging from \$10,000 to \$500, is open to architects, designers, draftsmen and students in the United States and Canada. Paul Schell, A.I.A., of Pittsburgh is professional adviser; jurors, all members of the A.I.A., will be Max Abramovitz of New York, Kenneth Franzheim of Houston and Sigurd Edor Naess of Chicago. Closing date is March 26. Programs from: Paul Schell, c/o National Association of Architectural Metal Manufacturers, 228 North LaSalle Street, Chicago 1, Ill. . . . **The Society of the Plastics Industry Inc.** has announced a \$3250 house design competition open to architects, designers, draftsmen and students. Wanted: ideas for new uses of plastics, in house construction and built-ins, which provide "increased livability, comfort, safety and value." Prizes range from \$1000 to \$100; there will be special prizes for "feature areas" utilizing plastics — porch or outdoor living area, kitchen-breakfast area, bath-dressing room and children's or adults' playroom. Judges will be architects Paul Rudolph of Sarasota and John Highland of Buffalo and editor Hiram McCann of *Mod-*

MEDICAL RESEARCH REACTOR—Preliminary design made by Nuclear Development Corporation of America in cooperation with Brookhaven National Laboratory developed many features to be included in the medical research reactor to be built at Brookhaven (*AR*, Jan. 1956, page 12). In cutaway model photo below, patient treatment room is at right, animal experimental room at left, reactor core between; design provides for safe operation of the reactor in populated areas

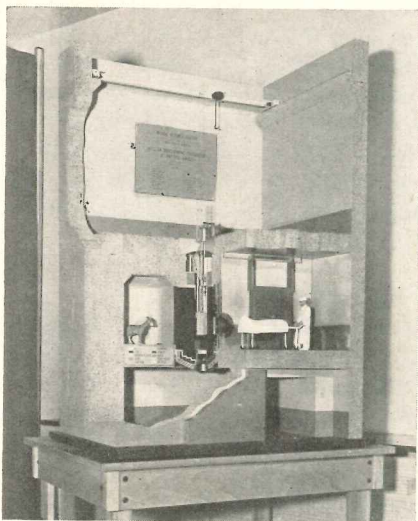

ern Plastics Magazine. The competition, which closes May 1, has been approved by the A.I.A. Committee on Architectural Competitions. Details from: James T. Lendrum, A.I.A., professional adviser, SPI Plastics House Competition, Mumford House, University of Illinois, Urbana, Ill. . . . **The Government of the State of New South Wales** will hold an international competition for a new National Opera House in Sydney, Australia. "Assessors," or judges, are Eero Saarinen of the U. S. A.; Henry Ingham Ashworth and Cobden Parkes, of Sydney; and John Leslie Martin of London. Three winning designs will receive prizes amounting to nearly \$18,000 — 5000 Australian pounds for first prize, 2000 for second and 1000 for third. Competitors must register by March 15, enclosing a remittance of 10 Australian pounds or its equivalent, with the Secretary and Executive Officer, Opera House Committee, Department of Local Government, Bridge and Phillip Streets, Sydney, Australia. . . . **Harvard University's Graduate School of Design, Department of City Planning and Architecture,** Cambridge 38, Mass., announces a new scholarship, or scholarships, totaling \$1200, from the Alfred Bettman Foundation for the year 1956-57 for graduate studies in city or regional planning, for a student or students accepted for admission or already enrolled in the Department. Recommendations will be made to the Foundation on the basis of admissions approved prior to April 1. . . . **The School of Architecture and Planning of the Massachusetts Institute of Technology** announces establishment of a research fellowship of up to \$1200 by the New York architectural firm of Voorhees Walker Smith & Smith, through the American Architectural Foundation. The fellowship will be awarded to a graduate student in the Department of Architecture or the Department of City and Regional Planning who submits "an acceptable program of research in the general field of *neighborhood needs and planning.*" Proposals must be submitted before April 1 to Pietro Belluschi, dean of the School of Architecture and Planning, M.I.T., Cambridge 39, Mass. . . . **The Rice Institute** invites applications not later than March 1 for graduate assistantships and fellowships in architecture for the academic year 1956-57. Assistantships require not more than eight hours of laboratory teaching and carry a stipend of \$1300; fellowships have a stipend of \$400 and remission of all fees.



EARTH SATELLITE—One man's guess at a very early precursor of interstellar architecture: model built by associate editor Herbert R. Pfister of *Popular Science Monthly* puts simulated instrumentation (standard subminiature electronic parts were used) inside plastic shell 18 in. in diameter; total weight, 25 lb. In the photo, satellite stands on "truncated third-stage rocket," *Popular Science Monthly* explains, as it might in actual flight. Model, which was displayed at *Hayden Planetarium* in New York, was built after consultation with scientists responsible for U. S. program

Candidates must be architectural school candidates with a professional degree. Applications should be addressed to the Department of Architecture, The Rice Institute, Houston 1, Tex.

Students in Britain

Almost as the first meeting of the new U. S. student organization, the Architectural Student Forum, was being held in Washington, D. C., under the sponsorship of the American Institute of Architects, came the announcement of the formation of the National Association of Architectural Students (of Great Britain). Objects, according to the *Journal* of the Royal Institute of British Architects, are "to link architectural students and affiliated societies, to act on behalf of architectural students in student matters, and to further architectural education by providing facilities as desired by the members." The Association, which invites dues-paying members on either a school or an individual basis, is organized in four regions — North, South, West and Midlands — and hopes, in lieu of a publication of its own for the present, to arrange for some

(Continued on page 18)

**2 INSTALLED
— ANOTHER
ORDERED!**
The two 100-HP
boilers in the
new Harris Hill
School. A 125-HP
unit will heat
the proposed
addition to
the Clarence
Elementary
School.

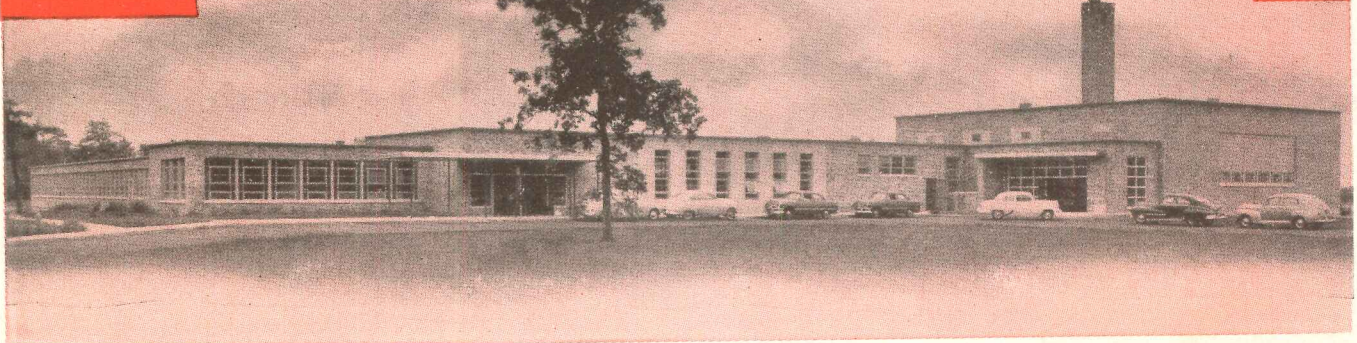
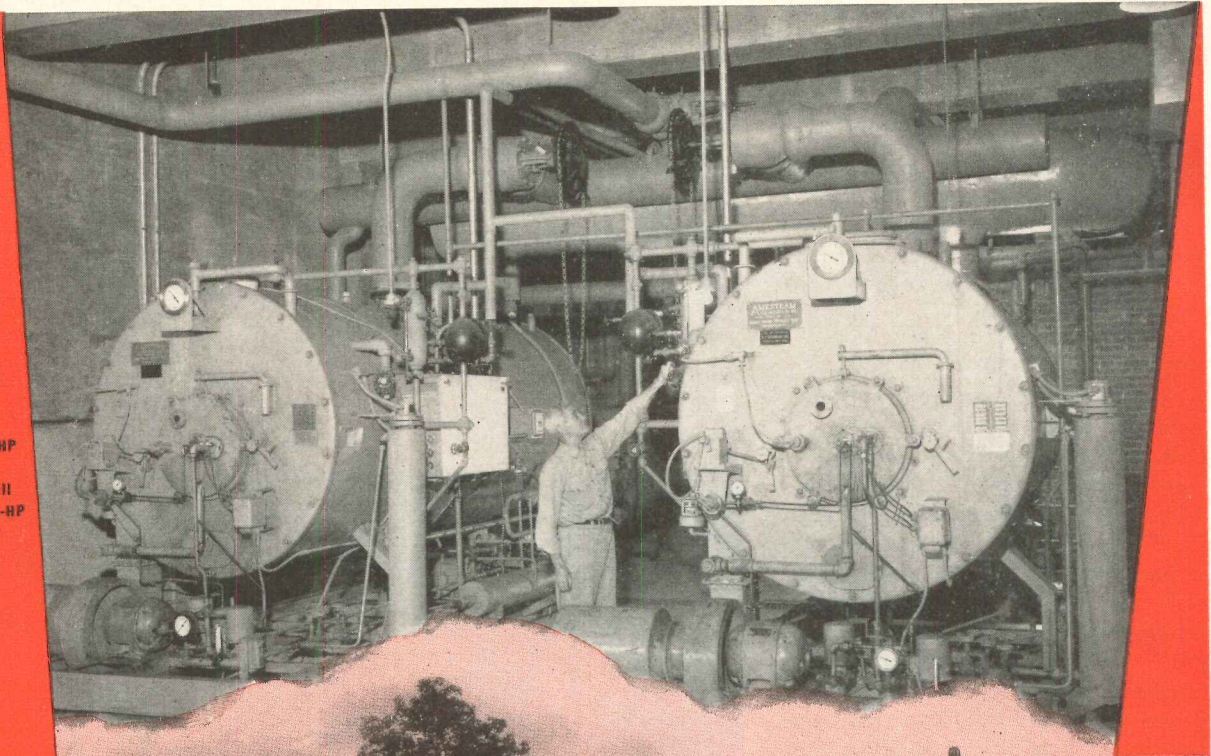

Harris Hill School, Clarence, N. Y., James Wm. Kideney & Associates, Architects; John W. Cowper Co., General Contractors; H. C. Mapes Corp., Heating Contractors.

**Another FINE SCHOOL HEATED BY THE BOILERS
OF PROVEN QUALITY**

**AMESTEAM
GENERATOR**

The new Harris Hill School of Clarence Central School District is an excellent example of sound planning for educational needs today and tomorrow. Its designers left nothing to chance, including the heating. They selected Amesteam Generators, the automatic package boilers with a 108-year reputation for dependability. Two 100-HP units have been installed in the Harris Hill School; with a 125-HP unit on order for the projected addition to the Clarence Elementary School.

Proven efficiency and dependability are the reasons why you'll find Amesteam Generators the choice for so many heating, processing and power installations . . . why Amesteam Generators are so often selected on performance, not first cost . . . why hundreds of our customers have re-ordered their 3rd, 4th, 5th and more units. Those who know Amesteam Generators, know they're getting the most important boiler value: low-cost steam!

MAIL COUPON TODAY

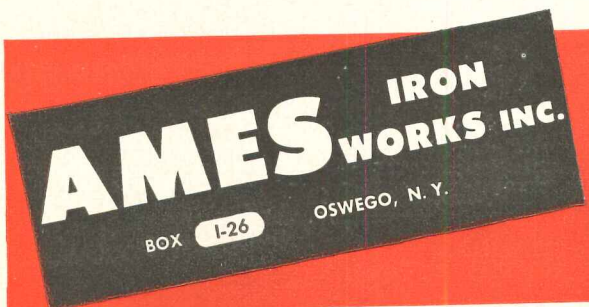

AMES IRON WORKS
BOX 1-26, OSWEGO, N. Y.

Gentlemen:

Please send me further information on AMESTEAM GENERATORS and name of the nearest representative.

NAME.....

COMPANY.....

ADDRESS.....

THE RECORD REPORTS

MEETINGS AND MISCELLANY

(Continued from page 16)

space in the established architectural journals. The Association's first annual congress is scheduled for next summer in London, and plans also include participation in international architectural student activities.

Art for Architecture

José de Rivera and Hans Hofmann have been commissioned to decorate the vestibule and lobby of William Kaufman's new office building at 711 Third Avenue, New York City. The building, designed by William Lescaze, will be completed in April. For all four walls of the building core that houses the elevators, and was designed as an island, Hans Hofmann has created a group of abstract murals in great splashes of color. The whole design will be translated into mosaic by the house of Vincent Foscato and will be installed under Mr. Lescaze's supervision. De Rivera has fashioned a unified design in two separate pieces of stainless steel which has been named "continuum." The two pieces will be hung over an area of about 50 sq ft on a contrasting dark stainless steel wall. . . . Another sculpture by José de Rivera has just been mounted in a patio of the Dallas Statler Hotel, William Tabler, architect. It is a large stainless steel piece painted chrome yellow inside and is on a revolving stand with water cascading below it into a rectangular pool. . . . For another office building in New York City sculptor Costantino Nivola has executed a relief to go into an office wall. The new building at 545 Madison Avenue was designed by architect Herbert Fischbach and is nearing completion. . . . Also of interest will be an exhibit at the Grace Borgenicht Gallery designed to tell the story of "Sculpture and Architecture." The show will run from February 13 to March 3. . . . In architect James Sudler's United States National Bank Building, part of Mile High Center, Denver, Colo., there will be three free standing panels of vitreous enamel designed by Peter Ostuni. The colorful seven-ft high panels, one a large abstract painting in blues and the others, two smaller abstract designs, one in hot reds, oranges and browns, the other in deep variations of greens, will be framed in brass and will "float" between two brass rods going from floor to ceiling. The panels will act as space dividers between the working and banking areas. They will be installed this spring.

(More news on page 22)



ARCHITECTURAL PHOTOGRAPHERS (caught, for once, in front of the camera, above) voted the four photo-

graphs below the best among 200 displayed at their recent convention in New York. Top — (left) M.I.T.'s Kresge Auditorium, by Joseph Molitor of Ossining, N. Y. (Eero Saarinen, architect); (right) Bloomingdale's, Fresh Meadows, L. I., N. Y., by Sigurd Fischer, Point Lookout, L. I. (Voorhees Walker Smith & Smith, architects). Center — Hunterdon, N. J., Medical Center, by Lawrence S. Williams, Upper Darby, Pa. (Vincent Kling, architect). Bottom — Maryland University Field House, by Robert C. Lautman (Hall Border and Donaldson, architects).

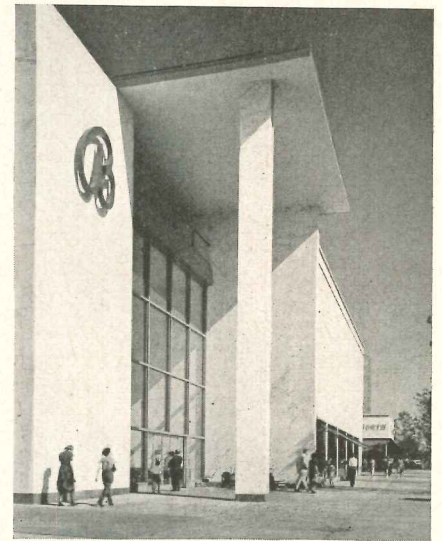
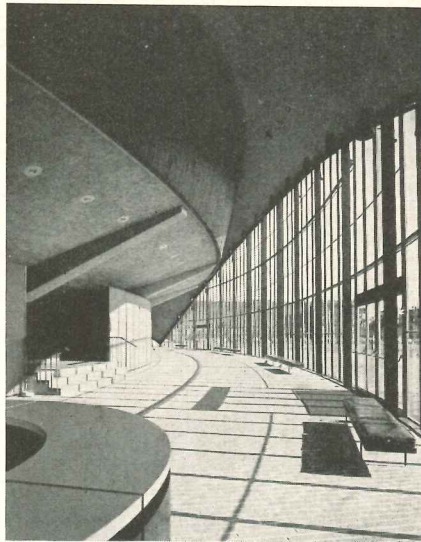

Star-Studded SERIES BY OASIS

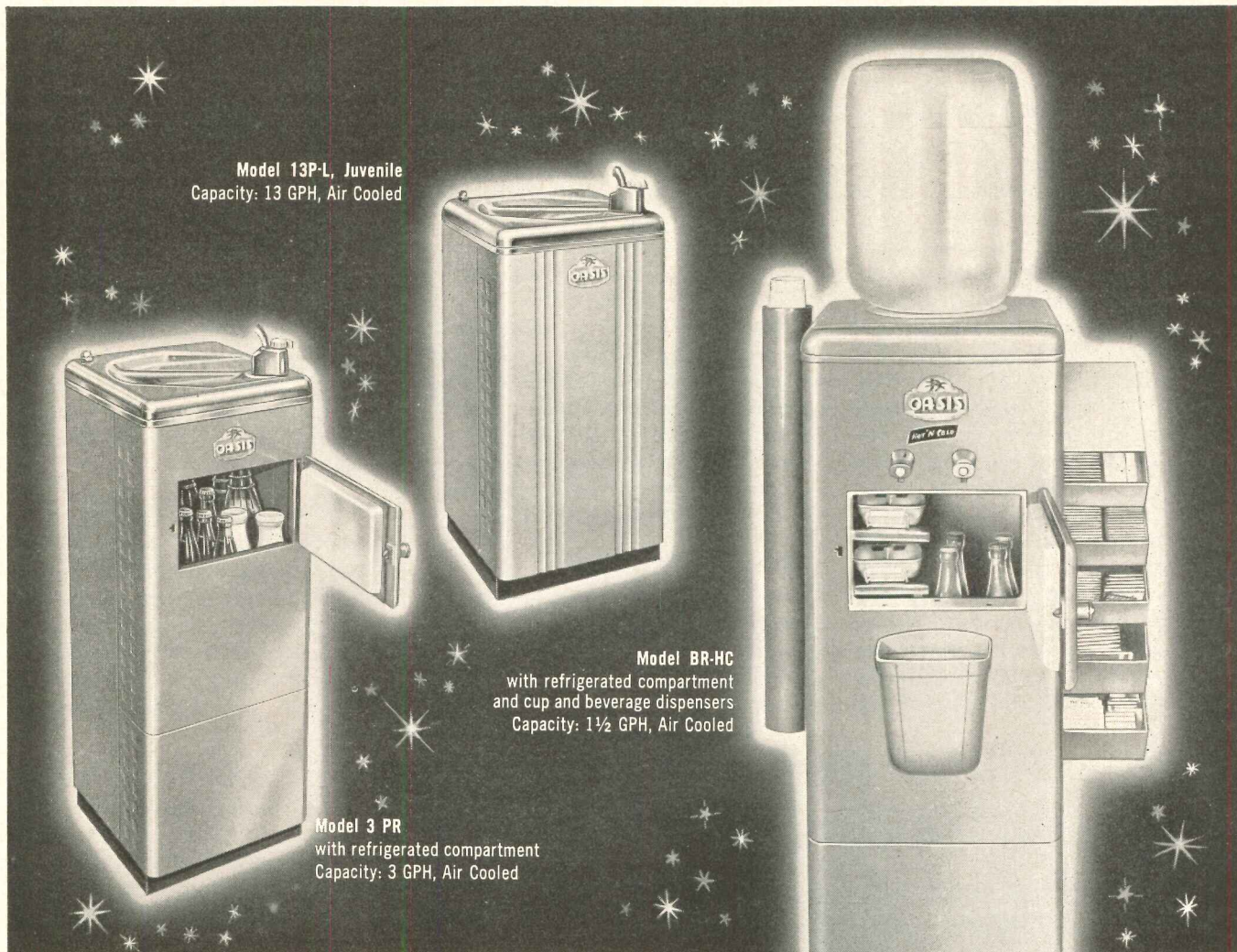
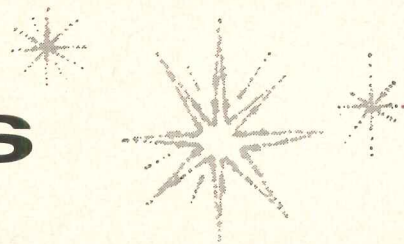

Model 13P-L, Juvenile
Capacity: 13 GPH, Air Cooled

Model BR-HC
with refrigerated compartment
and cup and beverage dispensers
Capacity: 1½ GPH, Air Cooled

Model 3 PR
with refrigerated compartment
Capacity: 3 GPH, Air Cooled

dispensers are optional accessories at slight additional charge—and individual service packages of coffee, chocolate, Pream and soup can be ordered direct from Ebco. And look! Now there's a bottle type Hot 'n Cold with a refrigerated compartment complete with ice cubes.

ACT NOW! Send for the Oasis Package—Beautiful 4-Color Spec Sheets and Roughing-In Drawings!



OASIS WATER COOLERS

The Ebco Manufacturing Company, Columbus 13, Ohio
Manufacturer of the most complete line of water coolers

Mail this coupon today!

DISTRIBUTED IN CANADA BY G. H. WOOD & CO., LTD.

THE EBCO MANUFACTURING COMPANY
Department MM, Columbus 13, Ohio

Please rush the whole story—spec sheets and roughing-in drawings—on the new Constellation Series to:

name _____

company _____

address _____

city _____ zone _____ state _____

1956 SEEN AS ANOTHER BOOM YEAR FOR CONSTRUCTION

A number of sources in the construction industry have predicted that Canada's building volume will continue high through 1956.

W. G. Malcom, president of the Canadian Construction Association, has forecast another \$5 billion-plus year for the industry. "Nearly one out of every \$5 spent on end goods and services will be spent on construction," he said.

At the same time, the Canadian investment house of Bongard & Co. estimates that the building volume could be increased by \$800 million annually if all requirements could be met over the next 10 years for highways, schools, hospitals, water and sewerage works. The Bongard figures are based on a proportionate projection of a recent estimate of United States needs published by the United States Department of Commerce. In each case the figures deal with what should be spent if capital and materials were available, and not with what will be spent. In theory, it means an increase of around 200 per cent over the amount actually spent in Canada in 1954. The United States estimate boosted the

value by 133 per cent over 1954 expenditures. The yardstick was the gross national product; the Canadian figure of \$26 billion was 6.75 per cent of the United States G.N.P. of \$385 billion.

As projected by the investors, the total annual average for the next 10 years should be \$1.22 billion against the \$405.3 million spent on Canadian construction in 1954.

On the basis of what is being accomplished, Canada compared well with the United States except in the highway category. The comparison showed that, proportionately, Canada is spending nearly as much as the United States on schools; hospital construction in Canada is ahead of that in the United States; water and sewerage spending is about equal; but highway spending in Canada is about half the United States rate.

Housing Looks Healthy

By far the biggest single category of Canadian construction is housing, which should remain high in 1956, according to Harry J. Long, president of the National House Builders Association, who

forecast that last year's housing production, estimated at 125,000 units, will be equalled and possibly bettered this year. Housing production in 1954 totalled 102,000 units.

Carryover of uncompleted new houses into 1956 is expected to be about 20 per cent higher than the carryover into 1955, a fact which is seen as promise of another record.

Continued high house production depends on continued effective demand, Mr. Long said; population growth is essential, he declared, but natural increase is not enough. He gave credit to the government for re-activating its immigration program by offering loans to newcomers unable to pay their own passage.

Mortgage Record Reported

For the official record of the year 1954, Central Mortgage & Housing Corporation has stated in its annual report on mortgage lending that activity on the Canadian mortgage market reached an all-time peak in 1954. The bulk of the

(Continued on page 32)

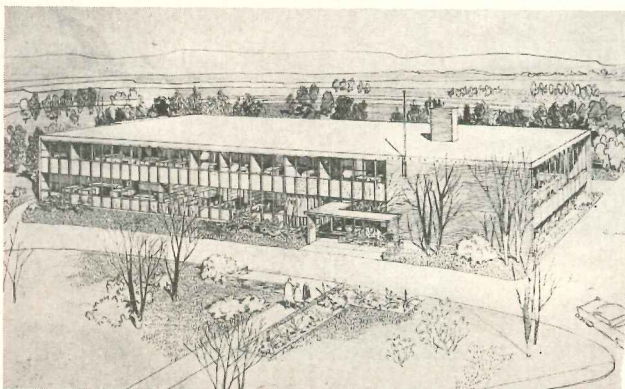

1

SOME CURRENT CANADIAN PROJECTS: The Canadian Welfare Council plans a new headquarters building (1) at Ottawa; Abra & Balharrie are the architects. The first private office building to be built in Montreal's Terminal Center (2) will be built over the Canadian National Railway tracks; the ends of the building have been designed by architects Greenspoon, Freedlander & Dunn as shear walls because of the high winds in the area. The Burrard Building (3), to be built in Vancouver, will have an earthquake-resistant welded steel frame, and will be covered with a glass and aluminum curtain wall; architects for the building, which is being built at an estimated \$7 to \$7.5 million, are C. B. K. Van Norman and Associates of Vancouver



2

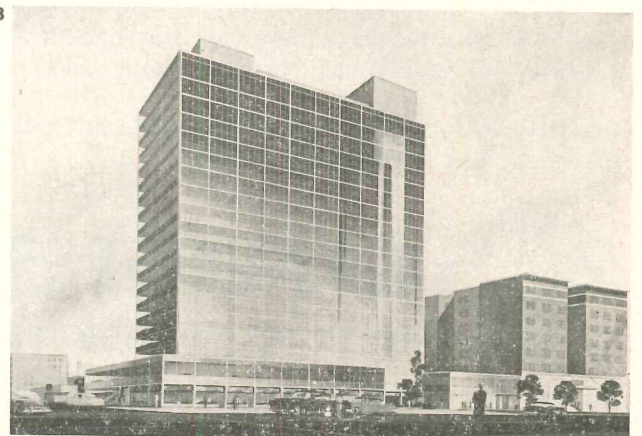

3

**FROM
OUT
OF
THE
BLUE**

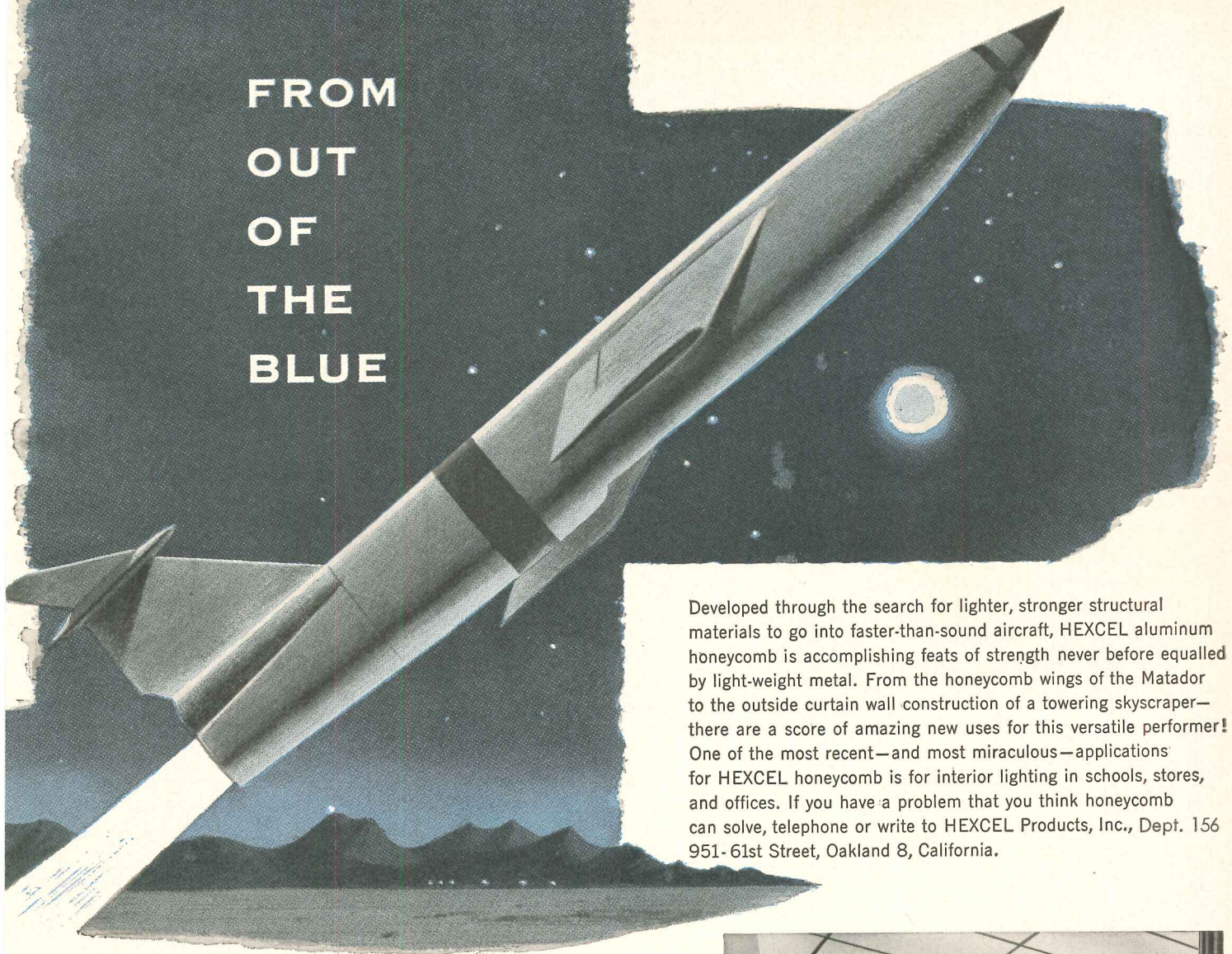

Developed through the search for lighter, stronger structural materials to go into faster-than-sound aircraft, HEXCEL aluminum honeycomb is accomplishing feats of strength never before equalled by light-weight metal. From the honeycomb wings of the Matador to the outside curtain wall construction of a towering skyscraper—there are a score of amazing new uses for this versatile performer! One of the most recent—and most miraculous—applications for HEXCEL honeycomb is for interior lighting in schools, stores, and offices. If you have a problem that you think honeycomb can solve, telephone or write to HEXCEL Products, Inc., Dept. 156 951-61st Street, Oakland 8, California.

HONEYLITE . . . *the last word in visual comfort!*

Picture an all-aluminum ceiling composed of thousands of hexagonal honeycomb cells, casting shadow-free, luxuriant light into every corner of the room...a ceiling whose neutral shading harmonizes with any color scheme or any decor. Picture a ceiling that will always look new, whose aluminum honeycomb panels, suspended under lighting units, will not crack from heat or discolor with age. Such a ceiling can be yours with **HONEYLITE**, the new light-diffusing material that has the following remarkable characteristics:

- * Transmits light with 95%—plus efficiency
- * Non-flammable and UL approved
- * Weighs only two ounces per sq. ft.
- * Permits free circulation of air around light units
- * Provides lowest surface brightness obtainable
- * Has a noise reduction coefficient of .46

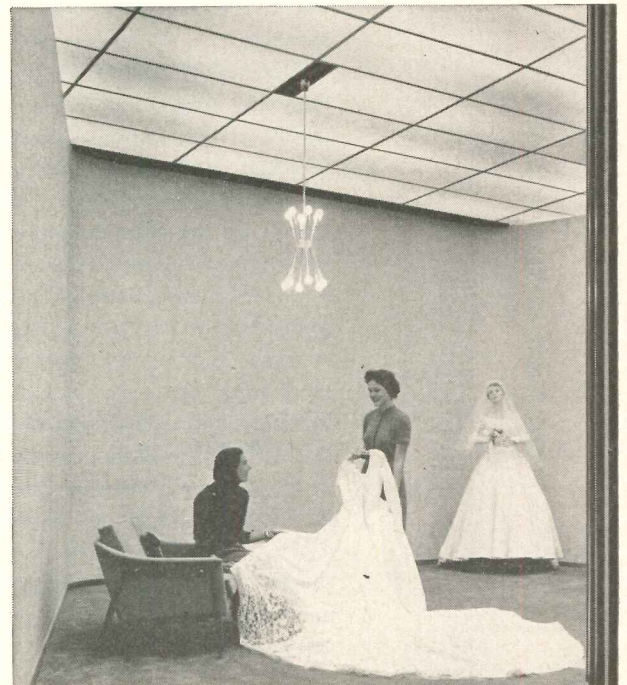

BRIDAL SALON, JOSEPH MAGNIN'S, SAN FRANCISCO VICTOR GRUEN, A. I. A.

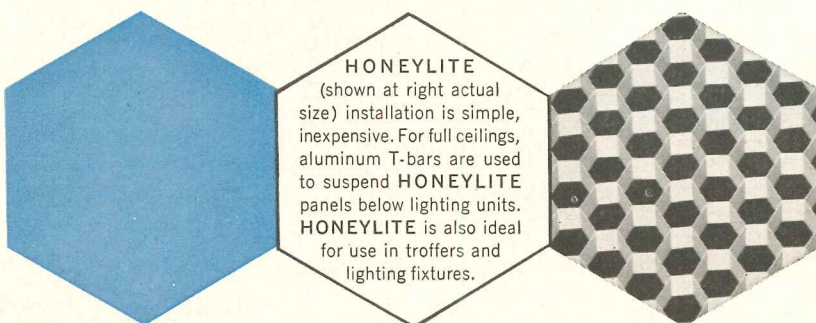

HONEYLITE
(shown at right actual size) installation is simple, inexpensive. For full ceilings, aluminum T-bars are used to suspend **HONEYLITE** panels below lighting units. **HONEYLITE** is also ideal for use in troffers and lighting fixtures.

HONEYLITE®

Light-diffusing acoustical aluminum honeycomb

A development of HEXCEL PRODUCTS INC.

Producers of HEXCEL aluminum honeycomb — the wonder material

THE RECORD REPORTS NEWS FROM CANADA

(Continued from page 30)

increase occurred in housing loans, where mortgages totalled \$670 million, a 30 per cent increase over the 1953 figure. The year 1954 was the first in which chartered banks were permitted to participate in mortgage lending and CMHC said this contributed to an easier supply of funds.

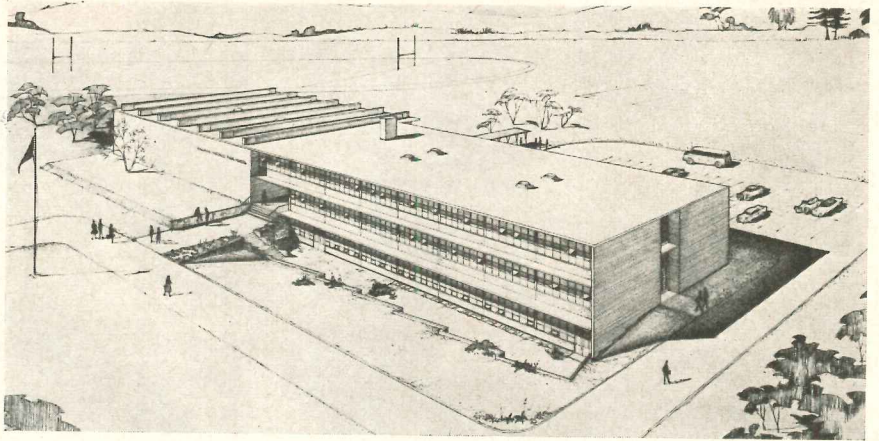

Niagara District High School will utilize prestressed beams in the gymnasium roof to give a 71-ft clear span; lift-slab construction will be used throughout the building. Craig & Madill, Toronto, architects

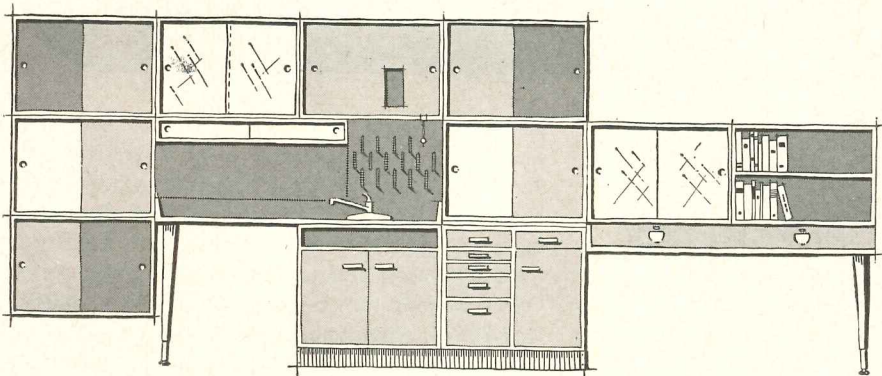

MULTI-LEVEL UNAFLEX

... concise instrument for teaching ... A new concept in LABORATORY FURNITURE... setting the stage for science to stimulate the students' interest and imagination. The advanced Unaflex in its neoteric form transcends the word furniture to become operational equipment. It will include perimeter planning, multi-level work areas, suspended storage space and apronless work tops. This new concept in lab planning by SJÖSTRÖM OF PHILADELPHIA will be previewed at the AASA Conference Exhibit in February, 1956, at Atlantic City ... and featured in the Unaflex Catalog U-561 off press in early spring. Reserve your copy now.

SJÖSTRÖM OF PHILADELPHIA

Designers and Manufacturers of

1717 NORTH TENTH STREET • PHILADELPHIA 22, PA.

UNAFLEX
LABORATORY FURNITURE

URANIUM MINES PLANNING NEW COMMUNITY IN ONTARIO

A townsite designed to accommodate a population of 12,000 to 15,000 is being planned about 20 miles northwest of Blind River in Ontario's uranium country. The project is being carried out with the cooperation of Algom Uranium Mines and Consolidated Denison Mines, which are getting ready for uranium production.

The townsite will be located within the Improvement District of Elliott Lake, which was established by the provincial government when it became apparent that uranium mining would bring large numbers of permanent residents to the area. The improvement district covers an area of 396 sq mi. Discussion between the Ontario government and the companies started about a year ago, and resulted in the reservation of surface rights over a certain area to be transferred subsequently to an improvement district.

OTTAWA ARCHITECTS HOLD THEIR YEARLY MEETING

Members of the Ottawa chapter of the Ontario Association held their annual meeting at the end of November at the Eastview Hotel in Ottawa. Their newly elected officers are: James W. Strutt, chairman; Gordon Pritchard, vice chairman; Henri Gouin, secretary; and D'arcy Helmer, treasurer. Other executive committee members are Wallace C. Sproule, Arthur Taylor and Norman Sherriff.

Engineer F. A. Sweet, general manager of the Canadian Standards Association, addressed the meeting on "Stand-

(Continued on page 36)

GIVES *Lifetime* SERVICE



AIR MAINTENANCE COSTS!

DEVELOPMENT . . . IN 25 YEARS

IT WEIGHT CUT LABOR COSTS

Evans filters are all aluminum. Light to handle, easy to carry, to pick up. In spite of airtight fitting, Evans filters pull quickly and easily out of the frames. Take much less effort, less labor to handle. No latches . . . or lugs required.

HEAVY . . . Initial costs for air cleaning equipment are not the big factors or controlling factors in the cost for clean air.

OPERATING COSTS THAT YOU MUST CONTROL WITH . . . THAT YOU MUST CONTROL. EVANS FILTERS GIVE YOU THAT CONTROL. IS IT POSSIBLE FOR YOU TO SAVE 50% ON CLEAN AIR MAINTENANCE COSTS.

- ALL ALUMINUM
- EVERY PART PRECISION MADE
- GIVES LIFETIME SERVICE
- HOLD UP TO 200% MORE DUST AND LINT . . . WITHOUT HARMFUL RESTRICTION TO AIRFLOW

FREE CATALOG MAIL COUPON TODAY

THE GEORGE EVANS CORPORATION • MOLINE, ILL.

Gentlemen: I wish to know how to cut my clean air maintenance costs in half with a filter that gives lifetime service. Please send me new illustrated catalog.

Name.....

Company.....

Address.....

City..... State.....

A I R F I L T E R S

REDEVELOPMENT PROMOTION: ZECKENDORF IN NEW YORK

The Webb & Knapp proposal for a \$100 million Palace of Progress atop the present site of New York's Pennsylvania Station has been superseded by a still bolder scheme for transformation of a 40-acre area of open track bounded by 30th and 39th streets and Ninth and Tenth avenues into "the city's most important center of commerce, recreation and communication." The "West Side Redevelopment Project," as outlined last month by Webb & Knapp's peripatetic president, William Zeckendorf, would cost an estimated \$300 million to \$500 million and involve the cooperation of both the New York Central and the Pennsylvania railroads, as well as the major television networks and the city of New York.

The original Palace of Progress scheme, as Mr. Zeckendorf tells it, just "spilt out" of its essentially vertical potential: in the city of skyscrapers, economics demanded horizontalization. This was because of the very special engineering problems involved in putting a nine-acre building over operating railroad tracks without interrupting the flow of some 689 trains a day: cost analyses indicated the building could not get tall enough to provide an economic amount of space without becoming so heavy it required entirely uneconomic engineering expenditures. Mr. Zeckendorf asserted, by the way, that the proposal had been found to be feasible

from a purely engineering standpoint.

The new scheme (see below) not only "spills out" the three major elements of the old scheme—the convention hall, the merchandise mart-buyers' offices and the "permanent world's fair"—but adds some considerable addenda—for example a "television city" which it is hoped will encourage the major networks to resist at least in some measure the lures of the West Coast (a perpetual New York concern these days). The present scheme would provide "large horizontal areas for TV studios hitherto unavailable in mid-Manhattan"—400,000 sq ft of production studios and an additional 1,600,000 sq ft for supporting service areas.

Another notable addition to the earlier plan: parking facilities. The project is planned to occupy two levels above track level—the middle level, at the grade of the city streets, will provide parking facilities for approximately 7500 cars; the steep slope of the site would make it possible to provide additional levels of parking if that became desirable. Buildings, pedestrian walkways and park areas will be on the top level.

A "rebuilt Pennsylvania Station" is envisaged as the entrance to the entire project, and "the point of origin for a transportation spur to the main body of the project." Use of moving sidewalks within the project itself is—of course—"under study."

Other proposed features: a 2000-room hotel for transients, an apartment hotel for TV City "citizens," a heliport, and—almost inevitably, in a Zeckendorf project, "the world's highest tower." This will be "Freedom Tower," approximately 1750 ft tall, "a free-standing shaft near the center of Manhattan Project II," providing broadcasting transmission facilities, "a glass-enclosed elevator ride high over the city," and "a powerful symbol for the entire project."

The new proposal would provide 12 million sq ft of floor space as compared with 7.5 million in the earlier scheme.

The plan was presented to Mayor Wagner and other city officials at a closed meeting at New York's City Hall last month; Mr. Zeckendorf emphasized that the plan would "cost the city nothing and we are asking for no tax exemptions. The city will get about \$16 million a year in taxes and we will put up a bond to guarantee that it will not lose a penny by use of its condemnation power to help carry out the new plan." The Mayor had no immediate comment, although his press secretary was quoted as saying he found it "bold and exciting."

The preliminary studies for the project have been developed by the Webb & Knapp Architectural Division, I. M. Pei & Associates, Architects. There has been some talk of commissioning leading architects for major buildings if the project materializes.

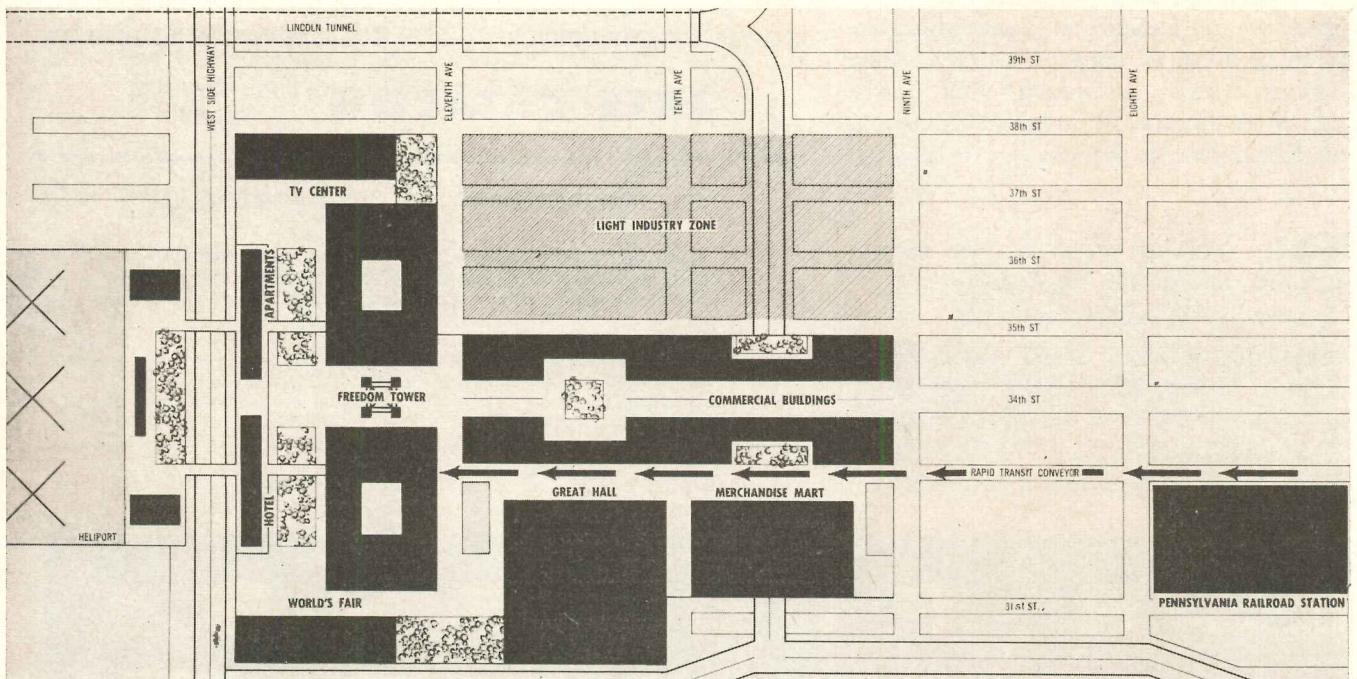

ARCHITECTURAL RECORD

FEBRUARY 1956

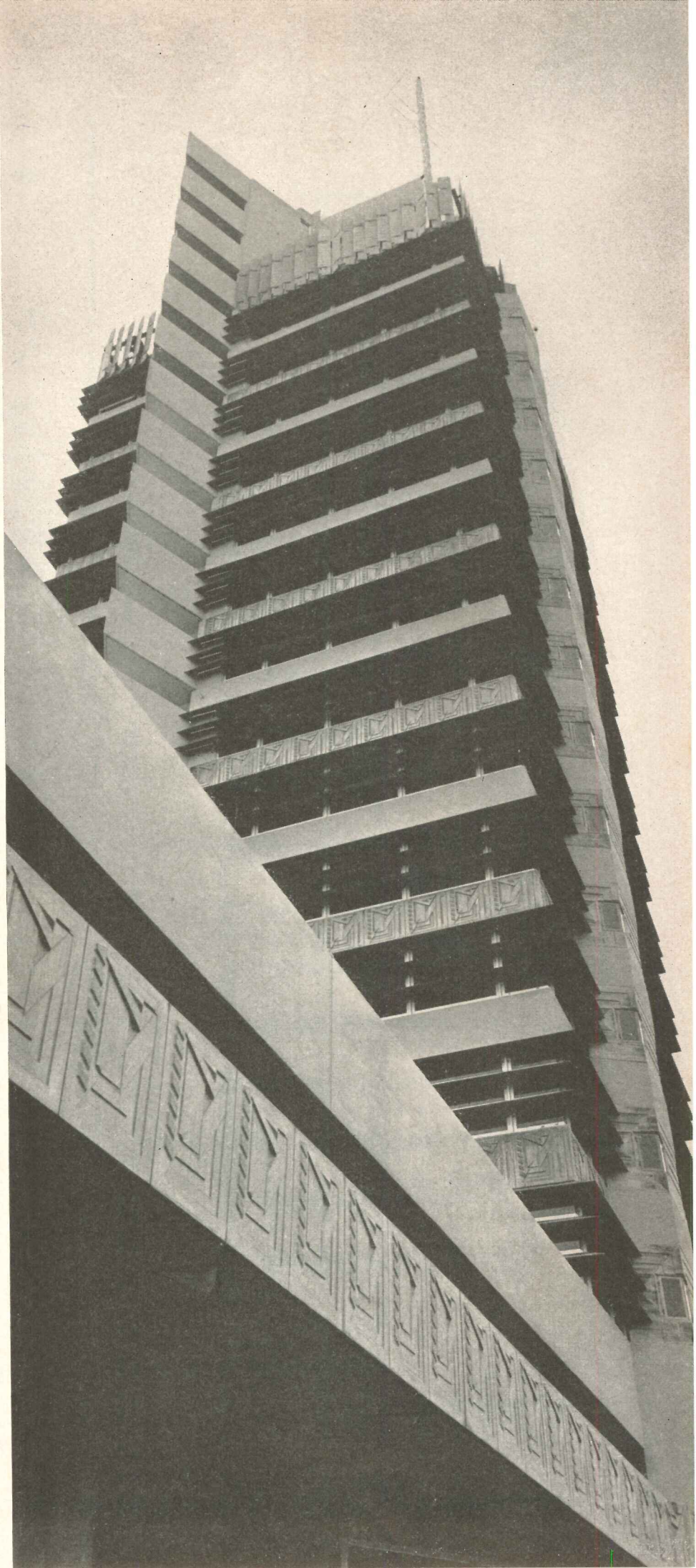

THE H.C.
PRICE
TOWER

Section reproduced by courtesy of Horizon Press, publishers of the book, *The Story of the Tower*, by Frank Lloyd Wright, to appear this month. See book review, p. 58.

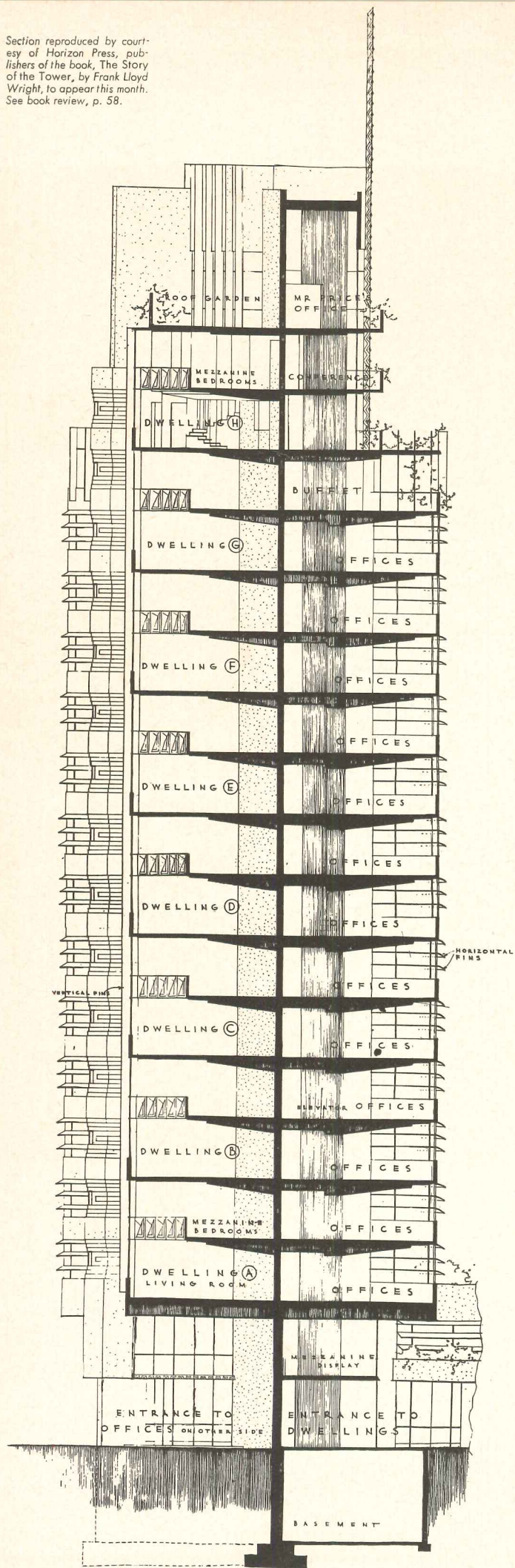

FRANK LLOYD WRIGHT

Architect of the Tower

THIS GENTLE SKYSCRAPER has escaped the big city to live in an American town in the country . . . To stand there in its own park, casting its own shadow upon its own ground. Reflected in a long slender pool it affords everyone everywhere in it a beautiful view of the rolling countryside that is Oklahoma.

The "skyscraper" in itself, where there is space, is a proper American circumstance; a triumph, not of landlordism, but of our own best technology. It should be a triumph of our architectural artistry as well. But such is not the case. The skyscraper of the big city where skyscrapers crowd upon skyscrapers is a rank weed in what otherwise might be a wholesome garden. The American skyscraper belongs, rather, to our smaller American towns like Bartlesville, where there is still a chance for the spirit of man to live and express itself in a free community that offers a better future to American democracy. The big city of today is servile and doomed by the eternal law of change.

This instance of the tall building in the country now seems to me to be one proper step on the way toward the inevitable, planned-decentralization of the giant-city: the city—a greedy monster—now being undermined by its own extravagance. The unplanned nature of this overgrown old pattern of the city—now so overcrowded with mechanized merchandise—is being accelerated to extinction by its own contrivances. This old pattern is not for the modern free-world of democracy.

Look at this American skyscraper now upright in the American countryside. A natural! Its glass is protected by wide projecting copper blades (or blinds) and tinted gold. The occupant is not only protected against actinic exposure; the whole building is itself shielded against weather. This copper shielding is for the liberation, comfort, and pleasure of those who live and work in the building. Glass is here a blessing to the occupants.

THE PRICE TOWER, BARTLESVILLE, OKLA.



Joe D. Price

Glass, the modern miracle, used *according to human nature*. That would mean used with architectural artistry.

Why not American buildings now as spirited as Mont St. Michel yet as scientific and utilitarian in nature as the automobile, the steamship, or the airplane?

Frank Lloyd Wright
Dec 18 / 55

FOR THE RECORD

Plans reproduced by courtesy of Horizon Press, publishers of the book, *The Story of the Tower*, by Frank Lloyd Wright, to appear this month. See book review, p. 58.

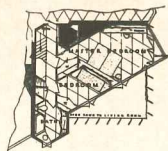

TYPICAL MEZZANINE

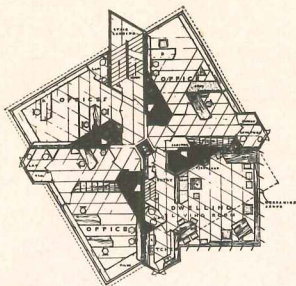

TYPICAL FLOOR

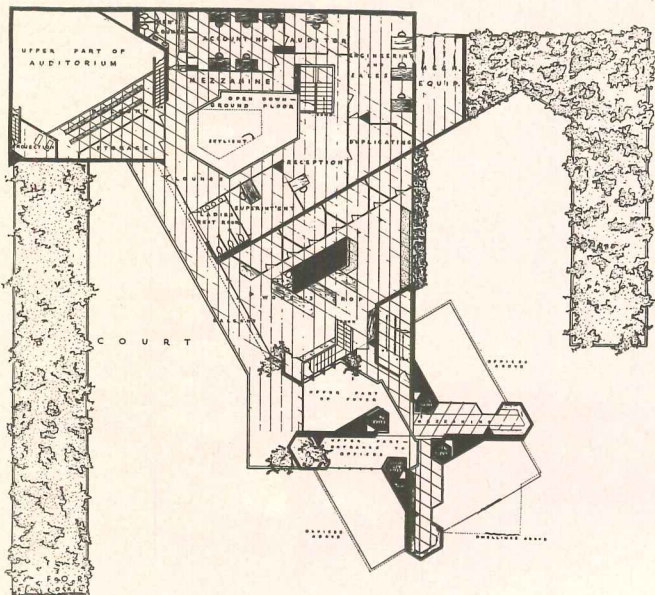
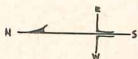

SECOND FLOOR

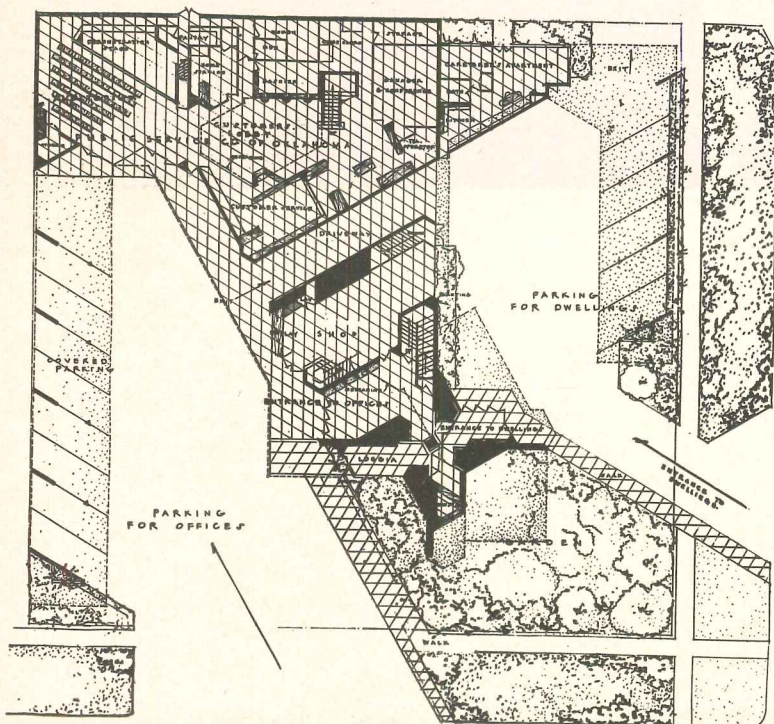

GROUND FLOOR

HAROLD C. PRICE

*Owner of the Tower and
head of the H. C. Price Company:*

THE DECISION to engage Frank Lloyd Wright the architect for an office building for the H. C. Price Company was prompted by our belief in his ability to create for us and our community a structure of great and lasting beauty.

We were of the opinion that an office building could be made beautiful without affecting proper functioning. It seemed to us that nearly all office buildings have followed a stereotyped design — with variations — though many have proved very impressive upon completion.

It was not our intent to build a monument. We simply wanted a functional office building that would possess a natural beauty brought about through outstanding design. We wanted a building of which our city would be proud. We believe that we have obtained the desired result.

Working with Mr. Wright and his Fellowship over a period of three years has been a liberal education in the appreciation of the arts of decorative and functional design.

During the construction of a building, the client and Mr. Wright do not always agree. When Frank Lloyd Wright is certain he is correct, he objects to change. But, if the client has logic in his argument, Frank Lloyd Wright will readily consider any sensible changes suggested.

We particularly noted that Mr. Wright is never bound by his original ideas. He will make changes as the work progresses, whenever it is practicable and advantageous to do so. And, without a single exception, during the construction of the Price Tower, every such change that was made resulted in marked improvement.

*Joe D. Price, son of the owner;
who took the photographs:*

WHEN ONLY the bare structural form of the building had been erected, it possessed a basic poetry different from the rhythm of the ordinary post and beam and slab system — a beauty that was actually built in before the exterior was ever applied. The outer surfacing — when it was finally fixed in place — merely intensified the ingrained charm and grace of the basic form; a quality best described by Mr. Wright's own term "organic."

THE PRICE TOWER, BARTLESVILLE, OKLA.



Joe D. Price

When the windows were added to the skeleton, their big mullions tended to make the building appear heavy. This discouraging stage of construction lasted several months. But one day, when the louvers had been applied to the upper third of the tower, I was walking along Bartlesville's main street and looked up over the little box-type buildings all about me to find the Price building towering majestically over them. Then,

for the first time, the true building itself became visible to me. There are no words to describe the intense feeling it gave me. Since then the building has grown in magnitude. As you drive through Bartlesville, down streets, past houses, through alleys, you keep seeing glimpses of the tower rising and thrusting nobly above the rooftops. Everywhere one goes he is aware of it — as a medieval cathedral, it dominates the town.

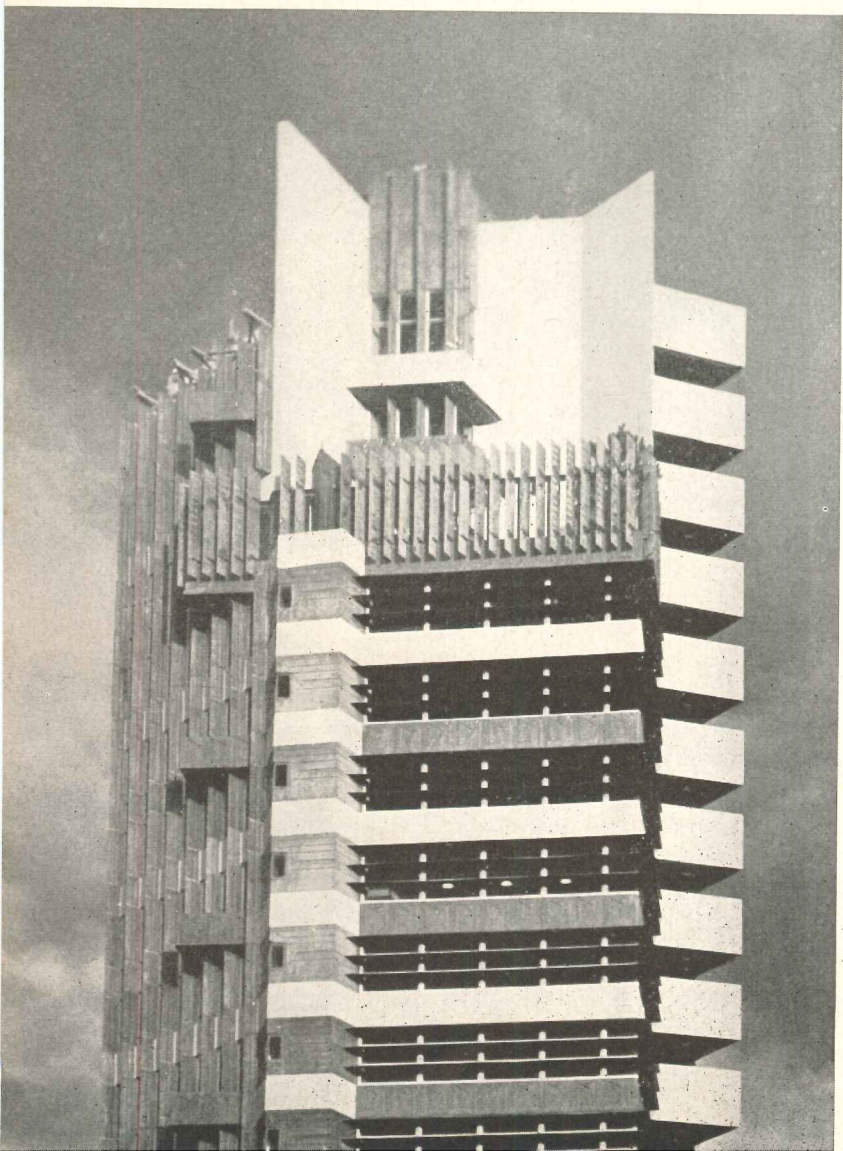
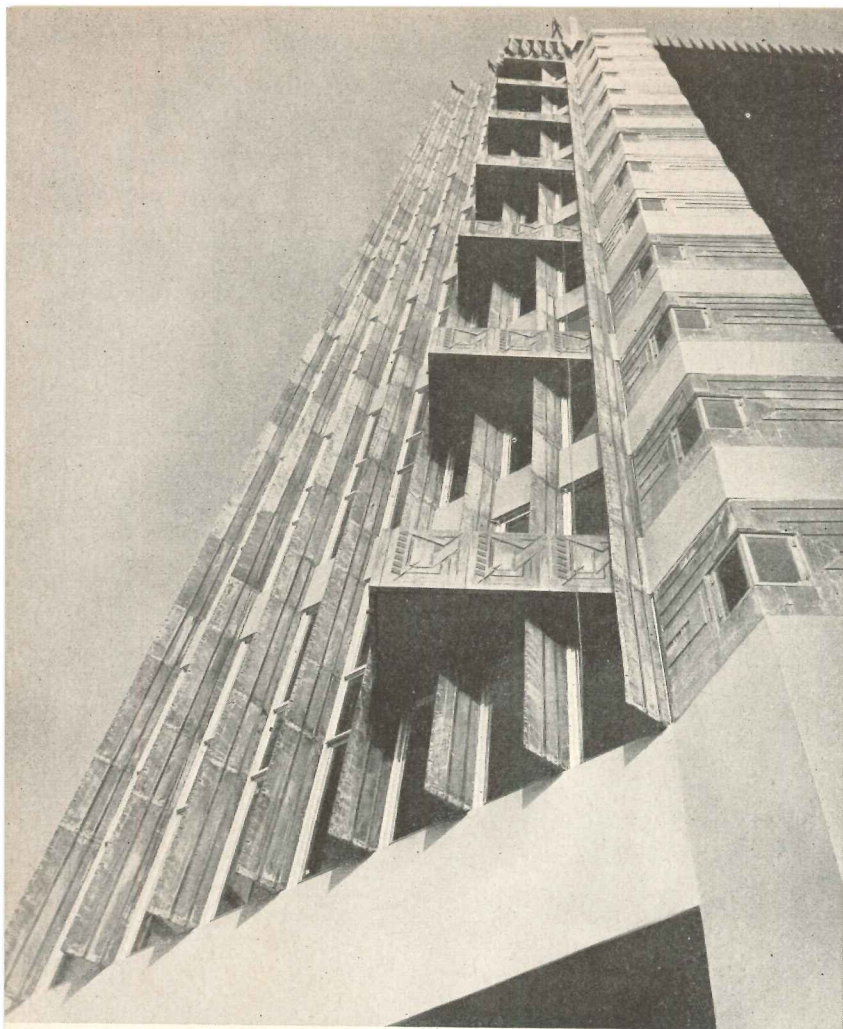

EDGAR KAUFMANN, JR.

Historian, author, critic:

THE PRICE TOWER culminates an extraordinary tradition that began in 1873 when Frank Lloyd Wright was four years old. Then Frederick Baumann published a pamphlet, *The Art of Preparing Foundations for all Kinds of Buildings with particular Illustrations of the "Method of Isolated Piers" as followed in Chicago*. At eighteen Wright went to work for Adler and Sullivan in the Borden Block, one of the earliest tall buildings erected on isolated piers, and designed by the partners themselves in 1880. Similar piers supported Sullivan's later masterwork, the Wainwright Building. Wright wrote, "As he threw the 'stretch' on my desk with the first three bays outlined in pencil I sensed what had happened . . . Until Louis Sullivan showed the way, high buildings lacked unity. They were built up in layers . . . All except one . . . Root's Monadnock . . . a noble building."

In 1890, tall buildings achieved their first symbolic and purely exterior expressions of unity: the second Leiter building (structurally advanced); the Monadnock (structurally retrogressive); the brilliant Wainwright (structurally symbolic rather than directly expressive). Ever since, unity of surface has remained the admired expression of tall building design.

Beaumann's seed idea of the isolated pier was to yield a second harvest, however. In 1929 Wright, after his great skyscraper projects of 1912 and the early 1920's, grasped the isolated pier as the very core of tall building in his scheme for St. Mark's tower. Developing from a 60 foot wooden windmill he erected for his schoolteacher aunts thirty-five years earlier, this concrete and glass shaft achieved a technical and spatial expression of startling originality. Four separate, symmetrical segments were linked by ribbons of patterned copper; fire-stairs differentiated alternate sides of the building; pointed ribs of concrete, evidence of the mast-like structure, impinged on the sky to top it all.

Twenty years later, in the laboratory tower for S. C. Johnson and Son, Wright gave the isolated pier a yet more forcible expression. One great concrete shaft, sunk deep into the earth, rises to carry work-space cantilevered about it, smoothly sealed in bands of brick and glass; the surface the complete expression of the core.

When Harold Price requested a building combining offices and dwellings, Wright reworked and

THE PRICE TOWER, BARTLESVILLE, OKLA.

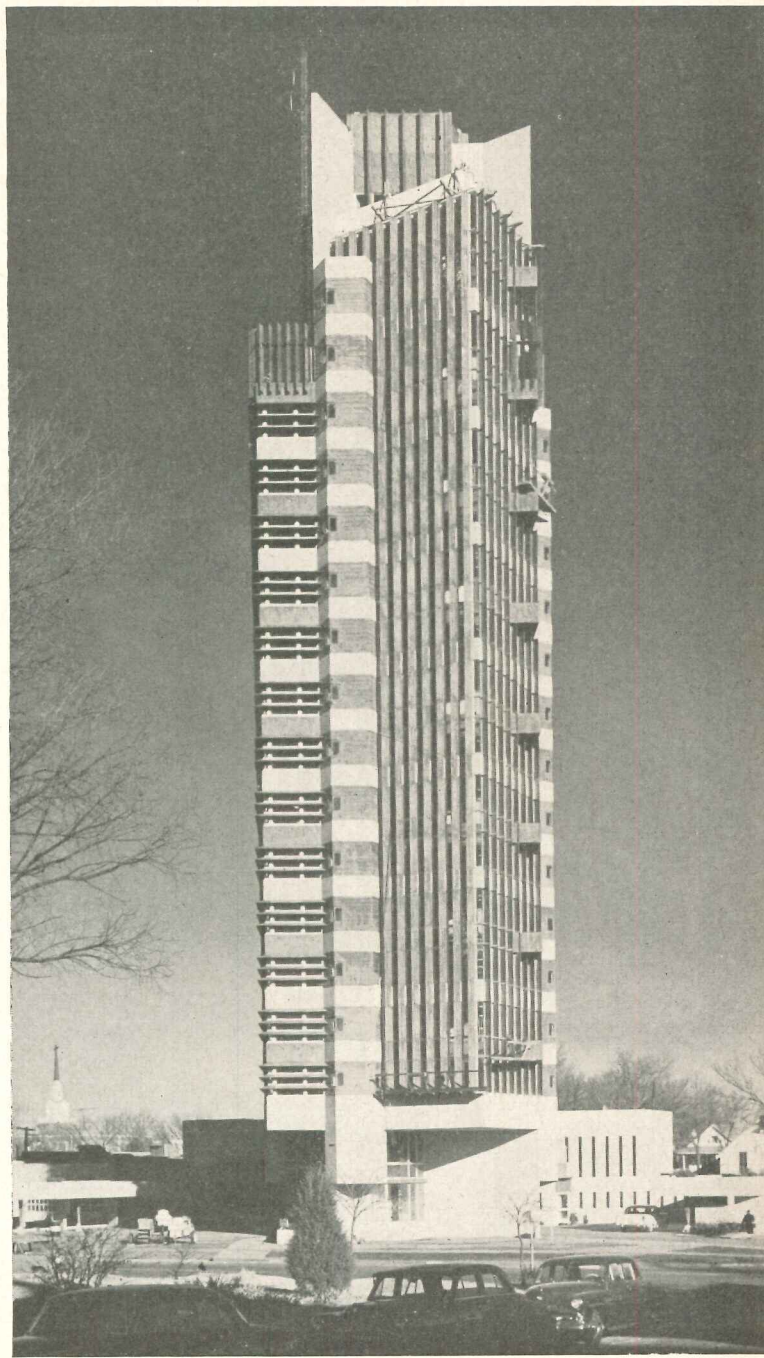
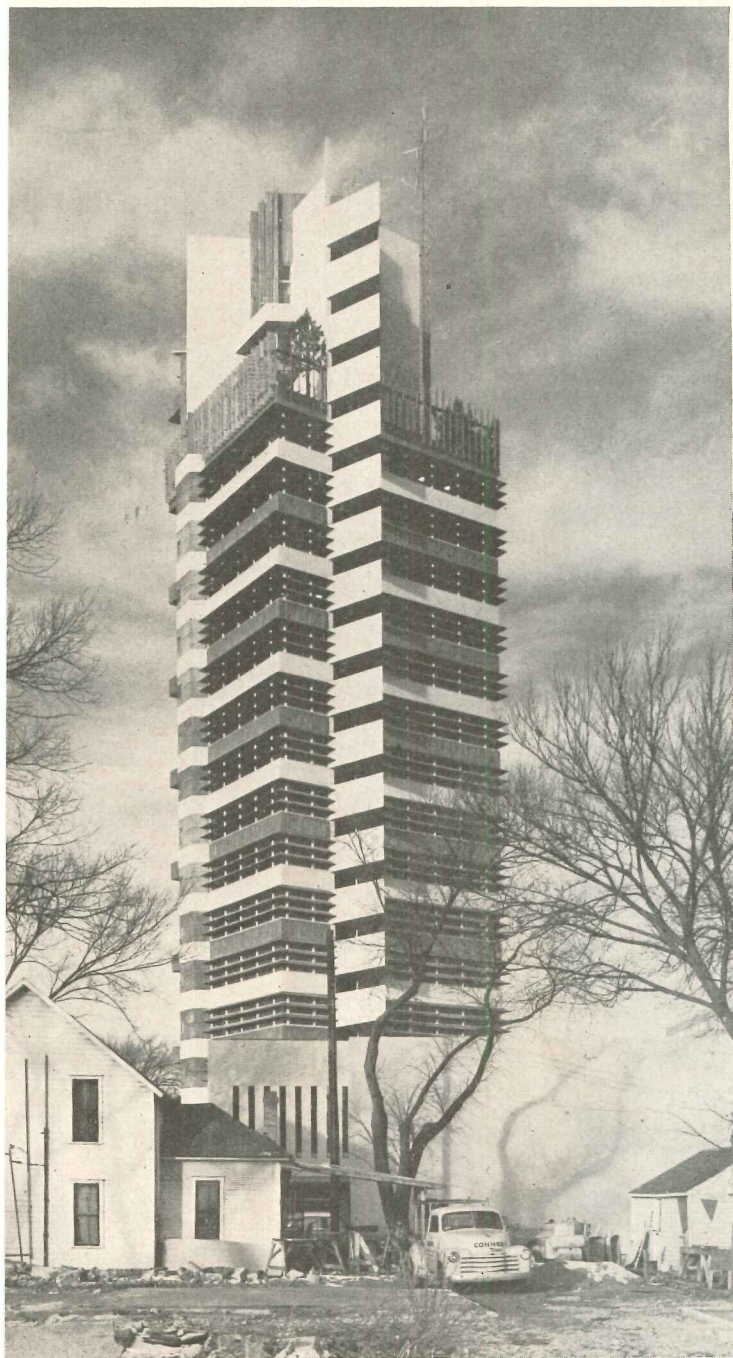

Joe D. Price

refined his original scheme of a tower in quadrants. The proportion of three to one in favor of office space produces an exterior asymmetry of continual, graceful surprises. Fire stairs and core-walls rise to a coronet of offices for the owner. Blue-green copper — inside and out — counters the different blue of the sky; golden glass softens the strong prairie daylight or warms the dusk. Copper fins further modify the light — vertical over the

apartment windows, horizontal elsewhere — ensuring in silhouette the vibrant dotted line Wright always prefers. The structural core of the Price Tower effloresces in movement, color, texture, ornament, and (in the penthouse mural) art, all held together and in scale by integration with the structure itself — inner unity and identity here embodied in an architecture that establishes as seldom before a new horizon.

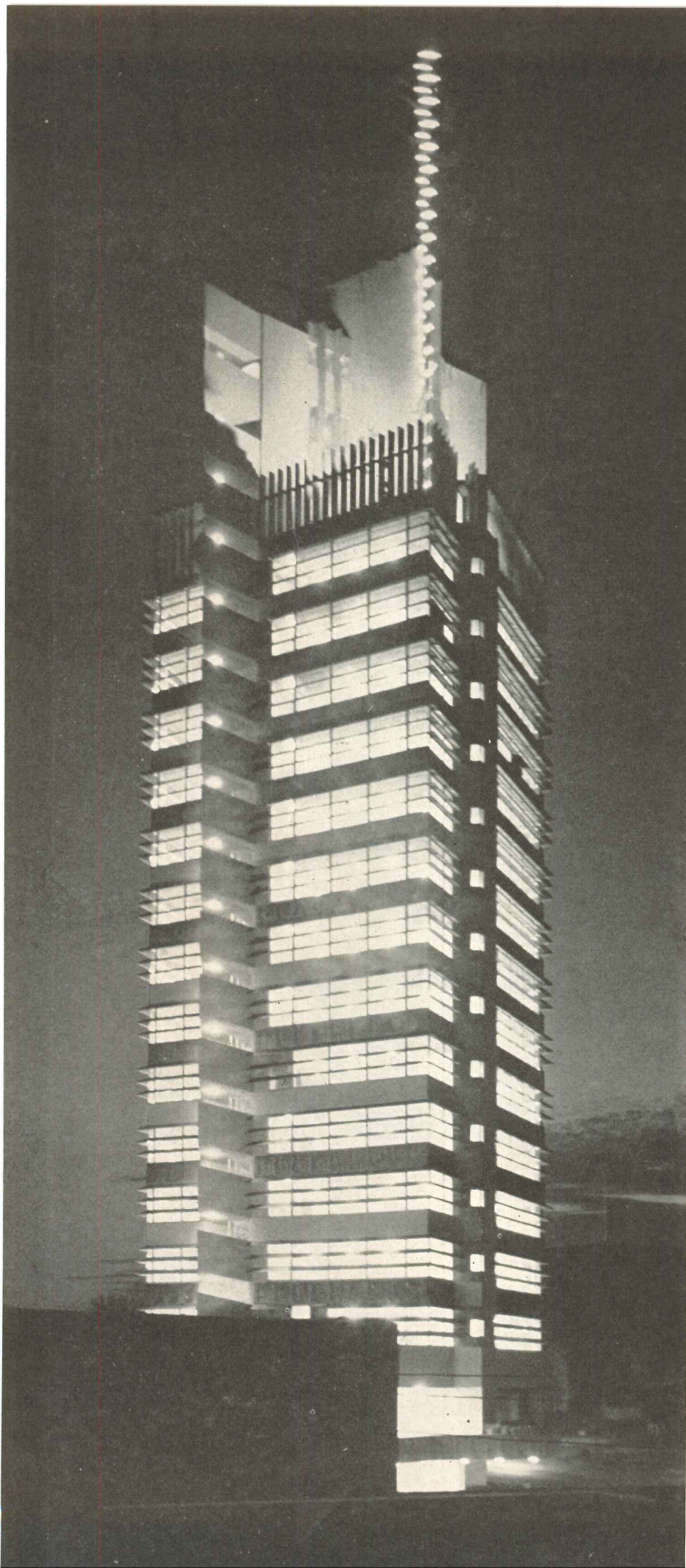

Architect: Frank Lloyd Wright

*General Contractor:
Haskell Culwell Construction Co.*

*Mechanical Engineer:
Collins and Gould*

*Electrical Engineer:
L. B. Perkins Co.*

THE CONTEMPORARY ARCHITECTURE OF FINLAND

A selection of examples from the comprehensive exhibition — now on tour — covering postwar achievement

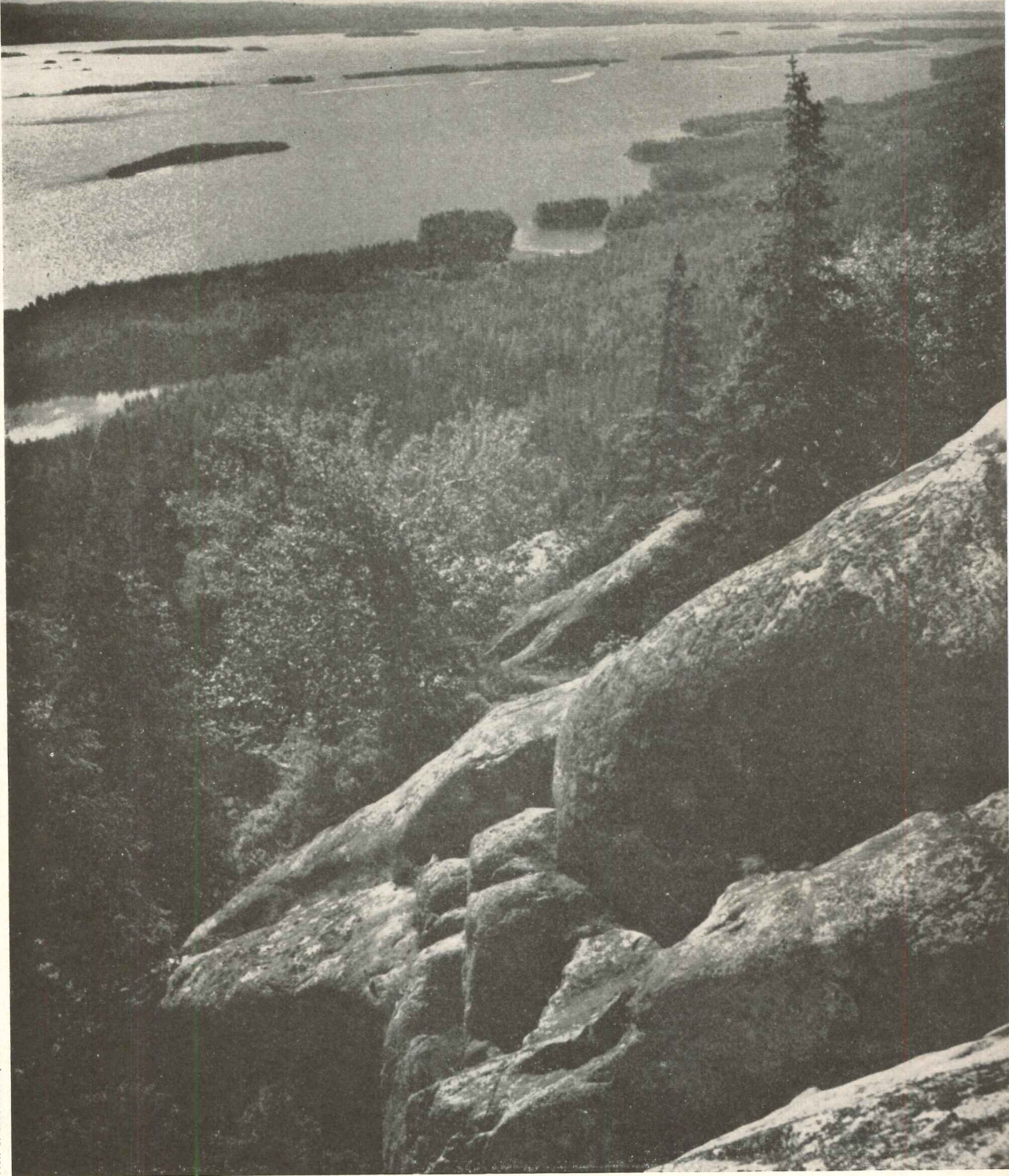

View of Lake Piiineu, near Koli

Arranged originally in 1953 by the Finnish Architects' Federation, and designed to show architectural achievement in that country during the past 15 years, an exhibition comprising some 30 odd panels showing 65 examples by 49 architects as well as a brief coverage of influencing historical works was shown for the first time in the United States at the reopening of the Octagon in November, 1955, and will tour the United States.

The traveling show was jointly organized by the Association of Finnish Architects and the Finnish-American Society; will be circulated by the Smithsonian Institution Traveling Exhibition Service. The Finnish Commissioner and Architect for the Exhibition is Iiro Tukkila; the sponsors are: The Finnish Ambassador to the United States, Mr. John A. Nykopp, and the United States Ambassador to Finland, Mr. Jack A. McFall.

Comments on the exhibit and discussion of the state of architectural development in Finland today — presented on the following pages — was written by Göran Schildt, Finnish historian and critic.



Eerikäinen & Sipari: Church at Salla (Lapponia)

FINNISH EXHIBITION

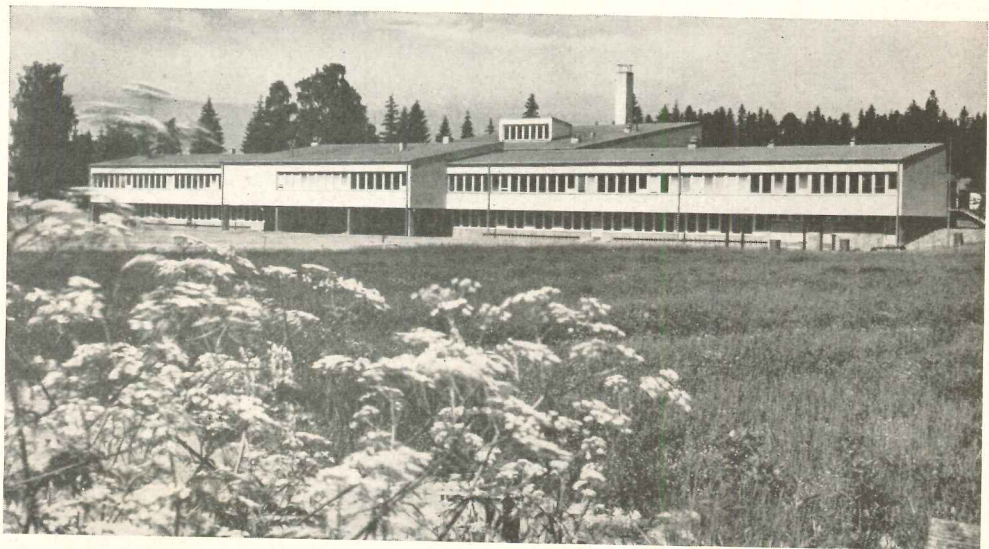

Rewell & Sipari: Primary School, Tuusula



Alvar Aalto: Tuberculosis Sanatorium, Paimio

Aarne Ervi: Phyakoski Power Plant, Oulujoki River

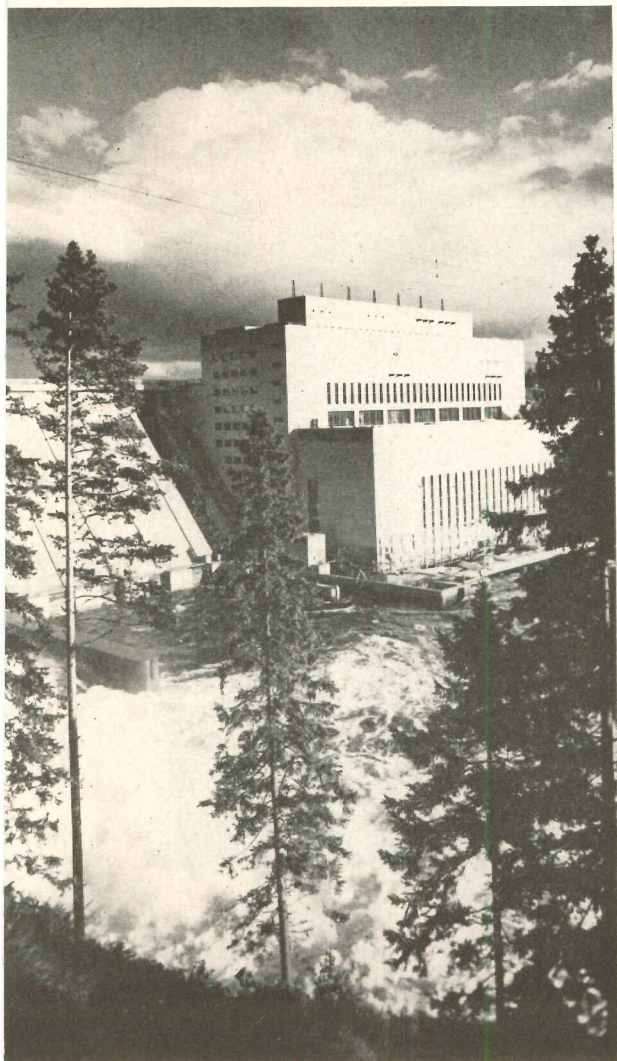

FINLAND BUILDS

by Göran Schildt

THE DEVASTATION and human losses of war occasion many reactions in society. One of them is an exceptional rise in the birth-rate. Another is that out of the ashes rise buildings larger and more numerous than those destroyed. When, in the Atheneum of Helsinki, in 1953, the Finnish Architects' Federation arranged the most significant and extensive architectural exhibition ever held in that country, the writer of the catalog correctly stated, "After World War II, Finnish architects have been given commissions of hitherto unknown scope." It has become apparent to many who have visited Finland in the postwar years that these commissions have indeed been many. However, the extent of what has been accomplished could be understood only at this exhibit, despite the fact that it failed to show the quantitative aspect of the reconstruction work. By means of carefully selected material, it aimed to show the best and most representative architectural achievements in Finland during the past fifteen years.

After a four day study of the designs, models, and photographs and after intense discussions with the originators of the designs, the writer left winter-bitten Finland feeling an urgent need to bring some order to all his impressions. These remarks will serve as an unbrooded attempt in that direction.

Perhaps the most impressive aspect of the exhibit was that it so clearly showed an art in the promising stage of expansion. It often happens that in viewing exhibitions of paintings or sculpture the spectator has the impression that both he and the artist are living twenty, fifty or five hundred years too late — that nothing but repetition and echo remain. Finnish architecture — with its wealth of fresh ideas, its spirit springing up from an inspiring competition between different temperaments and trends, its exaggeration and its fruitful mistakes — gives the impression of being in a vital, creative and triumphant stage of development. The spectator is possessed by the happy conviction that the best buildings ever built in Finland are being built now.

The exhibit included a small section as a memorial to Eliel Saarinen, the pioneer of modern Finnish architecture who died in his new homeland, the United States, five years ago. His designs, which combine the functionalism of the Jugend-style with an ineradicable love for the monumental element, pose a difficult question: is there unity in modern Finnish architecture — something that can be considered a national feature? The weight and earnestness of closed granite and a robust monumentalism, foreign to every attempt at elegance, was characteristic of Saarinen and his contemporaries Lindgren and Sonck. But they were not alone, and won many followers among the group of architects who created the Parliament Building under J. S. Sirén and who formed the so-called "Helsinki school."

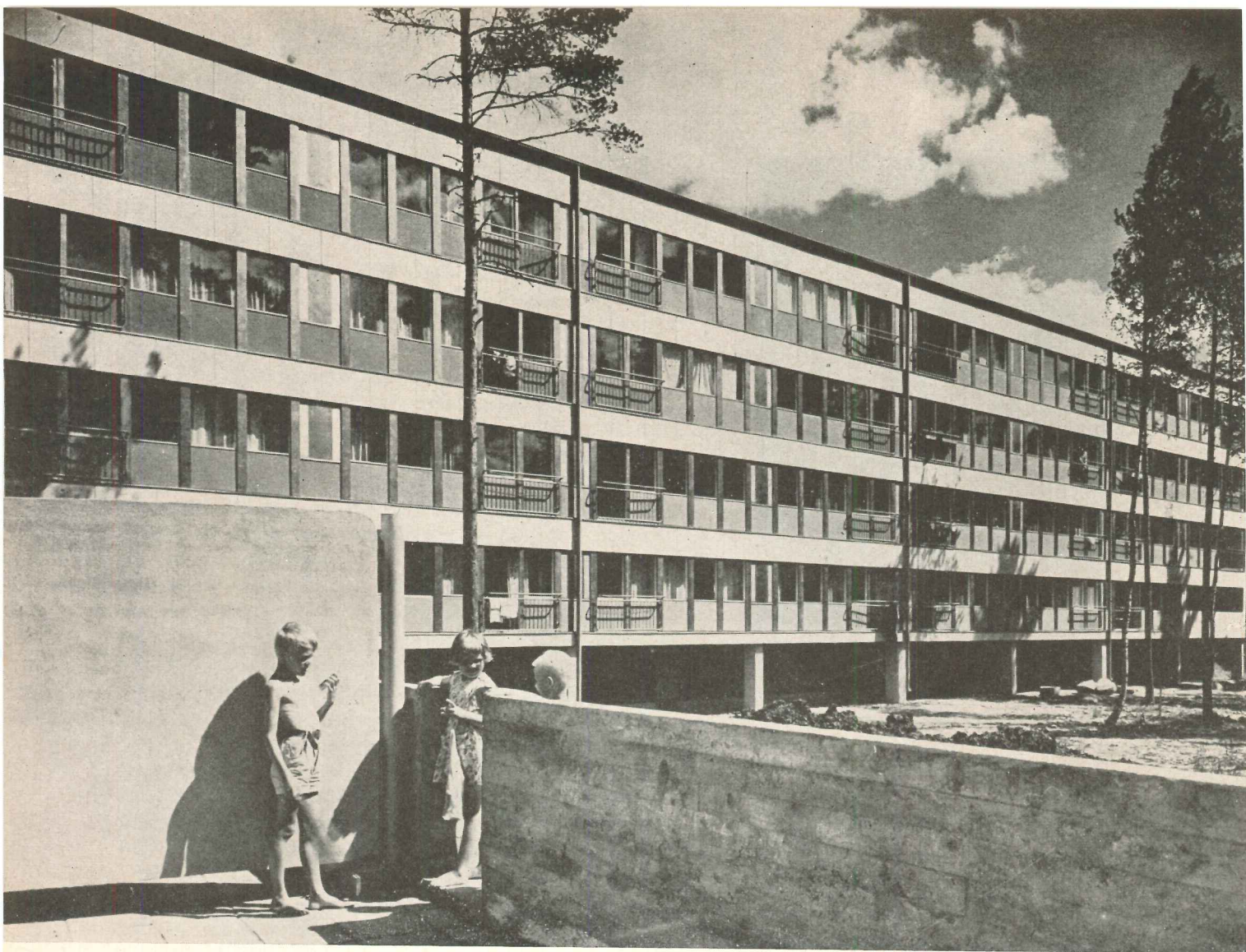

Viljo Rewell: Apartments at Tapiola, Helsinki

FINNISH EXHIBITION



Aarne Ervi: University Library, Turku

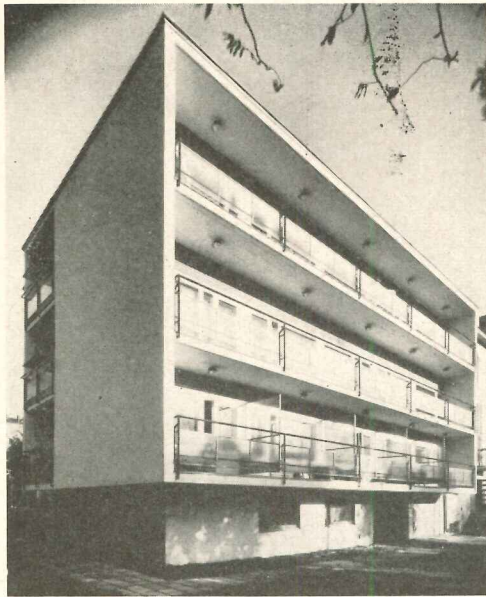

Iiro Tukkila: Cancer Clinic, Helsinki

Erkki Huttunen: Flour Mill, Nokia

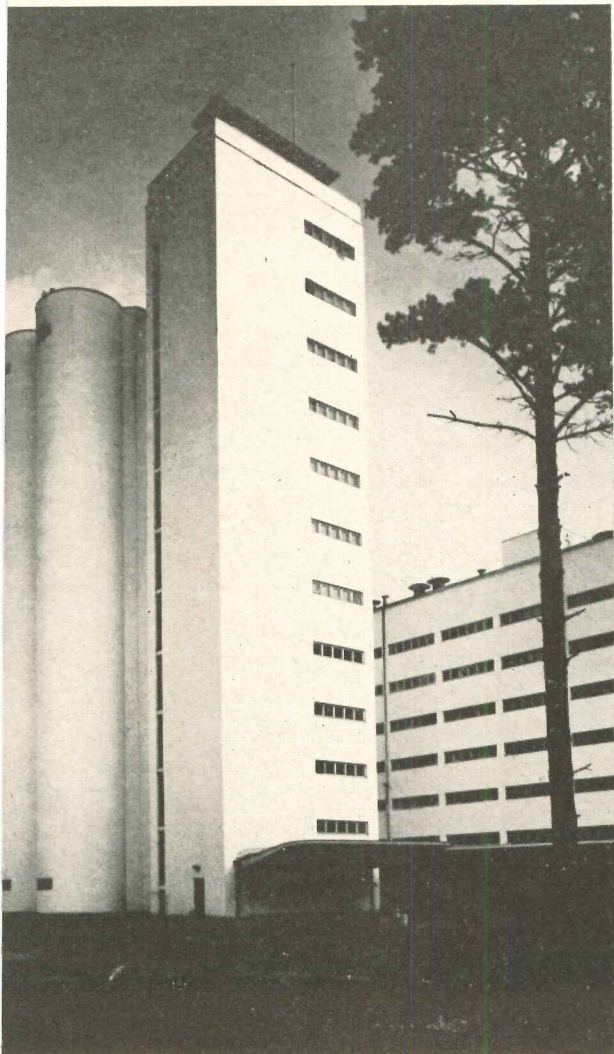

Schildt (continued):

As a contrast to this development, there appeared in Turku another group, led by Alvar Aalto and Erik Bryggman during the rationalism of the thirties, which followed a line freed from both weight and monumentalism. At that time, it appeared as if vital Finnish architecture had been seeking a way out of what had seemed its national characteristics. Now, twenty years later, it can be seen that this was not the case. Alvar Aalto, who was called upon to become the great foreground figure has, step by step, turned back from his early excursion into Le Corbusier's grounds, made in the building of Turun Sanomat, in Paimio Sanatorium and in the City Library of Viipuri. The leap is truly enormous from Saarinen's design for a parliament building in Tahtitorninmaki in Helsinki to Aalto's Town Hall in Säynätsalo. However (in the writer's eyes), Alvar Aalto is in his latest creations materializing the best aspects of the aspirations that, in the past, have led to the erection of so many masculinely rugged, noble and emotionally-toned buildings. That this outlook of Aalto's has penetrated through solid rational schooling and that his characteristic feeling for moderation shrinks from all crushing monumentalism (the solution of the enormous People's Pension Institute in Helsinki to a system of smaller building units provides a good example of this) serve to indicate that his idea of monumentalism is akin to the ideas of composed and sober Greeks.

Against this background, one is also inclined to consider it a good sign that, instead of slavishly following their master, so many of the country's younger architects for their part go along the same road as he. In other words, they seek a contact with an architecture of glass and concrete structure, of floating lightness and logical calculation.

The outstanding name in this more rationalistic trend is Viljo Rewell. He has created, in addition to the Industrial Palace in Helsinki, a highly meritorious school in Meilahiti, as well as apartment houses that would be embellishments in today's rebuilt Milan. An interesting specimen of this trend is the new church at Salla in northern Finland, designed by architects Eerikäinen and Sipari. It is immaterial that it looks from a distance as if it were made of folded paper, for actually it is a rigorously constructive solution, based on a roof elevation related to those of the medieval gray-stone churches.

That Alvar Aalto should dominate the exhibit was to be expected, but it was nevertheless surprising to find his work foremost in virtually every section of the exhibit. Town planning, saunas, crematories, factories, hospitals, passenger ships, schools, churches, office buildings, apartment houses and tombs — each of these seems equally to inspire his tireless creativeness. For the writer (who had previously seen most of Aalto's

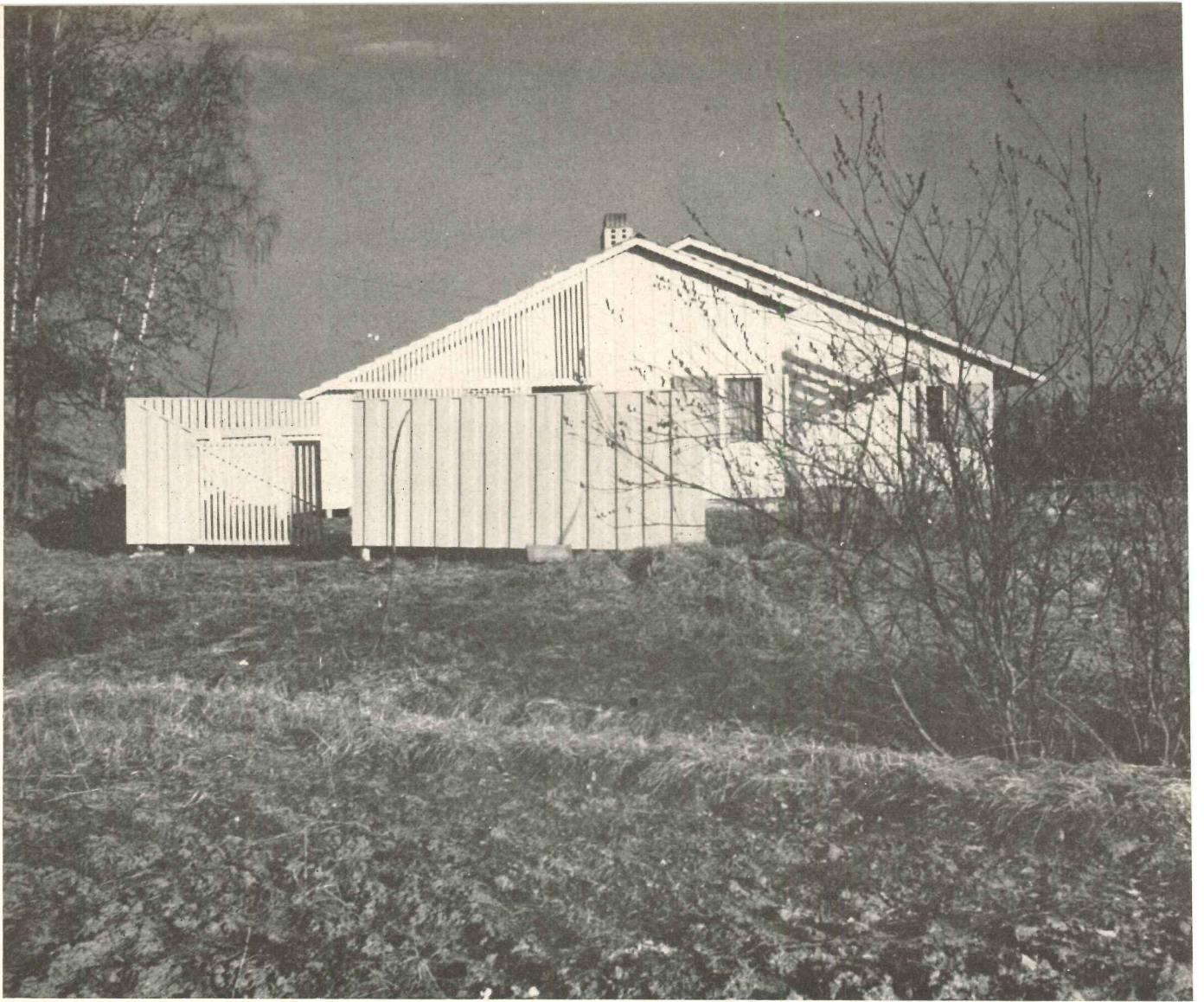

Olof Hansson: Villa Schild, Östersundom

FINNISH EXHIBITION

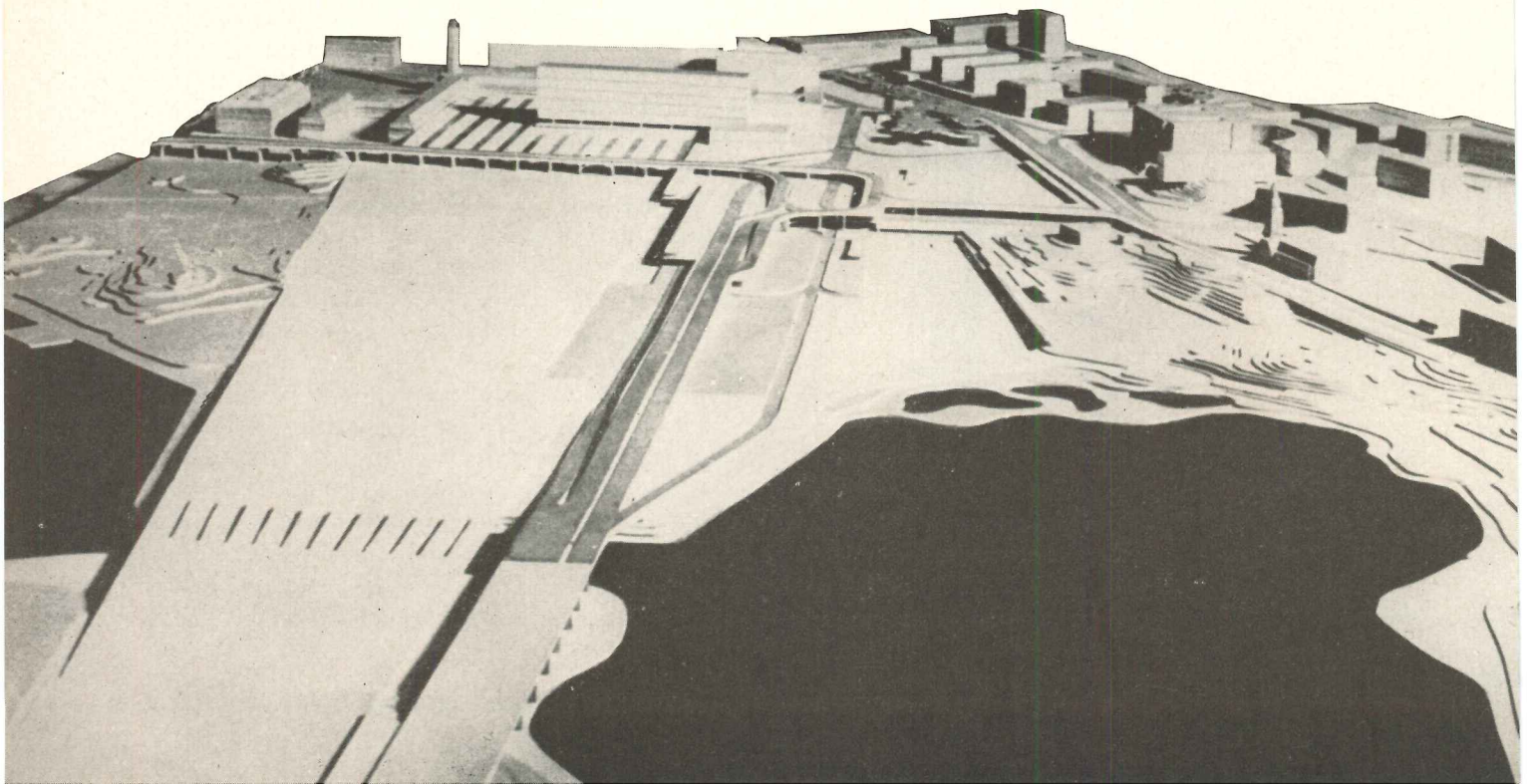

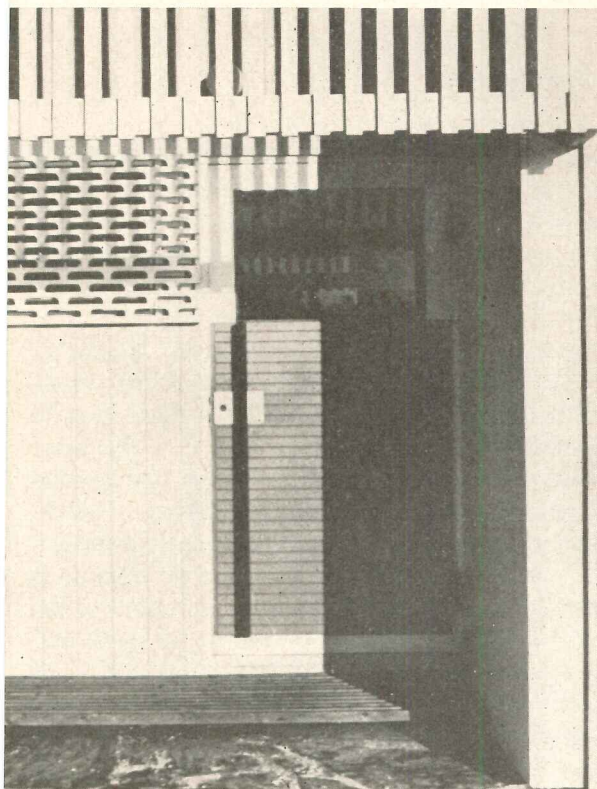

Olof Hansson: Entrance, Villa Schildt

Schildt (continued):

works in reality) the design for the crematory and cemetery in Kongens Lyngby, outside Copenhagen offered the most positive surprise. The difficult problem posed by modern, effectively organized cremation has here been solved with distinction.

Although Aalto is the dominant figure, it should be noted that he has influenced his colleagues far less than might reasonably be expected. Finnish architecture is markedly republican in spirit, its tendencies are divergent, and the sources of inspiration are more often sought outside the country's frontiers than inside. Aalto's indirect influence is most certainly great, although uncontrollable; the existence of this grand and honest architecture must surely exert an inspiring influence on the entire surroundings. Two independent architects of the older generation are the late Yrjö Lindegren, creator of the Olympic Stadium in Helsinki, several other sports establishments and the so-called Snake House, a freely winding apartment house in Helsinki; and Erik Bryggman, most noted for his Cemetery Chapel in Turku, but perhaps greater where his weakness for decorative elements is less evident. Ragnar Ypyä recently built one of Denmark's largest hospitals in Glostrup, and a very well planned housing area in Västerås. However, his design for an enormous, circular building for the new Kivelä Hospital, in which many of the treatment rooms are placed in the windowless inside of the circle, seems decidedly less successful. Among the younger architects, we have mentioned Rewell, a talented designer. Aarne Ervi takes a lively interest in building with prefabricated beams and other manufactured elements. The Institute Building of the University of Helsinki and the large power plants at Oulujoki have won him great admiration.

There are other names and projects that deserve mention; Jonas Cedercreutz' and Helge Railo's Central Hospital in Jyväskylä, an attractive and daring creation; Jorma Jarvi's Swimming Stadium for the 1952 Olympics; Markus Tavio's dignified, altogether modern and exceptionally pure-formed church in Meilahti, Helsinki; and Keijo Petäjä's unusually intelligent solutions for the problem of a sauna and villa built on steeply sloping ground. Heikki Siren, who has plenty of ideas, shows his most merited creation in the Concert Hall in Lahti. But a further listing of names and buildings serves no purpose; it is more fruitful to attempt a general summation of the exhibit.

As is well known, "humanizing" is the slogan of today's architecture. After the rationalistic solutions of form and the social theories of the thirties, there are prominent today different trends designed to infuse life and an irrational factor into the architectural surroundings of people, such as were missing in functionalism after the early enthusiasm waned. It was surprising to

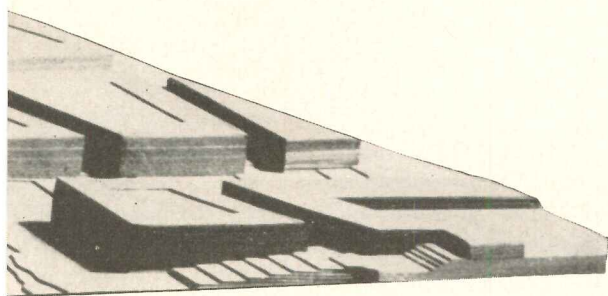

*Yrjö Lindegren & Erik Krakstrom:
Central Area Plan, Helsinki*

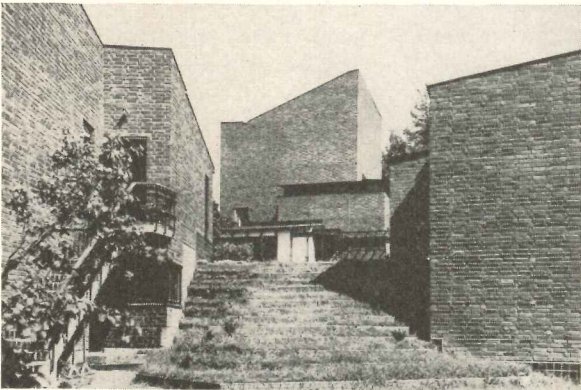
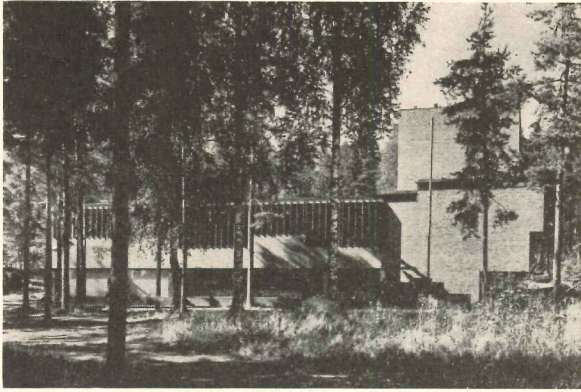

Alvar Aalto: Civic Center, Säynätsalo

FINNISH EXHIBITION

Schildt (continued):

hear Professor Chernyshev, Vice President of the Soviet Academy of Architecture, who had visited the Exhibit, declare that the architects' program in present-day Russia is to create, as a reaction against the constructivism of the twenties, architecture that is primarily human. The fact that Moscow University seems to us to be a prototype of non-human architecture is another matter; the setting of goals is the interesting thing. Western architecture strives toward the same ideal in entirely different ways, although — for it — the functional and social benefits inherited from the thirties form a natural basis of departure. A solution — which, with some generalizing, one is tempted to call an Italian solution — implies that to the free esthetic shaping is connected the exaltation which can be accorded to the milieu by an effective plastic treatment of space and volume. A great deal has been written to prove that all good architecture is functional. However, to see something functional in a Greek temple or in a Gothic cathedral, the idea of "function" must be given so wide an interpretation that it is difficult to exclude from such a concept either the Town Hall in Stockholm or the Vittorio Emanuele Monument in Rome. It is apparent, finally, that it is the quality of the *feeling* created by a building which decides its significance, while the practical requirement of function is merely a primary condition of necessity.

In Sweden, also, it has become clear that the saving of several housewives' steps and the lowering of the rent are not adequate goals for architecture. In this situation there is a temptation to resort to something which we are tempted to call the "people's home solution"; well known also in Switzerland, Holland — and with some short-sighted architects in Finland. It signifies "humanizing" by way of a polished *petit bourgeoisie* and a playful artistry in trivial art-making, which causes so many newly-built city sections to be pitifully dull and impersonally sterile. For the truth is that it is not sufficient, nor even necessary, to live practically and comfortably. It is necessary, however, to live in surroundings in which the human being, with his irrational soul, his capacity for ecstasy and sorrow, and his confinement to a community — can feel at home and contented. The old sections of European cities have generously offered all this, and architects have consequently long been able to occupy themselves with reconstructing and attaching neutral complements to such existing pieces. Perhaps this explains why Finland, so poor in examples of the older art of building, has felt more powerfully than other countries the need to change functionalism into a truly human art of building. It is far out in the Finnish wilderness, among the pines, that the world's perhaps most inspired modern monumental building has risen, Alvar Aalto's little Town Hall in Säynätsalo.

THE EVOLUTION OF A HOUSE

An architect and his client review the planning and design of a summer residence in Stockbridge, Mass.

John MacL. Johansen, Architect

Dr. Alice McNiff, Owner



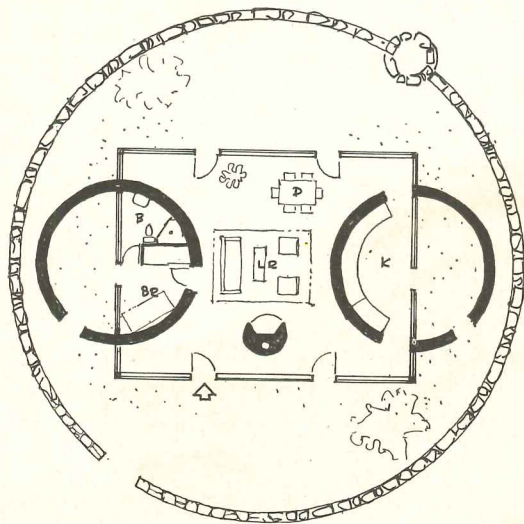
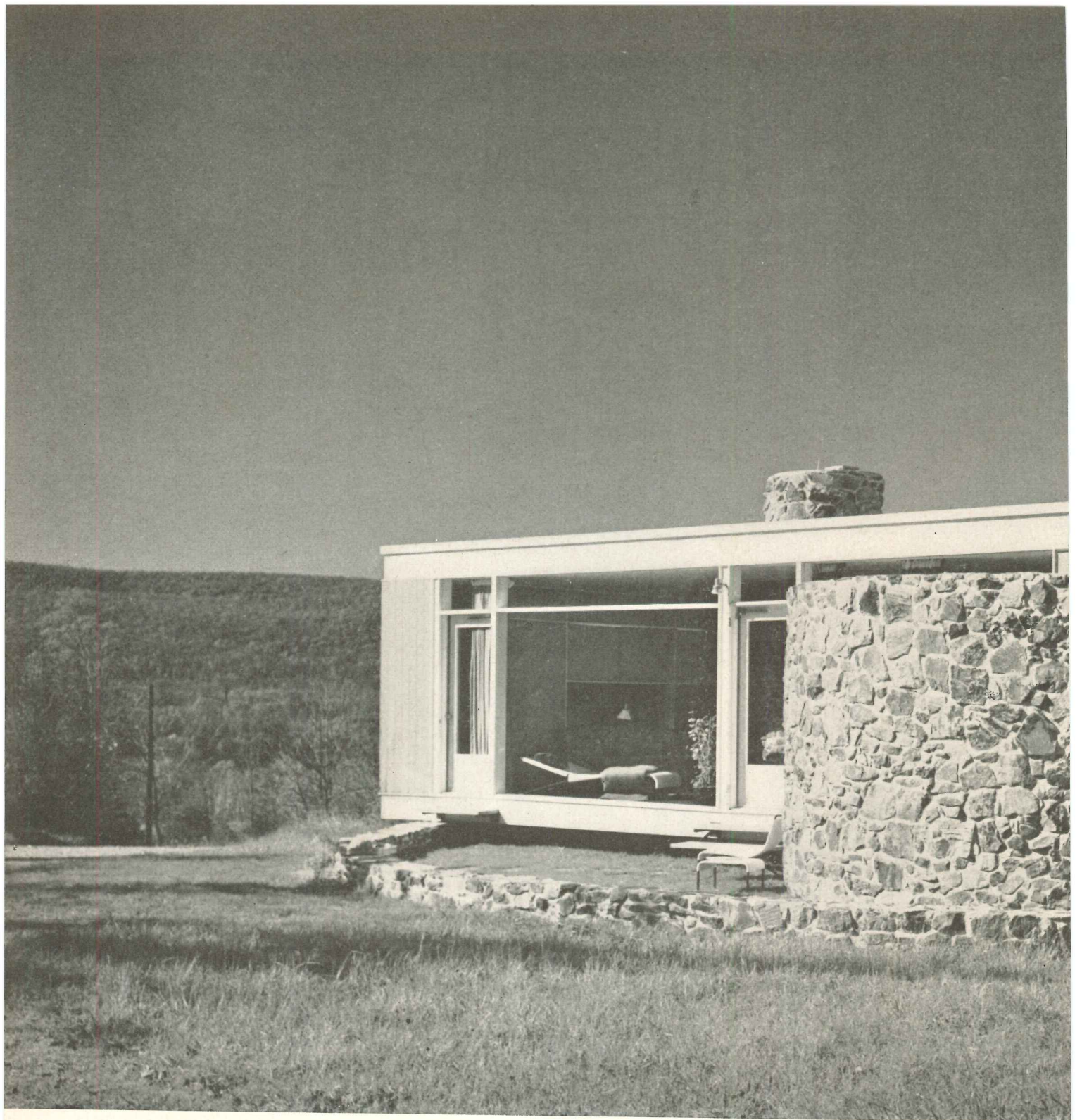

Scheme #1 abandoned
Too balanced & formal
The 2 circles compete



All photos © Ezra Stoller

THE PHOTOS OF THIS HOUSE do not require much study to prompt a series of questions: why the circular terrace, the circular stone chimney, the exterior-interior circular wall? Architect and owner were queried and revealed the following background.

The owner, Dr. Alice McNiff, an assistant professor at New York University, had an almost impossible list of site requirements: the site must be in the Berkshires,

close enough to New York for weekend commuting and near Tanglewood, home of the Berkshire Festival; it must also be on a mountainside, facing west for the sunsets, and on or close to a lake. By great good chance she found exactly the property she wanted — 24 acres overlooking the lake and grounds of Tanglewood itself.

Next came the choice of an architect. Dr. McNiff had decided on a contemporary house (although she admits she was “rather afraid of it” for Stockbridge) and was

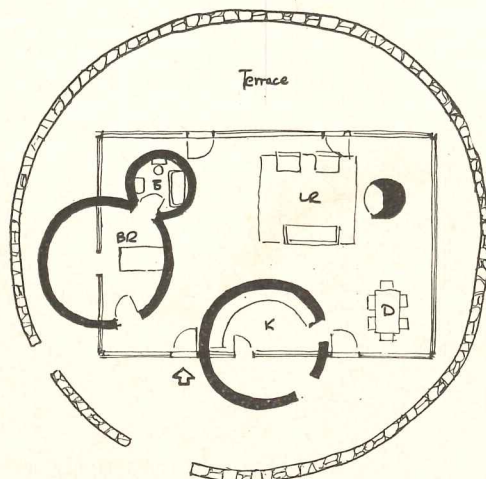

Scheme #2 abandoned
 too large
 " complex
 " expensive

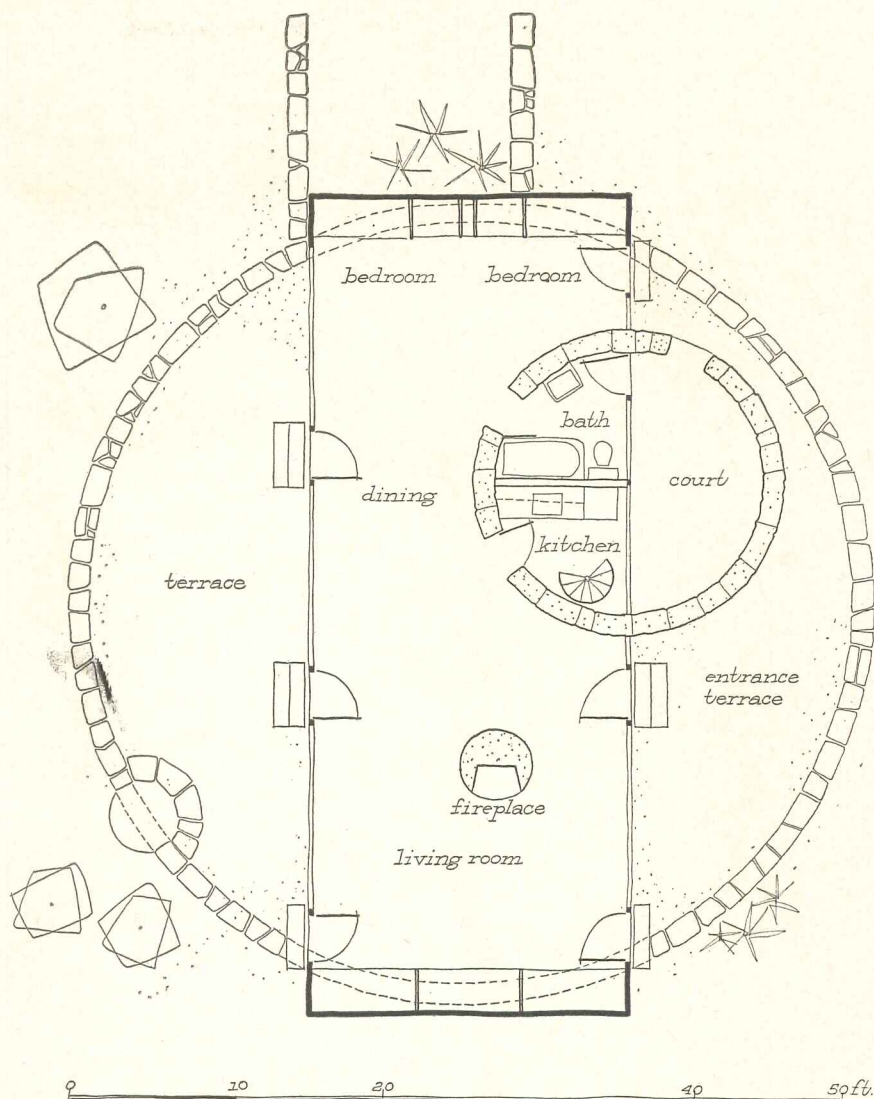

particularly interested in the "simplicity and serenity" she had found in houses in the vicinity of New Canaan, Conn. Again she was lucky: a single inquiry put her in touch with New Canaan architect John Johansen, who had summered in the Berkshires every year since he was three years old and who knew her mountainside well.

"All I told him," Dr. McNiff relates, "is that I wanted easy upkeep, a really tiny kitchen, a tiny bath-

room, as much stone and glass as possible, and as little wood as possible; room to sleep four people; no unnecessary walls; and a definite boundary for the lawn."

The architect, Mr. Johansen, says: "the general idea, was one of compartmentation of functional areas (inside and outside) from each other — static space for those enclosed, fluent space for those left between. The house is basically one large room, 50 ft long by 20 ft wide,

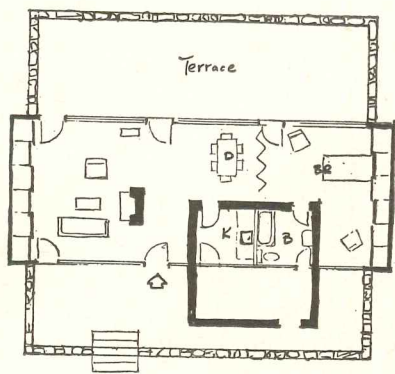

Scheme #3 abandoned
works well but
less pleasant in
rectangles than circles.

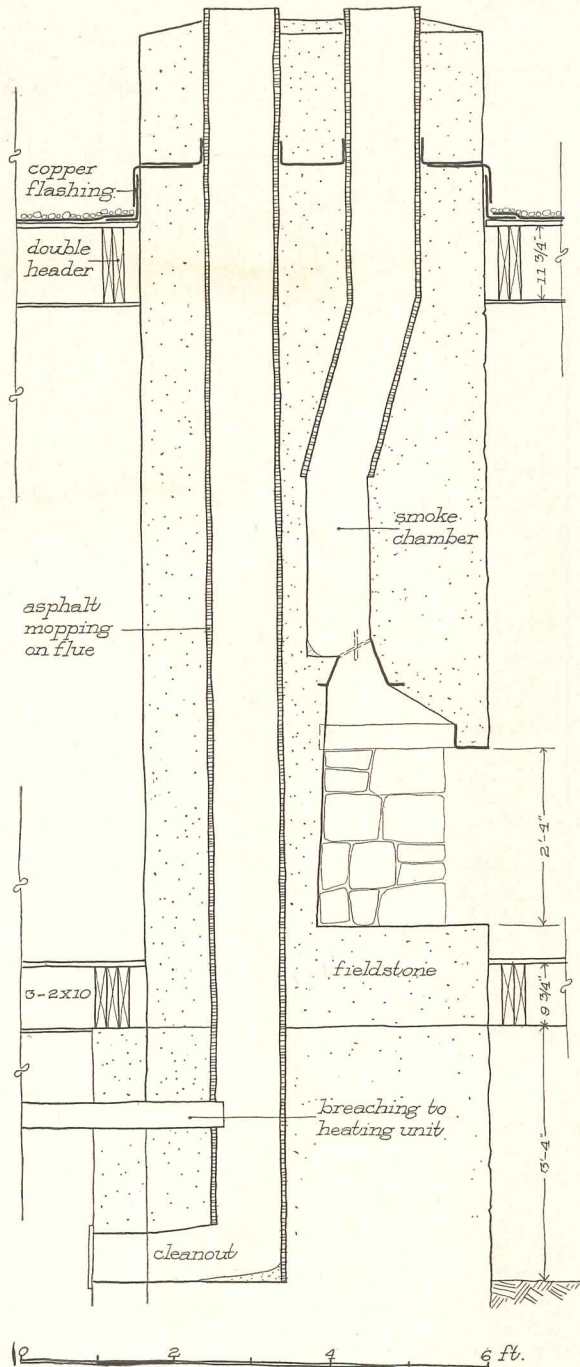

with a folding partition to close off the sleeping area. The long walls are floor to ceiling glass; solid end walls form 20-ft storage cabinets.

"The three stone circles with the rectangular building," the architect continues, "form the architectural composition. The largest of these is the low garden wall. This expresses dramatically the separation of rough, natural landscape from the cultivated terrace areas. The higher stone ring is half inside the house and

half outside; inside enclosing the bathroom and kitchen, outside a sun bathing court and shower. The third circular element of stone is the chimney. A circular stair leads from the kitchen down to laundry, storage, heater room and garage."

Four preliminary studies were made before Mr. Johansen showed his client even a rough pencil sketch. The first three of these already had been abandoned by the architect for various reasons (see his notes and

THE EVOLUTION OF A HOUSE

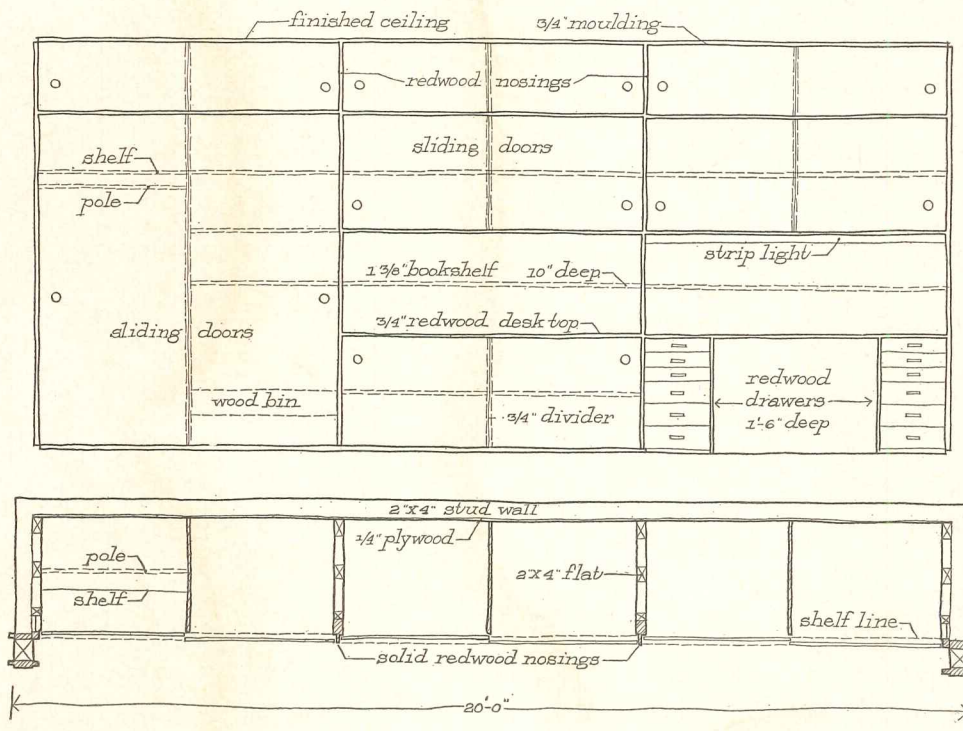
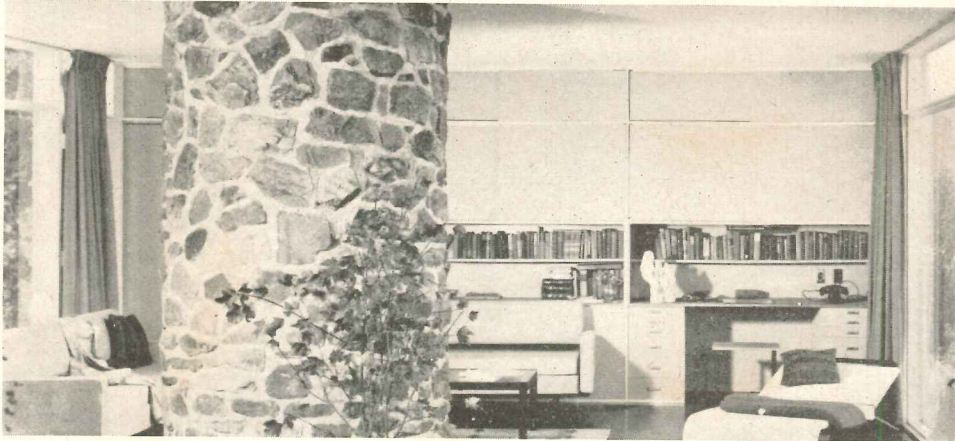

sketches, pages 170, 172 and 174). The fourth study, which was immediately adopted, "incorporated the strictly minimum, functional plan with the easy, informal use of the curved format." A 1/8-in. scale model was built for study of proportion of space and mass.

The budget was a moderate one, and had to be adhered to rather closely. When preliminary bids came in some \$4000 too high, both owner and architect were so discouraged that they began to talk of a less expensive all-frame house. Fortunately, however, the architect was as enthusiastic as was the owner about the proposed

design; he re-studied the plan carefully, going over material and labor estimates with a new contractor, and, by coordinating the subcontracts himself, succeeded in bringing the construction cost down to the budget figure.

Construction problems centered on the unfamiliarity of local workmen with contemporary design: considerable schooling was required, with constant citing of successful similar construction in the New Canaan area, and one contractor even journeyed to New Canaan for first-hand verification. Construction proceeded smoothly, however, and to everyone's satisfaction.

Ernest Braun



A WORKSHOP FOR EXERCISES IN HOME ECONOMICS

Home Economics Building, University of California at Davis





Lobby's glass-panelled wall contrasts by day and by night with 20-ft bays of classroom, laboratory and office wings at either side. Fins are

actually part of building frame which with extended ceiling and slabs make effective sunlight control, essential in area's climate

HOME ECONOMICS BUILDING

Hervey Parke Clark, John F. Beuttler, Architects

Lawrence Halprin, Landscape Architect

Henry J. Brunnier, Structural Engineer

Keller and Gannon, Mechanical and Electrical Engineers

Erbentraut and Summers, General Contractors

TWO FACTORS especially governed the design of this Home Economics building for the agricultural campus of the University of California. One was to provide a building "whose friendly atmosphere would have the inviting quality of openness which an attractive home has" — no mean feat in a building of this size. The other was to dispose the elements of the building for the best possible natural light.

A further factor was the climate of the locality. Davis is in California's Central Valley, where hot weather

starts early in the year, and temperatures by mid-summer go as high as 110 deg, and lasts until late fall. A comfortable building in such a climate has to be one which is cool for the greater part of the year.

Essentially a "workshop for exercises in home economics," as the architects characterize it, the building consists of classrooms, laboratory facilities, offices and one large lecture hall located where it is easily accessible from other buildings. Neither of the elements usually used to provide a "homelike" atmosphere in home

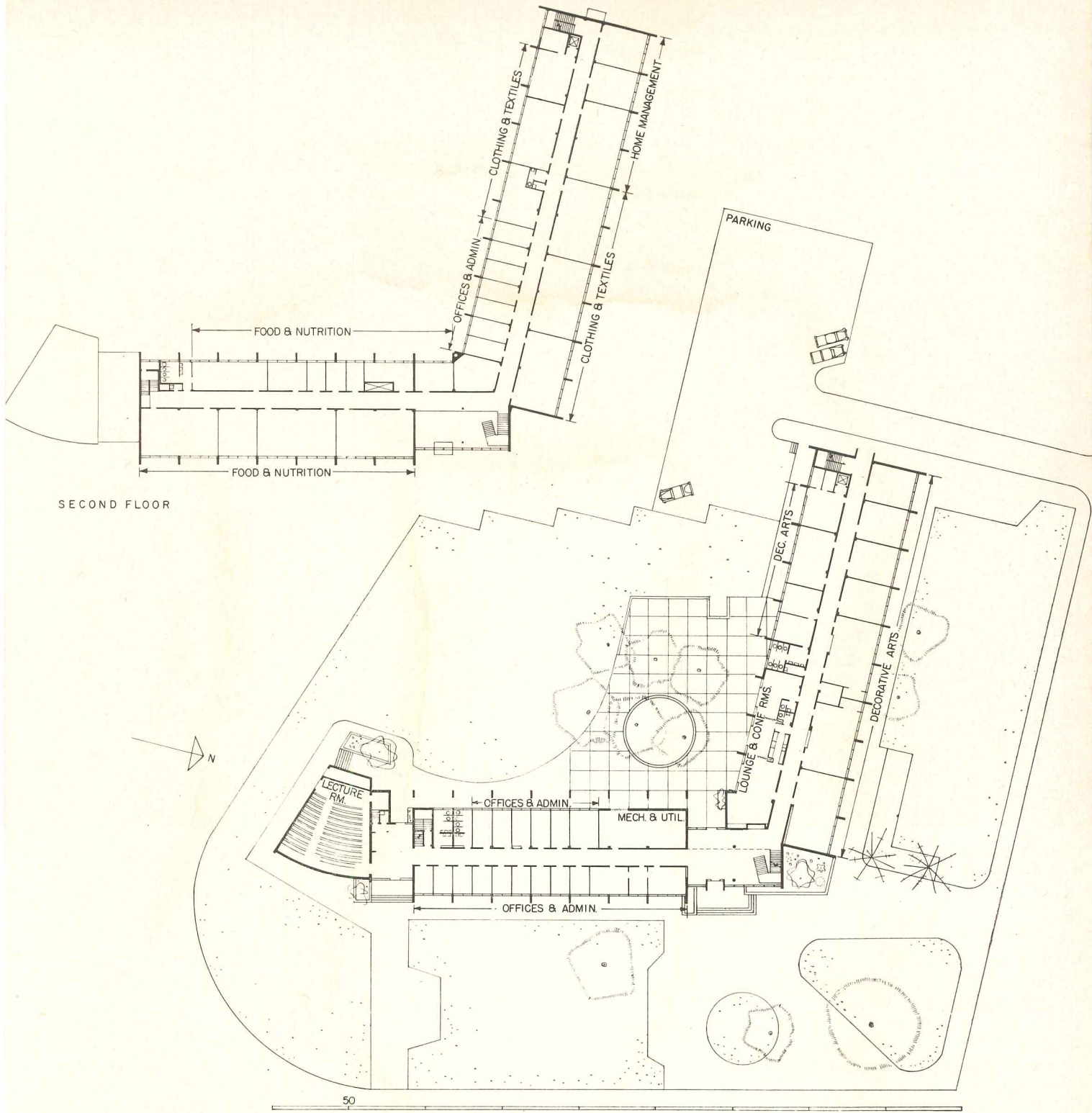

Ernest Braun

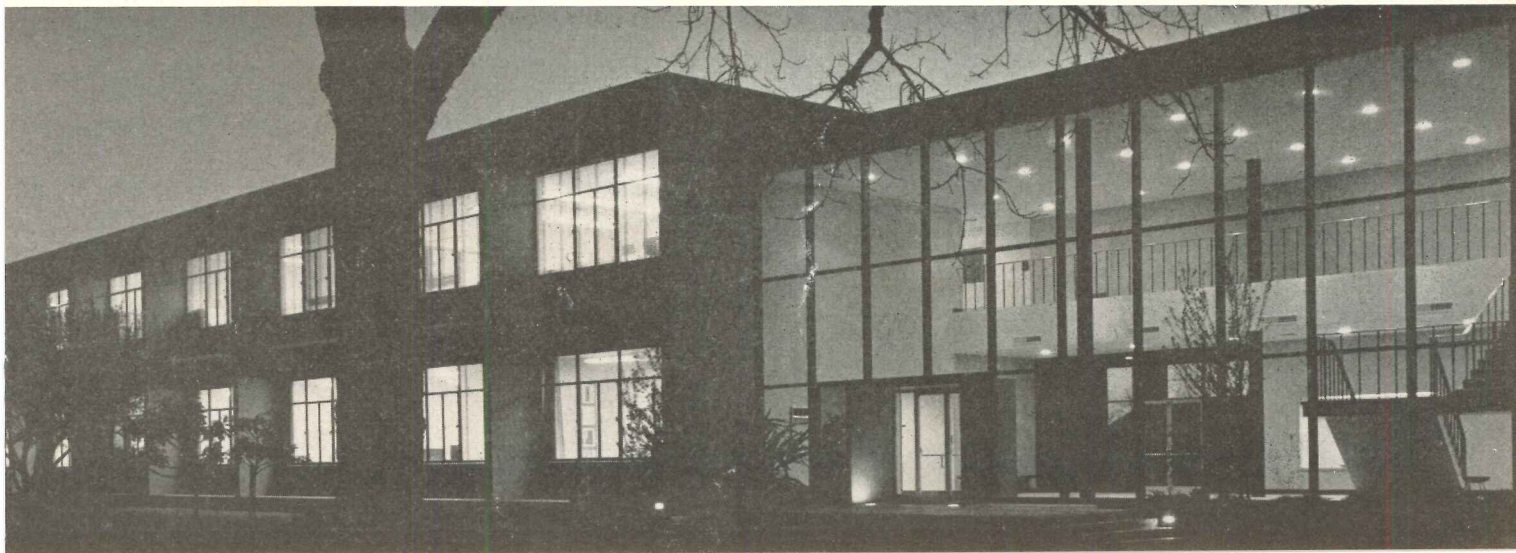

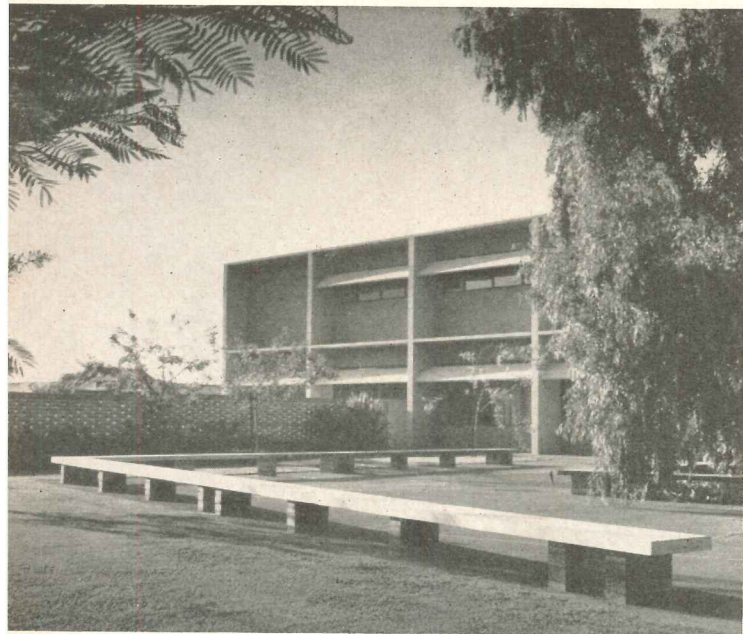

Landscaping is simple, consists largely of low-lying shrubs and flowering trees. Program called for lobby with as much residential character as possible, providing "gracious, informal atmosphere" in keeping with building's purpose. Laboratories like home management one (bottom) are important part of building's facilities

HOME ECONOMICS BUILDING

economics buildings is present in this one, since the nursery school (for child development courses) is in a separate building, and separate home management houses will be used instead of an apartment in the main building. The informal, casual character of the building, so important a part of the program, is obtained through the careful organization of the plan and consideration of such fundamental architectural qualities as repose, scale and proportion.

Some departments, particularly decorative arts, clothing and textiles, require detailed work in good light. These departments were located where they would receive north light. Offices and food and home management laboratories have east light. Those offices which are located on the west side are placed on the first floor under a 9-ft overhang which protects them from excessive heat and sunlight.

The building's exterior appearance results directly from the integration of the structural system with some of these climatic control devices. Reinforced concrete was an appropriate and economical solution to the structure and a 5-ft module proved a further means to economy since it made possible a framing system based on 20-ft bays. The structural columns in this system are shaped as long, narrow fins which extend 4 ft from the building face; these, and the floor and ceiling slabs, form the major part of the sunlight control system. Large exterior louvers on the south and west supplement this system.

"The building not only is cool," say the architects, "but looks it." In achieving this, color was an aid: fins and slabs are natural concrete color; walls above and below windows are gray-green stucco; horizontal louvers are yellow. Garden walls, seats and plant boxes are buff-colored concrete block.

Since sub-surface water conditions made large basement areas inadvisable, the mechanical equipment for the forced air heating and ventilating system is in the east wing of the building. Each room has its own temperature controls. A constant temperature room, used by all divisions, provides a fixed temperature at all times, under all conditions, for special experiments.

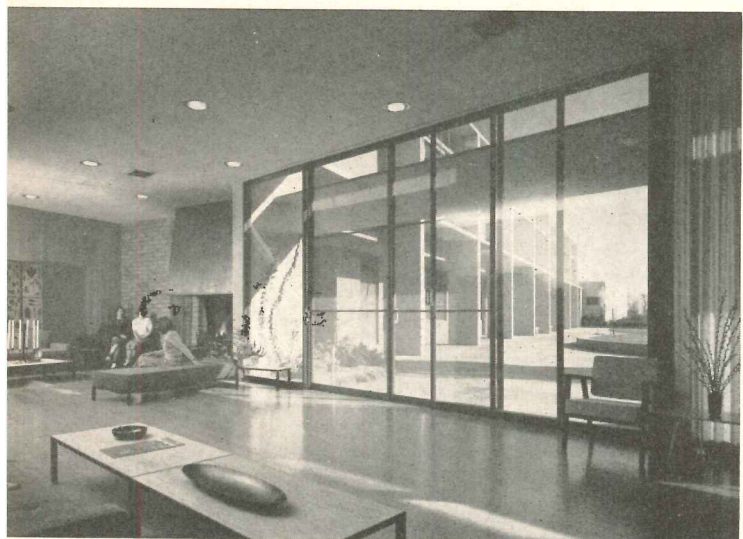

Ernest Broun

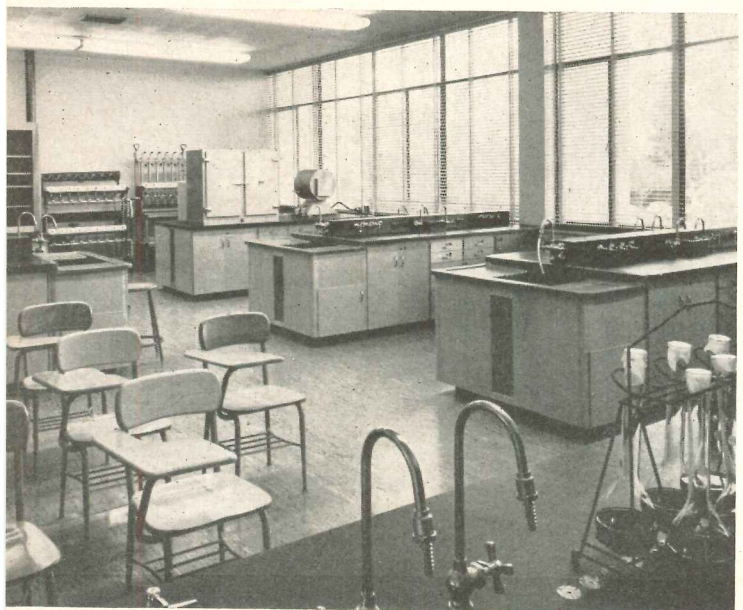

INDUSTRIAL BUILDINGS

Factories—Warehouses

MORE AND MORE INDUSTRIAL BUILDINGS are the outlook for this year. More factories, more warehouses, more service buildings, more of everything. Economists of the F. W. Dodge Corp. (*ARCHITECTURAL RECORD*, Nov. '55) estimate an increase of 12 per cent over the already high levels of 1955.

While such an increase must of course represent expansion of industrial production, it is important to realize that new buildings result from other factors. Industry's ever more intense effort to cut costs hurries the process of obsolescence. It is getting almost to the point where a new factory building, like a new automobile, is already obsolete on the day it is first used — the new model is already on the way.

Architects and engineers are of course heavily involved in this process, not only because they design the new buildings, but because they are part of the cost-cutting team. Building costs are justified by economies in production, distribution or handling; building costs are in a sense less important than the others. A factory building is merely one part of a production machine, its purpose and its useful life determined by manufacturing processes. If the artistic side of architecture is still important, and it is, the functional aspects of the building are its reason-for-being.

This Building Types Study takes for its theme one of the more important of industrial cost-cutting approaches; the scientific handling of materials in the whole process of manufacturing and distributing goods. Materials handling necessities intrude in every operation of manufacture, every step of distribution; they represent perhaps the major avenue toward cost cutting. One materials handling expert cites as more or less typical the case of an automobile window frame: it has five parts, goes through 37 manufacturing operations, is handled 208 times and has 198 temporary storages. In another instance a specialty part was worked on for a total of 10.5 hours but the manufacturing process required 220 hours. If it is this sort of analysis that lends attractiveness to the word "automation," it is also this kind of thinking that determines the need for and design of new buildings. In the new group of buildings for Johnson & Johnson (page 182) it was largely this type of thinking that changed the original concept from one large square building to four separate ones.

In recent years industry has discovered that the same thinking works the same way in the distribution and warehousing of manufactured goods, and we are seeing a new crop of "streamlined" warehouse buildings. Some say indeed that the handling and sale of finished goods is a newly discovered gold mine, since it costs almost as much to get the product to the consumer as to make it, and distribution has not had the same efficiency study as production. There is a whole science of warehousing, complete with warehousing consultants, and warehouse buildings are now following earlier trends of factory buildings — single story layouts, away from congested centers, with fancy mechanical systems, electronic paper work, even radio-controlled lift trucks. Planners are now working on the automatic or push-button warehouse.

Decentralization is an accompanying trend which seems to be intensifying. As factories go farther afield from metropolitan centers, so do warehouses. Truck transportation makes its contribution to the decentralization.

All in all, it means that more and more architects, in more and more places, will be learning more and more about factory and warehouse methods, and building more and more buildings.

— Emerson Goble

JOHNSON & JOHNSON TAKE A LARGER LOOK

*New Manufacturing Center
North Brunswick, New Jersey
Walter Kidde Constructors, Inc.,
Designers and Builders*

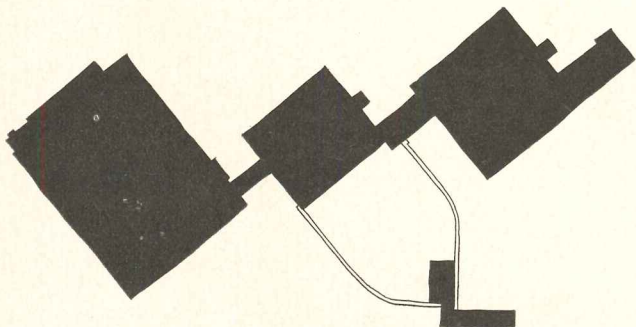

WHEN AN INDUSTRIAL CONCERN like Johnson & Johnson, famous in architectural circles for its enlightened concept of industrial buildings, changes its collective mind, that is news. And when the change produces so interesting a scheme as is now in construction, the news seems worthy of attention.

For many years the growing group of factory buildings of J & J has been the subject of many presentations in architectural magazines, with glowing reports of high standards of design, functional efficiency, consideration for the welfare of workers, autonomy of individual enterprises, beautiful landscaping, large sites in decentralized locations, and so on. Most of these concepts they still hold valid, and will continue in the new manufacturing center at North Brunswick, N. J. Nevertheless the new center represents new thinking; if it does not change the old it adds substantially to it.

What it amounts to is that their building program was beginning to grow beyond its previous bounds. Expansion needs were coming faster than could have been anticipated; some still sparkling new plants could not be sufficiently expanded. Their large sites were not large enough. Their older buildings — especially the ancient group at New Brunswick — were forcing expensive operations of a shoe-horn nature. There were growing strains in management, production and distribution. It was time to take a larger look.

One of the theories that suffered in this process was decentralization. A small plant, in its own location, with its own autonomy, its own group of workers, its own proud building — this was all very nice up to the

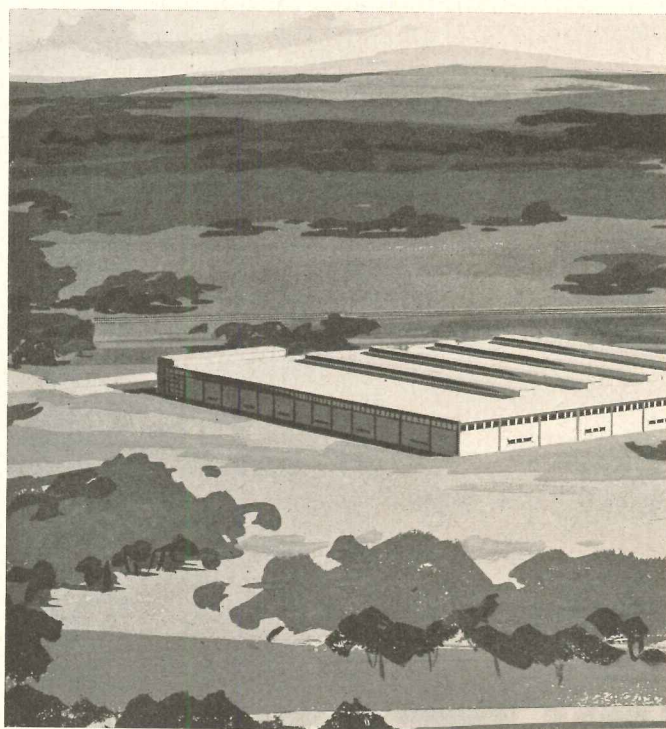

point where the seams burst. Then most of those advantages were lost in another move.

The new center will regroup certain of the manufacturing operations, and the shipping center, with a large enough site and a large enough concept to offer hope for some years of stability. It certainly does not represent the centralization of all J & J operations, far from it, but it may eventually become the home base, with new office buildings to replace the age-old home group at New Brunswick.

The rather radical grouping of buildings results from a similar rearrangement of thinking applied now to buildings. It did not arrive as a full-blown inspiration but grew laboriously out of months of effort to fit together many divergent processes and considerations. A few of the major changes in concept are shown in the diagrams on page 186, but it is reported that these are but a few out of dozens of tries. Those most active in this jigsaw puzzle process were: for J & J, C. V. Swank, Vice President, Manufacturing; L. J. Bardsley, Assistant to Vice President, Manufacturing; Nason Manley, Director of Construction Services; and for Walter Kidde, Frank L. Whitney, Vice President, and John Faas, Chief Mechanical Engineer. Whitney will be remembered as the project architect in charge of the Corn Products Refining plant at Corpus Christi, the one that is half-building-half-machine (*ARCHITECTURAL RECORD*, Nov., 1949).

Here again the solution came out of thinking of buildings as machines. The diagrams illustrate quite graphically the mental switch required in this instance. The

group started, not unnaturally, with a plan of A BUILDING, a building to house what they wanted to put in it. The idea of a single building seemed to offer so many logical advantages and economies (one big square building was obviously the least expensive) that a long time was spent trying to realize those benefits. Gradually it became apparent that the advantages were more theoretical than real. There were always compromises involved in just staying within building walls.

Suppose we think of this, they then decided, not as a building but as a theoretical layout of processes on a limitless site without any walls. Now move toward an ideal scheme, working out all systems of handling materials and finished goods, all similar considerations, then see where you want the walls. Now start drawing walls, roads, spur lines, all the rest. Now what do you have? Then double all the operations; where would the walls go then?

Stripped thus of all practical problems and sketched out as a theoretical approach, it all seems much easier to comprehend, and the switch in thinking doesn't seem too radical. Industrial architects generally report, however, that complications usually are so many, so real, as frequently to block this basic kind of total planning. It is indeed the conventional idea that all sorts of manufacturing operations are stuffed into one building shell. All manner of process engineers will work out their mazes of machines, pipes, conveyors, wires, and almost always think in terms of putting them under one roof. And at some point the building is frozen by considerations that the architect may or may not be allowed to

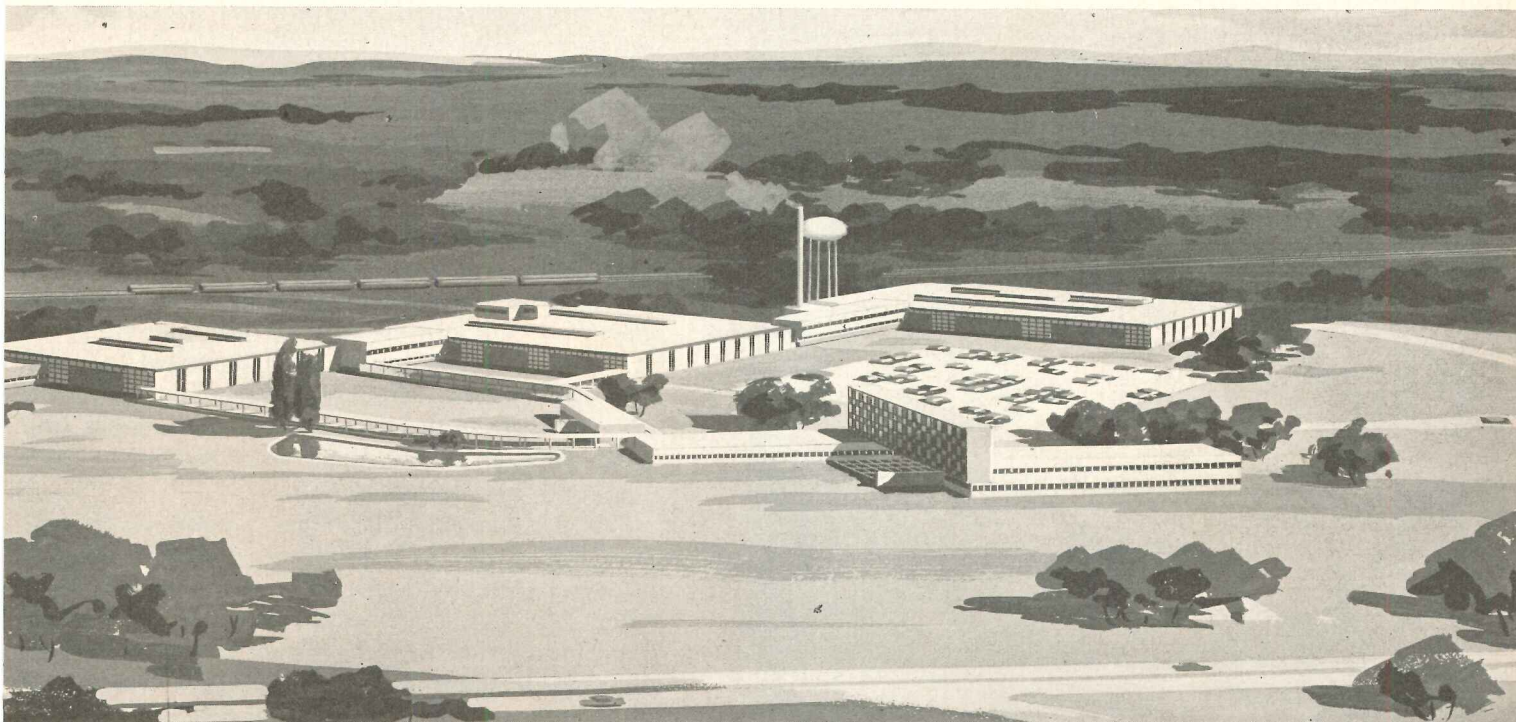

Site for the Johnson & Johnson manufacturing center is 275-acre tract in North Brunswick Township, N. J., lying between the main line of the Pennsylvania and U. S. Route 1. Initial program calls for three main buildings, two for manufacturing, one a shipping center, plus cafeteria and auditorium building. Another factory building may be added later, also possibly a new home office building. Present program totals 600,000 sq ft; largest single building, 285,000 sq ft. Construction has already begun; first occupancy is scheduled for Fall of 1956, completion of initial group during 1957.

Fairchild Aerial Surveys



tinker with. Industrial problems range, for architects or construction engineers, from those in which they are called upon to plan everything, including materials handling, to those in which they can plan nothing but the enclosing shell.

It is odd — still philosophizing — how difficult it is to assume much freedom of thinking about buildings for industrial purposes. Buildings are fixed, permanent fixtures, that take recognized shapes and styles and conform to fixed regulations. They acquire intangible qualities, maybe even an institutional sort of veneration. To a certain extent, of course, there are solid reasons why buildings are not junked like other parts of the assembly line. But it seems generally true that buildings are supposed to escape the rapid obsolescence that is so well accepted for machines. Certainly they will not escape obsolescence unless they are conceived with fullest possible freedom and imagination.

In the J & J instance the single-building scheme was given a thorough shakedown before it was abandoned. A more detailed story of factors involved is given with the diagrams, page 186. Oddly enough it was a materials handling development that broke the dam wide open. While testing various layout possibilities (in the single building) the planners were also studying routes for a dragline conveyor, a sort of all-purpose trolley line doing most of the intraplant railroading. When they began to think of separate buildings they realized that the dragline could just as well go any place as be confined with certain walls. It could go from one building to another, and back again, and the only extra expense would be in the length of the line. Time of handling was not a real factor: time would only be costly if factory personnel had to do the driving. If loaded trucks could ride the line unattended (and of course they always do) why bother about a little more time en route?

Now we are getting places. We can plan our in-process handling as we like, free from worries about bulk-distance calculations on either raw materials or finished goods. Now we can plan buildings as we really want them.

But one minute. What does this do to our building costs? Walls running all over the place!

The answer was easy enough — there was almost no difference. Outside walls were much longer, of course, but inside fire walls were virtually eliminated. And since there was little cost differential between inside fire walls and exterior walls, there was little to choose either way.

But one more minute. What about people? Are they all going to have to ride bicycles?

This question caused little more trouble. In the first place, it is not people but things that travel the longer distances. Most of the people stay at relatively fixed stations. In the second place, distances to cafeteria building proved to be little greater than from one end of a single building to the other. Perhaps more people will have to walk that distance, but they will probably

like this walk, since the separate building set in the park surroundings should offer a pleasant interlude, more pleasant than eating within the manufacturing plant walls.

Now the advantages of separate buildings began to roll out rapidly:

1. Expansibility comes first. With the buildings placed as they now are, each operation can expand in two directions as occasion demands. This expansion can be independent of other operations, forces nothing to move out of its path. Moreover, expansion will be in the easiest directions, forcing no disturbance to machines already operating (see diagrams).

2. J & J favorite theory — autonomy of separate manufacturing divisions — is maintained automatically. This is a consideration for labor as well as for management.

3. Closely allied to autonomy is scale of operation, and this too applies to workers as well as management. The separate building scheme cuts scale to humanly comprehensible proportions.

4. Strictly factory office areas and control laboratories are kept out of manufacturing buildings; they are in the connecting links between buildings, close to opera-

tions but out of the way of future layout changes.

5. There is greater flexibility for scheduling incoming shipments of materials. Theoretically, with three separate spur lines, one to each building, it will be possible to eliminate raw stores space. Whether or not this is ever practically possible, the three spurs help.

6. At one point it was considered disadvantageous to separate raw stores areas, as J & J wanted to consolidate controls. But some study indicated that physical separation was a small factor in control, and that this was more than offset by better handling of materials to processing machines.

7. Last but not least — several separate buildings give much more opportunity for architectural expression. Architectural attractiveness, always insisted upon by General Johnson, is difficult enough with a group of flat buildings of great size, but what would one do with a great square pancake? Now there can be some compositional effects, some relief in size and height, some logic and purpose in fenestration, some chance for color, some scope for Labatut's landscaping (yet to come). Some chance now for what J & J always want, an industrial development to arouse feelings of pride in management, workers, and in fact the whole community.

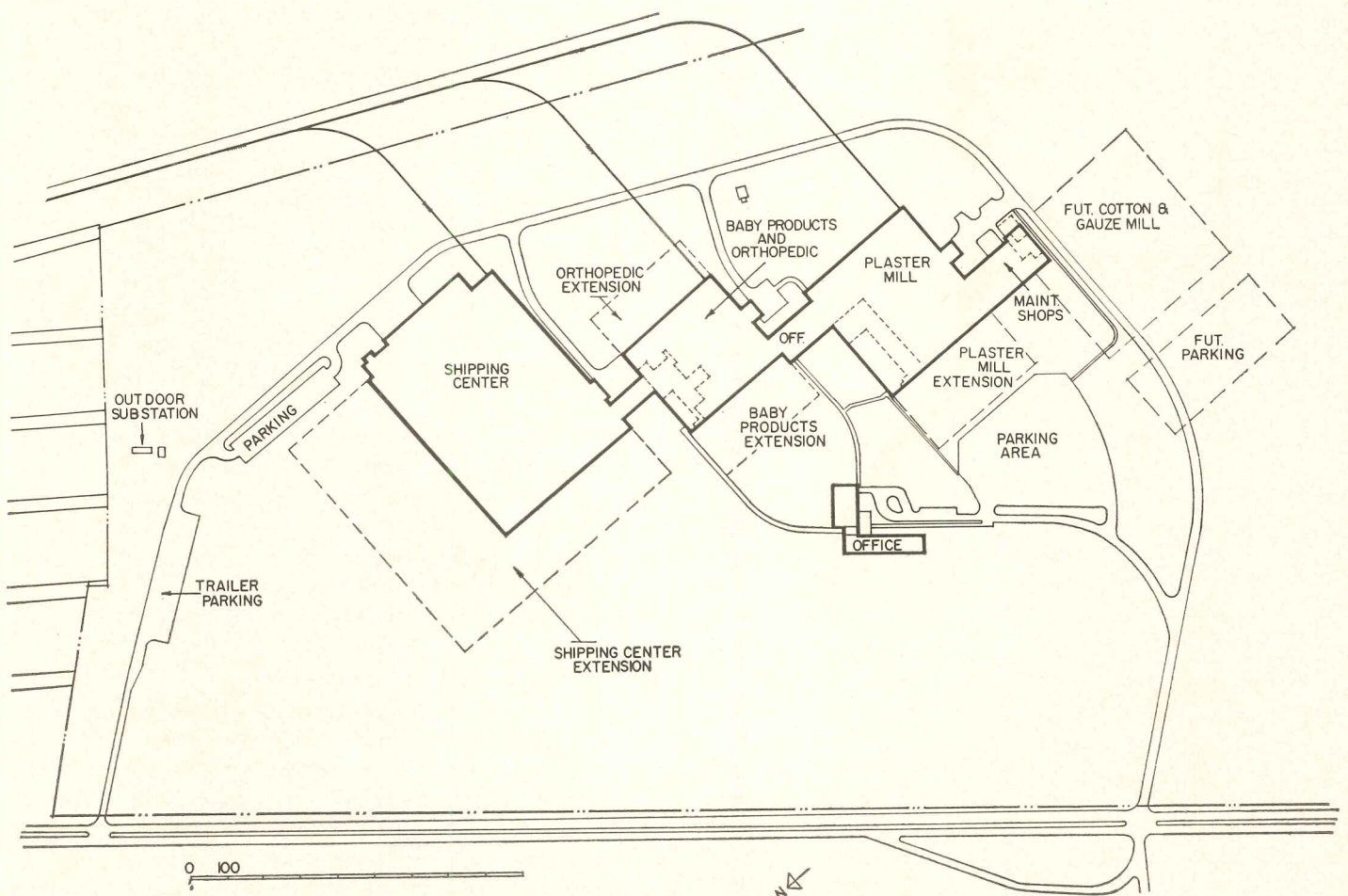

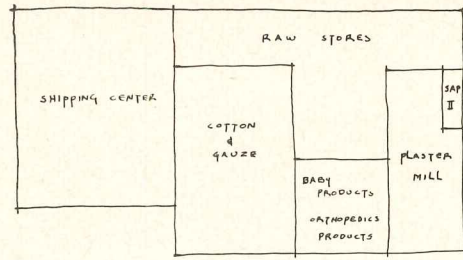

FIGURE 1

Figure 1 represents about the best that could be done with a single building, at about the time the Kidde men were called in. Expansion is obviously restricted; moreover any possible expansion would cause much moving, would be in wrong directions. J & J wanted incoming rail shipments to be so scheduled as to minimize storage and handling of raw stores, but a single spur line here would make that difficult.

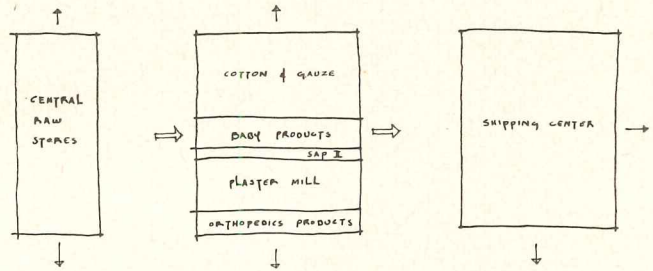

FIGURE 2

Figure 2 shows an early try at separate buildings, with an attempt to centralize all raw stores. But handling of stores to manufacturing lines would be difficult. Expansion possibilities better but still by no means good.

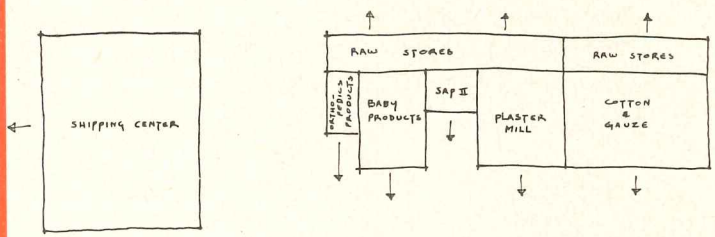

FIGURE 3

Figure 3 is an attempt to keep raw stores together but also adjacent to manufacturing operations. But growth of stores area would be away from machines. Good freedom to expand manufacturing lines, but stores and machines growing apart. Single rail siding still a problem. An advantage in that stores areas are together, hence are flexible.

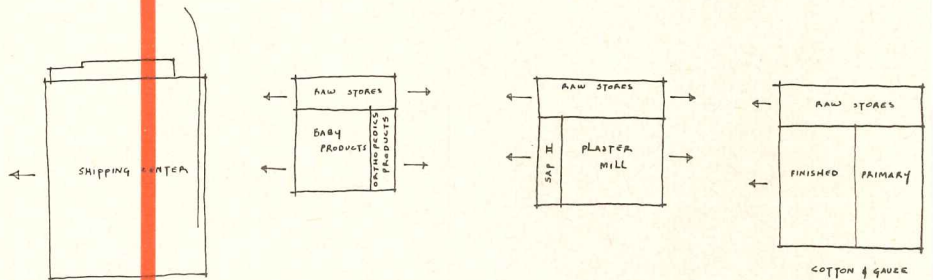

FIGURE 4

Figure 4 is getting close. Stores and machines are close together, and stores areas can grow parallel with manufacturing. Separate rail sidings now possible, but directions make sidings awkward.

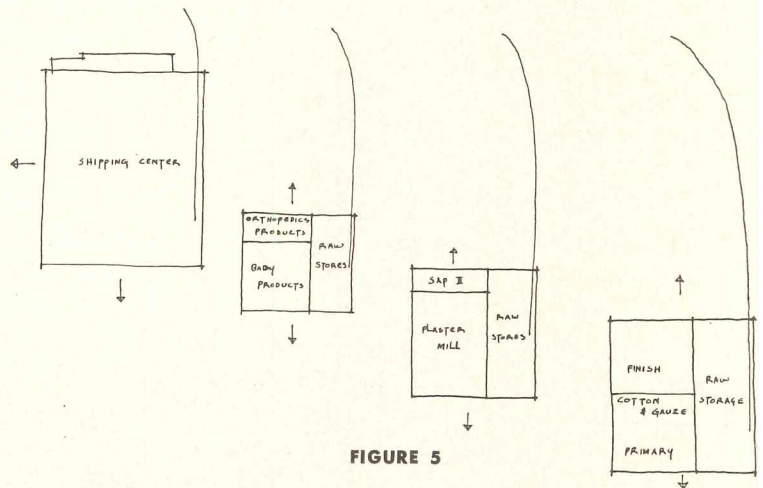
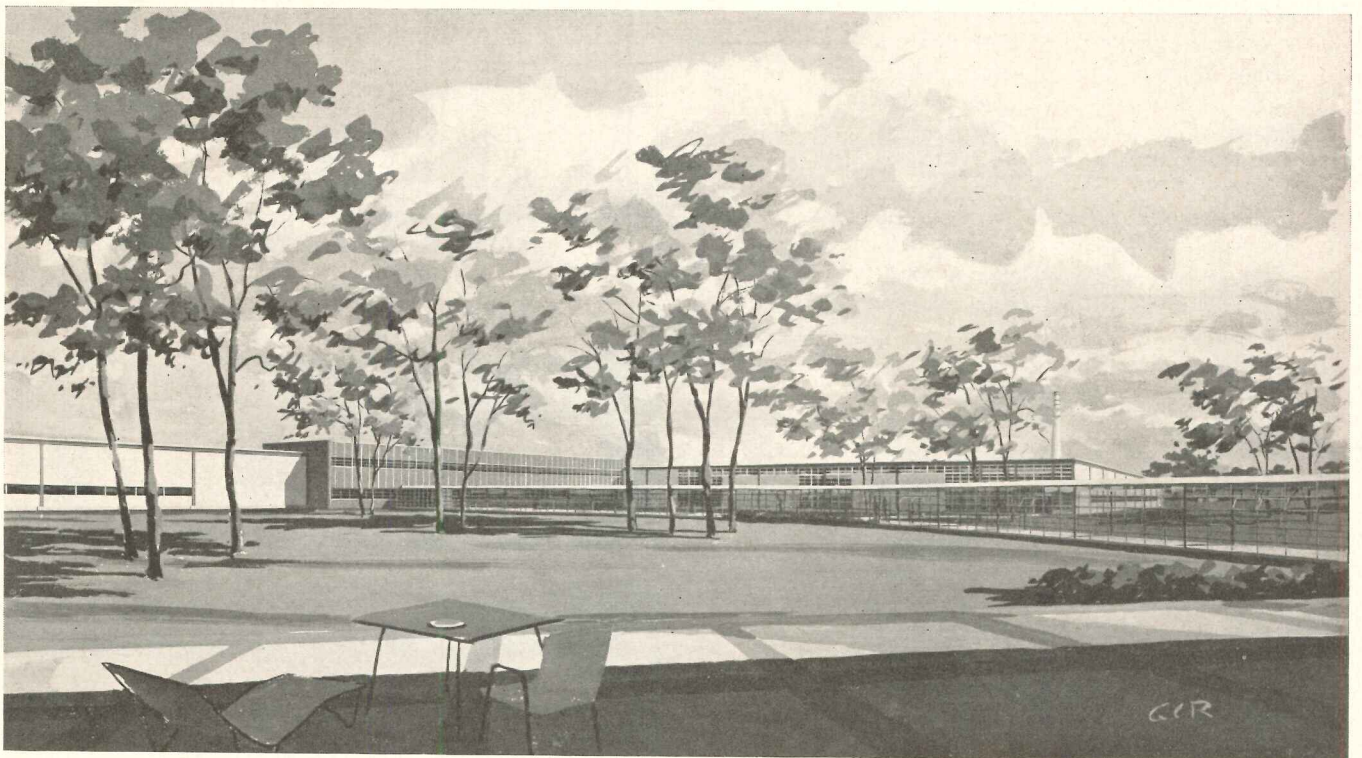
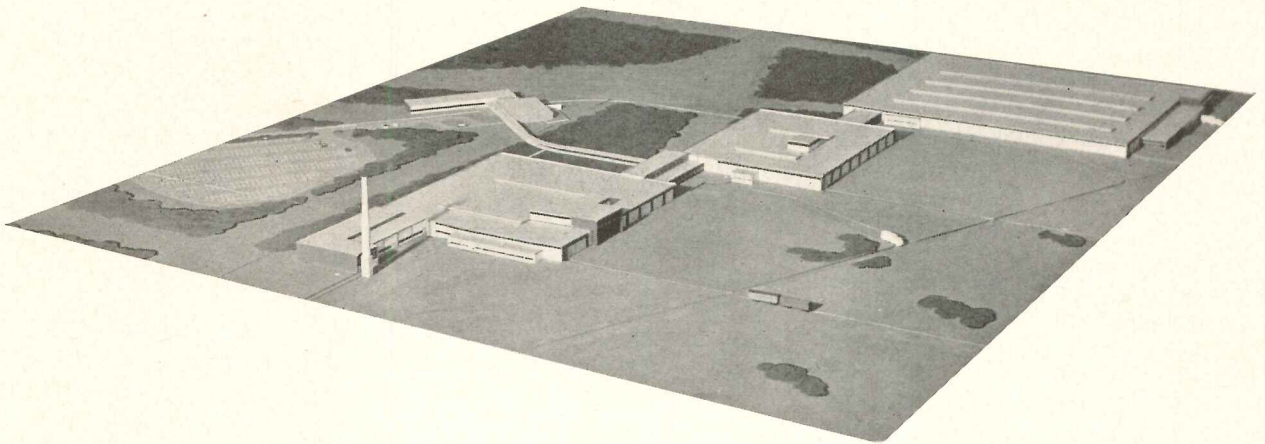
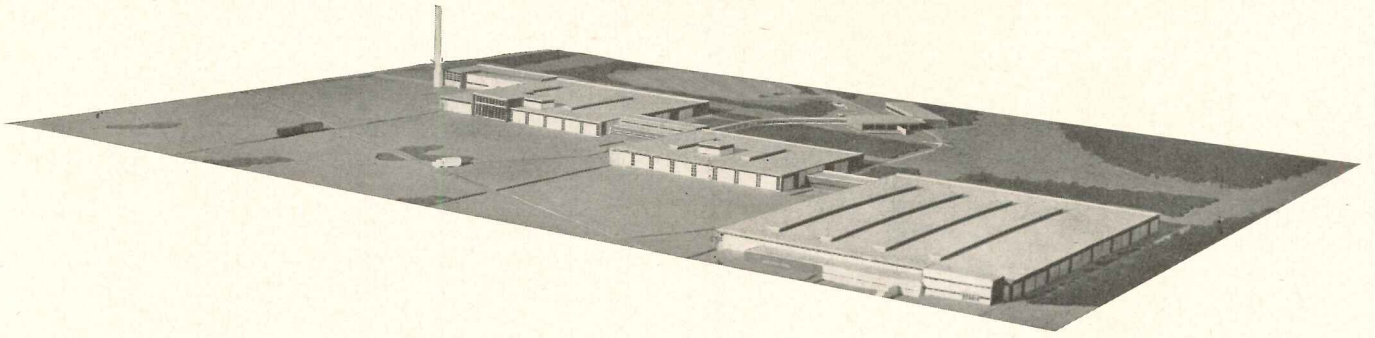

FIGURE 5

Figure 5 is mission accomplished. It is same as Fig. 4 except that building layouts are turned 90 degrees to get rail spurs in easiest directions, and buildings are staggered to take logical positions on route of dragline conveyor which connects them all together.



In this instance both client and architects agreed that fenestration should be rather intensively studied. J & J always wants daylight, not for lighting but for psychological effect. This desire even explains the monitors, though as a matter of fact the monitors proved very useful for enclosing a variety of vents and ducts that would otherwise clutter up the roof, and for fire-control vents. In any case, the architects took some pains over fenestration, as suggested by the elevations at the right. The sketched elevations are the final ones, the half-tones the early studies of color effects.

A blue glass will be used on all south, east and west exposures; clear glass on the north. West exposures use eye-level ribbon windows to obviate claustrophobia and to provide emergency ventilation. South walls will have ribbon sash below eaves for natural light and to allow maximum flexibility in locating louvers. East, ribbons under eaves and vertically alongside columns, enclosing blowout panels. North, ribbons under eaves plus occasional vertical strips for views and ventilation.

The buildings will be steel-frame, single-story structures, except for certain two-story office sections. Roof steel is of cantilever design. Walls generally will be of concrete block set between columns, with expansion joints at each column, making each bay essentially a panel. Walls will be generally white, with blue enamel cover plates over exposed steel girders and columns. Certain office portions will be of red glazed brick.

Column spacing is 41 by 41 ft, to accommodate ten rows of pallets. The clear height of the building is 18 ft minimum, with bottom of the steel set at 20 ft.

Each of the three major buildings contains its own administrative offices, lunchrooms, toilets, locker room and other personnel facilities, offices being mainly in connecting links between buildings. Manufacturing buildings will house employee facilities in basements, together with building services and processing equipment.

The center office and cafeteria group contains administrative offices, a central cafeteria and main conference or meeting room. Central medical facilities are also provided in this group.

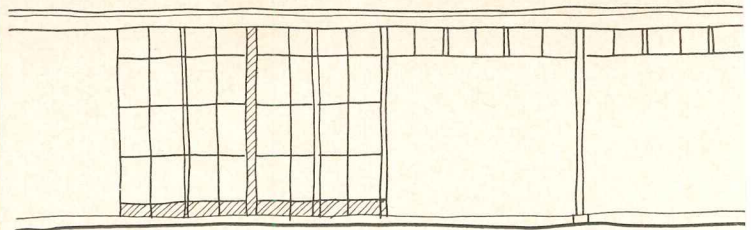

NORTH ELEVATION (FACTORY)

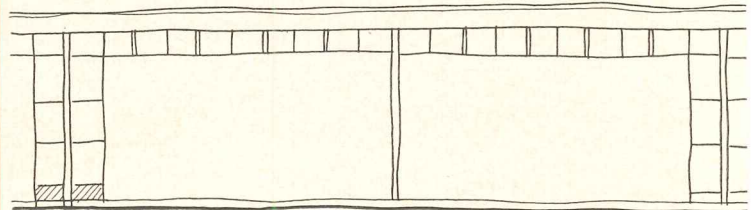

NORTH ELEVATION (SHIPPING CENTER)

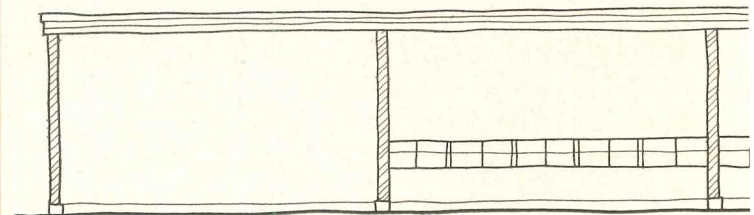

WEST ELEVATION

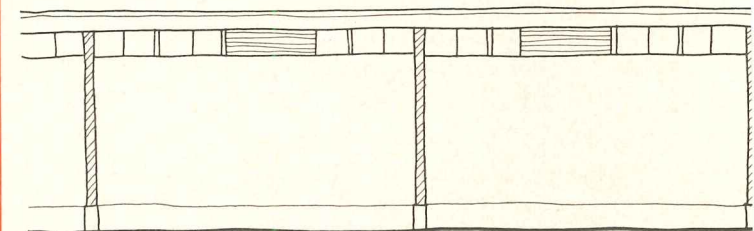

SOUTH ELEVATION (HIGH WINDOWS OVER RAILROAD SID

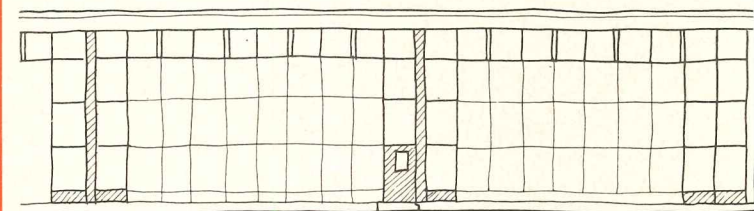

EAST ELEVATION (BLOW OUT PANELS)

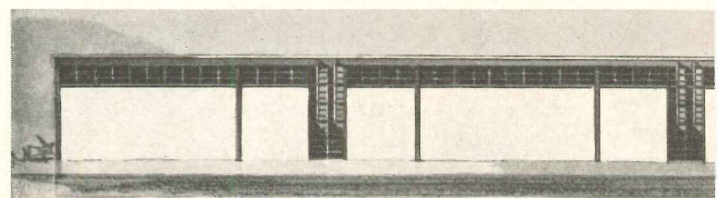
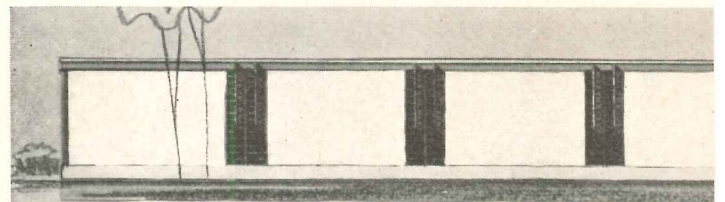

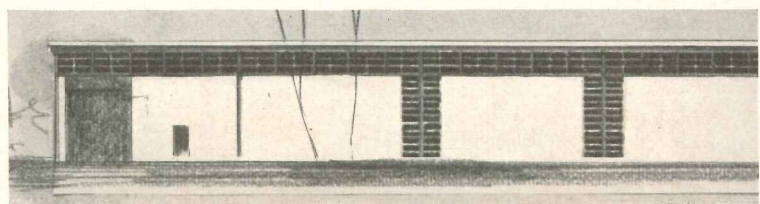
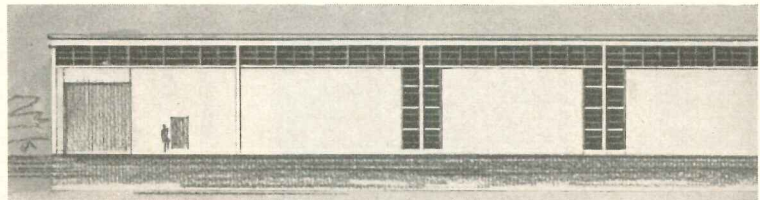
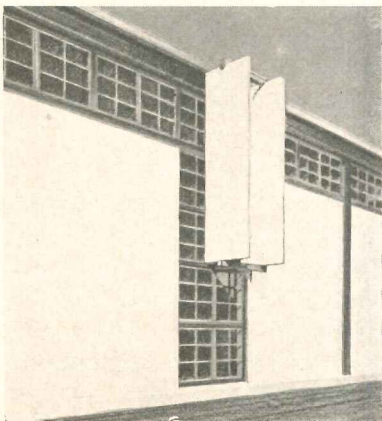
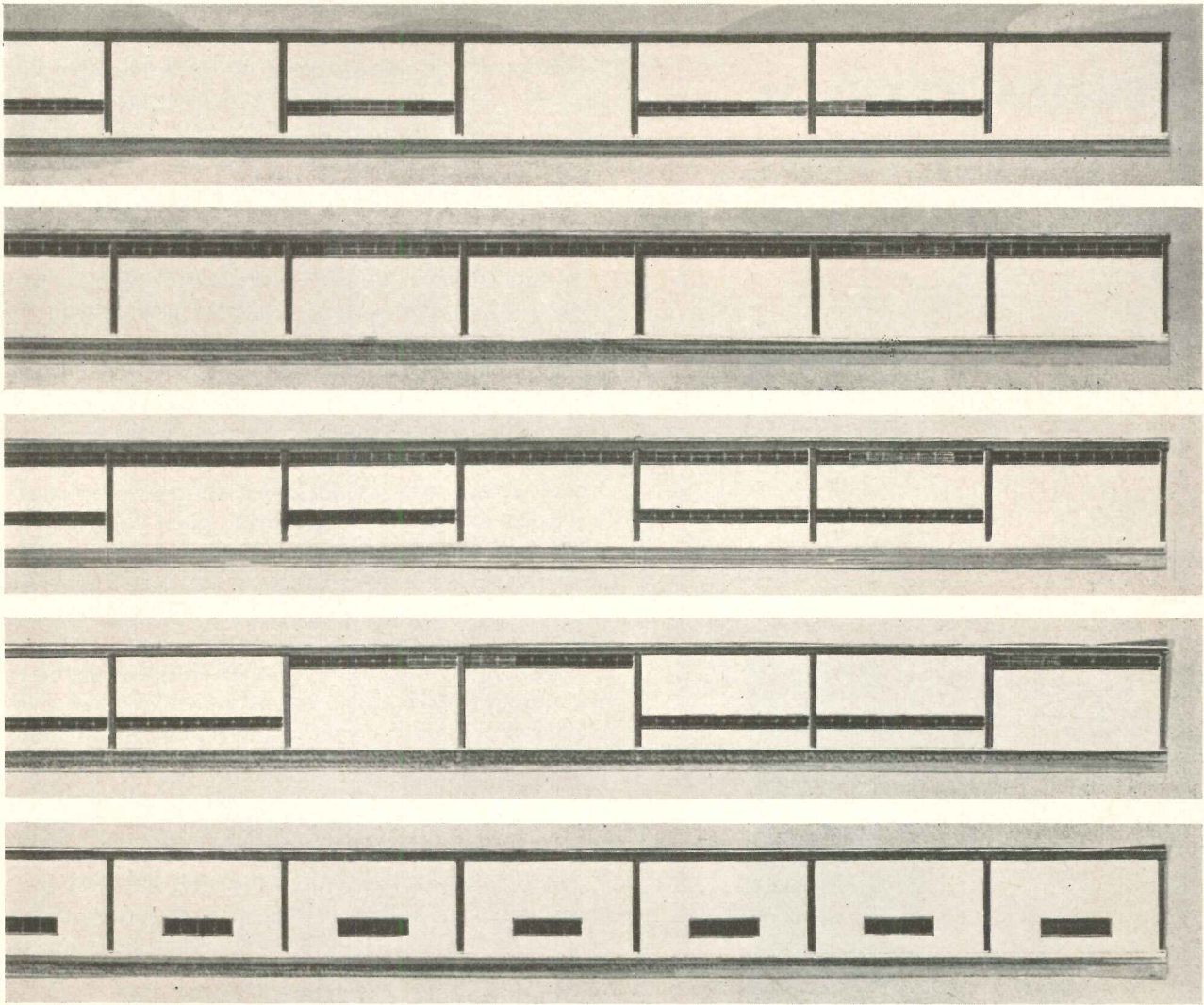

MATERIALS HANDLING AND INDUSTRIAL ARCHITECTURE

*By Irving E. Ingraham
of Giffels & Vallet, Inc., L. Rossetti
Engineers and Architects*

Lens-Art



CONTEMPORARY INDUSTRIAL ARCHITECTURE typifies the integration of architectural design with all phases of engineering. Modern industry has come to realize that buildings are as much a part of the productive and operative processes as are power distribution and plant layout. Professional services are now based on the thesis that there can be no clear division between the process and plant, and that architecture must be developed in close harmony with the plant layout and its equipment and services.

A natural result of this development has been that industrial projects — once considered primarily in the engineer's domain — have become equally the concern of the architect; and commercial, public and institutional works — once primarily the architect's province — have become the concern of the engineer. It has, of course, always been true that the structural engineer worked closely with the architect. But recent emphasis has been to have the equipment, plant layout, electrical, and mechanical engineers work closely together with the architect to produce an integrated, efficient plant or commercial establishment which is both esthetic and functional.

This modern integration of architecture and engineering is appropriately called Industrial Architecture, even though it is applied regularly to commercial and institutional projects as well as industrial. The name conveys the necessity for all modern structures to house materials handling devices and to provide for the proper flow of materials, vehicles and personnel.

For example, it was once considered sufficient for a public building, such as a post office, to have a monumental and pleasing appearance, which is to say its design was primarily an architectural function. Now it must also include the integration of all of the engineering fields, and be laid out to provide efficient materials handling. In skillful hands, such a building can be treated as a unified pattern and functional items which initially appear to be troublesome can be made to offer welcome relief and provide opportunities for accent and variation within a suitable over-all design.

The design of this post office parallels that of an industrial plant, and would commence with building layout to suit the site and provide for efficient receipt, flow and shipping of mail and materials. Analyses of conveyors, docks, lift trucks, palletizing, automatic cancelling, stacking and sorting, employee facilities, pedestrian flow, mail-by-auto facilities, and public services all enter into the layout and must be combined functionally within a suitable over-all design.

The industrial plant, conversely, was once considered solely a productive process which, unfortunately, had to have a functional housing of some sort. It was only recently that the layout and design of a factory became the province of any professional group, when production management turned to engineers for assistance in developing plant layout and design.

Industrial facilities produced under this emphasis

rapidly developed along the lines required by modern automation and mass production; that is, they were laid out to meet straight line flow and to provide for efficient materials handling.

As the modern architect-engineering firms began to serve both of these fields there evolved a conscious plan to achieve the integration of architecture and engineering necessary for an efficient, economical plant which was by nature, functional, simple and pleasing. It may well be that this coordination of the two professions has been ingrained in the personnel of these firms as a heritage of their association, rather than having come about as a conscious plan. The necessity to provide personnel flexibility to meet the rapidly changing workload in this cyclical business has made many of these individual engineers do some work as architects and many of the architects work on plant layout and various phases of engineering. This flexibility of training and knowledge on the part of these professional personnel has been a logical part of the process for the integration of architecture and engineering.

Industrial projects now usually commence with plant layout, at which stage the general outlines of the plant and departments and choices of equipment are established. Then architectural studies proceed apace with more detailed engineering, as the two are interdependent. The fundamental emphasis is on plant layout, which is the backbone of all good industrial facilities. In turn, plant layout is fundamentally an arrangement to meet the proper flow of materials.

The handling of materials represents most of the physical activity in a plant. Raw materials, materials in process and the finished product are the basis of its existence. From the receiving dock materials are unloaded, moved, stored, removed and stored, and moved into manufacturing. During the manufacturing process they move, wait in process and move through numerous operations and surge storages, through inspection and packaging to final storage. From there they go to the shipping dock and final handling.

This basic material flow in all industrial plants, whether processing or warehousing, is a major part of the activity. It absorbs many man hours, and may cover high costs hidden in inventory, space utilization and curtailed output. Materials handling is a top consideration of all management and so of the architect-engineer.

Conveyors are often considered to be the basic materials handling device and, in the sense that materials handling encompasses machinery, they are. There are literally hundreds of different types of conveyors and other materials handling devices which are often the heart of a plant activity.

A single conveyor is often the basic item around which a plant is built. An example of this which quickly comes to mind is the assembly plant, where various components are added, one to the other, as the basic frame travels on a continuous conveyor. These com-

ponents may be sub-assembled adjacent to the main conveyor, or received as individual parts or complete sub-assemblies from another plant.

The continuous mold conveyor in the modern foundry and such other plants as those manufacturing foam rubber mattresses is an example of this type of conveyor. Here molds are filled, prepared and assembled either on or adjacent to the conveyor. On the conveyor they are poured, cooled, otherwise processed and emptied of their product.

Probably more fundamental than the conventional mechanical conveyor to modern materials handling is the lowly and unsung fork lift truck, which has facilitated the modern concept of the unit load. This concept is that materials in any phase of production — raw storage, in process, or finished form — should be handled in as large a load of individual units as is possible. This is achieved by palletizing, tote boxing or otherwise packaging the material into a several thousand pound load that can be readily lifted, transported and stacked by lift truck. Of course these same unit loads are also conveyed on roller, belt and other conveyors or crane; but the transferring, storing and conveying medium normally is the lift truck. Utilization of trucks determines aisle patterns, storage area and ceiling heights (the latter to permit stacking), which enter into the configuration of the structure.

A logical extension of the unit load concept has been the complete elimination of units. In many industries, materials such as limestone, wheat and petroleum are conveyed through much or all of the production processes in bulk. Here the utilization of pneumatic conveying, belt conveying, hopper cars and cranes has not only eliminated many costs associated with packaging, but they have also had their effect upon architecture.

The architectural trend to facilitate this modern materials handling has been an almost universal and natural adoption of the single story building. This one level floor plant facilitates efficient arrangement of parts and assembly lines, and also provides for ease of materials handling by conveyors, cranes, monorails and lift trucks. The phrase "one level" in its broad sense, includes mezzanine, basement and penthouse areas which are frequently employed to conserve cubage and to keep auxiliary services adjacent to the areas they serve. The single story building normally, and for all intents and purposes, is equal in cost to the multi-story building for an equivalent floor area. The latter is usually not considered to be worth the sacrifice in materials handling required in vertical transportation between floors.

The multi-story building is still required in many production processes, especially in the chemical and allied fields where a vertical flow is a production necessity. The multi-story structure requires a minimum of ground area and is utilized for this reason oftentimes on expensive urban properties.

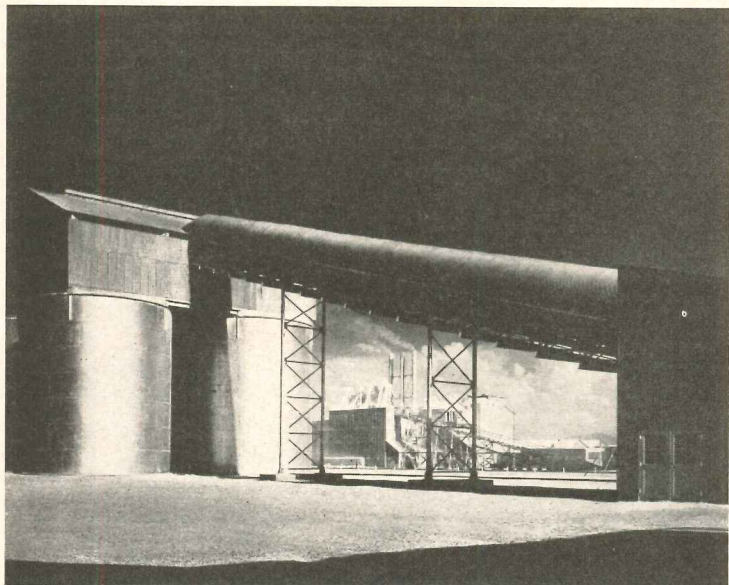

Lens-Art



Lens-Art

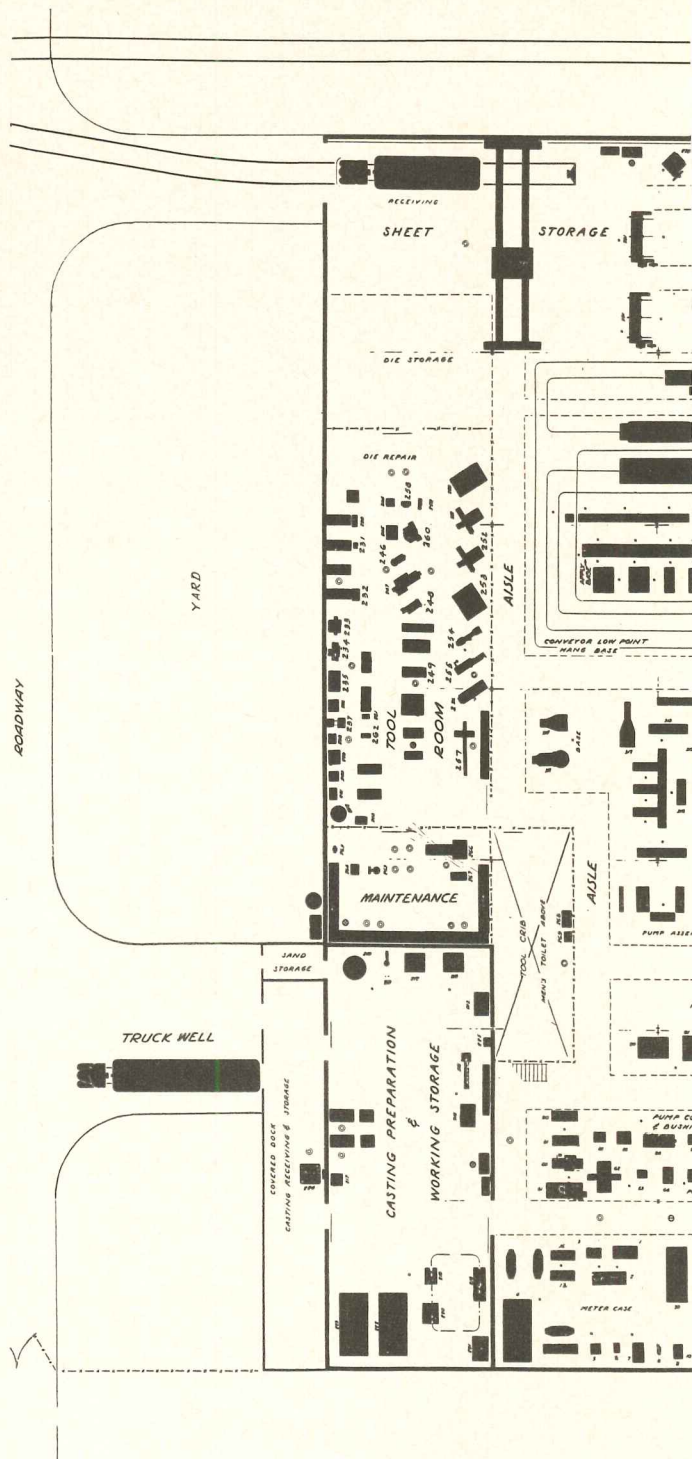
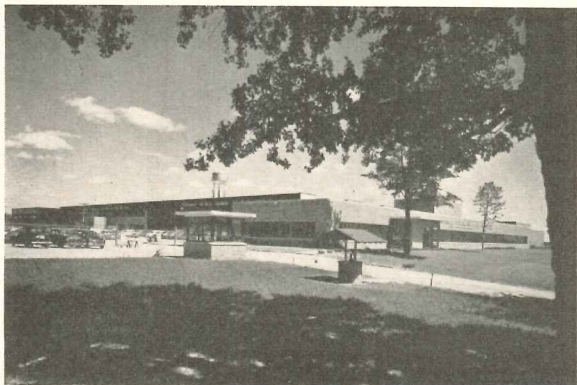

THE GROWING SCIENCE OF WAREHOUSE DESIGN

*By William H. Meserole, President
Ballinger-Meserole Company**

*Food Distribution Center for Penn Fruit Co., Inc.
Philadelphia, Pa.*

The Ballinger Company, Architects and Engineers

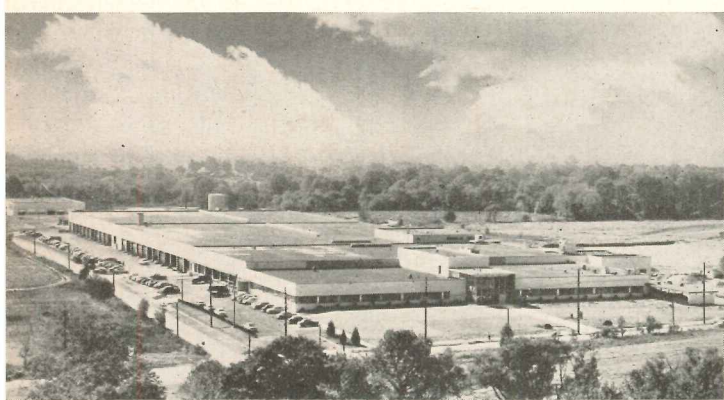

Skyphotos



THE FIRST MODERN one-story "streamliner" food distribution depots were built in the early 1930's. They had 14 ft. ceilings. Their operators put cubage to use and handled tonnage on skids and high-lift platform trucks. What was then called the assembly line was in use, though still controversial.

Plenty was wrong with these warehouses, by today's standards. But considering they represented the first admirable steps toward high tonnage output per man-hour, they were meaningful.

They were radical, too. They departed from the multi-story concept that had dominated distribution warehouse history since days of yore when transportation was primitive, when distributors were obliged to locate near the market place and build level on level to justify real estate costs. Waterfronts were good locations because the upper floors of buildings could be loaded by ships' gear and unloaded by chutes. Hydraulic, then steam, finally electric elevators were introduced, and for generations it seemed as though invention to make these buildings ever optimum would keep abreast of need.

The first fork lift truck, circa 1916, developing slowly through the Twenties, found the chinks in the giants' armor and in the mid-Thirties tumbled them to the

**The Ballinger-Meserole Company is a combination of an architectural firm and warehouse consultant. In the past decade the firm has organized operations and space for some 300 warehouses.*

1. Truck dock, cigarettes
2. Cig. warehouse & stamping
3. Expansion area
4. Premiums, shelf goods, etc.
5. Fast-mover stacks
6. Reception & shipping platform
7. Truck dock
8. Detail. End elev. of fast stacks
9. Storage stacks, turnover lots
10. Storage stacks, long buys and balloon goods
11. Incinerator
12. Baler
13. Type & size of pallet
14. Pallet racks, med. fast movers
15. End elev. of pallet racks
16. Double rail spur, 32 cars
17. Rail rec. platform
18. Truck rec. & ship. platform
19. Truck dock
20. Charger benches
21. Racks for very slow movers
22. Tow-line, set in floor
23. Charger benches
24. Banana, tomato, melon rooms
25. Toilets, lockers, overhead
26. Produce floor
27. Warehouse offices
28. Self-adjusting dock boards
29. Fish cooler
30. Fish freezer
31. Frozen foods
32. Meat rail
33. Boxed meats
34. Meat & fish truck dock
35. Cheese cooler & work
36. Meat cooler
37. Wet produce cooler
38. Dry produce cooler
39. Compressors
40. Office
41. Meat office
42. Employees entrance
43. Corridor to office
44. Start of order-pick
45. End of order-pick

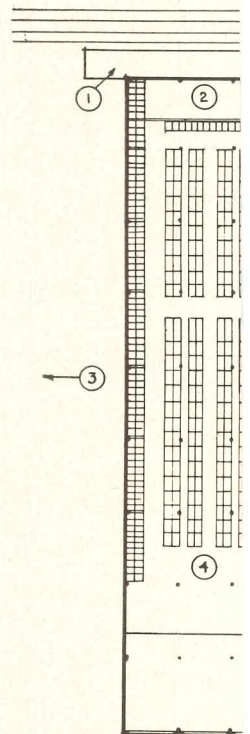

ground. Wage rates had risen under NRA and the New Deal and goods no longer could be handled piece by piece in quantities per man-hour justifying the higher wage rate.

Elevators became serious bottlenecks; nine-foot ceilings then common forced operators to spread out the goods and increased distances traveled at more and more cents per man-hour. So, few if any multi-story distributor warehouses have been built since. The trend has been strongly toward "streamliners," with effort concentrated on improving operations within them.

This was all part of the drive to justify the rising wage rate. Labor cost as a percentage of sales has not declined since the Thirties, but the ratio has not increased either. Concurrently, the dollar wage rate has rocketed to three or four hundred per cent of what it was. Real wages have increased substantially since the value of goods has not risen that much.

Continual improvement of materials-handling devices — mechanical and procedural — arrested the percentages. We have machines today that run faster, lift more goods higher and require less waste space for aisles than ever before. The procedural improvements followed recognition of certain low-cost-causing principles that are so obvious they should have been detected long ago.

"Right" mechanics and structures, for distributors' purposes, have joined with the burgeoning population

to make this the century of scientific distribution at the middleman level.

What is the architect's place in this picture?

Too often clients "guesstimate" they need a new plant a certain per cent larger than what they have. Too often the architect has no way of checking the estimate. So he accepts it, assuming the client knows how much space he needs, and away we go.

Common mistakes found in warehouses are:

- too small or too large in footage
- too low in ceiling height
- badly column-spaced for usage (however economical)
- wind bracing impeding usefulness
- badly proportioned
- ill-shaped, as in a "U" or "L"
- improperly slab-heighted for trucks and rail cars
- on inadequate land prohibiting expansion
- too expensive
- badly floored as to surface, thickness, joints and just plain quality

Clients' estimates and architects' assumptions are often wrong. The architect should recognize the client as a merchant who, incidentally and unwillingly, must maintain a warehouse he views with distaste because its operations are far less flexible than his genius as a merchant. He is not a specialist in physical operations. He is impatient with his warehouse superintendent who is, or should be, a specialist.

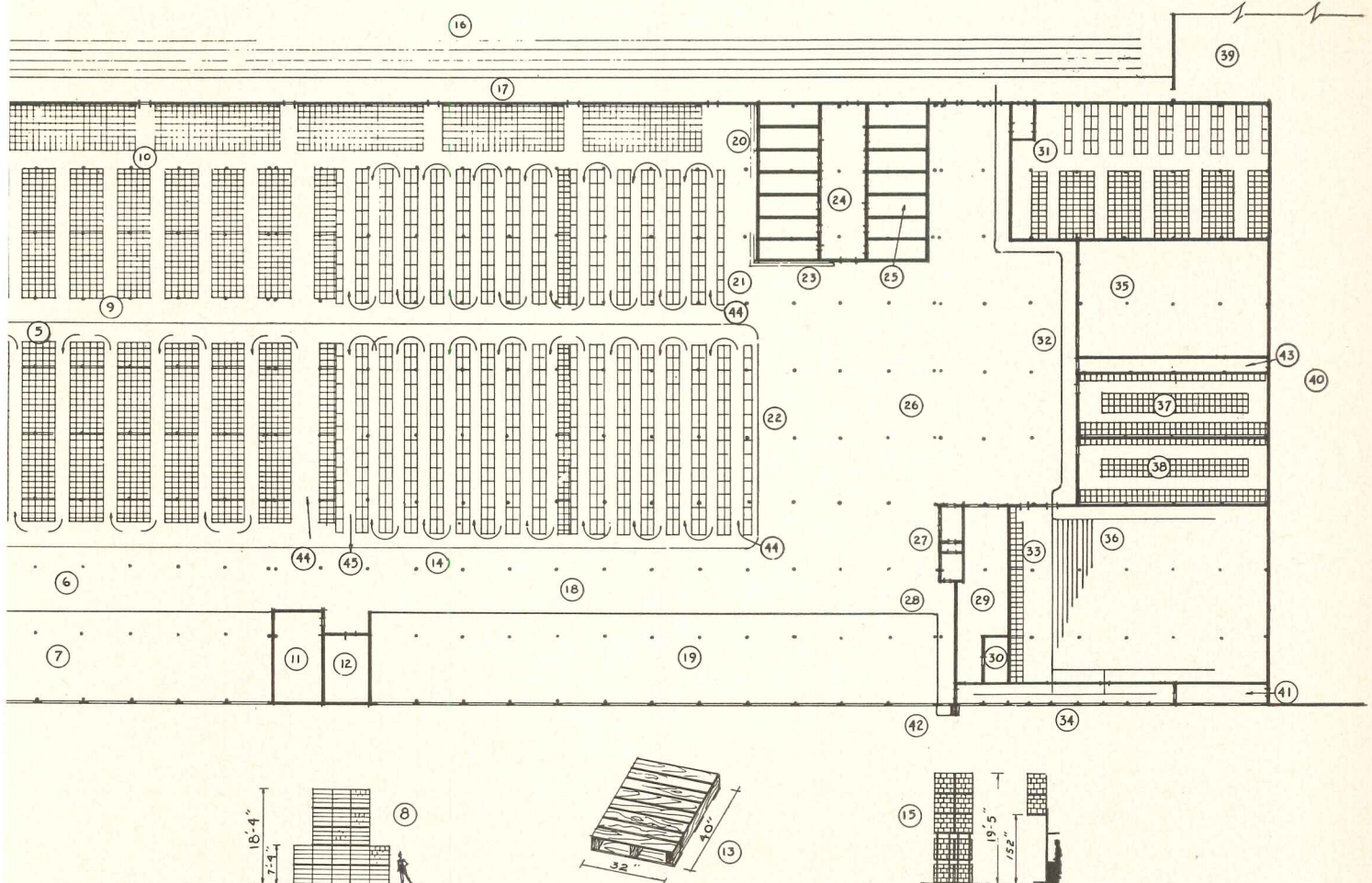

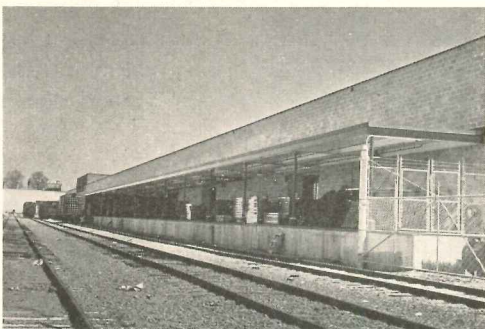

Let's face it: not all are. Many, emerging from the labor force, learn all they know within the four walls of one warehouse and acquire reverence for its customs. They lack the perspective they could have, had they been exposed to other methods and mechanics in other plants.

Operations Planning

Intelligent distributors have recognized their own inability to design either their own physical operations or their own plants for lowest-cost operations. Many have sought help from a new species of specialist — the operations consultant — who has sprung up in response to demand.

Materials and dimensions, important though they are, depend heavily on several significant principles of inventory and work organization.

One can be stated simply: *labor cost rises dollarwise with distance and tonnage.* To apply this, up-to-date general-line food warehouses are organized on a ton mileage basis (as shown in the diagrams). The time-honored likeness grouping of goods — flour here, canned vegetables there, canned fruits somewhere else — no longer is maintained. The new concept of departmentization is built on such factors as fast and slow movers, shelf stocks, etc.

By these means the inventory is organized to minimize walking and hauling. Daily tonnage is moved in and out of the warehouse with fewest steps, turns of wheel and man-hours. The shape and proportions of the warehouse can enhance the results of these achievements.

Proportion of Buildings

Architects know that square buildings are cheaper because the perimeter is shorter and less wall is needed for a given footage and cubage. But more important than any saving in building cost is the lower cost of labor when the warehouse is well proportioned.

Walks and hauls are greater as the ratio of length to width of the structure increases. For reasons of labor cost we believe it unwise for proportions to exceed three to one in a dry grocery distributive operation. As that ratio is exceeded it becomes harder to organize the warehouse for labor economy because the increase in length of walks and hauls is proportionate. Travel takes time. Time is bought by the man-hour.

Of course contiguous and related though separate functions can be set up in warehouses of any L-W ratio so long as no unified function occupies space exceeding the three to one proportion. A produce department may be set up at one end of a warehouse; a grocery operation at the other. Neither need occupy space ratioed over three to one, though total space may be five to one.

Odd shapes like the "U" and "L" should be avoided. These are hard to organize for economy and require more wall to enclose a given footage or cubage. Too narrow a site, selected because of excellent location, should be avoided — at least for grocery warehouse purposes. Plots less than 300 feet wide in the narrow

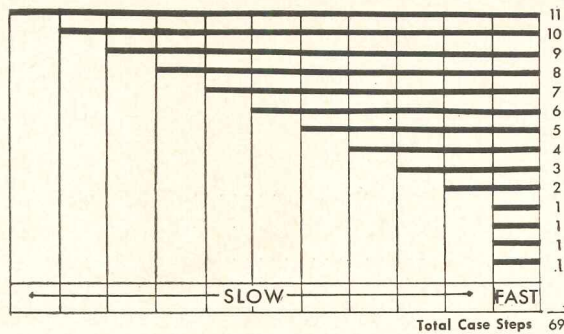
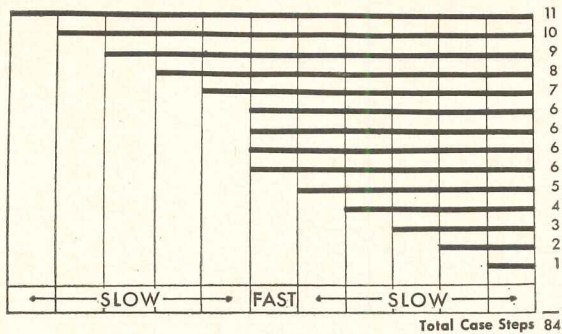

The Ton-Mileage Principle — How the strategic placement of one fast-mover item reduces the case-steps

axis between a highway and a rail line may set up unexpected difficulties, like this:

truck dock	100 ft
covered truck dock	50 ft
inside shipping platform	25 ft
rail siding and platform	32 ft
	207 ft
left for stacks and aisles	93 ft
	300 ft

Under conditions like this, operations within a 40,000 sq ft warehouse (a small one) will be conducted in space ratioed at more than four to one. That ratio will increase, dragging rising labor cost with it, as any building expansion is made, since the warehouse can expand only laterally.

You can "correct" by making other mistakes, like minimizing the truck apron and eliminating the rail platform. Still the lateral expansion of the building is so limited by the three-to-one rule that the user will be driven out of his new warehouse by rising labor cost as his business grows.

How Much Land?

Another good generalization is that the future should be anticipated by securing enough land. The plot can well be big enough so not more than 25 per cent will be covered by the initial construction. The growth of food distributors is limited usually not by the market, but by their physical facilities. With labor cost lowered through a well-designed operation in a good new warehouse, growth and need for more space is likely to occur very soon. There must be a place for it.

Expansions should not be built until they are really needed. Gross margins being low in the food industry, few can pay 1960's occupancy cost out of 1955's dollar margins and still stay in the black. The question then is: how much warehouse does the client need right now?

We have conventions that work well for us in basic planning to determine warehouse size. The following illustration is based on use of the 40 by 32 in. pallet; 20 ft clear inside heights; standard dry grocery inventories; use of straddle-type high lifts, and reasonably-sizeable operations.

Here is the formula we use;

Dollar inventory divided by \$5 as the average case value yields number of cases in inventory.

Divide the number of cases by three, since three pieces per square foot can be stacked — yield is stack and aisle space required.

Add 20 to 25 per cent for non-inventory footage needed to get total footage required to carry the inventory at 70 per cent of "shoehorn" capacity, including non-inventory space.

From this, the building can be sketched, layouts made, and operating load computed. As a rule, minor addition or subtraction of space for more or less office, cooler or shelf department will portray accurately the client's space needs.

For a general-line dry grocery distributor, about 30,000 square feet is the low limit of size. For the operator who would use such a building the inventory load, which we've seen how to compute, is not the criterion of size. Rather, the criterion is spread of inventory — the variety offered for sale. The total number of cases, regardless of variety, is another matter. That governs the size of the building needed by large distributors.

It has been our experience in warehouses as small as 30,000 square feet that the inventory capacity is ample when there is aisle space enough to set up the spread. In such a warehouse 2500 items can be carried, and over \$4 million in annual volume accomplished. At 100,000 square feet, the problem is never spread — always load.

Building Design Factors

Because he stacks his merchandise on racks no dry grocery distributor today should build a warehouse with less than 20 feet of clear ceiling height.

For the architect this means adding enough to the 20 feet to accommodate all mechanicals and structure above that level, bracing included.

Speaking of wind bracing, there must be other and better ways of making sure a warehouse building will not twist or blow down. If the problem is explained, the client will usually settle for heavier structure. More steel tonnage may add a few per cent to the cost, but returns to usefulness a much larger per cent of the cube. Cross bracing at the bottom chord of a truss also makes it tough on the operator. If the ceiling height is 20 feet and the truss takes five, cross-bracing virtually guarantees an effective stacking height of only 15 feet. Thus the at-least-20-feet-under-whatever-lies-aloft rule.

In the dimension perpendicular to the shipping dock

the column spacing of a palletized warehouse should express a given number of pallet loads. With the 32 inch face pallet some multiple of three feet plus one final foot always works if the columns are not over eight inches:

9 pallets at 32 in. equals	288 in.
10 clearances at 4 in. equals	40 in.
1 column	8 in.
	12) 336 in.
	28 ft — 0 in.

Add any multiple of three feet and the spacing may be 31 ft or 34 ft, etc.

In the second dimension, parallel with the dock, the depth of a rack or stack plus the width of the aisle is the multiple:

Rack, depth for two pallets	7 ft
Aisle required by lift and load	7 ft
Thus any multiple of 7 ft will do well	
How about 42 ft?	

And how about 28 by 42 ft? (Of course other dimensions apply with other pallet sizes.)

Floors and Floor Grades

Floors for food warehouses should be as good as skills can design and build. It never pays to try to save money on a concrete floor for a food warehouse. Where can the operation relocate while repairs are made? Besides, no one knows how to repair a concrete floor effectively.

Food warehouse operations, we have found, will not normally injure an honest six inch floor on good compaction — unless ruthless operators use steel-wheeled vehicles. However, we have seen four inch floors broken up by grocery loads. Steel wheels work havoc on floors. Rubber-tired and solid plastic wheels are available, and entirely satisfactory.

Expansion joints in grocery warehouse floors are another gremlin. The floor can and does chip away to some extent at these points. We prefer a sawed joint with the narrow slot filled with asphalt. Metal joints should be knife-edged, or they will break the wheels of jacks, wagons and other handling vehicles.

How high should the surface of the floor be above grade in the truck dock, and above the top of the rail at the siding?

Reason for confusion is that all heights of over-the-road vehicles bring in goods, and these vary as much as two feet between highest and lowest. It is impossible to adjust for all. Nor is there any way to predict the height that suits most.

One can tell exactly what the truck fleet of the warehouse requires, even though several kinds of trucks are used. The truck fleet can be measured and dock floor height adjusted accordingly. The dock slab height should be adjusted to truck height, loaded, so when empty the truck bed will be higher. It is wise to do this because in ramping down into a truck, the ramp has to extend well into the body. Ramping slightly up into any vehicle is preferable.

The same thing applies at the rail siding. Rail cars are not wide. If one must ramp down into them, insufficient turning space is left inside for the jack or lift truck.

Another good reason for relatively-low rail platforms is that cars differ markedly in floor height and many have hinged doors opening outward. These are the refrigerator cars commonly used to protect goods from sub-freezing temperatures in long winter hauls. If the dock is high, doors may not swing open between car side and platform. For these reasons, we like a nine foot space between platform and center of rail siding, and a 3 ft 6 in. height of platform over the top of the rail. The gap between the car side and platform of some cars then is nearly four feet, but that can be bridged easily, and the dimensions stated outguess all difficulties.

Where double rail sidings are necessary to carry more cars alongside, the two rail centers should be kept far enough apart to allow the doors to two refrigerator cars to open, letting the off car be worked through the nearer one.

Things to Come

As the multi-story warehouse toppled at the summit of its development, so will our now-wonderful streamliners. The shape of things to come is already visible. Manufacturers of materials handling machinery are asking themselves what they'll be making, say 20 years from now, when the only lift trucks extant will be in museums. Some of them are doing something about it — which tends to bring closer the date of accomplishment.

In time 80 per cent complete automation in distribution warehouses will be the rule. Goods will be handled by machines activated by magnetized tape. Machines will detect odors, read numbers, appreciate dimensions, work in the dark in one-story warehouses of towering height, without floors. The buildings, indeed, will themselves be machines, and instead of labor forces we shall have a small corps of technicians to keep the plant operative.

The only "labor" will be a small receiving crew directing inbound goods to slots by mechanics and electronics. Allow 10 per cent for the technicians and 10 per cent for the input crew, explaining the 80 per cent figure above. When this happens we shall be able to pay the technicians three times as much as labor earns today, and the inputters twice as much, while operating at half the labor cost.

Certainly this is a dream. But so was the Brooklyn Bridge, designed before Roebling worked out the detail of spinning the big cables on the job.

We have been told by the "brain" manufacturers that if we can think out what we want, and can afford it, they can make it.

So it is only a matter of time. Twenty years? Thirty?

And then, architects and engineers will house it all in buildings scarcely imaginable. Then, all we know now about warehouses for distributors can be filed away in a time capsule — to give our descendants a chuckle.

MODERN WAREHOUSE FOR FOOD DISTRIBUTION

*Abner A. Wolf, Inc. Warehouse
Detroit, Michigan*

Louis G. Redstone, Architect

C. L. Toonder & Associates, Mechanical Engineers

Lens-Ar

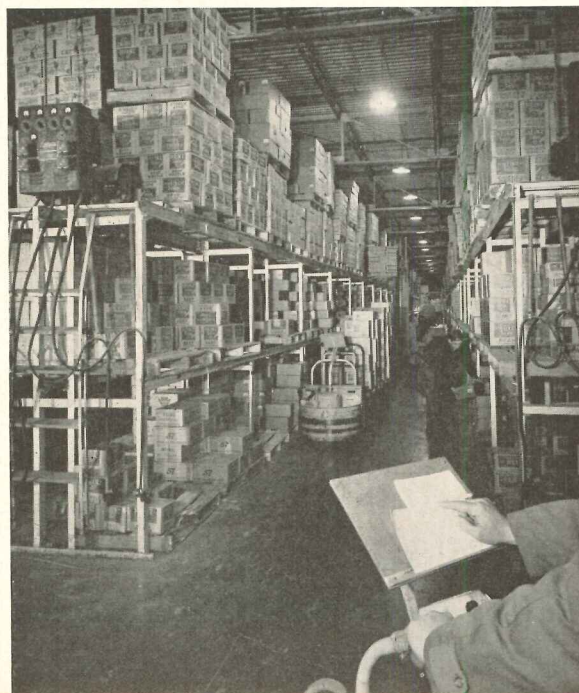

THE GREAT FLOOD OF PRODUCTS of industry must be sold, stored and moved to consumers, and the distribution process is rapidly becoming as scientific as manufacturing. The distribution inventiveness, and the buildings that go with it, is well illustrated in the food field, where both the volume and variety of goods force an intensive search for the most economical methods. Buildings for the handling of grocery products are called warehouses, for of course that's what they are, but the operations inside them may include all of the modern wholesaling functions.

The Wolf warehouse in Detroit is one of the large and well organized ones, a true wholesaler. But Manley Wolf, one of the brothers who have become in fact warehousing specialists as well as food sellers, laments that here their operation has so outgrown their building that some of their science has been snowed under. He nevertheless has outlined their methods, with special reference to their effect on building design.

"We operate with a 72 page order form. The customer orders the items in the amounts he desires and mails the form to us. Girls select tabulating cards for the items that he has ordered; these cards are then pre-sorted from their original order-form code sequence to warehouse lot sequence. They are then put into the IBM tabulating printer and an invoice is printed. This invoice has 3 copies; office, customer and warehouse. The warehouse copy is used by the selector to fill the order. The office and customer copy, kept together, are used to check the selected orders. The checker marks an X for items filled and an O for items not filled. This gives the customer a copy of the actual checking that took place.

"Our order selectors use 4-wheel trailers and electric towing tractors and select their orders on empty pallets, which, when full and checked, are loaded by fork trucks at the dock. This system of filling on pallets, though slightly less productive at the selection end, more than compensates at the loading end.

"We operate on a surplus selection system wherein order-pickers are travelling in a selection area which contains a representative amount of all items. The selection area, of course, is backed by the surplus area which contains the remaining stock. We feel that the additional intra-plant handling necessitated by this is more than compensated for by the shorter selection

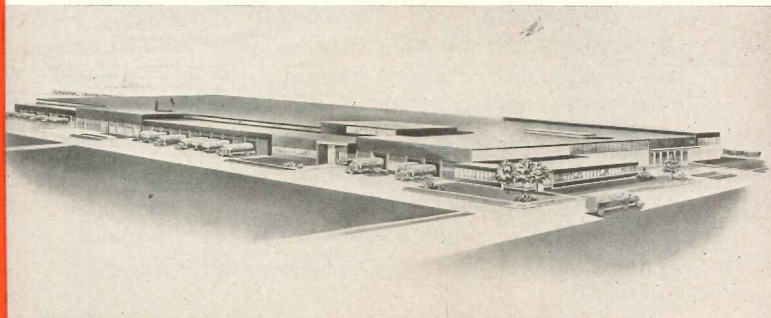

WAREHOUSES

walk of the order-pickers and therefore their greater production. We operate under a quasi-slot system, the slot number for each item being in effect the selection address number of the item. All items have a code number in our order form from which the customer orders and these are numerically in sequence by family groups and these are numerically in sequence by family groups. All tomato products are found in the same area of the order form and are in numeric sequence. These same tomato products are in different warehouse locations selection-wise. Thus, with the slot number system, we can keep our selectors in numeric sequence without confusing the customer order book which approximates store layout. Also, the separate slot number allows greater facility for moving items in the selection line. For instance, an item that is normally a slow mover and therefore in a less accessible selection area, might become a feature item at store level with a much accelerated movement. Thus, by merely changing the slot number, without any alteration at the customer level of ordering, we can put the item in question in its proper spot.

"We use 28-foot through 32-foot semi trailers almost exclusively in our delivery operation and average 80 loads per eight-hour day.

"In our receiving operation, we can receive 20 highway trucks at a time and can accommodate 14 railroad cars within our building.

"You probably know most of the architectural facts concerning our building, but in the event that you don't, here are a few pertinent ones. We have 40 x 40 bays. We have a clear useable height to the bottom of the trusses of 16' which we find adequate for our 40" x 30" pallets. Our shipping docks are 240' long and 51" high. Our receiving dock is 200' long by 30' wide by 48' high. The reason for the lower receiving dock height is to be able to accommodate more inbound trucks of varying truck-bed levels. Since it is an unloading operation, we're better off coming out of the truck with a down slope than the reverse.

"In closing, I might mention some things of prime importance that we have learned in this building. Floors should be of adequate strength and proper finish. Adequate clear height is essential, pre-determined by the stocking height one's operation dictates. Above all, there should be an adequate electrical supply to handle greatly increased projected use in future handlings."

Constructed of steel, concrete and masonry, the building occupies 350,000 sq ft of a 12-acre site, with 38,000 sq ft devoted to office use, and 100,000 for expansion now going forward.

Foundation, reinforced concrete; frame, steel; enclosing walls, 6-in. concrete curtain with steel windows and steel deck fascia up to roof. Interior walls, concrete block. Roof, tar and gravel, $\frac{3}{4}$ in. glass insulation over metal deck. Warehouse floor, 6-in. reinforced concrete with a hard "monorock" finish.

Average cost of building was \$6.50 per sq ft, including warehouse, offices, cooler installation and refrigeration equipment.

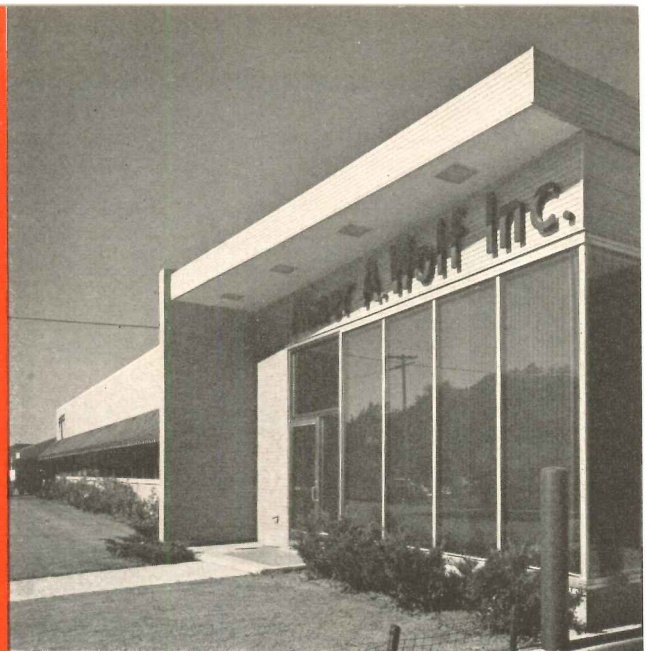

Lens-Art



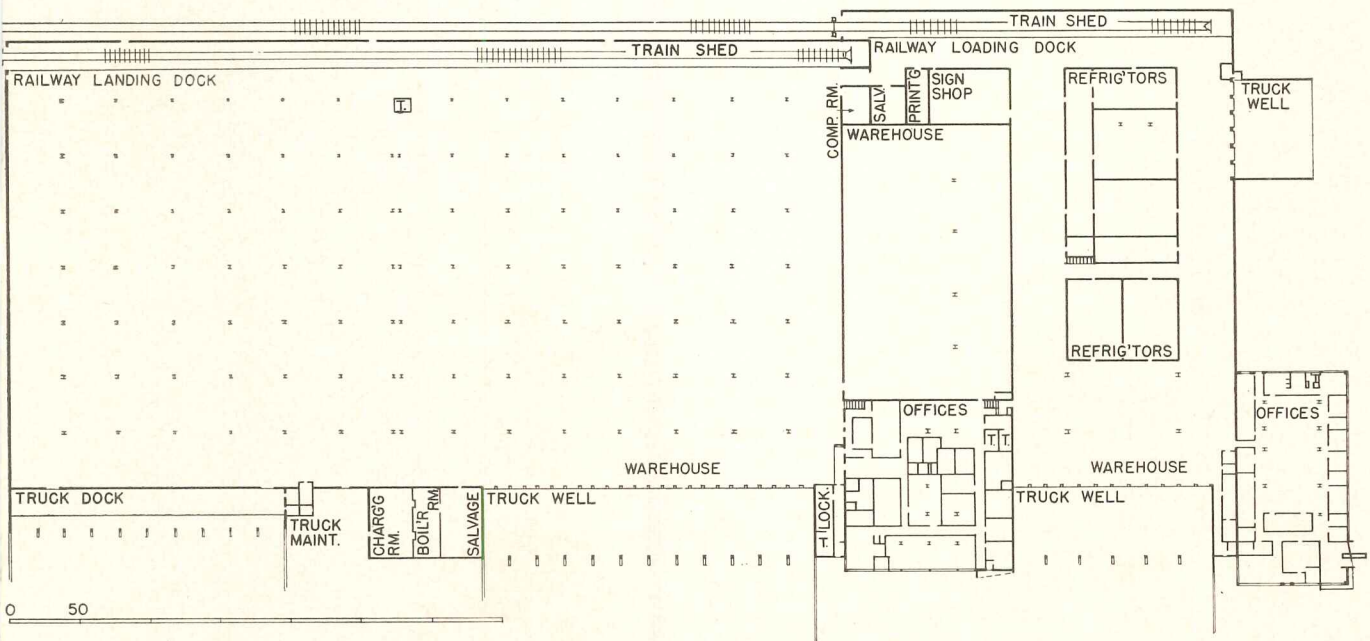
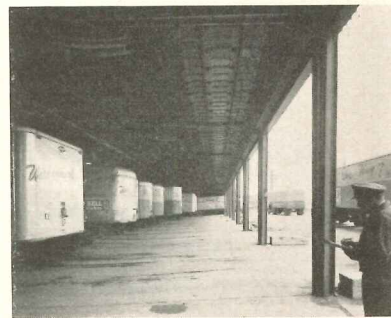

OFFICES AND WAREHOUSE FOR MICHIGAN STATE LIQUOR COMMISSION

*Louis G. Redstone
and Otis Winn
Associate Architects*

David J. Zabner, Mechanical Engineer

*Building Division, Michigan
Department of Administration
Adrian N. Languis, Director*

NO DOUBT AROUND DETROIT this building is the subject of many a feeble joke, for it is the world's largest liquor warehouse, designed to contain 9,000,000 bottles of "packaged goods."

Like most modern warehouses, however, it was designed for the business-like and economical handling of goods, in this case both local and state liquor storage and distribution at the wholesale level. Its dual purpose accounts for the fact that it is really two separate warehouses, with two separate truck wells.

Like many another of the representative "warehouse" buildings in other distribution fields, it is also a sort of home-office-in-the-field, with fairly important

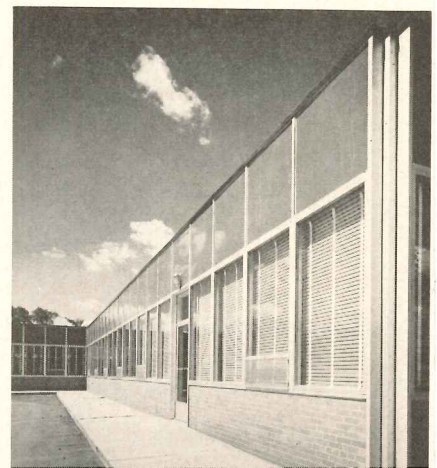
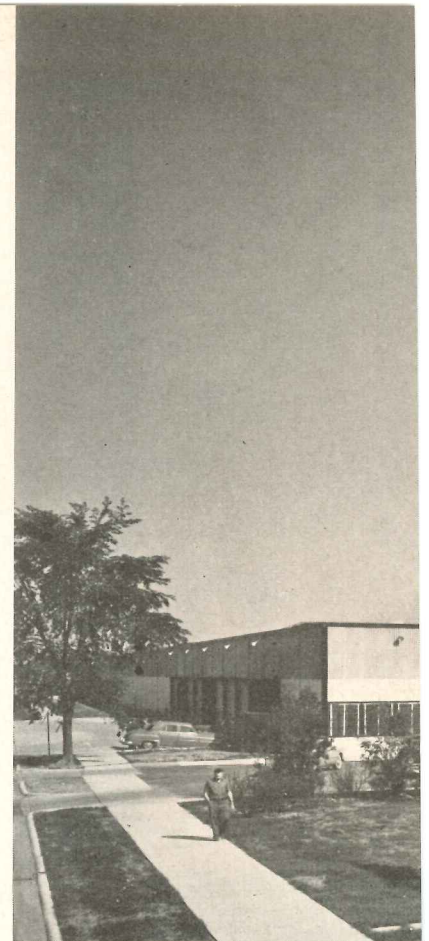



Lens-Art

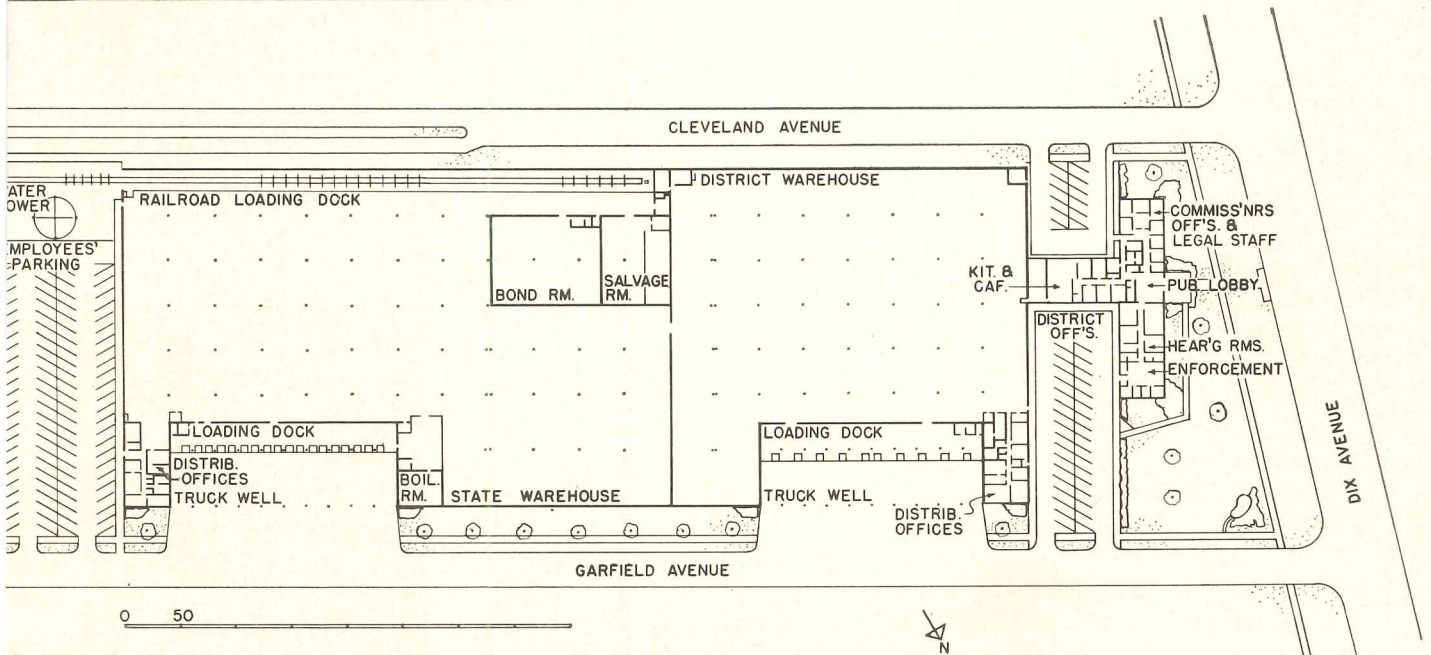
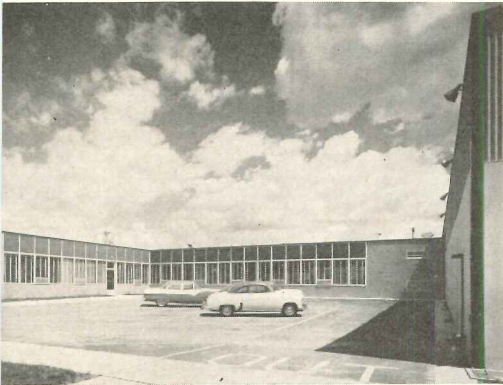

WAREHOUSES

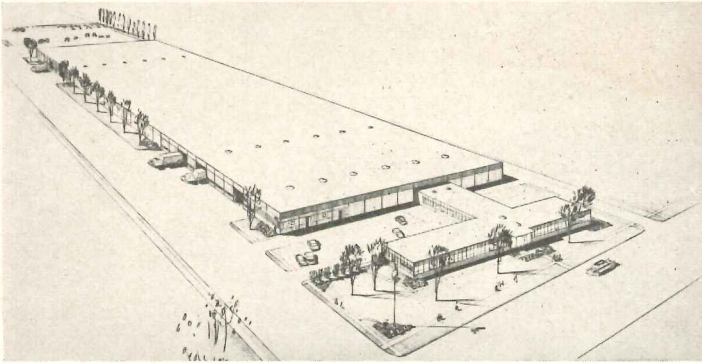

stature as an office building. Here are housed the state liquor control commissioners, legal staff, office staff, enforcement group, district staff, complete with kitchen and cafeteria, all completely air conditioned.

The warehouse portions contain 240,000 sq ft, disposed in a rectangle 800 ft long by 300 ft wide. A railroad spur extends into the building to bring as many as 10 freight cars to the incoming platforms. Outgoing deliveries are by truck, and the two truck wells can accommodate 40 trucks. Manually operated levellers facilitate loading.

Warehouses used fire-resistive construction, with steel beams and columns, steel joists, metal roof deck. Exterior walls are 8-in concrete, 12 ft high, with upper section of corrugated asbestos. The warehouse fire protection system comprises automatic sprinklers, fed from a free-standing 100,000 gallon water tank and 100-gallon-per-minute fire pump.

Lighting in the warehouses uses the new 480-277-volt, 4-wire, 3-phase system. Heating is by unit heaters served by 10-lb steam, with vacuum returns. Ventilation system employs controlled sectional intakes and exhaust to obtain full coverage without dead spots.

Cost of the building, both office and warehouse, was \$5.76 a sq ft, including all site improvements. This cost is reported to be 20 per cent under the appropriated amount.





Lens-Art



DISTRIBUTION CENTER FOR ELECTRICAL GOODS

*Sales and Warehouse Building for
Central Electric Supply Company
Denver, Colorado
Stanley E. and Jared B. Morse, Architects*

THIS "WAREHOUSE" EXEMPLIFIES a general type of building which is seen in increasing numbers as industry's distribution system expands. While the strictly warehouse function is, space wise, the largest, there would be little reason for a warehouse without the display, sales, service and general office work that also goes on here. Nevertheless it is frequently the materials handling operation that forces the construction of the building, and that strains the designers to plan buildings and facilities for the utmost efficiency in receiving, sorting, storing, packaging and shipping goods.

Here these problems were turned over to the architect, to devise systems of handling the seemingly infinite variety of electrical supplies, ranging from tiny parts to great reels of cable. One can guess that he found it a fertile field for the kind of ingenuity that finds daily exercise in an architect's office.

The building serves three types of customers. The display area (left portion of plan) is to promote the sale of light fixtures on a retail basis. Fixtures are mounted on panels and are inserted into the ceiling grid to simplify changing them. Small orders are filled in a serve-yourself area (left center of plan). Large orders are collected from the mezzanine area, assembled at the carton slide, wrapped, weighed and shipped.

Office partitions are removable in four-foot sections. They are designed so that uniform light and air conditioning can be employed for one large area. The cornice of the partitions is recessed to house electrical conduit. The architect reports that these partitions have proved very easy to maintain and are extremely economical. As the photographs indicate, acoustical treatment is liberally used.

It seems to be standard practice in buildings of this type to plan considerable expansion in the original scheme, then to start that expansion soon after the building opens. Here the first phase has begun with the addition of a mezzanine over bays 8 to 10 (from the left). Eventually conduit will go to a new building.

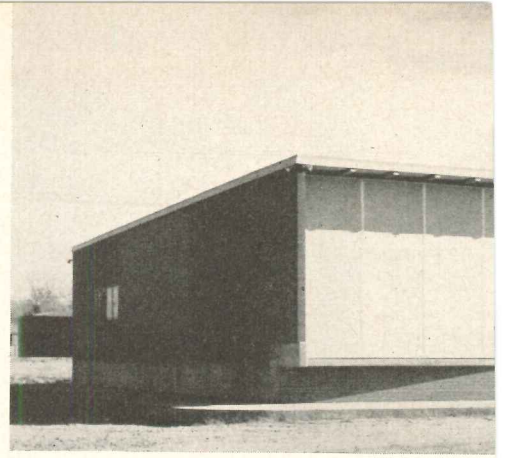

Winter Prather

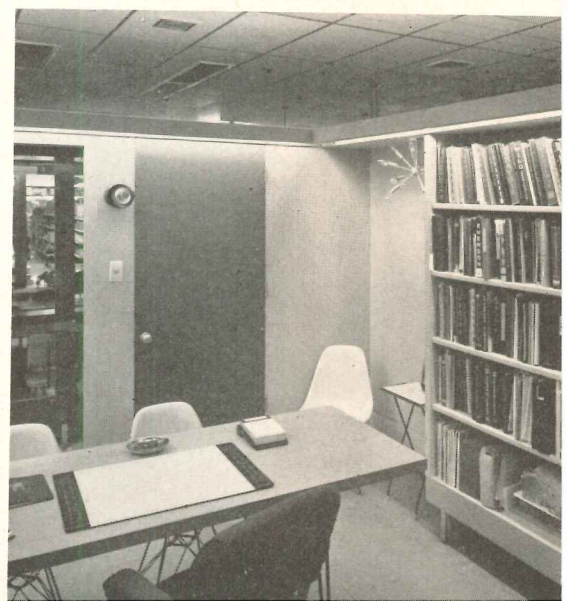
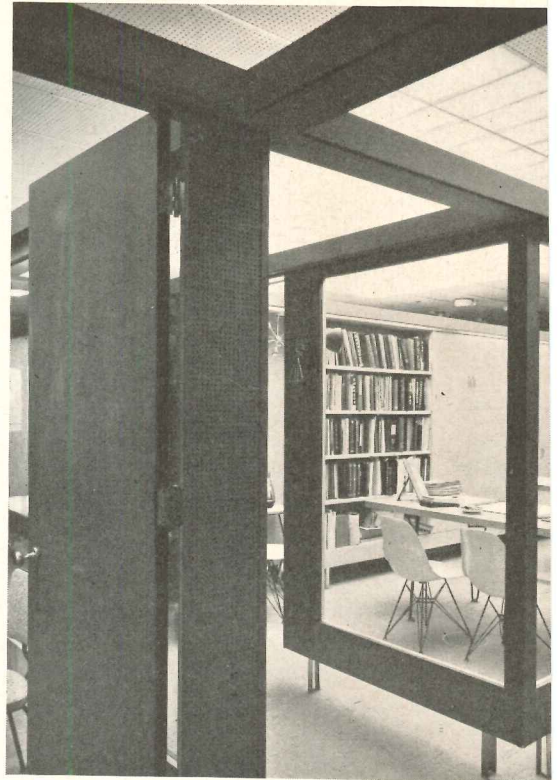

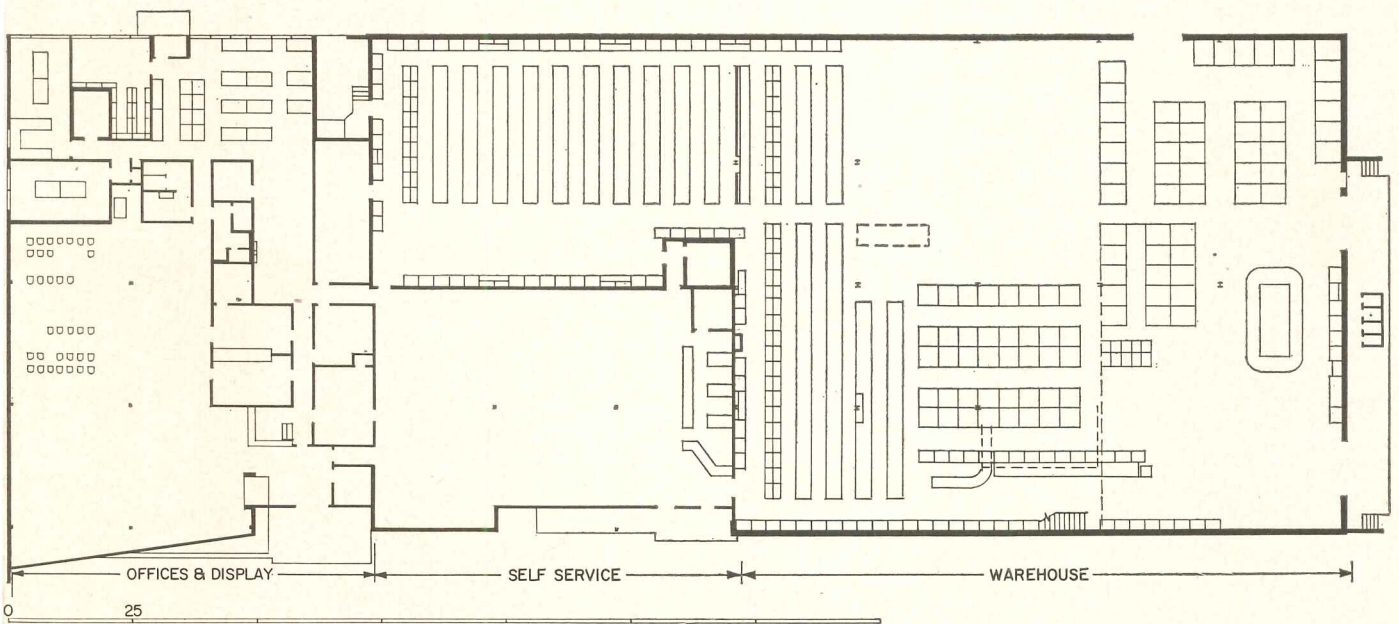
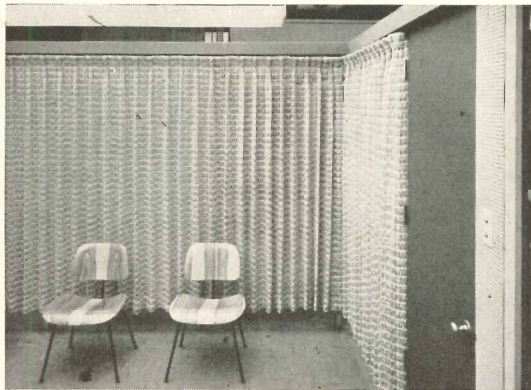

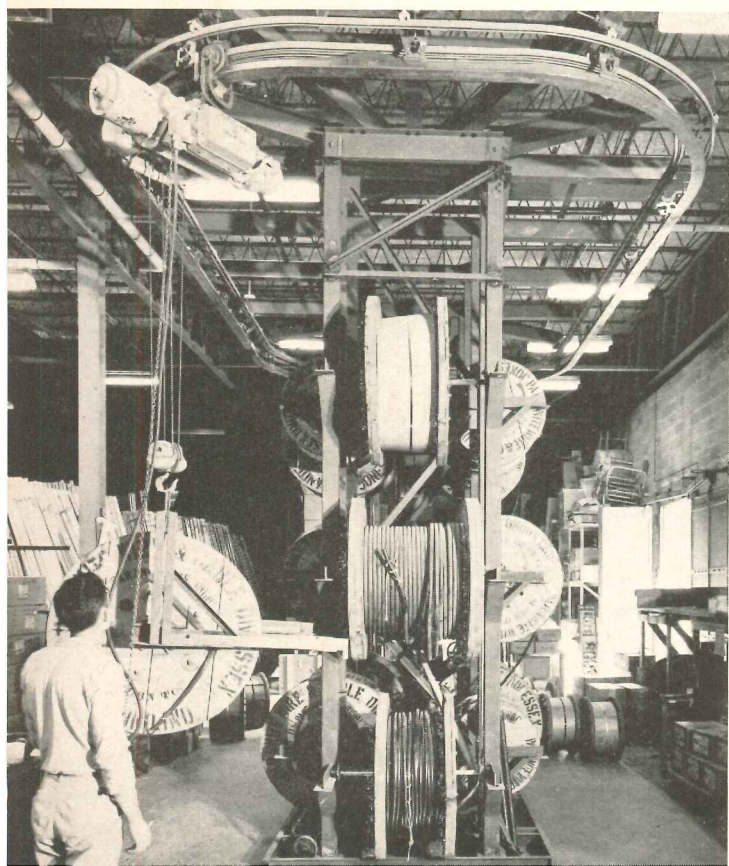
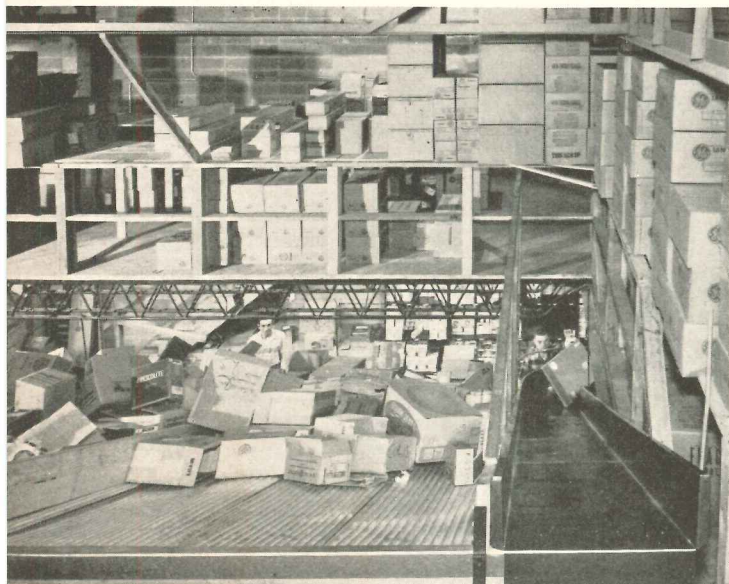

WAREHOUSES

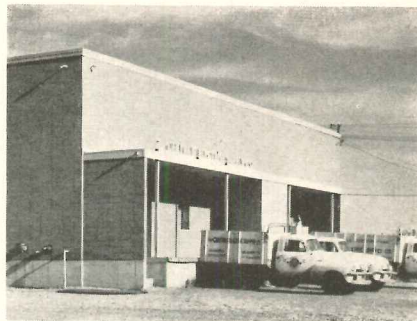

Shelving indicated on the plan is all of steel; conduit racks were designed for steel but were adapted to Unistrut construction. The special rack for cable reels was employed to conserve floor space. The carton chule was devised to simplify the work of packing a great variety of items.

Due to foundation problems, the building is supported on caissons. Main floor is reinforced concrete. Frame is steel; all walls are concrete block, glass and asbestos-cement panels. Roof deck is flat, poured gypsum.

The building was planned for expansion to the north, west and south. A mezzanine is now being added in one part of the warehouse; it is planned to move the conduit part of the operation eventually to a separate building.

PREFABS OR PROPRIETARY PLANS FOR SCHOOLS?

Many American architects and educators are sincerely interested in the possibilities mass production and distribution open up; the demonstrated American enthusiasm for good new building products forces us so to believe. Yet some current examples of prefabricated schools in this country raise serious architectural questions as to quality, suitability and maintenance; while some educators, and laymen not so conversant with either sound design and construction or the imperative nature of local site and educational requirements, seem more willing to accept "prefabs" as a panacea. Furthermore, and naturally when there is deep public concern over rising costs, developing educational concepts and staggering pupil loads, eagerness to find an inexpensive, speedy way out leads to confused ideas. The confusion is not dissipated when patented plans, proprietary schemes and packaged building units are all labelled "prefabrication," particularly when some of the systems which *are* entitled to the label involve little more standardization of parts than is available on the American market for custom-built schools.

On the other hand, Britain has produced several prefabrication systems comprised of components adaptable to varying site conditions and educational needs, systems which place few limitations on design and produce permanent buildings of high quality. While their governing conditions are different than ours — in matters political and economic, the availability of materials and labor, for instance — the fact remains that British prefabrication systems work and work quite well.

The following material offers a chance to make comparisons not so much of results (though these are important!) as of principles. First is a description of British practice by an English authority who has in the past spent many months in the U. S. appraising our school buildings, who lectured before New England architects and educators last November at Cambridge, Mass., and who has been intimately concerned with the development of British prefabrication systems. Second is a report on three American systems prepared by the staff of *Architectural Record*.

— Frank G. Lopez, A.I.A.

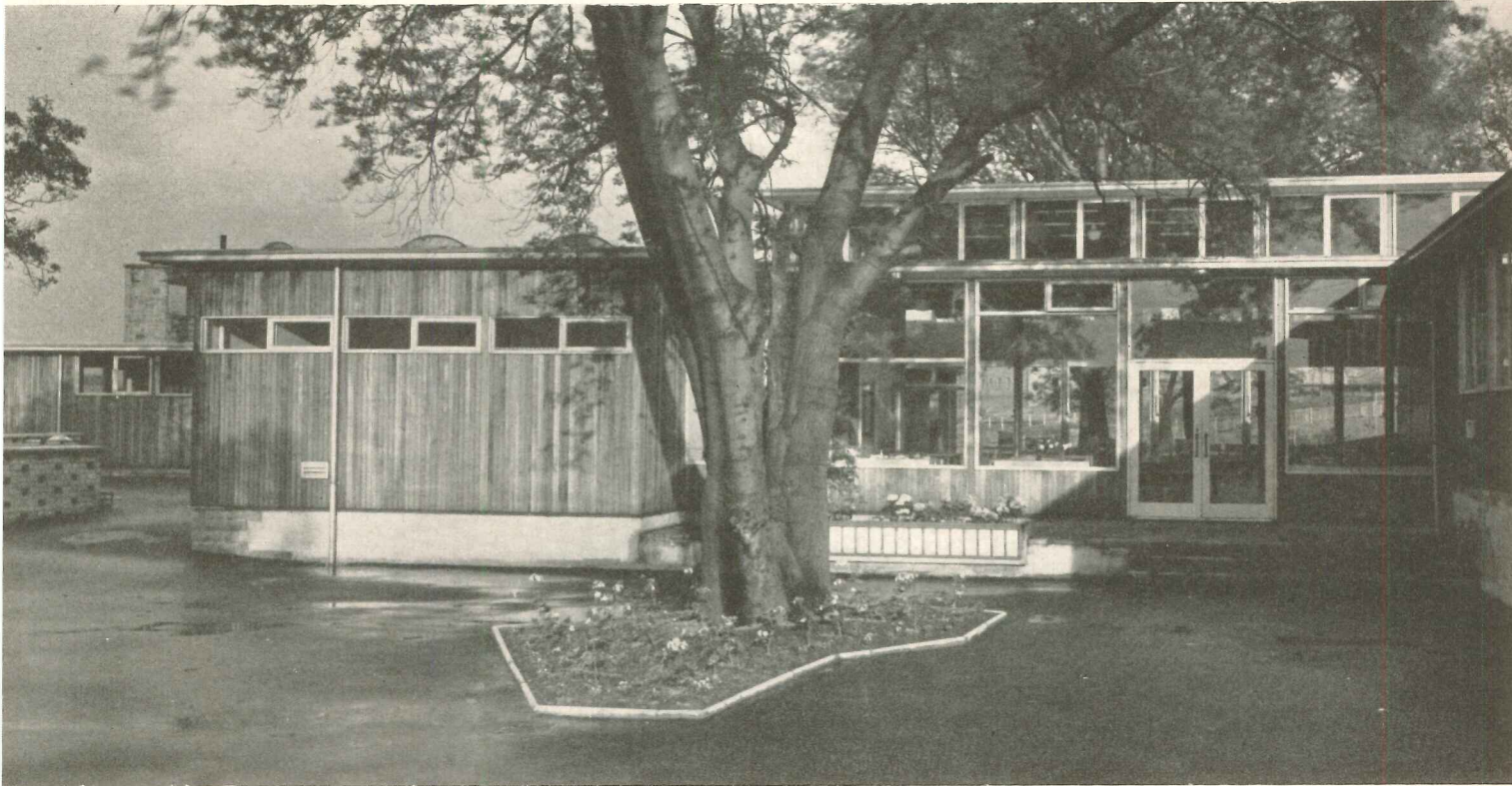

Prefabrication in England: Hackenthorpe Primary School, Derbyshire, uses the Derwent (wood) system (photo: British Ministry of Education, courtesy Vic Hallam, designers of the system)

I: PREFABRICATED SCHOOLS IN BRITAIN

by Anthony Part, Under Secretary, British Ministry of Education

ABOUT ONE-FIFTH of the new school buildings now under construction in England and Wales are largely or entirely prefabricated. They are not sub-standard or temporary buildings, they are not limited to a single storey and they do not involve standard classrooms,

still less standard plans for whole schools. Above all, the systems from which they are constructed have not been designed to dispense with the services of architects. Indeed, if there is any merit in prefabricated British schools today, it is largely because a

major part has been played in the design both of them and of the components of which they are constructed by some of the most talented architects in the country.

During World War II it became clear that the post-war building industry

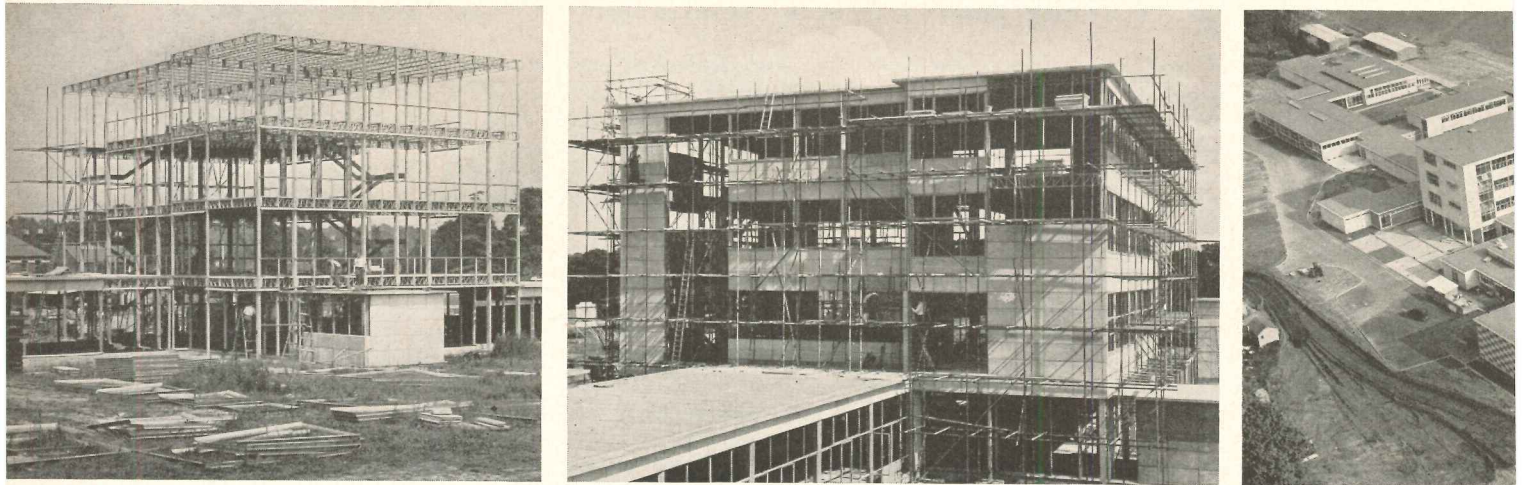

ST. CRISPIN'S SECONDARY SCHOOL (for 600 boys and girls), Wokingham, designed for the Berkshire County Council by the Development Group, British Ministry of Education, is a prototype for multi-story use of the Hills system (light steel frame, precast concrete cladding) used in earlier single story schools. 4-story block (left, July 1, 1952; center, Sept. 2, 1952) has 3 upper floors of classrooms grouped around a workroom. Air view and plan: social areas (one story but of varying heights) at right, entrance and library (classroom block over) at center, craft and science rooms (and a 2-story classroom unit) at left. About $\frac{1}{5}$ of the 29 acre site is shown

PREFABS IN BRITAIN (Cont'd.)

would be unable to handle the immense volume of construction required unless, in some areas at least, prefabrication were used. One house in every four and one school in every five was destroyed or damaged and large new populations would have to be provided for. Britain needed, among many other things, new steel plants and electricity generating stations and planned to establish for the first time oil refineries. In these circumstances prefabrication could help by saving man-hours on the drawing board (in factories as well as architects' offices) and on the site.

There was much argument at first about methods. Prefabrication means different things to different people. Discussions raged furiously about modules: should they be one-way or two-way? Should they be large or small? Those who opposed prefabrication of any kind claimed not to know what all the fuss was about. Most building components nowadays, they said, are prefabricated, even (they added correctly but mischievously) bricks. In the end, however, several important things became clear.

First, prefabrication for schools should be conceived as the mass production in factories neither of whole schools in a sense comparable with totally prefabricated houses, nor of individual units of a school, such as classrooms, gymnasias and kitchens but of ranges of com-

ponents which could be assembled in a great variety of ways. What was needed was a series of meccano sets. In other words, each system should be flexible enough to allow architects to approach the design of each school as an individual problem with its own educational requirements and site conditions.

Second, any system evolved must permit economical lay-out and be flexible to deal with variations in site level.

Third, though most of the prefabricated components would be used in the shell of the superstructure, designers would have to bear in mind such other needs as heating, lighting and plumbing.

Fourth, it seemed unlikely that prefabricated systems could be marketed much, if at all, below the price of traditional construction. They must therefore have a length of life and a quality comparable with more conventional structures. For these reasons substandard or temporary buildings would be unacceptable. To produce good prefabricated buildings with a long life did not seem impossible. Quality and permanence depend on specifications and skill in design rather than on technique of production and erection.

Fifth, because most of the schools first needed would be primary, single-storey buildings would probably be sufficient. But parts at least of secondary schools would need to be multi-storey, so as time went by, more elaborate systems would be required and the problems of vertical

modules would have to be studied more closely.

Sixth, crude plan shapes, like those of Army camps, would not meet the varied demands of modern educators. (More is said about this later in this article). In order to give the architect freedom to meet these demands, there would have to be a two-way horizontal module with a related vertical module.

What size should the modules be? No one pretends yet to have produced the ultimate answer to this question. But modules of some kind seem to be essential if the range of factory-made components is to be kept within reasonable bounds and if the architect is to have a set of components which does not constantly impede flexibility of design.

An early suggestion of 8'-3" for a horizontal module (related to the length of a classroom) was discarded in favour of a more human scale which would also allow of more flexible and economical planning. The module now most generally used is 3'-4", but the economic width of aluminum and timber panels has caused several designers in these two materials to use modules of 4' and about 6' respectively.

Vertical modules are usually either 10" or 2'. One important feature of all the best prefabricated systems for British schools is that in order to keep down the number of components there is a constant depth between the ceiling of one storey and the floor of the storey

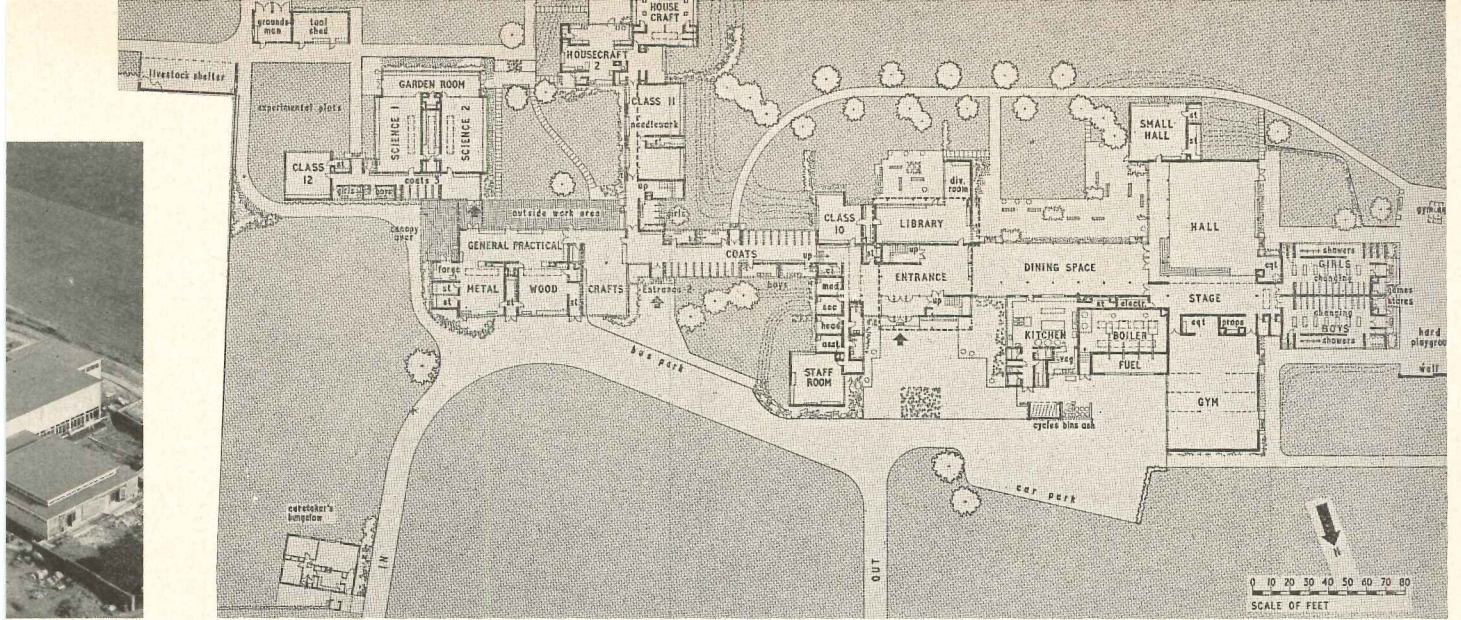

Illustrations courtesy British Ministry of Education (Crown Copyright Reserved)

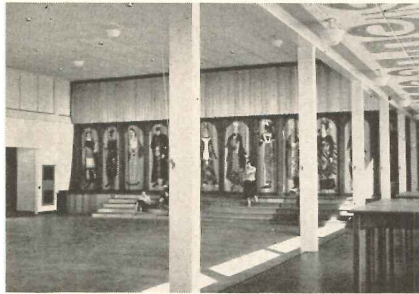

Above, Assembly Hall; raised aisle at right also used for drama and music

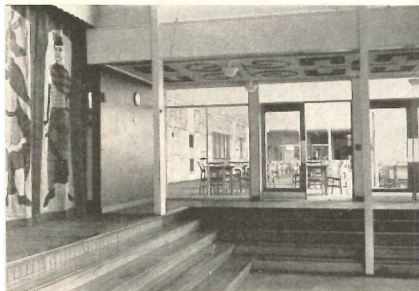

Above, Dining Room from Assembly Hall. Stage curtain: Enid Everard, Gerald Holton



Above, Dining Room; right, stair to classrooms. Wall, ceiling decor: Oliver Cox



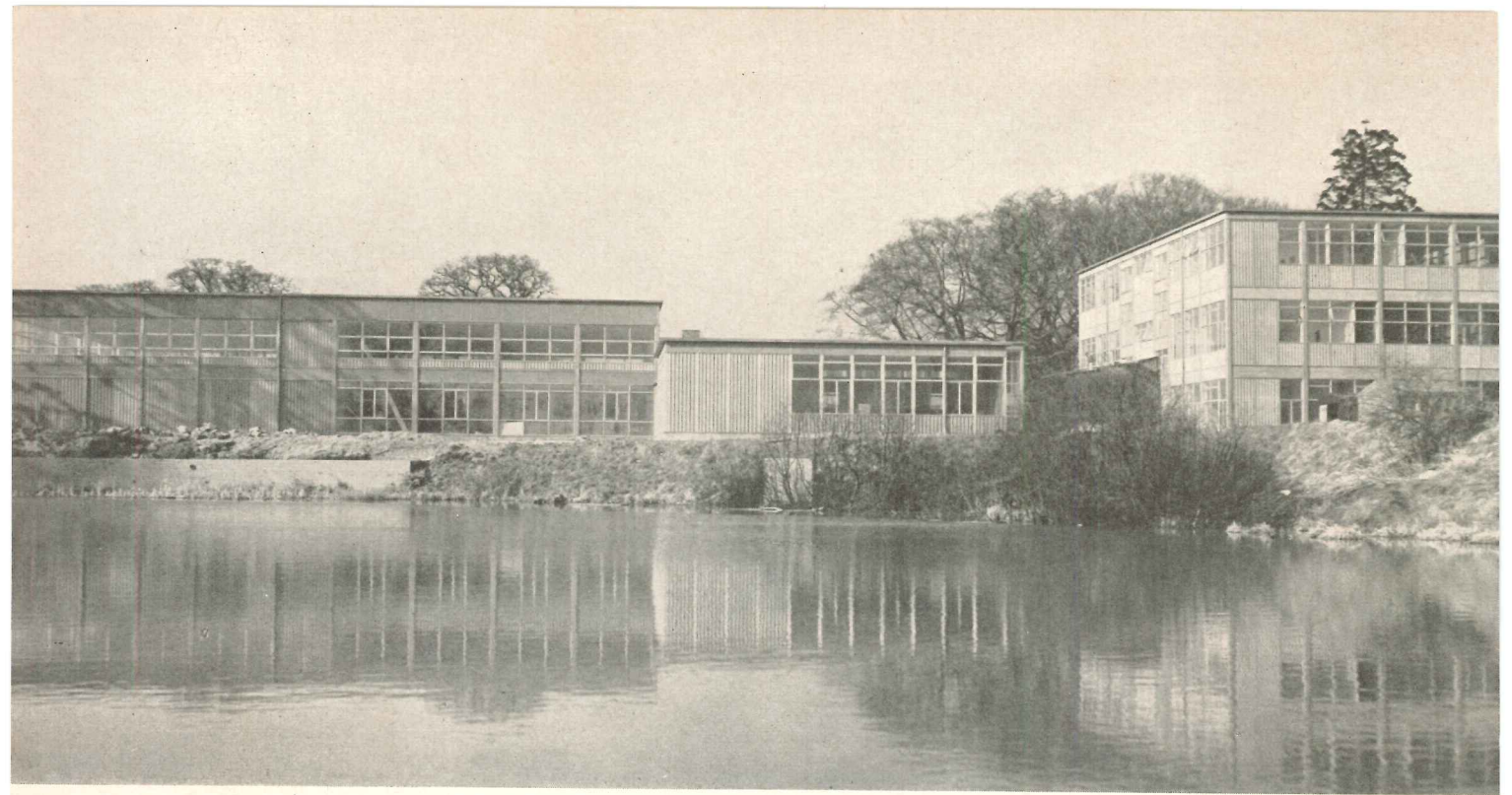

WHITLEY ABBEY (COMPREHENSIVE) SECONDARY SCHOOL at Coventry employs the aluminum system developed by the Bristol Aeroplane Company: steel frame and aluminum cladding. *Elegance, neatness, fine finish characterize school buildings using this system*

PREFABS IN BRITAIN (Cont'd.)

above. A second is that beams, whether made of steel, aluminum, concrete or — in some cases — timber, are of open web type so as to allow heating pipes and other services to be run free of the structure.

The most prominent early developments were undertaken immediately after the war by the Hertfordshire County Council. Faced with the need for about twenty new schools a year they worked closely with Hills (West Bromwich), a firm of engineers, on the design of a system which has since become widely known abroad.

Many architects, especially perhaps those of the older generation, looked upon prefabrication as a necessary evil. The young Hertfordshire team, assembled under the experienced guidance of the County Architect, Mr. C. H. Aslin (who now holds office as the President of the R.I.B.A.) took a more positive view. They believed that prefabrication would enable them to match the demands of educators more successfully than would traditional methods and to create efficient yet attractive buildings in a modern idiom. The architects worked very closely with the manufacturers, often spending long periods in the factory in order to make themselves

familiar with its economics and the capabilities of the plant.

Since then other authorities and manufacturers have entered the market, and for the last five years much of the running has been made by the Development Group which was set up at the Ministry of Education in 1949. This is a team of architects, quantity surveyors, educators and administrators whose main task has been to design systems of prefabrication suitable for secondary schools, to try out the architectural implications of advanced educational practice and to fit the whole into an administration pattern which is valid for school building on a large scale. In all these operations, teamwork has proved essential. If any member had been left out of the team, these projects could hardly have been brought to a successful conclusion.

The control of cost has been a vital factor throughout. Every new school in England and Wales has to be built up to a standard and down to a price. (The standards are described in terms of results to be achieved, not of detailed methods to be used. For example, the amount of daylight required in a classroom, not the height of a classroom ceiling.) The maximum permitted price is described in terms of cost per child, based on a formula carefully designed to

put all projects on a reasonably comparable basis. No special extra costs are allowed either for prefabricated schools in general or prototypes in particular.

It follows that neither the Ministry of Education nor local education authorities (school boards) let any development contracts such as are common, for example, in the aircraft industry. The cost of developing new systems is therefore borne by the manufacturers. The manufacturers are prepared to do this for three reasons.

First, because the Ministry of Education has been able to convince them that with the certainty of a very large school building program to house the post-war "bulge" of children, they would have an excellent chance of marketing their products successfully, at least in the many important areas in which building labour is scarce.

Second, because the system of annual building programs established by the Ministry in 1947 gives notice about two years ahead to local education authorities of the schools which they will be permitted to build, thus enabling large authorities to place substantial orders well in advance of the dates when the components will be needed on the site.

Third, because of the development of the method of cost planning described in Ministry of Education Building Bulletin

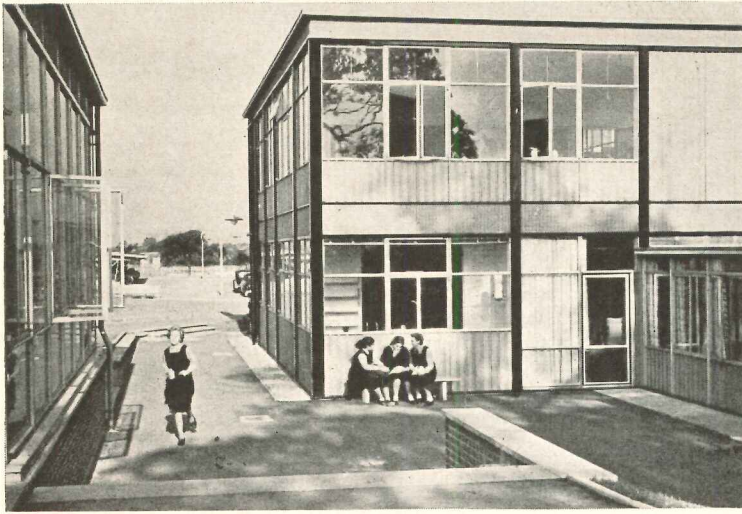
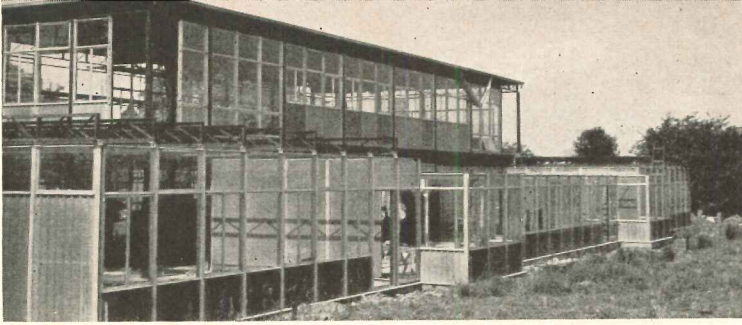

LYNG HALL SECONDARY SCHOOL, for girls, also at Coventry and also built according to the aluminum system. Top photo illustrates flexibility resulting from use of the same horizontal module in both directions. Changes of site level can be taken care of by all the systems illustrated in this article. Center: black paint is here used to outline the structure; strong color on some partitions is visible from outside. Bottom: Lyng Hall is divided into a number of "houses" for 150 girls each; girls have dinner and several classes in "house" rooms, one of which is pictured



Illustrations courtesy British Ministry of Education (Crown Copyright Reserved)

BELPER SECONDARY SCHOOL, Derbyshire, uses the Brockhouse system, which consists of a cold rolled steel frame with cladding of precast concrete on the ground floor and asbestos cement sheet on upper stories. Concrete panels first used were sound but unsatisfactory in appearance. Now an exposed aggregate is employed and considerable variation in color is available at reasonable cost. (Photo at right © F. W. L. Heathcote)

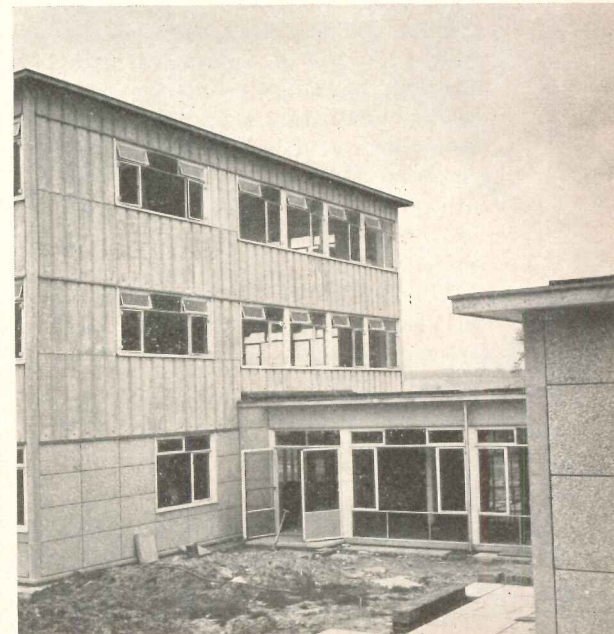
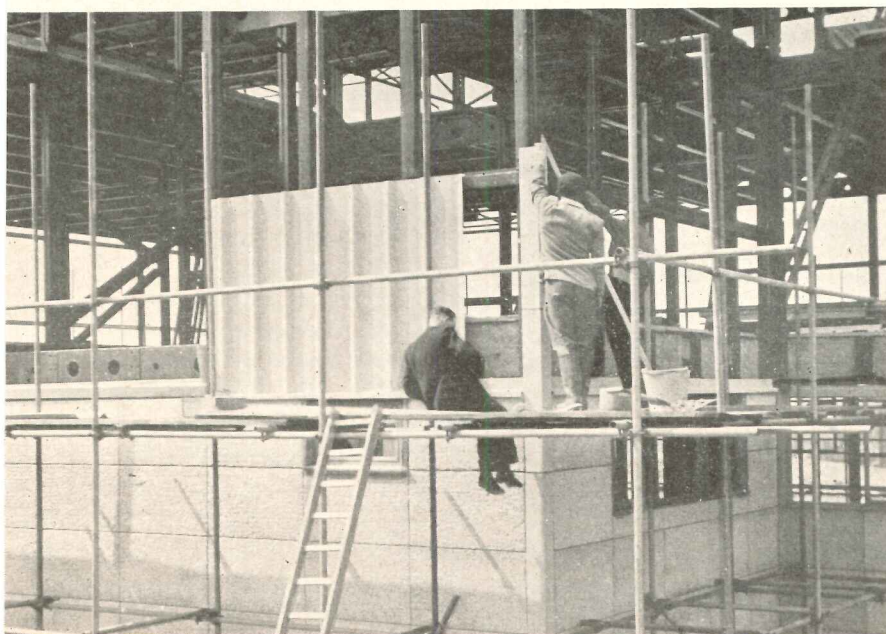

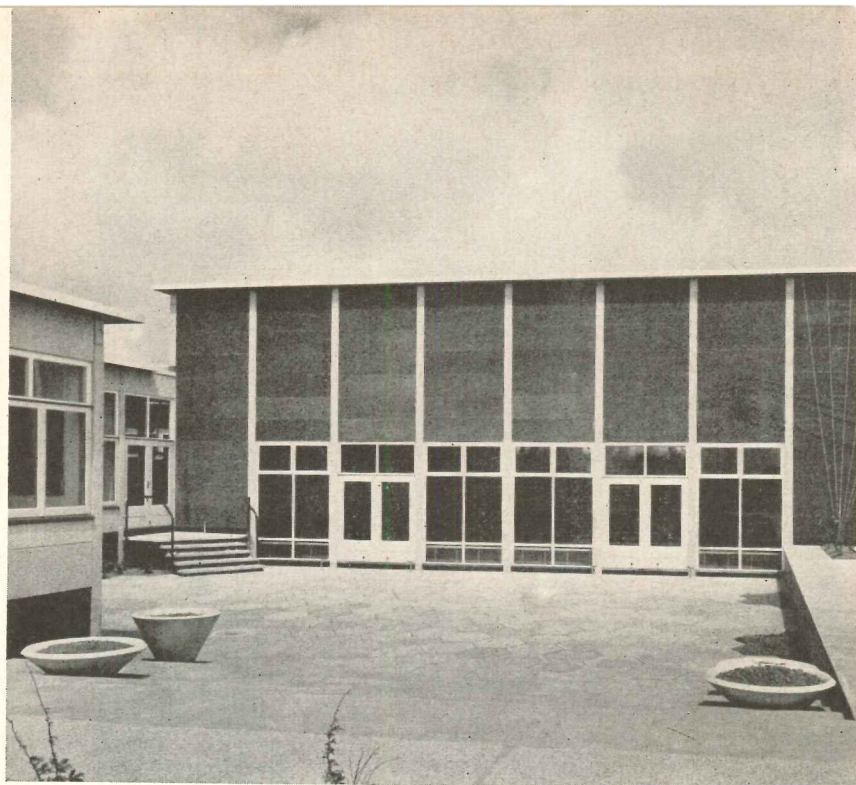
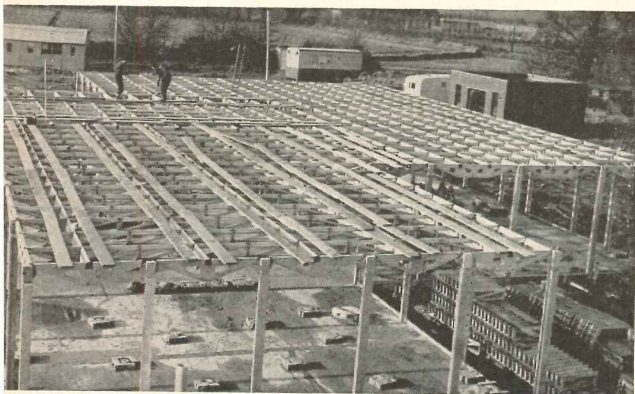
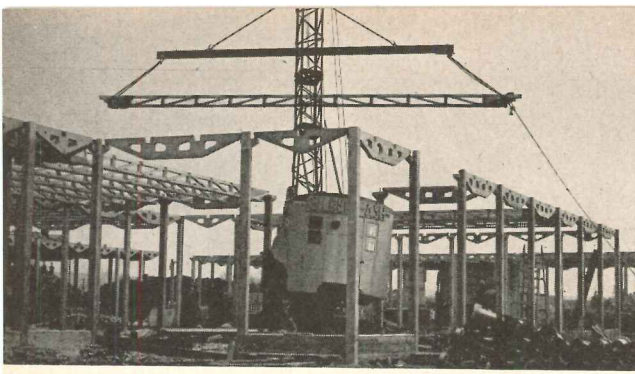

WORTHING TECHNICAL HIGH SCHOOL (600 boys and girls), built in 1954, was the prototype for the "Inter-grid" system pioneered by Messrs. Gilbert-Ash — believed to be the first prefabricated modular system ever designed in pre-stressed concrete. Concrete beam components, 3 ft 4 in. long, are factory made and post-tensioned on the site by the Freyssinet method. Tower columns are 6 in. by 4 in. At Worthing, stairwells were cast on the site; in later work they have been entirely prefabricated. At right: drama court adjoins Assembly Hall. Black cladding slabs have exposed aggregate of granite chips (photo from Cement and Concrete Ass'n.)

PREFABS IN BRITAIN (Cont'd.)

No. 4*. This method involves analysing the cost per square foot of previous projects and using the analysis to set up a target cost for each element of the building. Thus at sketch plan stage the architect knows how much he can afford to spend on each element instead of working against the less precise background of a cost per square foot for the building as a whole based on his general experience. In Britain the analysis is done by the quantity surveyor and the target costs are agreed between him and the architect. Cost planning then enables architects to know while they are designing a system of construction how much they can afford to spend on any material or element. Thus, the manufacturer does not have to fear that the components used in the prototype will have to be radically altered in order to enable the system to be sold at an acceptable price.

This means that the manufacturer need not wait until the prototype has been erected to bid for orders and go

* The Ministry of Education building Bulletins are obtainable from British Information Services, 30 Rockefeller Plaza, New York 20.

into production. Once any necessary tests such as structural or fire tests have been carried out he can go ahead, thus saving 12 or 24 months which are invaluable to him financially. One manufacturer contracted to sell the components for 15 schools while his prototype was still under construction.

There now exist quite a number of prefabricated systems. Leaving aside those which provide only part of the superstructure or are limited to single-storey buildings, the main systems are as follows:

- a light steel frame with cladding of thin concrete slabs faced with stone dippings, and internal partitions of gypsum plaster;
- a steel frame with aluminum cladding and partitions of factory-made panels faced with gypsum plaster;
- a cold rolled steel frame with cladding of pre-cast concrete on the first floor and asbestos cement sheet on the upper storeys, and internal partitions of gypsum plaster;
- a pre-stressed concrete frame with

pre-cast cladding and internal partitions of gypsum plaster. This system, in spite of its adaptability, contains only twenty-six components; they are all small factory-cast units which are assembled and post-tensioned on the site;

several timber systems: most of the exterior cladding is in hardwood, except in one case where it is plywood. Extensive research on fire hazards has enabled satisfactory arrangements to be made for the construction of timber schools of more than one storey.

The first system mentioned is described in detail in Ministry of Education Building Bulletin No. 8*. This Bulletin tells the story of the creation of Saint Crispin's secondary school at Wokingham designed by the Ministry's Development Group for the Berkshire County Council. This project has so far exercised more influence on post-war secondary school design than any other. The bulletin sets out much of the thinking underlying the British approach to prefabrication for schools and illustrates the practical application of a system to the problems set by the educators.

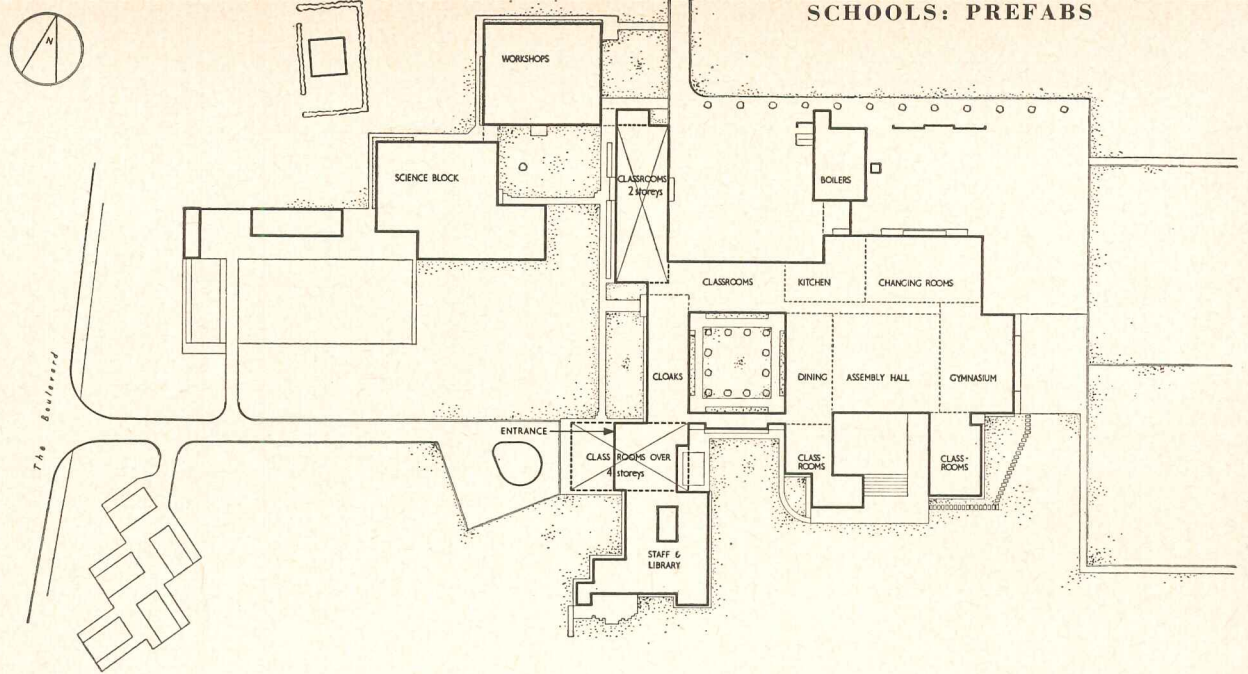
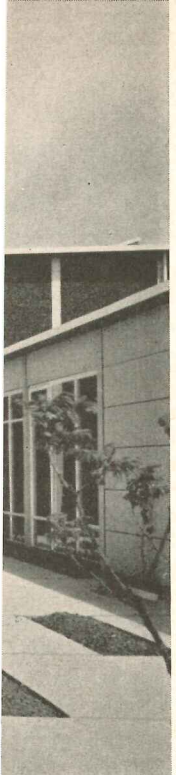

Worthing plan, above, compared to St. Crispin's (previously shown), indicates great variety possible in organization; prefabrication of these types permits great freedom in design. Below, typical beams, one of several types of columns, cladding panels, assembly details

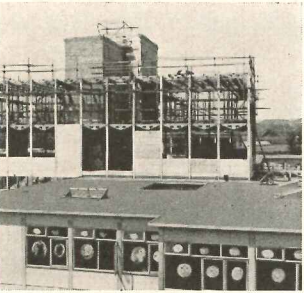

Photos courtesy British Ministry of Education (Crown Copyright Reserved)

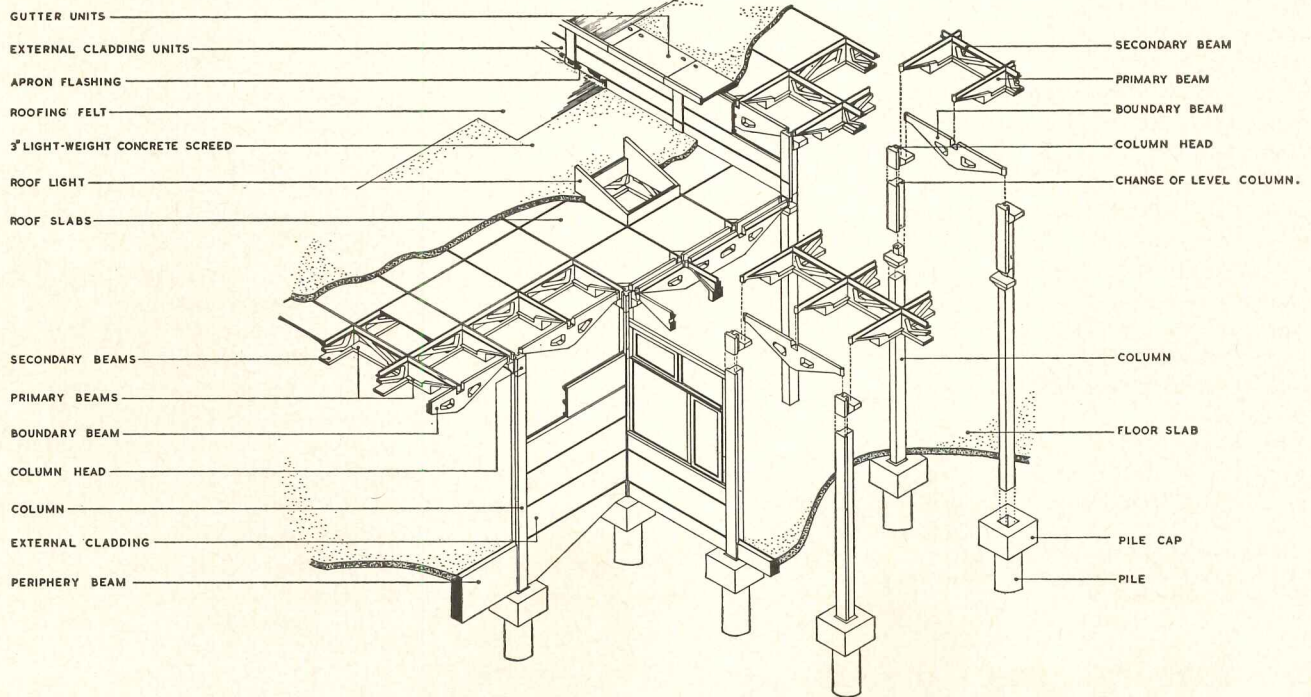
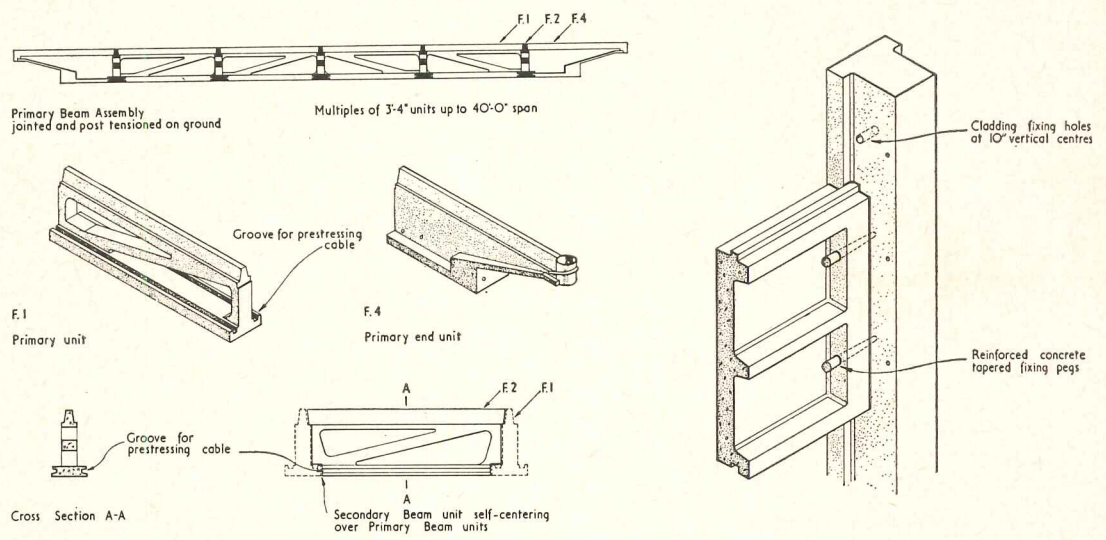

PREFABS IN BRITAIN (Cont'd.)

British educators have fairly definite ideas about the kind of secondary education which they wish to develop. But those educators who have worked closely on development projects with architects have learnt a great deal from the cut and thrust of detailed discussion. It is one thing to proclaim an educational principle, such as the desirability of enabling work sometimes to be organised in small groups: it is another to be forced to think clearly precisely what that means in terms of both school organization and architecture.

What can be said of the buildings which have so far resulted from these efforts? Impartial observers seem to agree that they are efficient and economical and that in scale and use of color they are quite strikingly successful. The architects have also often devoted much care to landscaping and to the use of murals and sometimes sculpture.

Critics are, I think, less unanimous about the external appearance of the buildings. Doubts arise on two counts,

texture and proportion.

Because of the dominating position of brick in the British building industry, it was clear ten years ago that anyone wanting to promote prefabrication would have to pay a great deal of attention to the quality and appearance of the external walling. The early efforts in pre-cast concrete did not fill the bill. They were too crude. After much experiment, slabs have been evolved which have a finish of exposed aggregate and which can be produced at a reasonable price. These slabs are available in three or four different colors and have a sparkle which the earlier slabs lacked.

Asbestos cement sheeting is not normally regarded as an attractive material, but the corrugated pattern used has enhanced its appearance and the decision not to use it on the first floor saves it from damage.

Aluminium is more readily acceptable. Although its use for walling is very unfamiliar in Britain it has a clean-cut quality which associates it in people's minds with engineering rather than building. People who look at a building

in concrete compare it, subconsciously at least, with a brick building and because many modern architects who work in concrete have an imperfect mastery of external detailing, the observer is apt to think (often mistakenly) how much nicer the building would have been in brick. Aluminium is different. Visually it is so far removed from brick that the observer has consciously to construct a whole new series of values. He is then often ready to be pleased by the elegance, neatness and fine finish of the material.

Timber, of course, raises no aesthetic difficulties in a new building. The problem is how to ensure that it is adequately preserved without gradually assuming a tawdry or depressing appearance. Some success has been claimed in this respect but it is too early to judge the results.

The texture of the individual components of the external walling is, then, no longer a major handicap, but the handling of the exterior as a whole often seems to leave something to be desired. Most post-war British architects are to my mind better at the insides than at

II: PREFABRICATED AND PROPRIETARY CONCEPTS OFFERED FOR

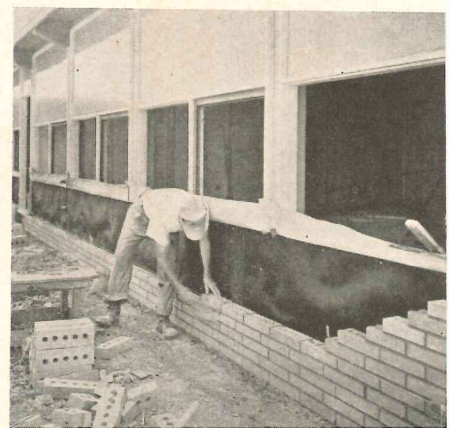
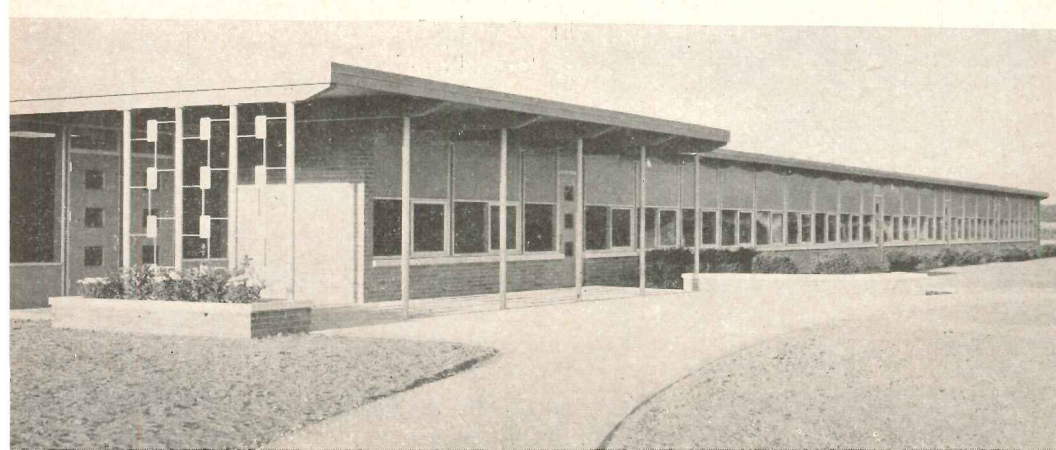
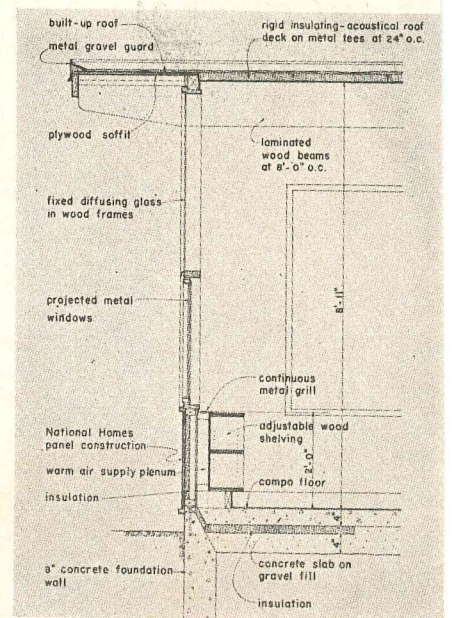
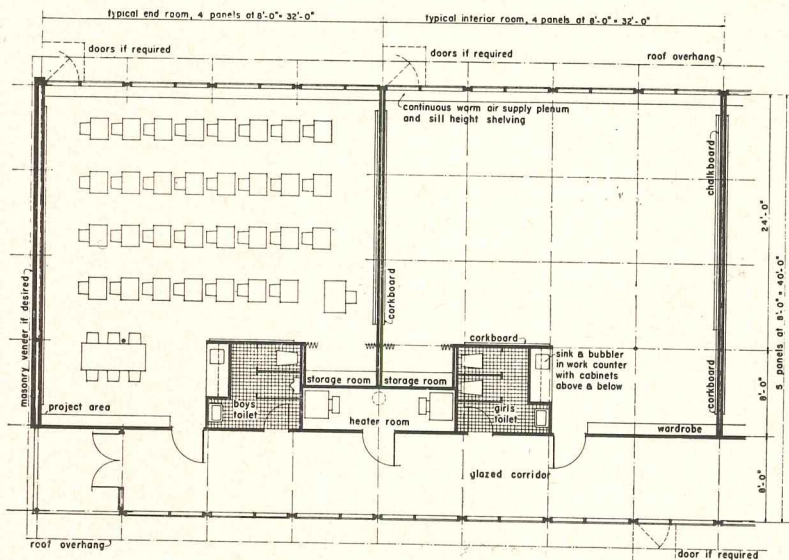

the outsides of buildings. The prefabricated systems mentioned in this article all seem to result in buildings which give an impression of lightness and sometimes grace, and the use of a module provides a kind of organic rhythm which knits the building together and avoids the restlessness which, to me at least, characterises many modern exteriors. Nevertheless, the first sight of many of the prefabricated British schools — the immediate impact on a visitor, even one like myself who has seen large numbers of them — is not always pleasing. It is hard to say where the fault lies, possibly in the design of the eaves, possibly in the lack of variety in window and cladding sizes available for multi-storey building, possibly in the lack of ingenuity on occasions in the use of external color (or color seen externally) to relieve the monotony which is apt to result from a large walling surface of glass and concrete.

Some will regret also that in a prefabricated system devised for plan forms which require a two-way horizontal module, a pitched roof increases the

number of components prohibitively. It is therefore impossible as a general rule, and luxurious if used as a "special" component on particular occasions.

One must, however, always return to the fact that these are low-cost buildings †. The encouraging thing about them, in my view, is the quality which has been achieved within the cost, in other words the value for money.

Indeed, the skill devoted to the best of them has put them among the best British post-war schools. This fact represents a fine advertisement for prefabrication even if it is not yet a guarantee that prefabrication will be widely used ten years from now when the pressure of the post-war "bulge" of children is over. Tradition, symbolised one suspects by bricks and pitched roofs and the deeply rooted British passion for individuality, is sure to attempt a counter-attack.

Nevertheless most of the present systems are being widely used on other building types and there are many architects today who are more than fair weather friends to prefabrication. In-

clined to it in theory by their pre-war education and their views on the way in which building technique should develop, and pleased by the possibilities which have already been demonstrated in practice, these champions, many of them now in their 40's, will represent in the next decade an influential element in the profession. In a way it is a pity that their efforts so far have been tied to low-cost buildings. This has stimulated them to exciting achievements in clean design. But one could wish that every now and again circumstances would allow these designers to have the kind of financial elbow-room which a wealthy American suburban school board can give its architects so that they could, so to speak, open their shoulders and exploit their potentialities to the full.

† To quote actual figures for purposes of international comparison is nearly always misleading. The permitted cost per child of the secondary schools discussed in this article is £264 (for the building and fixed equipment, excluding site development and furniture). The equivalent in dollars at \$2.80 to the £ is \$740; but I think that, taking everything into account \$1500 might be a fairer comparative figure to quote.

AMERICAN SCHOOLS

NATIONAL HOMES CORP. SCHOOL UNIT (*Lafayette, Ind.*) provides a complete 2-classroom basic unit, to be multiplied as required. It is essentially a wood structure with standardized laminated wood beams and columns, standardized wood-framed, plasterboard wall panels of a type familiar in National Homes' houses, and roof deck of non-combustible panels laid on metal tees spanning between beams. Individual heating units are provided; many state codes may require more fireproof construction than is contemplated for the heater room. Architect Charles Goodman reportedly participated in development; Walter Scholer is credited as designer. After inspecting a pilot model in use at Lafayette, Ind. (site of National's main plant), an architect of substantial reputation in the school field has reported:

"Although in plan it was similar to another Lafayette school it cost much less, but nothing was said of the comparative quality of the two schools . . . unquestionably there would be high maintenance costs . . ."

WHAT WE loosely call prefabrication has not yet produced in the U. S. A. schools satisfactory to architects, excepting of course architects personally concerned with development of a system. Some non-architects may erroneously believe that architects fear the inroads prefabrication might make into established practices and fees. This is *not* the case.

In informal discussions with architects from all over the country, objections have been raised on three grounds: 1, **quality** of either structure or educational accommodations; 2, the "**packaged building**" concept which forces acceptance of a structure predesigned as well as prefabricated, when most architectural experience indicates that ignoring local site and climatic conditions is extremely expensive, and when educational experience emphasizes the need for an infinite variety in plan and design rather than the limitations which most American systems impose; 3, the **high true cost of most systems**, though initially some may seem cheap.

Far from fearing prefabrication, most architects will be found sincerely interested in any system which promises even

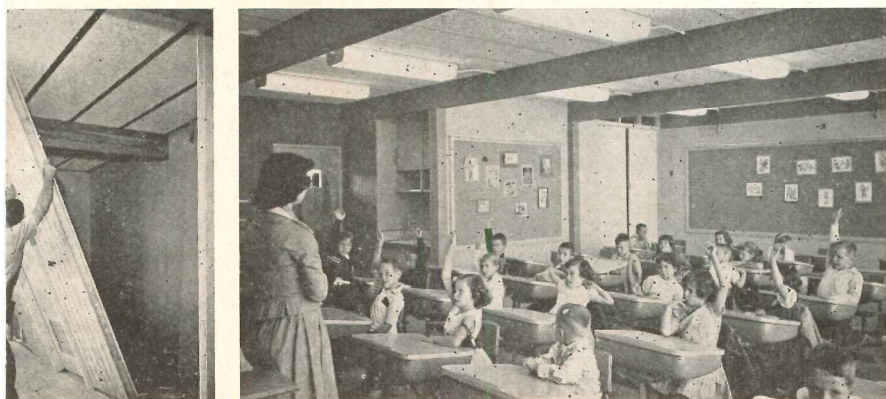

SCHOOLS: PREFABS

relatively good quality, without severe design restrictions, at reasonable true cost. They do worry about the client's interest: In buying a bargain does he pay far too much for the quality of the building he gets? Furthermore, the architect's position is fairly well protected; most states require localities to hire architects if state funds are involved. As public experience with low-quality prefabs multiplies, architects expect their competition to become increasingly unimportant though high-pressure campaigns may sell quite a few jobs. Another factor causes worry: an architect hired to "do" a prefab school has a continuing responsibility for the building's quality and performance, while the extent of the prefabricator's legal responsibility is a question.

Specific criticisms of the three illustrated types have been made by reputable architects after intensive investigation. The Maximlite school is not truly prefabricated; it is a copyrighted design employing conventional materials available, mostly in standard sizes, on the open market. Cost advantages which might accrue through mass purchasing of building materials through a central Maximlite source have, we are informed, seldom been realized, because the average local contractor has usually been able to buy materials just as cheaply. What manufacturer is going to jeopardize large segments of his market for a favored customer? A Maximlite job in New York state would have cost \$1170 per pupil if

(Text cont'd. on page 356)

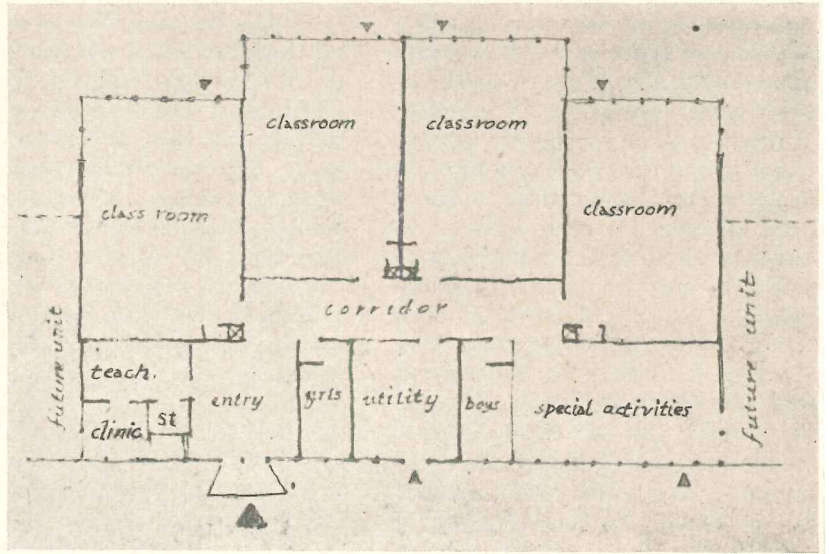

STRUCTO SCHOOLS (*Structo Schools Corp., 1 State St., Boston, Mass.*) are reportedly based on design research by Anderson-Nichols & Co. and marketed with appealing financial arrangements backed by extensive banking resources. Plans and information generally available are copyrighted and so cannot be reproduced in detail, but sketches above and right are believed to be correct. Construction is reportedly of quite high quality, consisting of an assembly of steel members and porcelain enamel panels selected from standard items available on the open market and selected for permanence, safety, attractiveness and low maintenance to assure a 50 year life. In many respects the plan is admirable, we are told; the building is designed to be erected in 90 days; it can be added to as a continuous building or used in "campus" plans. Financing is described in text

AMERICAN EXAMPLES

Maximlite school built at Fayetteville, Ark.

Maximlite variation proposed for a Maine community

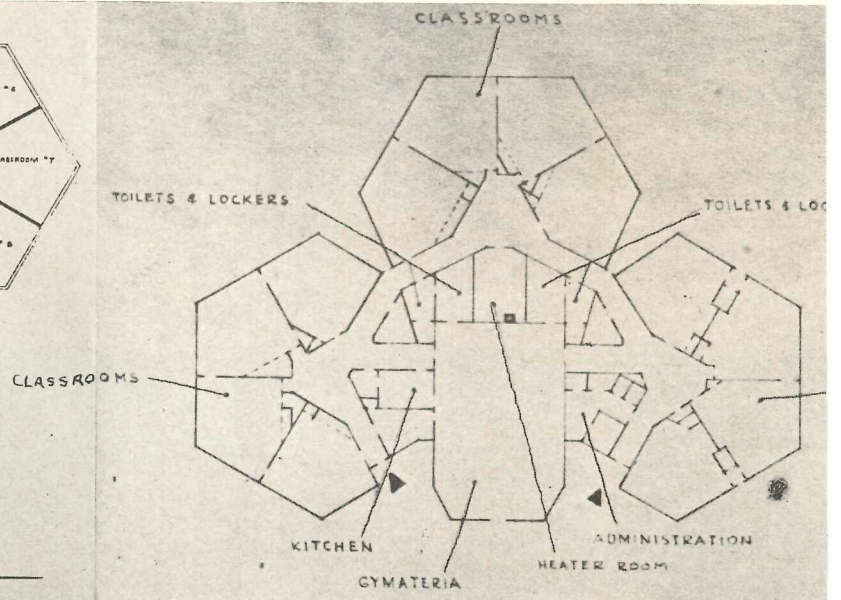
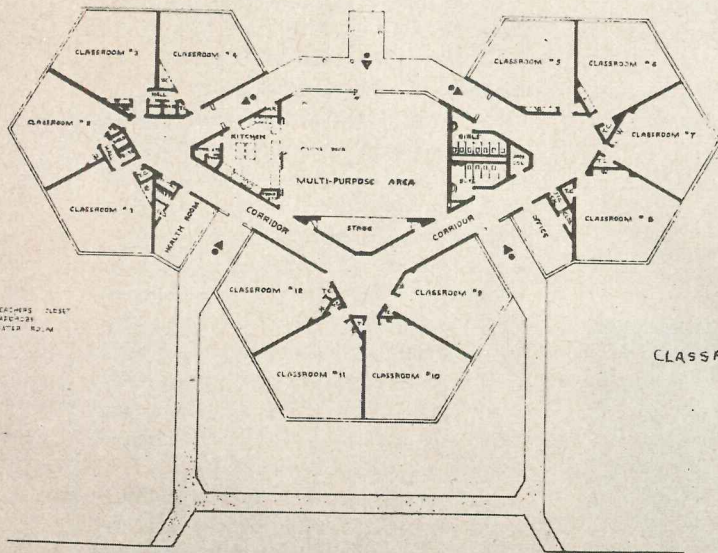

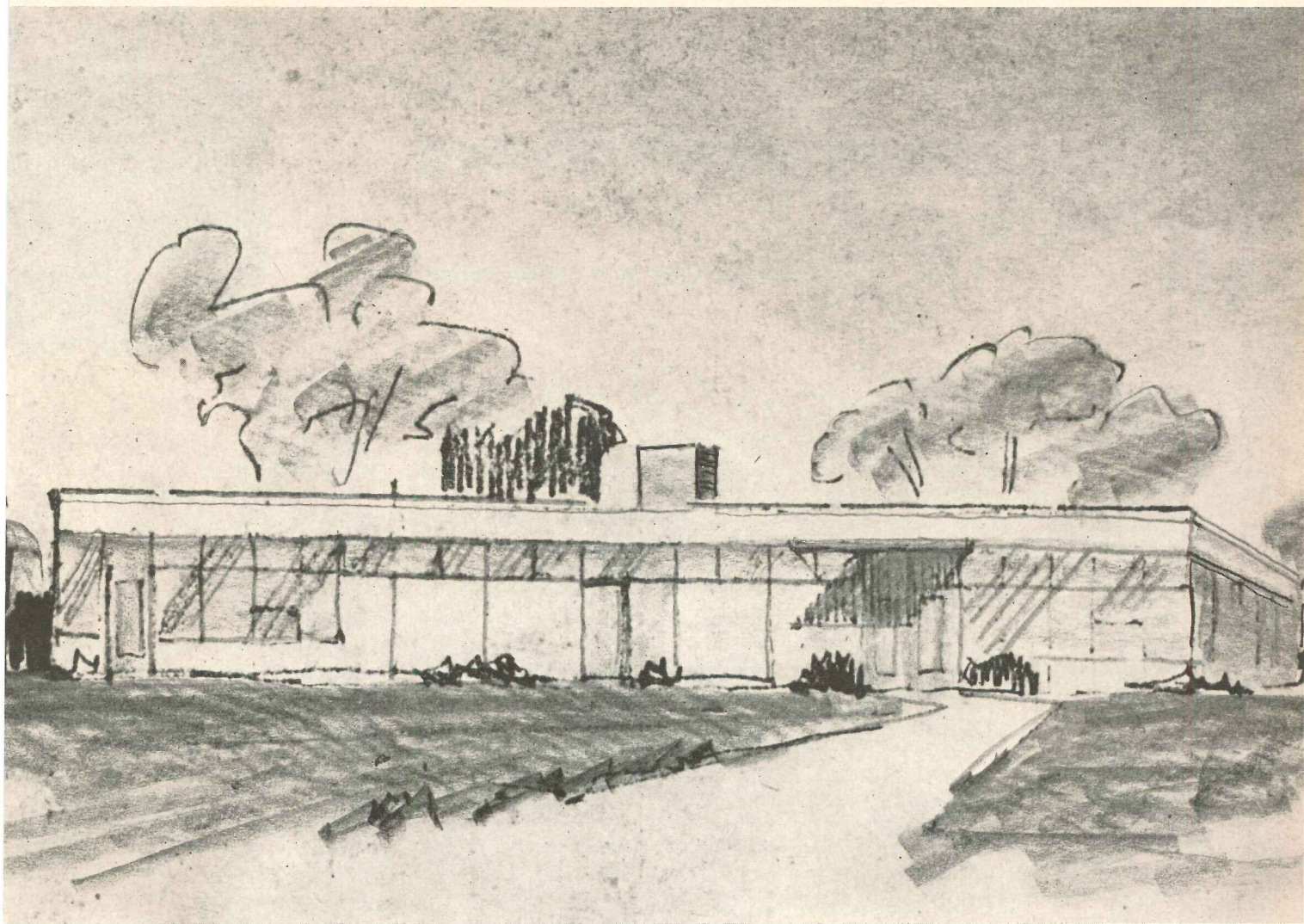

MAXIMLITE SCHOOLS (*1st National Bank Bldg., Fayetteville, Ark.*): original classroom and arrangement of rooms designed and copyrighted by T. Ewing Shelton, Architect. Local architects have been licensed to use the "system" in various arrangements; a degree of flexibility is possible. Construction: masonry bearing walls with flat roofs; exterior walls glass block (facing all points of the compass) above clear-glazed venting sash. A comparison of one variation with an efficient conventional plan for the same situation appears herewith. New York state school authorities required changes and improvements to bring another variation up to state requirements; bids came in far above preliminary estimates. Texas authorities rejected another for poor ventilation, too much glare from glass block areas, faulty orientation, inferior finishes. Massachusetts authorities have required masonry around heater rooms on still another. Others have called the classrooms small, tackboard insufficient, ventilation inadequate, etc.

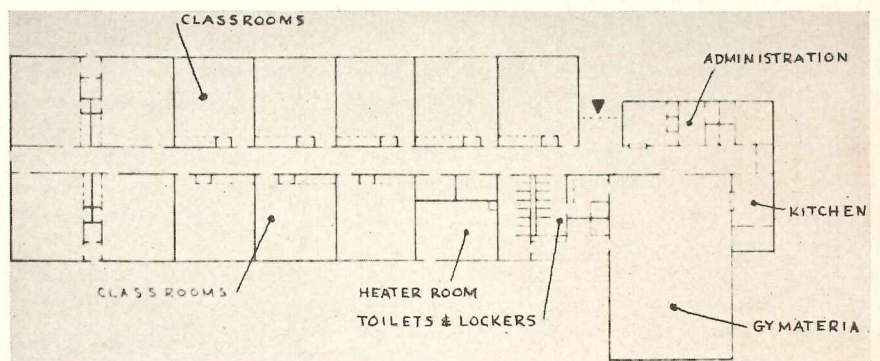

For purposes of comparison with the Maximlite school proposed for a Maine community (facing page) the above conventional plan was developed by a competent architect, incorporating the identical useful areas. The accompanying comparison resulted. Conclusion: conventional plan ought to be less expensive if built of the same materials, under the same conditions

Plan	COMPARISON	
	Maximlite	Conventional
Total area	18,000 sq ft	17,400
Perimeter	704 lin ft	674
Corridor area	2,570 sq ft	2,050
4 in. block partition	330 lin ft	231
8 in. block partition	851 lin ft	846
12 in. block partition	114 lin ft	100
Area per classroom	730 sq ft	730

WATER CONDITIONING

by Warren D. Calhoun and J. William Moffett *

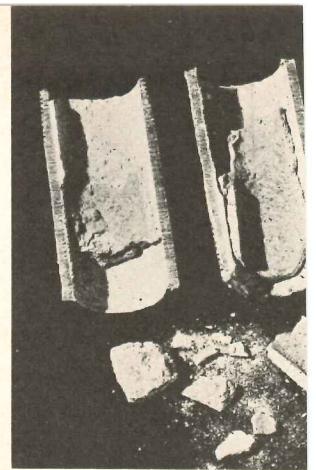

WITH THE STEADY MIGRATION of new construction beyond established metropolitan areas, more and more houses and buildings must rely on private wells for their water supply. Many municipal water systems also use underground sources. While architects and their clients will insist on a bacteriological check of well water before it is piped into a building, the same degree of caution is not exercised regarding some of the deleterious qualities of water such as hardness. Although water may be perfectly safe for human consumption, it can at the same time cause thousands of dollars worth of damage in large buildings and be a many-sided nuisance in all types of buildings. This can be equally true of water supplied from either private or municipal sources.

The discussion that follows is limited to water problems in homes, institutions and commercial buildings where the water is used for human consumption, sanitation, and for low-pressure heating systems. Many other problems are applicable to the process industries and to medium- and high-pressure boiler plants, but because of their complex nature, require the attention of experts.

Water is destructive because of the things it contains. Primarily these are dissolved minerals and gases. Many of them are colorless, odorless and tasteless and thus are practically impossible to detect by a casual examination of the water. Yet they can do a great deal of damage as soon as the water is piped, heated, or used for housekeeping chores.

Any of the following conditions, depending on the end use of the water, will cause trouble in buildings:

1. Hardness
2. Iron
3. Corrosive factors

HARDNESS

Hardness is one of the most geograph-

** Both of Ion Exchange Application Group, Rohm & Haas Co., Philadelphia, Pa.*

ically widespread causes of water problems (see map). Water is hard because it contains calcium and magnesium.

Water hardness may be expressed in "grains per gallon," one grain being equal to about 2/1000 ounce of hardness (calcium carbonate) per gallon. In industrial terminology water hardness is expressed as parts per million (ppm). One grain equals approximately 17 ppm.

Water of 0.4 grains and less is generally considered soft. Above 3 to 4 grains of hardness, water becomes progressively more troublesome, and above 8 grains — which is characteristic of the water supply of more than half of the nation — the water becomes a definite nuisance and a serious hazard to the life of plumbing and all water-using equipment.

Why is hard water objectionable? The undesirable effects of hard water can be grouped into two major categories: (1) damage to water-using equipment, and (2) interference with everyday household and institutional operations, such as laundering, cooking and bathing.

Hard Water Damage

1. *Heaters, boilers and piping:* When hard water is heated, the calcium and magnesium minerals form a hard, granite-like deposit (called scale) on the inside of pipes and other equipment through which the water passes. The layer of scale grows continuously, eventually reducing the flow of water to a trickle.

In boilers and water heaters, scale has serious consequences. First, it acts as an insulator, cutting down on heat transfer. It is not uncommon for scale in heater and boiler tubes to reduce heating efficiency by 15 per cent.

Second, because of the insulating effect of the scale, the boiler must be operated at higher-than-normal temperatures to provide the required heat transfer. These excessive temperatures weaken pipe walls, leading to burn-out, blistering and rupture.

The scale problem in heaters and

piping can be expected to intensify because of the growing use of home laundering equipment. This equipment calls for more water and at higher temperatures than have heretofore been required for household use. Both conditions will accelerate scale build-up markedly.

In addition to heaters and boilers, other water-using appliances are susceptible to scale formation. For example, the heat exchange units in central air conditioning systems contain many feet of small-diameter tubing which control heat exchange efficiency. When this tubing clogs with scale, the conditioner can no longer cool adequately. The same is true of any heating, cooling or humidifying system to which water must be added continuously to make up evaporation losses.

2. *Sanitation:* Besides diminishing the effectiveness and service life of most types of water-using equipment, hard water increases operating expenses in many hidden ways. For example, the advantages of soft water in providing better washing action, cutting soap costs and saving equipment are so pronounced that no commercial laundry would attempt to operate without a water softener, even in so-called soft water areas, where the water is 2 to 3 grains in hardness.

Whenever soap is used in hard water, a certain percentage of the soap used is destroyed. Calcium and magnesium combine with soap to form a scum or curd.

Besides representing wasted soap, the scum formed in hard water reduces fabric life. The soap curds deposited on the fabric by the hard water are fused onto the fibers during the subsequent drying and ironing. After repeated washing the fibers become quite brittle.

When hard water is used for bathing, washing, shampooing, etc., its effects are most noticeable and most troublesome, at least where the individual is concerned. Hand soap does not lather,

Much of the water used in this country is not as harmless as it appears. In fact, more than half the water supply in the nation is hard—resulting in clogging of pipes and washing difficulties. There are other serious problems, too, such as iron and corrosiveness. The nature of these water problems and methods of treating them in domestic, commercial and institutional buildings are discussed in the following article.

dishes and glassware do not rinse clean, hair and skin feel parched.

What to Do About Hard Water

There is a fairly sharp demarcation between the type of equipment that is practical for the home on the one hand, and for commercial and institutional buildings on the other. The home owner's choice is more limited by initial cost, convenience, simplicity and size. In an institutional building, the choice of equipment depends on the quality of the water as received, quality required for the end use, volume needed and operating costs. The availability of more space, trained operating personnel, and the probable use of the water for non-human purposes provides a wider range of possibilities of water conditioning methods. For these reasons, the following discussion of conditioning methods will make a distinction between domestic and commercial problems.

As in most other water conditioning procedures, hardness can be handled in one of two ways: by removal or retention. Removal extracts the minerals from the water; retention prevents or minimizes the scale-forming materials from depositing by using additives to keep them in solution.

For domestic installations, the most convenient softening method by far is ion exchange. Water softened by ion exchange is equally suitable for human consumption, personal sanitation and for all water-using appliances and equipment. Its initial and operating costs, convenience and simplicity for the relatively small volumes of water used in the home, make the ion exchange softener an ideal choice.

Ion exchange, as applied to water softening, consists of removing the "hard" ions (calcium and magnesium) from the water and substituting other "soft" (sodium) ions in their place. The actual exchange is performed usually by a synthetic resin, a fine bead-like material. As the hard water comes in

contact with the resin, the calcium and magnesium ions attach themselves to the resin. In the process, sodium ions are displaced from the resin and released into the water in exchange.

Softening capacity is restored by a process which is the reverse of the softening process. Salt (which provides sodium ions) is admitted into the resin tank, and the sodium ions displace the calcium and magnesium ions from the resin. After a short rinse period, the resin is ready to begin another softening cycle.

Home Water Softening Equipment

The home softener is compact and is designed to harmonize with other modern household appliances. Most domestic units resemble a modern hot water tank and can be installed unobtrusively almost anywhere. Operation of the softener is shown in Fig. 2.

Softeners are made in various capacities. One manufacturer offers a typical series of domestic softeners rated at 45,000, 60,000 and 90,000 grains. The correct size depends on two main factors: First, the anticipated consumption of soft water by the family; and second, the hardness of the water supply.

Capacity for any particular installation is calculated with a convenient rule of thumb, based on the following information:

- (a) number of persons in the family (automatic washer demand must be considered)
- (b) extent of soft water service
- (c) water analysis (particularly hardness and iron concentrations)

Equipment engineers allow about 50 gallons per person per day if soft water is used throughout the home. An automatic washer uses about 30 gallons per load and is generally considered as an extra "member" of the family.

Two types of systems (called "one tank" and "two tank" models) are commonly used in the home. In the one-

tank model, the softener is regenerated by pouring the salt from the sack directly into a hatch on top of the tank. Thus, no additional valves, pipes or tanks are required. With the two-tank model (Fig. 3), the salt is kept in convenient solution form in a separate tank, and is admitted into the softener merely by positioning a valve. In most cases the salt solution tanks hold enough salt to regenerate a softener two or three times without refilling.

The table accompanying Fig. 3 lists the important typical minimum dimensions that must be allowed when planning the location of a softener. The dimensions given apply only to softeners using ion exchange resins. Softeners which contain the lower capacity silicate zeolites must have greater volume to give equivalent softening capacities.

Commercial Softening

In commercial and institutional installations, hardness is also commonly removed with ion exchange softeners. However with certain types of water containing carbonate hardness, some of the older softening processes which remove hardness by precipitation, are sometimes employed if the water is to be used in the heating system only. These involve the addition of one or more chemicals to the incoming water to precipitate and remove the hardness as a sludge. Two of those processes are: (1) lime-soda softening and (2) hot-process phosphate softening, sometimes followed by ion exchange. The factors in the selection of any of these processes are quite complex and beyond the scope of this article. In general they are used in the treatment of hard waters containing compounds of high turbidity, suspended solids, and silt all of which are removed during the precipitation of the hardness thus eliminating the need for preliminary filtration. Space requirements for this type of process are usually extensive, because of the size of the settling tanks used for sludge settling.

Internal treatment is another technique used to prevent or minimize scale problems. This involves the use of complex phosphates or organic compounds and are usually applied to boilers and other confined water-using systems where the water is not used for human consumption or sanitation. These compounds must be continuously introduced into the system by some metering device in proportion to water flow. Such compounds, usually used in combination with organic additives, prevent scaling by "binding" the calcium and magnesium into a sludge-like precipitate and thus prevent formation of the hard, dense scale on heating surfaces. The sludge is removed by periodic boiler blowdown. These additives will prevent scale deposits from water of fairly high hardness, but the method should be approached with caution and in accordance with U. S. Public Health Service recommendations.

IRON

Iron-bearing water is a nuisance practically wherever it is used. Iron will stain plumbing fixtures and porcelain cooking utensils. Clothes laundered in iron-bearing water will develop yellowish stains. Iron also imparts an objectionable appearance and, sometimes, taste to the water and to foods cooked in it. Under certain circumstances it can be troublesome in water softeners. Iron compounds can form scale which is a common cause of constrictions in valves, piping and boiler tubes.

The iron encountered in water systems may come from two very different sources and it is essential to identify the source before treatment is recom-

mended. In one case the iron is a corrosion product, produced by corrosion of the metals within the system. No remedy is effective against this red water unless it is designed to stop the corrosion. Such measures will be discussed in the next section.

However, very frequently iron comes directly from the water source, particularly if the source is a deep well in which natural conditions favor the dissolution of iron-bearing soil minerals into the water. Manganese is also picked up in the same manner, and creates similar difficulties, but its occurrence is less frequent. The U. S. Public Health Service recommends that the total content of iron and manganese in municipal water systems be limited to 0.3 ppm.

When iron-bearing water is first drawn from a deep well, it is clear and colorless. After aeration or exposure to air, the water develops a milk-like haze and later a yellow or red-brown precipitate of ferric oxide. If the water sample is already red when taken from the system, and the system does not contain a retention tank or aerator where iron-bearing water could oxidize, corrosion should be strongly suspected as the source of trouble.

Iron can be removed by several processes used individually or in combination. Selection of the method is dictated by the form of the iron present, the amount present, and by whether the water is to be softened also. The processes fall into two general categories: removal of the iron; and retention in a form that prevents deposition.

Domestic Iron Treatment

In domestic applications where the wa-

ter contains soluble iron as well as hardness, the iron can be removed in the ion exchange softener at the same time the hardness is removed provided the iron does not have an opportunity to precipitate before reaching the softener. Where the concentration of soluble iron is excessive or iron bacteria are known to be present, a separate iron filter is recommended.

Where the water is already soft, there are available special iron-removal units which utilize a catalyst to precipitate the iron by combining it with the oxygen normally present in the water. The iron thus precipitated is removed periodically by reversing the water flow through the unit and backwashing. Where the oxygen content of the water is too low, precipitation may be effected by using manganese-treated greensand whose oxides act to precipitate the iron. The bed must be backwashed to remove the accumulated iron precipitate, and must also be regenerated periodically with potassium permanganate to restore the oxidizing ability of the greensand. Because of high regenerant costs, this process is generally limited to waters of fairly low iron content if the volume of water treated is high. The water processed in these filters is suitable for human consumption.

On farms where space is available, the iron can be precipitated by aeration in settling tanks where the atmospheric oxygen converts the soluble iron into insoluble form. Because of space requirements, this method is not feasible in suburban areas.

Commercial Installations

In commercial and institutional installations, a greater variety of methods is available. The iron can be removed simultaneously with softening, where lime, lime-soda softening or ion exchange are applicable. Iron is commonly removed by aeration (consisting of intimately admixing air and water, usually by spraying the water through fine nozzles) which oxidizes the iron into insoluble form, later to be removed from settling tanks. In other cases, usually involving swampy surface waters containing organic matter (which interferes with precipitation), the iron must be removed by chemical coagulation followed by filtration.

Retention of iron is sometimes practiced in preference to removal because of the lower equipment costs in certain cases. Retention involves adding surface active materials such as polyphosphates and organic sequestrants in sufficient

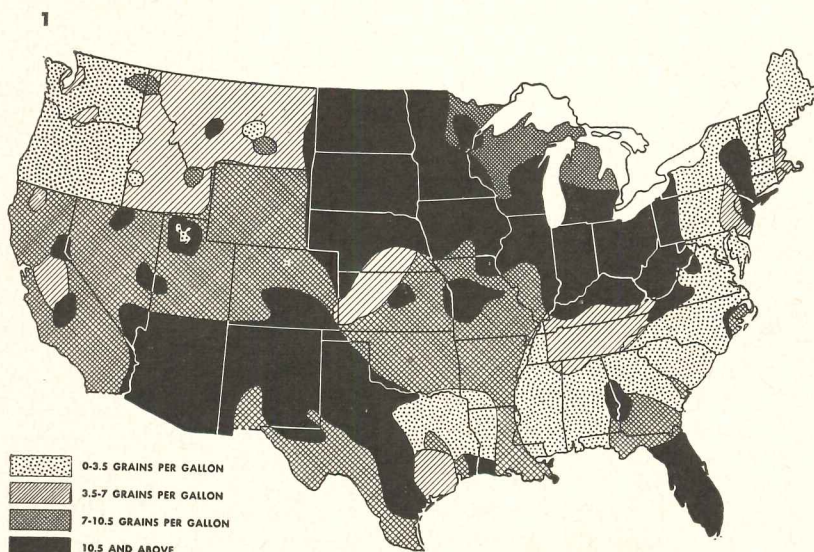

Variations in water hardness in different sections of the country. Dark areas indicate hard water; white or light areas softer water

quantity to stabilize or bind the iron into soluble form and thus prevent precipitation. This procedure becomes somewhat costly when the water is heated, recirculated or retained in the system for a long time because of the high concentration of complexing agent needed to assure retention. It is therefore most applicable for once-through cooling systems where the water remains in the lines only for 20-30 min. and then goes to waste. The concentration of complexing agents should be checked before the water is consumed.

CORROSION

Effects of corrosion may be found anywhere in a water system, but are particularly severe in boilers, heaters and hot water lines, where the high temperatures accelerate the corrosion rate.

Corrosion develops because of what the water contains and because of the way the water is used. Some contributing factors are acidity, low solids content, galvanic action, elevated temperature and high concentrations of dissolved oxygen and carbon dioxide. Usually it takes a combination of conditions, rather than one individual factor to produce corrosion and for that reason the problem of corrosion prevention is a highly complex one.

Many of the methods developed for preventing corrosion by eliminating its causes are tailored for commercial and industrial installations. Because of the cost and technology involved, the householder can do little to eliminate the causes of corrosion, except in a few specific instances. The householder's major weapon against corrosion is to protect the system with various chemical compounds which either form a protective coating over the vulnerable surfaces or "deactivate" the metal and make it less susceptible to attack. These materials rarely prevent corrosion entirely.

Domestic Anti-Corrosion Measures

One of the commonly-used compounds for protecting household systems against corrosion is vitreous phosphate, which forms a thin protective coating over the metal. This is introduced into the system from a pot feeder installed in a cold water line, where the phosphate is slowly dissolved by the flowing water. Less than a pound a month is used for the average home. This phosphate gives fairly good protection against corrosion and scaling except in fairly acidic water, at temperatures above 212 F, or where the water remains in the system for long

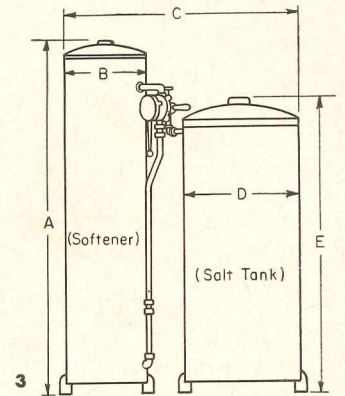
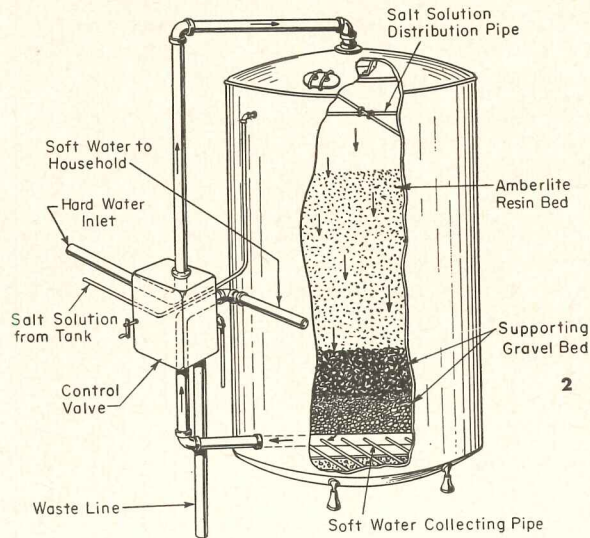

Grain Capacity	Roughing-in-Dimensions (Inches)				
	A	B	C	D	E
45,000	47	12	40	15	37
60,000	49	14	46	19	45
90,000	58	14	46	19	45

Left: components of a typical water softener indicating its operation. Right: space requirements for a domestic softener and accompanying salt tank which regenerates resin

periods with little make-up. Vitreous phosphate may be used to treat water used for heating, sanitation or human consumption. It does not soften water. The Public Health Service has no objection to the use of complex phosphates in water up to 10 ppm.

For corrosion protection in domestic heating systems, the Steel Boiler Institute treatment, utilizing a buffered chromate, has proved very effective against corrosion from all causes. This compound is usually added to the boiler by the manufacturer and it need not be replenished unless the boiler is drained. This compound must not be used in lines carrying water for human consumption.

Corrosion Protection for Large Installations

In large installations, the treatment used usually is directed toward removing the causes of corrosion directly. Oxygen dissolved in water that is somewhat acidic is one of the most common causes of corrosion of iron and steel. Its symptoms are pitting, tuberculation and eventual blocking of water lines by corrosion products. Corrosion by oxygen is most rapid in hot water lines, but occurs in cold water piping also.

Water obtained from surface supplies will almost always contain high concentrations of oxygen, whereas deep underground sources will usually contain little or no oxygen. Oxygen-free water will become saturated with oxygen if the water is aerated to remove other gases.

The most effective method for remov-

ing dissolved oxygen is to deaerate the water by heating in an open or deaerating type of heater, followed by chemical treatment to reduce the residual oxygen to non-corrosive form. Sodium sulfite is most frequently used for this purpose because it is both economical and easy to handle. This water should not be used for human consumption.

Carbon dioxide—another prime cause of corrosion in iron and steel water lines—can be present in surface water but more commonly occurs in underground supplies. However, the most prolific source is by the decomposition of water-borne carbonates and bicarbonates.

Corrosion by carbon dioxide is found more frequently in condensate lines than in the boiler or in feedwater lines. Usually the corrosion takes the form of grooves worn into the pipe wall although it may also cause a general roughening of the wall. Threaded joints and elbows tend to corrode sooner than straight piping runs.

Low concentrations of carbon dioxide in the steam condensate should not be taken as assurance that corrosion will not occur. Small concentrations may be corrosive if the condensate flows at a high rate. One definite method of checking the corrosive potential is to expose a sample of metal to the condensate by mounting it in a simple by-pass arrangement in the condensate line and measuring the rate of corrosion after several weeks of exposure.

Free carbon dioxide can be removed by heating the feedwater in a deaeration-type heater. However, the carbon

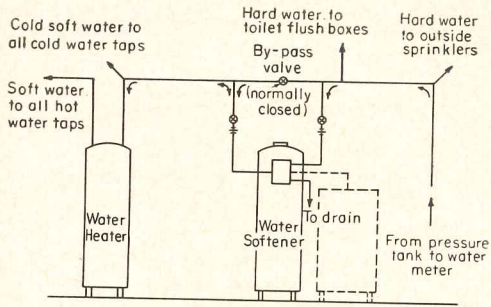

4 Installation for soft water throughout a house except toilet flush boxes

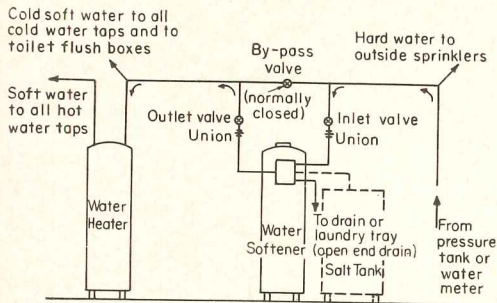

5 Complete domestic soft water treatment. Hard water is used for sprinkling only

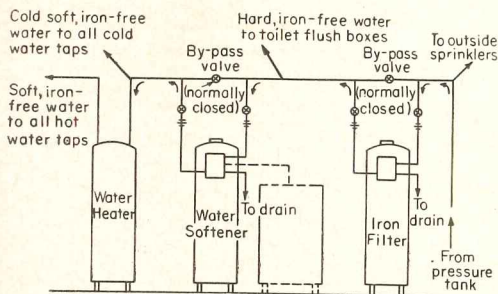

6 Water softening, except for flush boxes, plus a filter to remove iron content

dioxide occurring in the condensate system by the decomposition of carbonates and bicarbonates must be eliminated by other measures. One method is to remove them completely or partially by pretreating the feedwater with an anion exchange resin. Where a small amount of hardness can be tolerated in the water, the thin layer of scale that will form will often act as a protective coating for the underlying metal, but this is effective only in supply lines. For steam and condensate line protection a film-forming amine, which deposits a very thin water-repellent film, appears successful in preventing carbon dioxide attack.

In domestic systems dissolved carbon dioxide can be removed directly by a neutralizing filter which contains a bed of crushed limestone. The carbon dioxide is precipitated as a solid material which

must be periodically removed by backwashing the bed. This filter reduces the acidity of the water, but releases free calcium in the process. It should therefore be installed on the upstream side of the softener and the softener should be sized to handle this additional hardness. Water treated in a neutralizing filter is perfectly fit for human consumption.

Ammonia, which usually originates by decomposition of organic materials in the water supply, is a hazard to pipes and fittings made of copper or copper alloys. Usually, this decomposition occurs in the boiler so that the greatest corrosion can be expected to occur in the condensate lines. Also the copper dissolved by the ammonia can itself be troublesome by returning to the boiler in the recirculating lines to form heat-resistant deposits or galvanic cells.

Free ammonia may be removed by chlorination, ion exchange, or the injection of film-forming amines.

A familiar cause of corrosion in piping systems is galvanic action. Where two dissimilar metals, for example copper and iron, are coupled together a galvanic cell will form causing the gradual eating away of the more anodic metal. Thus, iron will corrode in the presence of copper. The most obvious preventative is to avoid coupling dissimilar metals. Magnesium anodes installed at the points of attack may also help in this situation.

For other types of water problems, such as offensive odors or tastes, aeration or filtering tanks containing activated carbon are used. A sand filter will remove turbidity, suspended clay, silt and organic matter that would tend to clog the rest of the system. Special problems such as very high concentrations of dissolved materials or the presence of hydrogen sulfide occur in some regions, and these conditions also require special consultation with water conditioning experts.

WATER ANALYSIS

The destructive effects of the various dissolved materials on a plumbing system make it important to have a reliable water analysis before specifying equipment. Most water analyses report on the following materials (although other materials will be analyzed under special circumstances): hardness, pH, alkalinity, calcium, magnesium, chlorides, sulfates, silica and iron.

It is relatively easy to get a reliable water analysis regardless of your geographical area. If your area is served by either a publicly or privately-owned water utility, that organization undoubtedly

has a complete analysis of its water obtainable for the asking. Furthermore, you can frequently obtain from the utility recommendations on the most serviceable pipe materials and advice on any special filters needed.

When the building is supplied from a private well or stream of unknown quality, it is practically mandatory to have a complete water analysis before making recommendations about equipment. Even if a second well is dug in a developed site, or an existing well is extended, a water analysis should be made. It is not uncommon for adjoining wells to furnish totally different water if they tap into different strata containing diverse mineral compositions.

You can obtain a water analysis free or at relatively little cost from virtually any manufacturer of water conditioning equipment. Certain pipe manufacturers will recommend the correct type and grade of pipe on the basis of a water sample you send them. In addition, there are many competent commercial laboratories that give a complete analysis and make detailed recommendations.

INSTALLATION TIPS

(1) Be sure to install a by-pass line around the softener and filter tank (if any) so that the water supply will not be interrupted while the softener or filter is being regenerated or serviced.

(2) Use pipe sizes recommended by the equipment manufacturer and select red brass, copper, or galvanized pipe, as required to give satisfactory service under the known water conditions.

(3) Plan drainage lines from the softener carefully. Most plumbing and sanitary codes require an air gap in the softener drain line to avoid the possibility of contaminating the softener with drainage back-ups. In cases where the utilities area has a concrete floor, the standard arrangement of placing a grid in the floor emptying into a receiver, trap, and thence to the sewer is recommended.

(4) Standard water system working pressures need not be boosted to operate a softener. The standard pumping pressure of 25 to 40 psi of most pumps is entirely adequate for softeners. Actually most units will operate satisfactorily in a pressure range of 25 to 125 psi; above and below this range pressure regulators will be necessary. Make certain that the water system has enough pressure to backwash the softener.

A CHECK LIST OF WATER PROBLEMS AND RECOMMENDED TREATMENTS

DIFFICULTY	EFFECTS	TREATMENTS	
		Residences	Institutional and Commercial
HARDNESS Calcium and Magnesium Minerals in Water Supply	<p>1. LIME SCALE IN WATER-USING EQUIPMENT (boilers, heaters, water lines, air conditioners, appliances, utensils, etc.), causing:</p> <p>(a) Restricted flow, pressure loss (b) Reduced heat exchange efficiency (c) Destruction of boiler tubes (over-heating) (d) Premature replacement of parts and equipment</p> <p>2. LAUNDERING AND WASHING DIFFICULTIES: such as:</p> <p>(a) Poor sudsing, soap scum deposit, grayish tinge on fabrics, difficult rinsing (b) Loss of fiber strength in fabrics (c) Cloudy film on dishes and glassware</p> <p>3. PERSONAL SANITATION DIFFICULTIES:</p> <p>(a) Poor sudsing for washing, shaving, shampoos, etc. (b) Gummy film deposited on sinks and tubs, as well as hair and skin</p>	<p>1. HARDNESS REMOVAL: Ion Exchange Softening—Note: water suitable for both human consumption and equipment use</p> <p>2. HARDNESS RETENTION: Complex Phosphates—Note: water suitable for equipment; also may be used for human consumption if concentration used not too high</p>	<p>1. HARDNESS REMOVAL</p> <p>(a) Ion Exchange Softening—Note: water suitable for both human consumption and equipment use (b) Lime-Soda Softening (c) Hot-Process Phosphate Softening Note: (b) and (c) involve precipitation of hardness and sludge removal; water primarily suited for equipment use</p> <p>2. HARDNESS RETENTION</p> <p>(a) complex phosphates (b) organics Note: (a) and (b) involve additives generally for boiler feed applications</p>
IRON AND MANGANESE Unoxidized Iron or Manganese in Water Supply (Not Pipe Rust)	<p>1. FIXTURE STAINING: Permanent rust stains on porcelain</p> <p>2. SCALE IN WATER-USING EQUIPMENT (particularly boilers and water lines): same effect on equipment life and operation as lime scale</p> <p>3. LAUNDERING DIFFICULTIES: Rust stains on linens</p> <p>4. COOKING DIFFICULTIES: Unappetizing brownish water for drinking and cooking</p>	<p>1. IRON REMOVAL</p> <p>(a) Ion Exchange—if practical to remove hardness and iron simultaneously (b) Iron Filter—when removal by ion exchange not practical (c) Aeration and Settling—if space available, usually on farms and ranches Note: (a), (b) and (c) suitable for both human consumption and equipment use</p> <p>2. IRON RETENTION—(no practical method)</p>	<p>1. IRON REMOVAL</p> <p>(a) Ion Exchange—if practical to remove hardness and iron simultaneously (b) Aeration and Settling Note: (a) and (b) OK for human consumption and equipment use (c) Chemical Softening By Precipitation Note: (c) may involve lime-soda, hot process phosphate processes, if water hard. Water primarily for equipment use</p> <p>2. IRON RETENTION: Complex Phosphates and Organic Sequestrants—usually economical only for cooling water used on once-through basis; water not for human consumption</p>
CORROSIVE FACTORS CARBON DIOXIDE (most prevalent in well water)	Corrosion, grooving or roughening of water lines, particularly steam or condensate lines	<p>1. REMOVAL—neutralizing filter</p> <p>2. INHIBITORS</p> <p>(a) for heating system only: Steel Boiler Institute (SBI) buffered chromate treatment (b) for general water lines: feed complex phosphates</p>	<p>1. REMOVAL</p> <p>(a) deaeration (b) ion exchange</p> <p>2. INHIBITORS—filming or neutralizing amines</p>
OXYGEN (normally occurs in surface water; may also be picked up during aeration)	Pitting, tuberculation and general corrosion in heat exchangers, condensate lines, return lines, etc.; red water; scaling by corrosion products	<p>1. REMOVAL—not economical</p> <p>2. INHIBITORS—see 2 (a) and 2 (b) under carbon dioxide</p>	<p>REMOVAL</p> <p>(a) deaeration (b) add reducing agent</p>
GALVANIC ACTION	Corrosion around joint of the two metals	PREVENTION—avoid direct coupling between dissimilar metals	PREVENTION—avoid direct coupling between dissimilar metals
AMMONIA	Corrosion of copper and zinc alloys	<p>1. REMOVAL—not economical</p> <p>2. INHIBITORS—see 2a and 2b under carbon dioxide</p>	<p>REMOVAL</p> <p>(a) ion exchange (b) chlorination (c) deaeration</p>
ACIDITY (from acid materials in water)	General corrosion depending on degree of acidity	<p>1. REMOVAL</p> <p>(a) extract acid materials by any applicable process above (b) neutralize with alkalis</p> <p>2. INHIBITORS—complex phosphates if water not too acidic</p>	<p>REMOVAL</p> <p>(a) extract acid materials by any applicable process above (b) neutralize with alkalis</p>

WELDED VIERENDEEL TRUSSES FRAME HIGHWAY-SPANNING LIBRARY

Five Vierendeel trusses — two of which are probably the largest and heaviest ever fabricated and erected in the United States — support a new public library which spans the Whitehead Highway in Hartford, Conn. Construction of the library above the six-lane highway, which travels over a twin-conduit through which a river flows, proceeded while two-lane traffic in both directions was maintained, and great care was taken to ensure that the highway surface was not damaged.

The building itself is an all-welded steel frame structure, about 192 by 174 ft, consisting of a basement, first floor, mezzanine and second floor, with a penthouse for elevator and staff rooms above the second floor. The Vierendeel truss was selected for use because the open spaces which its design provides afford an undivided area for book storage in the basement of the library.

The Vierendeel trusses carry the stack room floor framing on the bottom chord and the first floor framing on the upper chord. The unbroken area on the bottom chord, convenient to both the general reading room and the charging desk, provides the required large area for a stack room to shelve books. The first floor of the structure was set by the sidewalk elevation of Main St., the main entrance. Adequate clearance was afforded over the highway. Conventional trusses above the second floor support the roof and ceiling, with suspended hangers carrying the mezzanine and second floors, as shown in the typical section above.

Five Vierendeel trusses were used:

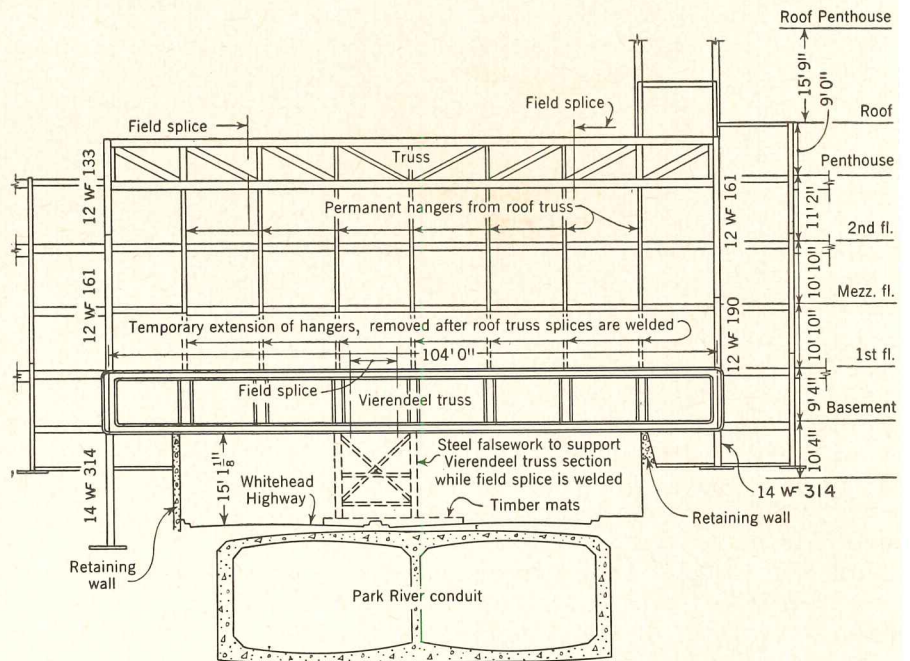

two have eight panels spanning 104 ft and weigh 94 tons; two have seven panels spanning 91 ft and weigh 73 tons; and one has seven panels spanning 91 ft and weighs 53 tons. As shown in the photographs below, the trusses are made up of top and bottom chords and vertical web members, thus eliminating all diagonal members and opening up the interior for use. These chords are strengthened by flange and web plates and also by curved plates at each knee and tee section. All the trusses were spliced at the mid-span. As shown in the drawing, temporary steel falsework was erected on the center strip of the high-

way to support the truss sections until the field welds were made. The end post of the truss serves also as a section of a building column. The end reaction of the truss is transmitted to the column below through bearing. The columns above the end post of the truss bear on the top chord of the truss.

The Vierendeel trusses, fabricated and erected by the Lehigh Structural Steel Co., are named for Prof. Arthur Vierendeel of the University of Louvain, Belgium, who first used them in 1893. Architects of the library were Schutz and Goodwin, Hartford; structural engineer, Robert Loomis, Windsor, Conn.

(More Roundup on page 238)

Fifty-ton half trusses are erected first, as shown in photo (left below). Mid-span splices connect the halves, and completed Vierendeel trusses span highway (right). Photos and drawing courtesy of The Lincoln Electric Co. and the American Institute of Steel Construction

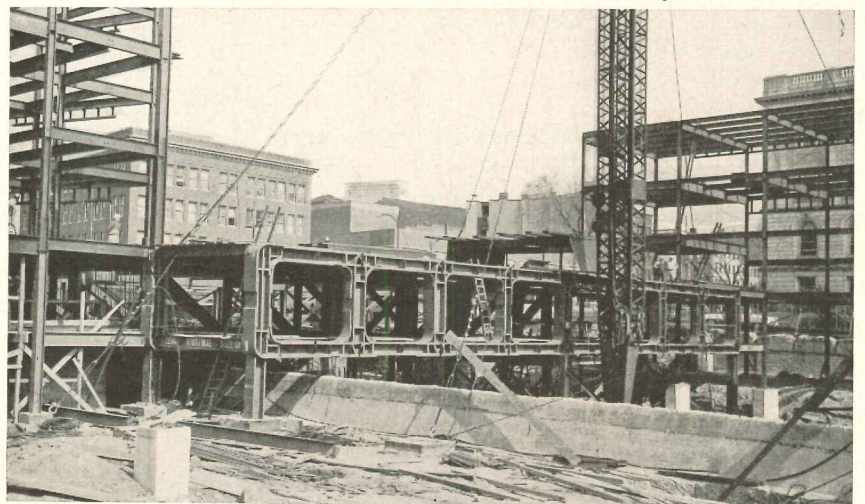
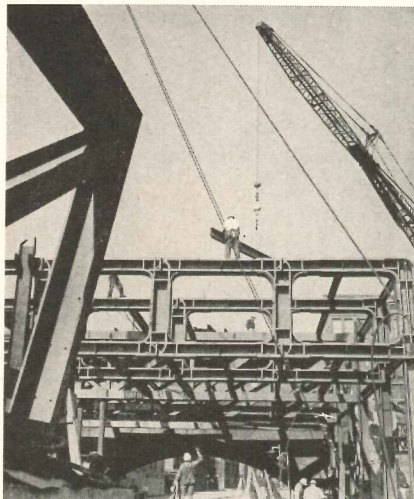

NEW WALL SYSTEMS ARE LIGHTWEIGHT, HAVE LITTLE MAINTENANCE

A Metal-faced, Insulated Wall Panel, *Fenestra Type FA*, is shipped to the site in components and assembled. Erection and fabrication take place at the same time, which makes for greater economy, says the manufacturer, than has previously been experienced in light-gauge metal, curtain wall construction.

The panel consists of a back-up plate and channels, insulation and light-gauge fluted metal facing, as shown in the illustration right. The flat back-up plate, with Z bar attached, is welded or bolted to the structural supports, and the horizontal channels are secured to the Z bars by means of sheet metal saddle clips and drive rivets. Batts of 4-lb intensity Fiberglas of 1½-in. thickness are forced in between the Z bars and channels so snugly that even high winds during erection won't dislodge them. Before the exterior metal sheet is positioned, an asphalt-impregnated felt strip is pasted to the outside of the horizontal sub girts to prevent thermal conductivity through the metal. The exterior metal is then attached by means of drive rivets, and

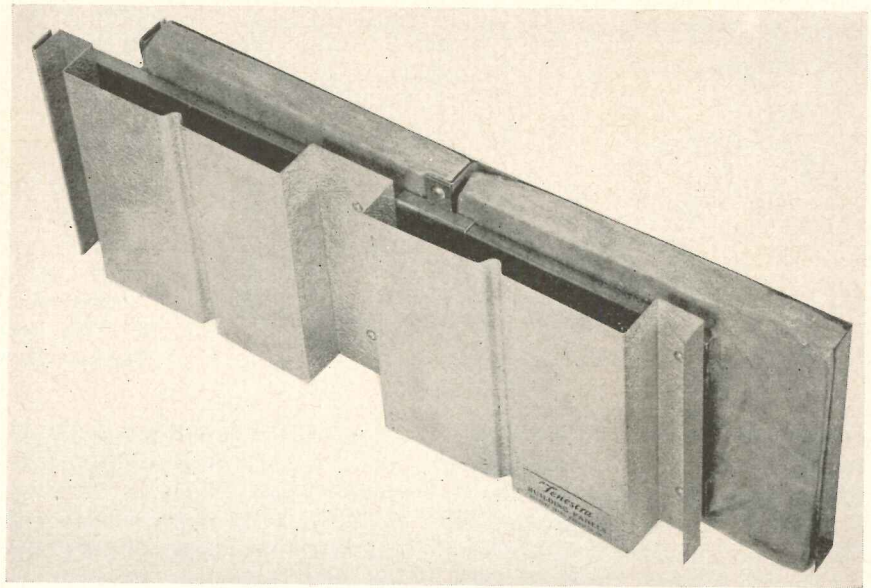

the side joints are vit-clinched.

The FA panel is 24 in. wide, nominally 3¼ in. deep and is manufactured in lengths up to 31 ft. It is available in 16-gauge aluminum and 18-gauge galvanized steel. In the aluminum model it

can have either a leatherette finish, as shown above, or a mill finish. The insulating value of the panels approximates that of a 16-in. masonry wall, according to *Detroit Steel Products Co., 3113 Griffn St., Detroit 11, Mich.*

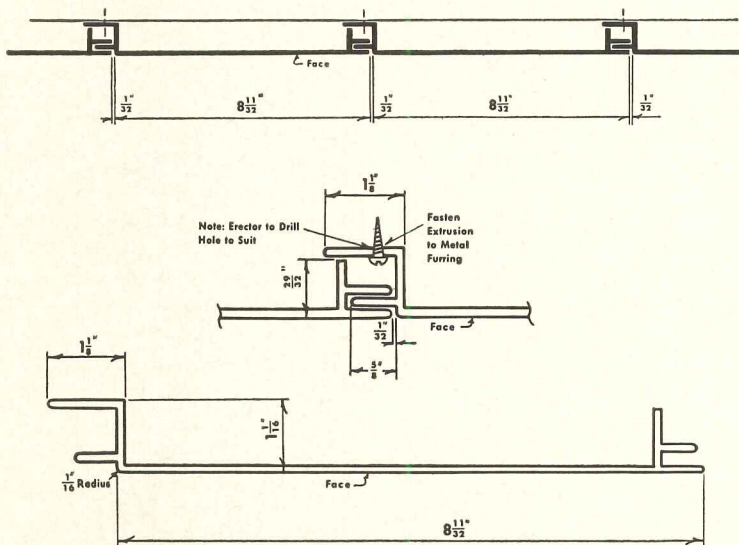

Extruded Aluminum Elements are used in another wall system, the *Snap-On-Wall*. This interior wall system makes possible variations of wall treatment to meet almost any requirement. Five extruded aluminum channels form the basis for this versatile wall: inside and outside corners, edging, furring and snap-on members. These channels can be attached to old walls or studs with nails or screws or even with adhesives. Then perforated hardboard or metal panels are inserted into a snap-on member like the top extrusion in the photo-

graph right and snapped into channels like the bottom extrusion in the photo. By snapping the panels into or out of position, the walls can be replaced, painted or cleaned. By using perforated panels and a sound absorbing material between panel and wall, an acoustical wall is possible. The aluminum channels are available in lengths from 8 to 20 ft; the perforated and metal panels in widths up to 4 ft. The system, developed with the assistance of the Aluminum Co. of America, is produced by *Erdle Perforating Co., Inc., Rochester, N. Y.*

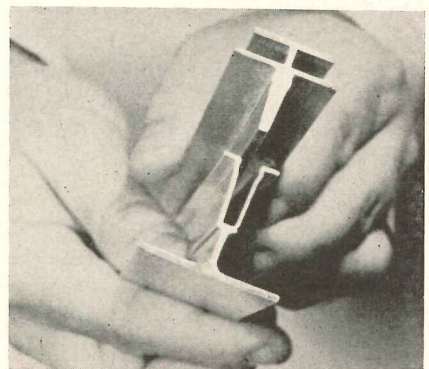

(More Products on page 260)

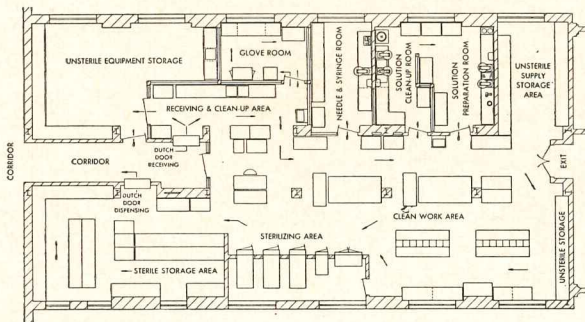

HOSPITAL STERILIZERS

The floor plan for a large hospital (approximately 350 beds) shown at left is just one of many typical plans for locating of sterilizing equipment presented in a well-illustrated, clearly presented, 48-page booklet entitled "Architects' Guide to American Sterilizers for Modern Hospitals" (AIA File 35K). Even though a central sterile supply department is extending its responsibilities in modern hospitals, says this book, limited sterilizing facilities must be planned for other areas. The brochure also contains an extensive product catalog section and engineering data. An 8-page brochure, "Architects' Guide for Surgical Lighting" (AIA File 31-F-28), has also just been published by *American Sterilizer Co., Erie 6, Pa.*

Copper and Brass in piping and tubing, building sheets, heating and termite shields are the subjects of six new publications: "Modern Applications of Sheet Copper in Building Construction," a 144-page technical handbook (AIA File 12). "Radiant Heating," 20 pp (AIA File 30-C-44). "Protection against Termites with Copper Shields," 12 pp (AIA File 19-A-34). "Brass Pipe," a 60-page handbook of plumbing installations (AIA File 29-B-4). "Copper Tube," a 72-page handbook for plumbing and heating installations (AIA File 29-B-41). "Maintenance, Cleaning, Finishing and Coloring of Copper, Brass and Bronze," 32 pp. A general brochure, "Why Leading Architects, Engineers and Builders Choose Copper to Build America," is also available from the *Copper & Brass Research Association, 420 Lexington Ave., New York 17, N. Y.*

Unplasticized Rigid PVC Pipe. Two types, Alpha 101 and Alpha 102, are described, together with charts showing their mechanical, thermal, electrical and other properties, in one folder, and another folder presents threaded and socket solvent cement fittings recommended for use with them. *Alpha Plastics, Inc., 15 Northfield Rd., West Orange, N. J.*

Electrical Equipment. Service entrance equipment, safety switches and lighting and distribution panelboards are cataloged in a 32-page manual which also has an engineering data section. *American Electric Switch Div., Clark Controller Co., 1146 E. 152nd St., Cleveland 10, Ohio.*

The Lumenated Ceiling is the title of an 8-page brochure which describes, with specifications and installation instructions, a plastic ceiling installation by Thermostat, Inc. (AIA File 31-F-290 and 31-F-21.) *John J. Fannon Sales Co., 1469 Algonquin Ave., Detroit 15, Mich.*

Standardized Buildings are the subject of a new 28-page, illustrated brochure entitled, "Buildings by Luria" (AIA File 14-I), which presents a description of the company's new F buildings, their large span and clear span buildings and their standard door and window combinations and collateral structural materials. *Luria Engineering Co., 511 Fifth Ave., New York 17, N. Y.*

Reflective House Insulation. *Alfol* aluminum foil insulation is discussed in a 24-page reference manual which covers topics from the origins of reflective insulation through installation techniques and cost study data. The brochure contains more than 75 charts, photos and drawings. (AIA File 37-C-3.) *Reflectal Corp., Suite 1748, 310 So. Michigan Ave., Chicago 4, Ill.**

Remote Air-Cooled Condensers are described in a 4-page bulletin, *Bulletin AC-100*, which includes tables of performance data and coil and fan data and also dimensions and weights. *Halstead & Mitchell, Bessemer Bldg., Pittsburgh 22, Pa.*

Automatic Emergency Lighting. *Light Warden* units, designed to provide instant protection whenever the regular source of power fails, are described in 8-page *Catalogue 10* from *Electric Cord Co., 195 William St., New York 38.*

Air Conditioning and Refrigeration Equipment is cataloged in *Bulletin 80-D*, which also includes a well-organized discussion of operating principles and useful tables. *Frick Co., Waynesboro, Pa.**

Aluminum Acoustical Ceiling designed to be suspended from the walls of corridors not exceeding 8 ft in width are described in a 4-page illustrated brochure (AIA File 39b) from *Simplex Ceiling Corp., 552 W. 52nd St., New York 19, N. Y.**

Folding Walls. Flexibility of space arrangement and versatility of function are used to illustrate the advantages of Fairhurst *Unitfold* and *Unifslide* folding walls in a 4-page brochure from *John T. Fairhurst Co., Inc., 45 W. 45th St., New York 36, N. Y.**

Store Fronts. A new catalog, *Catalog M*, of store front details presents cross sections in full, half and quarter size. They are printed on heavy translucent paper, so that the shapes can be traced in opposite directions by reversing the pages. *National Store Fronts Co., Manchester St., Lawrence, Mass.*

Air Conditioning and Refrigeration Controls. The complete line of these automatic controls, including late improvements and changes in the GC line, is cataloged by *General Controls Co., Glendale, Calif.*

Roof Decks and Roof Insulation (AIA File 4-E-13 and 37-B-2) is the title of an illustrated 12-page brochure which covers the use of *Vermiculite* insulating concrete on roofs. A 4-page bulletin, "Zonolite Concrete for Modern, Insulated Bermuda Roofs" (AIA File 37-B-2), is also published by *Zonolite Co., 135 So. LaSalle St., Chicago 3, Ill.**

Central Built-in Cleaning System. The *Vacu-Flo* vacuum cleaning system, with a hose that plugs into room outlets from a central installation, is presented in a 4-page brochure from *H-P Products, Inc., Vacu-Flo Div., Louisville, Ohio.*

Asbestos Siding. "Advanced Design with Asbestos Siding" is the title of a booklet which presents original house designs, in which asbestos cement siding has been used, by six architects. *Asbestos-Cement Products Assoc., 509 Madison Ave., New York 22, N. Y.*

* Other product information in *Sweet's Architectural File, 1956.*

(Continued on page 294)

THERMAL INSULATION — 14: Floors

By Laurence Shuman, Consulting Engineer

U Factors for Above-Grade Floors

Legend:

Type of Insulation or Ceiling under Wood Floor, or Ceiling suspended at Least 7½ in. under Concrete Floors

- A** Floor only, no insulation
- B** Metal lath and plaster
- C** ¾" gypsum board
- D** Gypsum or wood lath and ½" plaster
- E** ¾" plywood
- F** ½" rigid insulation board
- G** ½" rigid insulation board, plastered
- H** 1" rigid insulation board
- I** 1" rigid insulation board, plastered
- J** 2" flexible insulation
- K** 3¾" flexible insulation
- L** 1 sheet reflective aluminum, 1 air space
- M** 2 sheets reflective aluminum, 2 air spaces
- N** 3 sheets reflective aluminum, 3 air spaces

Type of Floor	A	B	C	D	E	F	G	H	I	J	K	L	M	N
13/16" hardwood flooring	.39	.24	.24	.23	.23	.19	.18	.15	.14	.09	.06	.08	.06	.05
13/16" hardwood flooring and 25/32" yellow pine subflooring	.28	.19	.19	.19	.19	.16	.15	.13	.13	.08	.06	.07	.06	.05
Bare concrete, 3" thick	.53	.29	.29	.28	.27	.21	.21	.16	.16	.10	.06	.08	.06	.05
6" thick	.47	.27	.27	.26	.26	.20	.20	.16	.15	.09	.06	.08	.06	.05
10" thick	.41	.25	.25	.24	.24	.19	.19	.15	.15	.09	.06	.08	.06	.05
Tile or terrazzo on concrete, 3" thick	.51	.29	.28	.27	.27	.21	.20	.16	.16	.10	.06	.08	.06	.05
6" thick	.45	.27	.26	.26	.25	.20	.19	.15	.15	.09	.06	.08	.06	.05
10" thick	.40	.24	.24	.24	.23	.19	.18	.15	.15	.09	.06	.08	.06	.05
Parquet flooring on concrete, 3" thick	.38	.24	.23	.23	.22	.18	.18	.14	.14	.09	.06	.08	.06	.04
6" thick	.35	.22	.22	.22	.21	.17	.17	.14	.14	.09	.06	.08	.06	.04
10" thick	.31	.21	.21	.20	.20	.17	.16	.13	.13	.09	.06	.08	.06	.04
Hardwood flooring and yellow pine subflooring on sleepers on concrete, 3" thick	.22	.16	.16	.16	.16	.14	.13	.11	.11	.08	.05	.07	.05	.04
6" thick	.21	.16	.16	.15	.15	.13	.13	.11	.11	.07	.05	.07	.05	.04
10" thick	.20	.15	.15	.15	.14	.13	.12	.11	.11	.07	.05	.07	.05	.04

Insulation of On-Grade Concrete Slabs

Heat transfer through concrete floor slabs on the ground is dependent on: (1) the difference in temperature between the air outside the structure and the air within the structure, (2) the floor material and (3) the conductivity of the surrounding earth. While data concerning the conductivity of the ground are not ordinarily available, tests indicate that where the area of the slab floor is on the order of 6 to 12 times its perimeter, the heat loss may be calculated proportionally to the exposed edge of the floor slab. For buildings of greater area, where the ratio of area to perimeter is much over 12 to 1, the heat loss should be determined proportionally to the area.

Tests show that the heat loss from uninsulated concrete floors laid on

the ground is about 0.81 Btu per hr per lineal ft per degree temperature difference between the air on the warm side and the air on the cold side of the building. Recommendations of the Building Research Advisory Board for insulation of the perimeter of such slab floors give the amount of perimeter insulation deemed necessary to reduce the edge heat loss to satisfactory limits. The Federal Housing Administration lists these limits in the MPR Revision No. 54, August 1955.

When the building area is greater than 12 times the perimeter, the heat loss from slab floors at grade should be calculated at approximately 0.10 Btu per hr, per sq ft of floor, per degree F temperature difference between inside and outside air. Heat loss of basement walls

below grade usually is calculated at twice this rate or 0.20 Btu / hr / sq ft / F. However, where specific rooms are located along the outside of the structure, it is recommended that their heat loss be calculated using the perimeter method to find the floor loss of the room.

Perimeter insulation must be non-capillary; not permanently harmed by wetting, or by contact with wet concrete mix; not subject to damage by fungi or termites; and must have a resistance to compression such that the reduction in thickness under a uniform loading of 50 lb per sq ft shall not exceed 10 per cent of its initial thickness; and the additional reduction in thickness under a uniform loading of 90 lb per sq ft shall not exceed 6 per cent of that measured under the 50 lb loading.

CURTIS *industrial*

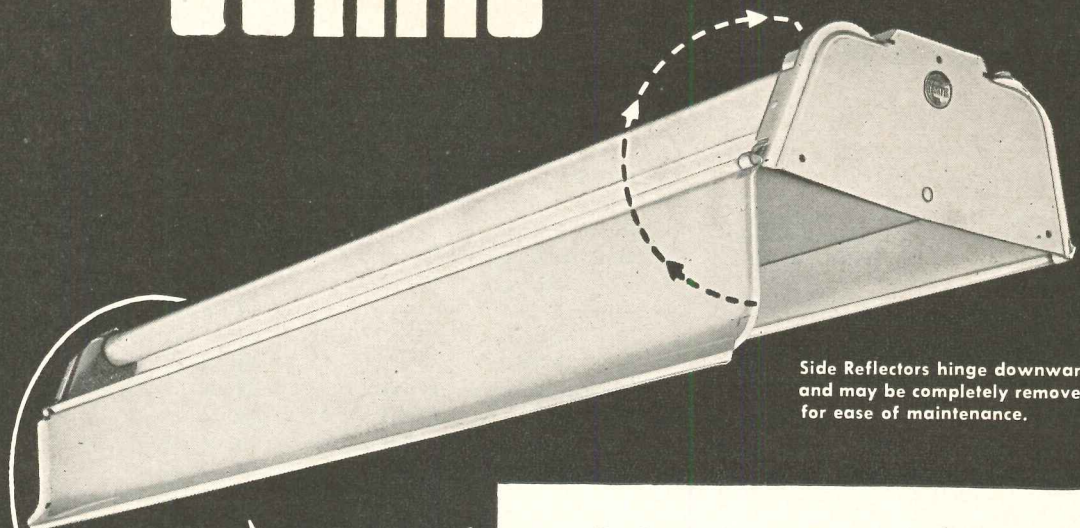

Side Reflectors hinge downward and may be completely removed for ease of maintenance.

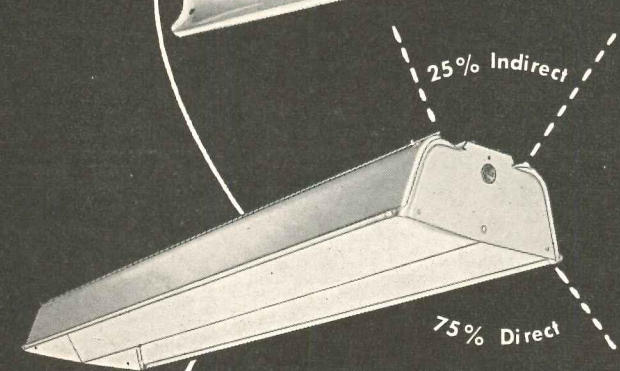

Light distribution eliminates severe brightness contrast and tunnel lighting conditions.

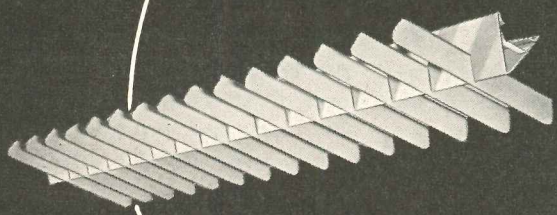

Louvers available where greater lengthwise shielding is desired.

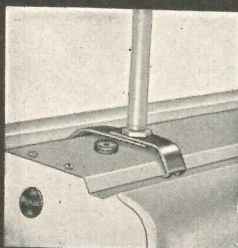

Curtis "Tong Hangers*" facilitate and cut installation cost as they allow flexibility in placement of hangers and permit bypassing of building construction obstacles such as beams, sprinkler heads, etc.

*Pat. applied for.

6000 SERIES

The New Curtis "Six Thousand" series is designed for Eye-Comfort® in industrial locations. The Luminaires illuminate the ceiling with an indirect component of 25% of the light output. Crosswise shielding of 35° is provided for the 75% direct component. The lighting units in this versatile line are available with Alzak Aluminum, Porcelain Enamel, or baked white "Fluracite" enameled steel removable side reflectors. Low cost efficient maintenance is provided by having side panels readily removable for cleaning. In addition there are no horizontal diffusing or reflecting surfaces to collect dust. There is a unit in this versatile line to accommodate all 4', 5' and 8' fluorescent lamps. The Curtis "Six-Thousand" series brings Appropriate Brightness Control Lighting to industrial areas. Mail coupon for FREE descriptive literature.

CURTIS LIGHTING, INC.
 Dept. B3-20 6135 West 65th Street
 Chicago 38, Illinois

Name _____

Company _____

Address _____

City _____ State _____

In Canada: Curtis Lighting of Canada, Ltd.
 195 Wickstead Ave., Leaside, Toronto 17, Ont., Canada

THERMAL INSULATION — 15: Concrete Floor Slabs

By Laurence Shuman, Consulting Engineer

TABLE 1: PERIMETER INSULATION FOR VARIOUS DESIGN TEMPERATURES

Outside Design Temp., F	Maximum Conductance (C) (Btu/hr/sq ft/deg. F) for Various Widths of Insulation					
	Total Width of Insulation (see sketches)					
	Unheated Floor Slab		Heated Floor Slab			
	2 ft	1½ ft	1 ft	2 ft	1½ ft	1 ft
-30 and lower	0.15	—	—	—	0.30	0.20
-20 to -29	0.20	—	—	0.40	—	0.30
-10 to -19	0.20	—	—	—	—	0.40
0 to -9	0.30	0.20	0.15	—	—	0.40
+1 to +10	0.40	0.30	0.20	—	—	0.40
11 to 20	—	—	0.40	Vertical edge only		
21 to 30	Vertical edge only			Vertical edge only		
31 and above	None required			None required		
Summer Air Conditioning	Uncooled slab 0.40		Cooled slab		0.40	

TABLE 2A: PERIMETER LOSS OF UNHEATED SLABS

Total Width of Insulation	HEAT LOSS (Btu/lineal ft/deg. F difference between inside and outside air)					
	Conductance (C) of Insulation					
	0.15	0.20	0.25	0.30	0.35	0.40
1.0 ft	0.29	0.38	0.49	0.58	0.67	0.77
1.5	0.26	0.35	0.44	0.52	0.61	0.70
2.0	0.25	0.33	0.42	0.50	0.59	0.67

TABLE 2B: PERIMETER LOSS OF HEATED SLABS

Total Width of Insulation	HEAT LOSS (Btu/lineal ft/deg. F difference between inside and outside air)					
	Conductance (C) of Insulation					
	0.15	0.20	0.25	0.30	0.35	0.40
1.0 ft	0.32	0.43	0.57	0.70	0.83	1.00
1.5	0.28	0.39	0.50	0.62	0.75	0.88
2.0	0.27	0.37	0.48	0.59	0.71	0.83

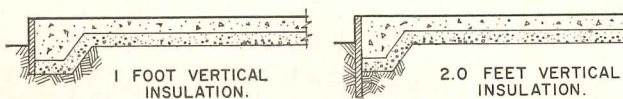
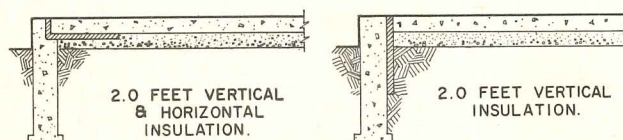
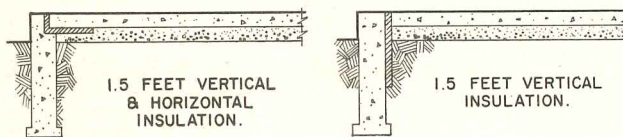
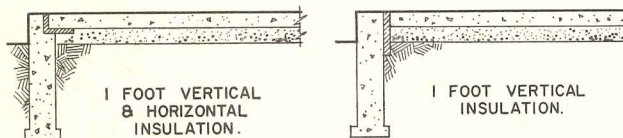
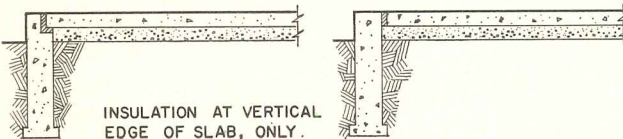
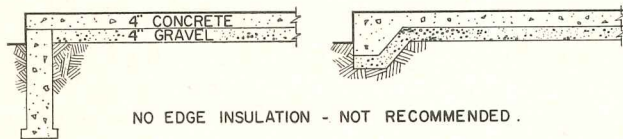

When the perimeter method of calculation is followed, the Federal Housing Administration requires the thermal value and width of perimeter insulation to be as given in Table 1, above. The term "heated floor slab" means any installation such as a radiant floor panel, warm air perimeter loop, or warm air perimeter radial system where heating pipes or ducts are installed in or under the concrete slab. The conductivity of the insulation at the slab perimeter must not exceed the figures in the tables.

TABLE 3: CONVERSION FACTORS FOR CONDUCTIVITY AND CONDUCTANCE

Conductivity (K)	INSULATION CONDUCTANCE (C)			
	Thickness of insulation, in.			
	2	2½	1	¾
0.2	0.1	0.13	0.2	0.27
0.25	0.13	0.17	0.25	0.33
0.3	0.15	0.20	0.3	0.4
0.35	0.18	0.23	0.35	0.47
0.4	0.2	0.27	0.4	0.53

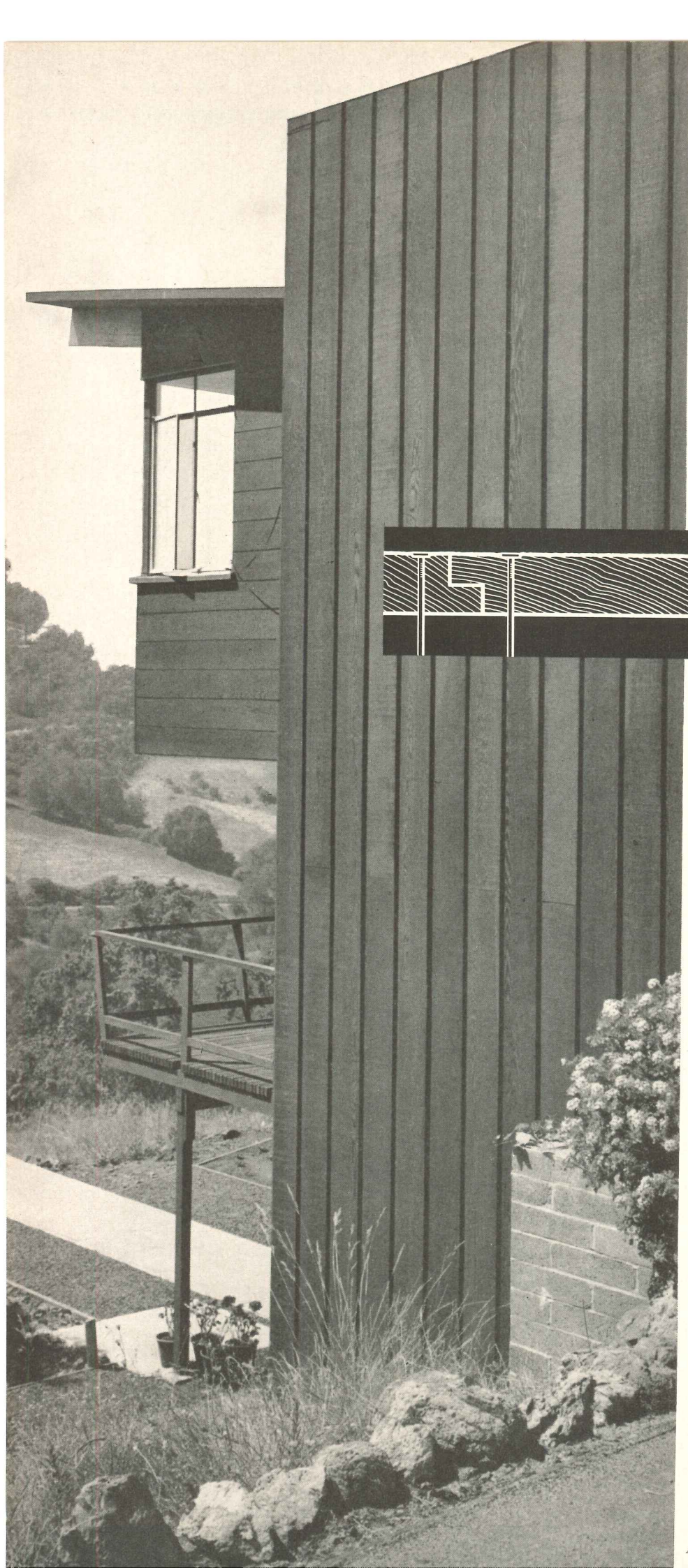

Rough face
does a
smooth job

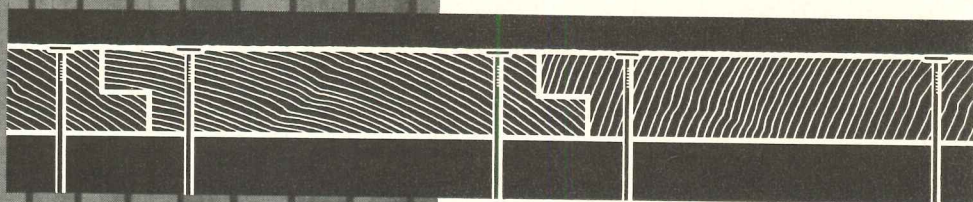

Particularly appropriate to distinguished contemporary design is the use of rough-face redwood siding for exterior and interior.

By specifying "resawn face," the architect can obtain a pleasing surface texture with superior stain retention.

"Resawn face" is standard in plain shiplap pattern sketched above.



California
Redwood

CALIFORNIA REDWOOD ASSOCIATION

576 SACRAMENTO STREET

SAN FRANCISCO 11, CALIFORNIA

THERMAL INSULATION — 16: U Factors for Glass; Wood Doors

By Laurence Shuman, Consulting Engineer

These tables reprinted by permission from Heating Ventilating and Air Conditioning Guide 1955, Chapt. 9, page 195

HEAT TRANSMISSION COEFFICIENTS FOR WINDOWS, SKYLIGHTS AND GLASS BLOCK WALLS

(Btu / hr / sq ft / degree F difference in temperature, air to air, inside and outside building)

Vertical glass sheets							
NUMBER OF SHEETS	ONE	TWO			THREE		
Air space, in. <i>U</i>	None 1.13	1/4 0.61	1/2 0.55	1 0.53	1/4 0.41	1/2 0.36	1 0.34

Horizontal glass sheets				
NUMBER OF SHEETS	HEAT FLOW UP			
	ONE	TWO		
Air space, in. <i>U</i>	None 1.40	1/4 0.70	1/2 0.66	1 0.63

DESCRIPTION	OUTDOOR EXPOSURE
5 3/4 x 5 3/4 x 3 7/8 in. thick	0.60
7 3/4 x 7 3/4 x 3 7/8 in. thick	0.56
11 3/4 x 11 3/4 x 3 7/8 in. thick	0.52
7 3/4 x 7 3/4 x 3 7/8 in. thick, with fiber glass screen dividing cavity	0.48

Application factors for windows: multiply flat glass U values by these factors

WINDOW DESCRIPTION	SINGLE GLASS	DOUBLE GLASS	WINDOWS WITH STORM SASH
Sheets	100% glass, 1.00	100% glass, 1.00	
Wood sash	80% glass, 0.90	80% glass, 0.95	80% glass, 0.90
Wood sash	60% glass, 0.80	60% glass, 0.85	60% glass, 0.80
Steel sash	80% glass, 1.00	80% glass, 1.20	80% glass, 1.00
Aluminum sash	80% glass, 1.10	80% glass, 1.30	80% glass, 1.10

HEAT TRANSMISSION COEFFICIENTS OF SOLID WOOD DOORS

(Btu / hr / sq ft / degree F difference in temperature inside and outside the door at 15 mph wind velocity outside)

NOMINAL DOOR THICKNESS	ACTUAL THICKNESS	EXPOSED DOOR	DOOR WITH GLASS STORM DOOR
1	2 5/32	0.69	0.35
1 1/4	1 1/16	0.59	0.32
1 1/2	1 3/16	0.52	0.30
1 3/4	1 5/8	0.51	0.30
2	1 5/8	0.46	0.28
2 1/2	2 1/8	0.38	0.25
3	2 5/8	0.33	0.23

A value of 0.85 should be used for single exposed doors containing thin wood panels or single panes of glass, and a value of 0.39 for the same door if protected by glass storm doors.

General Electric Announces

New TWO-LEVEL steel

**NEW G-E STEEL
TWO-LEVEL UNDERFLOOR
WIRING SYSTEM**

consists of two levels of steel ducts and fittings which feed and distribute power, telephone, signal, and auxiliary systems in commercial, industrial, and institutional buildings.

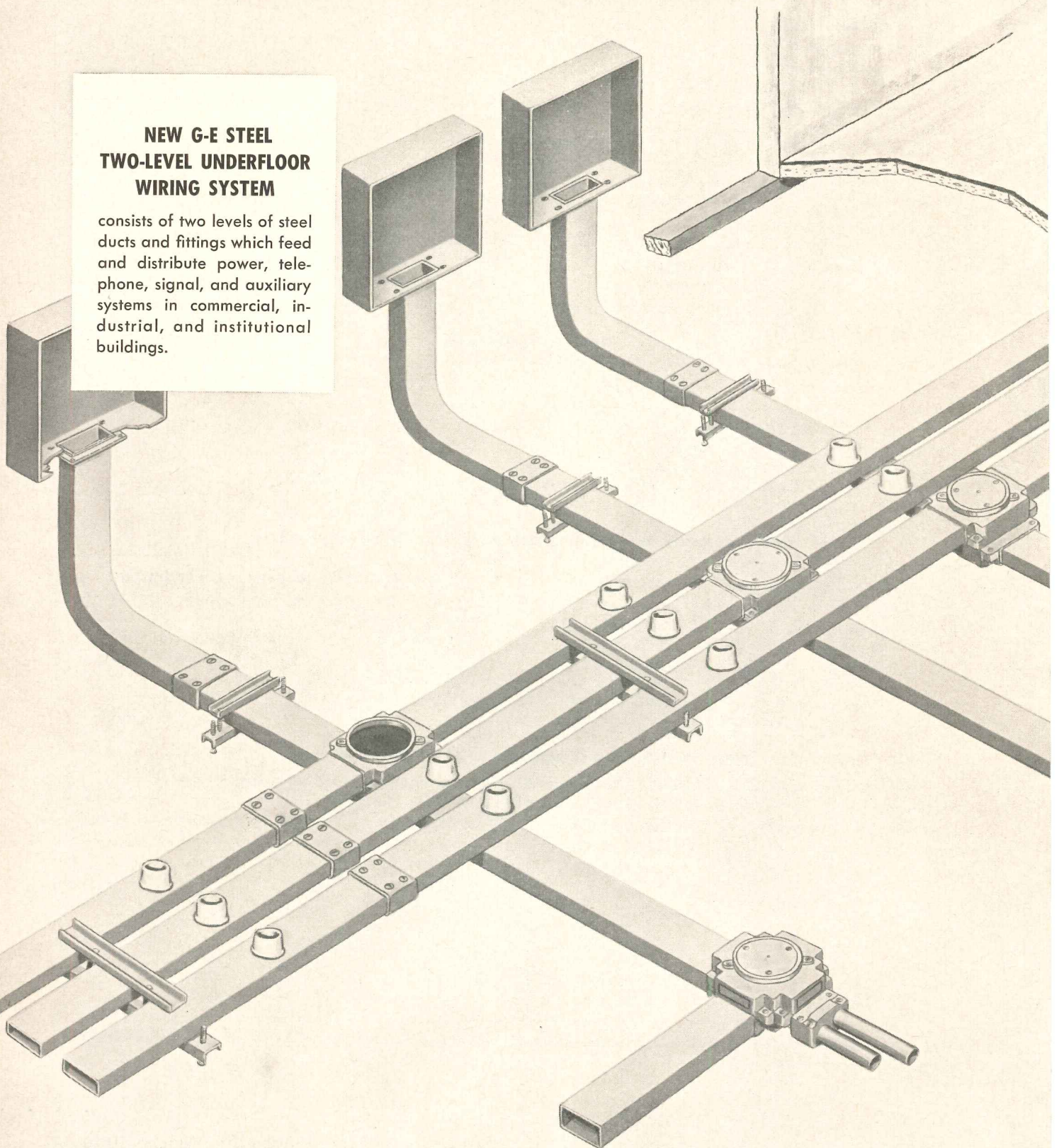

Underfloor wiring system

- gives completely separate services
- permits unlimited number of duct feeds
- fits any predetermined floor layout
- allows unlimited number of services

A new two-level steel underfloor wiring system offering entirely new benefits to architects, engineers, electrical contractors, owners, and tenants has been announced by General Electric.

COMPLETE SEPARATION OF SERVICES because only single-duct junction boxes are used. Duct entrances are on two levels—usually with feeder duct below and distribution duct above. This separation allows unobstructed runs and permits conductors to be pulled straight through the boxes. No crossunders or crossovers are necessary in the new G-E two-level system.

FLEXIBILITY IN LAYOUT AND DESIGN is now possible because there are no limitations to the duct pattern in either the feeding or distribution portions of the two-level system.

ONLY ONE TYPE AND SIZE JUNCTION BOX TO INSTALL—contains no tunnels or barriers. Its entire interior is accessible for work and inspection. Wire pulling is easier and circuits are easy to trace because of two-level separation of all services.

INCREASED WIRING CAPACITY is provided for by the new steel duct (4-square inches cross-sectional area).

FIND OUT how this two-level system can help you distribute power, telephone, signal, and auxiliary systems. Get in touch with your nearest G-E Construction Materials District Office or write for information bulletin to Section C59-25, General Electric Company, Bridgeport 2, Connecticut.

Progress Is Our Most Important Product

GENERAL  **ELECTRIC**

CONDUIT PRODUCTS DEPARTMENT

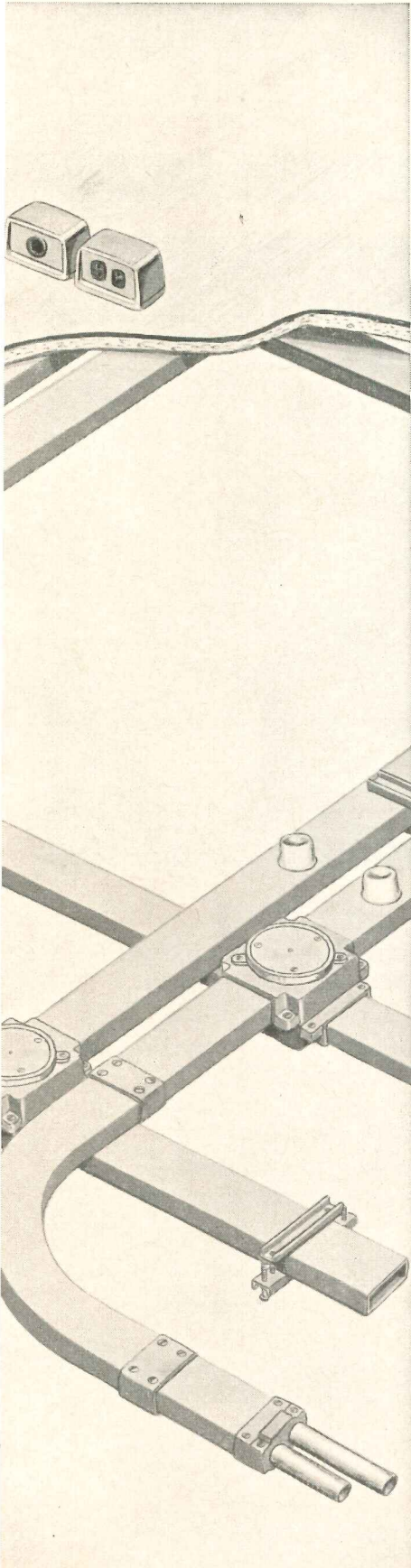

TECHNICAL ROUNDUP

(Continued from page 226)

MODEL "PLANT OF FUTURE" IS DESIGNED BY CHICAGO FIRM

The "Factory of the Future" — an eighth-inch scale model of a hypothetical, pushbutton manufacturing plant that will operate on solar and nuclear power in the year 2005 — was exhibited at the Pageant of Industrial Progress in Chicago last November by A. Epstein & Sons, Inc., Architects and Engineers, of Chicago. The plant incorporates all the features which Mr. Epstein envisions as those of a plant which may be operating in Chicago's Central Manufacturing District 50 years from now.

It will be equipped with its own power plant: rotating sun accumulators on the roof of the superstructure, as shown in the photograph of the model above. In the compartments of the superstructure will be atomic battery rooms for the storage of energy for evenings and days of inclement weather.

Walls will be of pre-formed plastic panels which will admit sunlight during the day and will be electronically charged to emit light at night. Infra-red radiation from the walls will be thermostatically controlled for temperature gradation.

The plant will be composed of two production lines with office facilities located centrally between them. Although there are locker and toilet facilities in the central section, there is no provision for an employees' lunchroom. By 2005, Mr. Epstein maintains, the 8-hr working day will have shrunk to 4 or 5 hr, so the lunch hour will be a thing of the past.

There is no storage space for either raw materials or finished products, since the efficiency of the pushbutton plant depends on its continuous operation. Raw materials will be delivered by "helio-trucks" and unloaded into the plant via automatic conveyors, operating through doors in the plant similar to bomb-bay doors in planes. They will then be carried to the turntable at the beginning of the production line on the second level.

The largest staffed departments of the plant will be the engineering and administrative sections. The maintenance staff can be kept to a minimum because the construction will be primarily of plastic, aluminum and other non-oxidizing treated ferrous metals. Furthermore, all surfaces will be given negative static charges, and positive charged air ducts located throughout the plant will pick up and transport dust to atomic disposal units.

(Continued on page 243)

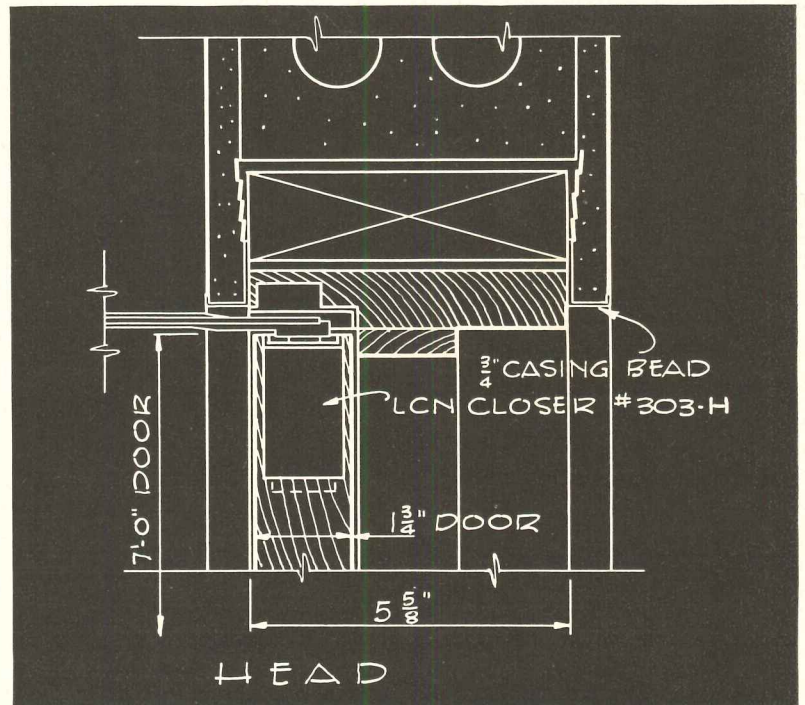
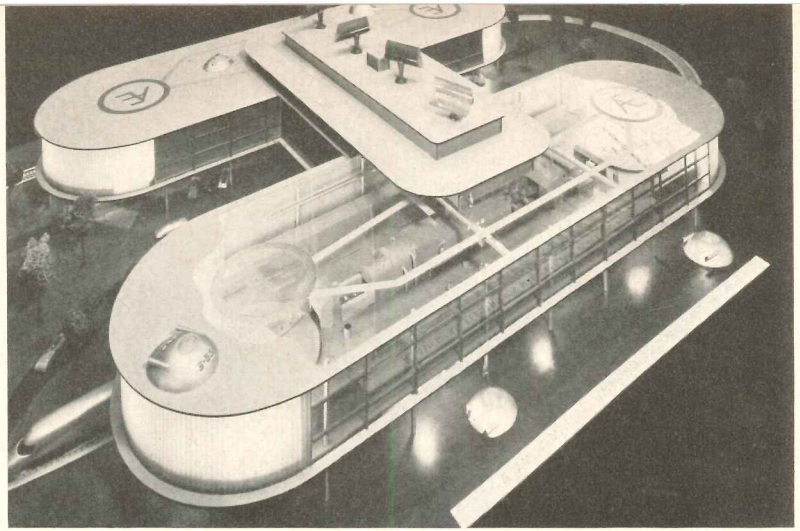

CONSTRUCTION DETAILS

for LCN Closer Concealed-in-Door Shown on Opposite Page

The LCN Series 302-303 Closer's Main Points:

1. An ideal closer for many interior wood doors
2. Mechanism concealed within door; flat arm not prominent, and provides high closing power
3. Door is hung on regular butts
4. Closer is simple to install and to adjust
5. Used with wood doors; wood or metal frames
6. Practically concealed control at little more than exposed closer cost

Complete Catalog on Request—No Obligation
or See Sweet's 1956, Sec. 18e/L

LCN CLOSERS, INC., PRINCETON, ILLINOIS

OR THE GOOD LIFE"

2.



Twenty Architect-Designed Houses for Typical American Families. A ninety-page, highly visual presentation of America's best new houses. Text covers the client's requirements, the architect's reasons for designing as he did, and an appraisal of the architect's work by the owner. Each house will be presented for easy comparison with all others in terms of design solutions to similar problems.

Criteria for the selection of featured houses include: (1) economical design in the \$20-\$50,000 price range, (2) three or four bedrooms, (3) facilities for growing children, (4) widespread geographical distribution, (5) functional excellence, (6) beauty of form, texture and color, (7) average sites, (8) design by 20 different architects — with full recognition of great new design talent along with the best known including . . .

Anshen & Allen; Bolton & Barnstone; Marcel Breuer; Curtis & Davis; Ulrich J. Franzen; Charles M. Goodman; John MacL. Johansen; A. Quincy Jones and Frederick E. Emmons; Allen & Edwin Kramer; Richard Neutra; Nims & Brown; John Pekruhn; Paul Rudolph; Schweikher & Elting; Smith & Williams; James Speyer; Paul Thiry; William Wiener; E. H. and M. K. Hunter; Wurster, Bernardi & Emmons.

Nine Adventurousome Houses. Examples of brilliant experimentation in design and the use of materials and equipment — pointing the direction to tomorrow.

3.



In all, twenty-nine houses that will be a valuable tool for you to use with your clients to open their eyes (and minds) to good architectural design and to win their acceptance for house plans in which you can both take pride.

Products and Literature. A round-up of new residential building products, sectionalized by main product categories *plus* a comprehensive listing of *new* manufacturers' literature.

4.



.....

Shortly after publication "Record Houses of 1956" will be available to the house building public in bookstores across the nation. For the first time it will give this public a truly embracing picture of the best in house design. "Record Houses of 1956" will make a significant contribution to the growing public awareness of the advantages of good house architecture — and the determination of the typical American family to enjoy them.



ARCHITECTURAL RECORD

119 West 40th Street
New York 18, N. Y.
OXford 5-3000

"workbook of the *active* architect and engineer"

THE RECORD REPORTS

(Continued from page 326)

DESIGN THEATER TO USE NEW PROJECTION SYSTEMS

The Carib Theater in Clearwater, Fla., was designed by architect James E. Casale of New York to incorporate facilities for "CinemaScope," three-dimensional and other new projection techniques. Acoustic properties of the auditorium were also a major consideration

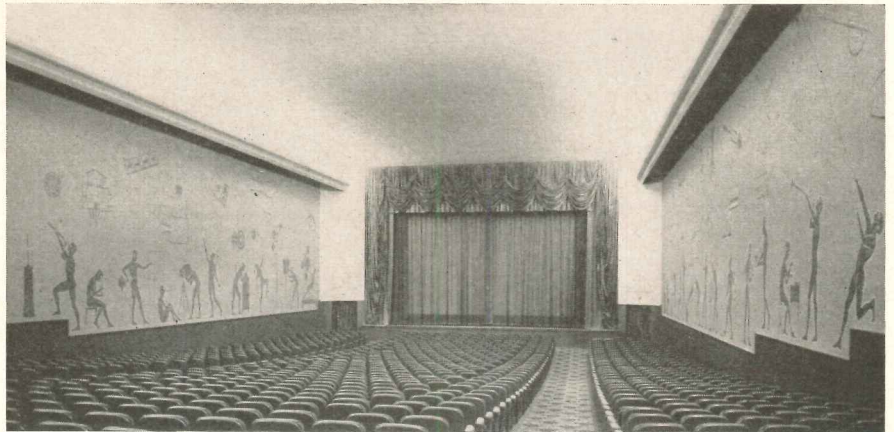

Murals by artist Peter Cohen in auditorium (above) represent man's experiments with light and sound; (below) red and yellow Caribbeans on a blue porcelain enamel sea



in view of recent developments in theater sound; i.e. stereophonic sound, which in this case required six speakers, three on either side of the auditorium.

The speakers are covered with perforated canvas painted beige to blend with the acoustic tile with which the walls are faced. The murals were done in green and coral oil, acoustically a rather inactive material, especially in the higher frequencies. The rear wall is composed of four in. of rockwool covered with damask; the ceiling is perforated acoustic tile.

The second floor of the building contains the projection room, a smoking room on each side of the projection room, the manager's office, ushers' dressing room and storage space. A parking area is located in the rear.

At the street level, the building has space available for store rental; the theater is designed as part of a commercial development.

The exterior of the building is buff stucco, trimmed with corrugated metal and stainless steel.

(Continued on page 332)



American Bridge Co.
American Can Co.
American Tobacco Co.
Chrysler Corp.
Eastman Kodak Co.
Ford Motor Co.
General Motors Corp.
Hart, Schaffner & Marx
International Business Machine Corp.
International Harvester Co.
Liggett & Myers Tobacco Co.
P. Lorillard Co.
The Maytag Co.
National Biscuit Co.
Philip Morris Tobacco Co.
Radio Corporation of America
Remington-Rand
Socony Mobile Oil Co., Inc.
Standard Oil Co.
Stromberg-Carlson Corp.
Studebaker-Packard Corp.
United States Tobacco Co.
Westinghouse

leading industries* use Robbins maple floors



Ritter Company, Rochester, New York
Architects: Waasdorp and Northrup, Rochester, New York

HERE'S WHY these leaders in their fields choose Robbins Ironbound, Continuous Strip, Northern Hard Maple Floors:

- Exceptionally long life (50 years or more)
- Hardness with resilience
- Smoothness and cleanliness
- Maximum ease of maintenance
- Lower cost in the long run
- Beauty and warmth of color

Sold and installed by approved and experienced flooring contractors only. Write Robbins, Reed City, for complete information.

ROBBINS FLOORING COMPANY

WORLD'S LARGEST MAPLE FLOORING MANUFACTURER

Reed City, Michigan

Ishpeming, Michigan

T.M. Reg. U.S. Pat. Off.

See our Catalog in Sweet's File

MILLIONS
WALK DAILY
ON
ROBBINS
FLOORING

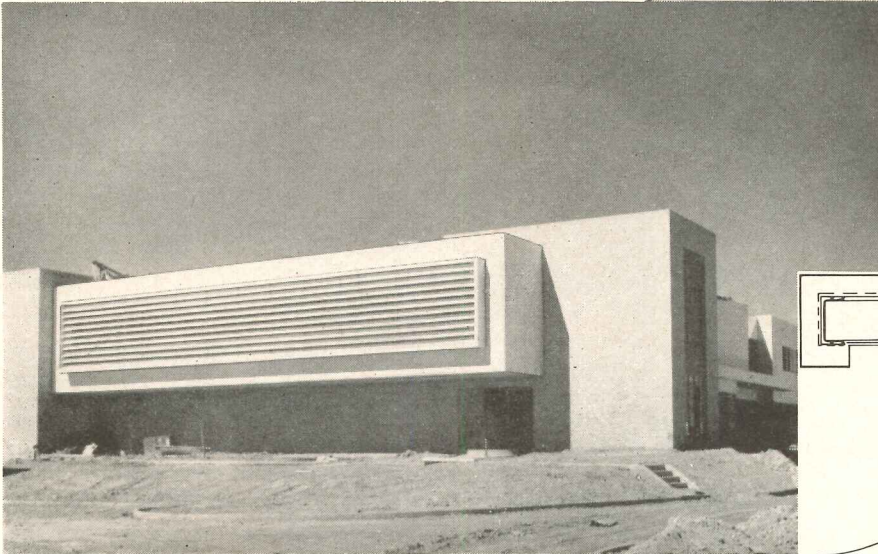

Architect: Locatelli, Inc.

Erie U-16 PANEL WALLS

- increase floor space
- add permanent color
- end maintenance

Erie's insulated Porcelain Enamel Panel permits thin-wall construction that increases floor space, adds permanent color of any hue, and virtually ends maintenance.

This light manufacturing plant is a typical application. The entire cantilevered section and much of the balance of the building is constructed of Stransteel framing with Erie U-16 insulated Porcelain Enamel Panels (See detail). These panels are only 1½" thick yet provide a U-factor of about .16. The impossibility of North orientation was overcome with Porcelain Enamel louvers shielding skylight from office windows but reflecting ground light. Porcelain Enamel assured permanent color and lifetime finish throughout.

You can offer your clientele this modern panel construction method and lifetime finish. ERIE will give you full cooperation on construction details and panel engineering to suit your job. WRITE for literature on construction details.

Lifetime Porcelain Enamel in Color

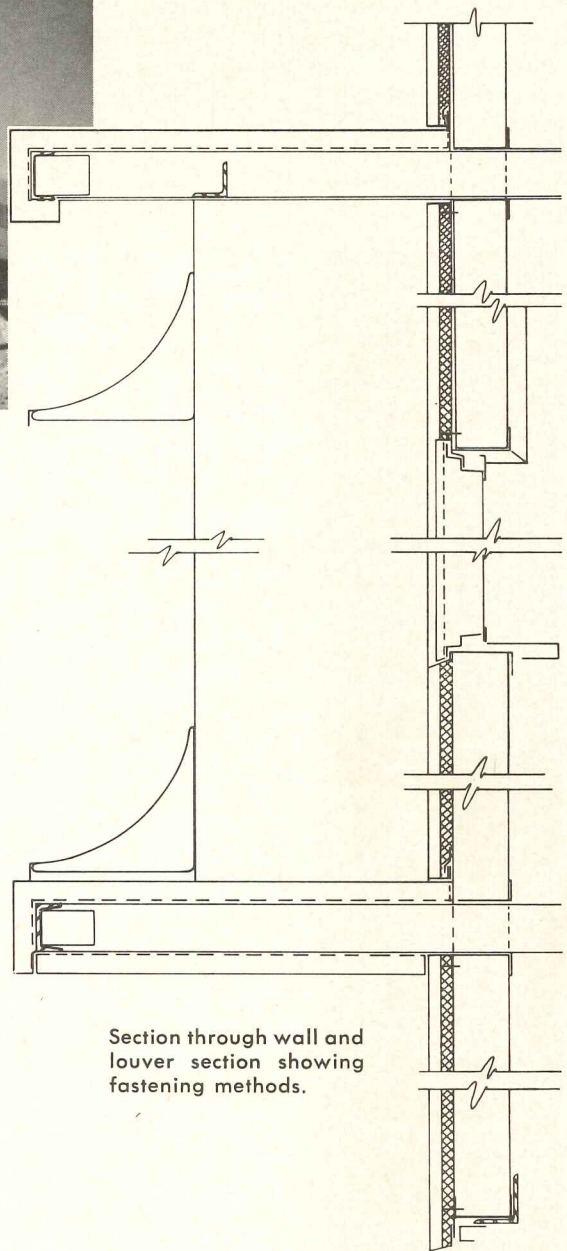

Section through wall and louver section showing fastening methods.

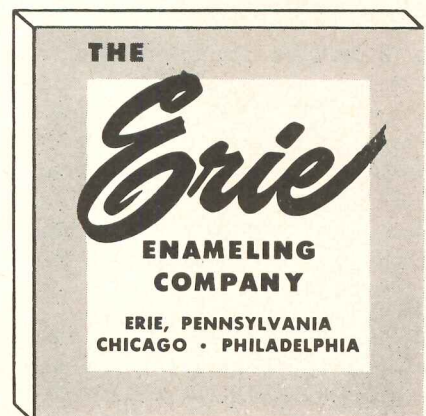

THE RECORD REPORTS

(Continued from page 330)

STUDENTS AT OREGON HELP DESIGN THEIR OWN SCHOOL

The design for an addition to the University of Oregon's School of Architecture and Allied Arts arose from a decision of the faculty of the school to use one of five designs done as a summer school project by advanced students. The Portland firm of Annan, Boone and

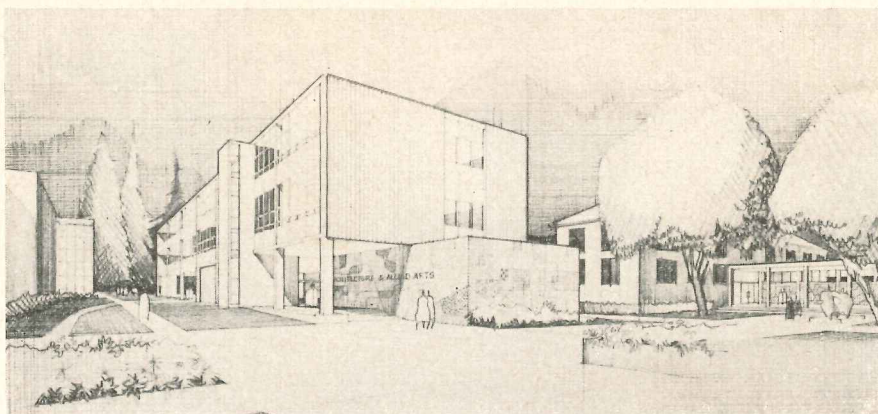

SCHLAGE door closers



Full headroom for outswinging doors... without brackets or parallel arms

EXCLUSIVE TOP JAMB

INSTALLATION — Schlage's unique double-end shaft permits installation of closer on the top jamb for outswinging doors. Now the unsightly appearance and additional cost of corner or soffit brackets can be eliminated... and there is no longer any need to use parallel arms with the resulting loss of power. Schlage door closers in the top jamb position give full and effective closing power... permit complete doorway clearance with maximum headroom to those passing through.

BALANCED, MODERN

DESIGN — Schlage's compact rectangular design door closers complement the architectural harmony of modern

interiors... blend with the horizontal and vertical lines of door and frame.

REDUCED INSTALLATION TIME

AND COSTS — Use of separate mounting plates eliminates need to juggle closer during installation... installer needs only a screwdriver to attach arm, shoe and mounting plate... and adjust closer to complete installation.

WRITE TODAY... for complete information on Schlage's modern door closer for modern interiors...

SCHLAGE[®]
SCHLAGE LOCK COMPANY
 San Francisco • New York • Vancouver, B. C.
 Address all correspondence to San Francisco

Lei was appointed to complete the plans and to handle contractual arrangements for the building, which is now under construction.

The new three-story unit will house the school's architecture classes, while the old building will be completely renovated to accommodate the allied arts unit. A one-story sculpture wing (at right in rendering) will form a link with another part of the existing building.

One wall of the architecture building, shown in the rendering with a mural, will be an experimental wall for the exhibit of mosaic, ceramic tile and fresco work done by the students.

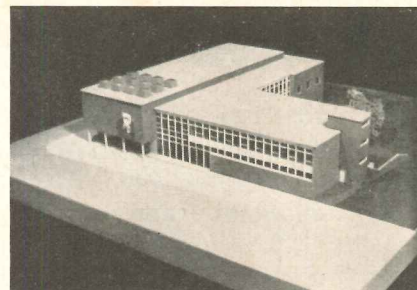

HILLEL FOUNDATION BUILDS FOR STUDENTS AT BROOKLYN

A new \$400,000 Hillel Foundation House has been proposed for the campus of Brooklyn College, and architect Percival Goodman's design would put a simple, contemporary building among existing buildings mainly Colonial in style. To harmonize with the older buildings, red brick will be used for exterior facing; the exposed steel columns will be painted white. Feeling that windows might be distracting to worship, Mr. Goodman suggested raised plastic skylights to light the chapel.

The building will have two wings, one containing the chapel and an auditorium, the other a game room and, on the first floor, offices. Other facilities will include a kitchen and a caretaker's apartment.