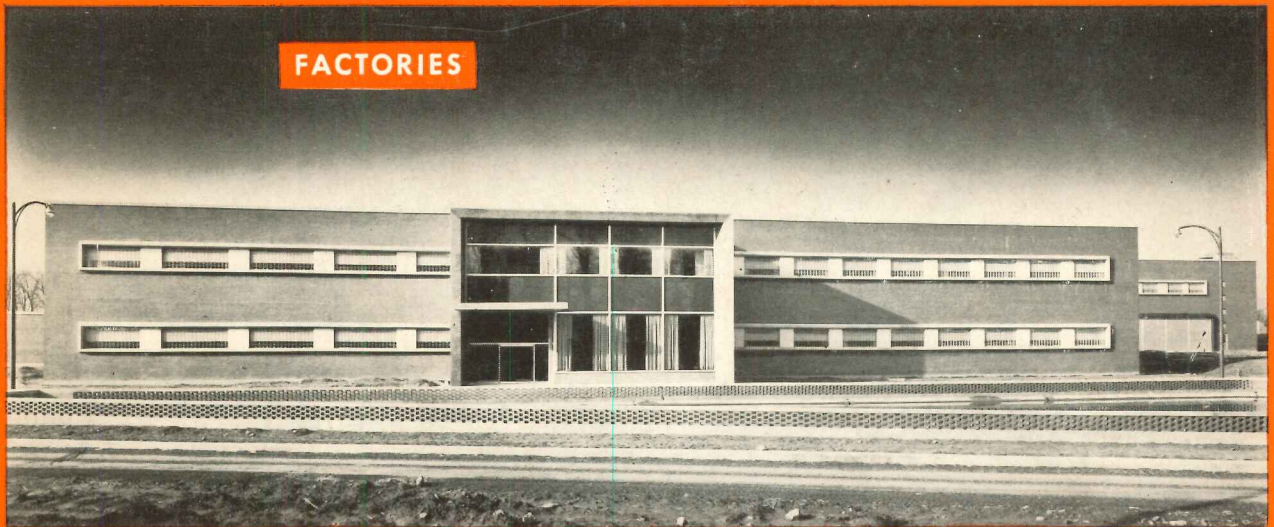


AUGUST 1953

# ARCHITECTURAL RECORD



FACTORIES

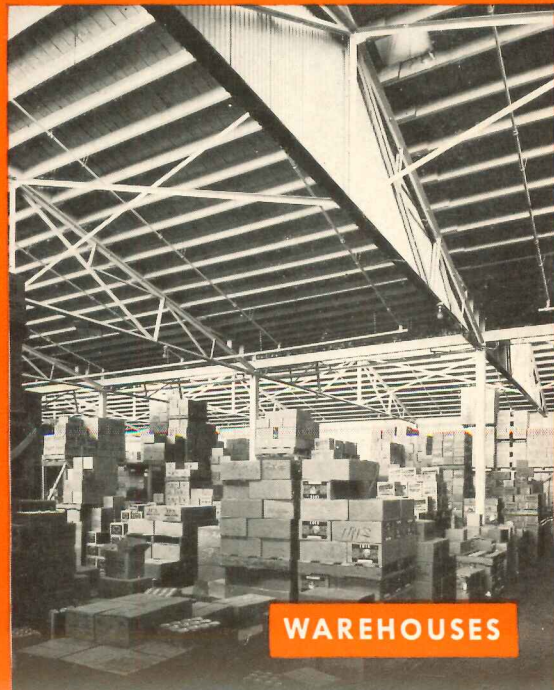
## INDUSTRIAL BUILDINGS

BUILDING TYPES STUDY NUMBER

**201**



TRUCK TERMINALS



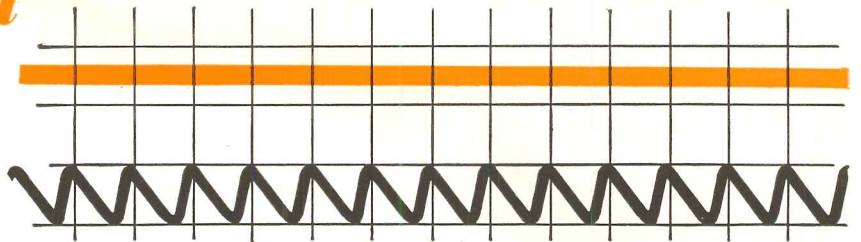
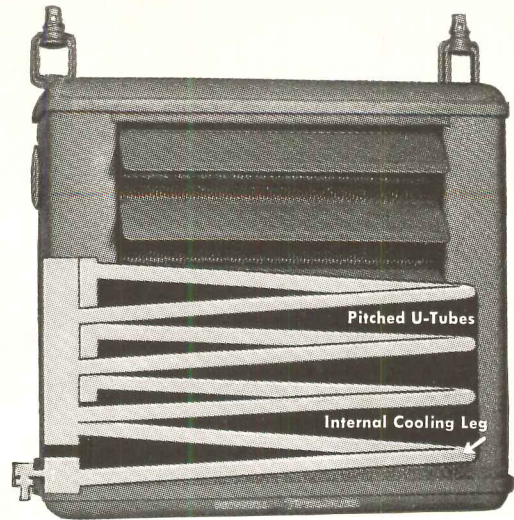
WAREHOUSES



when buying unit heaters

**be sure you  
get this**

**...not this!**



With **THERMOLIER...**

the Grinnell Unit Heater . . . you get

**CONTINUOUS RATED CAPACITY**



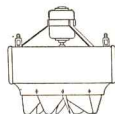
Horizontal Delivery



Textile Model



Velocity Nozzle



Vertical Delivery

**THERMOLIER FEATURES**

**INTERNAL COOLING LEG** A Grinnell feature which permits the use of a plain thermostatic trap for draining condensate.

**PITCHED U-TUBES** Built-in pitch of U-tubes provides complete drainage of condensate and elimination of destructive water hammer.

**CONTINUOUS RATED CAPACITY** The combination of Thermolier's internal cooling leg and the built-in pitch of tubes assures continuous rated capacity.

**BUILT-IN EXPANSION PROVISIONS** Every tube is an expansion bend of the U type to allow for independent expansion and contraction of each tube.

**TUBE-TO-HEADER CONSTRUCTION** Safety and durability assured by unique tube-to-header construction.

**EASE OF ERECTION** Exclusive with Thermolier are the adjustable swivel couplings which provide an easy, cost-saving method of hanging the unit.

**SIMPLE PIPE CONNECTIONS** The supply and return piping connections are on the same side to assure compactness, neatness and economy in installation.

**MOTORS** Thermolier motors are built specifically for unit heater duty. They give maximum operating efficiency with minimum power cost.

The practical advantages of unit heating, of course, are well known. But in order to get *maximum* economy and efficiency, certain engineering and structural features *must be* present in the unit heater of your choice.

Take provisions for draining off condensate. Failure to provide freedom from collected condensate in the heating element can interfere with heat output and adversely affect capacity.

A Thermolier Unit Heater successfully handles this drainage problem with its pitched U-tubes and internal cooling leg, through which all the condensate passes. In fact, condensate cooling is so efficient with Grinnell Thermoliers that a thermostatic trap — the simplest and least expensive of all traps — can be used with every model. Condensate temperature is lowered to the point where the trap is always draining — giving Thermolier Unit Heaters their *continuous rated capacity*.

Check Thermolier's advantages at left. For more details, call your local Grinnell distributor — or send for catalog.

**GRINNELL**

**THERMOLIER UNIT HEATERS**



Grinnell Company, Inc., Providence, Rhode Island

Coast-to-Coast Network of Branch Warehouses and Distributors

Manufacturer of: pipe fittings • welding fittings • forged steel flanges • steel nipples • engineered pipe hangers and supports  
Thermolier unit heaters • Grinnell-Saunders diaphragm valves • prefabricated piping • Grinnell automatic fire protection systems



# ARCHITECTURAL RECORD



Copyright 1953 by F. W. DODGE CORPORATION, with all rights reserved • Publishing Director, Magazine Division, H. Judd Payne • General Manager, Robert F. Marshall • **EDITORS:** Executive Editor, Joseph B. Mason; Managing Editor, Emerson Goble; Senior Associate Editors, Frank G. Lopez, A.I.A., James S. Hornbeck

A.I.A.; Associate Editors: Robert E. Fischer (Engineering), Florence A. van Wyck, Herbert L. Smith, Jr., A.I.A., Jeanne M. Davern (News), Elisabeth Kendall Thompson (Western); Contributing Editors: Ernest Mickel (Washington), John Caulfield Smith, M.R.A.I.C. (Canada); Assistant Editors: Jeanne G. Whitbeck (Reader Service), Enid Belding (Books), Carl Scarenco (Technical); Editorial Assistant, Patricia O. Brooks • **DESIGN:** Consultant, M. Peter Piening; Director, Alfred Petersen; Assistants: Donald Ervin, Joseph D'Amato; Drafting, Sigman-Ward • **CONSULTANTS:** Industry Relations Consultant, Thomas S. Holden; Statistical Consultant, Clyde Shute; Field Consultant, Clifford Dunnells, Jr.; Public Relations Consultant, Samuel C. Pace.

Architectural Record (combined with American Architect and Architectural) is published monthly by F. W. Dodge Corporation, 10 Ferry Street, Concord, N. H., with editorial and executive offices at 119 West 40th Street, New York 18, N. Y. Western editorial office, 2877 Shasta Road, Berkeley 8, Calif.

Chairman of the board, James McV. Breed; vice chairman of the board, Paul Abbott; vice chairman of the board, Thomas S. Holden; president, Howard Barringer; secretary, Sanford D. Stockton, Jr.; executive vice presidents: Irving W. Hadsell, Chauncey L. Williams; vice presidents: H. Judd Payne, T. Oliver Morgan, Julius T. Little, Robert F. Marshall, Howard M. Thomson; assistant secretaries: George W. Morgan, Jr., William C. Breed, Jr.; assistant vice presidents: Clyde Shute, Clifford G. Dunnells, Jr., Marc Wayne; assistant treasurers: Walter F. DeSaix, Edwin H. Freed, Irving B. Sotin; regional vice presidents: Carl S. Bennett, Raloh M. Hairston, Richard H. Ray.

Subscription rates: United States and possessions, Canada, Cuba, Mexico, Central and South America, and Spain, \$4.50 a year, \$7.50 for two years, \$9 for three years; elsewhere, \$6.50 a year, \$11.50 for two years, \$15 for three years. Single copy \$2. Circulation manager, Marshall T. Ginn.

Member of Audit Bureau of Circulations and Associated Business Publications. Architectural Record is indexed in Readers' Guide to Periodical Literature, Art Index, Industrial Arts Index and Engineering Index.

Every effort will be made to return material submitted for possible publication (if accompanied by stamped, addressed envelope), but the editors and the corporation will not be responsible for loss or damage.

Other Dodge services: Dodge Reports and Dodge Statistical Research Service, Sweet's Files, "Plannina Kit for Our New House," Chicago Construction News, Daily Pacific Builder, Denver Daily Journal, Real Estate Record & Builders' Guide.

Cover: Above, factory for The Mennen Company, Morristown, N. J., A. M. Kinney, Inc., Engineers and Architects; Interstate Photographers, photo. Below, left, truck terminal for Transcon Lines, Los Angeles, Allison & Rible, Architects; Robert C. Cleveland, photo. Below, right, Smart & Final warehouse, Phoenix, Ariz., McClellan, MacDonald & Markwith, Architects; Stuart A. Weiner, photo

<b>THE RECORD REPORTS</b> .....	9
Perspectives .....	9
A.I.A. Convention .....	9-12
News from Canada. By John Caulfield Smith .....	24
News from Washington. By Ernest Mickel .....	36
Construction Cost Indexes .....	42
Current Trends in Construction .....	316
<b>REQUIRED READING</b> .....	46
<b>FIVE CIVIC CENTERS IN SOUTH AMERICA</b> .....	121
Paul Lester Wiener and José Luis Sert, Architects	
Chimbote, Peru .....	122
Lima, Peru .....	125
Cali, Colombia .....	130
Medellin, Colombia .....	132
Puerto Ordaz and Ciudad Piar, Venezuela .....	134
<b>GOLF CLUB RESTAURANT BRAVES SUN FOR VIEW</b> .....	137
Cedarcrest Restaurant, Marysville, Wash. Harold W. Hall, Architect; Arthur A. Graves, David W. Dykeman, Jr., Associate Architects	
<b>CITY RESIDENCE BOASTS COUNTRY PRIVACY</b> .....	141
House for Mr. and Mrs. Gustav Dann, Hollywood Hills, Los Angeles, Calif. J. R. Davidson, Designer	
<b>ARCHITECTURAL INTERIORS: Gustav Dann House</b> .....	144-147
<b>BUILDING TYPES STUDY NO. 201: INDUSTRIAL BUILDINGS</b> 148	
<b>NEWER TRENDS IN INDUSTRIAL BUILDINGS</b> .....	149
By Frank L. Whitney	
<b>ATLANTA ENVELOPE FACTORY, ATLANTA, GA.</b> .....	153
Moscowitz, Willner & Millkey, Architects	
<b>MENNEN COMPANY FACTORY, MORRISTOWN, N. J.</b> .....	156
A. M. Kinney, Inc., Engineers and Architects	
<b>YEOMAN BROTHERS FACTORY, CHICAGO, ILL.</b> .....	160
John S. Cromelin, Architect	
<b>INTERNATIONAL HARVESTER BUILDINGS, FORT WAYNE,     IND.</b> .....	162
Albert Kahn Associated Architects and Engineers	
<b>STANDARD COFFEE COMPANY WAREHOUSE, NEW OR-     LEANS, LA.</b> .....	167
Richard Koch, Architect	
<b>SMART &amp; FINAL WAREHOUSE AND OFFICES, PHOENIX,     ARIZ.</b> .....	168
McClellan, MacDonald & Markwith, Architects	
<b>PHILCO WAREHOUSE AND OFFICES, CHICAGO, ILL.</b> .....	170
John S. Cromelin, Architect	
<b>MID-SOUTH REFRIGERATED WAREHOUSE, MEMPHIS, TENN.</b> 172	
E. Epstein and Sons, Inc., Architects and Engineers	
<b>ARCHITECTURAL ENGINEERING</b> .....	173
<b>TRUCK TERMINALS</b>	
1. Design Suggestions for Truck Terminals .....	173
2. Three Terminals: Studies, Experience Aid Planning .....	178
<b>PRODUCTS FOR BETTER BUILDING</b> .....	183
<b>LITERATURE FOR THE OFFICE</b> .....	184
<b>TIME-SAVER STANDARDS</b> .....	187
School Shop Planning: 4, 5, 6	
<b>INDEX TO ADVERTISING</b> .....	318



# AWARD





# THE RECORD REPORTS

## P E R S P E C T I V E S

**A NEW COUNTRY — A NEW ARCHITECTURE:** The theme of the 85th annual convention of the American Institute of Architects was conceived as a regional one — an opportunity to explore the effects upon the architecture of the Northwest of the geographic, economic and social factors peculiar to the area. The tours, exhibits and the program, emphasizing the lumber resources of the Northwest and architectural applications of wood and wood products, did implement this conception; but the three major speakers gave it a much broader interpretation. Even William M. Allen, the Boeing Airplane Company president who opened the Seattle meeting with a vivid picture of the resources and economic development of the Northwest, found in his own analysis of the area a frame of reference — “Opportunity Unlimited,” he called it — which encompassed at least the whole of America. The significance of regional influences in shaping the environment of all men everywhere was, however, a constant factor in every interpretation of the theme.

**THE TEST OF GREATNESS:** Of all the words spoken at the 1953 convention Pietro Belluschi's are likely to be longest remembered and most dis-

art. So we must accept and record as one of the aspects of ‘New Architecture’ the strivings of a few great artist-architects towards new and valid esthetic symbols by which future generations may remember us. . . . It seems to me that the test of greatness of any artist-architect is not that he be also practical but that he allow his inspiration never to be too far from the demands of his age, and the emotional needs of his contemporaries.”

“Great architecture is always a ‘Unity’ and cannot be explained or dissected into parts,” Dean Belluschi said, “. . . yet we may find it expedient to view such a Unity from three different vantage points.” The three points: “First: The exploration of structure as a source of form. . . . Second: Our attempts to more deeply understand human nature and to provide forms which will satisfy man’s physical and emotional demands; in short to make the nature of modern man the reference of our architectural thinking. . . . This concept includes . . . the understanding and acceptance of regional architecture as a sympathetic manifestation, and as a recognition of human values peculiar to certain people and places. . . . Third: . . . the attempts by the very few creative intellects to find visual esthetic symbols in a world which is in the way of losing the meaning of its destiny, in the many conflicts raised by science.” Dean Belluschi followed his talk by showing 71 slides selected to illustrate his three points.

**THE FORWARD LOOK:** “A new country,” said Boeing’s William M. Allen, “is a place where you may break with tradition and get away with it. . . . Our people have an independence unmatched, I think, elsewhere in the country. If they have a tradition, it is that of the pioneer. They have retained and developed the forward look, the willingness to try something new, to look for the better way. That, I

am sure, includes architecture as well as other things. . . . In the Pacific Northwest our living is characterized by outdoor activities, natural beauty, home gardens, hillsides, shorelines, and mountains and marine views. The architect has an opportunity to make the most of these — to make the functional lines of good engineering fit the natural beauty of the countryside, to make architecture fit our way of living.”

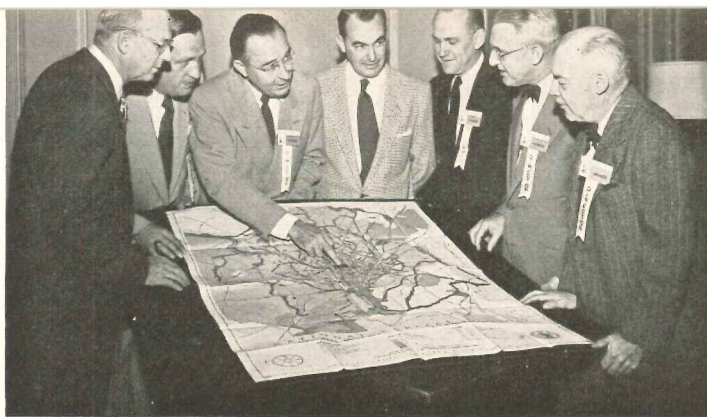
Mr. Allen cited “Opportunity Unlimited” as the broader basis of all development in the Northwest; and he added: “If the Pacific Northwest connotes the spirit of opportunity, it is a spirit which is typically American; one that can be and is being applied everywhere, because the opportunity is not so much with place as with people.”

**LIVING WITH THE EARTH:** The principal address at the annual banquet was made by George H. T. Kimble, director of the American Geographical Society, and it dealt with regionalism in the broadest terms of all. “We Americans,” Mr. Kimble asserted, “have been on a wonderful spending spree for the past 250 years. . . . We have come perilously close to bankruptcy”—and for evidence he cited the 1952 Report of the President’s Materials Policy Commission. “From now on . . . we have got to accustom ourselves to the thought of living in a strictly limited earth.” The “art of environmental appreciation,” said Mr. Kimble — feeling for spatial difference and identity — and “a recognition of limitations, both regional and global,” are essential preconditions to learning how to live with a limited earth. “By learning to live with the earth today,” he concluded, “we may yet live to see a tomorrow when ‘Nation shall not lift up a sword against a nation, neither shall they learn war any more. But they shall sit every man under his vine and under his fig tree and none shall make them afraid.’ ”



cussed. Reiterating his own conviction that any architecture of lasting significance must satisfy the mind as well as the senses, Dean Belluschi at the same time warned that “architecture could not long last as a non-pure art if it did not forever tend to trespass into the preserves of pure





Roger Dudley

A.I.A. directors with Capitol Plan urged in one convention resolution. L-R: Edward L. Wilson — Texas; John N. Richards (retiring) — Great Lakes; C. E. Silling (retiring) — Middle Atlantic; Philip D. Creer — New England; Edgar H. Berners — North Central; Irving G. Smith (retiring) — Northwest; W. Gordon Jamieson — Western Mountain



Presidents John Wade of the Architectural Institute of British Columbia (left) and Schlomo Sha'ag of the Architectural Association of Israel (right), with retiring A.I.A. President Glenn Stanton and Mrs. Chloethiel Woodard Smith, International Relations chairman

THE 85TH ANNUAL CONVENTION of the American Institute of Architects will probably live in most memories as "that wonderful trip to the Northwest." For 141 of the nearly 1500 architects and their guests who registered June 16-19 at the convention's Hotel Olympic headquarters, the fun began when the A.I.A.'s "convention special" train left Chicago on June 8 for a seven-day swing through the rugged scenic drama of the Canadian Rockies, with stops at Banff, Lake Louise and Victoria en route to Seattle. For more than 500 conventioners still another pre-convention feature will be a major memory of Seattle 1953 — the all-day tour through the Olympic Peninsula properties of the Simpson Logging Company, with the company providing a graphic account of modern forestry practices and a whole day of thrilling demonstration of the timber-to-lumber story.

When the convention got down to business on June 16, the assembled architects had an expert introduction to the regional context of the convention theme — "A New Country — A New Architecture" — by William M. Allen, president of Seattle's Boeing Airplane Company, whose keynote address, "A New Country," credited the pioneer tradition of independence and "the willingness to try something new" of its people with developing the Northwest as a region of "opportunities unlimited" in many fields — including architecture. The current awareness of regional influences in the development of contemporary architecture was reflected also (see page 9) in the two other major speeches of the convention — the annual banquet address "Living with the Earth" by George H. T. Kimble, director of the American Geographical Society, and the closing address, undisputed highlight of the

(Continued on page 284)

## THE NORTHWEST'S THE THING

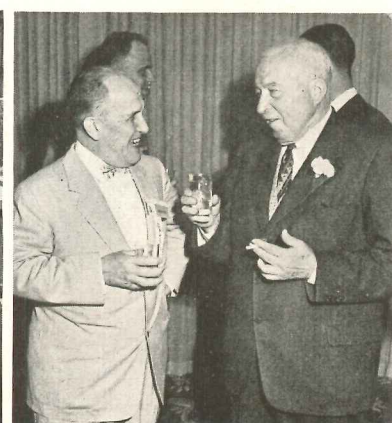
Forde photos



The all-day tour of the Simpson Logging Company properties at Shelton, Wash., drew 550 architects and their guests for a visual presentation of all phases of the lumber industry — including thrilling demonstrations of log rolling and tree topping. Participants thought the day set a pace for the convention itself that was hard to match

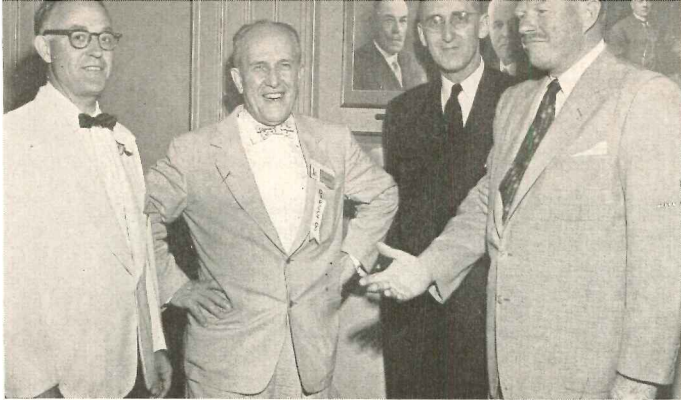


One of the "corridor conversations" that make an important part of any convention — Mr. and Mrs. Maynard Lyndon of Los Angeles and Mr. and Mrs. J. Robert F. Swanson of Bloomfield Hills, Mich.



A.I.A.'s new president — and erstwhile secretary — has a laugh with Thomas S. Holden, vice chairman of Board of F. W. Dodge Corp.





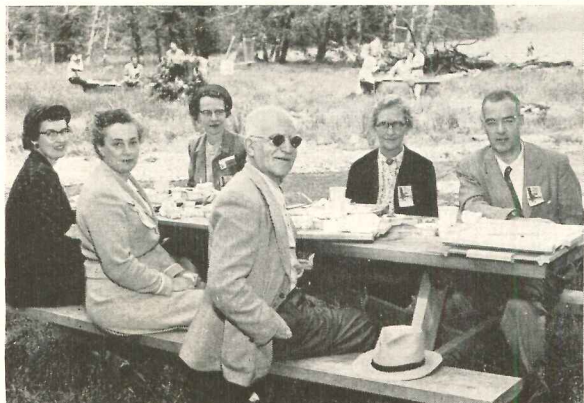
The new A.I.A. president, Clair W. Ditchy of Detroit (second from left), with Elliott C. Spratt, Producers' Council president, and John Haynes, new managing director of the Council. Joseph B. Mason, executive editor of ARCHITECTURAL RECORD, is at left



This group from the preconvention train tour got together for a "reunion" picture at one of the parties — ARCHITECTURAL RECORD'S executive editor, Joseph B. Mason, is seated at left, and a senior associate editor, Frank G. Lopez, at right. New Gulf States Regional Director Clyde Pearson is second from right (sitting, front)

## FOR 1500 AT A.I.A.'S SEATTLE CONVENTION

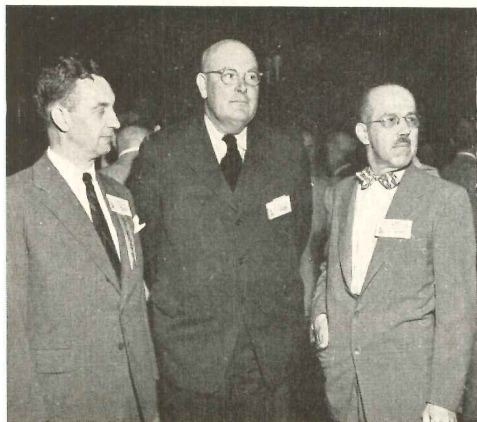
*A.I.A. National Honor Awards on page 12*



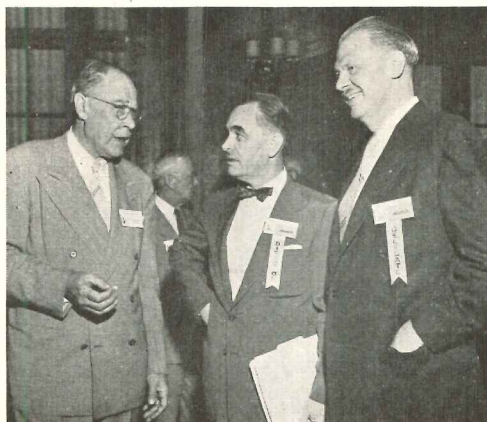
Hungry tourists got a hearty "chuck-wagon" lunch of Swiss steak on the shores of Mason Lake. Above at left (front), Mrs. Marjorie McLean Wintermute, Portland, Ore.; Mrs. Joseph Weinberg, Cleveland; Mr. Weinberg; (rear), Miss Mary Alice Hutchins, Portland; Miss Marion Manley, Miami;



and USPHS Chief Architect Marshall Shaffer. Center, a Houston contingent — (seated) Harold Calhoun and Mrs. Maurice J. Sullivan; (standing) Mr. Sullivan, A.I.A. treasurer, and Albert Golemon. Right: the Morris Ketchums of New York and the Harris Armstrongs of St. Louis



"Oriental Influence" Seminar Speakers Harwell Harris, Texas U. architecture director, and Prof. Winfield Scott Wellington, U. of California, with A.I.A. education and research chief Walter Taylor



Arthur B. Holmes, the A.I.A.'s convention manager and a busy man at Seattle, with Philip D. Creer of Providence, New England regional director, and Donald Beach Kirby of San Francisco

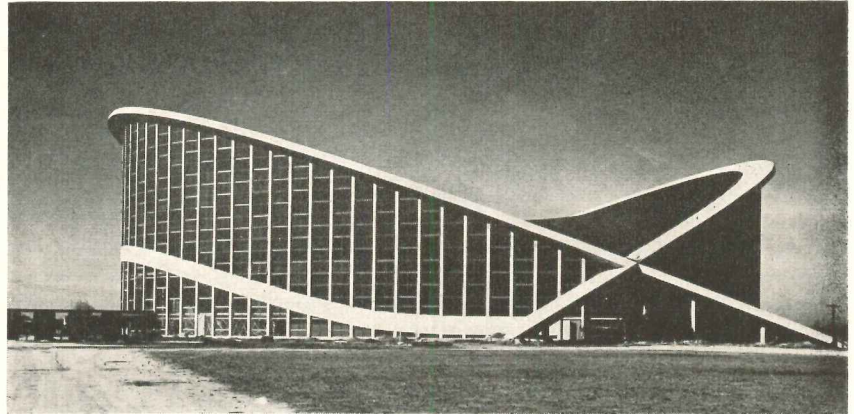


George Mayer, Cleveland; U. of Oregon architecture Dean Sidney Little and Mrs. Little; and Buford Pickens, late of Tulane, now architecture dean at Washington U., St. Louis

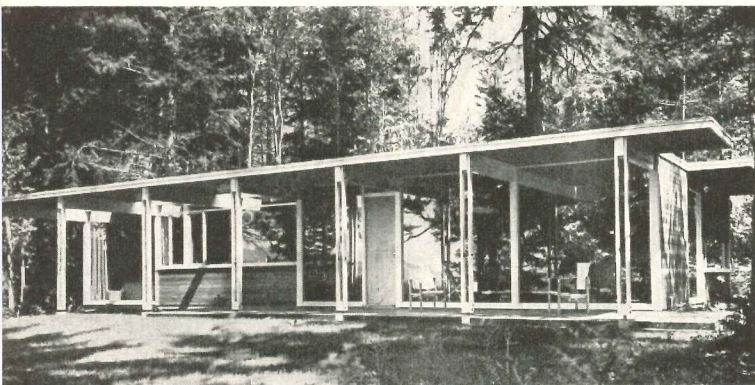


# THE RECORD REPORTS

## 1953 NATIONAL HONOR AWARDS FOR ARCHITECTURE

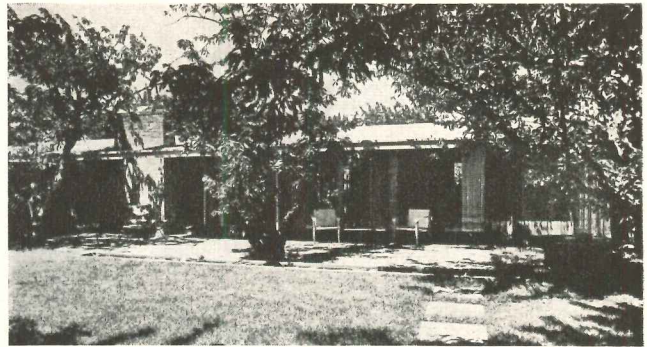


**HONOR AWARDS IN FIFTH ANNUAL** exhibition at Seattle convention were given for two buildings: engineering staff building (left above), General Motors Technical Center, Warren, Mich., designed by Saarinen, Saarinen & Associates, with Smith, Hinchman & Grylls, architects and engineers; and the North Carolina State Fair Pavilion, Raleigh, N. C., designed by William Dietrick and the late Matthew Nowicki, with Severud-Elstad-Kreuger, consulting engineers

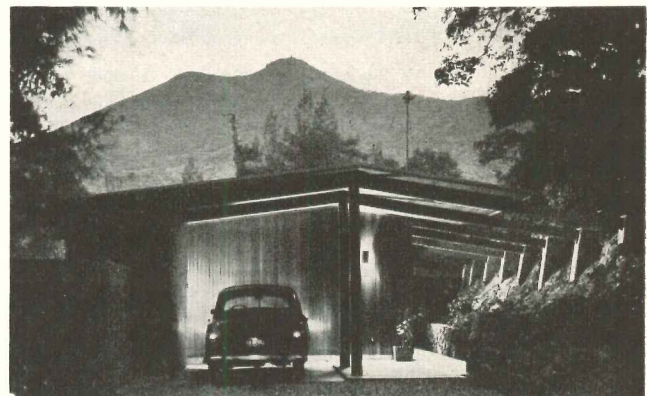


Dearborn-Massar Photo

1

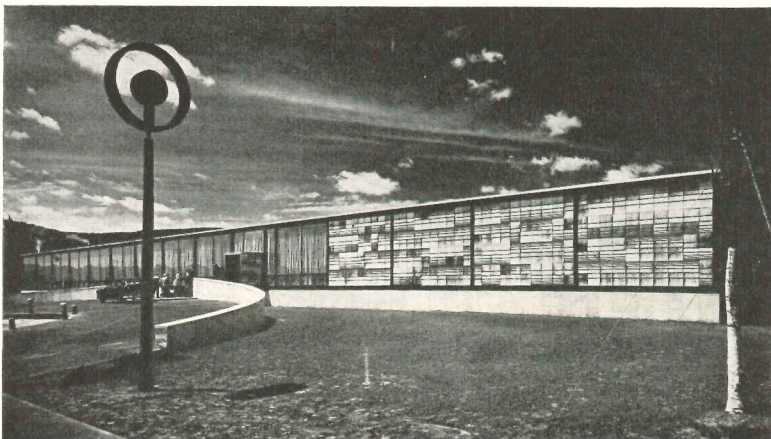


2

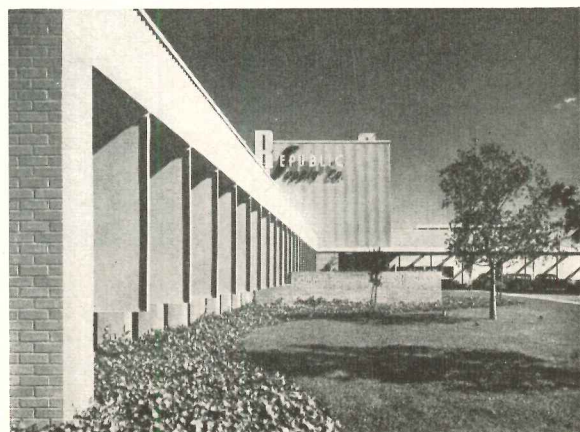


3

**MERIT AWARDS WERE GIVEN** for five buildings. 1. Forest Residence, Bellingham, Wash.; Bassetti & Morse, architects. 2. Gavello & Peregó development house, Santa Clara, Calif.; Anshen & Allen, architects. 3. Gilman Residence, Kent Woods, Marin County, Calif.; George T. Rockrise, architect. 4. Corning Glass Center, Corning, N. Y.; Wallace K. Harrison, Max Abramovitz and Charles H. Abbe, architects. 5. Republic Supply office and plant, San Leandro, Calif.; George Vernon Russell, architect

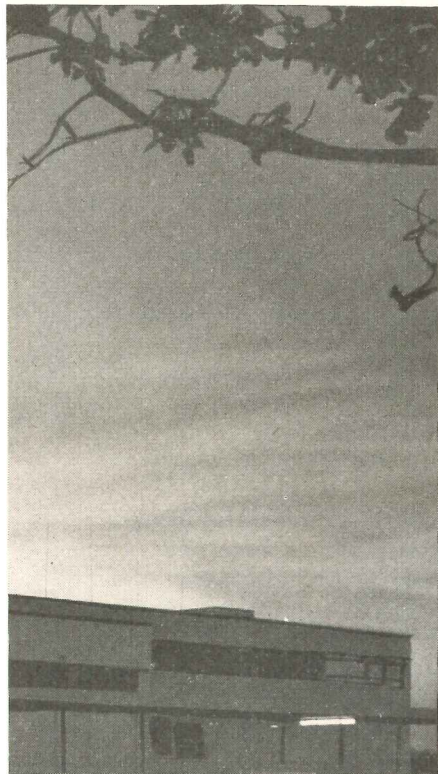


4

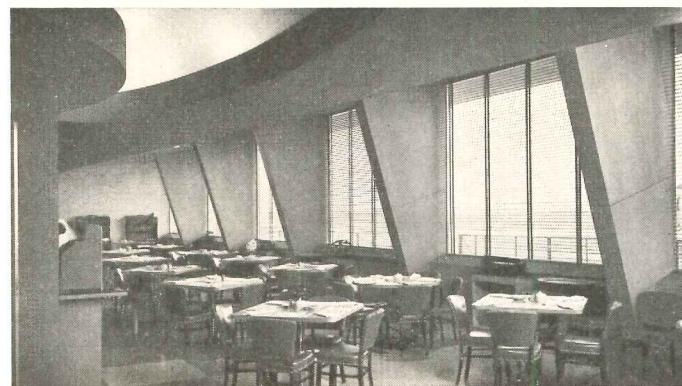


5

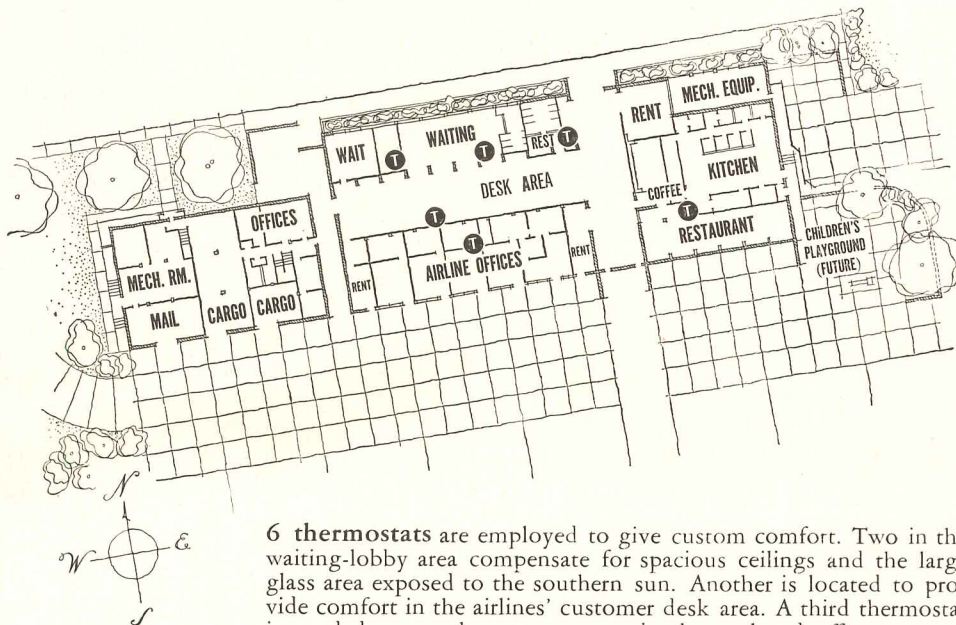




The problem in the counter area was to provide comfort—for passengers and airline personnel. Comfort load varies greatly with occupancy of room, the amount of heat or cold coming from outside. But with Honeywell Customized Temperature Control in charge of comfort, conditions are right all the time.



The problem in the dining room was to provide comfort regardless of "weather effects" of large windows, and whether there were two diners—or two hundred. And with Honeywell Customized Temperature Control on the job 24 hours a day it's comfortable in the dining room—no matter what.



6 thermostats are employed to give custom comfort. Two in the waiting-lobby area compensate for spacious ceilings and the large glass area exposed to the southern sun. Another is located to provide comfort in the airlines' customer desk area. A third thermostat is needed to regulate temperature in the enclosed office areas. A fourth, in the restaurant, compensates for heat loss (or intake) through big south windows.

*For comfortable, even temperature in new or existing buildings—of any size—use Honeywell Customized Temperature Control*

Whether it's an airport, hospital, apartment, church, school, office, factory, store, garage—or any size building—new or existing, Honeywell Customized Temperature Control can help meet your clients' heating, ventilating, air conditioning and industrial control problems.

Once equipped with Honeywell Customized Temperature Control, they'll have an ideal indoor "climate"—and save fuel besides.

For facts on Honeywell Customized Temperature Control, call your local Honeywell office. There are 104 across the nation. Or mail the coupon today.

**Claude L. Hamel, Shreveport airport manager, says:**

"It's true that we've got a great many temperature control problems here. And it's gratifying to report that Honeywell Customized Temperature Control handles them all so well."



MINNEAPOLIS  
**Honeywell**



*First in Controls*

MINNEAPOLIS-HONEYWELL REGULATOR CO.

Dept. AR-8-160, Minneapolis 8, Minnesota

Gentlemen:

I'm interested in learning more about Honeywell Customized Temperature Control.

Name.....

Firm Name.....

Address.....

City..... Zone..... State.....



SCHOOL TRUSTEES HEAR WARNING ON STOCK PLANS

STANDARDIZED DESIGNS are not a remedy for high school building costs, A. R. Prack, vice president of the Ontario Association of Architects, told the Urban and Rural School Trustees Association at its recent annual convention.

He said such plans would affect only about three per cent of the total cost of schools. Further, he asserted, if they had been in use during the postwar period the great economies made in school construction would not have been possible.

Some trustees have argued that building costs could be cut if the Department of Education provided standard plans

for schools of all sizes. They would be made available to school boards who would then, presumably, be able to do without an architect.

What About Costs?

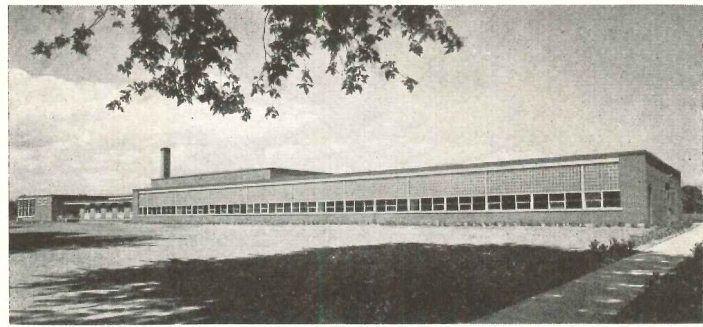
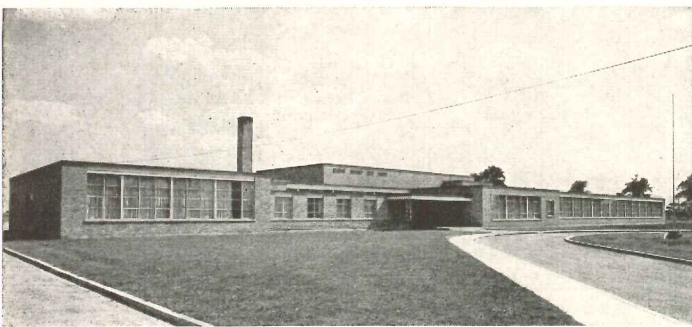
Mr. Prack, emphasizing that the architect regards each school he designs as a new challenge, noted that careful attention to function has yielded great economies in recent years. Schools are more economical to build now than before World War II, he insisted — and

cited figures on school construction in his home town of Hamilton, Ont., to support his statement. A secondary school built there in 1929 at \$8.14 per sq ft would cost \$15.53 today, he said; yet a high school built there two years ago cost \$11.90 per sq ft.

Timing and geography were proposed by Mr. Prack as the greatest factors affecting costs — in winter, for example, masonry and concrete work is more expensive and “labor is less industrious”; if a school board can get a contractor before his peak period begins, more money will be saved, Mr. Prack added.

Two architect-designed schools recently completed in Ontario: left, Glencoe District School; right, West Elgin School. Architect: C. H. Gillin of London, Ont.

Ron Nelson



CONSTRUCTION APPROPRIATION SCORE: MID-JULY (IN \$ MILLIONS)

CONSTRUCTION APPROPRIATIONS continued to provide one of the favorite sources of economy as the Congress struggled to push through the money bills that were musts before the August 1 target date for adjournment could become more than a target. The effect on 1954 construction of the lower appropriations figures can safely be assessed, however, only with an eye on the high level of carryover funds now available, for example, to the Defense Department.

Agency	Fiscal 1953	Truman Budget	Latest
<b>Dept. of Defense</b>			
<b>Military public works</b>			
Air Force.....	1.2	700	400 <sup>1</sup>
Army.....	585	(no fiscal 1954	money requested)
Navy.....	361.2		
<b>Labor-HEW</b>			
Rev. of BLS housing statistics.....		95(thousand)	95(thousand) <sup>5</sup>
Hospital const. (H-B).....	75	75	75 <sup>5</sup>
School construction.....	195	(no fiscal '54 auth.)	
<b>Independent Offices</b>			
Housing and Home Finance Agency (total).....	104.4	75.5	64.9 <sup>5</sup>
Cap. grants for slum clearance.....	8	20	20 <sup>5</sup>
Atomic Energy Commission (plant & equipment) ..	3.2(billion)	436.3(million)	166 <sup>4</sup>
VA hospitals.....	49.7	92.3	2.5 <sup>4*</sup>
<b>Army Civil Functions</b>			
General Investigations.....	3.2	5.5	3.4 <sup>5</sup>
Construction, general.....	404.8	491.2	313.2 <sup>5</sup>
Operation and Maintenance.....	83.8	90	77.5 <sup>5</sup>

- 1) Eisenhower request
- 2) House committee
- 3) House
- 4) Senate committee
- 5) Senate
- 6) Joint committee
- 7) Final House
- 8) Final Senate
- 9) Eisenhower signature

\* Planning funds for three proposed new hospitals (San Francisco, Topeka and Houston). No construction money.





UTILIZE SPACE . . .  
SPECIFY *Pella*<sup>®</sup>  
WOOD FOLDING  
DOORS

WICKLIFFE ELEMENTARY SCHOOL, YOUNGSTOWN, OHIO

HERE'S WHAT THEY'RE SAYING  
ABOUT Pella WOOD FOLDING DOORS

"We are happy to advise you that Pella Wood Folding Doors installed in the auditorium of Wickliffe Elementary School have proved eminently satisfactory in every respect. The installation harmonizes beautifully with woodwork, furnishings and trim.

"The Pella Doors are mechanically perfect in operation and have given us two greatly needed classrooms, side by side, inside the auditorium. Best of all, the mechanical operation is so simple that a sixth grade child can throw open the doors, permitting use of the entire space for auditorium purposes."

Marcus V. McEvoy, Superintendent  
Austintown Public Schools  
Youngstown, Ohio

Give your clients full use of their rooms by specifying Pella WOOD Folding Doors. In schools, churches, hospitals and other institutions, there's no substitute for the *natural beauty* of space-saving Pella WOOD Folding Doors. Individual panels,  $\frac{3}{8}$ " thick and  $3\frac{5}{8}$ " wide, joined by continuous spring hinging, stack to 6" for average interior door opening. Track with concealing wood mould, all attaching hardware *and latch* are supplied as standard items. Prefitted to opening to install quickly and easily. Fashioned from pine, oak, mahogany or birch. Specify painted, clear varnished or unfinished. Stock sizes or custom-built.

For complete details  
write Dept. E-30,  
Rolscreen Company,  
Pella, Iowa

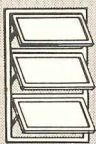
see our catalog in



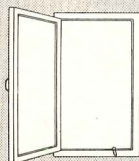
or write for copy



PLAN WITH *Pella* PRODUCTS MADE BY ROLSCREEN COMPANY, PELLA, IOWA



*Pella*  
MULTI-PURPOSE WINDOWS



*Pella*  
WOOD CASEMENTS



*Pella*  
ROLSREENS



*Pella*  
LITE-PROOF SHADES



*Pella*  
VENETIAN BLINDS



## THE RECORD REPORTS

### CANADA

(Continued from page 24)

It costs less to build a school in a remote small town than in a small town near a big city, he said; in the former, the labor will be local and may be non-union, while in the latter, the big city contractor, with union labor, will be

hired and will add traveling expenses to his costs.

Mr. Prack also reported that his own firm's research had shown a one-story school to be more economical to build if it contains up to 12 classrooms. Beyond that size, the two-story school was found to be more economical.

### 1960 BUILDING LEVEL OF \$8 BILLION IS FORECAST

A volume of construction worth \$8 billion in 1960, almost double current

annual construction, has been predicted by John N. Flood, president of the Canadian Construction Association.

He bases his calculation on the theory that the construction industry will continue to expand at the same rate as in the postwar period and prices will remain at today's levels.

Mr. Flood also envisions steel production of 6,500,000 tons in Canada in 1960 and cement output of more than 47 million barrels.

However, he points out, demand for construction depends on many economic and psychological factors—the whims as well as the financial resources of owners and their assessment of construction and other capital costs in terms of the potential return on their investment.

In Mr. Flood's opinion, Canadian construction has some serious growing pains ahead. He noted a trend toward individual projects on a larger scale which may force construction companies to develop new sources and methods of financing.

Referring to a shortage of skilled machinists, he pointed out that labor has a significant stake in the construction industry, since about 90 per cent of the value of construction contracts represents wages to on-site employees and those engaged in manufacturing, distributing and transportation industries.

### The Big Problem: Housing

Housing continues to be the leading social problem, Mr. Flood declared, adding that it is essential that additional financing sources be developed. It would be desirable, he noted, for these funds to come from private sources.

Mr. Flood also predicted a continuing problem in building sufficient roads.

### LATEST FIGURES REVEAL 1953 BUILDING OVER '52

Canada's building boom continues. After a serious first-quarter lag, April construction contract awards showed a sharp reversal of the earlier downward trend and latest available figures issued reflected a continued improvement in May that brought the total for the first five months of 1953 to \$789,295,700, or \$88,421,300 over the corresponding period in 1952.

May building awards, as reported by MacLean Building Reports Ltd., totaled \$181,682,800, an increase of \$5,951,700 over May 1952. Except for engineering,

(Continued on page 30)



**GLOBE SPRINKLERS**

**FIREMEN EVERY 10 FEET**

**ASK YOUR FIRE INSURANCE BROKER...**  
An expert... he will tell you that automatic sprinklers detect and stop FIRES...and provide permanent protection that permits a big saving in your yearly insurance premiums. Install GLOBE Automatic Sprinklers for safety and savings.

**GLOBE AUTOMATIC SPRINKLER CO.**  
NEW YORK . . . CHICAGO . . . PHILADELPHIA  
Offices in nearly all principal cities

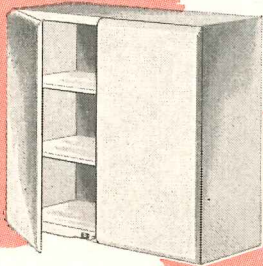
**THEY PAY FOR THEMSELVES**



# THIS NEW KITCHEN LINE

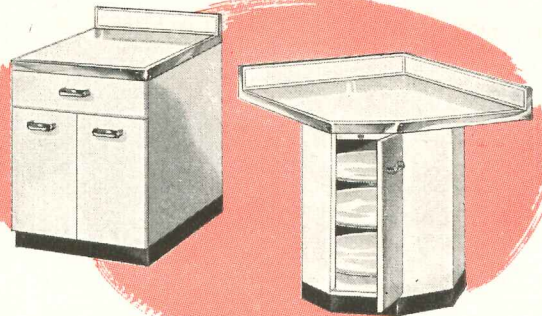
by **Universal-Rundle**

*Beautifully Designed  
All-Steel Cabinets!*



## WALL CABINETS!

Top quality cabinets of heavy gauge furniture steel . . . easily adjustable and removable shelves . . . quality features galore . . . a wide range of sizes!

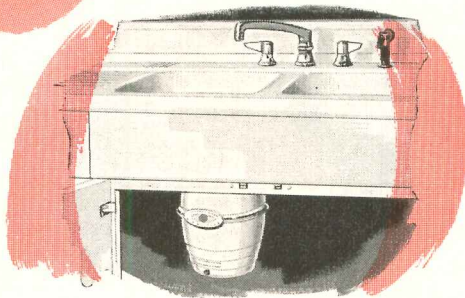


## BASE AND CORNER CABINETS!

Designed to match U/R Easy Living cabinet sinks . . . U/R quality features . . . choice of cabinet tops . . . handy "Lazy Susan" corner cabinet . . . easy operating doors and drawers . . . sizes that let you plan "built-in" styling in every kitchen.

## DISPOSER!

The most quiet disposer made—and the easiest to install! Revolutionary "Under-cut" action reduces noise, gives speedy grinding action.



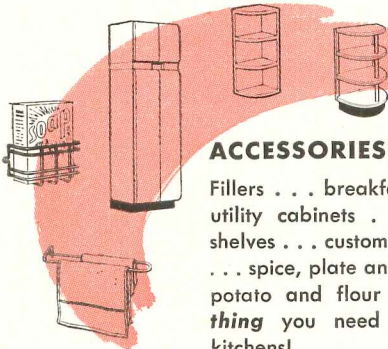
## CABINET SINKS!

Choice of vitreous enameled cast iron or steel! Famous U/R sink quality, with top quality cabinets to match U/R Easy Living base and wall cabinets. Wide choice of models to fit every kitchen and budget.



## ACCESSORIES!

Fillers . . . breakfast bars . . . utility cabinets . . . what-not shelves . . . custom counter tops . . . spice, plate and soap racks, potato and flour bins—*everything* you need for modern kitchens!



**GET ALL THE FACTS! MAIL TODAY!**

UNIVERSAL-RUNDLE CORPORATION  
175 River Road, New Castle, Pennsylvania

Send me complete facts on U/R "Easy Living" Kitchens.

NAME \_\_\_\_\_

FIRM NAME \_\_\_\_\_

ADDRESS \_\_\_\_\_

CITY \_\_\_\_\_ ZONE \_\_\_\_\_ STATE \_\_\_\_\_

**KITCHENS**  
**★ Rundle**  
**and Kitchen Equipment**



## THE RECORD REPORTS

### CANADA

(Continued from page 26)

all categories of work gained in the month. Even in the engineering classification, such work as sewerage, waterworks, roads and streets, and power and communications was in larger volume. A major gain is reported for residential

building, but contract work on schools was down for the month.

#### Comparative Figures (from MacLean)

	May 1953 (\$ millions)	Per Cent Change From 1952
Residential . . .	68.4	+25.8
Business . . . .	48.2	+13.9
Industrial . . . .	36.2	+ 9.1
Engineering	28.7	-42.9
<b>Total</b>	<b>181.5</b>	<b>+5.9</b>

Regionally, the May figures show a spotty pattern. In the Maritimes and

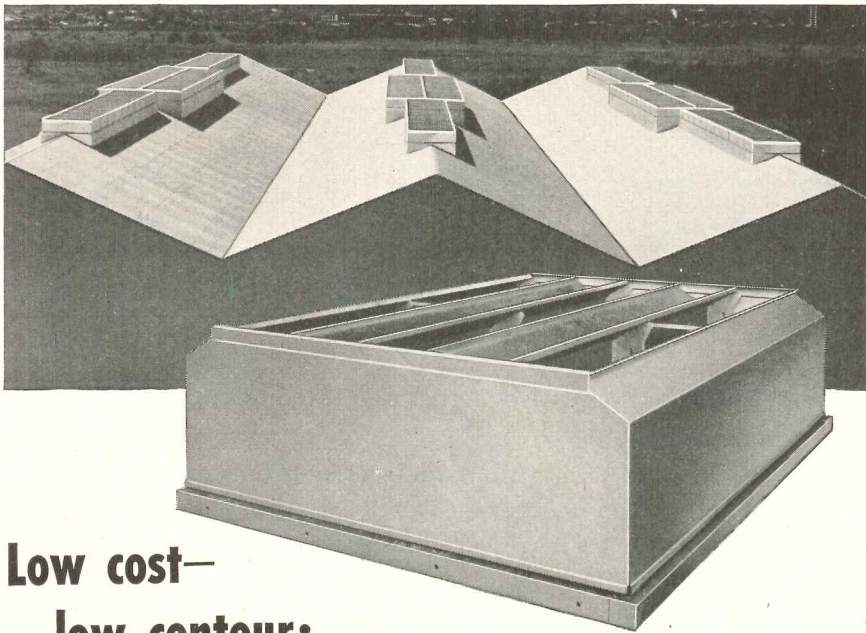
the West only residential and business construction gained; and in Quebec residential construction alone had a slight improvement.

Ontario figures were dominant in establishing the all-Canada pattern, with solid gains in residential, industrial and commercial construction and even a substantial counter-trend gain in engineering.

Types of projects in the 21 entries in the "Big Job" list (projects over \$1 million) reflect the overall figures, with only one outstanding engineering project on the list — \$5 million in additional work on the Niagara Falls hydro job. A \$30 million automobile plant in Oshawa, Ont., shaded all other undertakings by a good margin.

#### SIX-MONTH WAGE RAISE HELD TO 1.6 PER CENT

The most recent reports on the Canadian wage rate index showed an increase of 1.6 per cent over the last six months. (Continued on page 32)



### Low cost— low contour; Swartwout Airmover combines these important advantages in large scale ventilation

You can make wide use of Airmover's many advantages for a large variety of buildings. In this exclusive Swartwout Ventilator design you get (1) great exhaust capacity without power cost; (2) low, spreading contour that eases roof load, enhances the building's appearance, and avoids stays and guy-wires; and (3) provides lowest cost ventilation per square foot of roof opening.

Airmover can be applied to any type of roof. It's completely weatherproof; has adjustable damper for varied opening. Its low-air-friction design assures high capacity gravity exhaust. Write for Folder 326G.

18511 Euclid Avenue, Cleveland 12, Ohio

## The Swartwout Co.

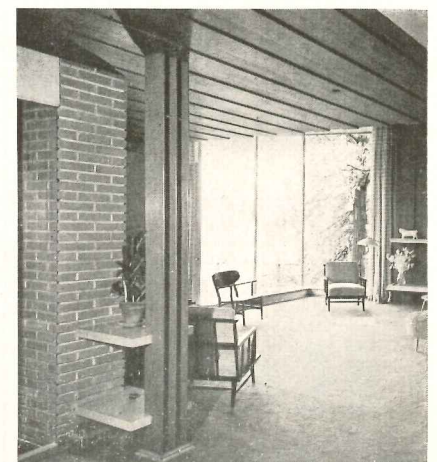
### Roof Ventilators and Ventilating Louvers

POWER PLANT EQUIPMENT • PROCESS INDUSTRY CONTROLS



James B. Hardy Studios

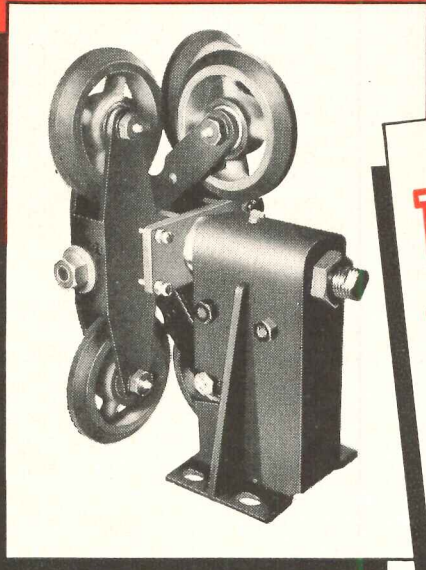
House design in Montreal meets a perpetual challenge from the fact that the city's choicest residential area is a mountain — Westmount. Max W. Roth was the architect for this Westmount house. Interior view shows corner of living room





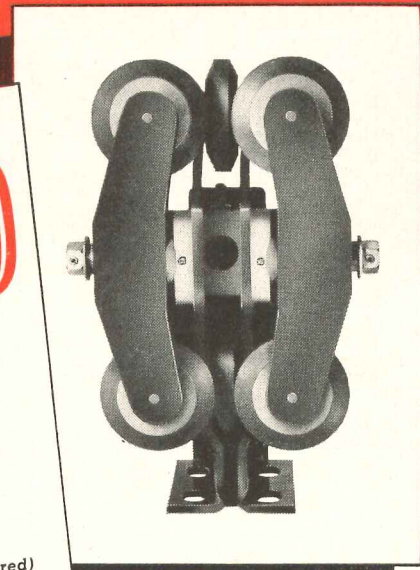
# ELIMINATE The Greatest Fire Hazard In Your Building

and save up to \$500 per elevator each year



MODEL A—for elevators

USE  
**ELSCO**  
SAFETY  
ELEVATOR  
ROLLER  
GUIDES  
(Patented and Trade Mark Registered)



MODEL C—for counterweight  
and low rise, low speed elevators

**1** Eliminate inflammable oil, grease and fuzz by operating elevators in completely dry shaftways and on dry rails. This will prevent for all time, flash and general fires starting or drawn into the elevator shaft. Fires in elevator shafts constitute the greatest menace to life and property in buildings.

**2** Since ELSCO GUIDES roll and do not slide, they are an anti-friction device, and save between 25% and 40% in electricity. All of our tests have proven this savings beyond peradventure of doubt. Many customers made their own tests and all reported similar results.

**3** The large labor cost of frequent hatchway cleaning is completely eliminated. Those customers formerly in doubt now report that on rare occasion they use vacuum cleaners to remove dust, although not essential.

**4** ELSCO GUIDES take up all badly aligned rail and unbalanced conditions, because they operate on the principle of traction, oscillation and knee action. They contain stabilizing springs and actually glide and float in the hatchway. They contain adjustments so that they may be adapted to all conditions. They eliminate the knock and jiggling of cars and permit better leveling. They are readily adaptable for conversion from present sliding guides.

**5** Dry rails create the perfect condition for the holding of safety jaws in the event of accident.

**6** ELSCO SAFETY ROLLER GUIDES may be installed on all passenger and freight elevators, space permitting. They have been employed on the highest rise and speed passenger elevators and heaviest duty freight elevators. They are adjustable, take standard rails and jumbo rails up to 1 1/4" in width.

**7** Model C units may also be used on passenger elevators up to 200 F.P.M. — 2500 lbs. capacity.

**8** The rubber compound used on the wheel assemblies, specially developed by us during the last few years, stand up indefinitely.

**9** There are two special rouge polished ball bearings in each wheel assembly. They come seal packed. We have nevertheless installed a zerk fitting in each wheel assembly should lubrication be required at a later date.

**10** Once installed and adjusted ELSCO GUIDES require no maintenance, with the exception of the recommended annual lubrication of bearings.

**11** ELSCO GUIDES have been unanimously approved by the Board of Standards and Appeals of the City of New York up to 1200 F.P.M.

**12** ELSCO GUIDES are now installed in every part of the United States and also in Europe, Canada and Mexico. There are more than 200 agents throughout the country ready to serve.

FOR FURTHER INFORMATION INQUIRE OF YOUR MAINTENANCE COMPANY

OR

## ELEVATOR SAFETY CORPORATION

165 BROADWAY • NEW YORK 6, N. Y.



One of a series of papers prepared by leading authorities on air conditioning. The opinions and methods presented are those of the author and are not necessarily endorsed by the Du Pont Company. Reprints of this article, and others in the series, may be had free upon request.

# Air Conditioning For Modern Industrial Buildings

by A. B. WATERBURY, Assistant Chief Engineer—Walter Kidde Constructors, Inc., New York, N. Y.



**A. B. WATERBURY** is a graduate of Stevens Institute of Technology, and a licensed professional engineer in New York State. For twenty years an associate of Clyde R. Place, Engineers, he worked on mechanical and electrical aspects of engineering projects. Mr. Waterbury joined Walter

Kidde Constructors in 1947 and has worked on projects for many clients that have required complex air conditioning installations. For a period of three years he was an instructor in heating, ventilating and air conditioning at New York University.

Many of the manufactured products that are now considered commonplace, and which are sold at a price within the financial reach of all, were made possible as a result of modern air conditioning in industrial plants.

Air conditioning has advanced a long way since its early applications in textile and printing plants. For one thing, it has made increased defense production possible. Machine parts, regardless of where they are produced, can now be assembled at some common point without fear of mismates, as the parts were made under controlled air conditions. Fine and exact tolerances can be maintained regardless of plant locations or weather conditions. Laboratory testing and inspection procedures are now based on standard air and humidity conditions. There are fewer rejects in machine shop work because of tolerance or corrosion on fine parts due to humidity.

## TWO REASONS

There are two main reasons for air conditioning the modern industrial plant. Simply stated, these reasons are for the control of a specific process or production method, and for increased employee comfort that leads to increased production output. Process air conditioning is used to control moisture regain, rate of crystallization, rate of chemical and biochemical reactions, oxidation and the control of close machine tolerances.

## MORE EFFICIENT PRODUCTION

Industry is based on the production unit of output per man hour. Air conditioning is an important factor for

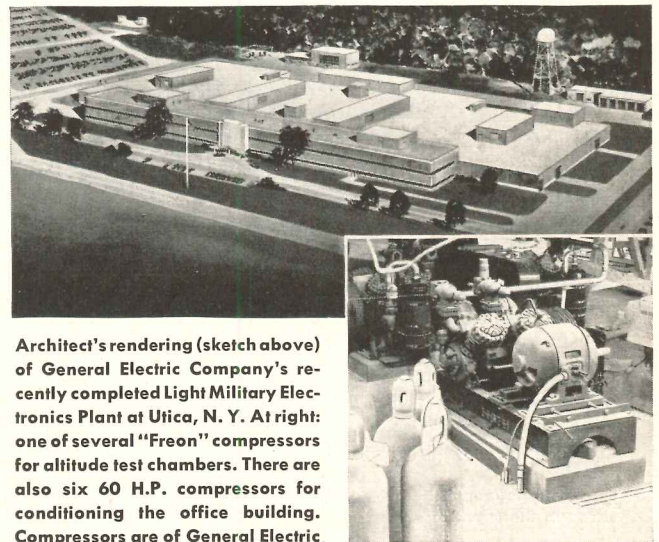
increasing efficiency, thus increasing production output.

The manner and extent to which air conditioning is applied to an industrial plant is largely dependent on the type of work. Those who work seated at benches or at small machines, as in assembling small parts, inspecting finished parts or in packaging, require a larger amount of cooling in summer or heating in winter than do employees who are on their feet or who move about. The average conditions for those seated at tables or benches during summer should be about 80°F. and 50 per cent relative humidity.

Drafts are an important consideration. Those who are seated at work, especially older workers, are particularly sensitive to excessive air movement or drafts.

## SAFETY FOR THE WORKER

Although some industrial processes may require high temperature and humidity, it is necessary to sacrifice something in the way of production to bring conditions to the point where they will be closer to the personal comfort of the employees. Even in the glass industry, in which extreme high temperature is normal, it has been found good practice to install air cooled walls to absorb some of the radiant heat.



Architect's rendering (sketch above) of General Electric Company's recently completed Light Military Electronics Plant at Utica, N. Y. At right: one of several "Freon" compressors for altitude test chambers. There are also six 60 H.P. compressors for conditioning the office building. Compressors are of General Electric manufacture.

In atmospheres containing volatile solvent vapors, particularly where there is a high concentration of such gases, good practice is to have two or three air changes per minute. In addition, the relative humidity is increased to 50 or 60 per cent to avoid dangers from possible explosion, where such vapors are present in explo-



sive proportions.

Many accidents at machines are due to repetitive hand movements inducing drowsiness. Air conditioning has cut accidents and careless operation due to such causes, and has even bettered production.

## MECHANICAL EQUIPMENT

Although industrial plants have more commonly been served from central air conditioning systems, the use of self-contained or packaged units is looked upon with increasing favor.

1. It has minimized the use of costly ductwork.
2. Where processing can be concentrated by component steps, it is possible to supply each area or process with its special air conditioning from individual unitary equipment.

It is also possible to eliminate excessive duct systems by piping chilled water that is cooled by a central refrigerating system through multiple unit coolers. These unit coolers generally consist of fans, chilled water coils, heating coils and filters. With such a system, the chilled



"Climate Room" (top photo) for testing electronic equipment in temperatures as low as -76 F., readily obtained with "Freon-22." Bread cooler (below) in modern bakery cuts cooling time from several hours to 80 minutes!

water piping is frequently used to supply hot water to the units for space heating during the winter.

## CLEAN AIR

Filters are a must with a system supplying air, particularly where a high degree of air cleanliness is necessary. The procedure is to pass air through filters before it passes through finned cooling or heating coils so that dust will not collect on fins to decrease the heat transfer.

The filter may be an air washer using a water spray; dry or oil-impregnated filters of glass or metal fibers; dry paper or electrostatic filters. Where even the finest dust particle must be removed, as in the manufacture of electronic equipment or pharmaceutical products, electrostatic filters are used. For average conditions, the other types will give good results.

## INDUSTRIAL AIR CONDITIONING

In pharmaceutical plants, pills are made in air conditioned rooms to control the quality of the coating applied. Air conditioning of all areas where sterile operations are performed is almost a "must."

Air conditioning for textile processing plants is designed to maintain an effective temperature of from 78° to 80°F. Such temperatures are comfortable for the operators and they permit a range of dry and wet bulb

temperatures correct for the type of fibers used.

In the manufacture of ball bearings, air is held at 34 to 36 per cent relative humidity and 74°F. temperature for the final inspection and packing areas. While it is possible to use a lower relative humidity, this range has proved to be most satisfactory.

In the manufacture of hard candy, temperature is held from 75° to 80°F. and relative humidity from 30 to 40 per cent. In the production of chocolates, temperatures in the hand-dipping room vary from 60° to 65°F. and relative humidity, from 50 to 55 per cent. Chewing gum is made in rooms held at 77°F. and 33 per cent relative humidity.

For precision machining, particularly in special assembly rooms, temperature is from 75° to 80°F. and the per cent relative humidity, from 35 to 50.

Thermo-setting moulding compounds (plastic industry) are handled in rooms of 80°F. and 25 to 30 per cent relative humidity.

During the production of cigars and cigarettes, the air temperature is from 70° to 75°F., and the humidity from 55 to 65 per cent. During the softening of the tobacco, the temperature is 90°F. and from 85 to 88 per cent relative humidity; stemming or stripping, 75° to 85°F. and 70 to 75 per cent relative humidity.

\* \* \*

While the ramifications of industrial needs are too complex to treat the subject of air conditioning in detail in a paper of this length, it can readily be seen from Mr. Waterbury's article, that air conditioning is essential in almost every industry. Although specific requirements will vary in each case, controlled conditions of temperature, humidity and refrigeration remain basically the same.

It has become well recognized in many industries that quantity and quality of production output are directly influenced by working conditions and the comfort of individual employees. Today, management generally looks upon air conditioning in the light of a production tool which, in many instances, may be fully as important as light, heat and plumbing facilities.

Because the installation of a system frequently represents a sizeable investment, you can render a valuable service by recommending equipment designed to operate with Du Pont FREON® fluorinated hydrocarbon refrigerants. These refrigerants are ideal for industrial systems of every size and for every purpose. They are safe . . . nonflammable, nonexplosive, virtually nontoxic and are produced in strict accordance with intricate, laboratory-controlled methods that insure quality and uniformity. They contribute to the economical, satisfactory operation of the machines over long periods of time. In addition, "Freon" refrigerants meet all building-code requirements. E. I. du Pont de Nemours & Co. (Inc.), "Kinetic" Chemicals Div., Wilmington 98, Del.



REG. U. S. PAT. OFF.

BETTER THINGS FOR BETTER LIVING . . . THROUGH CHEMISTRY

**"FREON" SAFE REFRIGERANTS**



"Freon" is Du Pont's registered trade-mark for its fluorinated hydrocarbon refrigerants



**HOUSING BILL PASSED —  
PRESIDENT GETS POSER**

THE 1953 HOUSING BILL sent to the President last month for his signature extended for one year most of the government's housing program and left up to the President the thorniest question put before the Congress in the course of the debate on the bill — whether or not to lower down payments on government-

insured mortgages. The bill gave the President authority — which the Administration had not requested — to lower to not less than five per cent down payment requirements on mortgages insured by the Federal Housing Administration or guaranteed by the Veterans Administration and to extend the repayment period from 25 to 30 years if he thinks such moves are necessary to stimulate home building. Although the

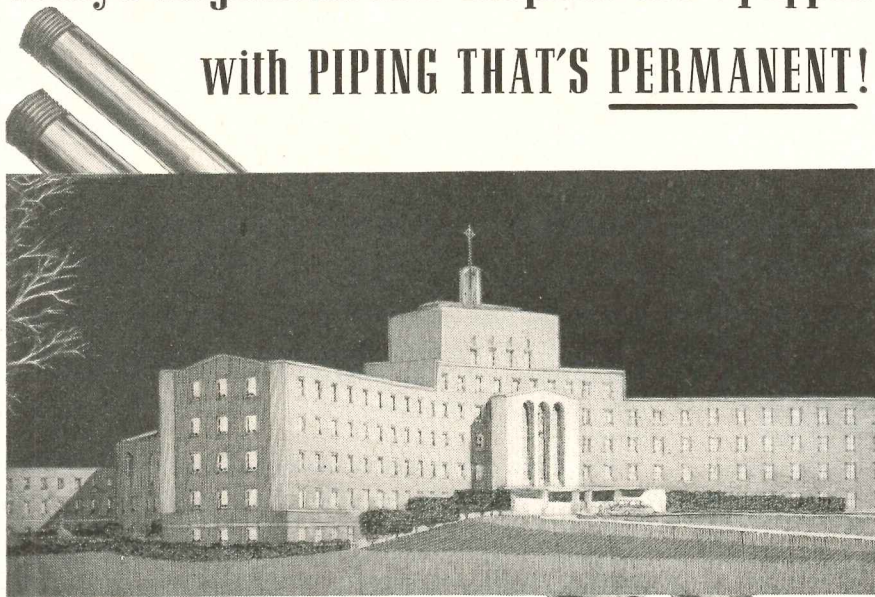
authority was permissive, not mandatory, and although lower down payments had been expressly excluded from the Administration's housing bill recommendations as "inflationary," industry groups like the National Association of Home Builders which had been battling for the downward revision were expressing a cautious jubilation on the theory that the President would be more receptive to the idea now that Congressional concern had been expressed.

On another controversial point, Congress revoked the May 18 order of the Veterans Administration requiring builders to certify to the agency that they have not or will not pay nor absorb, directly or indirectly, any charges or fees in excess of those authorized by VA.

The bill also increases by \$1.5 billion the present \$13.2 billion available for insurance of the regular FHA sale and rental insurance program and authorizes the Federal National Mortgage Association to sell and buy mortgages on a "one-for-one" basis, up to a \$500 million limitation.

(Continued on page 38)

**Today's magnificent new hospitals are equipped  
with PIPING THAT'S PERMANENT!**



Architect's Rendition of Resurrection Hospital, Chicago. Architects: Schmidt-Garden & Erikson. Plumbing Contractor: Fettes, Love & Sieben. Clow (threaded) Cast Iron Pipe for all downspouts, wastes and vents.

**Clow (threaded) Cast Iron Pipe  
adds permanence to all buildings**

The newly-constructed hospitals so desperately needed today will play a vital part in the good health of Americans for decades to come.

These important buildings *must* be built for permanence. That's why more and more architects and contractors choose Clow (threaded) Cast Iron Pipe for the downspout, vent, and waste lines in today's hospitals. They know that because of its great resistance to corrosion, Clow piping will last the life of the building. They prefer Clow pipe, too, because of its low installation cost.

Write today for complete, factual information on Clow (threaded) Cast Iron Pipe.

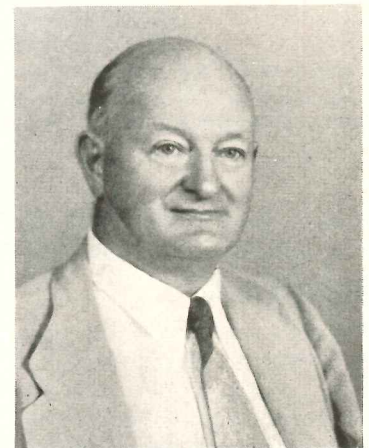
**A COMPLETE LINE  
FOR ALL PIPING NEEDS**

Clow (threaded) Cast Iron Pipe has same O.D. as steel pipe, is available with plain or threaded ends, in 3, 4, 5, 6, 8 and 10" sizes in 18' random lengths. Also available with integral calking hub on one end (other end plain) in 18' random lengths in 4, 6 and 8" sizes.

**Clow Cast Iron Pipe  
can be...**



on the job, with ordinary tools of the piping trade.



James W. Follin has succeeded Nathaniel S. Keith as director of the Division of Slum Clearance and Urban Redevelopment of the Housing and Home Finance Agency. Mr. Follin's numerous government services have included, besides his most recent post as director of the office of contract settlement of the General Services Administration, chairmanship of the subcommittee on building construction of DPA's Conservation Division and the organization and early direction of the Construction Controls Division of NPA. He is a former managing director of the Producers' Council

**JAMES B. CLOW & SONS**

201-299 North Talman Avenue • Chicago 80, Illinois



WHOLESALEERS OF PLUMBING AND HEATING SUPPLIES  
Publishers of the Clow Bulletin



# Passenger Elevators

For architectural beauty, construction economy, low operating costs

## No penthouse or heavy sidewalls needed

There are several very good reasons why Oildraulic Passenger Elevators are the most practical and economical type to specify within their ranges of travel and speed.

## Architectural advantages

The elevator car and its load are supported by the hydraulic system—not the building structure. This makes unnecessary the costly, unsightly penthouse that interferes with modern architectural design. It also permits a substantially lighter shaftway structure. Rotary's compact electric power unit can be located in any convenient spot on any landing, or placed in an area with other mechanical equipment.

## Operational advantages

The revolutionary Rota-Flow power system guarantees quiet, efficient operation and low operating costs. Because of simple design and construction, maintenance on an Oildraulic Elevator is also remarkably inexpensive.

Through the use of hydraulically operated control system (electrically actuated) and automatic leveling, smooth starts and stops and accurate landings are guaranteed. Automatic leveling is standard equipment on all Rotary Passenger Elevators, and costs less than automatic leveling on other types of elevators.

## Coast-to-coast service

With over 75,000 Oildraulic Elevators and Lifts now in use, Rotary offers the most complete service in the oil-hydraulic elevator field. Look under "ELEVATORS" in your Classified Phone Directory or write us for the name and address of our distributor near you. They will gladly assist you on elevator plans and specifications.



## Oildraulic Passenger Elevators



Write for new Catalog RE-307

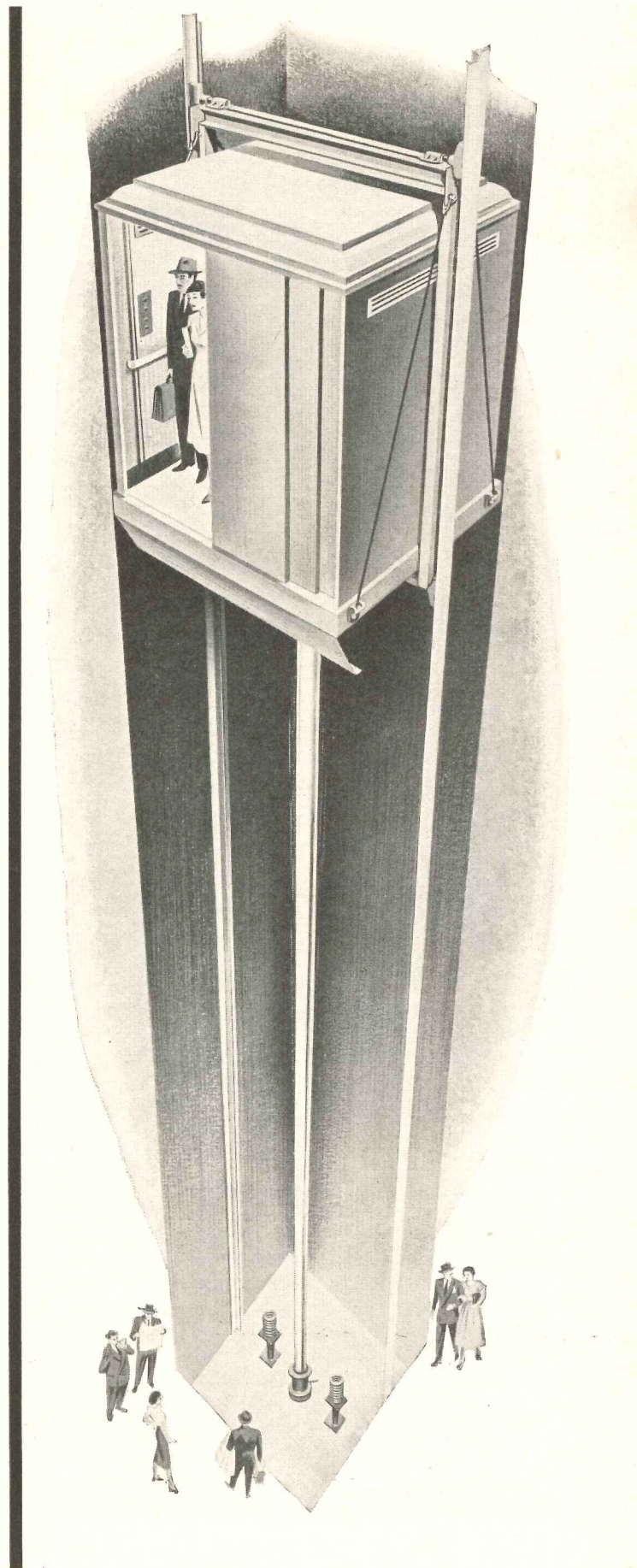
It's the most complete and helpful booklet ever issued on oil-hydraulic elevators for passenger service.

See our catalog in Sweet's Files

**ROTARY LIFT CO.**

1010 Kentucky, Memphis 2, Tenn.

*Specialists in modern oil-hydraulic elevators*





CONSTRUCTION COST INDEXES

Labor and Materials

United States average 1926-1929 = 100

Presented by Clyde Shute, manager, Statistical and Research Division, F. W. Dodge Corp., from data compiled by E. H. Boeckh & Assocs., Inc.

NEW YORK

ATLANTA

Period	Residential		Apts., Hotels Office Bldgs. Brick and Concr.	Commercial and Factory Bldgs. Brick and Concr.		Brick and Steel	Residential		Apts., Hotels Office Bldgs. Brick and Concr.	Commercial and Factory Bldgs. Brick and Concr.		Brick and Steel
	Brick	Frame		Brick	Frame		Brick	Frame				
1930	127.0	126.7	124.1	128.0	123.6		82.1	80.9	84.0	86.1	83.6	
1935	93.8	91.3	104.7	108.5	105.5		72.3	67.9	95.1	87.1	85.1	
1939	123.5	122.4	130.7	133.4	130.1		86.3	83.1	96.9	97.4	94.7	
1940	126.3	125.1	132.2	135.1	131.4		91.0	89.0	136.8	98.5	97.5	
1946	181.8	182.4	177.2	179.0	174.8		148.1	149.2	158.1	136.4	135.1	
1947	219.3	222.0	207.6	207.5	203.8		180.4	184.0	178.8	157.1	158.0	
1948	250.1	251.6	239.4	242.2	235.6		199.2	202.5	180.6	178.8	178.8	
1949	243.7	240.8	242.8	246.4	240.0		189.3	189.9	185.4	180.8	177.5	
1950	256.2	254.5	249.5	251.5	248.0		194.3	196.2	204.2	183.7	185.0	
1951	273.2	271.3	263.7	265.2	262.2		212.8	214.6	88.6	202.8	205.0	
1952	278.2	274.8	271.9	274.9	271.8		218.8	221.0	212.8	210.1	214.3	
Mar. 1953	278.9	275.4	274.9	279.0	274.2		221.7	223.3	217.9	218.4	220.0	
Apr. 1953	278.9	275.4	274.9	279.0	274.2		221.7	223.3	217.9	218.4	220.0	
May 1953	277.7	274.5	273.5	278.5	272.8		221.7	223.3	217.9	218.4	220.0	
May 1953	124.9	124.3	% increase over 1939				156.9	168.7	% increase over 1939			
			109.3	108.8	109.7				129.1	124.2	132.3	

ST. LOUIS

SAN FRANCISCO

1930	108.9	108.3	112.4	115.3	111.3	90.8	86.8	100.4	104.9	100.4
1935	95.1	90.1	104.1	108.3	105.4	89.5	84.5	96.4	103.7	99.7
1939	110.2	107.0	118.7	119.8	119.0	105.6	99.3	117.4	121.9	116.5
1940	112.6	110.1	119.3	120.3	119.4	106.4	101.2	116.3	120.1	115.5
1946	167.1	167.4	159.1	161.1	158.1	159.7	157.5	157.9	159.3	160.0
1947	202.4	203.8	183.9	184.2	184.0	193.1	191.6	183.7	186.8	186.9
1948	227.9	231.2	207.7	210.0	208.1	218.9	216.6	208.3	214.7	211.1
1949	221.4	220.7	212.8	215.7	213.6	213.0	207.1	214.0	219.8	216.1
1950	232.8	230.7	221.9	225.3	222.8	227.0	223.1	222.4	224.5	222.6
1951	252.0	248.3	238.5	240.9	239.0	245.2	240.4	239.6	243.1	243.1
1952	259.1	253.2	249.7	255.0	249.6	250.2	245.0	245.6	248.7	249.6
Mar. 1953	261.1	254.0	255.2	263.5	254.6	252.3	246.7	250.4	253.9	254.4
Apr. 1953	261.1	254.0	255.2	263.5	254.6	252.8	247.1	251.4	255.4	254.8
May 1953	262.3	254.2	258.1	268.0	258.1	252.3	246.4	251.4	255.6	254.3
May 1953	138.0	137.6	% increase over 1939			138.9	148.1	% increase over 1939		
			117.4	123.7	116.9			114.1	109.7	118.3

The index numbers shown are for combined material and labor costs. The indexes for each separate type of construction relate to the United States average for 1926-29 for that particular type — considered 100.

Cost comparisons, as percentage differences for any particular type of construction, are possible between localities, or periods of time within the same city, by dividing the difference between the two index numbers by one of them; i.e.:

index for city A = 110  
index for city B = 95  
(both indexes must be for the same type of construction).

Then: costs in A are approximately 16 per cent higher than in B.

$$\frac{110-95}{95} = 0.158$$

Conversely: costs in B are approximately 14 per cent lower than in A.

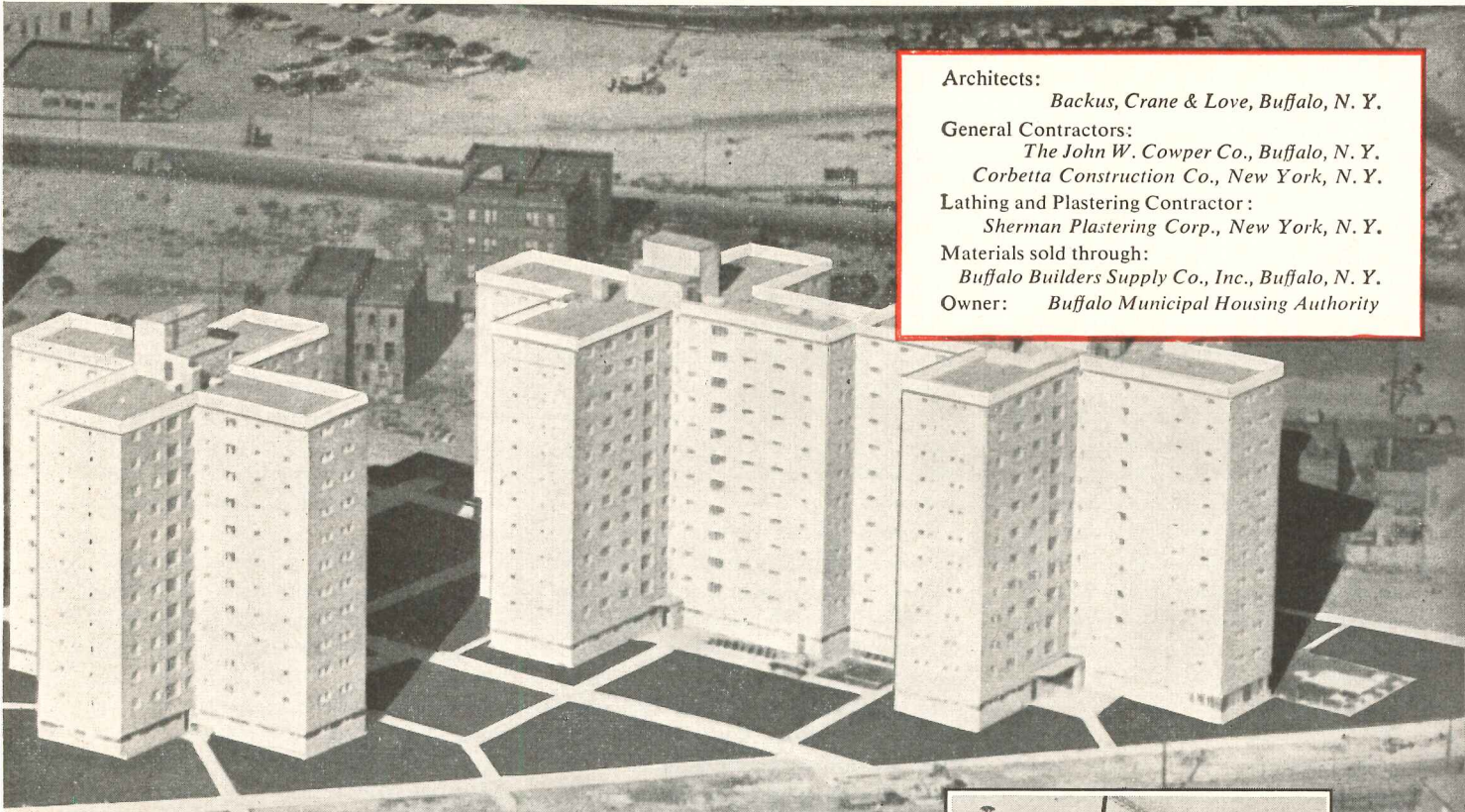
$$\frac{110-95}{110} = 0.136$$

Cost comparisons cannot be made between different types of construction because the index numbers for each type relate to a different U. S. average for 1926-29.

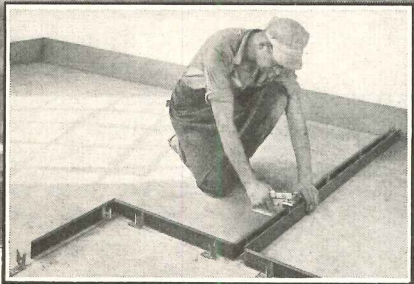
Material prices and wage rates used in the current indexes make no allowance for payments in excess of published list prices, thus indexes reflect minimum costs and not necessarily actual costs.

These index numbers will appear regularly on this page.

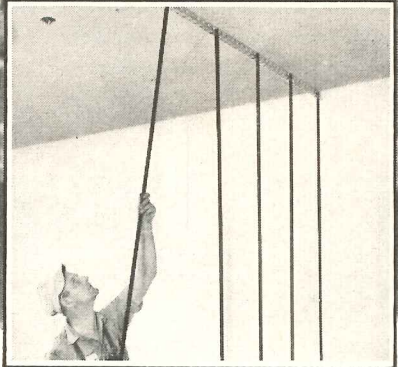




Architects: *Backus, Crane & Love, Buffalo, N. Y.*  
 General Contractors: *The John W. Cowper Co., Buffalo, N. Y.*  
*Corbetta Construction Co., New York, N. Y.*  
 Lathing and Plastering Contractor: *Sherman Plastering Corp., New York, N. Y.*  
 Materials sold through: *Buffalo Builders Supply Co., Inc., Buffalo, N. Y.*  
 Owner: *Buffalo Municipal Housing Authority*



*Wheeling Metal Base* firmly locks into position on both sides of Floor Clips. Ceiling Runner goes up easily using stub nails or rawl drives.



*Wheeling Channel Studs* are inserted in Ceiling Runner slots at same intervals as Base Clips.

# **PARTITIONS**

*The Wheeling line of building materials includes:* Steelcrete Reinforcing Mesh, Expanded Metal, Metal Lath and Metal Lath Accessories, Metal Base, Tri-Rib Steel Roof Deck, ExM Angle Frame Partitions and Steelcrete Vault Reinforcing.



*Wheeling Metal Lath* ties flat to Channels with Wheeling Hank Tie Wire. Plaster is applied on both sides to form an effective solid partition.

**WHEELING, WEST VIRGINIA**  
 NEW YORK PHILADELPHIA RICHMOND ST. LOUIS





# REQUIRED READING

## TOWN DESIGN

*Town Design.* By Frederick Gibberd. The Architectural Press (London, England). Reinhold Publishing Corporation (New York, N. Y.), 1953. 8¾ by 11 in. 300 pp., illus.

REVIEWED BY JOHN RANNELLS, A.I.A.

TOWN PLANNING is so big a field in which so many different specialists must work together that the architect hardly knows where he fits into it and how much of it he should try to comprehend. Even less is the role of the architect understood by the others concerned. By focusing on *Town Design* as the peculiar province of the architect, Frederick Gibberd clarifies the issue for specialists and public alike.

This is a full, rich study, directed especially toward the present town planning needs in England but drawing upon examples throughout Europe and America. Its lessons are as applicable to planning problems in this country as they are to those in Great Britain —

perhaps more so, for we have no such generally understood sets of concepts on which to base our planning (and redevelopment) goals as have been worked out in recent years by the British. This book owes much to the shared experiences of whole groups of architects and planners, working together with sociologists, geographers, economists and government people. The author had a prominent place in this experience as architect and planner in a number of new towns and reconstruction of urban centers.

Town design is concerned with everything we see in the urban picture and goes on after the planning job is completed — it scarcely begins, in fact, until after the planning is well along. The importance of design is continually being stressed in architectural publications but the visual relationships of the *entire* scene are rarely covered. It is one of the special virtues of the present work that architecture is put into context with the entire urban scene — as it exists, not as the architect would like it to be. In the process, some limitations of architecture

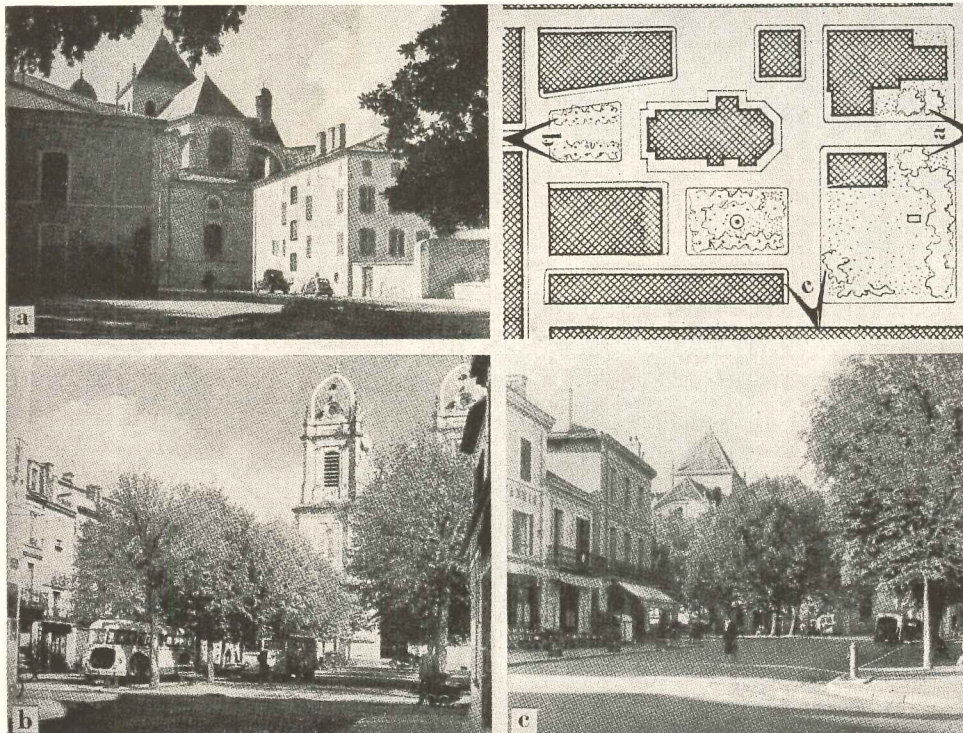
as practiced are exposed — but all to the good, for broader fields are opened for architects. According to Gibberd: "The co-relation of the raw materials of town design is usually ignored today, with the consequence that there is a wide gap . . . between town planning and the design of the individual object. The art of architecture, for instance, has tended to become withdrawn from the art of town design and has turned in on itself, the architect regarding his buildings as being an abstract composition with an existence independent of its surroundings."

This book will be most useful to architects and planners as a reference volume and text. Those without technical training who are interested in the urban scene and need to be shown what can be done will be attracted by its readability and illustrations. There are many hundreds of photographs (mostly by the author, taken all over Europe) and plans and diagrams — all illustrating the argument of the text. Visually, it is a handsome picture book but it is a picture book that has to be read.

The text (and illustrations) play back and forth between general underlying considerations and specific design; theory and practice are kept always in balance. At the end of each main part, *Design of the Complete Town*, *Central Areas*, *Industry*, *Housing*, there is an *Analysis* section in which typical examples are studied, both for their own interest and as examples of theories set forth in the previous chapters.

In Part One, consisting of two brief chapters on *The Town and its Raw Materials* and *The Master Plan*, the author sets out the functioning elements which are to be later elaborated. The economic and social basis for planning is taken for granted — referred to continually but not elaborated. The author begins where the architect enters. He begins with towns as they are and as they can be shaped for those who use them. "Most towns today have a characteristic functional pattern as follows: a central core containing the principal shopping centre, civic group and business zones; surrounded by suburbs of houses, often each with its own character and each with its own shopping centre and other social services; and areas of industry, some of which are generally associated with the town centre and some with the railway. That the pattern is confused by

(Continued on page 48)

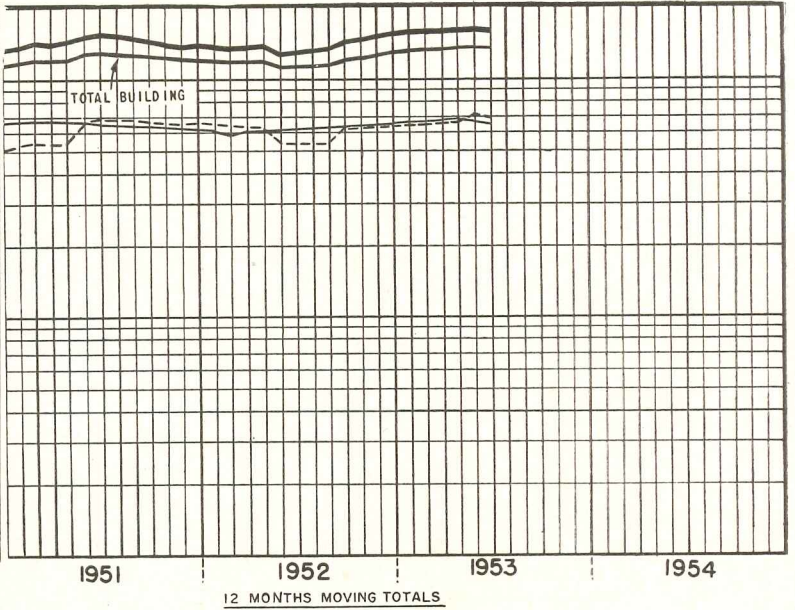
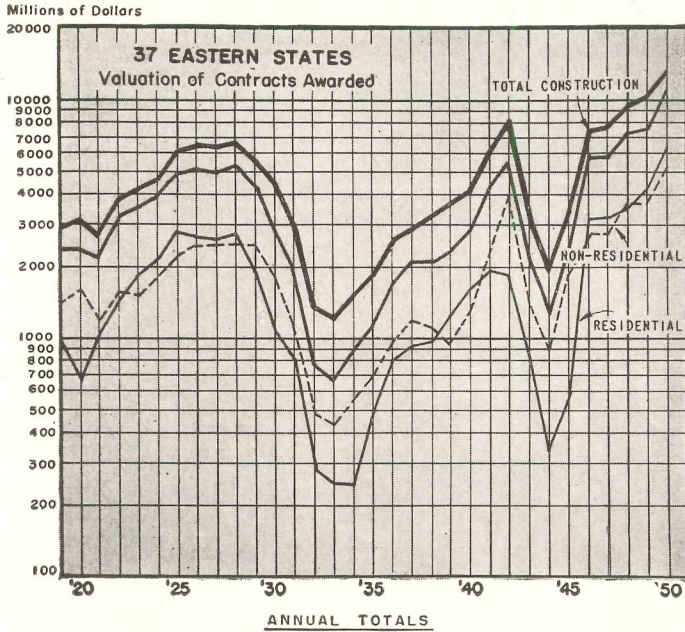


The English cathedral is often too open, and the European ones are often too enclosed, but in the central area of Dax, there is a balance between the cathedral as a three-dimensional crown and the spaces as open-air rooms. However, there is a change in function and size between the spaces, giving them marked individual characteristics — in all cases the spaces hold their own as places to be in, rather than just settings for façades. From "Town Design"



# CURRENT TRENDS IN CONSTRUCTION

Charts by Dodge Statistical Research Service



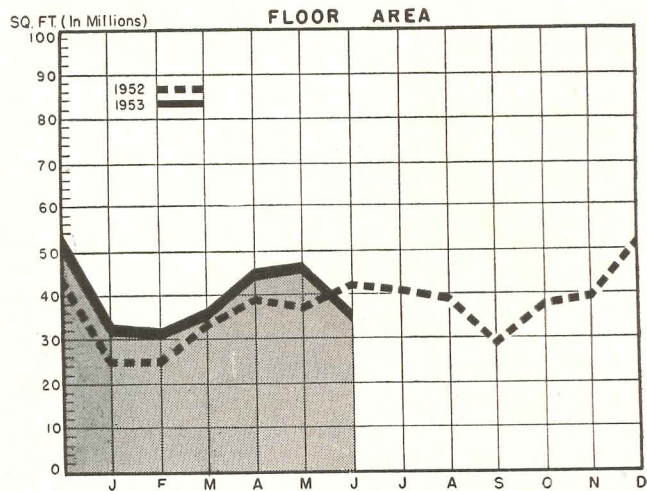
## CONSTRUCTION CONTRACTS DECLINE

An expected slow-down in U. S. construction activity was revealed by contract award figures reported by the F. W. Dodge Corporation for June.

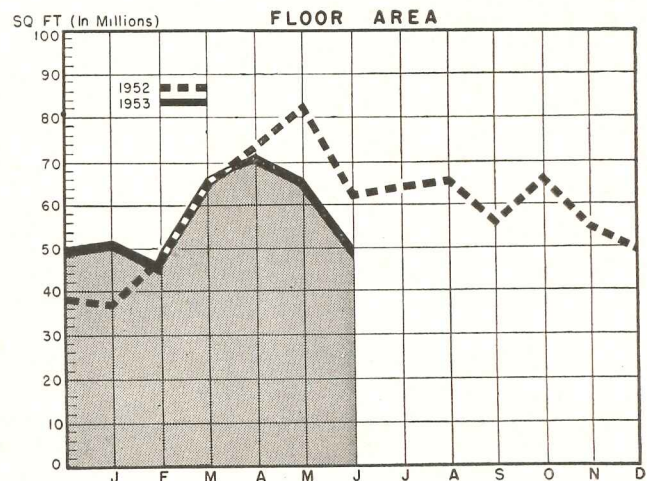
Although totals for the first six months of 1953 were still slightly above 1952, June contracts reveal declines from June 1952 as follows: nonresidential building, off 17 per cent; residential building, off 20 per cent.

The June contract declines were not extensive enough to indicate any long-term trend. However, they were large enough to show the effects of a tighter fiscal policy. Nonresidential building contracts in June (37 Eastern states) totaled \$459,230,000 compared with \$551,500,000 last year. Residential building contracts this June totaled \$463,084,000 compared with \$581,792,000 last year. For the first six months of 1953, the total of nonresidential contracts was \$2,952,031,000 — up nine per cent. Residential contracts for the same period totaled \$3,258,496,000 — down three per cent.

## NONRESIDENTIAL BUILDING (37 EASTERN STATES)



## RESIDENTIAL BUILDING (37 EASTERN STATES)



### INDUSTRIAL BUILDING 1947-1953

Contracts Awarded — Millions of Dollars (37 Eastern States)

Year	Annual Total	Monthly Average	Year	Annual Total	Monthly Average
1947	941	78	1950	1142	95
1948	840	70	1951	2883	240
1949	558	47	1952	2557	213

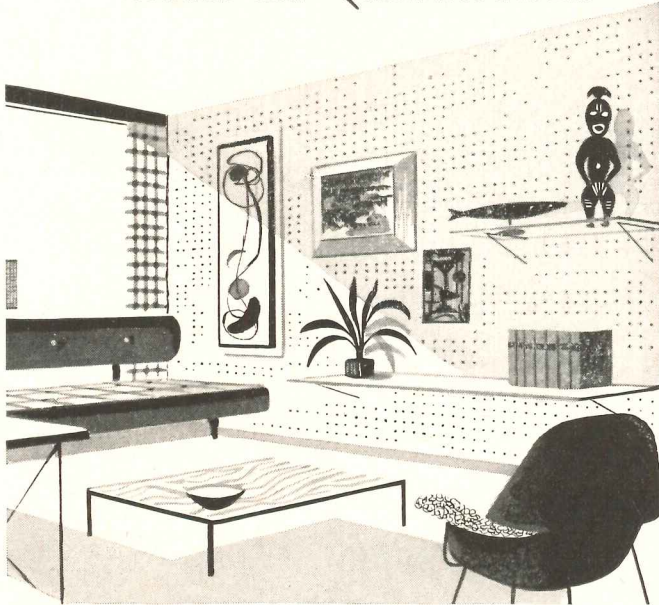
1952		1952		1953	
Month	Total	Month	Total	Month	Total
Jan.	110	July	140	Jan.	76
Feb.	61	Aug.	142	Feb.	89
Mar.	120	Sept.	995	Mar.	105
Apr.	205	Oct.	113	Apr.	262
May	79	Nov.	117	May	132
June	166	Dec.	309	June	85



Give your designs **WORKING WALLS** with



PANELS and METAL HANGERS



for complete descriptive literature write

B. B. BUTLER MFG. CO., INC., 3150 Randolph, Bellwood, Illinois

*Throughout the  
AIR CONDITIONING  
Industry—*

**AEROFIN FIN-TYPE  
HEAT-TRANSFER UNITS**  
do the job Better,  
Faster, Cheaper

**AEROFIN CORPORATION**  
410 South Geddes St., Syracuse 1, N. Y.



A.W.M.A. Quality Specifications—Materials, Construction, Strength of sections and air infiltration resistance—confirmed by Pittsburgh Testing Laboratory NUMBER—ALUMINUM WINDOW MANUFACTURERS ASSOCIATION



**ONLY ADLAKE ALUMINUM**

**WINDOWS GIVE**

**ALL THESE "PLUS"**

**FEATURES:**



- Woven-pile Weather Stripping and Exclusive Patented Serrated Guides
- Minimum Air Infiltration
- Finger-tip Control
- No Painting or Maintenance
- No Warp, Rot, Rattle, Stick or Swell

**THE  
Adams & Westlake**

**COMPANY  
ELKHART, INDIANA**

Established 1857 • New York • Chicago

**SCHLAGE**  
**REFERENCE BOOKLETS**

YOURS ON REQUEST



- Entrance lock designs and matching interior designs
- Radically new Glass Knob Sets
- Non-tarnishing, Luster Sealed aluminum locks
- Simplified Methods for Selecting Lock Types

Please send booklets checked above:

SCHLAGE LOCK COMPANY • 2201 BAYSHORE BLVD., SAN FRANCISCO, CALIFORNIA

name \_\_\_\_\_

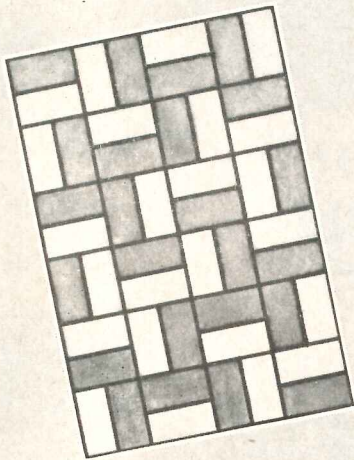
address \_\_\_\_\_

city \_\_\_\_\_ zone \_\_\_\_\_ state \_\_\_\_\_



# tiles

by **SPARTA**



Spartan Ceramics are made in a variety of ceramic mosaic colors and sizes to meet a wide field of suitable uses. Above is illustrated Design No. 130, indicative of an inviting range of color designs in low cost

## SPARTAN MOSETTES

These are unglazed ceramic tiles fired at high temperature, assuring ruggedness, impermeability, slip-resistance, and a high degree of vitrification. Available in sizes 1x1, 2x1, 2x2, 1/4" thick in a wide range of colors. Extremely versatile and easy to set in irregular shaped spaces. Write for descriptive sheets showing many standard patterns.

*Practical for Floors in*  
SCHOOLS • HOSPITALS • INSTITUTIONS  
also SWIMMING POOLS

**THE SPARTA  
CERAMIC CO.**

P.O. BOX 2, EAST SPARTA, OHIO

## THE RECORD REPORTS

(Continued from page 296)

### DOWNTOWN ATLANTA GETS 25-STORY BANK BUILDING

Construction got under way this June for the only large office building to be built in downtown Atlanta since 1930. The 25-story building, main office of the Fulton National Bank, will contain 527,000 sq ft of office space, the greatest area of any office building in the city. The architect for the building is Wyatt C. Hedrick, in association with the firm of Moscowitz, Wilner & Millkey.

The bank will feature four drive-in tellers' windows on the street level, with room enough for eight cars indoors; the remainder of the ground floor will be taken up by the bank's installment loan department, their day and night depository facilities, and by shops. The bank's main business room will occupy the second floor; moving stairways will be installed for easy access. The third floor will be used for the trust department, the fourth and fifth for various other departments. The bank will rent the sixth and seventh floors, earmarked for future expansion, on short-term leases. The other floors are intended for office rental.

Situated in the center of the city's business district, the new building will help to relieve Atlanta's traffic problems by providing three levels of underground parking.



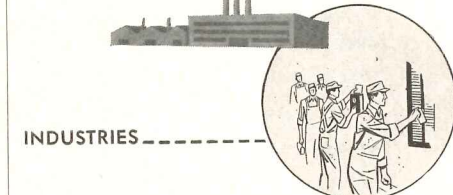
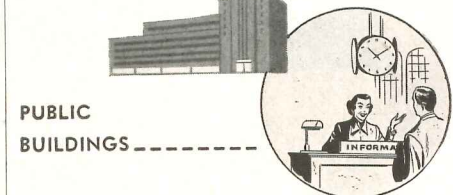
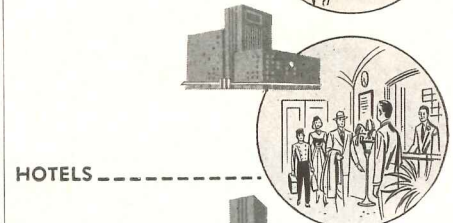
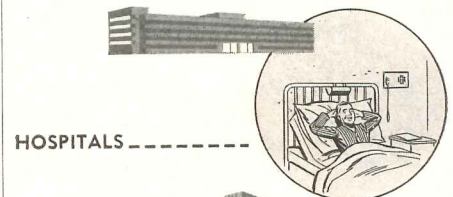
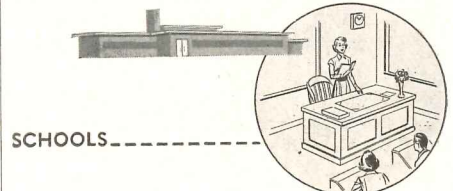
The building, of steel and concrete construction, will be the tallest building in the city. The electric display signs will be visible for many miles around

(More news on page 304)

One source  
for all Time and  
Signal equipment

**STROMBERG**

clock systems • program signals  
tower clocks • time recorders  
fire alarm equipment  
audio-visual: paging systems  
nurse call  
doctors registers



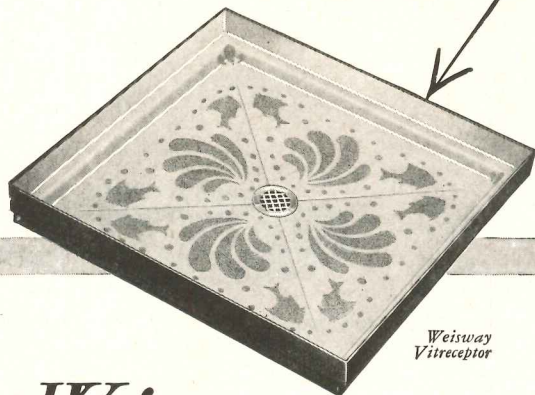
**STROMBERG**  
TIME CORPORATION



subsidiary of general time corp.  
109 LAFAYETTE ST., N. Y. 13, N. Y.



*for Permanently Leakproof  
Shower Baths*



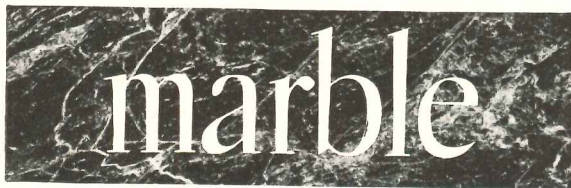
Weisway  
Vitreceptor

## Weisway VITRECEPTOR

The perfect receptor with integral flashing for showers having walls other than metal. Formed in one piece of enameling iron with vitreous porcelain inside and out. Textured Foot-Grip, No-Slip floor—safe, sanitary, non-absorbent. No metal underpans required. Write for detailed information on Vitreceptor and catalog of Weisway Cabinet Showers.


**HENRY WEIS MANUFACTURING CO., INC.**  
803 Weisway Bldg., Elkhart, Indiana

*There is no  
substitute for*

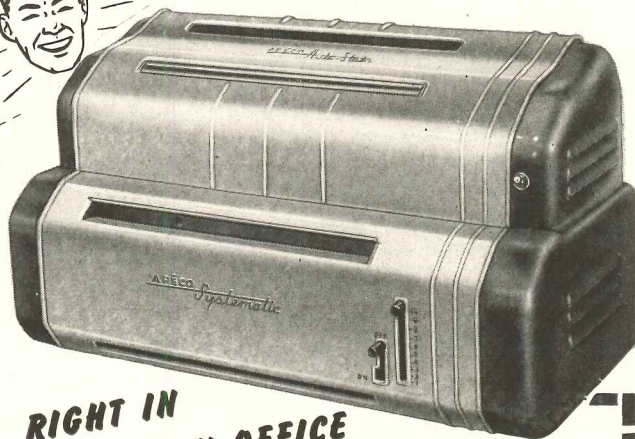


The Marble Institute of America protects your heritage in one of America's great industries. Each of its members is pledged to provide the finest of materials, finished in America, by Americans, no matter what its source. You can depend on the integrity of your local M.I.A. member.

Literature is available to assist you in your contact with clients. For this, or technical data, or for a complete list of M.I.A. members, write the Managing Director:

**MARBLE**  **INSTITUTE OF AMERICA, INC.**  
108 FORSTER AVENUE, MOUNT VERNON, N Y

**"NOW YOU CAN MAKE  
DRY PHOTOCOPIES  
IN ANY COLOR"**



**RIGHT IN  
YOUR OWN OFFICE  
INSTANTLY!**

ALL ELECTRIC

**APĒCO** *Auto-Stat*  
SYSTEMATIC

**Makes photo-exact copies of anything  
typed, written, printed, drawn or photo-  
graphed in any color or black and white.**

Now make photocopies in color! The amazing Apeco Systematic Auto-Stat makes a dry photocopy in red, blue, green, yellow or any other color—including black and white—in less than 45 seconds. Now—"color-code" orders, invoices, letters, etc.—speed up order filling and office procedure—save filing time! This lightning-fast copying machine prints from any original up to 11" wide, any length, whether printed on one or two sides opaque or translucent paper . . . all automatically. Finished copies are ready for instant use. Save up to 80% on copying cost by eliminating costly re-typing, hand copying, checking and outside copying service. Offers even greater savings in increased business efficiency.

**SO LOW COST!** A complete Apeco Systematic Auto-Stat installation is priced well within the budget of even the smallest firm.

**"COLOR-CODE"  
YOUR  
PHOTOCOPIES!**



Increase office efficiency with copies in any color for immediate recognition, faster filing, speedier handling.

**PRE-PRINTED  
COPIES FOR  
SYSTEMS USE**



Methods experts acclaim new pre-printed Auto-Stat copy system offering simplified office record procedure tailor-made to your particular needs.

**HAVE YOU READ THIS FREE BOOK?**

**American Photocopy Equipment Co.** Dept. AR-83  
2849 N. Clark St., Chicago 14, Ill.

Please rush me, without obligation, your factual book on "29 ways to save time and money" and the Apeco Auto-Stat story. I understand this free booklet pictures and tells how I can use Apeco Auto-Stat in my office

Name \_\_\_\_\_  
Firm \_\_\_\_\_  
Address \_\_\_\_\_  
City \_\_\_\_\_ Zone \_\_\_\_\_ State \_\_\_\_\_

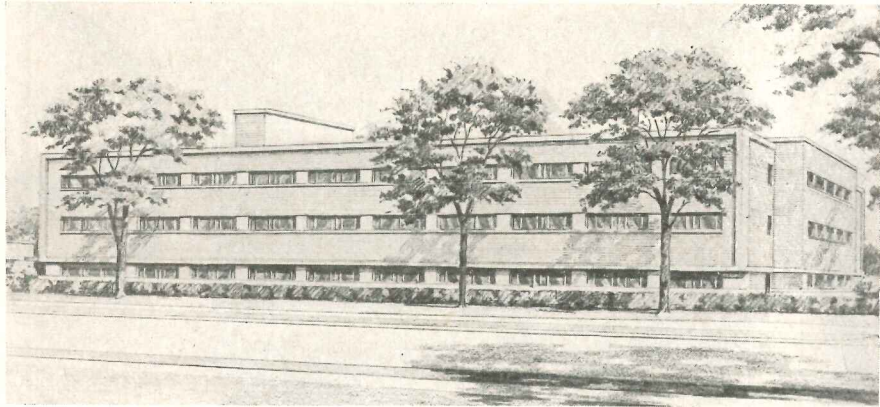




(Continued from page 282)

FIFTH PUBLIC SCHOOL IS BUILT FOR PARK FOREST

Mohawk Elementary Public School, fifth public school to be built in Park Forest, the planned community 20 miles from Chicago's Loop, is scheduled to be opened next fall.



The fifth public school for Park Forest, the planned community near Chicago, is the Mohawk Elementary School, scheduled to be completed next fall. Cost: \$400,000

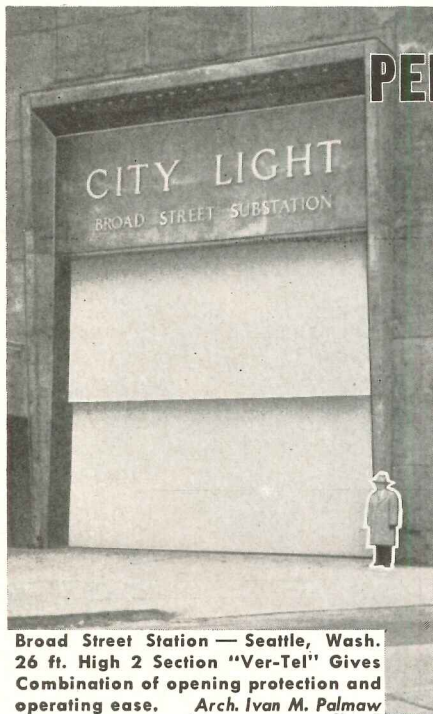
SIZE Is Not the Measure of a DOOR

but PERFORMANCE IS

Security DOORS

LARGE or SMALL are nationally measured by...

1. stronger construction for ...
2. longer life with ...
3. less maintenance cost plus
4. easy, quiet operation!



Broad Street Station — Seattle, Wash. 26 ft. High 2 Section "Ver-Tel" Gives Combination of opening protection and operating ease. Arch. Ivan M. Palmaw

Thousands of outstanding elevator installations have increased satisfaction and improved efficiency due to Security's "Proven Performance" Power Operated and Manual Freight Elevator Doors. Have our representative show you. . . .

Security Superior Proven Heavy Duty Industrial Doors are made specifically to meet building requirements, operational problems and individual desires. ALL Security doors are noted for their ability to withstand hard usage, ease of operation and trouble free service.

Consult phone book yellow pages or write

... There is a difference! **SECURITY FIRE DOOR COMPANY**  
3043 LAMBDIN • ST. LOUIS 15, MO.

The school, to cost about \$400,000 in land, buildings and equipment, will be a one-story structure of brick and stone with 16 classrooms — 14 for grades one through six and two for kindergarten.

Classrooms are designed as self-contained units, each with its own lavatory, drinking fountain, toilet, wardrobe spaces, book shelves and storage closets. In addition, each will have its individual exit into its own play area.

Plans call for several rooms for administrative purposes; a teachers' study which can double as a speech correction room during the day and be available for Parent-Teacher Association and other meetings after school hours; and a small room for bookstacks adjoining a classroom which could be converted to library use.

Broad windows extend the entire length of the building, for maximum daylighting, and the overhanging roof has been designed to permit the windows to remain free of blinds or shades throughout the greater part of the year. Fluorescent lighting will be used throughout.

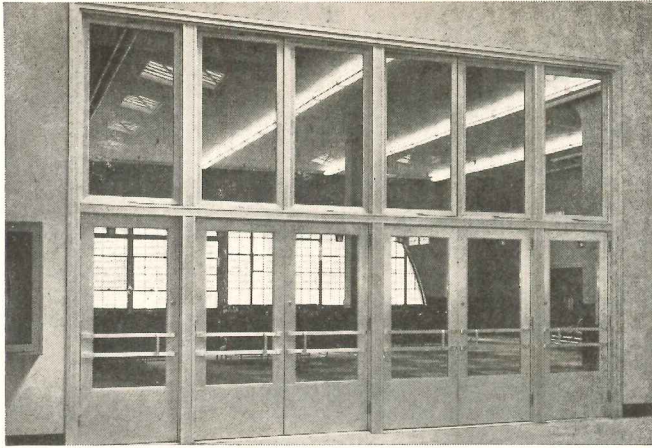
Land Given by Developers

The school is being built on land donated by American Community Builders Inc., developers of Park Forest. It is being financed through a not-for-profit building foundation, and it is expected that School District 163 will purchase the school from the foundation when it has gained sufficient bonding power. The school will accommodate about 540 pupils.

Loebl, Schlossman and Bennett, planners of Park Forest, are the architects.

(More news on page 294)





Pier 86, North River, N. Y. C. Home Pier of U.S.S. United States  
Architects: New York City Dept. of Marine & Aviation

## ALUMILINE

### EXTRUDED ALUMILATED ALUMINUM PRODUCTS

Specified by Leading Architects for:

HOSPITALS • SCHOOLS • RELIGIOUS BUILDINGS • BANKS  
STORE FRONTS • OFFICE BUILDINGS • INDUSTRIAL PLANTS  
HOUSING PROJECTS • SHOPPING CENTERS

- Extruded Aluminum Store Front Construction
- Extruded Aluminum Factory Assembled Entrance Frames
- Narrow and Wide Stile Extruded Aluminum Doors
- Custom Built Extruded Aluminum Windows

Send for these Catalogs: "Alumiline" Store Front  
Construction and "Extrud-A-Line" Entrances

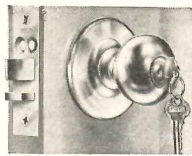
### THE ALUMILINE CORPORATION

DUNNELL LANE

PAWTUCKET, R. I.



## You'll always Satisfy when you Specify SARGENT Products



### SARGENT INTEGRALOCKS

give lifetime beauty and lifetime protection. Brass, bronze or aluminum finish. Have the famous SENTRY BOLT, plus locking set stops.



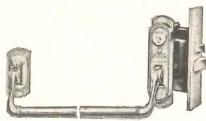
### SARGENT LIQUID DOOR CLOSERS

are already installed on hundreds of thousands of doors. Many well-proven advantages.



### SARGENT EXIT BOLTS

permit emergency exit under all conditions. Collapsible latchbolt prevents jamming.



For complete data, specifications, please write to Dept. 31H.

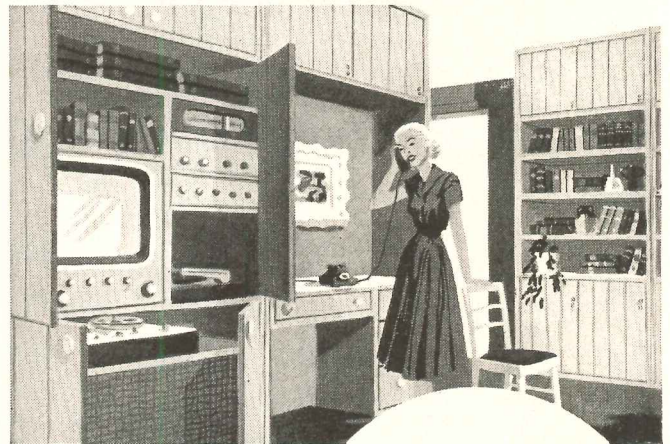


### SARGENT AND COMPANY

New York • NEW HAVEN, CONN. • Chicago  
Builders Hardware and Fine Tools since 1864

## Wood-Textured Homasote PANELS

Individually molded from actual boards—reproducing grain and texture of natural wood. Here is beautiful decorative insulation—plus great structural strength—for use indoors or out. Suitable for many types of stain or paint. In 16", 32" and 48" widths—and in 8' lengths. Send coupon for suggestive, illustrated material.



## Nova PRECISION-BUILT Wall Units

To be used individually or in whatever combination fits a given room. Included are wardrobes, storage wall units, desks, vanities, bath storage cabinets, music units, bookshelves, dressers, linen cabinets and tray chests. Precision-built of the finest plywood and lumber; shipped KD for quick assembly. Let us send you illustrations and specifications.

## HOMASOTE COMPANY

## NOVA Co. SALES

Trenton 3, N. J.



HOMASOTE COMPANY, Trenton 3, N. J., Dept. 97C

Send detailed, illustrated literature on

Wood-textured Homasote  Nova Wall Units  All Homasote-Nova Products

NAME \_\_\_\_\_

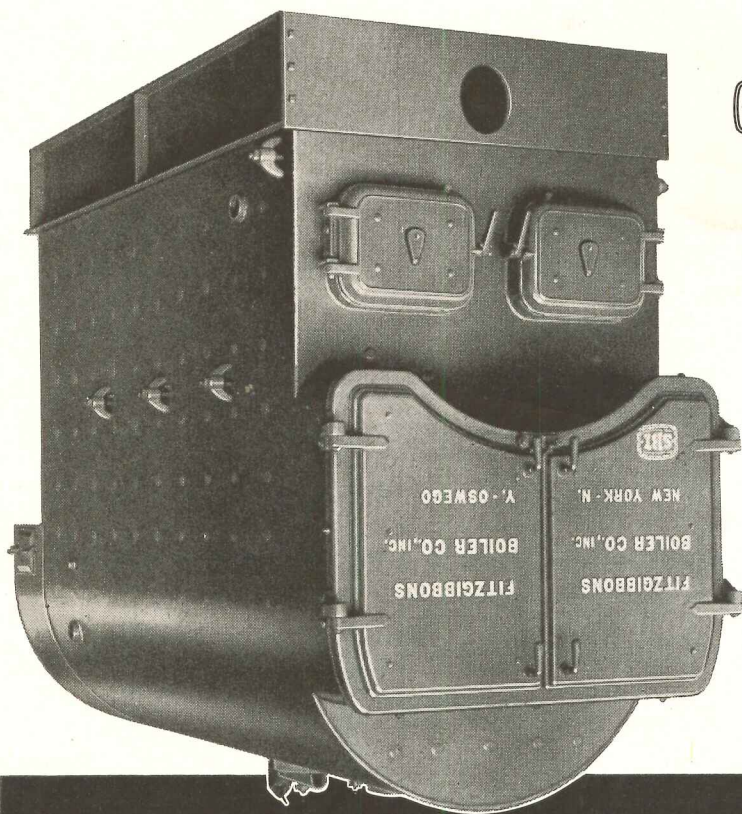
ADDRESS \_\_\_\_\_

CITY & ZONE \_\_\_\_\_ STATE \_\_\_\_\_

My lumber dealer is \_\_\_\_\_



# THE FITZGIBBONS BOILER®



The "D" Type Catalog gives all facts and data. On request from the Fitzgibbons Boiler Company, Inc., N. Y., Dept. AR-8, 101 Park Avenue, New York 17.



now serving thousands of large buildings everywhere, have long passed the need for fuel economy. Apartment owners, office building operators, management staffs of schools, churches, institutional buildings and large department stores of national fame—all acclaim it. The Fitzgibbons "D" Type boiler meets or exceeds ASME Code requirements in all details of construction, as certified by a resident Hartford inspector and is S.B.I. rated. Sixteen sizes from 3,650 to 42,500 sq. ft., steam.

## FITZGIBBONS "D" TYPE STEEL BOILERS



*Best boiler buy for big buildings everywhere!*



SCHOOL SHOP PLANNING: 4

This series of school shop plans, begun in the July 1953 Time-Saver Standards section, is presented as a guide to current thinking on layouts and equipment in the field of shop planning for vocational schools. The seven plans which will be included are award winners of an international contest held during the last American Vocational Association Convention and sponsored by the Delta Power Tool Division of the Rockwell Manufacturing Co. The contest, using the theme "School Shops for Today and Tomorrow," was divided into six divisions, according to age level and type of instruction.

A six-man jury of educators and school building planning consultants judged the plans from the following

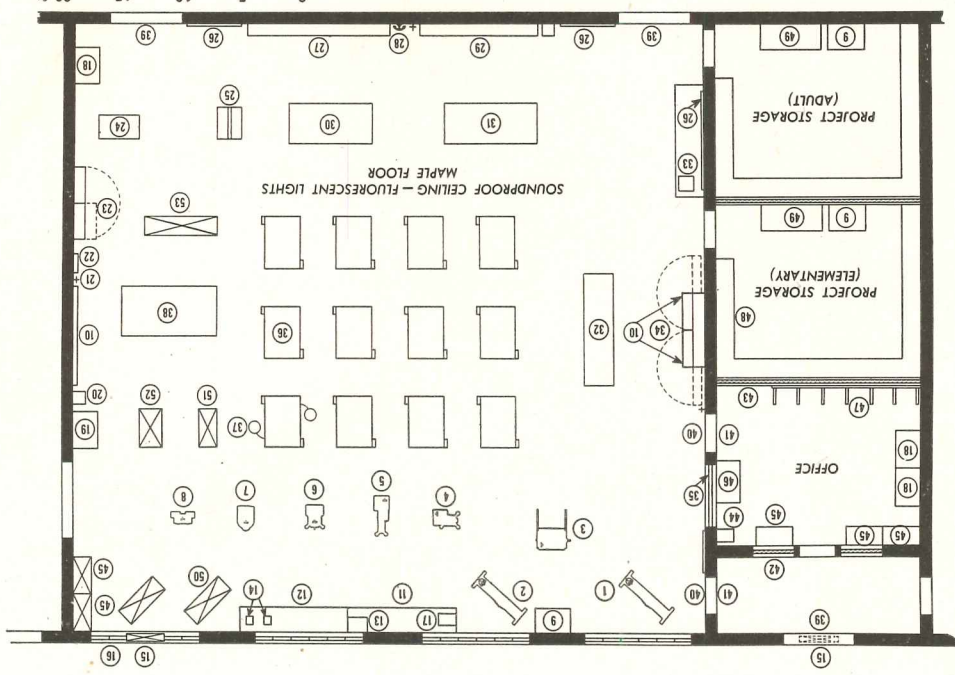
points of view: relation to vocational and industrial education; curricular integration; industrial arts application; administration of shop and accommodation to the administrative scheme of the school; and practicality from the standpoint of school construction.

Significant items noted by the jury in the majority of contest submissions were: a trend away from heavy industrial equipment to lighter power tools, with size and weight in accordance with teaching levels, and emphasis placed on more working area for students.

The plan shown on this sheet is the award winner for the general elementary school shop division, grades 5-8, and provides for 24 pupils. Subjects would include: wood,

printing, metal, mechanical drawing, plastics and home mechanics. (The equipment numbered 50-53 in the legend is for expansion, and is not included in the basic scheme.) The plan was designed by Armand G. Rehm, Director of Practical Arts, Board of Education, Newark, N. J.

The following are excerpts from the jury's comments on the plan: The plan (is) a very desirable departure from the usual elementary school shop, because it also serves as a community or neighborhood center. There are definite provisions, both in . . . equipment and storage rooms for the younger students in daily attendance and for adults in night school classes. These tools also permit an instructor to size lumber for young students.

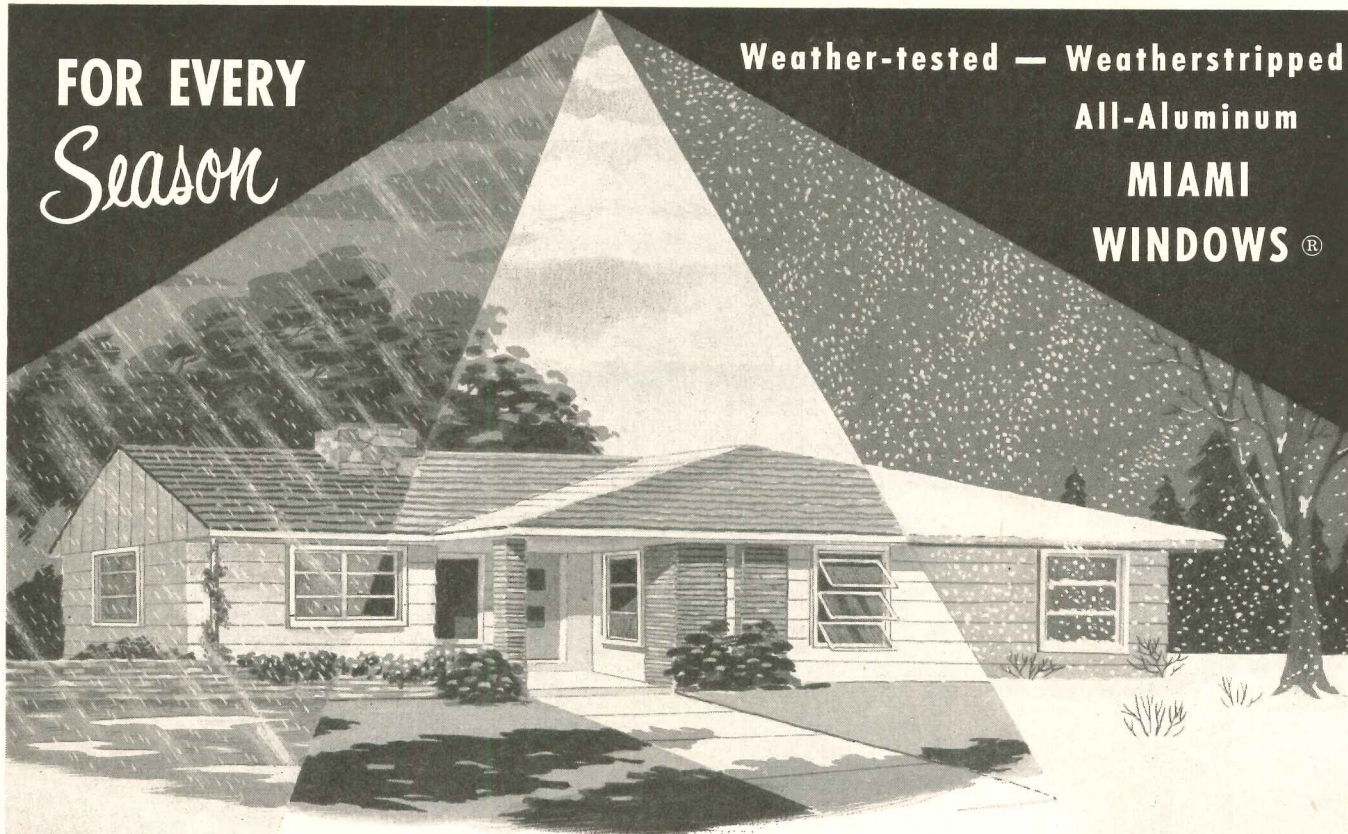


- LEGEND
1. Four Speed Lathe
  2. Sixteen Speed Lathe
  3. 10" Circular Saw
  4. Band Saw
  5. Scroll Saw
  6. Disc Sander
  7. 1 1/2" Drill Press
  8. Tool Grinder—1725 R.P.M.
  9. Steel Cabinet 24" x 35" x 42"
  10. Green Glass Blackboard
  11. 9 ft Maple Top Bench
  12. 9 ft Metal Top Bench
  13. Oven for Plastics
  14. Combination Furnaces
  15. Vent Fan (30")
  16. 9 ft Window
  17. Buffer
  18. Steel Cabinet 24" x 36" x 72"
  19. Foreman's Desk—Steel
  20. Drinking Fountain
  21. Master Machine Control
  22. Switch Box
  23. Metal Tools Cabinet 6 ft x 6 ft
  24. Pilot Hand-lever Press with Cabinet
  25. Type Cabinet
  26. Bulletin Board
  27. Reference and Project Display Shelves
  28. Telephone
  29. 10 ft Wash Trough
  30. Reference Table—Six Chairs
  31. Home Mechanics Bench
  32. 9 ft Assembly Bench
  33. Mitre Box Saw
  34. Wood Tools Cabinet 6 ft x 12 ft. Note—Green Glass Blackboard
  35. Plate Glass Window
  36. 2-Student Work Bench
  37. Steel Stools 26" high
  38. Stake Bench
  39. 6 ft Double Doors
  40. 3 ft Single Door
  41. Wire Grill Panel Over Doors
  42. Wire Grill Panel
  43. 3 ft Wire Grill
  44. Three-Drawer Filing Cabinet
  45. Steel Cabinet 19" x 36" x 72"
  46. Teacher's Desk and Chair
  47. Open-Side Metal Lumber Rack
  48. Four 18" Shelves, 24" apart
  49. Finishing Bench (with light)
  50. Metal Lathe, with Floor Cabinet, net, 9"—6 speed
  51. 7" Shaper, with Floor Cabinet
  52. Milling Machine, Floor Cabinet
  53. Sheet Metal "Shop-On-A-Bench"



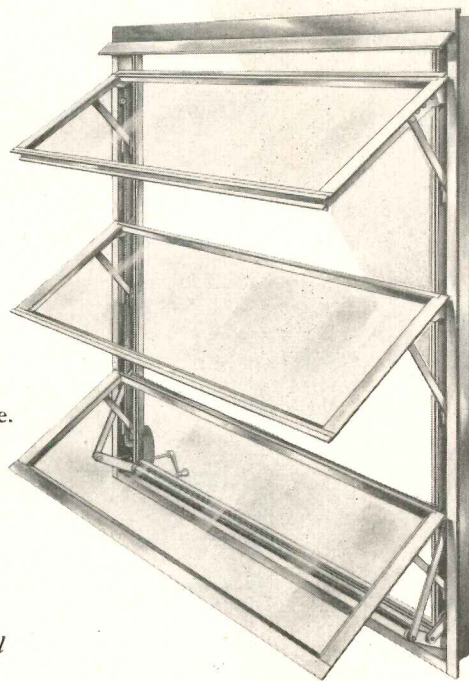
FOR EVERY  
Season

Weather-tested — Weatherstripped  
All-Aluminum  
MIAMI  
WINDOWS®



*All-aluminum Miami Windows close and lock, forming a positive weather tight seal. Tough plastic weatherstripping is carefully installed along the inner perimeter of the frame, eliminating practically all water and air infiltration\*. Operating vent arm is elongated to make closing double-tight, even in windows 7 or 8 lites high... That's why hundreds of architects the nation over, recommend with confidence, all-aluminum Miami Windows for fine buildings, everywhere.*

\*Air infiltration report on request.



**MIAMI WINDOW FEATURES:**

- Heavy Extruded Aluminum Construction
- Tinted Shatterproof Fiber-Glass Vents—Optional
- Acid Dipped and Lacquered at No Extra Cost
- Low Unit Cost

Patents Pending on New Series "54" Window



Write Dept. AR-8 for new installation details and literature—today!

MIAMI WINDOW CORP.—DEPT. AR-8  
Executive Office — 5200 N.W. 37th Ave., Miami, Fla.  
Please send me literature on the new Series "54" window.

I am a: (Check one)  
 Architect  Builder  Dealer  Other   
 Name.....  
 Address.....  
 City..... State.....

**MIAMI WINDOW CORPORATION**

5200 N. W. 37th AVENUE, MIAMI, FLORIDA

MIAMI WINDOW CORPORATION OF MISSISSIPPI—Key Field, Meridian, Miss.

MIAMI WINDOW CORPORATION OF PANAMA, Box 923, Panama, R. P.

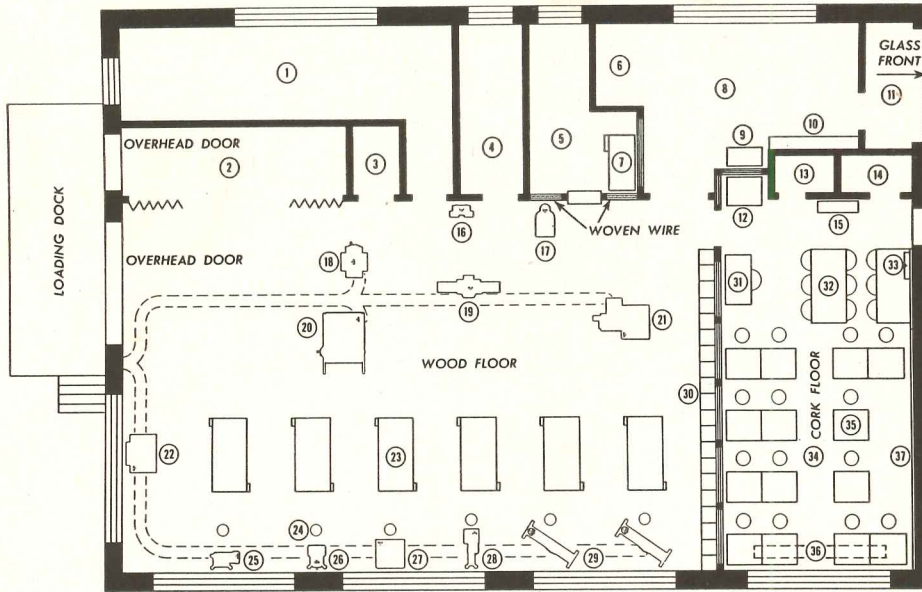


SCHOOL SHOP PLANNING: 5

For a woodwork shop at the senior high school level, grades 10-12, the layout gives the instructor clear visibility of every section of the shop, and allots safe working areas and traffic paths in a manner to minimize disturbance created by the movement of students within the shop

while teaching is in progress. The shop has three main areas: wood shop, planning room and finishing room. The lumber room is located so it can be loaded from the outside, yet have easy access from the interior. A chip and sawdust exhaust system is located under the shop

floor, and a spotlight is specified over each machine. The planning room is equipped with a movie projector and sound system. The designer and award winner for this plan is Joseph A. Williams, Industrial Arts Instructor, Lovejoy H. S., Ill.

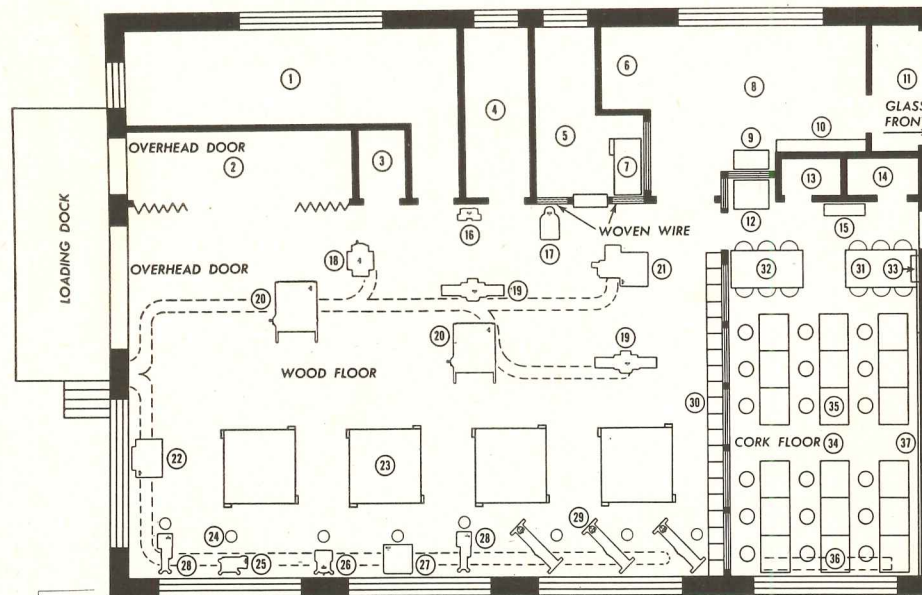


Senior High School Woodwork Shop

Basic Scheme—  
12 Pupils

LEGEND

- |                             |                            |                    |                                  |
|-----------------------------|----------------------------|--------------------|----------------------------------|
| 1. Project Storage Room     | 11. Exhibit Case           | 21. 36" Band Saw   | 31. Teacher's Desk               |
| 2. Lumber Storage           | 12. Blueprint Washing      | 22. Radial Arm Saw | 32. Reading Table                |
| 3. Turning Short and Scraps | 13. Projection Booth       | 23. Work Bench     | 33. Shelves                      |
| 4. Storeroom                | 14. Drafting Room Supplies | 24. Spotlight      | 34. Planning Room                |
| 5. Tool Room                | 15. Blueprint Machine      | 25. 6" Belt Sander | 35. Drafting Tables              |
| 6. Spraying Booth           | 16. Grinder                | 26. Disc Sander    | 36. Projection Screen in Ceiling |
| 7. Work Bench               | 17. Drill Press            | 27. Shaper         | 37. Blackboard & Corkboard       |
| 8. Finishing Room           | 18. Planer                 | 28. 24" Scroll Saw |                                  |
| 9. Sink                     | 19. Jointer                | 29. Lathe          |                                  |
| 10. Drying Shelf            | 20. 12" Tilting Arbor Saw  | 30. Lockers        |                                  |



Expanded Scheme—  
16 Pupils

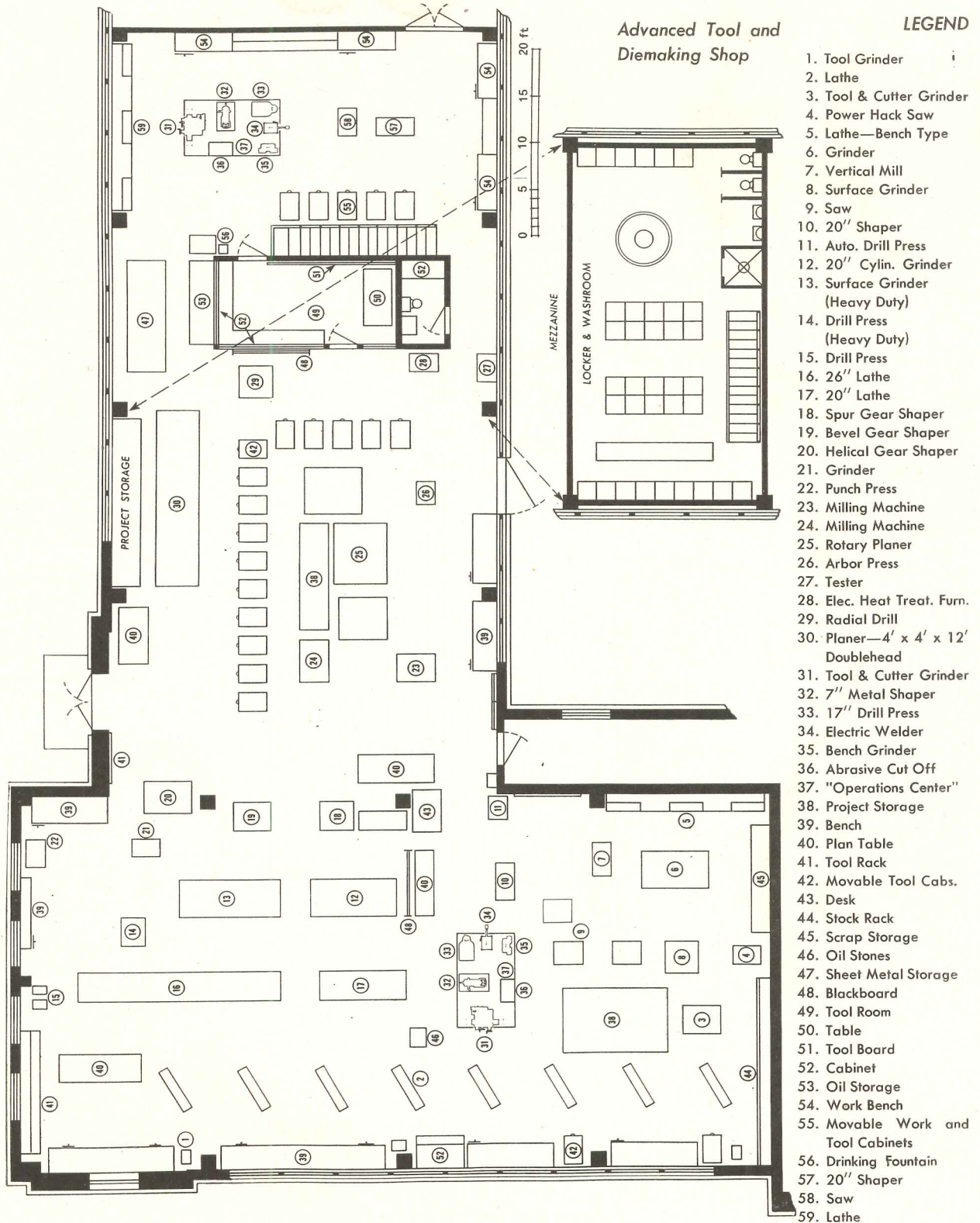


SCHOOL SHOP PLANNING: 6

Special attention in this advanced tool and diemaking shop for a technical institute has been given to the sequence of operations and shop traffic, and to use of newer types of equipment. The shop provides for the teaching of tool and diemaking,

machine tool process and sheet metal work. There is space for 40 pupils, grades 13 and 14; without the last bay (top of plan as shown) the plan would serve for 30 pupils. Much of the equipment is movable: individual work tables, tool lockers, tool boards

and blackboards. An "operations center" is placed so that work from any station can be quickly moved to it. The designer was G. Edwin Shofner, Drawing & Design Dept. Head, Wm. R. Moore School of Technology, Memphis, Tenn.





# NEW TRANE BASEBOARD CONVECTOR

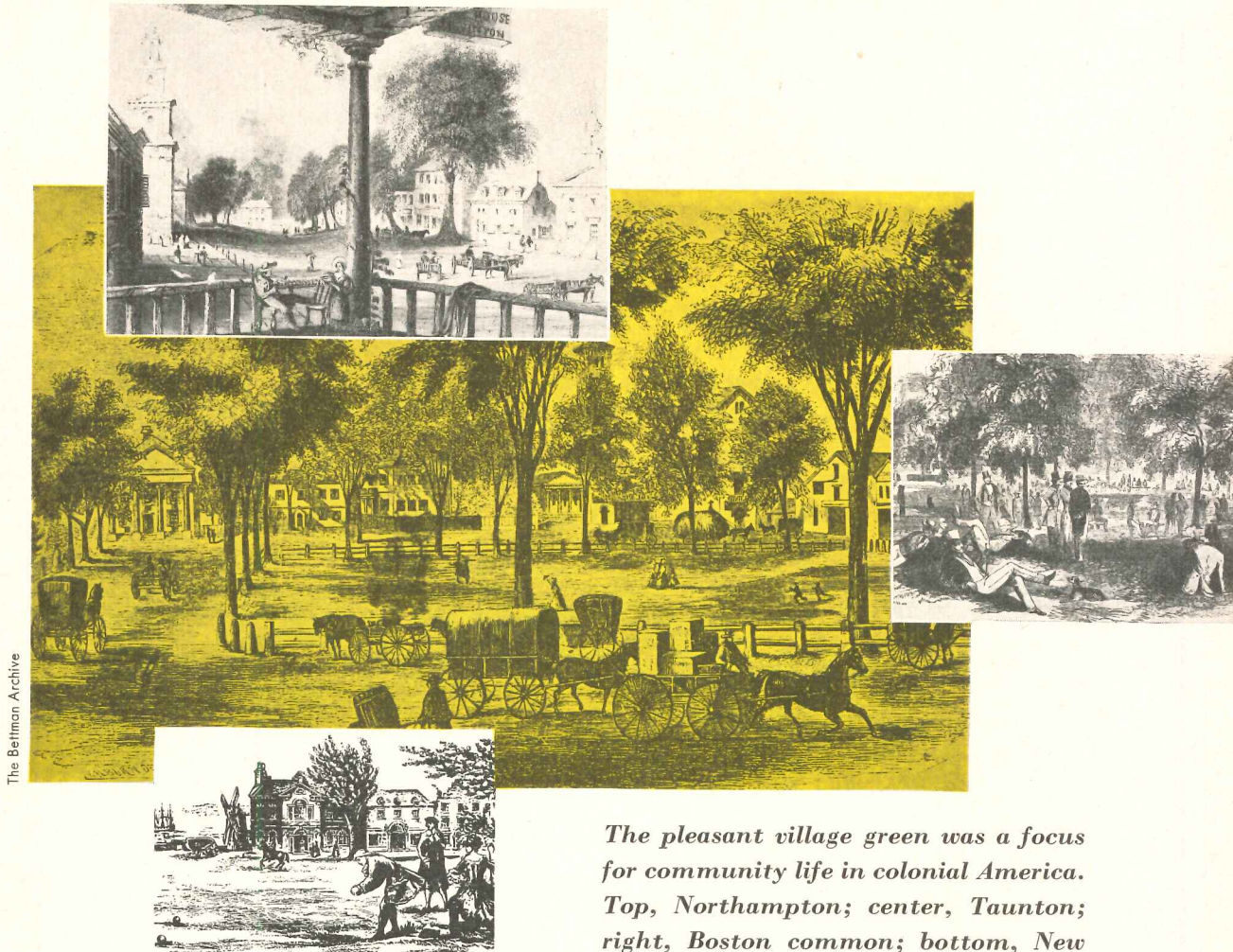
## looks better...



New comfort and new beauty with the new

The Trane Company, La Crosse, Wis. • East. Mfg. Div., Scranton, Penn.





The Bettman Archive

*The pleasant village green was a focus for community life in colonial America. Top, Northampton; center, Taunton; right, Boston common; bottom, New York's Bowling Green*

## FIVE CIVIC CENTERS IN SOUTH AMERICA

*Recent work by Paul Lester Wiener  
and José Luis Sert*

FOR CENTURIES people have gathered in the Agora, the Piazza, the market place, the village green. They come to see others and be seen, to stroll or sit, to make new friends, to discuss sports or politics, to celebrate special occasions. This urge to get together has existed in every town, large or small, through history.

In designing these civic centers, Wiener and Sert have regarded as basic the satisfying of this desire to gather and participate; and have also followed as guiding principles that pedestrians should take precedence over traffic and commerce; that scale should be in terms of walking distance; that attractive and controlled development should supplant the haphazard, purely commercial, and often unsightly visage of "Main Street."

During the ten years past, Wiener and Sert have planned eight South American cities. Telling that whole story would require many more than the sixteen pages on civic centers which follow. In this brief coverage, then, the centers should not be regarded as divorced from their surroundings, but rather as a part of an overall community and regional concept. In some cases the ideal condition, the virgin site, was the planners' compass; in others the difficulties involved in gradually remaking an existing city were part of the problem.

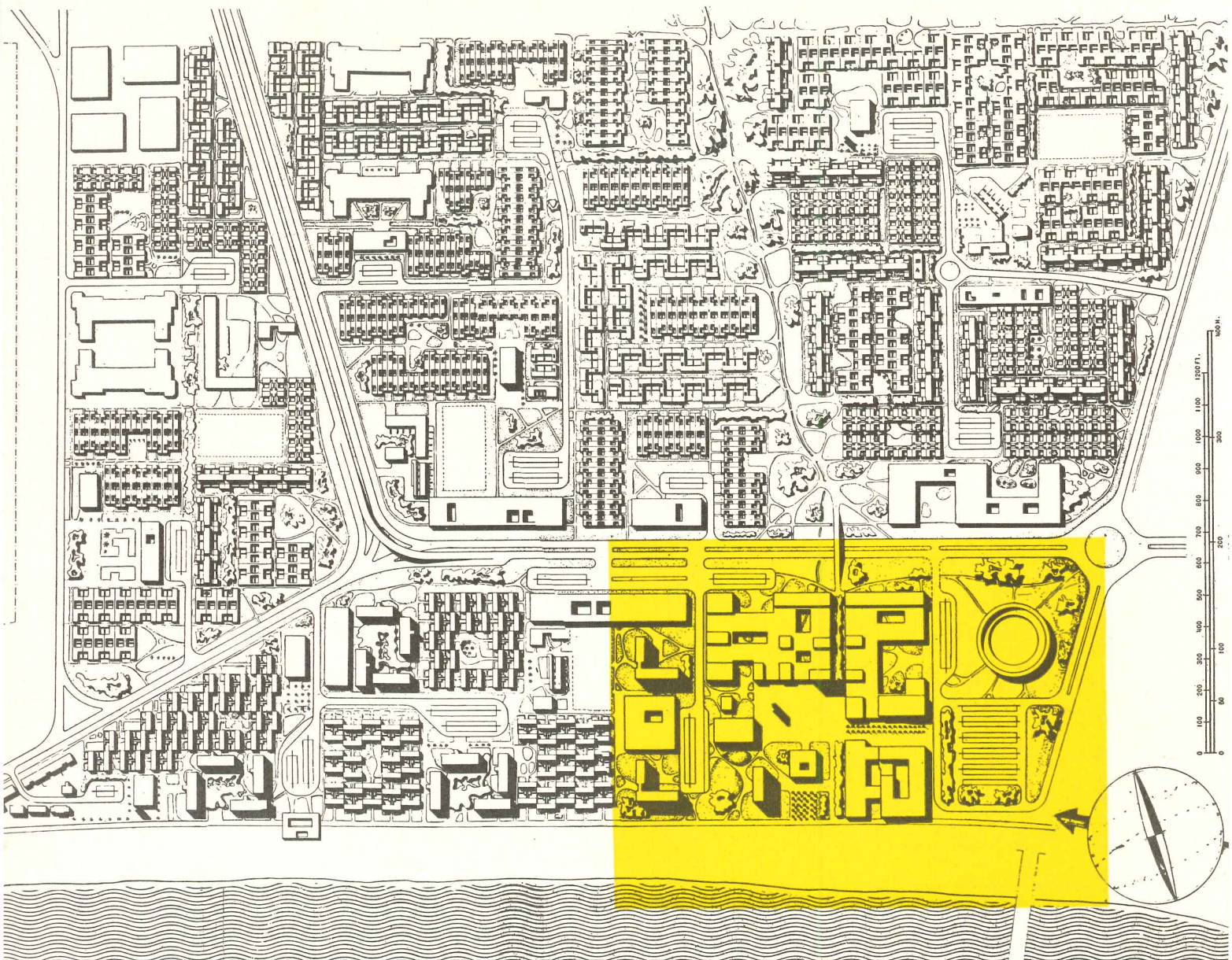
These plans will interest architects since they illustrate the growing concern with our total environment and because the design principles involve a group of buildings — a common architectural problem.



# CHIMBOTE

Peru

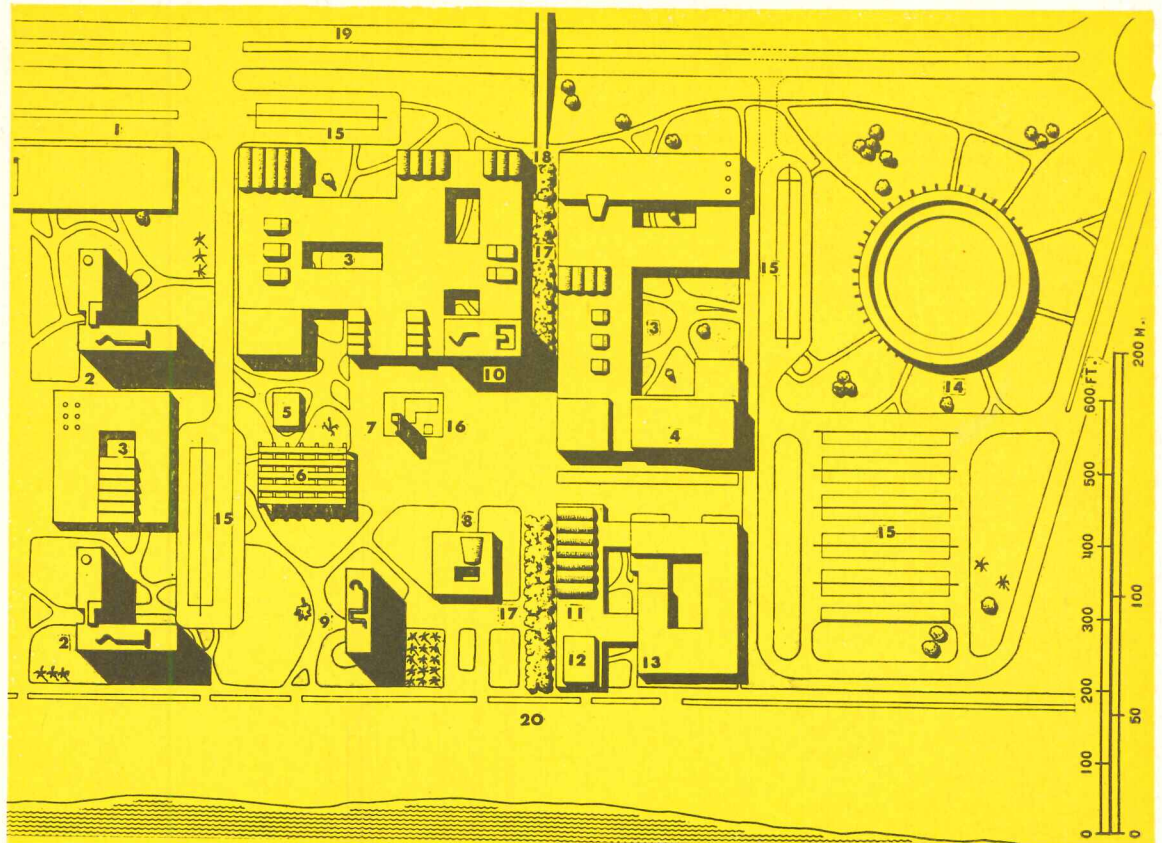
*Paul Lester Wiener and José Luis Sert,  
City Planners and Architects, in collaboration  
with the Oficina de Planeamiento y Urbanismo,  
Luis Dorich, director*





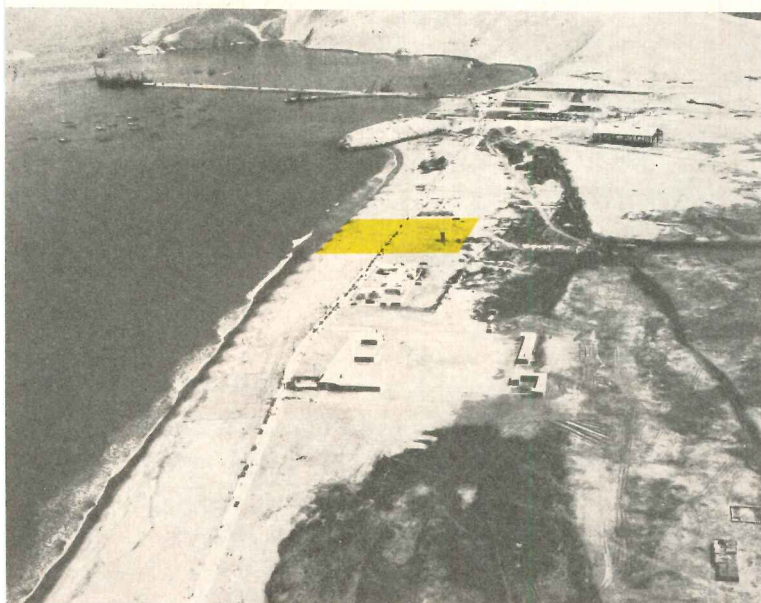
Located in a practically rainless region of the Peruvian coast, Chimbote at present is an industrial seaport of 12,000, but has been chosen as the outlet for the hydroelectric development of the Santa river (Peru's TVA), which means the future population may reach 40,000. The natural bay and modern port installations will make it an important Pacific harbor. In addition, nearby coal will be mined and industry should flourish on the cheap power. The normally arid soil will be irrigated in order to feed the people.

The plan for the new civic center, below, ingeniously separates pedestrians and vehicles; provides peripheral parking; features a plaza, promenade and beach for its citizens. The scheme is a modern expression of the old colonial "Plaza de Armas."



### THE CIVIC CENTER

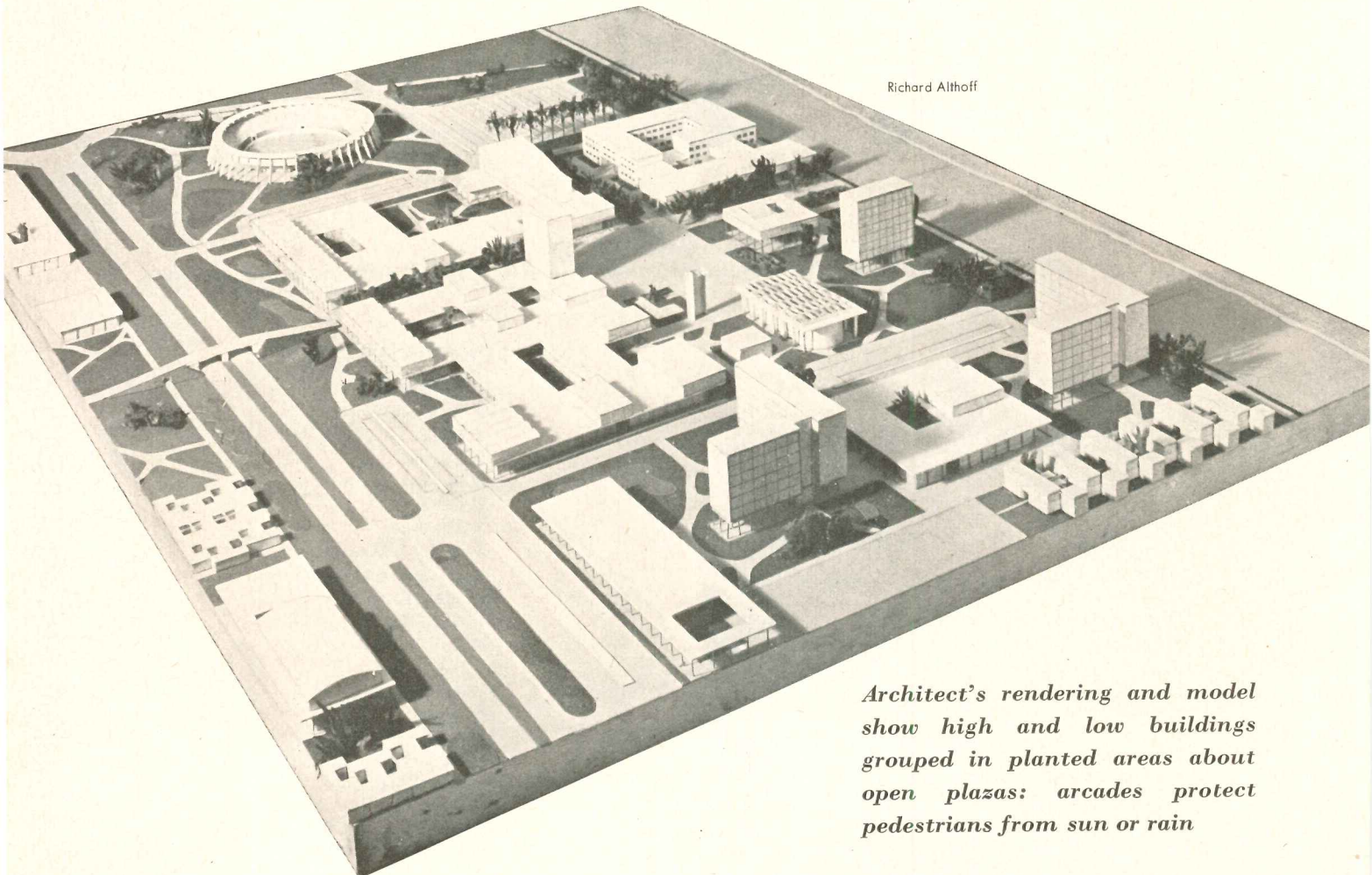
- 1 Bus Station
- 2 7 Story Apartment
- 3 Shops
- 4 Cinema
- 5 Rectory
- 6 Church
- 7 Bell Tower
- 8 Library & Museum
- 9 Municipal Building
- 10 Office Building
- 11 Travel Service
- 12 Cafe
- 13 Hotel Chimu
- 14 Bull Ring
- 15 Parking
- 16 Plaza
- 17 Promenade
- 18 Pedestrian Bridge
- 19 Pardo Avenue
- 20 Beach





Peru

CHIMBOTE



Richard Althoff

*Architect's rendering and model show high and low buildings grouped in planted areas about open plazas: arcades protect pedestrians from sun or rain*



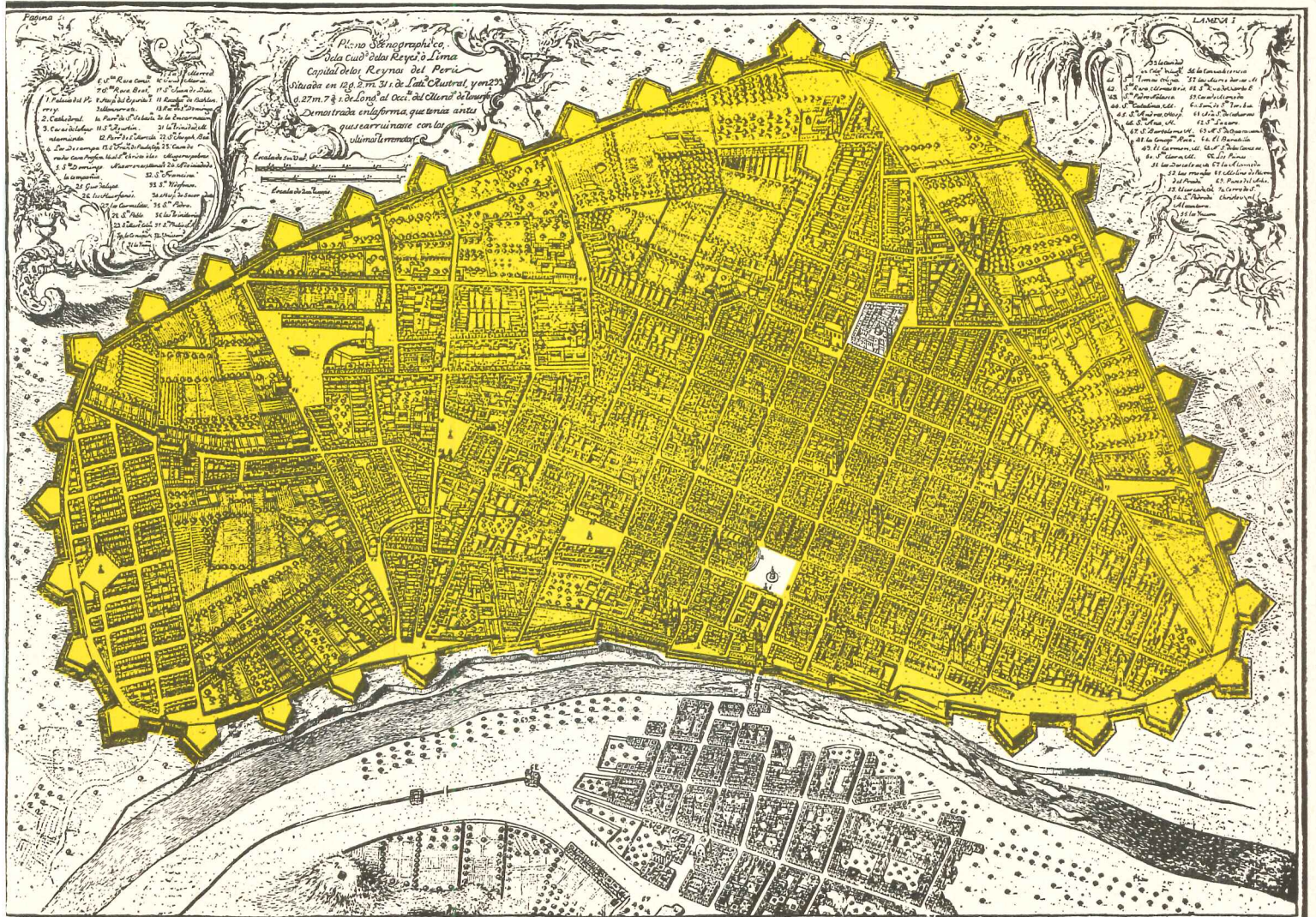
# LIMA

Peru

Paul Lester Wiener and José Luis Serf,  
City Planners and Architects, in collabora-  
tion with the Oficina Nacional de  
Planeamiento y Urbanismo

Originally a fortress city built in 1535 (see old map below), Lima has long been a commercial center, and is, of course, Peru's capital. Its nearby port, Callao, is one of the most important in South America, and the old city has expanded in the direction of the Pacific. The ancient fortress walls of colonial times were removed in the late 19th century and replaced by wide avenues. The present population is 900,000 — the master plan foresees growth to 1,800,000.

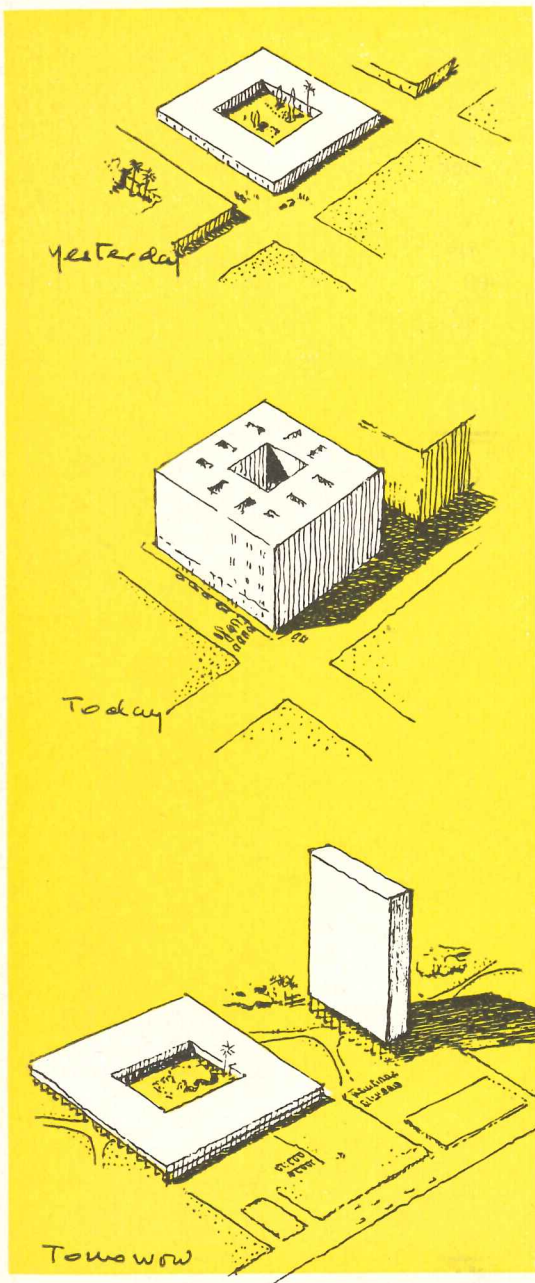
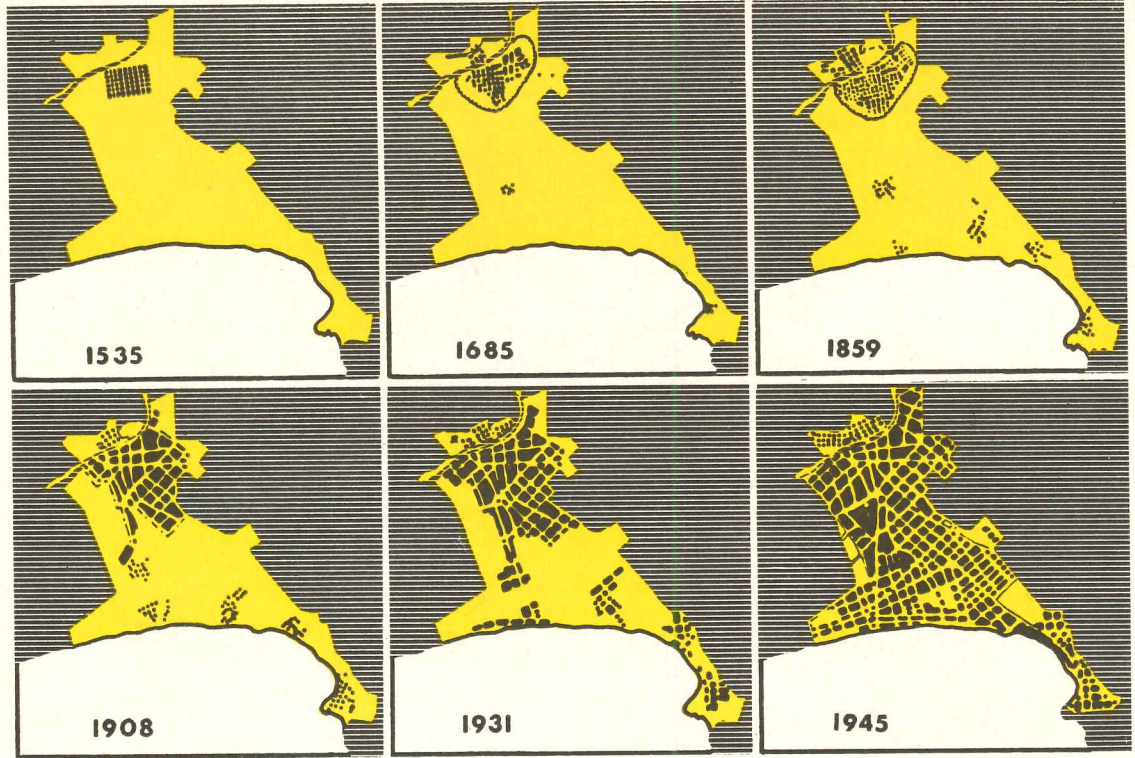
The new civic center will be built on a 173-acre site in an area of parks, old buildings, and of relatively low land values, but at a point where the principal avenues converge.





Peru

LIMA



Diagrams above show the growth of the city toward the sea. At left, the architects' conception for basic forms and arrangements for city blocks:

Yesterday — the old colonial quadra

Today — the old quadra perverted

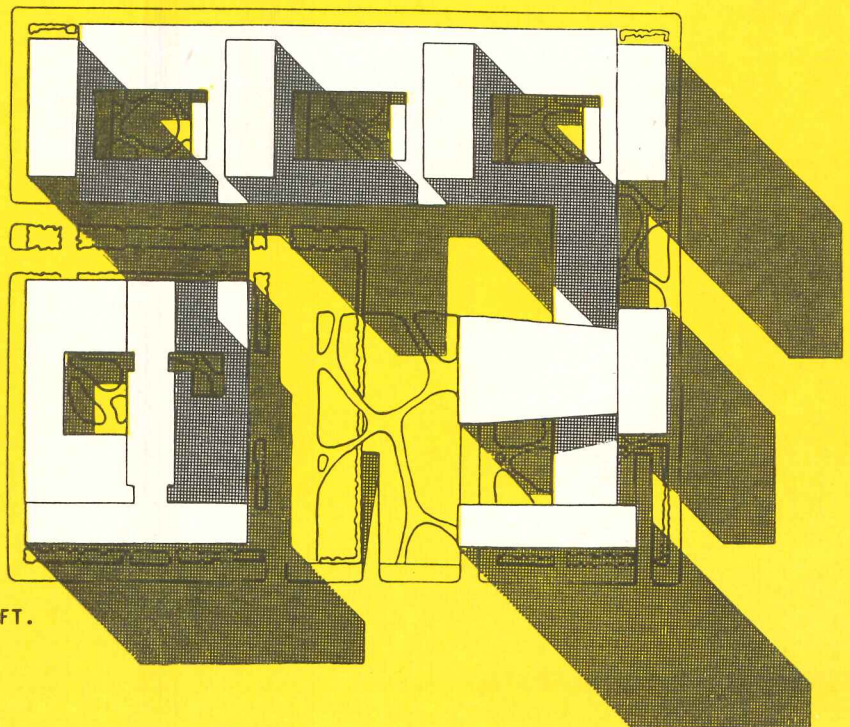
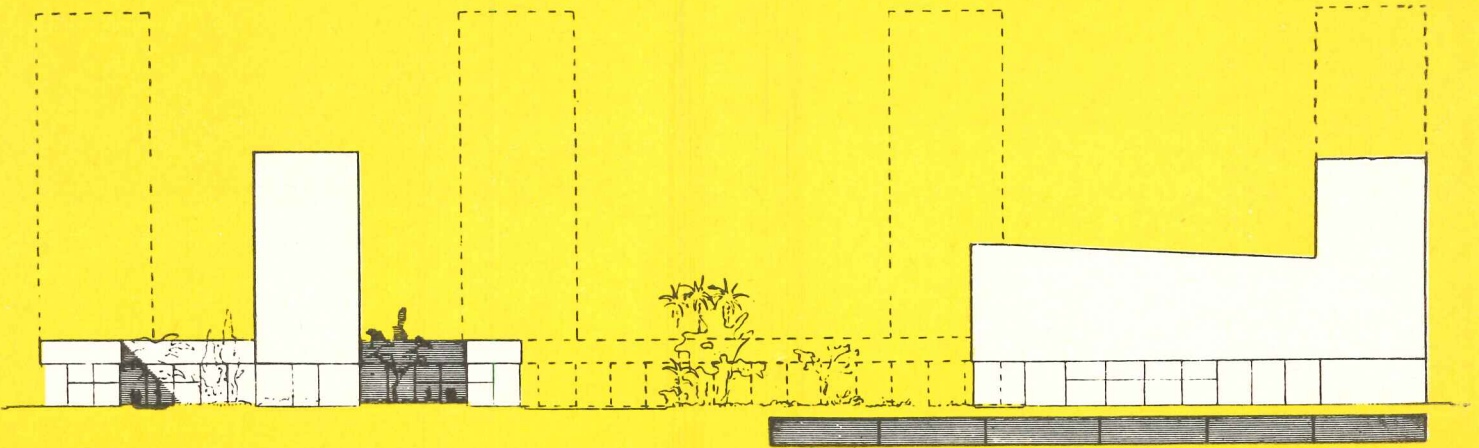
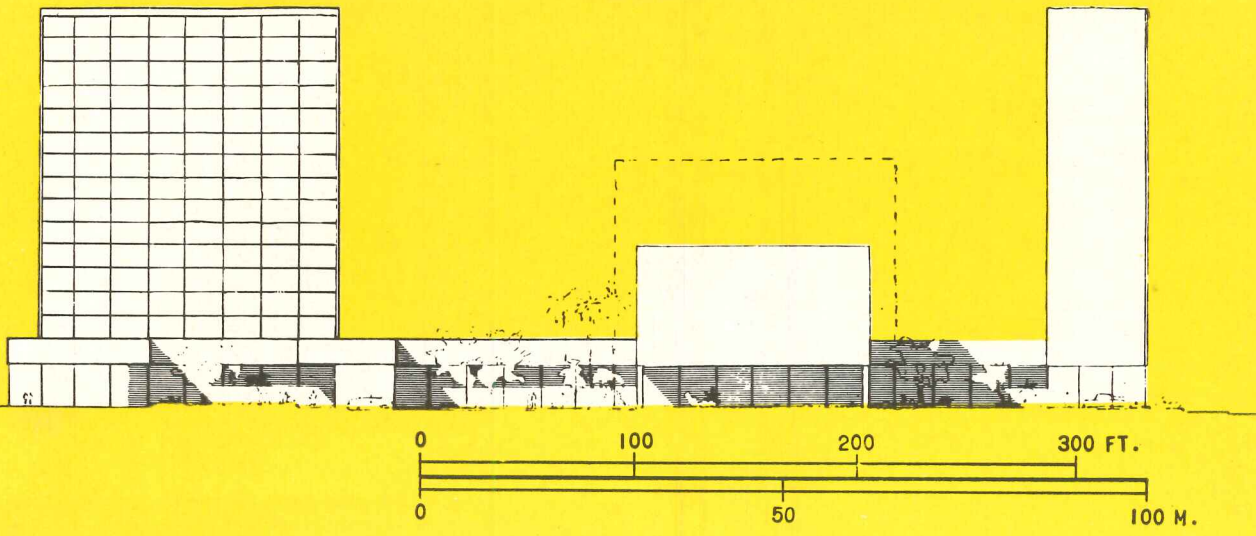
Tomorrow — the new pattern

Photo below is a view of central Lima. At right are two sections and a plan of the first phase of new civic center construction, on the old prison site

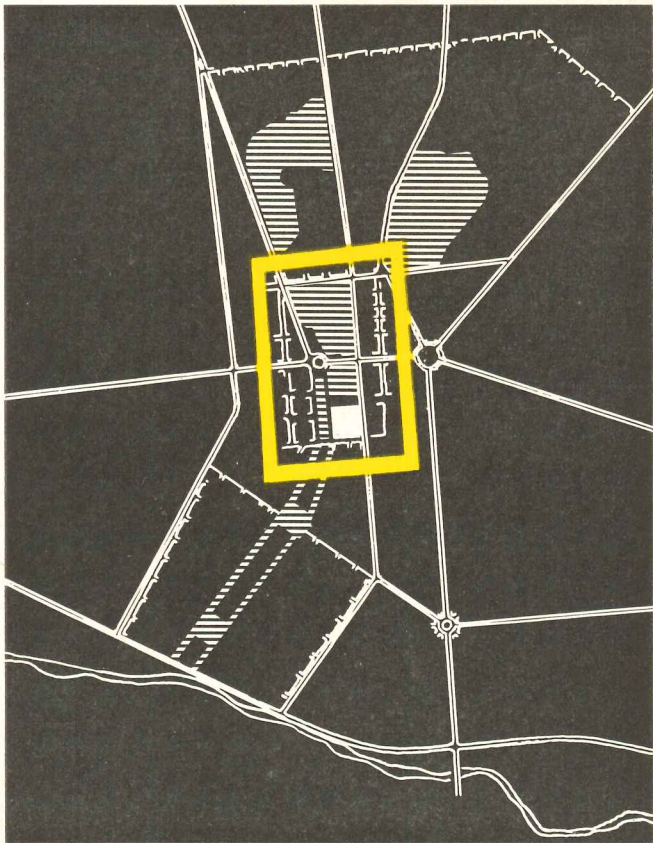


Photo by courtesy of Panagra









**LIMA**

Peru

*Serving as a center for the activities of 100,000 persons, the new civic center is a three dimensional contrast in mass between 3-story buildings and 15- or 18-story towers. Concrete slabs on posts will protect pedestrians from sun or rain and arcades will connect shop façades. Small white area on map at left is the old prison site*

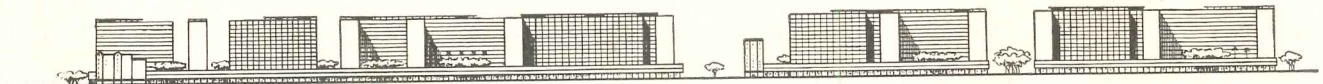
**THE NEW CIVIC CENTER**

Existing Buildings: A Courthouse | B Ministry of Public Works  
 C Italian Museum | D Other Buildings

Proposed Buildings: Ministries. 1 Interior, Justice | 2 Army, Navy, Air  
 3 Education | 4 Agriculture | 5 Foreign Affairs | 6 Hotel



**Elevation on Paseo de la Republica**



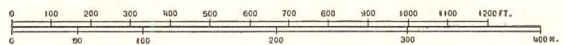
**Elevation on Avenue Wilson**



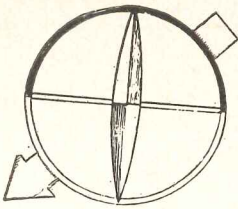
**South Elevation on Avenue Grau**



**North Elevation on Avenue Grau**



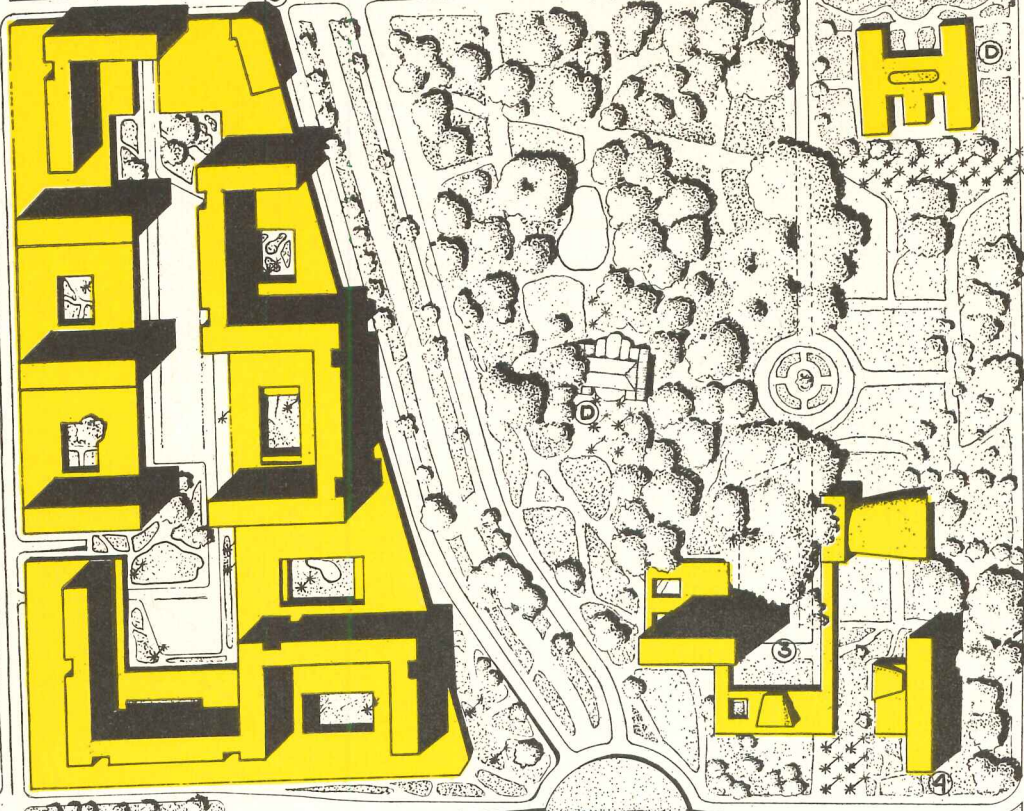




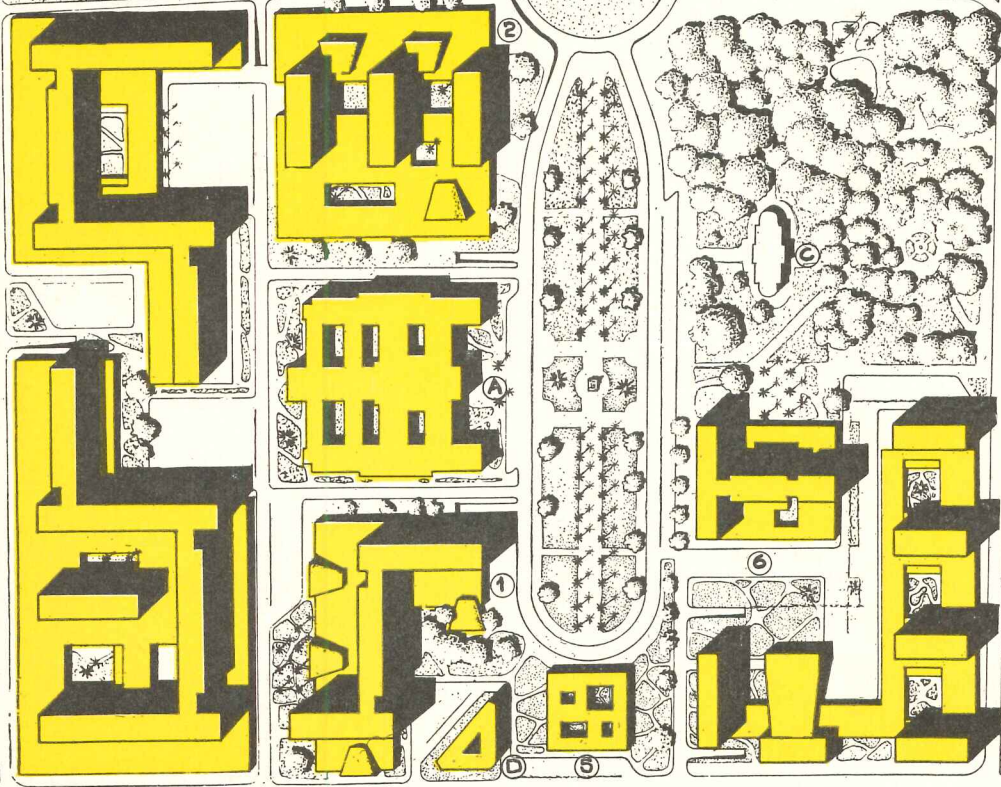
PASEO DE LA REPUBLICA

AV. 28 DE JULIO

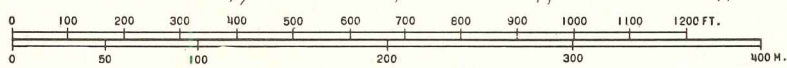
AV. AREQUIPA



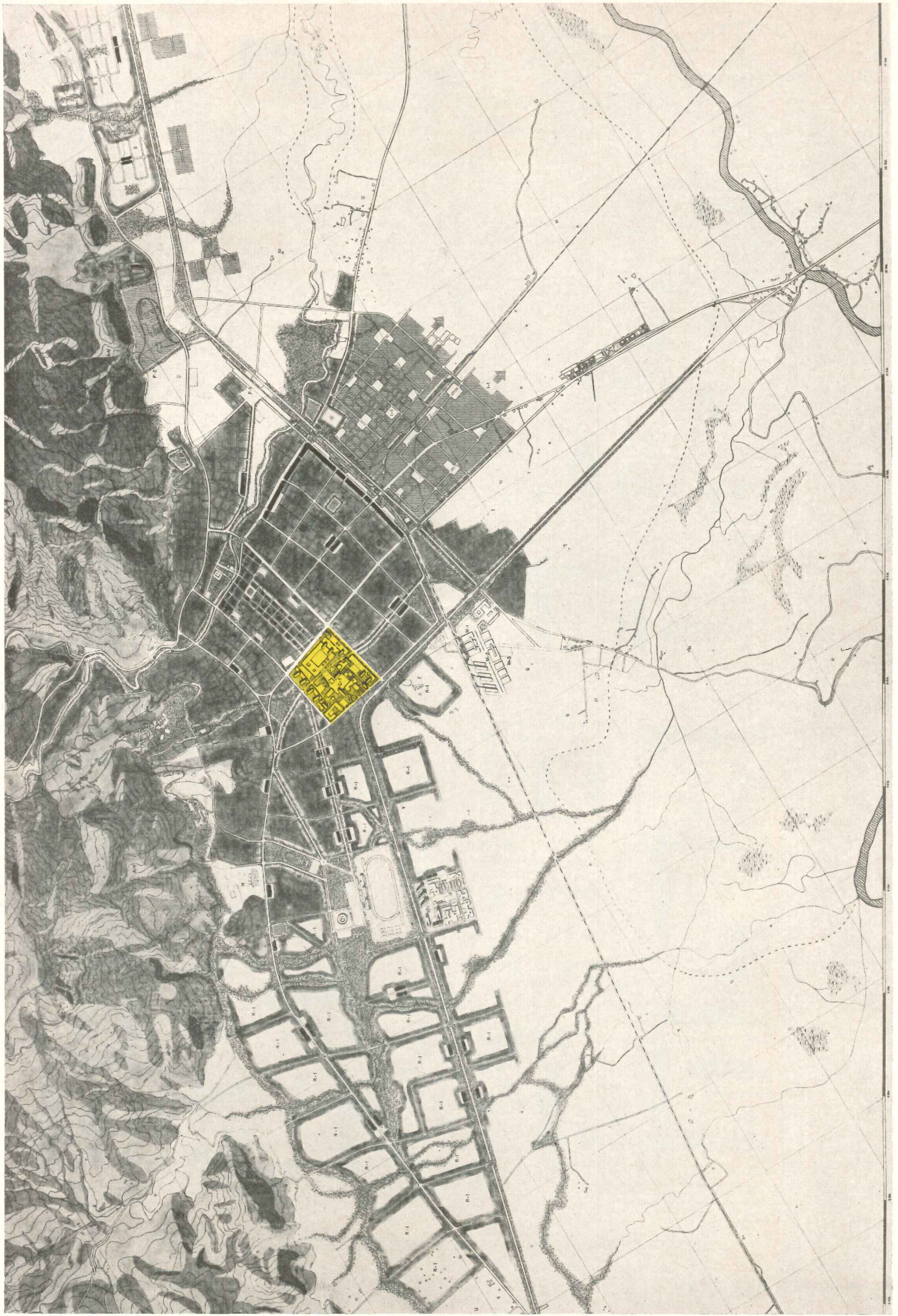
AV. GRAU



AV. WILSON









# CALI

Colombia

*Paul Lester Wiener and  
José Luis Sert, Architects  
and City Planners*

With a present population of 275,000, Cali is both a state capital and a center for commerce and light industry. It is located in a fertile valley and has a tropical though moderate climate. The master plan envisions an eventual population of 750,000 citizens.

The new civic center will be centrally located for easy access from all parts of the city. Its two main sectors, the administrative and commercial, have a varying character but are linked by a mall (3). The administrative buildings (1) are grouped about an open plaza, while the commercial center (2) is an enclosed square bounded by arcades.





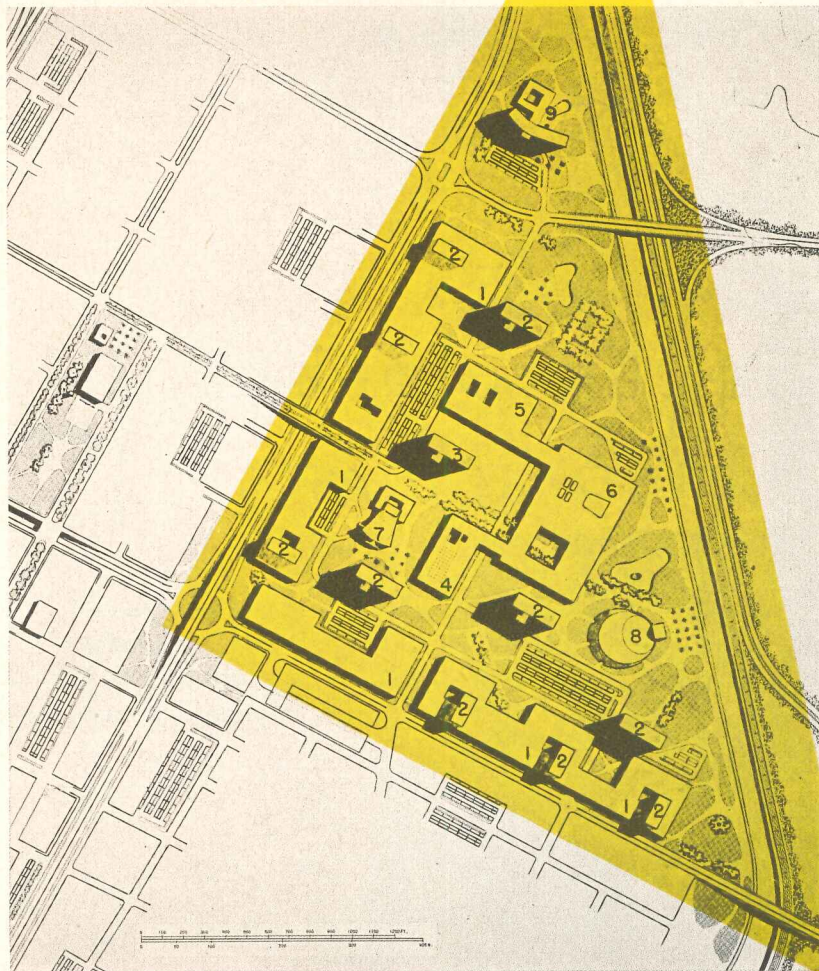


MEDELLIN | Colombia

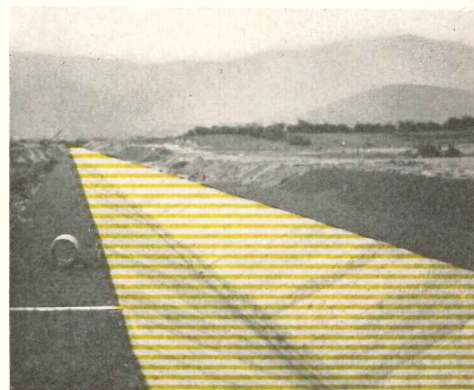
*Paul Lester Wiener and Jose Luis Sert, Architects*



# THE NEW CIVIC CENTER PLAN



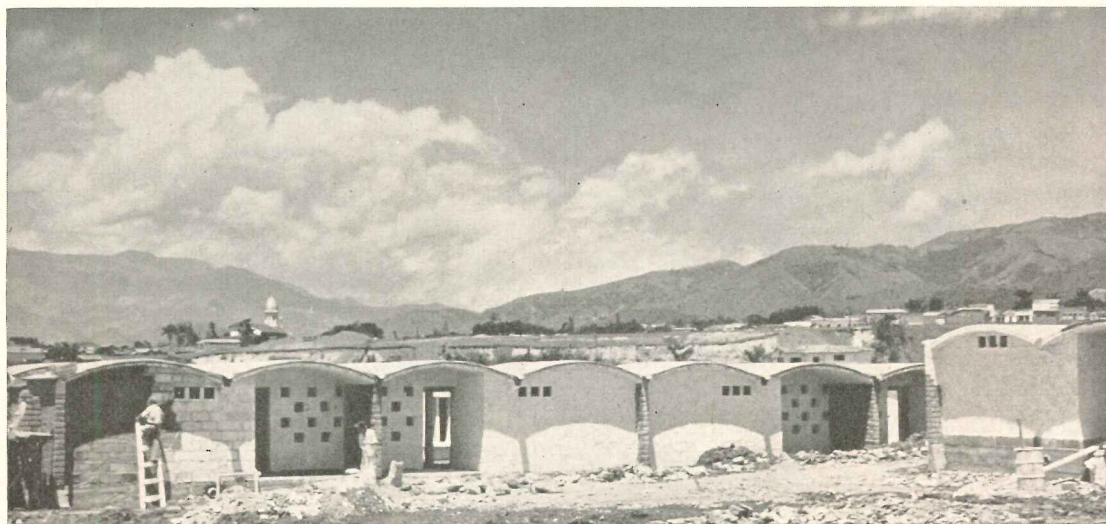
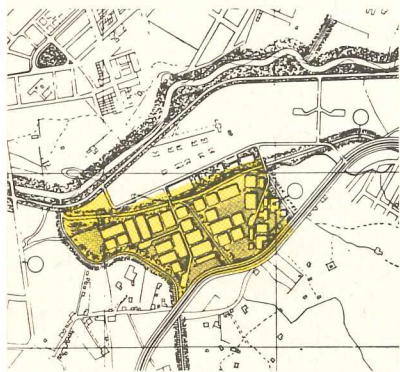
- 1 Shops
- 2 Office Buildings
- 3 Government Offices
- 4 Library; Conference Hall
- 5 Archeological Museum
- 6 Cinema; Restaurant; Exposition Hall
- 7 Theatre
- 8 Open-air Theatre
- 9 Hotel




With a present population of 250,000 and 700,000 anticipated in 50 years, Medellin is Colombia's second city and chief center for textiles and coffee. The Medellin River forms the axis of the valley city, and its control has been a leading concern of the planners. A series of lakes, dikes, dams, and irrigation ditches will prevent erosion and establish a network of planted areas penetrating the city in the pattern of the large map opposite.

A variety of residential developments, left and below, are planned as districts, each complete with civic, recreational and commercial facilities.

The new civic center will occupy a site on the riverfront now occupied by railroad yards and the public market. Pedestrian and vehicular circulation have been carefully separated; see plan above.







PUERTO ORDAZ  
and  
CIUDAD PIAR

Venezuela

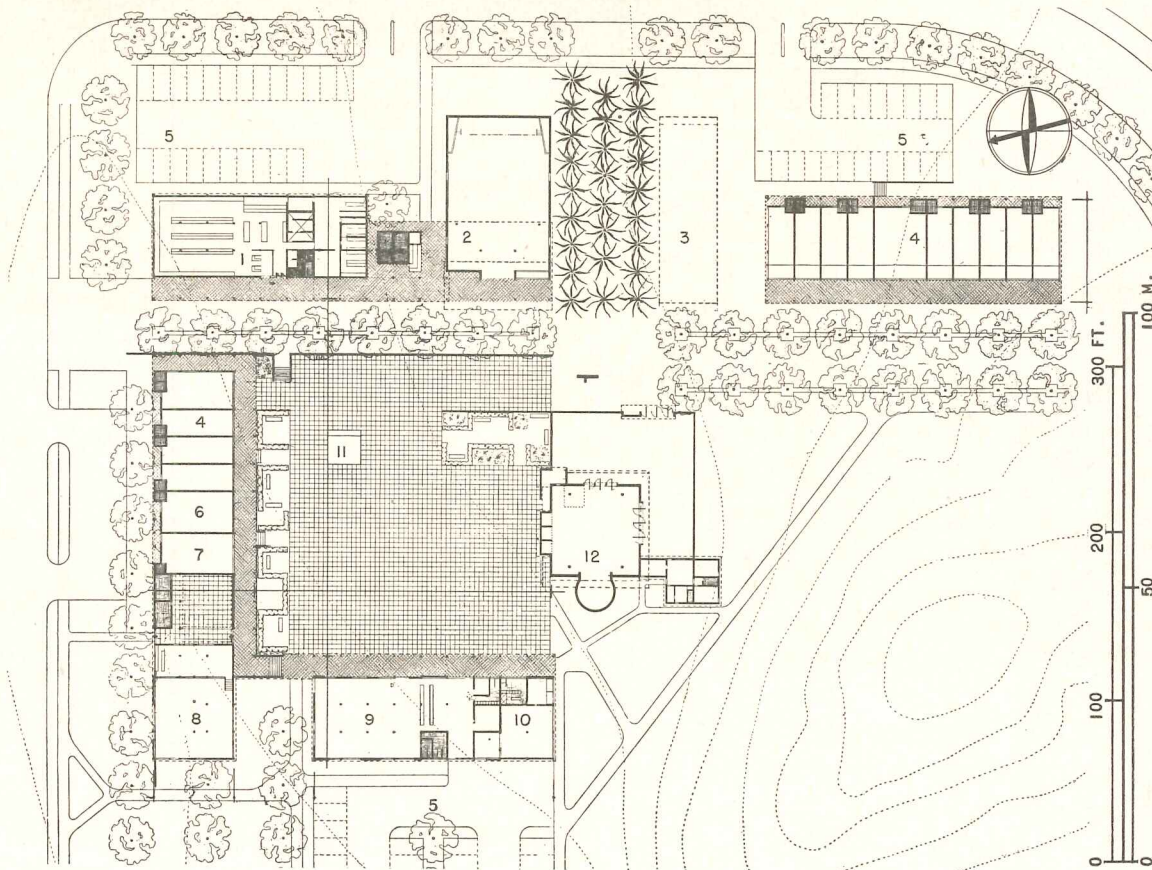
*Paul Lester Wiener and  
Jose Luis Sert, Architects  
in collaboration with Oficina de  
Planificación y Vivienda, Caracas*





# THE CIVIC CENTER FOR CIUDAD PIAR

- 1 Commissary
- 2 Cinema
- 3 Future Municipal Building
- 4 Shops
- 5 Parking
- 6 Post Office
- 7 Bank
- 8 Club
- 9 Cafeteria
- 10 Fire House
- 11 Bandstand
- 12 Church

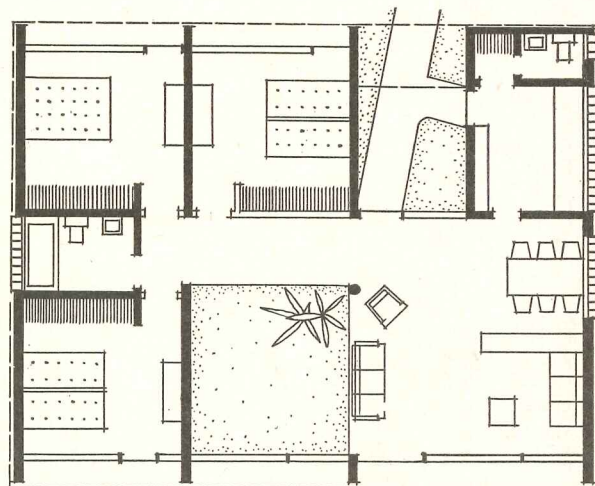
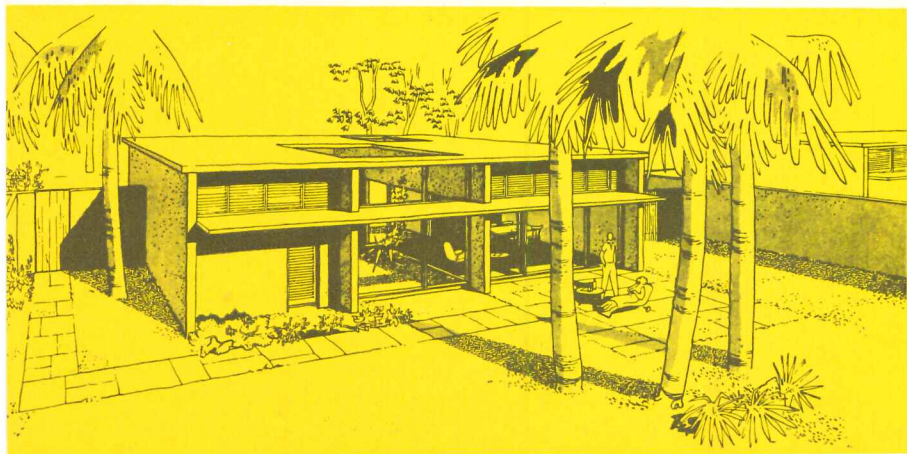


Located near the Orinoco River in Venezuela, Cerro Bolivar, a low mountain containing an estimated one half billion tons of iron ore, was discovered six years ago by U. S. Steel Corp. engineers. Today, at the foot of the mountain, a new mining town called Ciudad Piar is under construction, as is a port city called Puerto Ordaz, 90 miles away. By 1955 the high grade ore will be feeding the Fairless Works in Pennsylvania.

Each community will have its civic centers, serving both the local and foreign populations. This is one of the

first cases in which an American company, in initiating the building of new towns abroad, has called for an integrated town plan. This is in contrast to the more customary "company town" concept. The civic centers will be the hearts for the towns, and should stimulate social relations between local and foreign residents.

The Orinoco Mining Company (U. S. Steel subsidiary) and the Venezuelan Government are joining hands to provide housing, social services and utilities for the entire population of both cities.

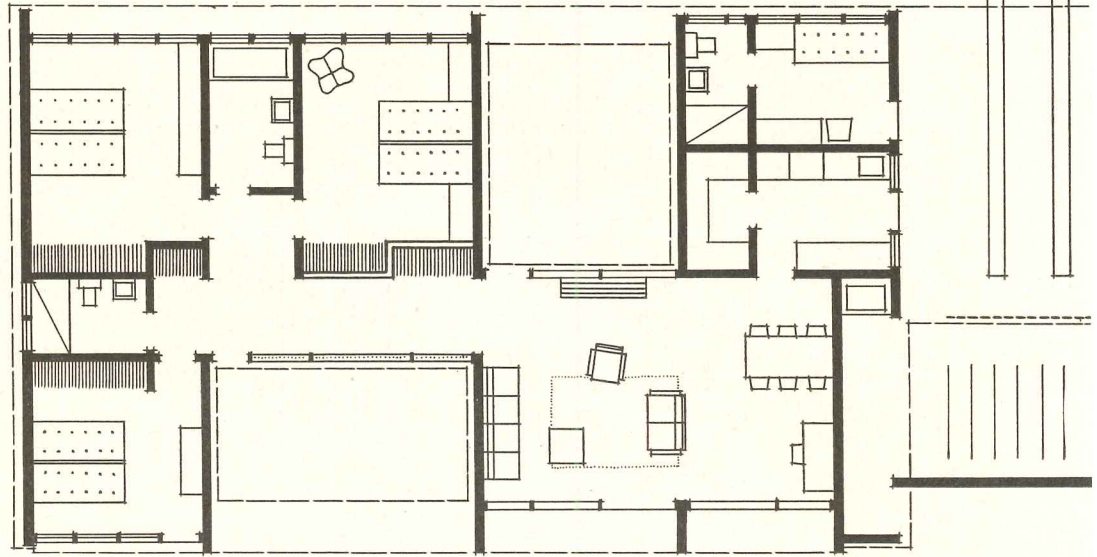
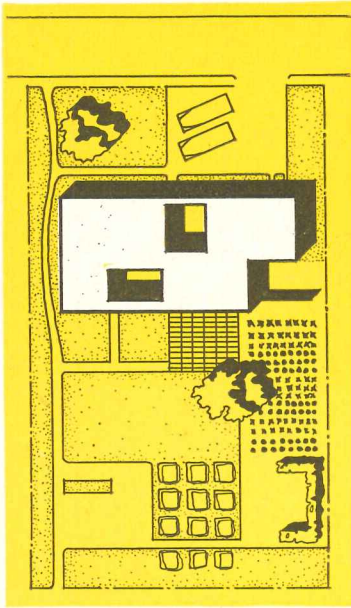


Left page shows plan of the port city, Puerto Ordaz. Above and left are preliminaries for junior workers' house



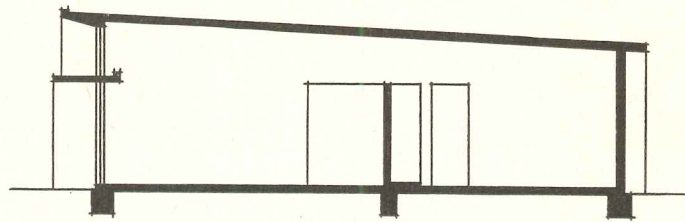
CIUDAD PIAR  
and  
PUERTO ORDAZ

Venezuela



*Only a few of the many types of houses can be shown in a brief coverage, but there will be in addition low cost houses for other categories of workers, as well as clubs, schools, etc.*

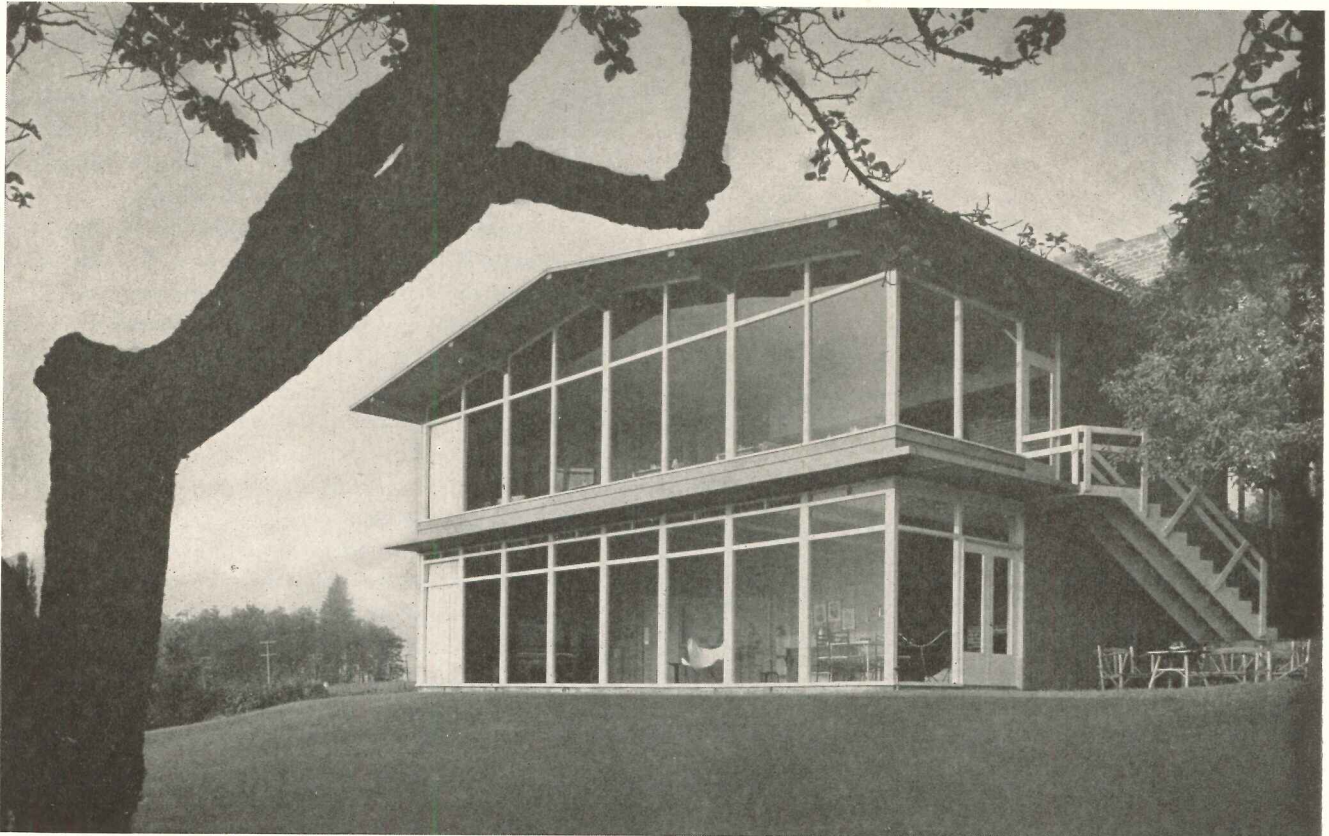
*On this page are shown preliminary studies for the senior workers' house; note the importance given to cross ventilation through open patios, lower panels, lowered doors, and screens. Houses will be built of concrete block with concrete slab floor and roof. Finished floors will be linoleum for interiors and ceramic tile for patios*



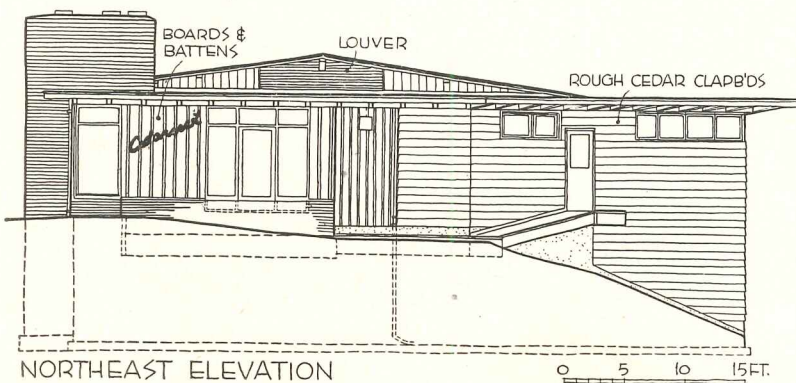


# GOLF CLUB RESTAURANT BRAVES SUN FOR VIEW

*Cedarcrest Restaurant, Marysville, Washington*



Charles R. Pearson



*Harold W. Hall, Architect*

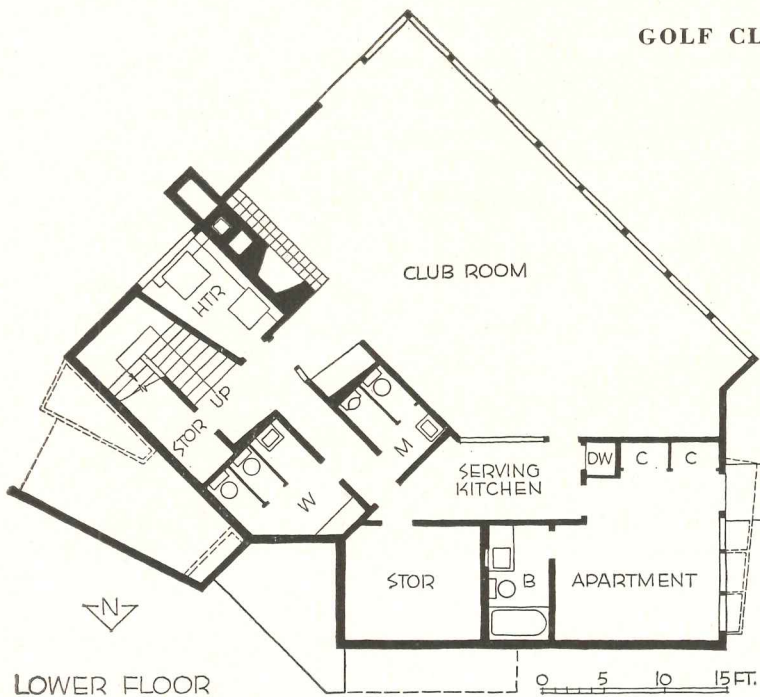
*Arthur A. Graves*

*David W. Dykeman, Jr.*

*Associate Architects*



## GOLF CLUB RESTAURANT



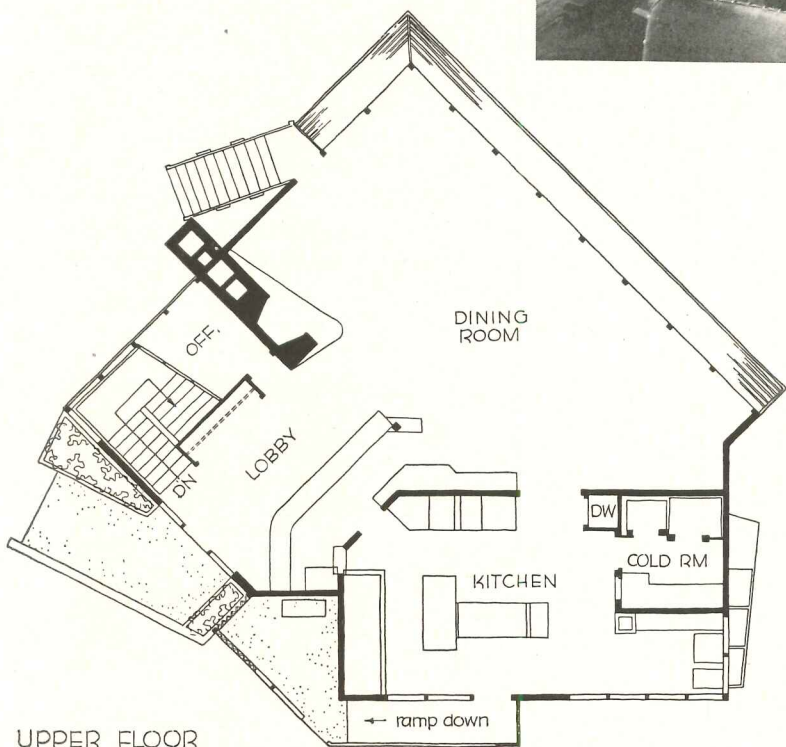
THIS RESTAURANT BUILDING is situated close to the club house of the Cedarcrest (municipal) Golf Club. It was planned not only as a public restaurant, but also as headquarters for group "field days."

Two major problems complicated the planning. One was a limited budget. The other was the unfortunate location of the best view at the southwest end of the site. Despite the fact that the budget would not permit air conditioning, the entire southwest side was, after much discussion, thrown open to the view, with floor-to-ceiling drapes providing the only sun control except for a shallow roof overhang. The owners and architects hope eventually to install mechanical ventilation in the dining and club rooms.

Construction is wood frame on concrete foundation. Only common lumber was used except for trim, which is kiln dried finish material. Exterior walls are rough cedar siding, painted. Club room ceiling is cement bound wood fiber board which acts as a two-way sound barrier between the club and dining rooms.

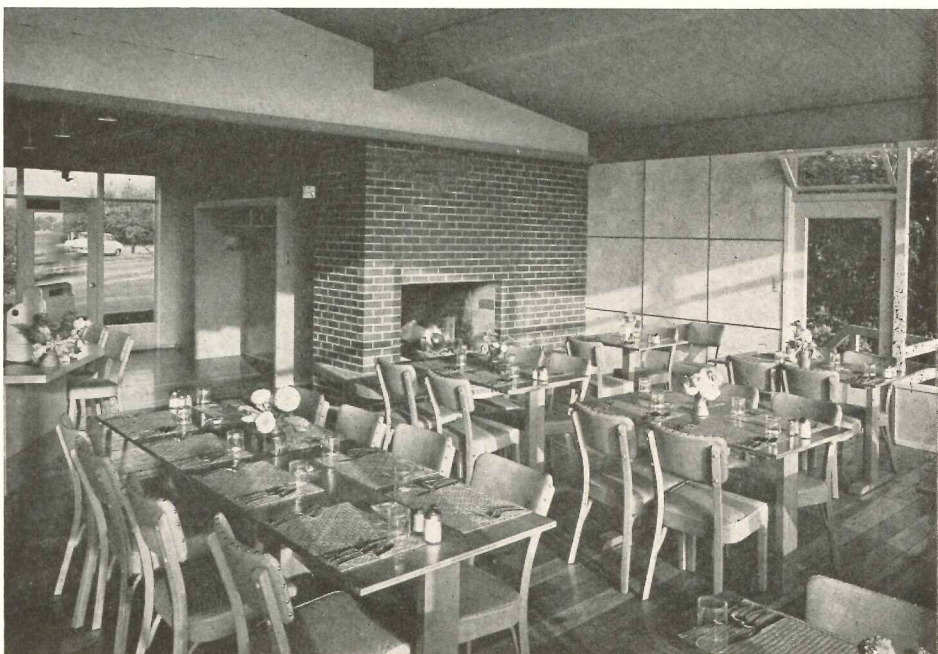






UPPER FLOOR

Budget limitations forced compromises such as use of fir planking for dining room floor; owners hope to lay either cork or carpet in near future to help cut down noise transfer from this area to club room below. Building, complete with fixture work, cost \$32,000, or slightly over \$8 a square foot



Charles R. Pearson



COMPACTNESS was the first requirement for this Los Angeles house: the owners, a couple with no children, had lived for a number of years in a residential hotel, with no household responsibilities whatever, and were understandably anxious to keep maintenance problems to a minimum. The most notable feature of the plan, however, is not the compactness but the deep-in-the-country privacy achieved on a city lot.

The house is on a low hill with a distant view of the ocean and the city. The site, irregular in shape and not too large, slopes steeply downward toward the view; existing eucalyptus and fir trees — most of which were saved — provided natural landscaping, and were used to frame the house. Well distributed

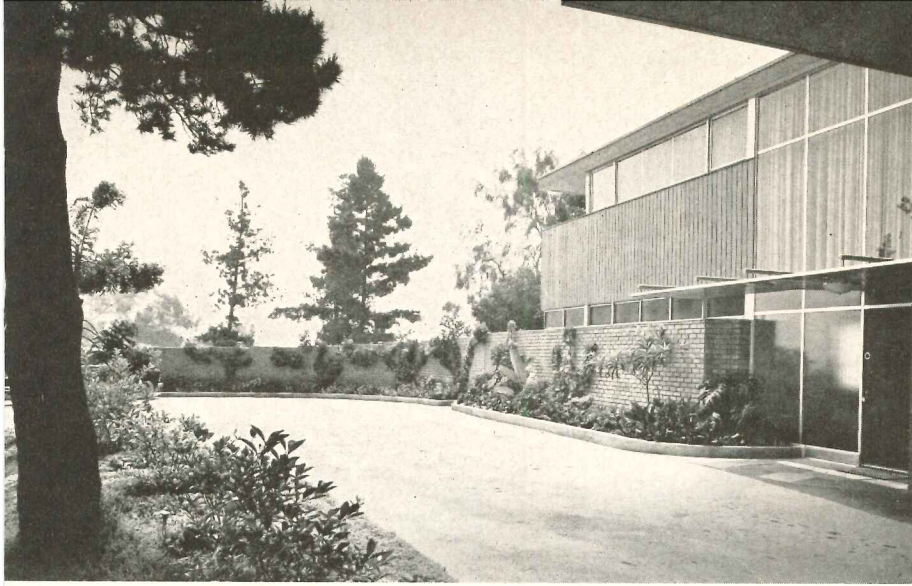


planting space outside the terrace windows and along the brick motor court wall takes the place of a garden.

At the owner's request the house is two stories in height, with living rooms and maid's quarters on the ground floor and the two master bedrooms upstairs. Both living and dining rooms open to a curved terrace protected from the winds by the high brick wall and the house itself, but freely overlooking the view to the south. The master bedrooms, each with its own dressing room and bath, share an 8-ft-wide balcony, partly screened for fly-less sunbathing.

The structural frame of the house is based on a 6 ft-4 in. module with steel posts and wood beams. Exterior walls are stucco and redwood siding.



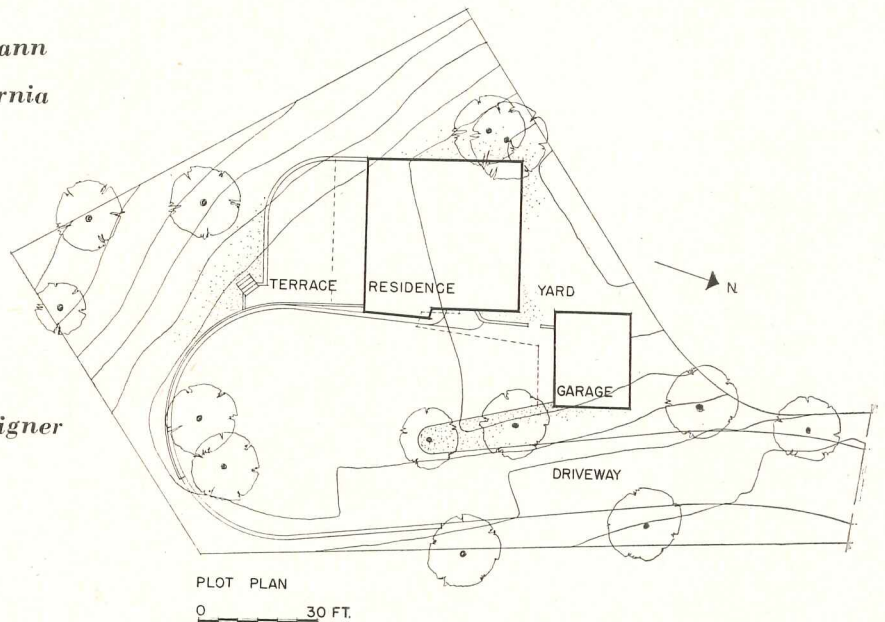


Semicircular brick wall of motor court is integrated into design of house, gives complete privacy to all living areas and shields terrace from wind. Doors in wall (opposite page) lead to terrace at one end, yard at other. Exterior of house is colorful: salmon brick wall, redwood siding, aluminum window frames, brilliant coral wood panels between first and second story hall windows. Aluminum sheet canopy connects house with garage

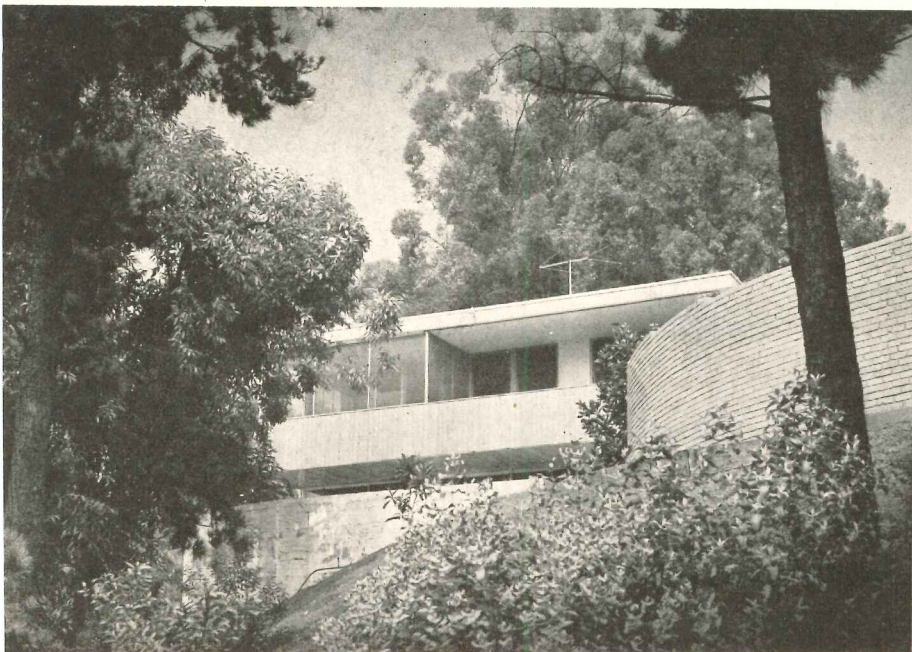
## CITY RESIDENCE BOASTS COUNTRY PRIVACY

*House for Mr. and Mrs. Gustav Dann  
Hollywood Hills, Los Angeles, California*

*J. R. Davidson, Designer*



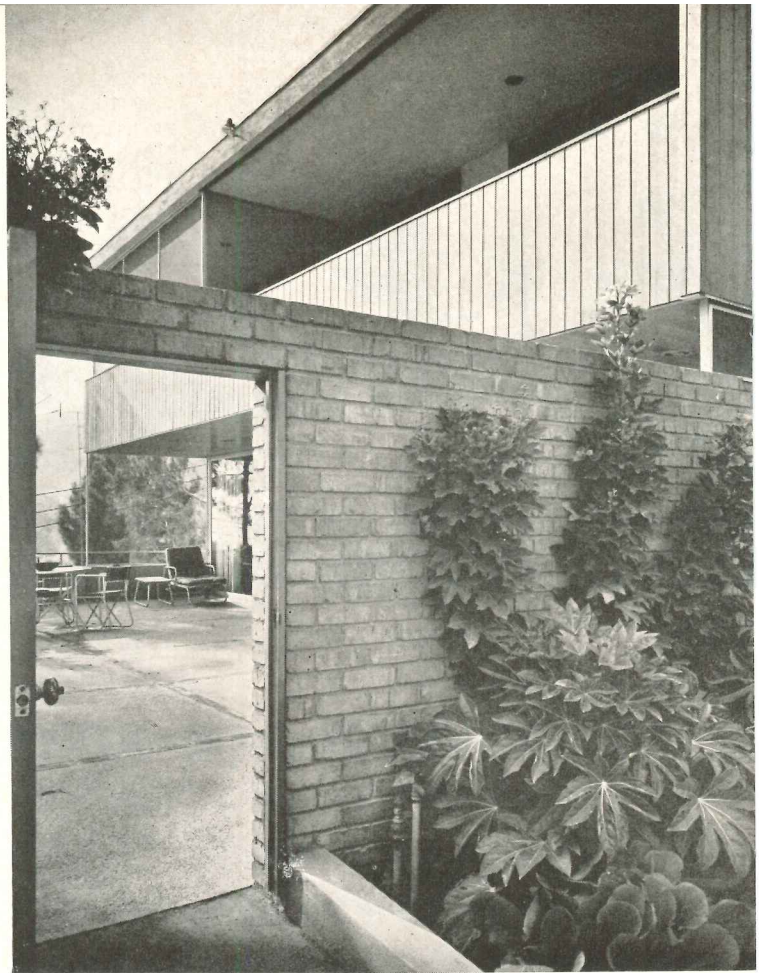
Julius Shulman



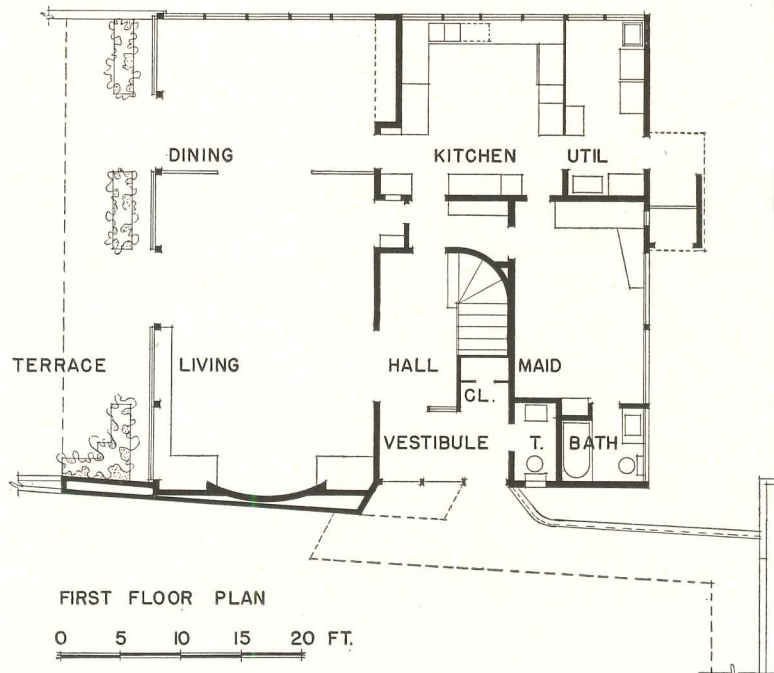
Steepness of site at south and east necessitated retaining wall for the filled-in terrace of living and dining rooms. From just a few feet below the house only the second floor is visible. Screen on bedroom balcony is plastic, on steel frame. Window frames are lemon yellow



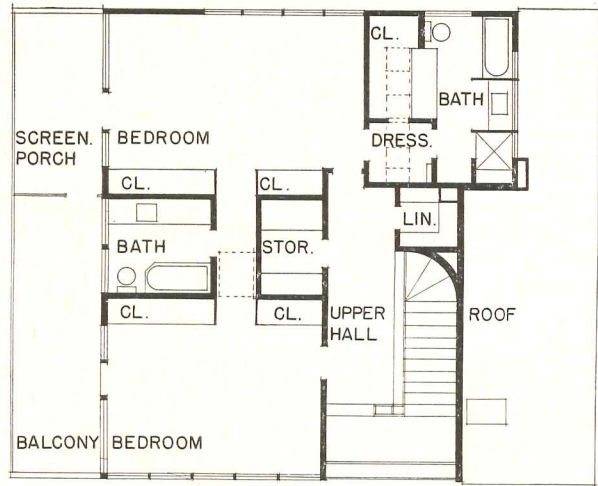
CITY RESIDENCE — COUNTRY PRIVACY



Left: main entrance is from motor court; door is wood, painted eggplant to contrast with salmon of brick wall; lower windows are ribbed glass, entrance paving is Arizona flagstone. Above: view of terrace through door to motor court; bedroom balcony has high railing of cypress siding for privacy







SECOND FLOOR PLAN

Julius Schulman

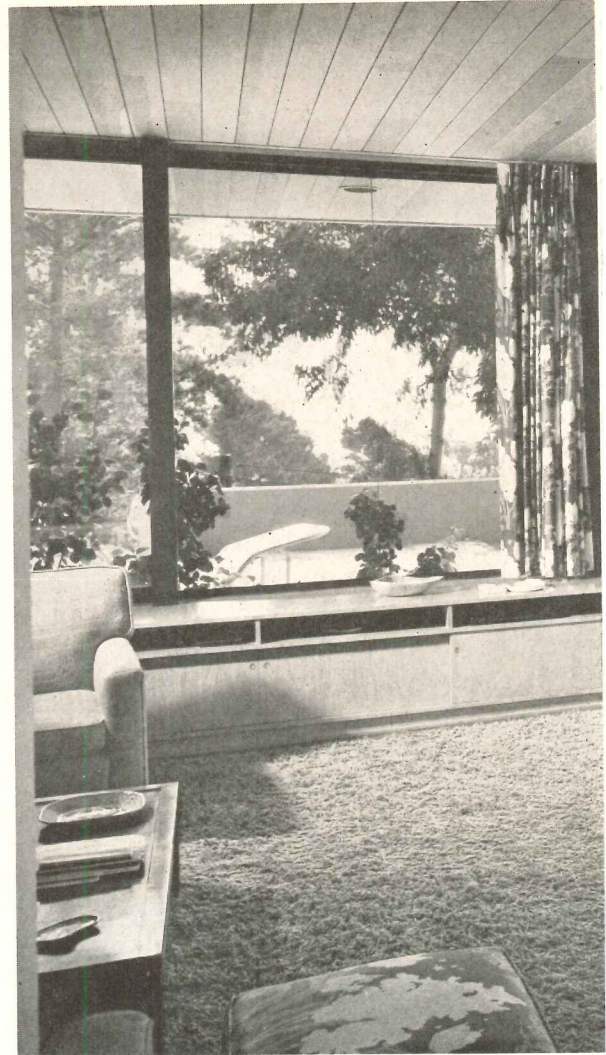
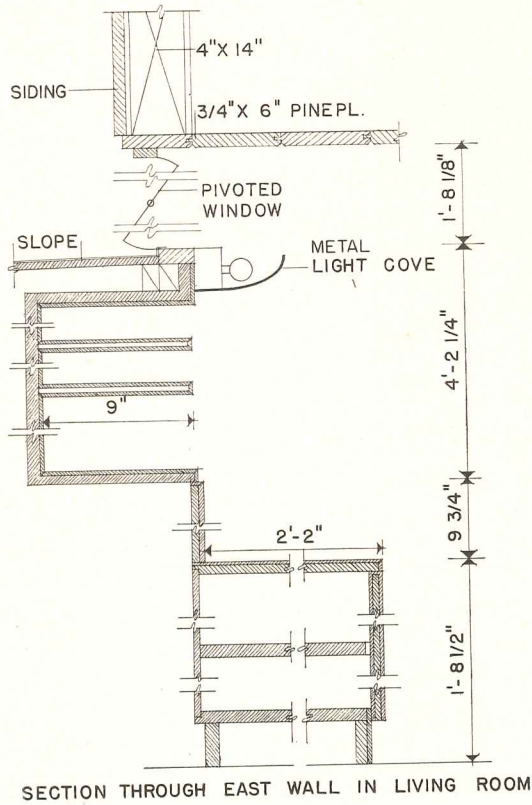


Terrace overlooks the city — but distantly, over the trees.  
Paving is cement with exposed aggregates and brick liners



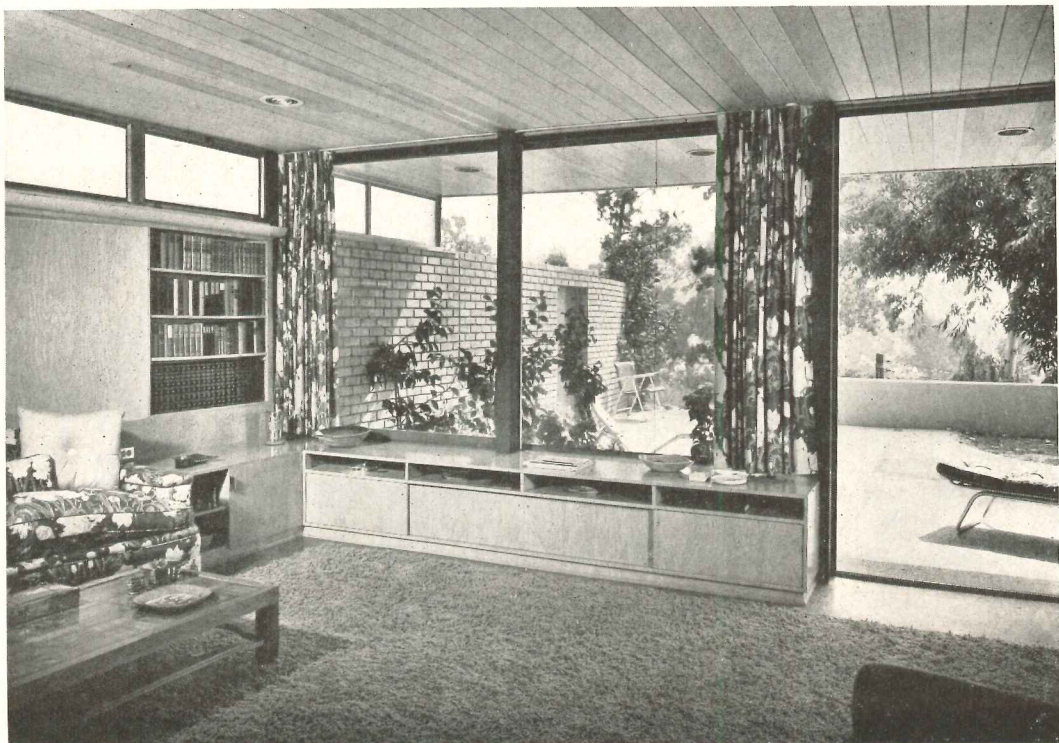
# ARCHITECTURAL INTERIORS

Design | Details | Materials | Equipment



## CITY RESIDENCE — COUNTRY PRIVACY

Above and below: living room looking toward terrace. Ceiling is pine T & G; east wall and low cabinet under window are natural elm, waxed. Floor is cork, rug is light cocoa colored loop. All lights are recessed, and a light cove runs the length of the east wall above the book shelves and cabinets (section at left above)

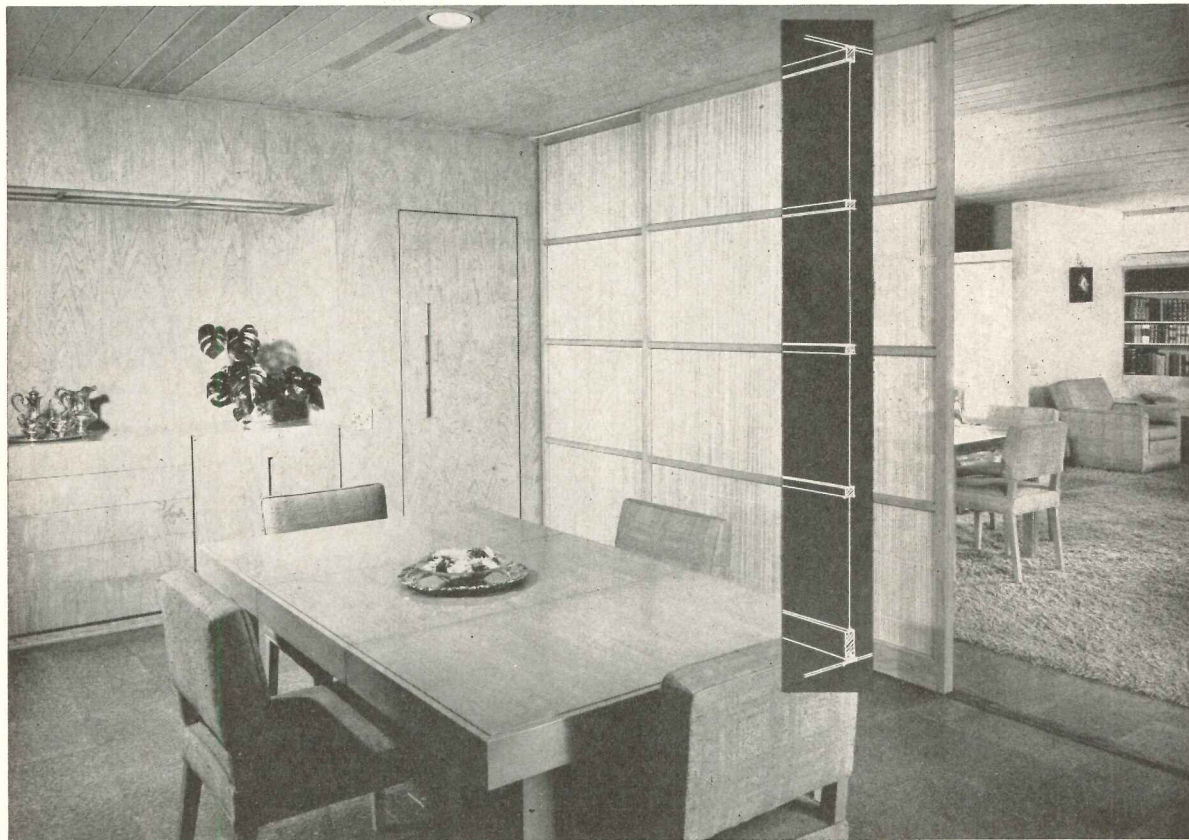






Two sliding screens of woven wood close off dining room when desired. Dining room floor and ceiling are same materials as in living room. Buffet wall is paneled in elm, waxed; lights are built into buffet ceiling. House is heated by radiant panel, in floor on lower level, in ceiling on upper

Julius Shulman





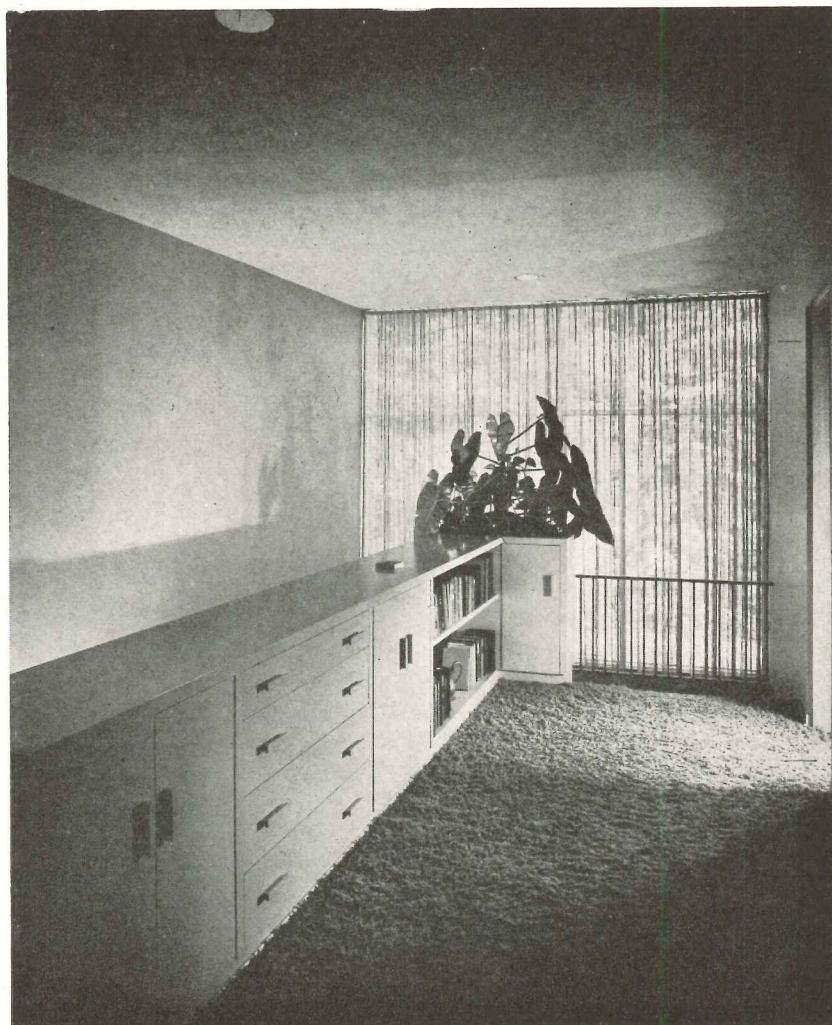


**CITY RESIDENCE — COUNTRY PRIVACY**

*Left: vestibule floor is Arizona flagstone, ceiling is coral-painted plywood, wall is light gray. Small wood mesh screen separates vestibule from hall. Below: second floor hall uses low storage cabinets with planting box at one end as railing above stairs. Carpet here and on stairs is cocoa, wall at left is painted to match. Two-story hall windows are clear glass; draw curtains are bamboo weave*

**ARCHITECTURAL INTERIORS**

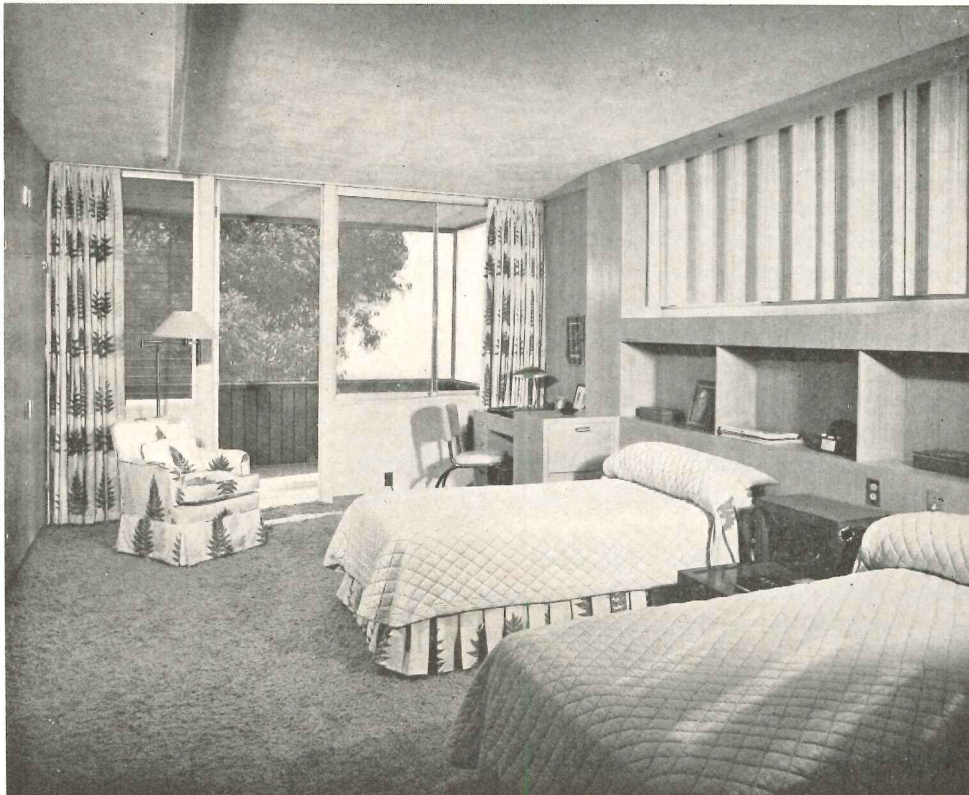
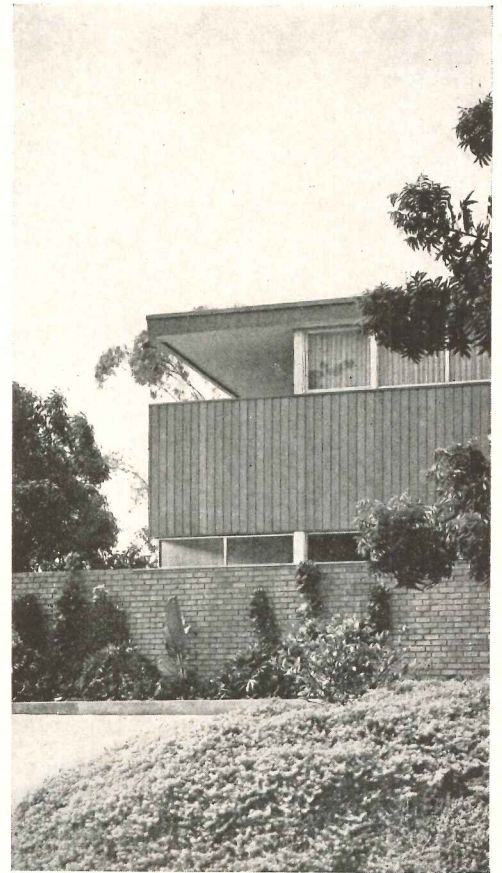
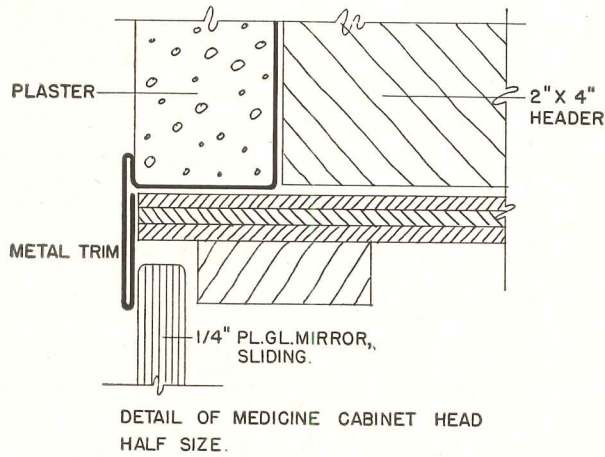
**Design | Details | Materials | Equipment**







Bath between two master bedrooms is key to second-floor versatility: owners can spread out over entire floor or assign a completely separate suite to guests. Medicine cabinet (detail, below left) is flush with wall, has sliding mirror door. Glass jalousies at windows; asphalt tile floor, light yellow walls, gray lavatory top. Each of three baths (including maid's on ground floor) has electric wall heater



Storage space, excellent throughout the house, is particularly good on second floor. Each bedroom has two large clothes closets, and the master bedroom (left) has in addition a much larger closet off the dressing alcove plus built-in storage drawers and shelves. Upstairs hall also has linen closet and large shelf-lined storage room

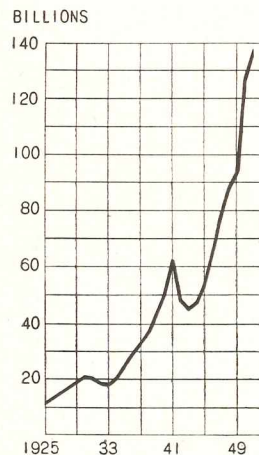


**M**ORE AND MORE ARCHITECTS are being called upon to design industrial buildings. The amazing growth of America's industrial plant in the last few years seems to know no stopping point. Presumably the government-sponsored defense plants are largely built, and that particular push is over. Yet industrial buildings continue to pop up, as expansion begets further expansion, in a sort of cosmic progression.

It is the smaller offspring that become the subject of this Building Types Study. The study focuses especially on small industrial buildings having some relation to truck transportation — factories, warehouses, truck terminals, buildings usually found in smaller cities. These types of buildings, though widely different in some respects, have a common interest in the booming growth of over-the-road transportation, indeed the trailer truck has now become a major factor in building design.

The chart at the left shows how rapidly truck transportation is developing. The American Trucking Associations report: "The American trucking industry is one of the most dynamic forces in our national economy. It has grown from fewer than 400,000 trucks in 1917 to more than 9,000,000 trucks and 500,000 freight trailers today (1951 figures). It gives employment to over 6,000,000 persons with an aggregate payroll of over \$20,000,000,000 per year and fur-

INTER-CITY TON-MILES  
ALL TYPES OF TRUCKS



ARCHITECTURAL RECORD'S BUILDING TYPES STUDY NUMBER 201

INDUSTRIAL BUILDINGS

Industrial Buildings Types  
Studies in Architectural  
Record

- June 1938
- June 1939
- February 1940
- January 1941
- January 1942
- June 1942
- December 1942
- October 1943
- November 1945
- December 1946
- August 1947
- August 1948
- November 1949
- February 1951
- July 1951
- February 1952
- Motor Transport Terminals  
October 1941
- Lighting of Industrial Plants  
September 1942
- Power Plants  
May 1944
- Industrial Research  
Buildings  
July 1950

nishes indirect employment to many others. Last year it spent over \$3,000,000,000 for new equipment alone and much more in operating expenses for fuel, tires, terminal buildings and supplies."

To architects the significance of all this lies in the great number of small buildings, in small cities, involved in this type of expansion. Factories, as everybody knows, are moving to the suburbs, in fact to the country, freed by trucks and automobiles from their former dependence on big-city transportation systems. Sales and service buildings and warehouses, again dependent on trucking, are opening up new markets in outlying territories. And the trucking industry needs its own buildings. The past two or three years have seen great numbers of strictly terminal buildings, as distinguished from warehouses, spring up at highway centers. The truck terminal has lately become the subject of intensive study (see page 156), for materials handling, even from one truck to another, is recognized as a costly operation.

For architects this is almost a virgin field, involving a range of small buildings with widely different design criteria, but all in their own way paying homage to the monster of the highway.



# NEWER TRENDS IN INDUSTRIAL BUILDINGS

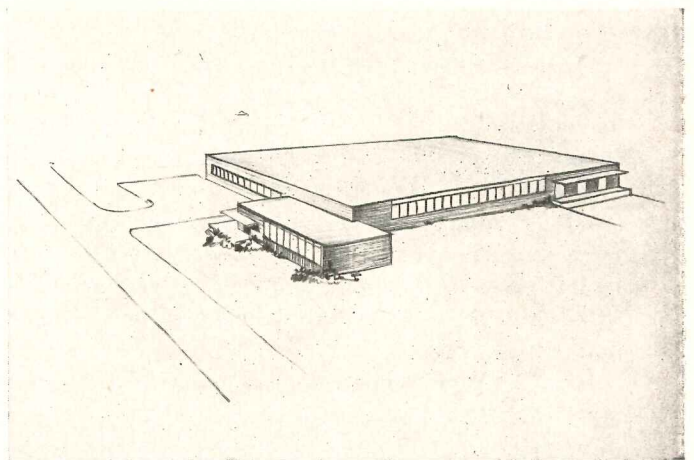
*By Frank L. Whitney*

*Chief Engineer, Walter Kidde Constructors, Inc.*

**I**N THE YEARS SINCE THE WAR there has been an amazing activity in the construction of smaller industrial buildings. In this rapid expansion there has been a definite trend toward decentralization. These two factors, each with many ramifications, have not only spread the work of the design professions, but also produced many changes in programming and design, also in construction techniques.

There is a third factor, which is perhaps more important than either of those first two in the changing concepts and uses of industrial buildings. That is the development of a highly organized system of truck transportation. It makes no particular difference that reliable trucking has been built up to accommodate changes in our distribution system: the solid fact is that over-the-road transportation has made possible a wide dispersion of American industry and a far-flung complex of factories, warehouses, sales and service buildings and truck terminals. Transportation factors have always determined the location and design of industrial buildings, and as transportation changes, so do the buildings. It is the purpose of this article to examine quickly some of the more important aspects of the changing industrial scene, and to trace some of the effects in the design of industrial buildings.

The dispersal of industry is a central if obvious fact. Though this has been a stated objective of government, as a safety measure in case of bombing attack, the other reasons for moving to the country are quite compelling. They are of course familiar, and need only brief mention here. Congestion is both expensive and unpleasant, two very cogent arguments for dispersal. Today parking space for employees' cars is likely to be more important than mass transportation for workers. City taxes drive industry outward. So do labor considerations. So do land costs. Given good roads, automobiles for workers, trucks



*Small buildings, in small cities — many warehouses*

for materials and finished products, dispersal is almost automatic.

More important perhaps than these common inducements is the distribution system. Markets today are not confined to city concentrations; markets are everywhere. As the once-undeveloped areas — the South, for example, or the West — become increasingly important market places, industry moves out to serve them. And there follows an ever-growing complex of small factories, distribution centers, warehousing and service facilities, garages, truck terminals. If in all of this development the old-time wholesaler has all but disappeared, the complicated distribution system that replaced him still needs buildings — more buildings rather than less, and buildings of more different types and designs.

## CHANGES IN THE FACTORY

The planners of factory building have gained important freedoms in this dispersal movement, just as the industrialist has. It is axiomatic that the factory building is designed around the production line. With a large plot available, the designer is free to accommodate the assembly line in any desired alignment, disposing his



areas as he sees fit. He can place storage areas, power plant, employee facilities, truck docks as the process demands. And he can arrange for expansion or for future changes without restrictions because of limited land area.

These are the more obvious freedoms; there are some new ones, however, which may not be so apparent. Take the matter of storage. In each type of plant there are individual problems of storing raw materials on the one hand and finished goods on the other hand. These are problems that need constant re-examination. It may be found, for example, that coordination of delivery arrangements may cut down or virtually eliminate the areas commonly reserved for storage. It may be much more efficient to take finished products off the line and directly into carriers and out of the plant. There are in fact manufacturing plants that would have to shut down if the outgoing transportation should be tied up for even a few days; they have simply eliminated storage of finished goods. Such an arrangement might be entirely feasible for one factory, but completely impossible in another. Or, the distribution system and the particular location may introduce delivery factors that might reverse the design criteria for materials and product handling. It is not news, of course, that materials handling problems are major design considerations; the point here is that modern distribution systems, completely outside the plant, introduce new complications within the plant, and that these may vary widely in different locations.

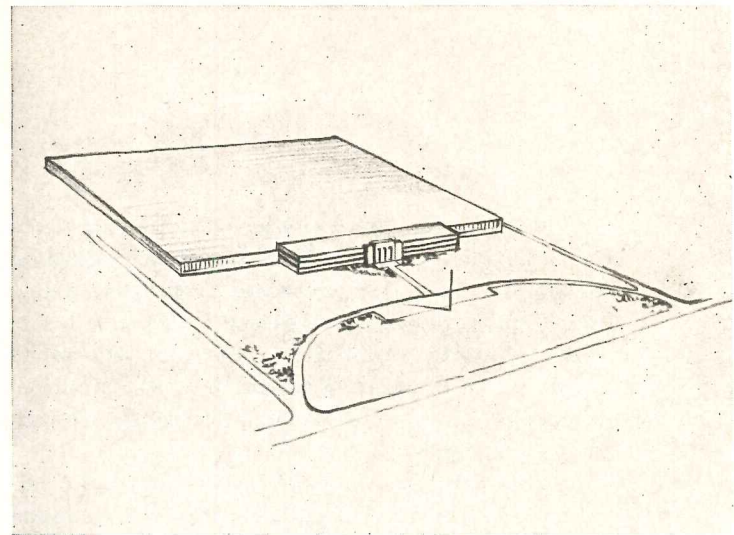
In architectural design the new freedoms are increasingly in evidence. The architectural concept of the industrial plant has in the past decade been radically revised. Industry readily accepted the principles of contemporary architectural design in its early stages, and with few exceptions these principles were put into full use in the suburban development. This because there was no required architectural tie-in with existing designs as had been the case in the expansion of most existing urban plants. Also, and more importantly, the economies of contemporary design were probably its greatest impetus. The industrialist found that he could have an attractive-looking plant in the contemporary style at no additional cost and in many cases, under an intelligent direction, actually at reduced cost. There were, of course, the few exceptions in industry where traditional pattern was desired, in which the industrialist was willing to accept the added cost. It is interesting to note that in most of these cases actual inefficiency of operations developed and the ability to design the logically expanding plant was considerably limited.

Another strong design influence is the federal tax structure. With few exceptions it seems to be the manufacturer's desire to develop the lowest capital expenditure, and while this is not exactly news, there may be a curious reversal due to tax factors. Without tax considerations the designer would try to work out a building which would give his client the best economy over the years, balancing first cost against annual operating costs; he might spend a bit more initially to save main-

tenance expense. But with high annual corporate taxes on profits there is less reason to invest more heavily at first, since the maintenance expense becomes an allowable item of cost.

This consideration could reverse again if the plant were for defense production, its cost written off in five years as permitted by the government as an inducement to undertake construction.

One word of warning here. This principle of balancing tax factors does not imply any general carelessness about manufacturing costs. The point is that manufacturing costs are not the same as building maintenance costs,



*“The architectural concept of the*

and the latter are presumably small by comparison. Low manufacturing costs might indeed be the principal reason for construction of the plant. It is nevertheless true that, once the building is properly planned for low-cost manufacturing, costs of operating and maintaining the building itself are not overpowering considerations.

Perhaps a more positive way of saying it is that the cost of the building is weighed primarily in relation to manufacturing costs, and this relationship is quite variable. In an earlier day a factory building was supposed to last fifty years, and was dignified with a sort of institutional quality. Too frequently the old pile did last that long, and the industry suffered accordingly. Today we think of a factory building as merely a housing facility for a certain layout of machines and the necessary personnel facilities. And the industry is prepared to enlarge it, change it, sell it, or abandon it entirely, whenever it begins to hamstring the operations. We expect a certain fluidity in manufacturing operations, and we design for it as we can.



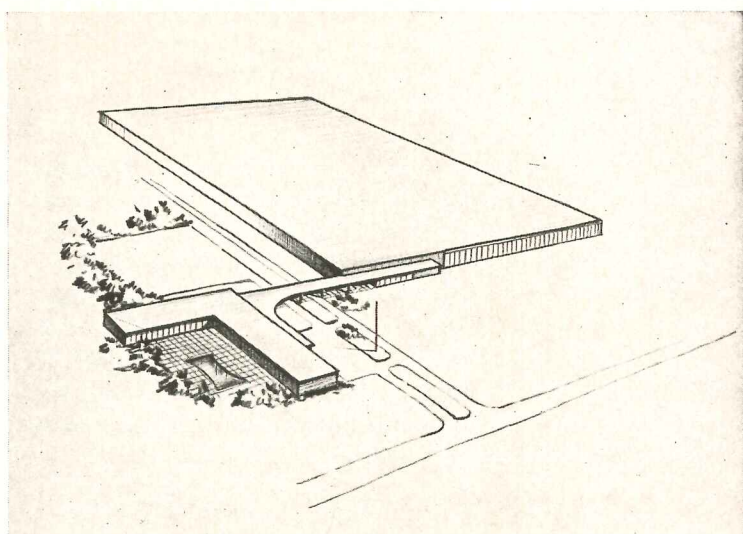
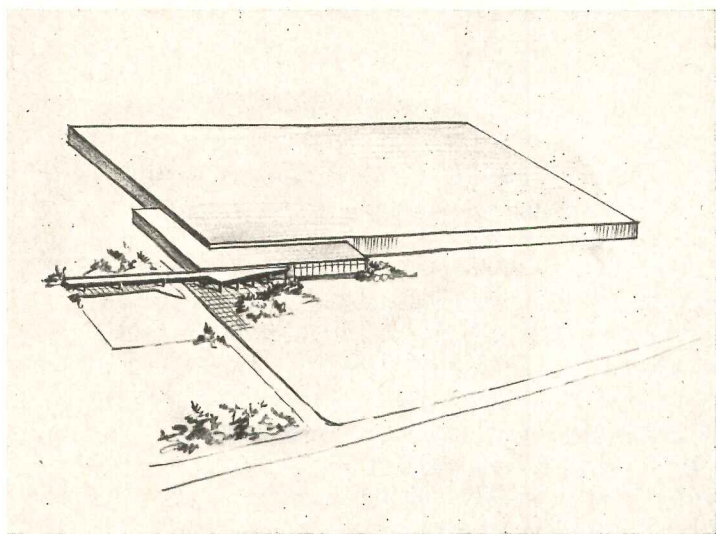
In planning a building, then, the designer leads his client away from institutional monumentality, in favor of flexibility, expandability, perhaps even demountability.

### THE FACTORY WALL

Here, then, the logical building approach is a wall which can be economically expanded or revised as the production facility is expanded or revised. Here we find masonry at a disadvantage, basically because of its inflexibility. However, in many cases the manufacturer, it seems, is desirous of masonry from the standpoint of

with the known building materials. For example, in a chlorine atmosphere these plastic panels are about the only thing we have that will stand up over a period of years without considerable maintenance. The use of plastic panels will open new vistas for the architectural designer and will have a tendency to change or modify our thinking in industrial lighting.

There are, of course, areas in the industrial building where at present the owner is justified in his desire for masonry. In food plants the smooth interior finish of the glazed tile wall is about the most economical construction where sanitation is not only desired but required.



*industrial plant has in the past decade been radically revised."*

appearance. This because brick is a building material he is used to, together with the fact that most of the panels on the market today were originally developed as a cheap substitute building material. The effort to utilize them architecturally has been a relatively recent experiment and is taking hold with difficulty. Although the use of panels has been taking hold with some difficulty, it is easy to predict its acceptance; one reason being the increasing shortage of masons, the other being the development of newer and better panels which will demonstrate lower maintenance cost and furnish the desired flexibility and resultant economy.

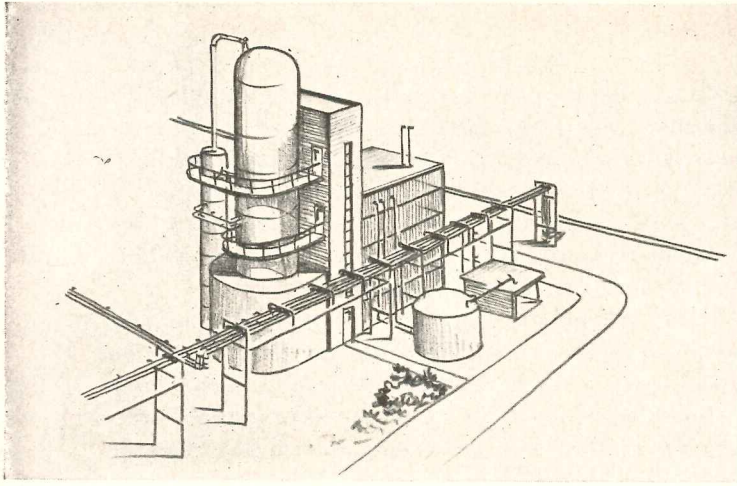
A new interest in the building market is the plastic panel. In most cases this is a corrugated panel of fiber glass mat impregnated with a resin. At the present time it is at a disadvantage since it is not fireproof. However, it is only a matter of time before this feature will be corrected. It has been in various laboratories already. It should have a great future. In some cases it will be the answer to problems which we have been unable to solve

At any rate, it would seem to be healthful to think of the industrial plant more as a shell over a mechanical process than as the ancestral home of a corporation, and try to design for fast-changing times.

One must go further along this line and inquire as to whether the factory building is a separate entity or part of the machine process. As the trend toward most "automation" continues, automatic controls are continually replacing human machine operators, until eventually it might develop that the buildings need scarcely be designed for human comforts but for machine covers. We should not be too long in recognizing that the instrument does not need the same housing facility. The instrument can also get to various levels with relative ease and without stairs. Consequently the electronic devices and relays may bring back verticality, reversing the horizontal trend.

There may come a time when the factory designer will face a difficult decision — whether to house the machine or the man. Although he might recognize that





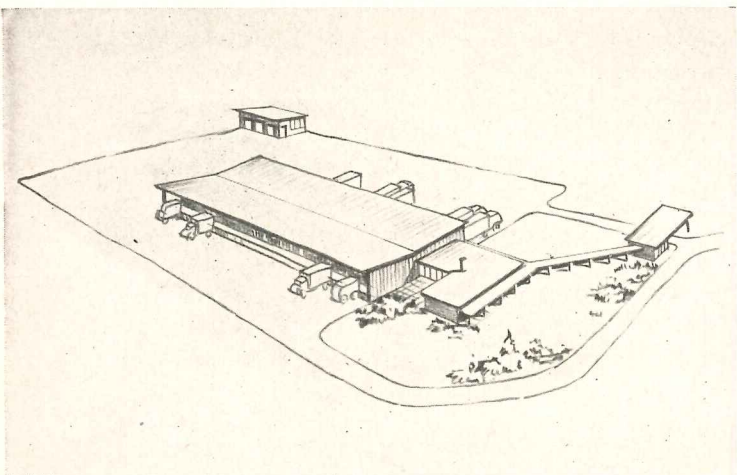
“ . . . a shell over a mechanical process . . . ”

the operator is no longer at the machine, but is rather a technical man moving about merely servicing automatic machinery, he will still face resistance, for the maintenance man will expect the same kind of air conditioned building to work in that the machine operator always had. Perhaps there would be weather conditions occasionally which would make his maintenance work difficult, but the coincidence of bad weather and breakdown would surely be infrequent, so infrequent as to make it economically unsound to design a conventional building cover merely for machine maintenance. Lest you think that this begins to sound like merely a mechanized nightmare, the author had these problems in a large refining plant which did leave many of the machines in the open.

## WAREHOUSES AND TRUCK TERMINALS

In the design of a warehousing facility or a truck terminal the architectural approach is almost completely the economical building, for the developed cost of the structure itself is a large part of the total operating cost of a warehouse. In a manufacturing facility building cost might run only a third of the equipment cost and in some process facilities even less than that. Consequently, the importance of structure varies with use. In the highly competitive warehousing field the ingenuity of the architect is taxed greatly because of the highly competitive nature of business and because of the

### *Truck terminal, a new building type*



importance that the cost of the structure will play in the operation.

One of the most typical solutions of a warehousing problem is the masonry bearing wall with the light open-web long-span joist roof. The masonry bearing wall is particularly suited to warehousing; inasmuch as it is a working wall it will demonstrate certain economies. Its one big disadvantage is its inflexibility for future expansion. This, of course, is not of major importance in the warehousing and terminal field inasmuch as new facilities can be separate units without much difficulty of operation.

Further studies of the warehousing structure have been centered around the column spacing. It is the natural desire of almost every warehouse operator to have as much clear and unlimited space as possible. However, again the economics of structure enter this picture. When one attempts to develop a span somewhere beyond 40 feet in length, economy dictates that he go to a truss type member and although the steel in pounds per square foot of building is less on a truss building, the cost per pound is relatively high, due to the greater fabrication cost. Consequently, a great deal of study has been devoted to economic spans for this type of building.

There are several factors to be considered: economic sprinkler head spacing and spans which would accommodate the maximum palletized storage. One bay spacing which has been developed and seems to be admirably suited for most warehouse layouts approximates the 24 by 33 foot bay. This seems to approach the maximum in sprinkler head coverage. It facilitates the use of relatively economically wide flange sections which can either be cantilevered over the columns or more simply connected. Although the pound per square foot of steel is somewhat higher than in some of the other schemes, the fabricated and erected cost due to the simplicity of design brings it within the economic range.

One more general remark on warehouses and truck terminals: they really should not be lumped together so blithely, and they appear in several different uses and types. In a sense a warehouse is the opposite of a truck terminal: the warehouse stores the goods; the truck terminal is designed to speed a handling process with an absolute minimum of storing.

Warehouses might be as widely different as the products they store — furniture vs. frozen foods, fish vs. vitamin pills. And naturally their design problems are widely different.

Truck terminals are tending to be much alike, if they are intended, that is, for commercial or contract truck lines. But the bulk of the truck fleets are owned by private corporations — Coca Cola trucks, for example — so terminals for them vary again as widely as the operation involved.

Sufficient to say here that they are getting to be big business, in every highway crossroads. And they are worthy of real study by the designer, being types of buildings where functional aspects assume great importance in a highly competitive field.



# SMALL FACTORY FOR A MOTORIZED AGE

*New Plant for Atlanta Envelope Company, Atlanta, Ga.*

*Moscowitz, Willner & Millkey, Architects*

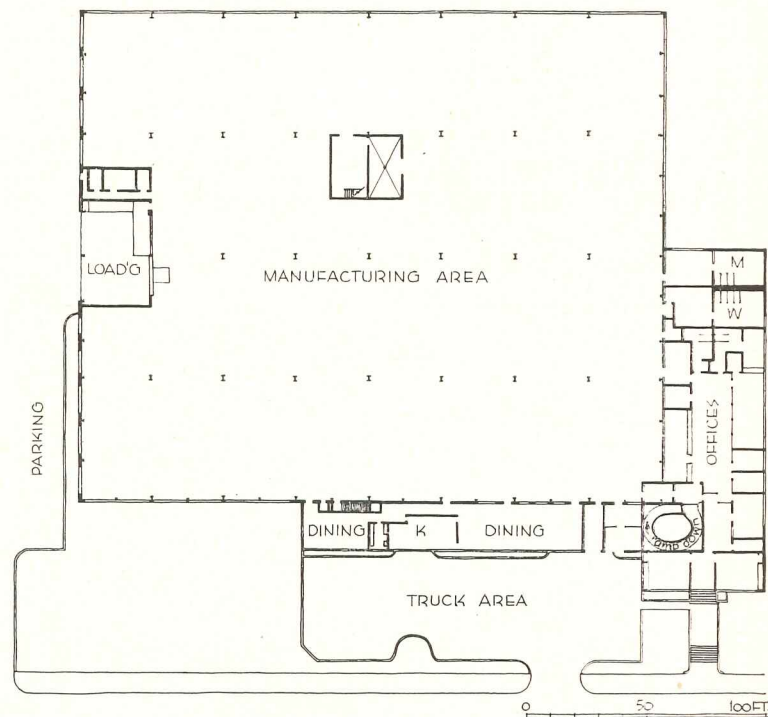
TYPICAL of the small factory in a motorized age, this building pays its respects to the truck and the automobile. Its site was chosen on the main north and south highway through Atlanta, for easy access for truck deliveries, also to develop the advertising value of display to hordes of passing tourists. In addition, the site adjoins the clover leaf of a new expressway, permitting



Joseph Molitor

attractive landscaping and insuring an open area around the building. Although the plant is essentially a one-story scheme, advantage was taken of a slope to provide a lower floor for boiler room and scrap baling room. Separate chutes from machines above provide a very economical means of removing scrap paper, also of keeping it sorted by types. The two-level operation provides for deliveries at either level, to minimize handling costs. Parking areas are provided both at the rear on the main floor level and at the entrance at the lower level. Access for all personnel and the public is from the main entrance, from which an oval, cantilevered concrete ramp spirals up to the reception room on the main floor. This low-rise ramp was used instead of a stair and elevator which would otherwise have been necessary.

The building was designed around a circular flow chart for mass production of envelopes. Cantilever steel construction gave a 30- by 50-ft column spacing with a minimum of steel. The structural system uses the concrete floor as a structural element to stiffen exterior columns. Exterior walls are placed outside the exterior columns.





## FACTORIES

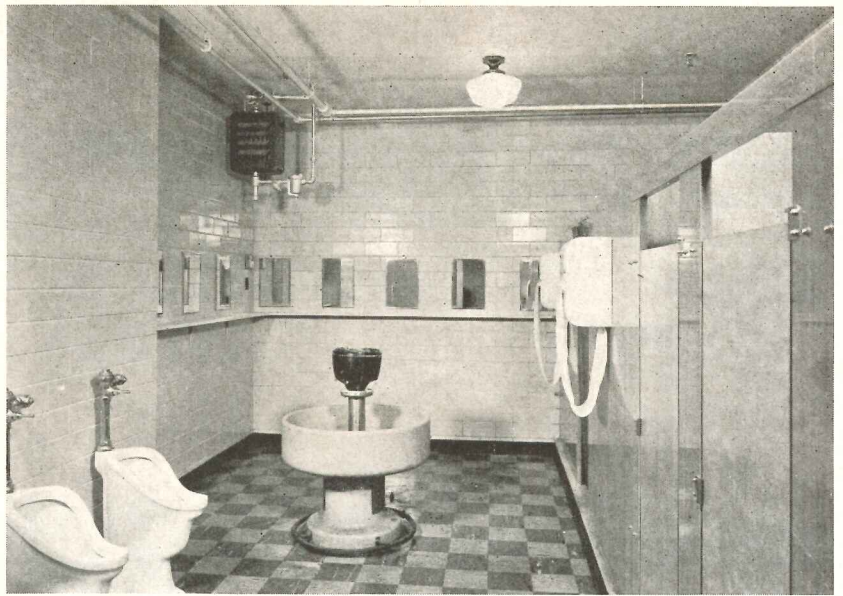
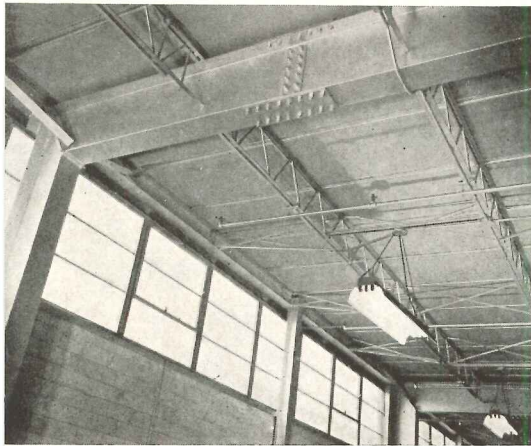


*All manufacturing is done at upper level; scrap paper is chuted down from individual machines, baled at lower level and taken away immediately by truck. Spiral ramp is public and personnel entrance to plant and offices from lower level; ramp takes the place of stairs and an elevator that would otherwise have been necessary. Office areas are air conditioned, air being exhausted from offices to cafeteria, which, being used only an hour and a half a day, does not then require its own cooling system*



Joseph Molitor





*Plant walls are buff structural tile exposed on the inside; in offices and toilets walls are light green structural glazed tile. Plant floors are concrete with a three-quarter-in. pea gravel hard topping; floors in office areas are asphalt and plastic tile*







## FACTORY DESIGNED AROUND MATERIALS HANDLING

*New Plant for The Mennen Company, Morristown, N. J.*

*A. M. Kinney, Inc., Engineers and Architects*

**M**ATERIALS HANDLING efficiency was the central objective in the planning of this new factory; it did not actually take precedence over the manufacturing operation — for the plant introduces many innovations in producing its line of goods — but materials handling did affect the design of the building more than the manufacturing process. The packaging room became the heart of the layout, just as the final assembly line dominates in an automobile factory. Manufacturing is done on the second floor, since most of the ingredients are handled in piping systems. Virtually the whole first floor is warehouse and storage space, the packaging department at one end, the truck docks and railroad siding at the other. As a matter of fact, the huge warehouse area was the principal reason for the building of this new plant, materials and finished product storage having been literally crowded out of the old plant.

The spacious packing room is arranged across a portion of the north end of the warehouse. The exterior

wall, having north light, is constructed entirely of glass block. The entire ceiling is louvered construction with fluorescent lighting above. After considerable study, the packaging lines were disposed in a U pattern, as this scheme greatly shortened trucking distances for packaging materials and finished cartons. The product itself is delivered to the lines by gravity flow from second floor. Thus there is virtually no trucking into the packaging room and it was possible to make it attractive with asphalt tile flooring in color patterns.

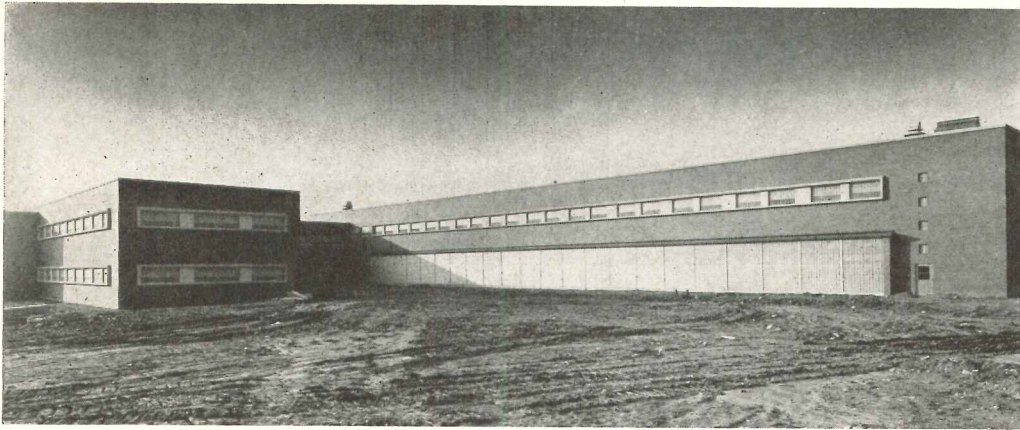
Bay sizes in the warehouse were selected to accommodate two sizes of pallets, 4 by 4 and 3 by 4 ft. Main aisles are 13 ft wide, cross aisles 10 ft, allowing ample maneuvering and passing space for fork lift trucks.

Materials handling equipment in the order make-up section was given considerable study, resulting in the rejection of some of the more complicated systems in favor of simple live roller belt conveyors, these continuing on outward to waiting freight cars or trucks.





*Administration building with its reception room (above) and offices is virtually a separate building at the front, will be given extensive landscaping*



*Packaging room (below), the "heart of the operation," has glass block wall at north side (photo above), louvered ceiling with fluorescent lighting above*



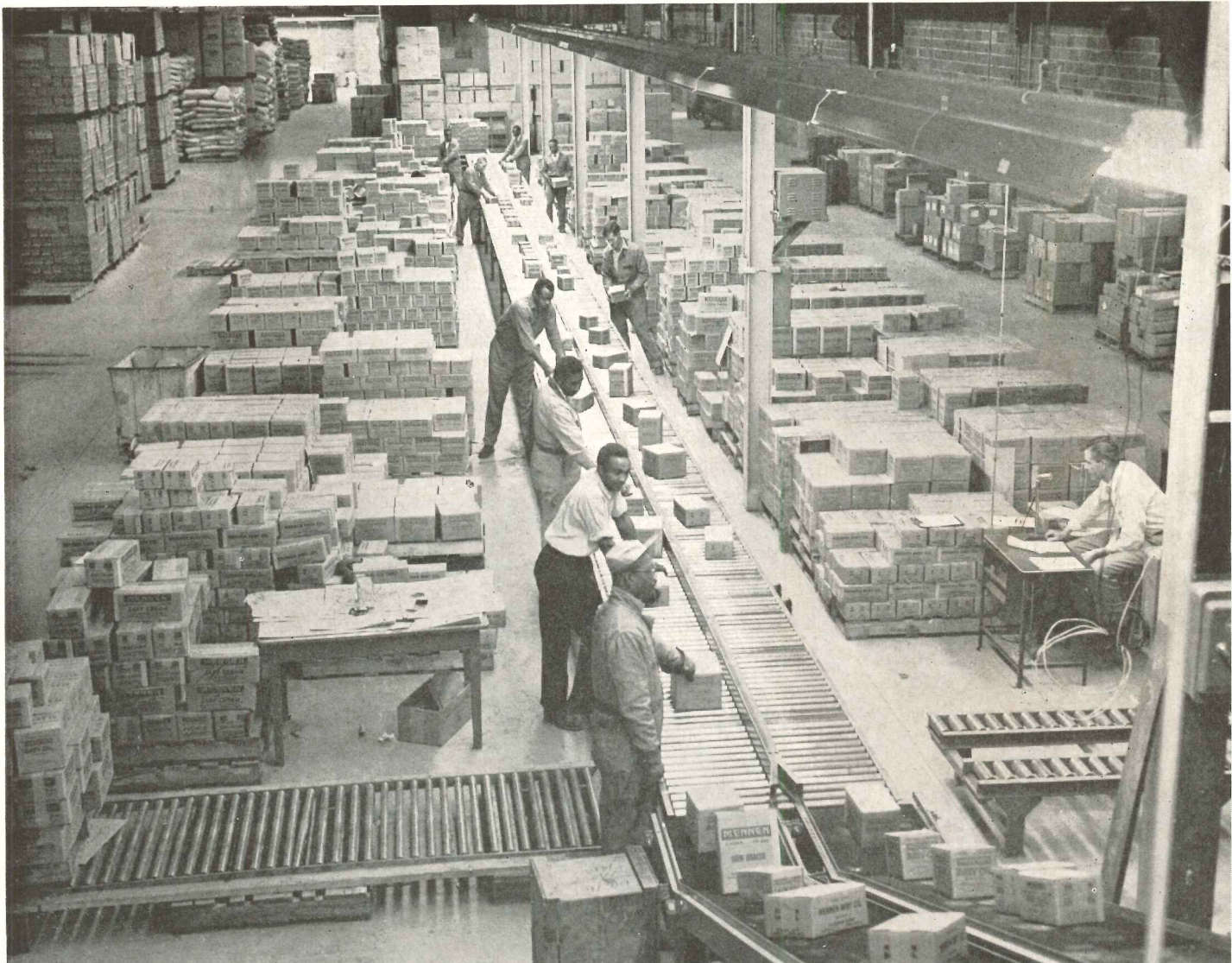
John Albert



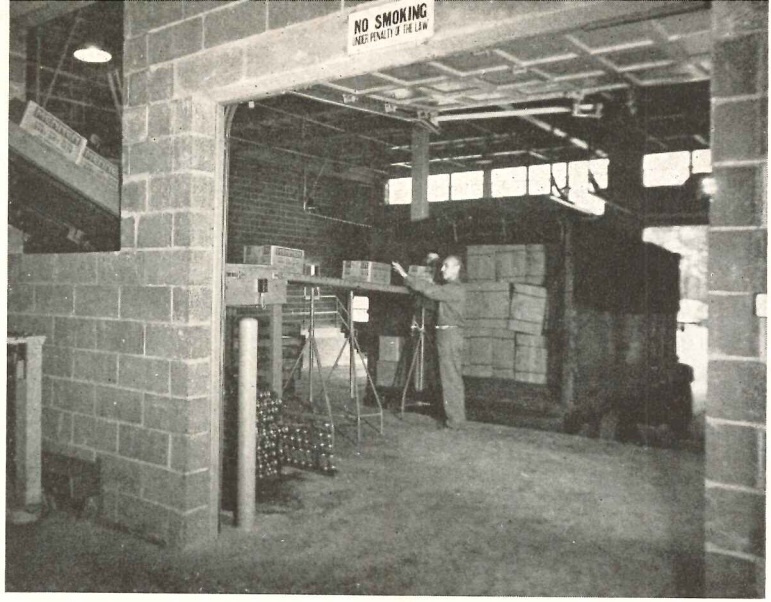


## FACTORIES

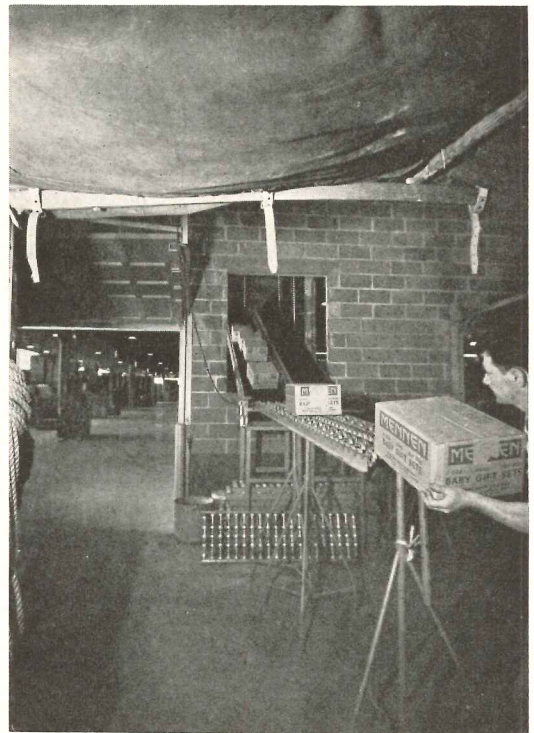
*Only a few raw materials must be transported by truck to second floor manufacturing areas; for this a huge elevator can lift two trucks at once. Other materials can be piped up; finished products go to first floor packaging room by gravity flow. Making up outgoing orders is a highly systematized operation, but is handled on simple live-roller belt conveyors, which go on out to freight cars or trucks to simplify loading*



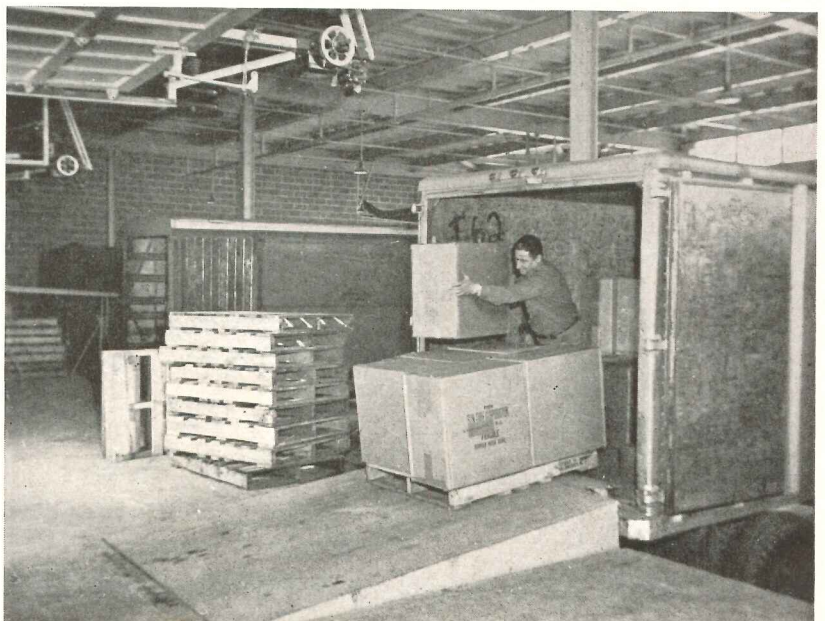




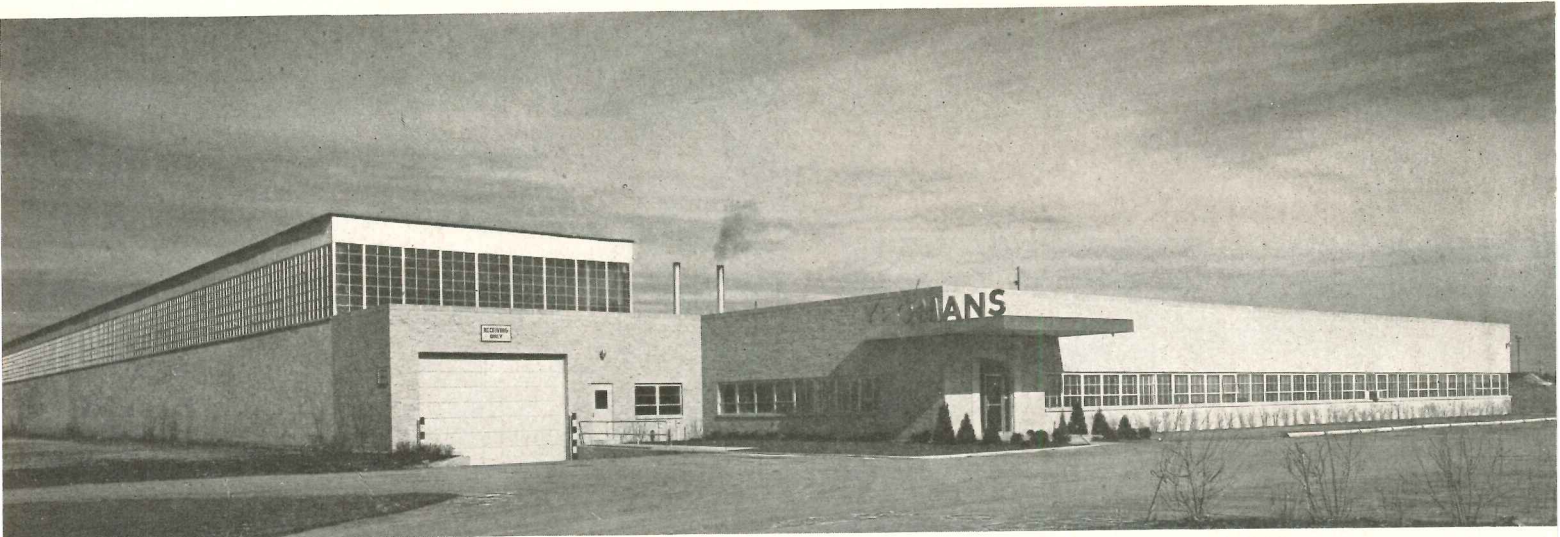
Finished goods are stored in huge warehouse, with carefully arranged categories and aisles for palletized handling by fork lift trucks; thence they go through order make-up room by conveyors right into, trucks



John Albert



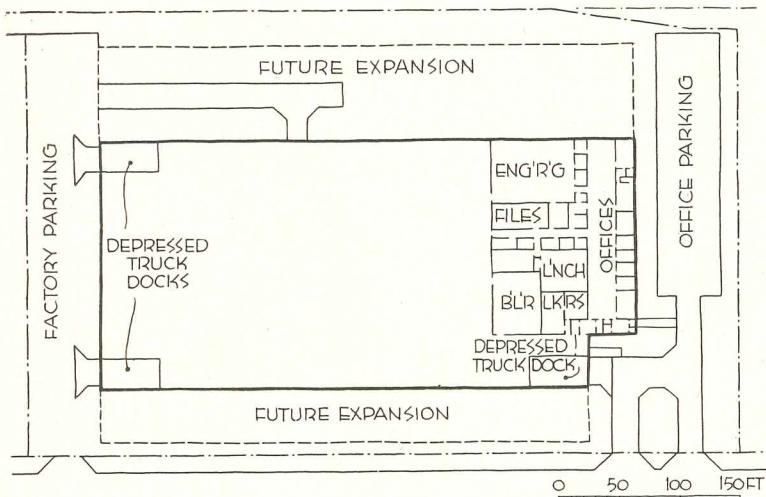




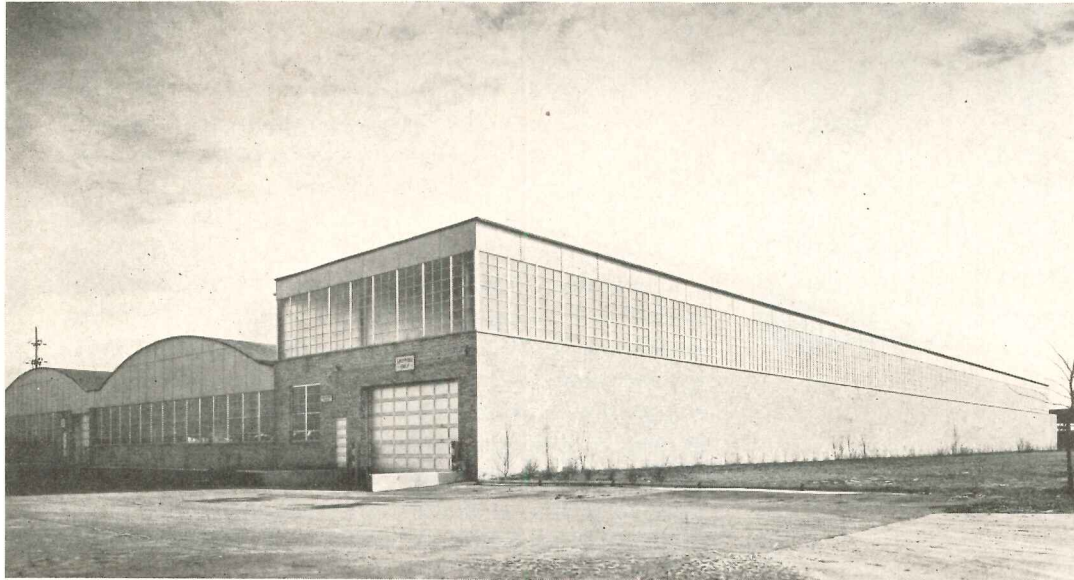
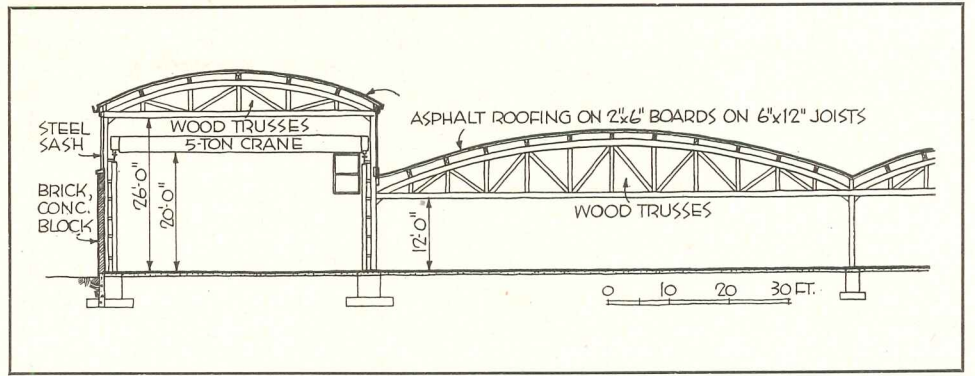
## TYPICAL NEW FACTORY BUILDING AT CLEARING

THIS IS ONE OF SEVERAL new small plants in the Clearing Industrial District, Chicago, an industrial subdivision built around good rail and truck transportation, with scores of small factory buildings all generally economical, clean and functionally designed. This one has wide column spacing — 80 ft — except in the one high bay for crane operation, where the span is 44 ft, with clear ceiling height of 26 ft. The building is planned for expansion in two directions: an additional crane bay to the west, one additional 80-ft bay to reach a future track to the east. Wood trusses were used because this building was constructed at a time when steel was in short supply. The building depends now on trucking for its transportation needs, but a rail siding can be brought in at any time it is required.

*Assembly Building for Yeoman Brothers Company  
Clearing Industrial District, Chicago  
John S. Cromelin, Architect*







Hedrich-Blessing





## FACTORIES



*For Motor Truck Division,  
International Harvester Company  
Fort Wayne, Indiana*

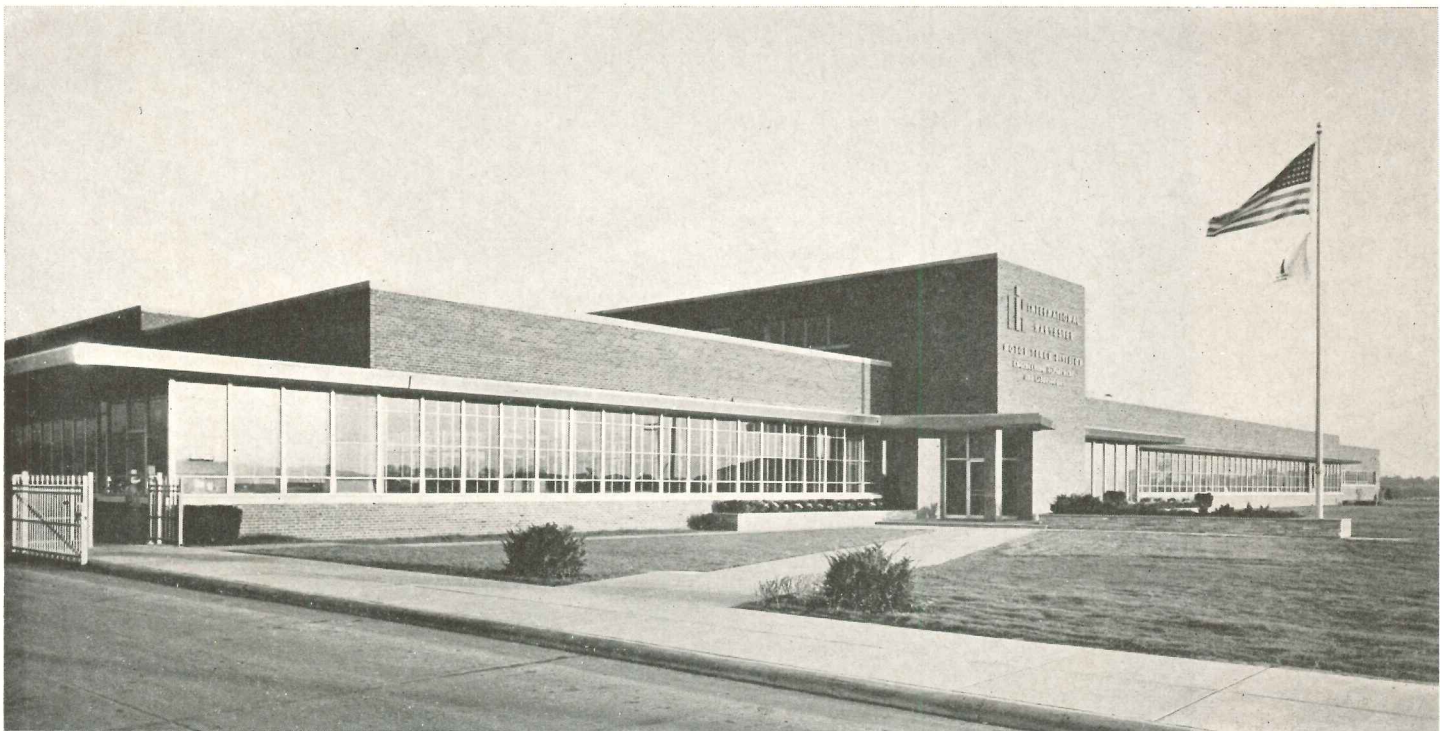
*Albert Kahn Associated Architects and Engineers*

## ENGINEERING AND

**B**UILT for its motor truck division, the International Harvester Company's new \$6,000,000 motor truck engineering and laboratory building is devoted exclusively to research, design, test and development of motor trucks.

The new facility comprises approximately 300,000 sq ft of floor space, on a site of 25 acres. Of brick and steel construction, the building is one-story in height, has three wings and is E-shaped with the segments of the "E" housing the various development areas, including executive offices and drafting operations, road test and experimental shops, engine test cells, transmission and rear axle test cells, and laboratories.

Site preparation for the building included placing approximately 130,000 cu yd of silty blue clay fill from 4 to 8 ft deep. The fill was placed in layers and compacted with sheepsfoot rollers to required 95 per cent density of the Proctor test as modified by the C.A.A. specification. Tests were made of moisture content and compaction, and each layer was placed and compacted at as near optimum moisture content as could be practically obtained in the field. A constant slope was maintained over the entire site during operations to facilitate drainage. Load tests were made which showed that the





# LABORATORY BUILDING FOR TRUCKS



*Courts between the wings of the E-shaped building prove useful for access to various sections and parking space for the trucks under study, also for exterior display purposes. Entire building was placed on fill of silty blue clay compacted by sheepsfoot rollers*



Hedrich-Blessing



## FACTORIES

Above: one of the courts of E-shaped building, toward dynamometer wing.  
Below: view of south court, test area at left, experimental shops at right

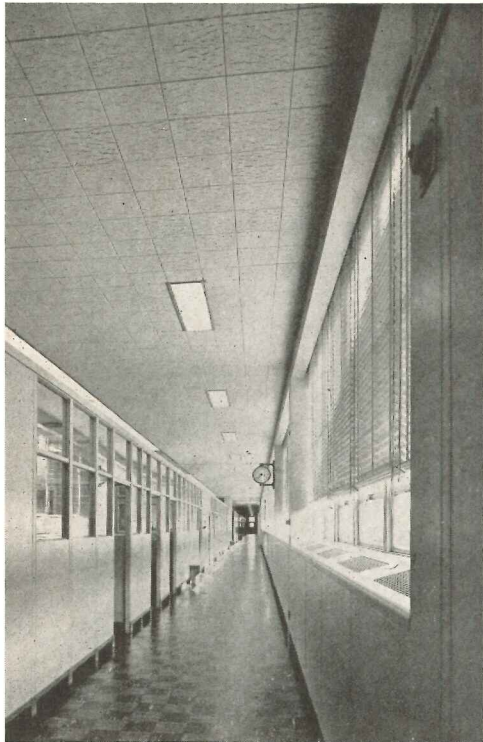
Hedrich-Blessing

Right: guard room and employees' entrance

fill could be safely loaded with 4000 lb per sq ft, with a settlement of not over  $\frac{1}{8}$  in. Accordingly footings were placed in the fill instead of excavating to the natural ground below, with a considerable saving in excavation and concrete work.

Of structural steel frame with truss or beam roof construction, the building has poured gypsum roof slab, with 1 in. of form board insulation covered with composition roofing. Major portion of the exterior walls are of blended red face brick backed up with cement block. Wall surfaces above sash at the road test and experi-





*Drafting room is 420 ft long, 100 ft wide. Overhead lighting, giving 70 foot-candles, was carefully designed to prevent excessive brightness when the eye looks lengthwise of room*



mental shop wing, also fan rooms serving these areas, are gunite on steel frame. Sills and copings are of stone.

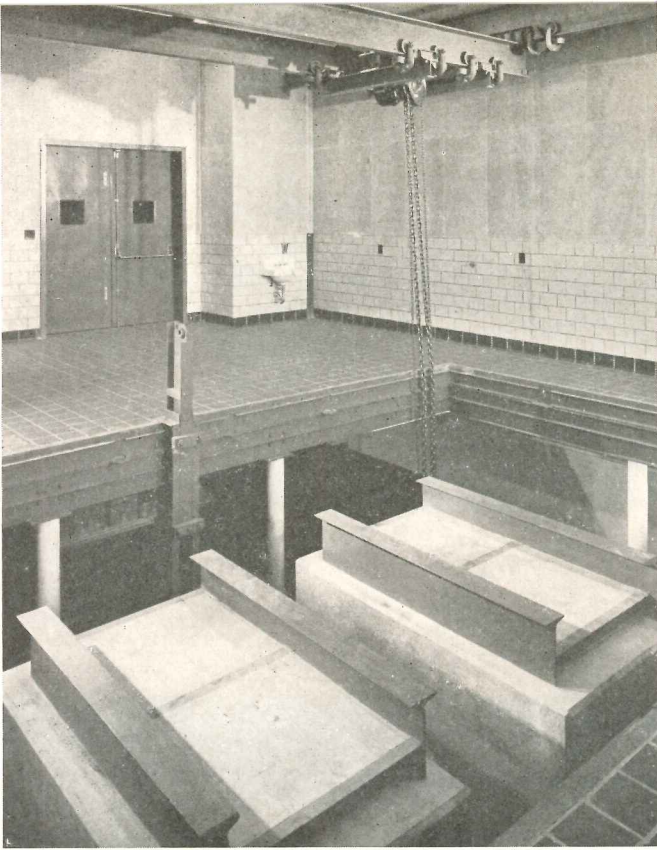
Aluminum projected sash was used throughout the executive and engineering wings, with steel projected sash in the balance of the building. Stainless steel was used at the main entrance, lobby windows and at fascia of canopy along the west elevation.

Suspended ceilings of mineral acoustic tile or sound absorbing blanket with perforated transite or metal pan acoustic tile were used throughout the building except in the road test and experimental shop areas

where roof trusses were exposed. Floors are concrete slab on ground with surface treatment varying with occupancy requirements of the several departments. Creosoted wood block is used in the experimental shops, and separate cement finish of high density and high compressive strength in the road test area.

The drafting room in the engineering wing parallels the north wall which makes possible full use of desirable north light. This room has an unobstructed area 100 ft wide by 420 ft long and 12 ft high, with a portion along the south wall devoted to corridor and engineering

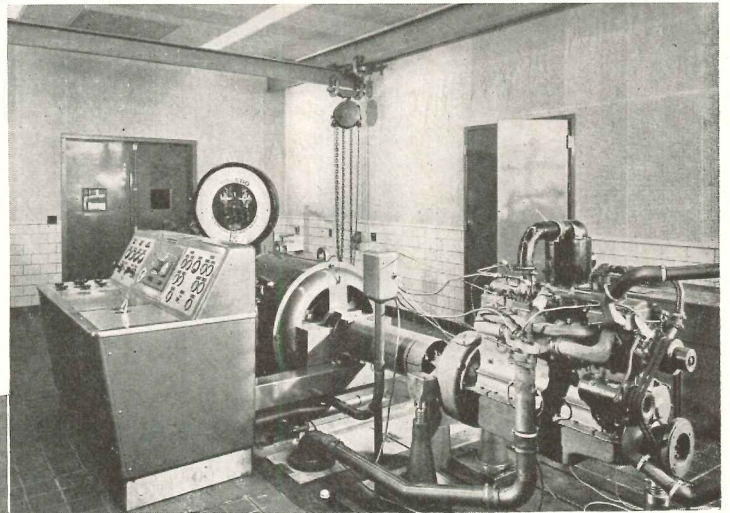




offices formed with metal partitions 9 ft high and open to the ceiling above. The interior face of the exterior walls is finished with flush metal partition wainscot enclosing convector heating units which are so located in relation to sash mullions that partitions may be readily relocated in modular units of 4 ft without disturbing the convector heating system. Color scheme in this area is silver green, window wall a lighter tone.

The drafting room, as described above, is one of the largest designed for this specific purpose, and presented a unique problem of lighting because of its length. Recessed fixtures were most desirable from an architectural point of view, and economy of cost ruled out single tube deep reflectors. The problem was to prevent the cumulative horizontal brightness of the fixtures at one end of the room from becoming so great that it would be a serious cause of eye fatigue to workers seated at the opposite end of the room. The problem was solved by using 2-tube continuous shallow troffers in rows across the room, each troffer having aluminum reflecting surface and aluminum egg-crate louvers with 30 deg shielding crosswise and lengthwise. The maintained lighting intensity is 70 foot-candles.

*In the dynamometer test wing all sorts of strange operations go forward. Above, "typical double end engine development test cell." Right: an engine under test, driving generator; incidentally, generators feed into electrical system, and so put to use power of engines under test. Below: main corridor in dynamometer test wing*



Hedrich-Blessing



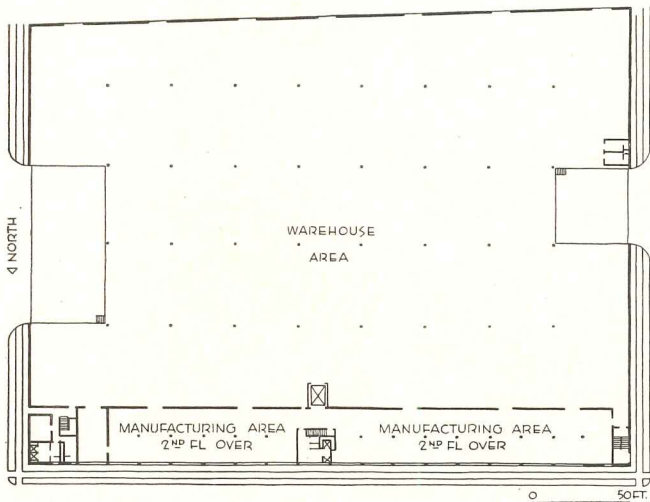
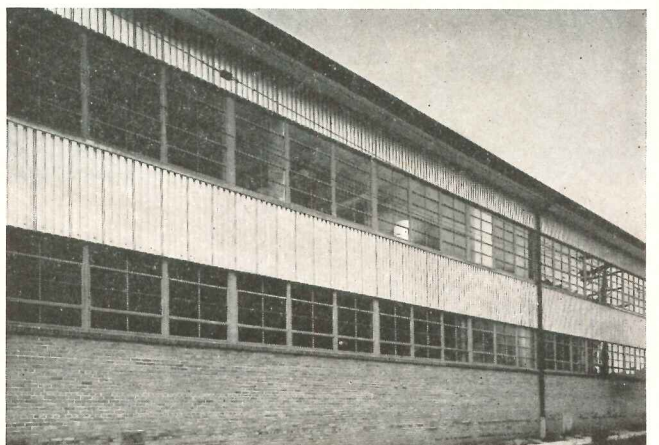
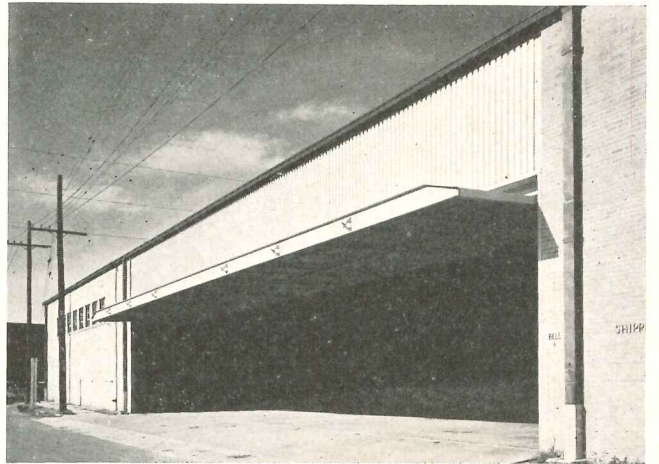
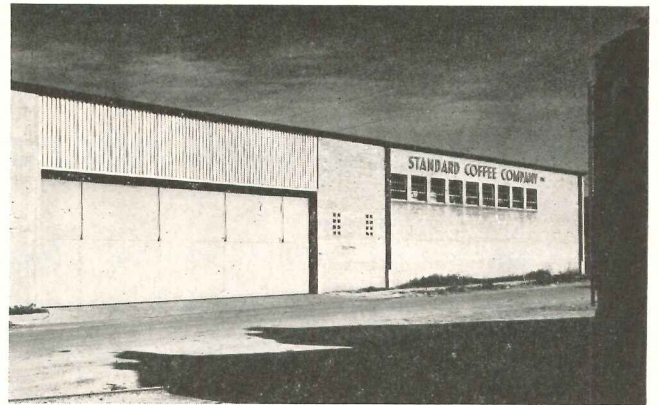


Joseph Mottior

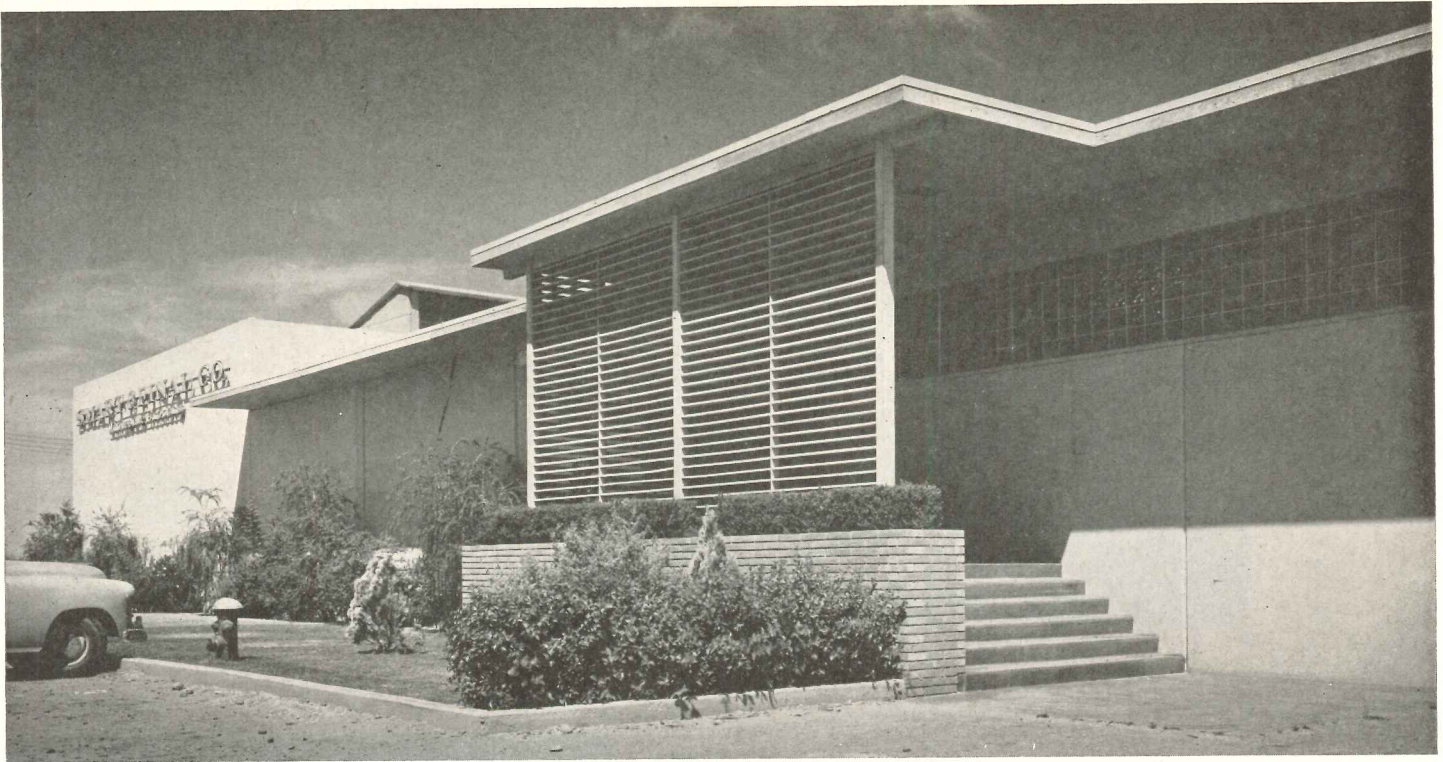
## DISTRIBUTION CENTER FOR HOUSEHOLD GOODS

*Warehouse for Standard Coffee Company,  
New Orleans  
Richard Koch, Architect*

COMPLICATIONS in selling systems, as referred to elsewhere, lead to many different combinations of warehouse, sales and service buildings. This one is a building for a truck-to-door selling system. Coffee and other staples, including blankets and kitchen utensils, are stored here, sent out by large trucks to various selling agents. Small-scale manufacturing is done in the two-story part of the building, but the principal activity is warehousing. The building is located on the water front, and has a rail siding, but three-fourths of its incoming products arrive by truck. Building is done economically but pleasantly with concrete block and brick walls, steel pipe columns, steel beams and joists.



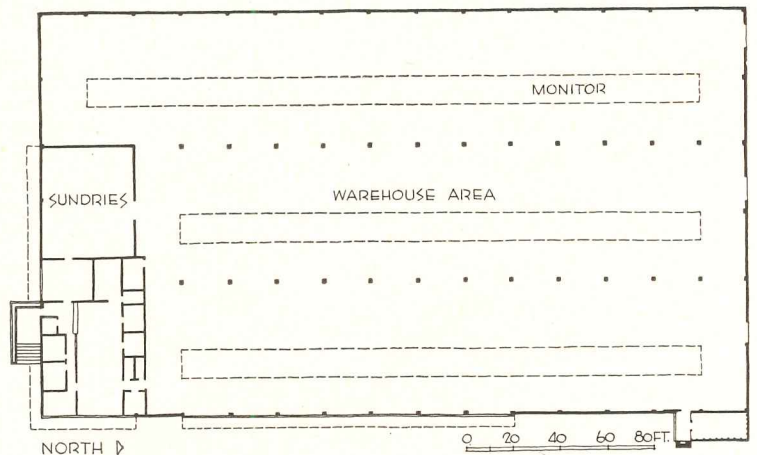




## WAREHOUSE AND OFFICES FOR WHOLESALE GROCER

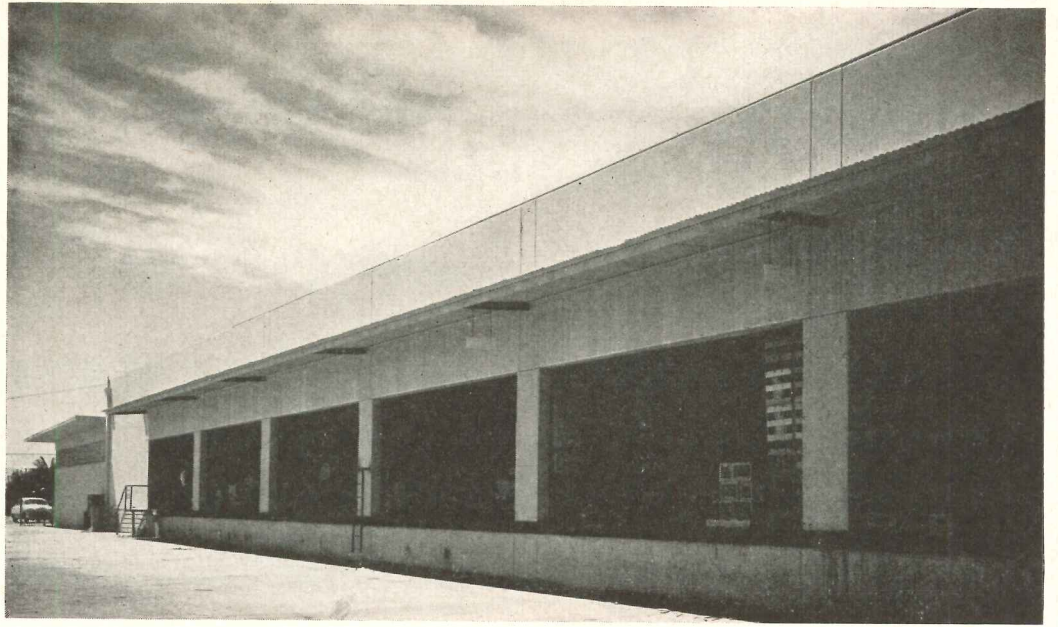
*For Smart & Final Co., Phoenix, Arizona  
McClellan, MacDonald & Markwith, Architects  
Buttress & McClellan, Inc., Contractors*

IN SOME LINES of business, the true wholesale concern seems to have disappeared, but here is one manifestation of a wholesaler who seems to be very much alive. The new building, measuring 100 by 300 ft, is largely warehouse space for grocery products, but there is a small group of offices. While the building is economical, its street front is designed to bring out the office portion, and to take full advantage of advertising value. The structure employs a system of precast concrete panels and welded light steel frame patented by the contracting organization. The 100-ft width of the building is divided into three spans; column spacing in the other direction is 20 ft. Roof is arched over the longer spans, but the arch is modified by monitor sections which run virtually the length of the building.

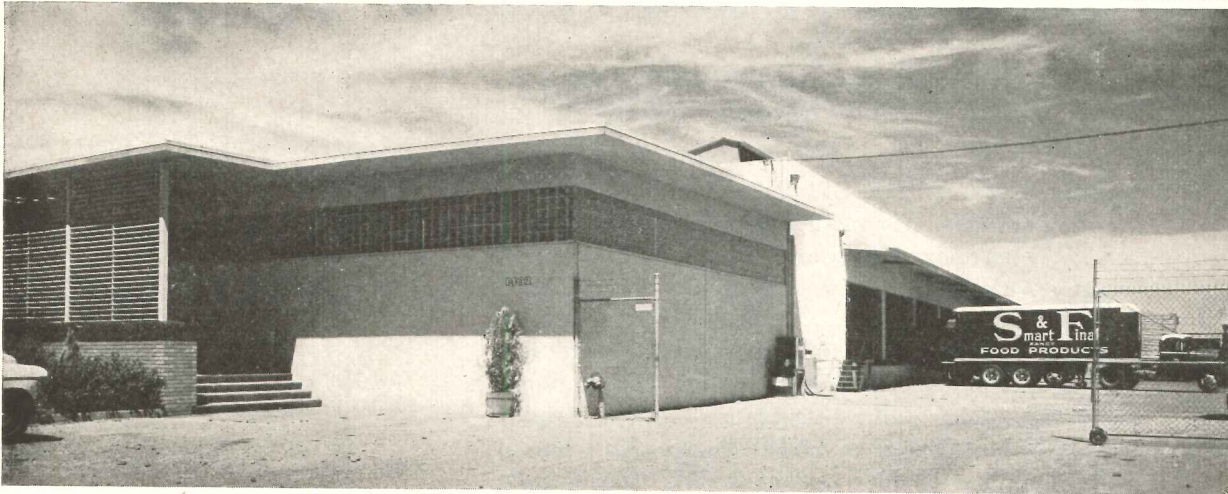




*Truck docks occupy nearly all of one side of the building, each opening being virtually the full space of 20 ft between columns*



Stuart A. Weiner



*Dock openings are closed just by rolled up mesh screens. Interior has 19-ft ceiling, gets daylight from three long monitor sections*



**AUGUST 1953**

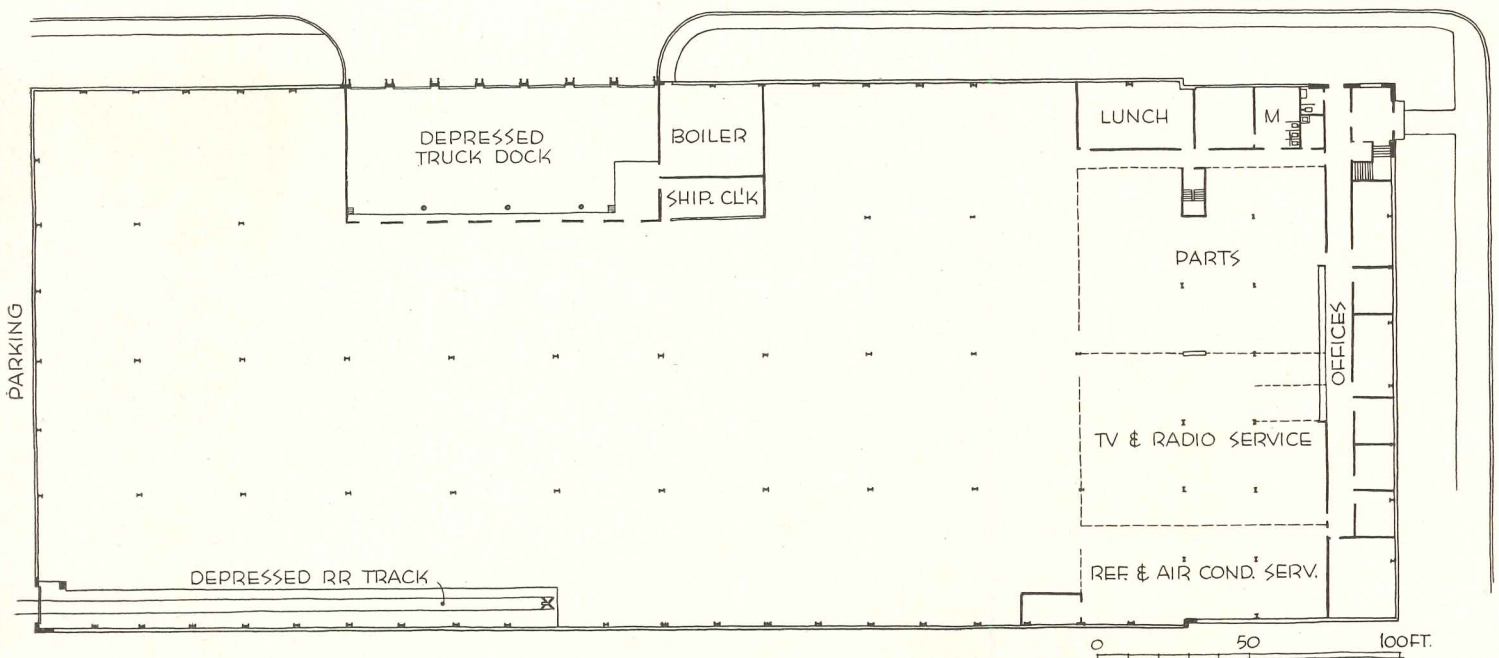
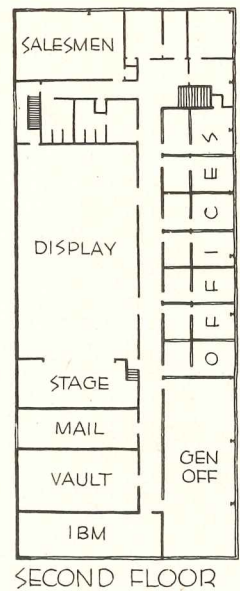




## WAREHOUSE AND OFFICES FOR PHILCO

*Clearing Industrial District, Chicago  
John S. Cromelin, Architect*

A FAIRLY TYPICAL TYPE of building in today's distribution systems, this one houses sales offices, display, service department and warehousing for Philco Distributors, Inc. The warehouse portion is quite large, is served by a railroad siding and a large truck dock. Executive offices are air conditioned with a central system for interior spaces, individual room units in rooms along the outside wall; these are used also as display units, will be replaced as models change. Note line of grills along second floor for air intakes. Construction is of light steel frame, masonry walls, concrete floor.





Hedrich-Blessing





WAREHOUSES

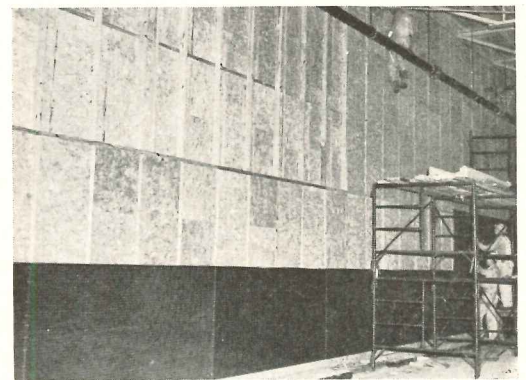
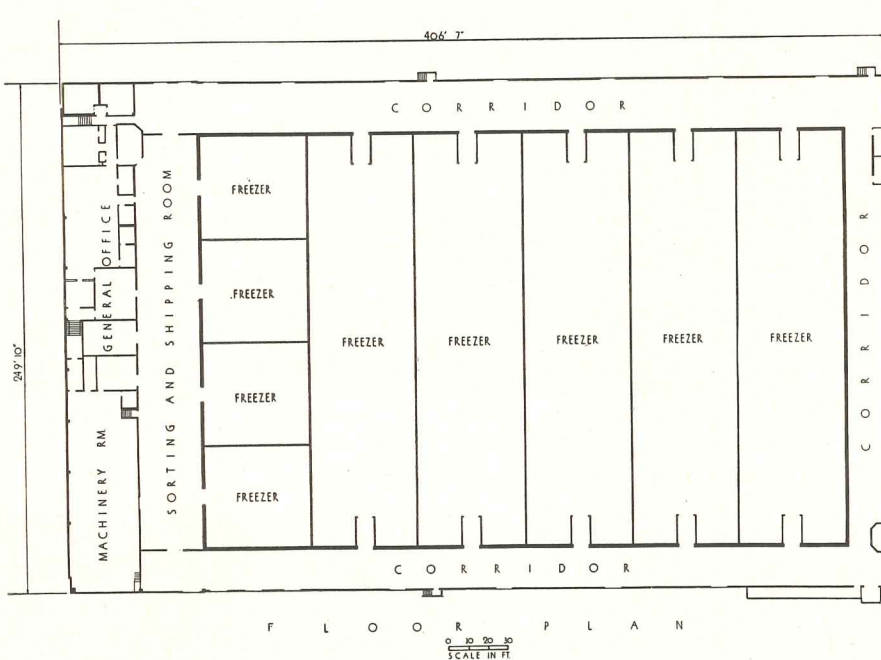
REFRIGERATED WAREHOUSE FOR FROZEN FOODS

*Mid-South Refrigerated Warehouse Company, Memphis, Tenn.*

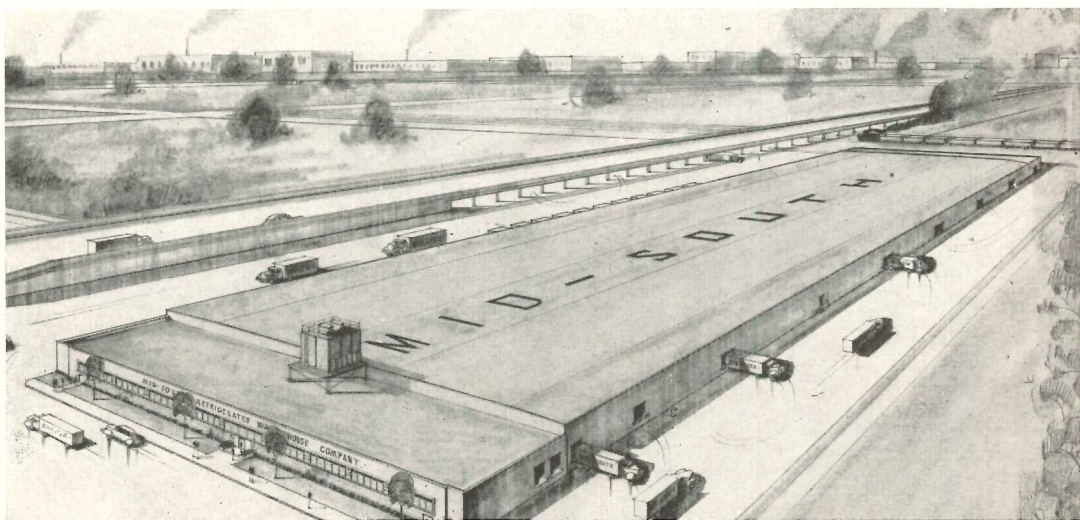
*A. Epstein and Sons, Inc., Architects and Engineers*

THIS IS ONE of seven huge refrigerated warehouses done by this firm of architects, in a rapid expansion of cold storage facilities that is fairly general over the country. This one covers two and a half acres, cost \$2,000,000. It contains 1,300,000 cu ft of freezer capacity, at temperatures down to minus 20 deg. Roof construction is structural steel beams, long-span bar joists and precast concrete slabs. Enclosing walls, both exterior and interior, are tilt-up reinforced concrete 6 in. thick. A dry-wall method of insulation was employed throughout. The concrete tilt-up walls were prepared

with a vapor barrier of laminated foil paper sprayed with asphaltic cement with all laps brush-sealed. Then followed a layer of fiber glass insulation between horizontal girts or walers, with a kraft paper convection barrier at each horizontal joint. A second layer was then installed level with blocking to receive outer studs. Then vertical studs were attached to the walers, and a third layer of insulation added between studs. Then a layer of 1/8-in. hardboard completed the inner side. Walls then have 8 in. of fiber glass insulation, with vapor barrier on the outside; 10 in. of insulation on the ceiling.



*Building is group of huge deep-freeze rooms surrounded by corridors and loading docks. A nice problem was to keep floors from heaving due to frost formation in sub-soil. A grid of vitrified tile, acting as air ducts, was installed under heavily insulated concrete floor. Thermocouples show when temperature drops to freezing, when heated air is introduced into the ducts*





# ARCHITECTURAL ENGINEERING

## TRUCK TERMINALS



Riss Motor Freight Terminal, Boston, Mass.

Gottcho-Schleisner

## PART 1

### DESIGN SUGGESTIONS FOR TRUCK TERMINALS

*Site Engineering*

*Dock Dimensions and Layout*

*Materials Handling Techniques*

*Communications Systems*

## PART 2

### THREE TERMINALS: STUDIES, EXPERIENCE AID PLANNING

*Analyses of existing terminals, past experience and knowledge of materials handling were guides for greater efficiency and more economical construction*

#### INTRODUCTION

WITH INDUSTRY becoming more decentralized and moving into new areas, the trucking business is becoming increasingly important in our economy and to the architect. To take care of the increased shipping by truck, between 60 and 70 million dollars were spent in 1952 for truck terminals.\*

Many of these terminals were designed with the services of an architect, but it is possible that this type of building has escaped the attention of some architects, since terminals may be grouped unconsciously with warehousing. Although there are obvious similarities, there are many differences that bear investigation,

mainly due to the fact that freight generally arrives and leaves the same day.

The trucking industry has developed many standards in facilities and equipment through the aid of personnel trained in terminal operations and management, assistance from materials handling consultants, and experience, but there are still features that call for the aid of an architect.

Some of the aspects of truck terminal design include: (1) site selection, (2) circulation patterns for the site and truck dock, (3) estimation of required dock dimensions, (4) design of office,

dormitory and feeding facilities, (5) selection of economical construction systems and materials, (6) layout of communications systems.

There is evidence that as trucking terminals increase in number, size and complexity, the trucking industry is becoming more conscious of terminal appearance and engineering and is developing an increasing awareness of community relations. All this adds up to further opportunities for the architect, in cities and towns of all sizes.

\* Figures from American Trucking Association, Inc.



## PART 1 | DESIGN SUGGESTIONS

This portion has been condensed from the manual, "Principles of Freight Terminal Operations," prepared by Drake, Startzman, Sheahan and Barclay, Distribution and Materials Handling Consultants for the Common Carrier Conference of the American Trucking Associations, Inc. The consultants studied some 20 terminals of every size and type across the country. All sorts of handling systems were encountered, tonnage and man hours measured and costs computed. At the conclusion of the field surveys, data and information were evaluated to find the best methods and techniques for the industry

*Note: The Terminal Operations Council of the American Trucking Associations, Inc. is planning to issue shortly a manual, "Planning the Truck Terminal"*

### Site Selection

The site must accommodate: (1) a dock for handling freight transfer and temporary storage, (2) a shop, (3) a parking area for trucks, (4) apron areas for maneuvering, (5) driveways and (6) office space. Minimum requirements include the dock, aprons and driveways.

After land cost, site development, and zoning regulations have been investigated, the following terminal operations must be analyzed in selecting the site: (1) proximity to pickups, deliveries and connecting trucking firms, (2) accessibility to roads, (3) traffic

congestion and obstructions such as bridges and railroad crossings, (4) transportation for employees, (5) available utilities.

Travel distance to and from major customers should be studied: i.e., consignees; shippers; and connecting carriers, affiliated trucking companies and warehouses.

A study should be made to determine the best location for customer service. This can be done by dividing the area served into sections according to pickup routes, listing the tonnage picked up and delivered in each section, and then

determining a ton-mile figure for each proposed site. But even if one site has a low ton-mile rating, it may be inaccessible or in a heavily congested area.

### Dock Position

The weather will dictate to a great extent the dock position on the site. The length of the dock should run in the direction of the prevailing wind, if space is available, and if traffic and expansion requirement can be met. Claims and rehandling can be reduced if the end of the dock faces driving wind, rain or snow.

## PART 2 | THREE TERMINALS

*Starts on page 178*



**Central Freight Lines Inc., Dallas, p. 180.** Designed to transfer huge quantities of freight—6 million lb every 24 hr—terminal materials handling system is expedited by extensive communications and an underfloor conveyor

**Yellow Transit Freight Lines, Chicago, p. 182.** One of two new terminals at the Clearing Industrial District, it is an economical prototype design using long span steel joists



**Transcon Lines, Los Angeles, p. 178.** Main feature is the suspended wooden roof which has a 35-ft overhang, shielding trucks from hot sun. Two years of planning, including a tour of major terminals, helped simplify and streamline operating procedures





Another decision to be made is whether the trailer trucks or pickup trucks should be nearest the street if the site borders on one street only. If there is enough space on the side away from the street, road equipment (trailer trucks) should be located there. The street side should be assigned to pickup and local delivery activity because of the higher turnover.

### Approach to the Dock

There should be easy access into the terminal for all trucks. As sizes of trucks and trailer equipment increase, maneuvering space increases. This is largely dependent on: (1) overall length of the tractor-trailer unit, (2) the width of the position into which the vehicle must move (called spotting), (3) the turning radius of the tractor. (Most trucks and trailers are 8-ft wide.)

The width of this dock position affects not only the yard area for maneuvering, but is also a factor in column spacing and location and width of aisles in addition to the area available for storing freight. For example, a 12-ft space (or position) will give a dock operation which uses pallets 30 per cent more storage than a 10-ft position. The 12-ft position is the best for most terminals since a narrower one may result in occasional damage to equipment and takes more time for maneuvering.

Turning radii of tractor-trucks have a definite bearing on space required for maneuvering as indicated by the table in Fig. 1.

### Other Site Problems

**Grading.** Roofs and canopies should not be drained into truck positions in front of the dock. The site should be graded so that there will be no danger of freight falling from trucks backing into dock position; also when tractor and trailer slopes vary, these units are difficult to couple. Sharp grades cause difficulty in maneuvering and in poor traction if there is ice or snow.

**Location of Shop.** The value of a nearby shop will vary with the terminal operation and its location within the particular trucking system. Some terminals have major maintenance and repairs, while others are equipped to handle only emergency or minor jobs. The closer the shop to the dock, the better, without interference with other yard requirements or causing traffic congestion.

**Truck Parking in the Yard.** The peak number of trucks to be parked simul-

taneously will determine the area required. Pickup loads sometimes accumulate in a parking area because of insufficient space at the dock. It is important that the travel time be as small as possible. Also security is improved if the parking area is close to the main terminal activity.

**Paving.** Good paving saves money on equipment repair and claim expense. Paving should be designed for local soil and wheel load conditions by a competent engineer. Generally, paving for 18,000-lb axle loads on most topsoils should not be less than a 6-in. thickness of 2000-lb concrete reinforced with 6 by 6 in. No. 8 wire mesh and provided with expansion fillers on 30-ft. centers; or 8-in. crushed rock or clean road gravel and 1½ in. of hot- or cold-rolled asphalt topping. If asphalt is used, concrete should be provided where trailer landing gear rests on the ground.

**Fences.** Fencing will provide protection for loads parked overnight. It should be high enough to prevent freight from being thrown over, and heavy enough to prevent holes from being cut. Bumpers made of heavy timbers or utility poles will prevent vehicles from backing into the fence. Vertical supports of heavy pipe or rail sections driven into the ground will hold the bumper in place.

### Dock Design

**Column Spacing.** This is related to the width of truck positions at the dock, working area and aisles, and storage space. The ideal freight dock should be free of columns except at the outer edge. If columns in the working area cannot be avoided, they should be of steel or concrete rather than wood.

The columns should be on 24-ft centers to allow 12 ft for each of two road trucks. Then three spaces will be available for pickup equipment.

**Doors.** If all freight is cleared at the

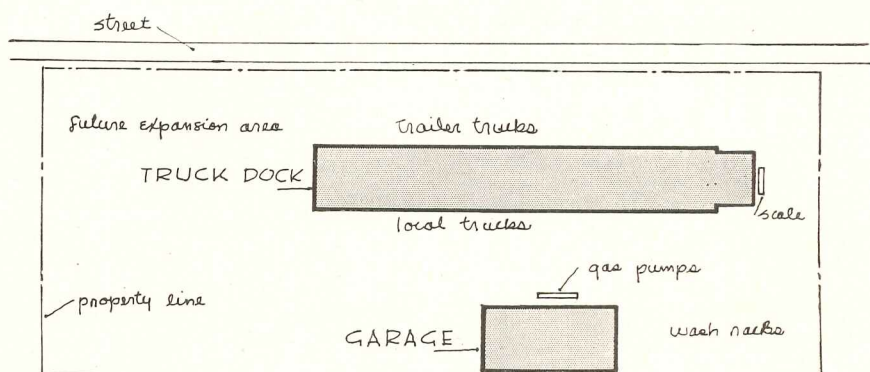
end of the working day, and nothing is stored that may be stolen or damaged by the weather, doors are not necessary. If doors are provided, either 10- or 20-ft units can be installed if the columns are centered at 24 ft. Most terminals are standardized on 10-ft doors. If the door hardware is not carefully located, it may be possible for the fork trucks to run into the tracks. In some cases, docks are designed to allow the doors to roll out under the roof overhang.

**Ceiling Height.** Requirements for overhead clearance vary depending on the type of operation and the amount of freight to be stored. A manual operation will be limited by the reach of the worker in stacking the freight, and clearance should be at least 7 ft. When fork lift trucks can be used effectively, at least a 9-ft stack is required, but recommended clearance is 12 ft where much freight is stored.

**Roof Overhang.** Canopies or roof overhangs should be as wide as possible consistent with sound building practice. Additional construction costs are offset in the long run by reductions in claims due to reductions in damaged freight and improved morale, stimulated by improved working conditions. Trailers left in the open can build up temperatures 20 degrees higher than the outside air, which can mean lowered working efficiency and possible spoilage of perishables.

**Floors.** The most practical material for docks is reinforced concrete. A fine float finish provides a good surface for fork trucks. Carborundum or metal filings used in the concrete for surfacing adds longevity and improves traction.

When the dock floor is built on fill, condensation can be reduced by providing a 6-in. layer of coarse granular fill under the slab. If there is air under the slab it should be circulated to help achieve the same result.

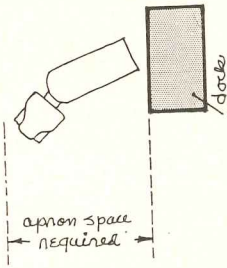


BASIC ELEMENTS OF A TRUCK TERMINAL

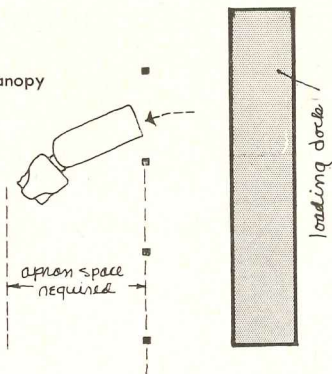


**MANEUVERING SPACE FOR TRAILER TRUCKS**

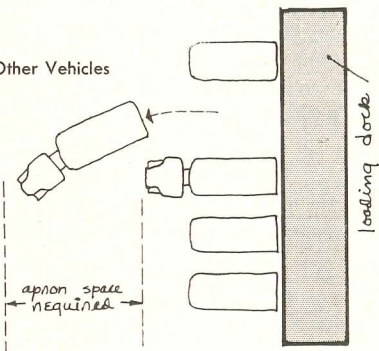
Unobstructed Dock



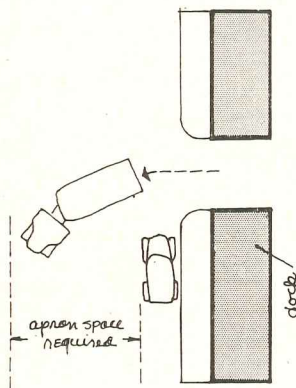
Post-supported Canopy



Alongside Other Vehicles



Driveways and Stalls



**Dock Dimensions — Height.** The distance between the pavement and floor level of heavy duty transport equipment averages 51 in. Depending on the type of road equipment used, the dock height will vary between 50 and 54 in. Preliminary construction standards of the American Trucking Associations, Inc. recommend a standardized height of 52 in. on the trailer side.

Sufficient dock space should be allocated to light trucks, depending on the activity of such equipment. A height of 45 in. will be satisfactory for most pickup operations; however, the equipment should be measured.

The apron may be tapered down toward the dock to compensate for extreme variations between body and dock height. But the rain may run down the trailer and drop on the freight unless a rubber sill is provided on top of the trailer to divert the water to the sides.

Timber bumper guards prevent damage to the dock and should be attached by countersunk bolts so that sections may be replaced. Steel capping may be attached to the top of the timber to lengthen its life.

Several methods have been devised to overcome difference in height between the dock and the vehicle, ranging from smooth pieces of boilerplate to hydraulic leveling devices, either built into the dock itself or into the pavement.

**Dock Length.** The principal determinant of length is the number of trucks to be spotted (parked) at one time at the dock. The prime factor establishing the width is the quantity of freight to be loaded. Factors involved in dock length include (1) number of outbound schedules, (2) number of pickup routes, (3) characteristics of the freight, and (4) interline policy of the company (interline freight is that delivered to or received from another carrier).

The number of outbound trailers or trucks spotted for each schedule of freight plus the number of pickup trucks and other inbound trucks unloaded at the same time will frequently determine the maximum truck positions and thus the dock length.

Another factor is the amount of transfer or intraline freight handled. (Intraline freight comes in on one segment of a trucking system and is transferred to another.) If an outbound truck is always available, the freight can be moved from the inbound truck to the outbound without moving it across the dock.

Also to be considered is the policy on delivery of interline freight. At some

terminals, all or part of the freight may be held on the dock awaiting pickup. In other cases it may be delivered to the carrier, eliminating dock storage. Sometimes the freight is loaded directly into equipment of the foreign carrier at the dock, so that additional loading spots will be required.

Dock length can be computed on the basis of the maximum number of trucks to be spotted at one time multiplied by the 12-ft position allowance.

**Dock Width.** After the fixed installations have been located on the dock, the width required is determined by the peak storage and whether or not special materials handling equipment is used.

At small terminals, 45-ft wide docks are usually sufficient. For fork lift truck operation a 60 to 70 ft dock is suitable. If a dragline conveyor is used, the dock will be wider generally as the equipment itself takes away 5 ft of dock space and 5 ft either side of the dragline should be left free. If a dragline is used with way station freight, the suggested width is 80 ft; if no way freight is handled, a 60 ft dock is adequate.

Storage requirements are at a maximum if the trucks are to drop off a number of different shipments en route, since all freight must be stored on the dock until all shipments are ready, and then loaded in reverse order. (This is called peddle freight when it is loaded in customer order for delivery directly from the loaded vehicle. It is called way station or block loading when trucks are loaded in sections for drop-offs en route; each section contains one or more shipments.)

In addition to truck position space and storage requirements, the dock requires aisle space for hand trucks and motorized fork trucks. If the dock is operated with two-wheeled hand truck equipment, cross aisles of 3½ ft and side aisles of 5 ft should be used. If the dock uses a fork truck and pallet system, cross aisles should be at least 10 ft wide and side aisles 12 ft. The same dimensions should apply for four-wheeled hand truck equipment.

**Dock Layout.** The dock requires aisles for the flow of traffic and storage space for freight. At least one such aisle should serve two vehicles. In this case it should be at the center of the 24-ft double vehicle position and have a 10-ft width.

The most efficient layout for finding shipments has single rows of pallets on each side of the aisle. With larger requirements, it is necessary to use multiple rows, and more pallets must be

Length of Tractor and Trailer, ft	Truck Dock Space O-C, ft	Apron Space, ft
35	10	46
	12	43
	14	39
40	10	48
	12	44
	14	42
45	10	57
	12	49
	14	48



moved to reach the desired shipment. The most practical arrangement is the double row of pallets. This should be used for peddle freight where the identity of each shipment is important.

### Materials Handling

The three basic factors to be analyzed are: (1) function of the terminal, (2) tonnage to be handled, (3) size of the dock.

**Function of Terminal.** The volume of freight that must be held on the dock before reloading is important in determining the best handling system. The simplest problem in freight handling is the transfer operation. Freight is unloaded, sorted or checked and reloaded directly into another truck which has a single destination. No freight is floored because sequence loading is unnecessary. The operation is essentially continuous from truck to truck.

At the other extreme is the distribution operation where mixed freight is unloaded and loaded in customer order. This requires the flooring or temporary storage of virtually all shipments.

Between these two extremes is the operation requiring the unloading of mixed freight and reloading in station sequence (each station has a number of shipments). At least one station can be loaded directly as it is unloaded. Segregation of the balance of the freight is required only by station.

In the transfer operation there is no storage factor, and the handling system can be selected without regard to it. In the distribution operation the handling system must be efficient from a storage standpoint.

**Tonnage.** The volume of freight handled over the dock should include the inbound, transfer or intraline, interline and outbound traffic actually handled over the dock.

**Size.** Since the size of the dock determines travel distance, it directly affects the type of handling system to be used. Pickup truck and road truck loading and unloading should be centralized at the dock location giving the shortest travel distance.

**Handling Systems.** There are three to choose from: (1) two-wheeled hand truck, (2) the fork truck and pallet, and (3) the dragline conveyor.

Two-wheeled hand trucks should be used where the volume is small, travel short and storage relatively unimportant.

The fork truck and pallet system should be selected when the volume is

less than 300,000 lb per day and the freight must be floored prior to loading.

Maximum advantage is obtained from a dragline when it is used for transfer of freight direct from pickup trucks to the outbound road trucks. The dragline conveyor is operated by a powered chain or cable that runs overhead or in the floor pulling carts from one area to another, and can be adjusted to operate at various speeds.

The dragline is less well suited to peddle freight, but when there are peddle routes, the freight can be handled in a different way. For example, freight can be stacked on the carts so that it does not take much storage space. Another method is to stack the freight on pallets which are put on the carts and then stored by fork trucks.

In the floor-type of dragline, the chain or cable runs in a trench approxi-

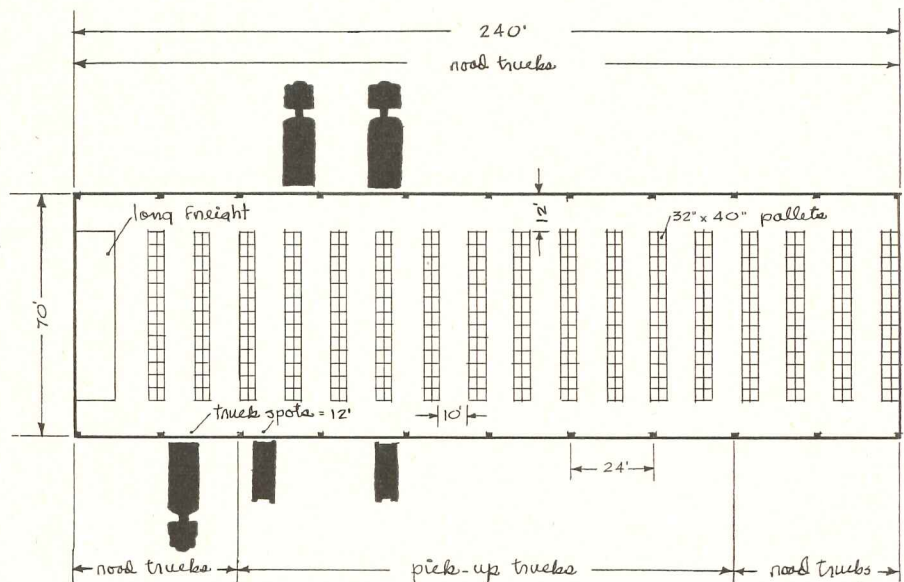
mately 12 in. square, covered except for a small slot through which a pin from the cart is dropped to engage the line. The dragline can follow any route, but the chain must be continuous for the system to be practical for terminals.

Although there are mixed feelings among terminal operators about the use of dragline conveyors, it is possible to make this generalization: the floor-type dragline has several advantages over the overhead type. There are no overhead obstructions and the carts are easier to couple. However the installation cost of the overhead dragline is less.

For direct transfer from pickup trucks to road trucks, the dragline should be set in 14 ft from the edge of the dock on both sides.

For peddle freight storage, the freight may be stored inside the dragline. Another method is to run the dragline

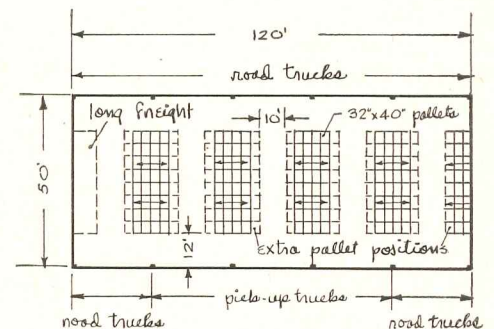
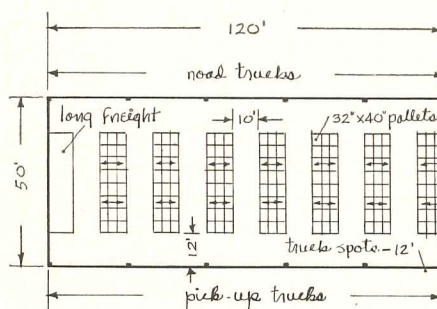
(Continued on page 194)



#### THREE TYPES OF FORK TRUCK AND PALLET STORAGE

1. Above: Peddle and delivery loading where each pallet must be identified easily. (Tonnage approx. 600,000 lb per day)
2. Below, left: Combination peddle and way station loading where larger groups of pallets must be identified. (Tonnage approx. 250,000 lb per day)
3. Below, right: Block or way station loading—one shipment is a group of pallets—showing maximum use of storage. (Tonnage approx. 300,000 lb per day)

Note: pallet positions indicate maximum dock storage. All positions should seldom be filled





PART 2 | THREE TERMINALS



Robert C. Cleveland

TRANSCON LINES  
Los Angeles, Calif.

Allison & Rible, Architects  
Ropp & Ropp, Structural Engineers

Two years of planning, including a study of truck terminals across the country, turned out a handsome, functional terminal, whose main feature is a 35-ft canopy guarding against the weather

ECONOMICAL CONSTRUCTION, saving of steel, and streamlined operating procedures were the architects' primary concerns in their studies for this trim, wide-canopied terminal.

The client desired an economical roof structure that would cantilever over 30-ft long trailers, eliminating columns in the path of the trucks. The result was a wooden roof hung from two rows of steel columns and spanning the 70-ft dock. Columns along the length of the dock are spaced 22 ft on center which is enough room for two trucks.

In examining truck terminals across the country, Architect Ulysses Floyd Rible did not note any universal pattern of design. He felt the need for more attention to such administrative procedures as integration of paper work with the checking of truck shipments. Also he found divergent viewpoints in the location of special facilities such as

the O.S. & D. room (over, short, and damaged freight), in the location and size of maintenance and repair service, and in the choice of materials handling systems.

Since Transcon Lines, which also has terminals in Oklahoma, Kansas and Illinois, is constantly expanding, the site was planned to allow for future additions. Now there are docking space, offices, maintenance shops and enough parking for more than 200 vehicles.

Roof Structure

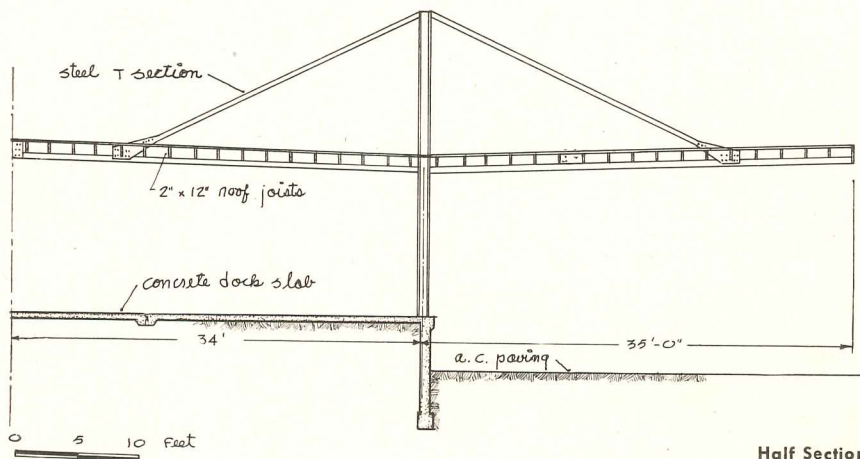
Steel "T" sections hang from the two-story-high columns to resist both the vertical load and uplift. The hangers are then connected to 45-ft wood girders. Heel connections of the columns were designed to take both the vertical load and horizontal thrust of the girders, and the columns themselves were designed to resist the moments induced

by wind or seismic forces. Three-quarter in. rods give longitudinal bracing.

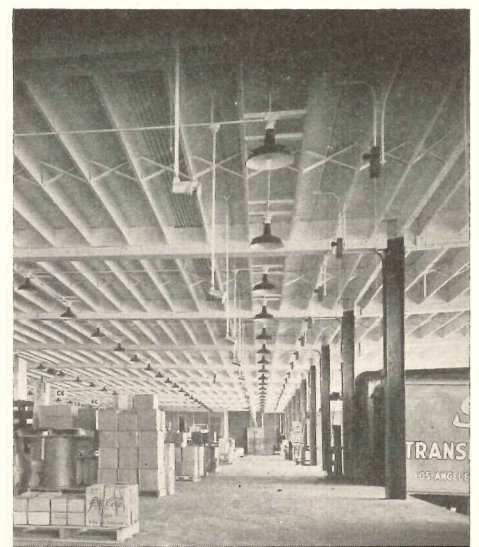
Under equal loading, the load of the 35-ft canopy balances the load of the 35-ft interior half span. Under transverse horizontal load, the downward force of one interior half span balances the upward force of the adjacent span, reacting like a three-hinged arch. The column bases were pinned in this direction.

This design permitted a large overhang without expensive trusswork; steel, critical in supply at the time, was saved. The overhang provides protection from sun and rain for a total of 44 carriers which can be spotted simultaneously.

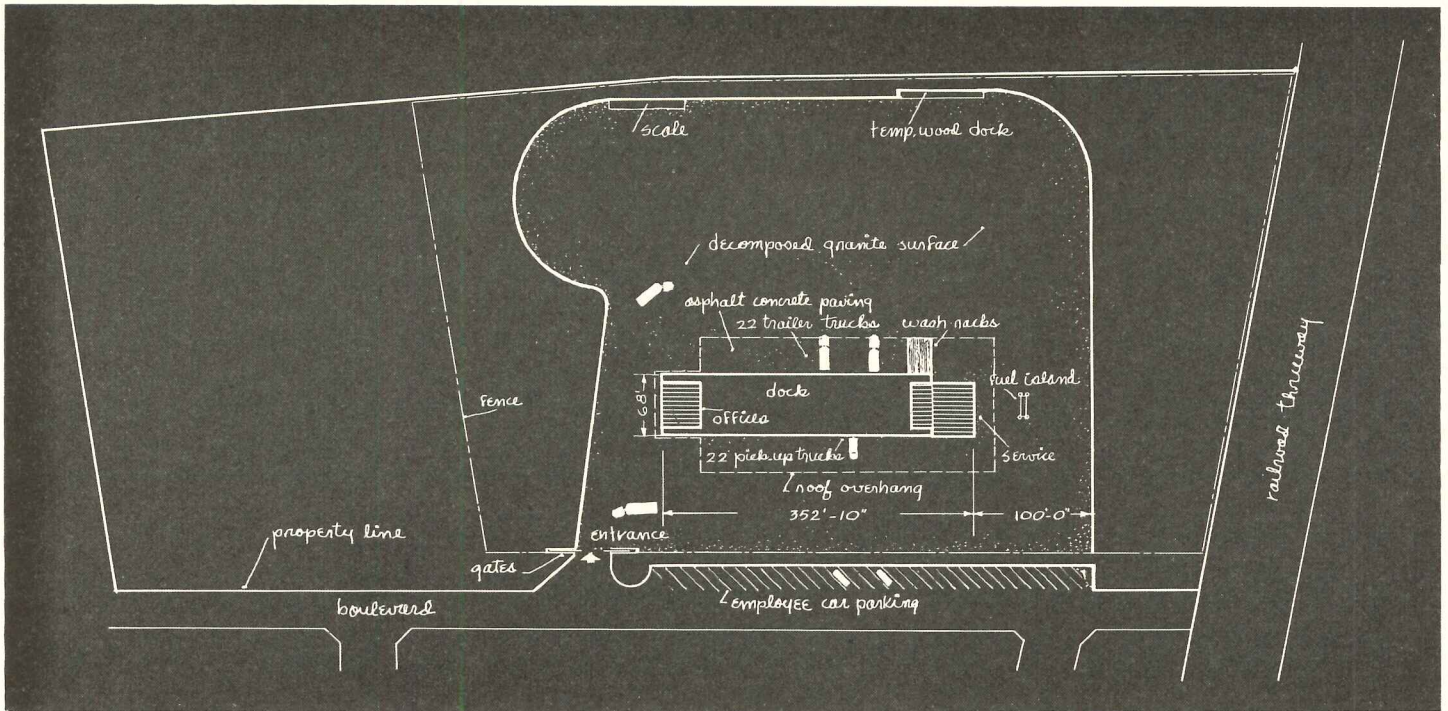
Consultants were: Ropp & Ropp, structural engineers; Stephen T. Berky, mechanical engineer; and Foster K. Sampson, electrical engineer. The contractors were Jones Brothers Construction Co.



Half Section







▲ Enclosed area adjacent service area has Gear Room, Bond Room (for drugs, liquors, etc.) and O.S. & D. Room (over, short and damaged freight)

#### DOCK DIMENSIONS

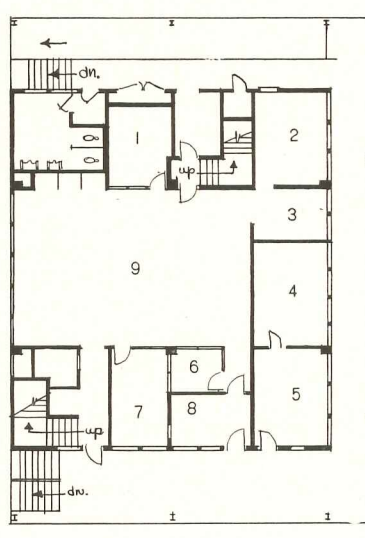
Width 70 ft

Height

Pickup side 44½ in.

Trailer side 52 in.

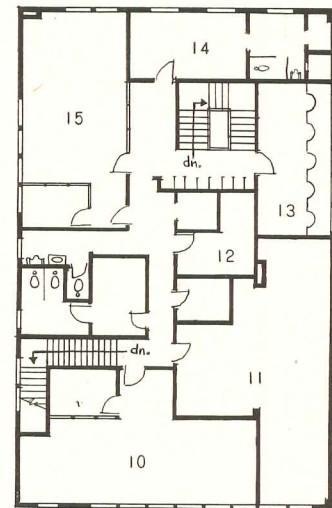
Roof Overhang 35 ft



#### OFFICE FACILITIES

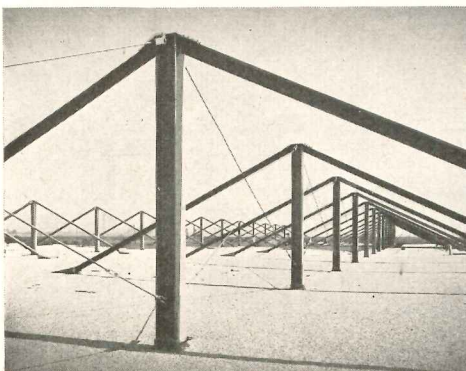
##### First Floor

- |                                 |                    |
|---------------------------------|--------------------|
| 1. TWX Room<br>(Message Center) | 5. Foreman         |
| 2. Billing                      | 6. Office Mgr.     |
| 3. Cashier                      | 7. Terminal Mgr.   |
| 4. Telephone Rm.                | 8. Operations Mgr. |
|                                 | 9. Office          |



##### Second Floor

- |                         |                                |
|-------------------------|--------------------------------|
| 10. Salesman            | 14. Line Drivers<br>Locker Rm. |
| 11. Records             | 15. Transp. Dept.              |
| 12. Heater Rm.          |                                |
| 13. Central<br>Checking |                                |



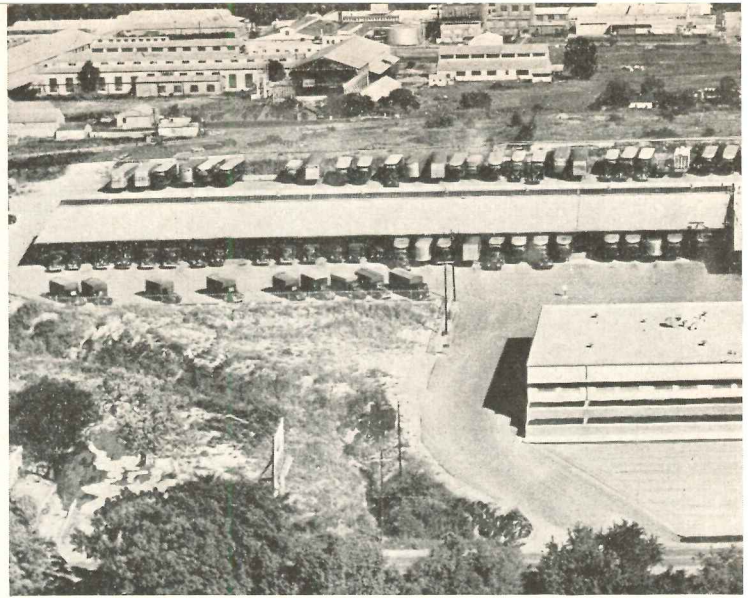
◀ Suspended from the ceiling are floodlights to illuminate truck interiors and signal lights (in front of columns) for loaders to call fork lift trucks





CENTRAL FREIGHT LINES INC.,  
Dallas, Texas

Handling of freight is expedited by an extensive communications system and an underfloor conveyor



SIX MILLION POUNDS of freight can be transferred from truck to truck at Central's huge Dallas terminal which has nearly 48,000 sq ft of dock space. Office and maintenance buildings are detached from the dock, making it possible for trucks to park around the entire perimeter. A total of 110 trucks can be loaded and unloaded at one time.

**Communications**

An underground passageway and a pneumatic tube system connect the terminal with the office building. The pneumatic tubes are used on the dock to transfer papers between "loaders" at the trucks and checkers in a mezzanine office suspended from the roof. Other parts of the communications system include: (1) two-way voice contact between loaders carrying portable inter-

com units which plug in at jacks on the columns, and a selected checker in one of the four central checking offices; (2) signal lights to call fork lift truck operators to various truck spots; and (3) selective two-way contact between three permanently located remote stations. (For further information on how such a system works, see "Communications" in Part I, p. 194).

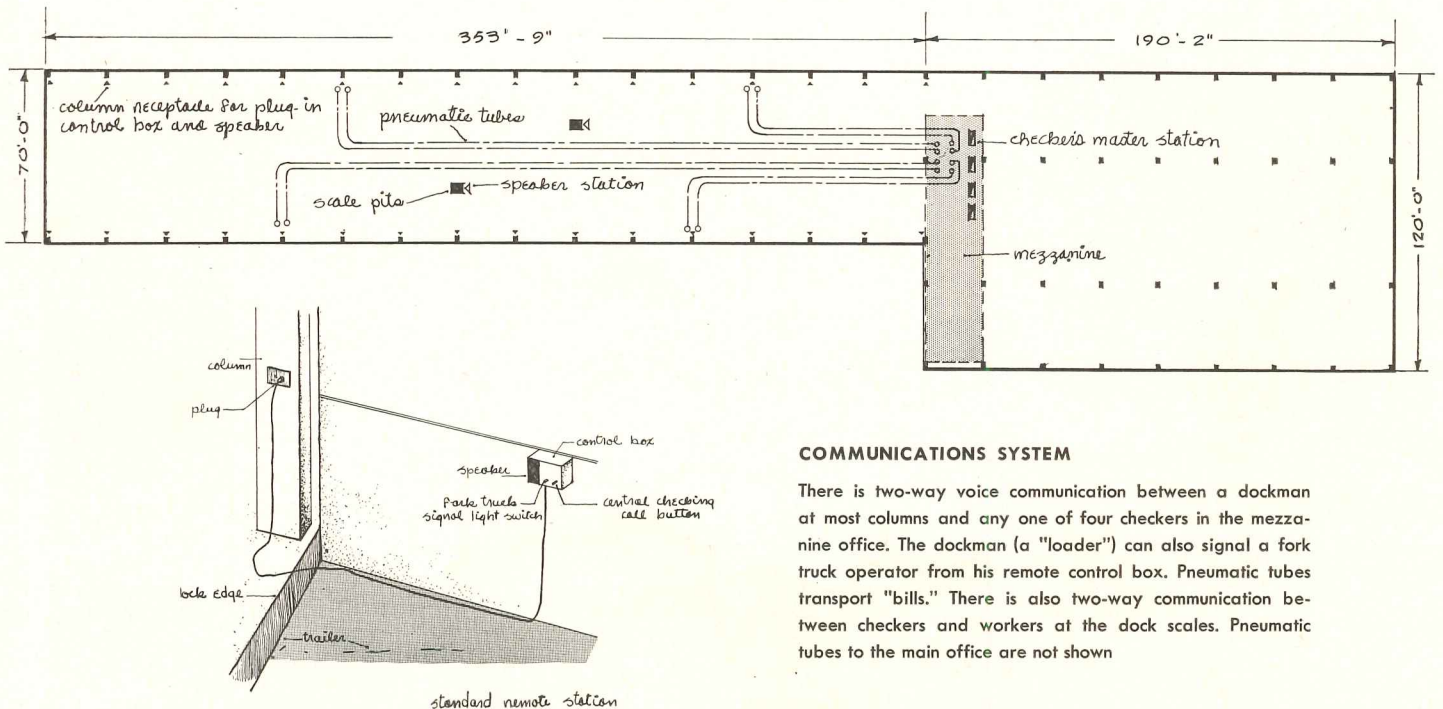
**Conveyor**

The dragline conveyor consists of a moving endless chain installed under the floor to pull a stream of pallet-sized carts. These can be slipped on and off the chain very readily by means of movable pins. In this way various pieces of freight can be mechanically shuttled from one truck to another with a bare minimum of manpower.

The dock structure is reinforced concrete with long-span channel slabs of concrete for the roof. The roof overhang forms a canopy which projects more than half a truck length. Floodlights are located under the eaves.

The one-story administrative building is of reinforced concrete and has year-round air conditioning. Facilities include, in addition to office space, a living room with two bedrooms for company personnel, combination cafeteria-meeting room accommodating 90 people, and a soundproofed dormitory for drivers.

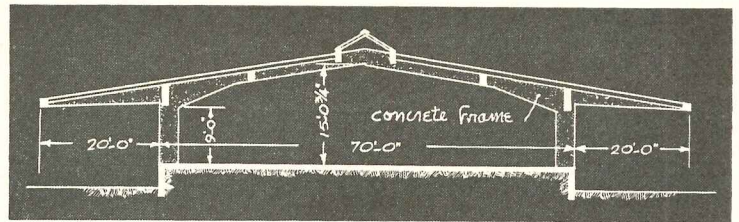
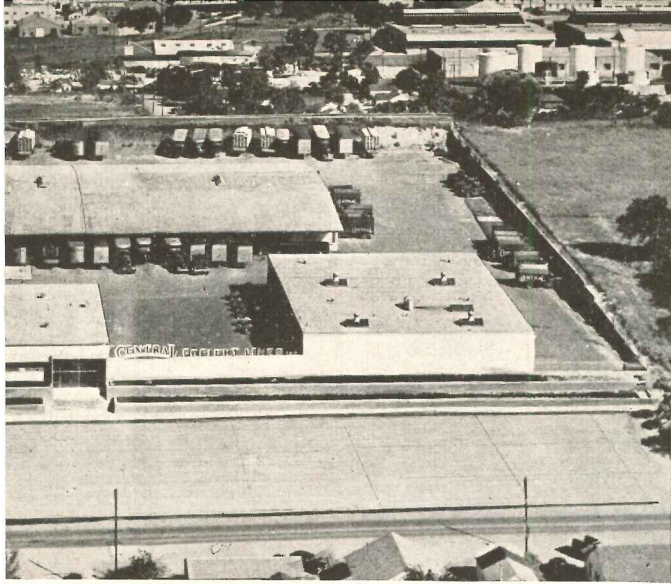
Nearby the office is a garage for speedy overhaul and maintenance of both gasoline and diesel trucks. The terminal was designed by engineers of Central Lines assisted by W. E. Lessing, Architect.



**COMMUNICATIONS SYSTEM**

There is two-way voice communication between a dockman at most columns and any one of four checkers in the mezzanine office. The dockman (a "loader") can also signal a fork truck operator from his remote control box. Pneumatic tubes transport "bills." There is also two-way communication between checkers and workers at the dock scales. Pneumatic tubes to the main office are not shown





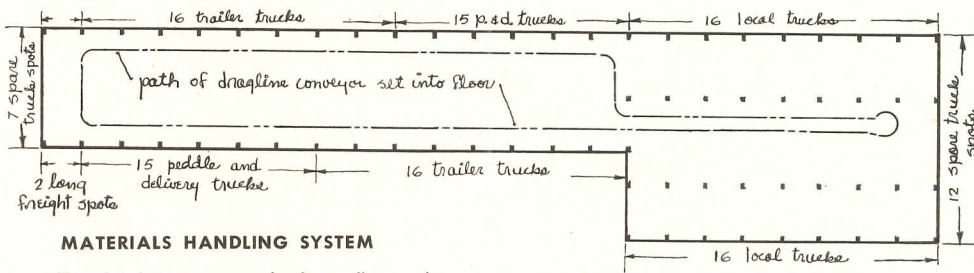
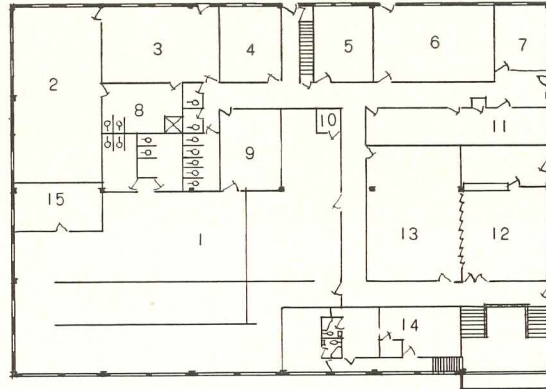
**DOCK DIMENSIONS**

Width 70 ft, 120 ft

Height 48 in.

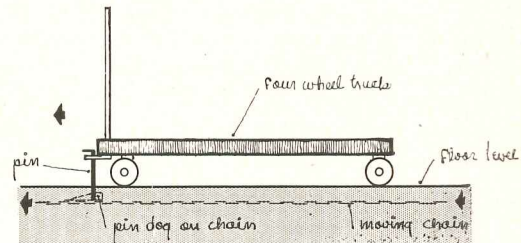
**OFFICE FACILITIES**

- |                               |                            |
|-------------------------------|----------------------------|
| 1. Gen. office                | 8. Line Drivers Locker Rm. |
| 2. Dormitory                  | 9. Machine Rm.             |
| 3. Line Drivers Ready Rm.     | 10. Tele. Oper.            |
| 4. Line Dispatcher            | 11. Confer. Rm.            |
| 5. Peddle and Del. Dispatcher | 12. Cafeteria              |
| 6. P & D Driver Ready Rm.     | 13. Meeting Rm.            |
| 7. Manager                    | 14. LR & BR                |
|                               | 15. File Rm.               |



**MATERIALS HANDLING SYSTEM**

The dragline conveyor shuttles pallet-sized carts from one truck to another. At the wide end, freight is worked out from the center to the pickup trucks



Squire Haskins





YELLOW TRANSIT FREIGHT LINES, Chicago, Ill. John S. Cromelin, Architect Clearing Industrial District, Inc.



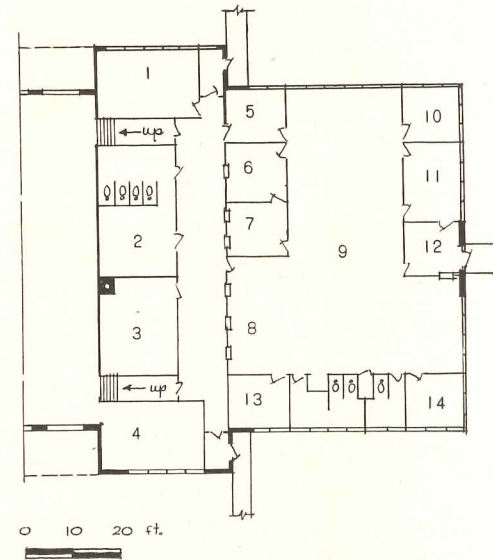
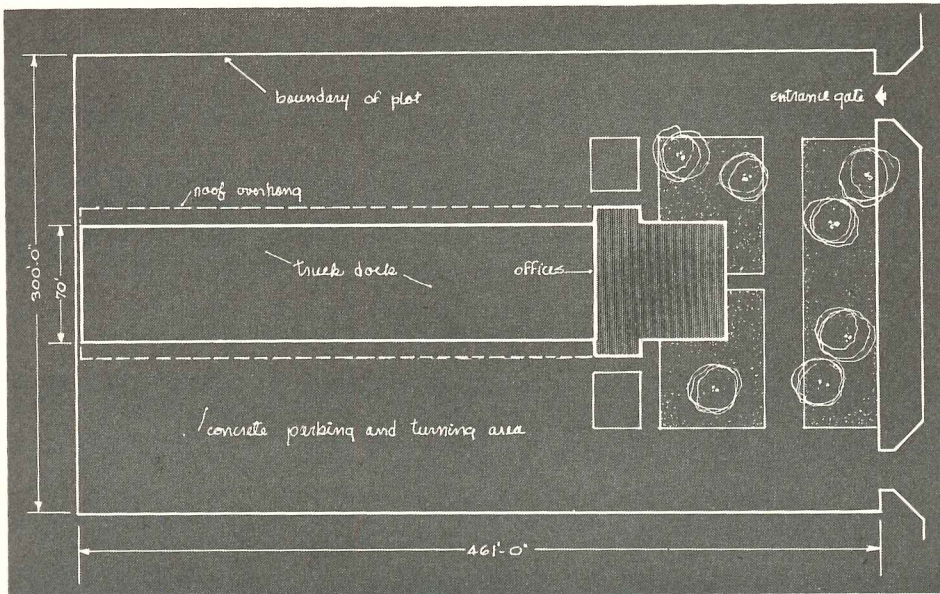
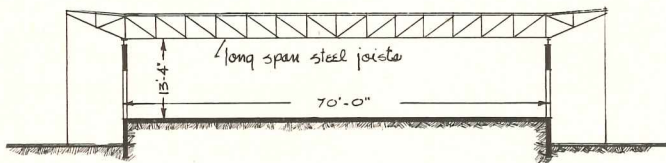
Hedrich-Blessing

A prototype design using long-span steel joists and brick walls for economy

LONG-SPAN steel joists carrying a pre-cast slab roof cover the 70-ft dock of Yellow Transit's brand new terminal. Another terminal nearby for Doyle Freight Lines is practically a duplicate.

A total of 54 truck spots are provided. The dock is divided alphabetically and doors are numbered for easy location and storage of freight. Wood overhead doors are 8 by 8 ft and 11 ft on center. Dock length is 300 ft.

Like many terminals, the office is at one end of the dock. A small service building is several hundred feet from the other end of the dock.

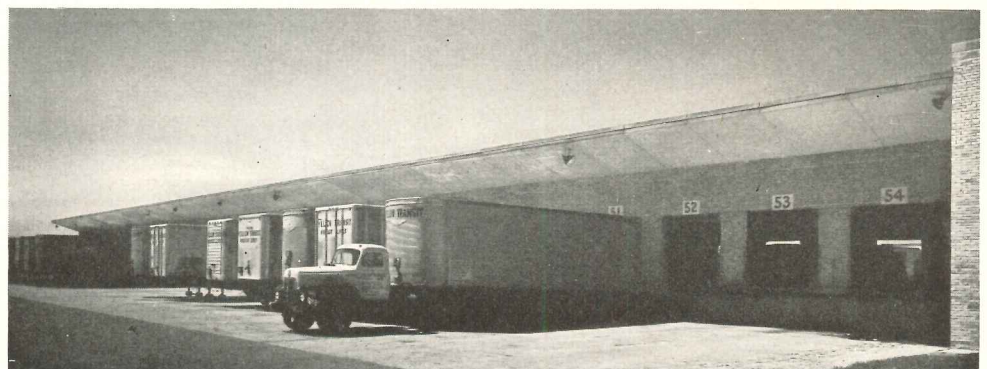


**OFFICE FACILITIES**

- |                             |                          |
|-----------------------------|--------------------------|
| 1. Lunch Rm.                | 8. Communication Windows |
| 2. Locker Rm.               | 9. Gen. Office           |
| 3. Air Cond. and Boiler Rm. | 10. Asst. Mgr.           |
| 4. O.S. & D. Stor.          | 11. Term. Mgr.           |
| 5. Dock Supt.               | 12. Lobby                |
| 6. Checkers                 | 13. Storage              |
| 7. Dispatchers              | 14. Exec. Office         |

**DOCK DIMENSIONS**

Width	70 ft
Height	51 in.
Length	300 ft
Roof overhang	9 ft

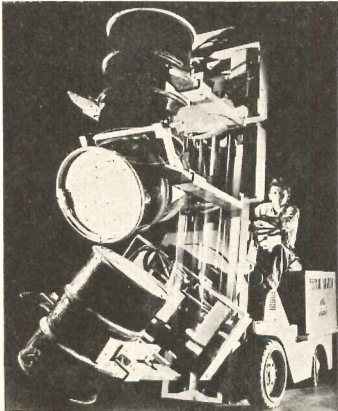




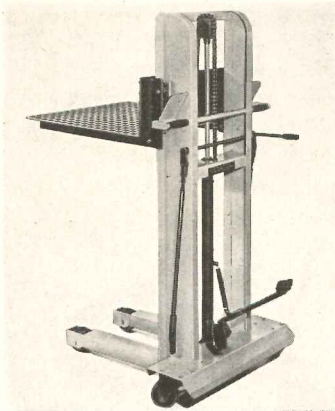
# PRODUCTS for Better Building

## EQUIPMENT FOR INDUSTRIAL BUILDINGS

### MATERIALS HANDLING



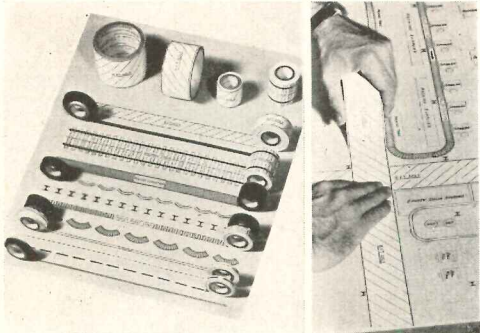
A



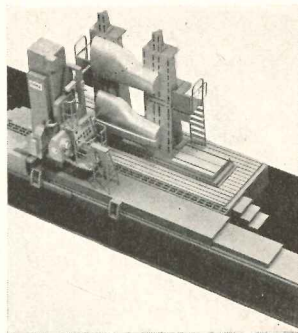
B

The architect who designs an industrial building today is faced not only with an ever-increasing variety of complex special problems, but also with a formidable range and quantity of equipment designed to help solve those problems. Specification of some of this equipment occurs in categories which are the architect's direct responsibility. In other cases, while he is not directly responsible for it, the architect can by his selection of equipment help insure maximum efficiency in plant operations. On this and following pages, *Products for Better Building* presents a round-up of some of the new industrial equipment available today in a variety of categories. The range and quantity of available equipment is large, and the presentation offered here is necessarily limited. Nevertheless the industrial building designer will find a representative selection of the equipment he may be called upon to specify in plants, warehouses or terminals.

### PLANT LAYOUT



C



D

A. The "Octopus," a new Baker-Raulang 4000-lb capacity fork lift truck, has special carriage and attachments which can handle nearly a dozen different types of loads, including large drums as shown. Baker-Raulang Co., Baker Industrial Truck Div., 1230 W. 80th St., Cleveland, Ohio.

B. Big Joe hydraulic lift for either manual or battery operation has straddle type base, adjustable forks. Can be used for simplified handling of loads up to 1000 lb. Big Joe Manufacturing Co., 900 W. Jackson Blvd., Chicago 7, Ill.

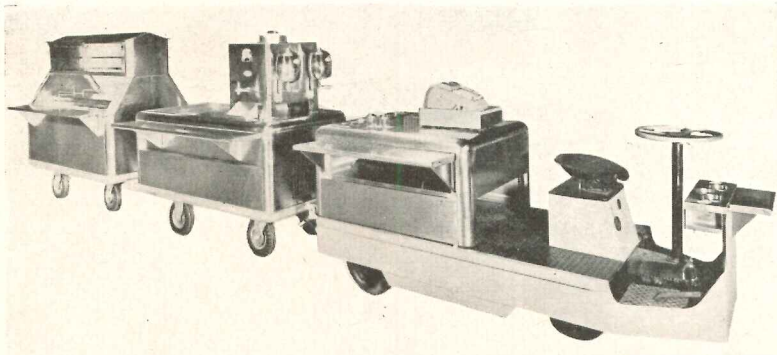
C. Labelon pre-printed adhesive tape helps save time in making plant layouts. Includes standard symbols, scale either  $\frac{1}{4}$  or  $\frac{1}{8}$  in. per ft, opaque or transparent tape. Labelon Tape Co., 450 Atlantic Ave., Rochester 9, N. Y.

D. Harman scale models for plant layouts include almost every known machine tool in  $\frac{1}{4}$ -in. scale. Models may be used in combination with two-dimensional acetate-printed scale grid sheets and outline drawings. Harman Associates, Halesite, Long Island.

E. Rehco mobile food train for in-plant feeding will serve about 300 persons. It has both cold food and hot food cars and is all-electrically operated. Cold food car has Servel Supermetec condensing unit. Rehco Corp., 5846 Hooper St., Los Angeles, Calif.

(Continued on page 202)

### IN-PLANT FEEDING



E



LITERATURE for the Office

NEW CATALOGS FOR INDUSTRIAL BUILDING DESIGNERS

Among the many new items of product literature especially relevant to design, equipment and maintenance of industrial buildings are the following:

- *Techniques of Plant Maintenance — 1953.* Volume contains the text of 61 sessions on various aspects of maintenance and plant engineering held in Cleveland in January. Over 2200 production and maintenance men attended the conference, which featured separate roundtables devoted to 11 industries: automotive, chemical, electrical, food, foundries, paper, petroleum, printing and binding, rubber, steel and textile. Ten other groups considered "Area vs. Centralized Maintenance," "Dealing with Union Labor," "Incentives and Work Measurement," "Lighting," "Lubrication," "Project Control," "Pumps

and Piping," "Sanitation," "Selling Management on the Maintenance Program" and "Maintenance Stores." General sessions were "Maintenance Essentials" and "Growing Pains of an Engineering Maintenance Organization."

- Highlighted in the publication are 859 questions and answers from the general and sectional conferences. Summarized discussions from the 21 roundtables are also included, as well as texts of 20 papers read and 41 charts. The book is sent without charge to those who attended the conference; it is available to all others for six dollars postpaid. 288 pp., illus. Clapp & Poliak, Inc., 341 Madison Ave., New York 17, N. Y.

- *Balanced Industrial Ventilation.* The scope of this bulletin is limited to the problems resulting from the relationship of exhaust and make-up air systems, and the bearing it has on the heating load. Drawings of a typical exhaust system, fan products for make-

up air systems and a field assembled unit are included, as well as descriptive matter. 4 pp., illus. National Association of Fan Manufacturers, Inc., 2159 Guardian Building, Detroit 26, Mich.

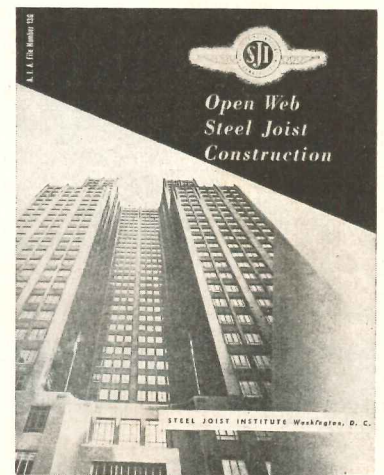
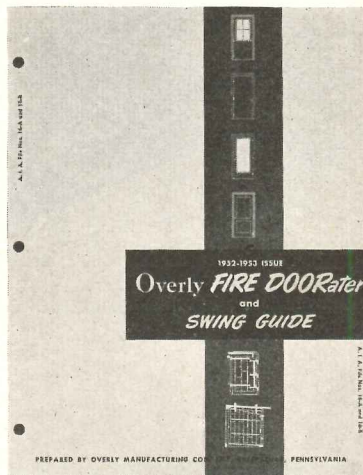
- *Recommended Practice for Supplementary Lighting.* Booklet deals with many critical seeing tasks involved in fabrication and inspection for manufacturing processes and recommends lighting which supplements the general lighting systems. A table is featured, classifying visual tasks and lighting techniques for each. Described here are material and task involved, lighting requirements for each task, suggested luminaire type and location. Other tables recommend proper brightness ratios and light reflectances for interior surfaces. Price, 50 cents. 16 pp., illus. Publications Office, Illuminating Engineering Society, 1860 Broadway, New York 23, N. Y.

\*Other product information in Sweet's Architectural File, 1953.

(Continued on page 250)



1953 BUILDING PRODUCTS LITERATURE WINNERS



THIS year's edition of the Annual Products Literature Competition sponsored jointly by the American Institute of Architects and The Producers' Council produced a total of 37 awards to manufacturers (see also ARCHITECTURAL RECORD, July, 1953, p. 12). The awards are presented for technical presentations of products, either in advertisements or manuals, which help architects in se-

lection and specification of materials. Top winners in the 1953 competition were the two booklets shown on this page, which won Certificates of Exceptional Merit for the Steel Joist Institute and the Overly Manufacturing Company, respectively. Eleven other manufacturers received Certificates of Merit and 24 were given Honorable Mentions. Most awards for a single manufacturer

were won by Armstrong Cork Company, which received a total of 5 in 3 different classifications. Awards were made in four classes by the following jury of practicing architects: Chairman Richard M. Bennett, F.A.I.A., Chicago; Ben H. Dyer, A.I.A., Bethesda, Md.; Edwin Green, F.A.I.A., Harrisburg, Pa.; George S. Idell, A.I.A., Philadelphia; Ben John Small, A.I.A., New York.



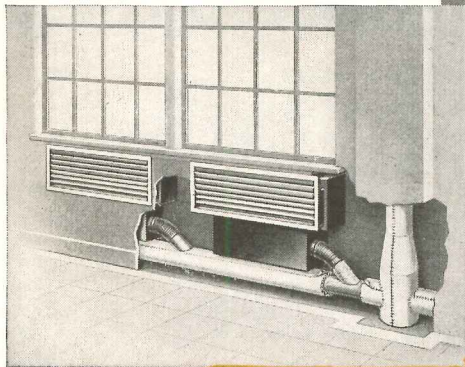
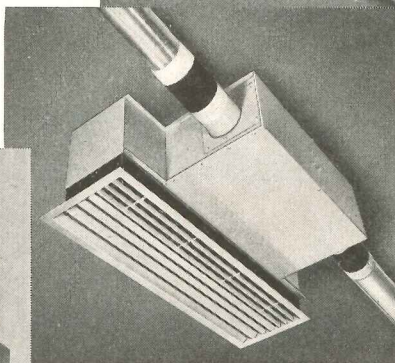
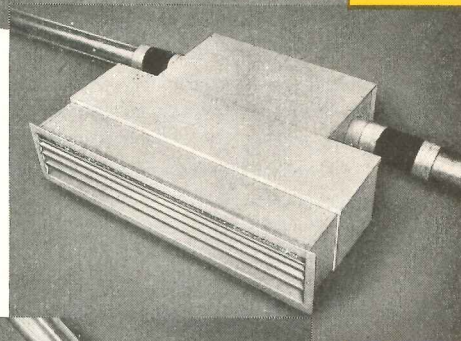
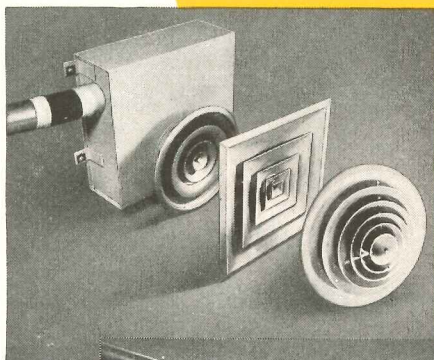
*Pick your*  
**package**

**ANEMOSTAT HIGH VELOCITY ASPIRATING UNITS**

Here's Anemostat's answer to the problem of high velocity air distribution.

Each of these easy-to-install packaged units consists of a combination static pressure and velocity reducing valve, plus sound attenuating chamber and one of several types of Anemostat draftless air diffusers. A wide choice to meet all your engineering and architectural requirements.

For top flight performance in high velocity air distribution systems, pick your package from Anemostat's line of tried and proven high velocity units. Write for High Velocity Manual No. 48 for details.



**ANEMOSTAT®**

**DRAFTLESS Aspirating AIR DIFFUSERS**

**ANEMOSTAT CORPORATION OF AMERICA**

10 EAST 39th STREET, NEW YORK 16, N. Y.

REPRESENTATIVES IN PRINCIPAL CITIES

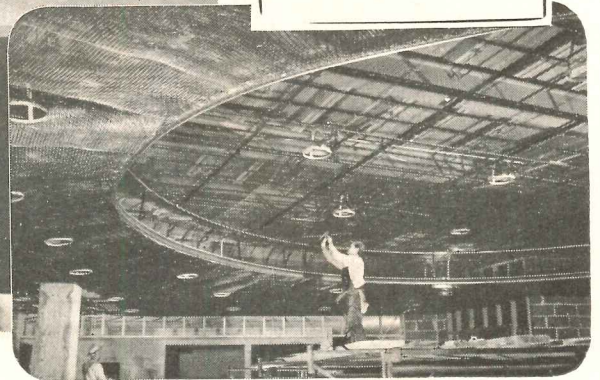
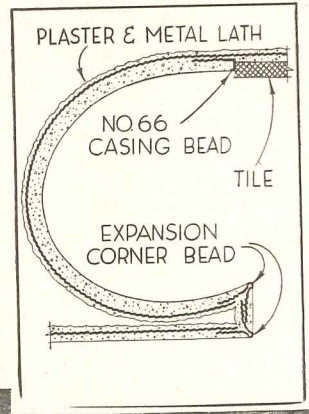
*"No Air Conditioning System Is Better Than Its Air Distribution"*



Handsome Misericordia Hospital lobby made permanently beautiful and firesafe with Milcor Metal Lath construction. Note details at right and construction photo below.



Misericordia Hospital, Milwaukee, Wis. • Architects Brust & Brust • General Contractor: Ed Steigerwald & Sons • Plastering Contractor: Michael Iglinski, Jr



## **MILCOR\*** Casing Bead provides clean, protective separation between plaster and other materials

**I**N this hospital lobby, Milcor Casing Bead has a double function: (1) It provides a sharp, permanent line of separation between the finished acoustical plaster and the acoustical ceiling tile, which is applied over a metal lath and plaster base; (2) During construction, it served as a screed, for a smooth, clean job at the point where the plaster adjoins the acoustical-tile ceiling.

This application of No. 66 Milcor Casing Bead is typical, wherever plaster abuts a material with a different co-efficient of expansion

and contraction. It often eliminates the need for covering trim, batten strip or cove mould over the joint.

These advantages of Milcor Casing Bead, however, are in addition to its basic ones of providing the beauty and simplicity of flush door and window openings — with the permanence of steel.

A variety of Milcor Casing Bead is available — solid and expansion-wing types. See Milcor Catalog No. 252. Write for your copy.

\*Reg. U. S. Pat. Off. M-117

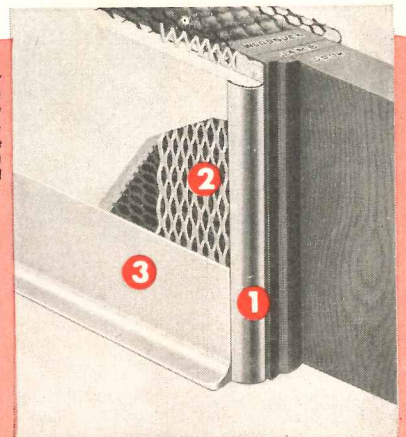
## **INLAND STEEL PRODUCTS COMPANY**

4035 WEST BURNHAM STREET

MILWAUKEE 1, WISCONSIN

BALTIMORE 5, MD. — 5300 Pulaski Highway • BUFFALO 11, N. Y. — 64 Rapin St. • CHICAGO 9, ILL. — 4301 S. Western Avenue Blvd. • CINCINNATI 25, OHIO — 3240 Spring Grove Ave. • CLEVELAND 14, OHIO — 1541 E. 38th St. • DETROIT 2, MICH. — 690 Amsterdam Ave. • KANSAS CITY 41, MO. — P. O. Box 918 • LOS ANGELES 58, CALIF. — 4807 E. 49th St. • NEW YORK 17, N. Y. — 230 Park Ave. • ST. LOUIS 10, MO. — 4215 Clayton Ave

Another popular Milcor Casing Bead — No. 4 creates interior beauty around this door opening. (1.) Note that only trim, narrow face is exposed. (2.) Expanded wing provides effective plaster reinforcement. (3.) Milcor No. 657 Applied Metal Base.



Milcor No. 66 Expansion Casing Bead

Metal Lath for Strength — Plaster for Beauty!