

OCTOBER 1952

# ARCHITECTURA RECORD



Marin General Hospital, Greenbrae, California; Robert Stanton, Architect

---

**BUILDING TYPES STUDY NUMBER 191 HOSPITALS**



**How safe  
is a  
hospital?**

*International News Photo*

**Above:** Fire in a mid-western hospital, out of control, destroys the building, takes the lives of forty patients.

This year there will be an average of three hospital fires reported per day and they will follow the general pattern shown in the insert.







Not all of these fires will develop into disasters, for most modern hospitals have excellent fire protection. But experience shows that some few will, and that these few will take an almost inevitable toll of lives and property. These will be hospitals not now provided with means of stopping fire *quickly at its source*.

Hospital fires *must* be put out before choking fumes reach bedridden patients, before searing heat can seal off floors or corridors, before panic can have a chance to develop. Grinnell Automatic Sprinklers offer such protection. Grinnell Automatic Sprinkler Systems guard against loss of life and property by stopping fire at its source, wherever and whenever it may strike, with automatic certainty. Seventy-four years experience proves this.

For help in planning fire protection, without obligation to you, write Grinnell Company, Inc., Providence, R. I. Branch offices in principal cities.

### Here's Where Hospital Fires Start

(Survey by National Fire Protection Association)

 <b>Service Rooms 52.1%</b>	 <b>Outside 15.5%</b>	 <b>Patients' Quarters 11.4%</b>
 <b>Nurses' Rooms 5.8%</b>	 <b>Operating 3.3%</b>	 <b>Miscellaneous 11.9%</b>



**GRINNELL**  
FIRE PROTECTION SYSTEMS



Manufacturing, Engineering and Installation of Automatic Sprinklers Since 1878

# ARCHITECTURAL RECORD



Copyright 1952 by F. W. DODGE CORPORATION, with all rights reserved • Publishing Director, Magazine Division, H. Judd Payne • Business Manager, Robert F. Marshall • EDITORS: Executive Editor, Joseph B. Mason; Managing Editor, Emerson Goble; Senior Associate Editor, Frank G. Lopez, A.I.A.; Associate Editor, James S.

Hornbeck; Associate Editor, Florence A. van Wyck; Associate Editor (Engineering), Robert E. Fischer; Associate Editor, Herbert L. Smith, Jr., A.I.A.; Western Editor, Elisabeth Kendall Thompson; Assistant Editor (News), Jeanne M. Davern; Contributing Editors, Ernest Mickel (Washington), John Caulfield Smith, M.R.A.I.C. (Canada); Editorial Assistants, Carl Scarenco, Enid Belding, Mary Lou Finnegan, Jeanne G. Whitbeck • DESIGN: Consultant, M. Peter Piening; Director, Alfred Petersen; Assistants, Joseph D'Amato, Donald Ervin; Drafting, Sigman-Ward • CONSULTANTS: Industry Relations Consultant, Thomas S. Holden; Statistical Consultant, Clyde Shute; Field Research Consultant, Clifford Dunnells, Jr.; Public Relations Consultant, Samuel C. Pace.

Architectural Record (combined with American Architect and Architectural) is published monthly by F. W. Dodge Corporation, 10 Ferry Street, Concord, N. H., with editorial and executive offices at 119 West 40th Street, New York 18, N. Y. Western editorial office, 2877 Shasta Road, Berkeley 8, Calif.

Chairman of the board, James McV. Breed; vice chairman of the board, Paul Abbott; president, Thomas S. Holden; vice president and treasurer, Howard Barringer; secretary, Sanford D. Stockton, Jr.; vice presidents: Irving W. Hadsell, Chauncey L. Williams, H. Judd Payne, T. Oliver Morgan; assistant secretaries: George W. Morgan, Jr., William C. Breed, Jr.; assistant vice presidents: Clyde Shute, Clifford G. Dunnells, Jr., Howard M. Thompson, Marc Wayne, Robert F. Marshall; assistant treasurers: Walter F. DeSaix, Edwin H. Freed, Irving B. Satin; regional vice presidents: Carl S. Bennett, Ralph M. Hairston, Julius T. Little, Richard H. Ray.

Subscription rates: United States and possessions, Canada, Cuba, Mexico, Central and South America, and Spain, \$4.50 a year, \$7.50 for two years, \$9 for three years; elsewhere, \$6.50 a year, \$11.50 for two years, \$15 for three years. Single copy \$2. Circulation manager, Marshall T. Ginn.

Member of Audit Bureau of Circulations and Associated Business Publications. Architectural Record is indexed in Readers' Guide to Periodical Literature, Art Index, Industrial Arts Index and Engineering Index.

Every effort will be made to return material submitted for possible publication (if accompanied by stamped, addressed envelope), but the editors and the corporation will not be responsible for loss or damage.

Other Dodge services: Dodge Reports and Dodge Statistical Research Service, Sweet's Files, Home Owners' Catalogs, Chicago Construction News, Daily Pacific Builder, Denver Daily Journal, Real Estate Record & Builders' Guide.

Cover: **Marin General Hospital, Greenbrae, Calif.**  
Robert Stanton, architect; Roger Sturtevant photo

<b>THE RECORD REPORTS</b> . . . . .	11
News from Canada. By John Caulfield Smith . . . . .	28
News from Washington. By Ernest Mickel . . . . .	38
Construction Cost Indexes . . . . .	42
<b>REQUIRED READING</b> . . . . .	46
<b>RIO SPORTS CENTER: A PROGRESS REPORT</b> . . . . .	131
Rio de Janeiro, Brazil. Raphael Galvão, Pedro Paulo Bastos, Antonio Dias Carneiro, Orlando Azevedo, Architects	
<b>COLLEGE BUILDINGS</b> . . . . .	140
<b>AIR CONDITIONING PLAYS MAJOR DESIGN ROLE</b> . . . . .	140
Business Administration, Agriculture and Administrative Offices Building, Arizona State College, Tempe, Ariz. Edward L. Varney Associates, Architects & Engineers	
<b>RECREATION CENTER WITH MODERN INTERIORS</b> . . . . .	147
Student Union Building, Ohio State University, Columbus. Bellman, Gillett and Richards, Architects & Engineers; Howard Dwight Smith, University Architect	
<b>DESIGNED FOR 600-LB LIVE LOADS</b> . . . . .	154
Engineering Building, University of California, Los Angeles Campus. Allison and Ribbe, Architects; Welton Becket & Associates, Supervising Architects	
<b>CONTEMPORARY DESIGN AMIDST COLLEGIATE GOTHIC</b> . . . . .	159
Classroom Building for Graduate Study, Concordia Seminary, Clayton, Mo. Kenneth E. Wischmeyer, Architect	
<b>LABORATORIES AND CLINIC, CENTRAL INSTITUTE FOR THE DEAF</b> . . . . .	164
St. Louis, Mo. William B. Ittner, Inc., Architects	
<b>PATTERSON-BRADFORD REXALL DRUG STORE</b> . . . . .	170
Jackson, Miss. N. W. Overstreet & Associates, Architects	
<b>COUSINS FURNITURE AND APPLIANCE STORE</b> . . . . .	173
Johnson County, Kan. Kivett & Myers, Architects	
<b>MODERN INTERPRETATION REMINISCENT OF OLD FRENCH QUARTER</b> . . . . .	174
Residence for Mr. and Mrs. John J. Taylor, New Orleans, La. Curtis & Davis, Architects	
<b>BUILDING TYPES STUDY NO. 191 . . . HOSPITALS</b> . . . . .	179
<b>285-BED HOSPITAL PLANNED FOR TRAINING</b> . . . . .	181
Mobile Infirmary, Mobile, Ala. Platt Roberts & Company, Architects	
<b>PACE-SETTER HOSPITAL STRESSES EQUIPMENT</b> . . . . .	190
Marin General Hospital, Greenbrae, Calif. Robert Stanton, Architect	
<b>133-BED HOSPITAL PLANNED FOR EXPANSION</b> . . . . .	198
Ottumwa Hospital, Ottumwa, Iowa. Morgan-Gelatt & Associates, Architects	
<b>PLANNED FOR EXPANDABILITY PLUS ECONOMY</b> . . . . .	206
Gadsden County Hospital, Quincy, Fla. Robert and Company Associates, Architects and Engineers	
<b>53-BED HOSPITAL THAT WILL GROW TO 75</b> . . . . .	214
St. Charles Hospital, Bend, Ore. John W. Maloney, Architect	
<b>19-BED HOSPITAL OF REMARKABLY LOW COST</b> . . . . .	219
Cozad Community Hospital, Cozad, Neb. Frank N. McNett & Company, Architects	
<b>ARCHITECTURAL ENGINEERING</b>	
<b>TECHNICAL NEWS AND RESEARCH</b>	
<b>TRAFFIC PROBLEMS IN SHOPPING CENTERS</b> . . . . .	223
By Kenneth C. Welch, A.I.A., and Bruno Funaro, A.I.A.	
<b>A NEW APPROACH TO SAFETY OF BUILDINGS</b> . . . . .	229
By Paul Weidlinger	
<b>PRODUCTS FOR BETTER BUILDING</b> . . . . .	233
<b>LITERATURE FOR THE OFFICE</b> . . . . .	234
<b>TIME-SAVER STANDARDS</b> . . . . .	237
Structural Forms — 8-11: Long Spans in Wood. By Seymour Howard, Architect, Instructor at Pratt Institute	
<b>INDEX TO ADVERTISING</b> . . . . .	6

# INDEX TO ADVERTISING

a	Accurate Metal Weatherstrip Co., Inc.	364
abe	Adam, Frank Electric Co.	83
a	Adams & Wastlake Co.	401
ae	Advance Transformer Co.	125
a	Aerofin Corporation	335
a	Aetna Steel Products Corp.	356
a	Affiliated-Gas Equipment, Inc.	345
a	Air Devices, Inc.	33
a	Alan Wood Steel Company	282-326
a	Alberene Stone Corporation of Virginia	280
a	Allegheny-Ludlum Steel Corp.	323
a	Allen, W. D. Manufacturing Co.	302
a	Aloe, A. S. Company	398
a	Alumiline Corporation	379
a	Aluminum Company of America	24-25
ab	Aluminum Window Mfrs. Assn.	393
a	Alumiseal Corporation	250-251
ae	American Blower Corporation	308
a	American Brass Company	55
a	American Bridge Division	311
ab	American Hardware Corporation	8-9-246-247
a	American-Olean Tile Company	67
b	American Radiator & Standard Sanitary Corp.	320
ab	American Telephone & Telegraph Co.	292
a	Amplex Corporation	362
a	Anco Wood Specialties Inc.	405
a	Anemostat Corp. of America	235
a	Arabul Manufacturing Co.	402
a	Architectural Record	288-289
abe	Armstrong Cork Company	130-319
a	Arrow-Hart & Hegeman Electric Co.	63
a	Art Metal Company	78
ab	Associated Plywood Mills, Inc.	127
a	Auth Electric Company, Inc.	80
ae	Barber-Colman Company	382
ae	Bayley, William Company	56
ab	Bell Telephone System	292
a	Benjamin Electric Mfg. Co.	115
ae	Bethlehem Steel Company	120-296
a	Bigelow Rugs & Carpets	112
abe	Bilco Co.	400
a	Bituminous Coal Institute	371
a	Blank, Frederic & Company, Inc.	394
abe	Blue Ridge Sales Division	283
a	Books	378
a	Bostwick Steel Lath Company	94
ab	Brainard Steel Division	397
a	Briggs Manufacturing Co.	52
ae	Brown Company	401
ab	Bruce, E. L. Co.	49
a	Bryant Electric Company	339
a	Bryant Heater Division	345
a	BullDog Electric Products Co.	61
a	Bundy Tubing Company	117
a	Burnham Corporation	401
ae	Burt Manufacturing Co.	392
a	Byers, A. M. Company	4
a	Cabot, Samuel, Inc.	270
a	Cambridge Tile Mfg. Co.	101
a	Canton Stoker Corporation	106
ae	Carrier Corporation	68-363
a	Cast Iron Soil Pipe Institute	336
ab	Ceco Steel Products Corp.	90-91
abe	Celotex Corporation	240
a	Century Lighting Inc.	372
abe	Certain-Seed Products Corporation	300
a	Chase Brass & Copper Co.	108
a	Cincinnati Time Recorder Co.	381
a	Cipco Corporation	38
a	Classified Advertisements	387
ae	Cleaver-Brooks Company	399
a	Cleveland Hotel	404
a	Committee on Steel Pipe Research	64
a	Concrete Reinforcing Steel Institute	361-405
a	Congoleum-Nairn, Inc.	252-253
a	Connor, W. B. Engineering Corp.	113
a	Corbin, P. & F. Division	8-9
a	Corning Glass Works	329
a	C-O-Two Fire Equipment Company	312
a	Coyne & Delany Co.	284
b	Crane Co.	29
abe	Crawford Door Co.	77
a	Crucible Steel Co. of America	129
a	Curtis Companies Service Bureau	293
a	Curtis Manufacturing Company	340
a	Cutter Mail Chute Co.	402
a	Dant & Russell, Inc.	306
a	Day-Brite Lighting, Inc.	40-41
a	Deco Sales	105
a	Detroit Steel Products Co.	66-307
a	Douglas Fir Plywood Association	30-31
ae	Dravo Corporation	390
a	Dunham, C. A. Co.	82
a	Duriron Company, Inc.	342
a	Edwards Company, Inc.	276
a	Electric Storage Battery Company	65
a	Ellison Bronze Co.	338
a	Employment Opportunities	387
a	Executone Communication Systems	385
a	Faber, A. W.—Castell Pencil Co.	400
ae	Facing Tile Institute	111
a	Fedders-Quigan Corporation	58-59
ae	Federal Cement Tile Company	386
a	Federal Seaboard Terra Cotta Corp.	385
a	Fenestra Building Products	66-307
ab	Fiat Metal Manufacturing Company	254
a	Fitzgibbons Boiler Company	242
a	Fleur-O-Lier Manufacturers	107
a	Flexicore Co., Inc.	379
a	Flint & Walling Mfg. Co., Inc.	392
ab	Follansbee Steel Corporation	381
a	Formica Company	406
ab	Gate City Sash & Door Co.	298
a	General Aniline & Film Corp.	258
a	General Electric—Construction Materials	10-367-386

ab	General Electric—Home Bureau	96-97
a	General Portland Cement Co.	350
a	General Time Corporation	377
a	Getty, H. S. & Co., Inc.	325
a	Glide Windows, Inc.	375
ae	Goode Hoist Company	310
a	Glynn-Johnson Corporation	299
a	Goodall Fabrics, Inc.	70-316
abe	Granco Steel Products, Co.	331
a	Grant Pulley & Hardware Co.	380
abe	Great Lakes Steel Corp.	81
ae	Grinnell Company, Inc.	2nd Cover
a	Guth, Edwin F. Co.	275
a	Hachmeister, Inc.	349
a	Haerdt, W. J. & Company	85
a	Hamilton Manufacturing Company	375
a	Hart & Hegeman Division	63
a	Haws Drinking Faucet Co.	390
a	Heinemann Electric Co.	27
a	Herring-Hall-Marvin Safe Co.	346
ae	Hogan, C. T. & Co., Inc.	251
ae	Homasote Company	398-399
ae	Hope's Windows, Inc.	98
a	Horn, A. C. Co., Inc.	89
ab	Hunter Douglas Corp.	343
ab	Hunter Fan & Ventilating Co., Inc.	384
abe	Ilg Electric Ventilating Co.	93
a	Imperial Brass Mfg. Co.	16
a	Infra Insulation, Inc.	15
ab	Inland Steel Products Company	236
a	International Nickel Company, Inc.	72
ab	Jackson & Church Co.	3rd Cover
a	Jenkins Bros.	51
ae	Johns-Mansville	118-347
a	Johnson Service Co.	100
a	Just Manufacturing Co.	48
a	Kalistrat	105
a	Kennard Corporation	305
a	Kennecott Copper Corp.	108
ab	Kenite, Inc.	19
a	Kent-Moore Organization, Inc.	394
a	Keystone Steel & Wire Company	50
a	Kimble Glass Company	321
ae	Kinnear Mfg. Co.	278
a	Kirlin Company	387
a	Knapp Brothers Mfg. Co.	384
a	Koh-I-Noor Pencil Company Inc.	386
a	Kohler Co.	393
ab	Kwikset Sales and Service Company	1
a	LCN Closers, Inc.	281
a	Laclede Steel Company	290
a	LaSalle Products, Inc.	330
a	Lees, James & Sons Company	92
abe	Libbey-Owens-Ford Glass Co.	283-355
a	Litecontrol Corporation	304
a	Litewood Hardware Mfg. Co.	255
ab	Louisville Cement Company, Inc.	119
a	Lucke, W. B. Inc.	126
ab	Ludman Corporation	244-245
ae	Macomber, Incorporated	352
ae	Mahon, R. C. Company	47
a	Marble Institute of America, Inc.	124
a	Markel Electric Products, Inc.	330
a	Marmet Corporation	382
ab	Marsh Wall Products, Inc.	84
a	McKenna, J. G. Inc.	391
a	McQuay, Inc.	259
a	Medart, Fred Products, Inc.	57
ab	Metal Tile Products Inc.	395
a	Michaels Art Bronze Co., Inc.	318
a	Miller Company	399
ae	Mills Company	79
a	Minneapolis-Honeywell Regulator Co.	272-273
a	Minwax Co., Inc.	388
ae	Mississippi Glass Company	122
ae	Mitchell Manufacturing Co.	391
e	Modine Mfg. Co.	313
a	Moore, P. O. Inc.	382
ab	Morgan Company	303
ab	Mosaic Tile Company	86-87
ab	Mueller Brass Co.	71
a	Nator Store Fronts	390
a	National Clay Pipe Mfrs., Inc.	351
ae	National Electric Products Corporation	20-21
abe	National Fireproofing Corporation	309
a	National Gypsum Company	327
a	National Lock Company	370
ab	National Oak Flooring Mfrs. Assn.	357
abe	National Steel Corporation	81
a	National Terrazzo & Mosaic Association, Inc.	368
a	National Tube Division	116
a	Neo-Ray Products, Inc.	377
ae	Nesbitt, John J. Inc.	348
a	New Castle Products	402
a	Norcor Manufacturing Co.	389
a	Norton Door Closer Company	23
ab	Nova Sales Co.	398-399
ab	NuTone, Inc.	386
a	Onan, D. W. & Sons, Inc.	358
a	Otis Elevator Company	99
abe	Owens-Corning Fiberglas Corporation	110
abe	Owens-Illinois Glass Company	321
ab	Oxalid Division	258
ab	Paine Lumber Co., Ltd.	69
a	Penberthy Injector Co.	395
ae	Pennsylvania Wire Glass Company	379
a	Picker X-Ray Corporation	333
ab	Pittsburgh Plate Glass Co.	264-265

MANUFACTURERS' PRE-FILED CATALOG  
Symbols "a", "b", and "e" indicate that catalogs of firms so marked are available in Sweet's Files as follows:

a	Sweet's File, Architectural, 1952	
b	Sweet's File for Builders, 1952	
e	Sweet's File, Engineering, 1952	
ab	Pittsburgh Steel Products Company	315
a	Ponderosa Pine Woodwork	297
a	Portland Cement Association	344
a	Powers Regulator Co.	35
a	Products Research Co.	380
ab	Pryne & Co., Inc.	267
a	RLM Standards Institute	271
a	Radio Corporation of America	314
ae	Ramset Fasteners, Inc.	262
a	Remington Arms Company, Inc.	256-257
a	Republic Steel Corporation	76-301
abe	Revere Copper & Brass, Inc.	60-373
abe	Reynolds Metals Company	279-369
ae	Reznor Manufacturing Co.	373
a	Richmond Radiator Co.	103
ae	Robertson, H. H. Co.	285
ab	Roddiss Plywood Corporation	43
ae	Rotary Lift Co.	287
ae	Rowe Methods Inc.	398
ab	Russell & Erwin Division	246-247
ab	Russell, F. C. Co.	74-75
ae	Rust-Oleum Corporation	123
a	Sarco Company, Inc.	121
a	Sarcatherm Controls, Inc.	39
a	Scientific Apparatus Makers Association	7
ae	Scott Paper Company	341
a	Seaport Metals, Inc.	365
ae	Security Fire Door Co.	322
c	Sedgwick Machine Works	396
a	Servicised Products Corp.	397
a	Sharon Steel Corporation	397
a	Shwayer Bros., Inc.	62
a	Silvray Lighting, Inc.	359
a	Simpson Logging Company	286-287
ab	Sisakraft Co.	391
a	Sjostrom, John E. Co.	373
a	Skylike Lighting, Inc.	359
ae	Sloan Valve Co.	4th Cover
a	Smith, H. B. Co., Inc.	404
a	Solar Light Manufacturing Co.	394
a	Soss Manufacturing Company	36
a	Southern Equipment Co.	37
a	Square D Company	2-3
ab	Standard Dry Wall Products	332
a	Standard Electric Time Co.	328
ae	Stark Ceramics, Inc.	95
a	Steel & Tube Division	76
a	Stem, Chester B. Inc.	377
ab	Starling Hardware Mfg. Co.	128
abe	Stran Steel Division	81
a	Straus, Nathan, Duparquet, Inc.	383
a	Stromberg Time Corporation	350
a	Struthers-Wells Division	396
ae	Swartwout Co.	376
a	Sweet's Catalog Service	260-261
a	Symmons Engineering Company	128
a	Thermador Electrical Mfg. Co.	385
ab	Thrush, H. A. & Company	389
a	Timber Engineering Company	366
a	Timber Structures, Inc.	378
ab	Timkin-Detroit Axle Co.	109
ae	Titus Mfg. Corp.	53
a	Titusville Iron Works Co.	396
ab	Trade-Wind Motorfans, Inc.	388
ae	Trane Company	248-249
a	Tremco Mfg. Co.	383
a	Trinity Portland Division	377
a	Truck Mixer Manufacturers Bureau	266
ae	Trumbull Electric—Dept. General Electric Company	353
a	United States Air Conditioning Corp.	394
a	United States Motors Corp.	393
ab	United States Plywood Corp.	102-105-337-360
a	United States Quarry Tile Co.	274
a	United States Steel Corp. Subsidiaries	104-116-311
a	Universal Atlas Cement Company	104
a	Universal Corporation	114
a	Upco Co.	389
a	Van Noorden, E. Company	397
a	Van-Packer Corporation	294
a	Van Range, John Company	374
a	Vannoguet Hardware Company	32
a	Volcan Radiator Co.	126
ae	Wakefield, F. W. Brass Co.	402
a	Wallace, William Company	354
ae	Wasco Flashing Co.	383
a	Waylite Company	54
a	Weyer Iron Works	405
ae	Webster, Warren & Co.	238
a	West Coast Lumbermen's Association	263
ab	Westinghouse Electric Corp., Apparatus	44-45-73-317
ab	Westinghouse Electric Corp., Electric Appliances	403
a	Westinghouse Electric Corp. Elevator	291
a	Weyerhaeuser Sales Company	268-269
a	Wiggins, H. B. Sons, Co.	390
a	Will-Burt Company	395
a	Wilmot Castle Co.	88
a	Wiremold Company	34
a	Worthington Corporation	324
a	Wright Manufacturing Company	334
abe	Zonolite Company	277
ae	Zurn, J. A. Mfg. Co.	295

NEW YORK—H. Judd Payne, Publishing Director; Robert F. Marshall, Business Manager; Tom Tredwell, Advertising Mgr.; Benton B. Orwig, Creative Service Manager; M. A. Murphy, Advertising Production Manager, 119 West 40th Street; BOSTON—Harry M. Horn, Jr., 855 Park Square Bldg.; CHICAGO—C. B. Riemersma, Robert T. Franden, David K. Bortz, 700 Merchandise Mart; CLEVELAND—John C. Jackson, Joseph F. Palmer, John W. Setear, 321 Hanna Bldg.; DALLAS—Joe Sanders, 2909 Maple Ave.; LOS ANGELES—Bob Wettstein, 672 South Lafayette Park Place; PHILADELPHIA—Tom Tredwell, 1321 Arch St.; PORTLAND—Bob Wettstein, 1220 S. W. Stark St.; SAN FRANCISCO—Bob Wettstein, Howard Bldg., 209 Post St.

# THE RECORD REPORTS

## CENTENNIAL OF ENGINEERING: A.S.C.E. MARKS 100 YEARS

THE CENTENNIAL OF ENGINEERING at Chicago September 3-13 was a bang-up birthday party for the American Society of Civil Engineers and the big climax of the Society's centennial year. Architects can take a special interest in this aspect of the Centennial — first because at its founding in 1852 the first national organization of civilian engineers was actually the American Society of Civil Engineers and Architects; and second, because the American Institute of Architects, founded as a separate organization for architects five years later, will be celebrating its own centennial in 1957.

The Centennial was also the greatest convocation of engineers the world has ever known. Planned to include all branches of engineering, as they were all once included in A.S.C.E., it attracted nearly 20,000 engineers representing more than 60 societies in this country and 20 foreign nations. It had as one of its major purposes the promotion of public understanding of the engineering profession.

The Centennial program was divided into two parts — the programs and special events arranged by Centennial of Engineering, 1952, Inc.; and the programs of 65 individual engineering societies and organizations that scheduled technical sessions in Chicago during the period of the convocation.

The American Institute of Architects joined the National Association of



A.S.C.E. President Carlton Proctor and A.I.A. President Glenn Stanton at "Re-Union of Architecture and Engineering 1852-1952," A.I.A. convention exhibit in tribute to A.S.C.E.

Home Builders and the Producers' Council in sponsoring one of these technical sessions — a progress report on modular coordination (see page 26).

Development of the Centennial theme centered on an ambitious program of symposiums on 12 subjects chosen "because of their high significance in the everyday lives of our people and in the industrial development of the country."

Of most direct concern to architects were the addresses at the "Structures and Construction" symposium by John O. Merrill, of Skidmore, Owings & Merrill, Architects & Engineers; Linton E. Grinter, Dean of the Graduate School and Director of Research at the Uni-

versity of Florida; and Walter C. Voss, head of the Department of Building, Engineering and Construction at Massachusetts Institute of Technology.

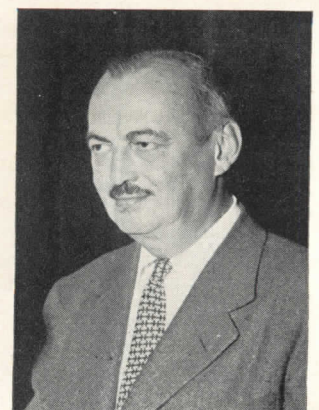
### *Design and the Needs of Men*

Mr. Merrill, who had been asked to discuss the subject "How Man Has Developed Buildings to Serve His Every Need," warned that any assumption that architects and engineers have already reached a final goal fails to take into account either the changing and dynamic nature of man's needs or the rapidity of technological advances in the construction industry.

But Mr. Merrill conceded that even

(Continued on page 26)

"Structures and Construction": Walter Voss and Chairman Waldo G. Bowman, editor of *Engineering News-Record*; Engineer David B. Steinman of New York and Willard Chevalier, McGraw-Hill executive vice president; John O. Merrill



## THE RECORD REPORTS

### WILLIAM F. LAMB DIES; DESIGNED EMPIRE STATE

WILLIAM FREDERICK LAMB, 68, of the New York architectural firm of Shreve, Lamb and Harmon Associates, died September 9 after a brief illness.

Mr. Lamb, a Fellow of the American Institute of Architects and the National Institute of Arts and Letters, was in charge of design for the Empire State Building; he and his firm became the recipients of the 1931 Gold Medal of the A.I.A. for the design of the tallest building in the world.

Among numerous other New York buildings designed by the firm are the 39-story Bankers Trust Company at 14 Wall Street and Best & Company's new building at Fifth Avenue and Fifty-first Street. The Acacia Mutual Life Insurance Company Building in Washington, D. C., and buildings at Cornell University, Connecticut College for Women, the Kent School and Hunter College in New York are among other works of the firm.

The present firm was founded by Mr. Lamb and R. H. Shreve, who had met while both were members of the firm of Carrère & Hastings. Arthur L. Harmon joined the firm in 1929.

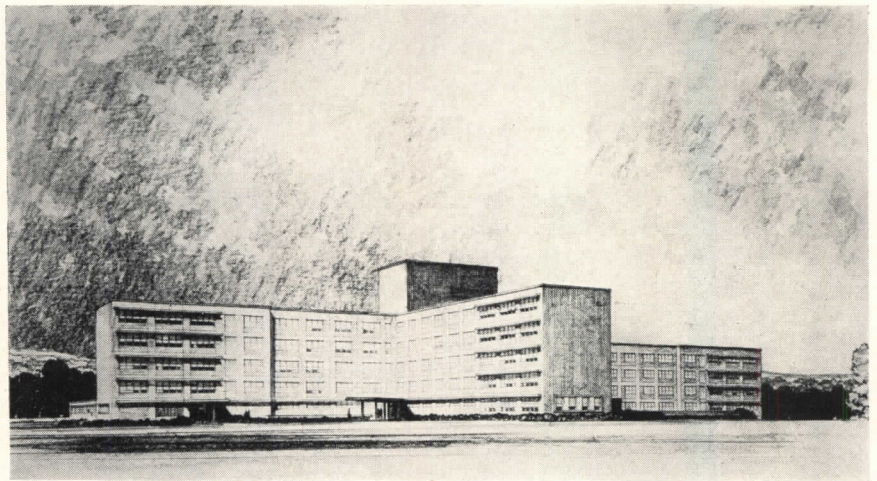
### J. G. BELCHER DIES AT 48; ARCHITECTURAL PUBLISHER

JOHN GODDARD BELCHER, vice president and a director of Reinhold Publishing Corporation of New York and publisher of *Progressive Architecture*, died August 30 in a seaplane crash at Boothbay Harbor, Me., where he was on vacation with his family. He was 48 years old.

A 1926 graduate of the University of Illinois, Mr. Belcher joined Reinhold in Chicago in 1937 as a salesman for *Pencil Points*, predecessor of *Progressive Architecture*. In 1942 he became midwest advertising manager, with headquarters in Chicago; and in 1943 he went to New York as business manager of *The New Pencil Points*. He became associate publishing director of *Progressive Architecture* in 1945 and publishing director in 1947, the same year he was elected to the Reinhold Board of Directors. In 1948 he was made vice president.

Mr. Belcher was active in civic and church affairs in Darien, Conn., where he made his home, and was chairman of the Promotion Committee of the Associated Business Publications.

## SEVEN ARMY PROJECTS LAUNCH SERVICES' NEW HOSPITAL BUILDING PROGRAM



Photograph of rendering shows one of two basic designs developed by York & Sawyer for the Army — the 250-bed hospital on 500-bed chassis

A NEW APPROACH to hospital planning for all the military services was revealed with the announcement by the Army of its plans to begin construction early next year on the first of seven new permanent-type hospitals for posts in this country.

The Army program is part of a new effort to coordinate building programs of all three services through an inter-service committee known as the Munitions Board Task Group for Development of Design Requirements and Construction Standards for Military Hospitals.

#### *Designed for Expandability*

The basic decision of the Munitions Board Task Group, beyond the goal of coordination, was the principle of expandability. All the hospitals in the new program are designed for easy expansion beyond their initial capacities.

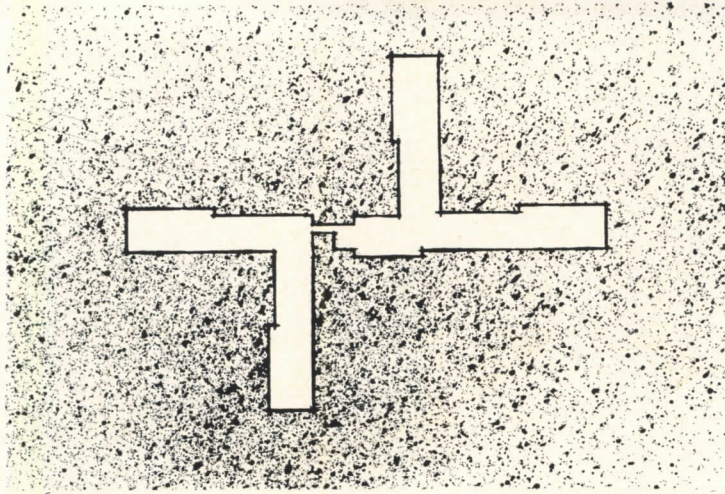
Each of the services was assigned by

the Task Group to develop basic designs for the sizes of hospital it uses most. Thus the Navy got the biggest, the Air Force the smallest and the Army the medium size projects.

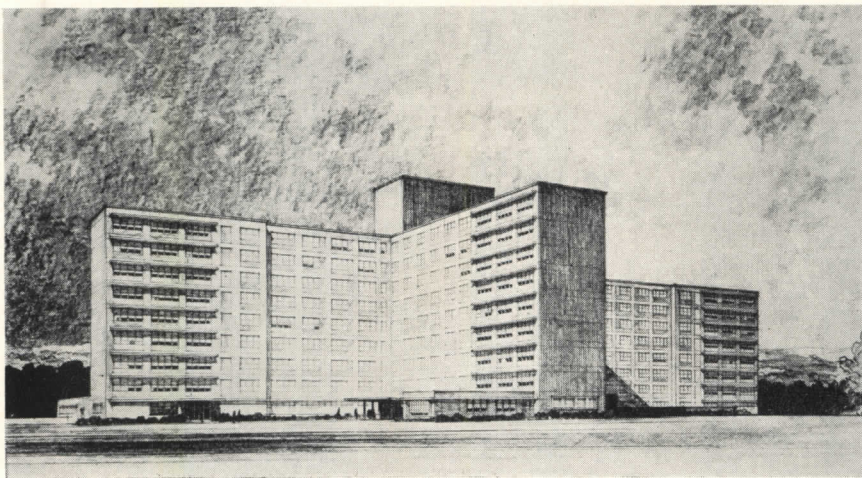
The Navy assignment was an 800-bed unit on a 1500-bed chassis; the Army's 250-beds on a 500-bed chassis and 500 beds on a 1000-bed chassis. The Air Force was assigned three sizes of permanent hospitals — 75 on 150-bed, 100 on 200-bed, and 150 on 300-bed — and three sizes of temporary hospitals — 50 on 100-bed, 75 on 150-bed and 150 on 300-bed.

#### *Private Architects Employed*

Private architects and engineers play a key role in the new programs. York & Sawyer of New York have developed the prototype designs for the Army hospitals; an association composed of Skidmore, Owings & Merrill, and Hays



Left: sketch shows outline of typical bedroom floor in expansion stage of York & Sawyer 500-1000 bed design; area right of narrow corridor would be constructed in initial stage. Below: plan of typical 34-bed ward (top finger in floor sketch)



Larger of prototype hospital designs for the Army by York & Sawyer is 500-bed project expandable to 1000; to be nine stories high

Seay, Mattern, Mattern, Virginia, for the Navy; and Schmidt, Garden and Erickson, Chicago, and Ellerbe & Co., St. Paul, for the Air Force.

The basic plans establish criteria, space allocations and general layout of the hospitals; the definitive drawings will be adapted to site locations by private architects to be selected.

All the designs will be used interchangeably by the three services as they require hospitals of the various sizes. During the development of the designs, they were studied and criticized at frequent meetings of the Task Group; approval of all the services and of the Armed Forces Medical Policy Council is required on final plans.

The Council also handles the programming end of the effort — selection of sites, construction priorities among the services, etc.

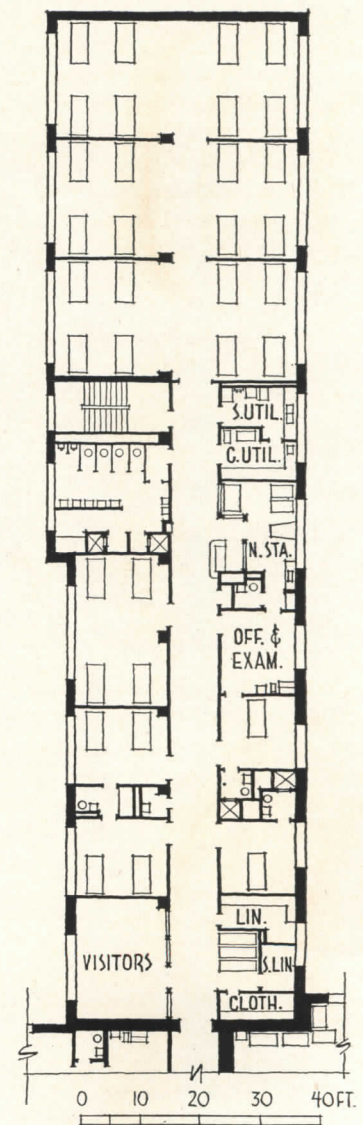
The \$133 million construction pro-

gram authorized by Congress provides \$45 million for eight Army hospitals; \$27 million for three Navy Hospitals; and \$61 million for 24 Air Force hospitals. Navy and Air Force plans are substantially complete and announcement has been awaiting Presidential approval.

#### Army Announces Sites

Site locations of the Army's seven hospitals were included in the Army announcement, which did not, however, mention the overall program.

The projects, which will add a total of 3200 beds, are planned at the following installations: Fort Benning, Ga., Fort Bragg, N. C., Fort Knox, Ky., and Fort Riley, Kan. — 500 beds expandable to 1000; Fort Belvoir, Va. — 250 beds expandable to 500; Fort Monmouth, N. J. — 200 expandable to 300; Fort Dix, N. J. — 750 expandable to 1000.



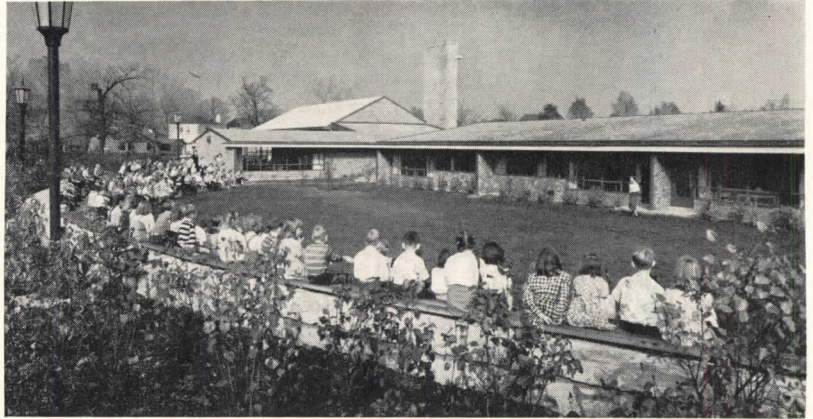
## THE RECORD REPORTS

### CHICAGO 1952: A. I. A. CHAPTER MAKES AWARDS

ARCHITECTS of the buildings shown on this page received the 1952 Honor Awards of the Chicago Chapter of the American Institute of Architects.

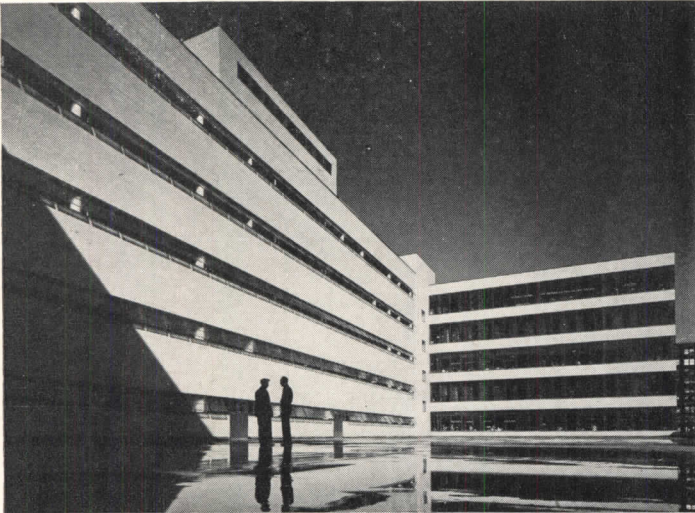
The four buildings were selected for the chapter's annual awards from submissions by 16 firms.

A special Award of Honor was given to Edgar Miller, Chicago artist, "for excellence in sculpture, mural painting and wood carving."

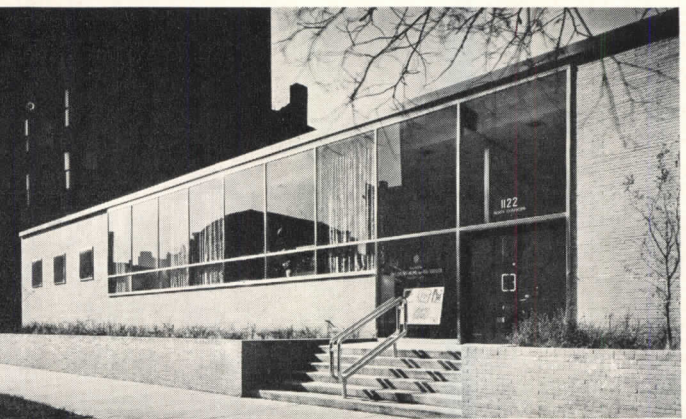


Hedrich-Blessing

*Blythe Park (Elementary) School, Riverside, Ill.; Perkins & Will, Architects-Engineers*

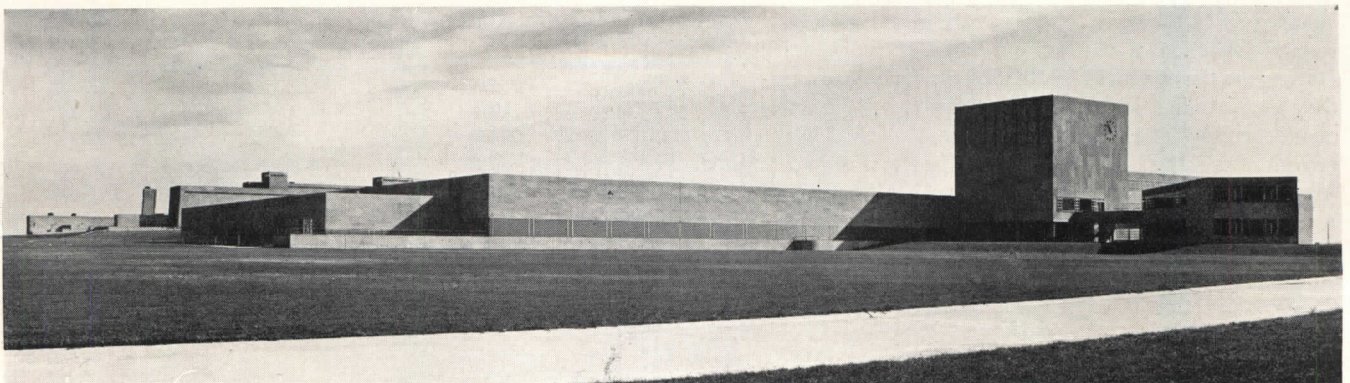


*Florsheim Shoe Company General offices and Main Factory, Chicago; Shaw, Metz & Dolio, Architects-Engineers*



*Illinois Children's Home & Aid Society Administration Building, Chicago; Skidmore, Owings & Merrill, Architects-Engineers. A Merit Award in the Fourth Annual National A.I.A. Honor Awards Program was later bestowed on this building*

*South District Filtration Plant, Chicago; Paul Gerhardt Jr., Architect for the city of Chicago*





**Why** does "rain" often form inside roof spaces of a crowded store or school? (pages 19, 32)  
**Why** does moisture gather on a water-and-vapor-proofed concrete floor? (page 32)  
**Why** is it wrong to vent cold roof spaces to a warm inside space? (page 33)  
**Does** a concrete floor slab lose heat only at the edges? (page 40)  
**In** what direction does heat flow by Conduction? Convection? Radiation? (pages 11, 15)  
**Do** "dead air spaces" exist with respect to heat flow? (page 16)  
**Why** do metals radiate and absorb less heat than wood, plaster, rockwool? (pages 13, 46)  
**Why** replace low-conductive air with denser materials of greater conductivity, i.e. ordinary insulation. (pages 11, 13, 14, 29)

The answers to these and numerous other problems of heat and vapor flow are found in the pages of the Fifth Revised Edition of

## SIMPLIFIED PHYSICS of Vapor and THERMAL INSULATION

By Alexander Schwartz

Written in simple language easy to understand, yet accurate and complete enough to gratify the scientist. Crammed with information the engineer, architect, public official, builder, contractor, insulator, heating installer, need. Hundreds of universities and technical schools use previous editions as a text. 56 pages of Facts, Figures, Charts, Illustrations, and Explanations of Heat and Vapor Flow; Vapor Permeability; Condensation; Dry Rot; Conduction and Density; Convection; Radiation and Emissivity; Reflection and Absorption. Suggests solutions and illustrated techniques for practical problems of insulation installation, condensation, protection against heat loss or intrusion, radiant heating; cold storage.

**For The First Time**  
**TABLE OF ABSORPTIVITY AND EMISSIVITY OF MATERIALS**  
*Plus, Revised and Amplified, the Famous*  
**CHART OF THERMAL INSULATION VALUES**

These 2 charts are indispensable to anyone interested in building and heating. THE VALUABLE MANUAL IS FREE! Just fill in the coupon below.

INFRA INSULATION, INC.  
 525 Broadway, N. Y., N. Y. Dept. R10  
 Please send FREE copy of "Simplified Physics of Vapor and Thermal Insulation"

Name \_\_\_\_\_  
 Connection \_\_\_\_\_  
 Address \_\_\_\_\_

Send Infra Insulation prices.  
 Send Infra sample.

*In* **HERE**  
 are the answers



**INFRA INSULATION, INC.**  
 525 Broadway, New York, N. Y.  
 WORTH 4-2241

5th REVISED EDITION, 1951  
**INFRA**  
 SIMPLIFIED PHYSICS OF VAPOR AND THERMAL INSULATION  
 By Alexander Schwartz, president, Infra Insulation, Inc.

**TYPE 6**  
 Infra Insulation

Carton, 3' x 11' x 11", contains 500 sq. ft. 1 1/2 cu. ft. to 1 sq. ft.

COMPARED WITH ORDINARY INSULATION:  
 40 lbs. against 1,000 lbs.  
 2 cu. ft. to 125 cu. ft.  
 12", 15", 24" Centers  
 Occupies 2" space

Flange for stapling has insulator's relief; makes installing easy

**3 ALUMI**  
 6 surfaces, one Warm surface Cold surface Permanent—Does not dull Water vapor, Convection, 1250° F. mol Tough 500% Stretching etc Tearing etc

**6 REFLECTIVE SPACES**  
 Enable aluminum to function. Have slight Conduction.  
 2 Outer Reflective Spaces.  
 4 rows of inner, alternating, reverse, triangular air spaces.

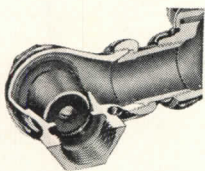
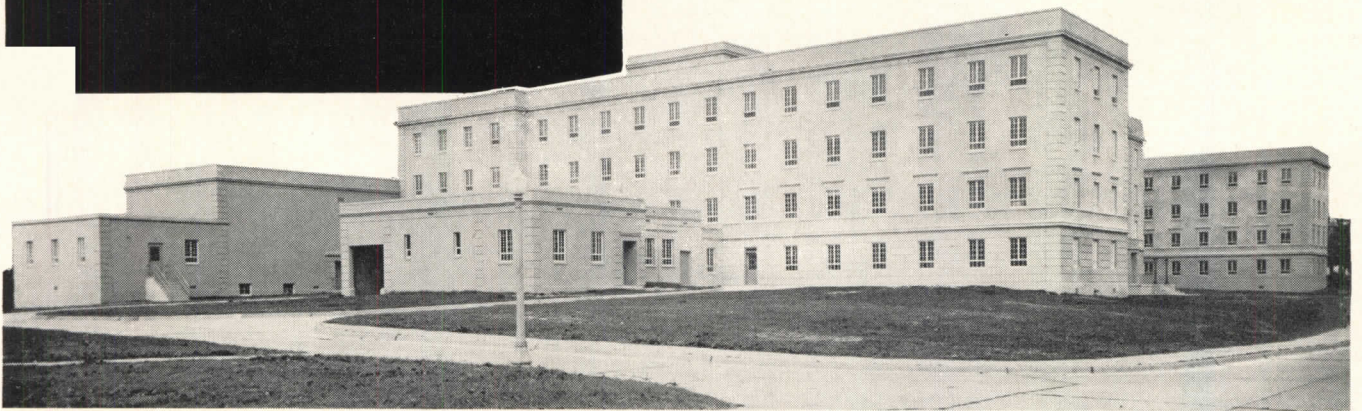
**ACCORDION SEPARA**  
 Creates 4 inner rows of 1 Makes 4 inner foil surf Enhance Configuration Block inner Convection Prevent aluminum from Flame, melt and void

**Multiple Accordion**  
 Does not form comb Does not store moisture Low storage cost in Lowest first cost in 100% more install Safe hot skin, eye Not damaged by 1 Does not retain o

**THERMAL FACTORS—TYPE 6**  
 Up-Best C.083, R11.23-4 1/2" dry rockwool  
 Wall-Best C.073, R11.69-5 1/2" dry rockwool  
 Down-Best C.044, R22.72-9" dry rockwool

# Fine Flush Valves for Fine Buildings

For complete information on Watrous Flush Valves write for Catalog No. 449-A.



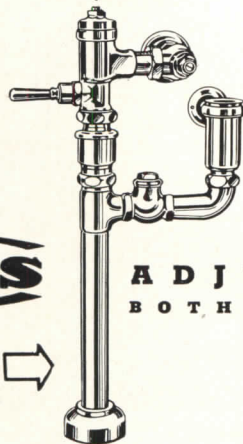
*Among Watrous Fine Features*

## Silence Without Penalty

Watrous Silent Action Flush Valves eliminate unwanted noise by employing corrugated surfaces to arrest water surge and eliminate turbulence. In contrast with the usual method of using shot or screens, Watrous Silent Action retains its high efficiency without danger of clogging — stays silent without requiring frequent cleaning, replacement or adjustment.

# Watrous

This new Watrous Flush Valve Combination for hospitals is especially adapted for bedpan cleansers. Eliminates need for special type bowls.



## VETERANS ADMINISTRATION HOSPITAL

Alexandria, La., one of the many fine buildings equipped with Watrous Flush Valves

VETERANS ADMINISTRATION  
Architects

J. D. HEDIN CONSTRUCTION CO.  
General Contractors

FRANK M. DORSEY & SONS, INC.  
Plumbing Contractors

**ADJUSTABLE FLUSH VALVES**  
BOTH DIAPHRAGM AND PISTON TYPES

THE IMPERIAL BRASS MANUFACTURING COMPANY  
1240 West Harrison Street, Chicago 7, Illinois

## THE RECORD REPORTS

### NEW METHODS DEVELOPED FOR BLAST-RESISTANT DESIGN

WINDOWLESS STRUCTURES, A Study in Blast-Resistant Design," latest in the series of technical manuals issued by the Federal Civil Defense Administration, applies the principle of dynamic analysis to the problem of designing for resistance to atomic blast. It describes a design procedure suitable for a structure that may be subjected to a single, comparatively heavy impulsive load, in contrast to conventional procedures dealing with the application of static loads or of dynamic loads of long duration and frequent occurrence.

The new methods were developed by Amman & Whitney, Consulting Engineers, of New York. They are based on studies of usable theories made for the Chief of the Army Engineers by a board of consultants including Prof. N. W. Newmark of the University of Illinois and Professors John W. Wilbur, Charles H. Norris and Robert J. Hansen of Massachusetts Institute of Technology.

The manual includes methods of evaluating the forces of an atomic blast, prepared under the direction of C. W. Lampson and J. Meszaros of the Army Ballistic Research Laboratories.

The new methods design a building to survive the blast by yielding, without coming apart. The building goes with the blow, sluggishly, and absorbs it, while the peak of the blast goes past. The building is left somewhat deformed, but otherwise intact. It completely protects occupants and equipment; work can continue.

These methods take advantage of the fact that the pressure of the atomic blast drops to zero in less than a second. It is during that fraction of a second that the blast delivers a blow that makes the ordinary, pre-atomic design loading insignificant.

The theories on which the study is based have been tested experimentally on small-scale models in a shock-tube at Princeton University.

In addition, a few test calculations have been made, using the proposed design methods to analyze elements of bombed Japanese buildings. The behavior of the Japanese buildings under actual atomic blasts checks with the calculated theoretical behavior.

The new principles may have impor-

tant applications in making conventional structures blast-resistant either in whole or in part by the addition of relatively inexpensive design features based on such general principles as these:

1. Structures with integrally-connected basements well anchored to the ground are more resistant to sliding and overturning than structures having shallow foundations.

2. Reinforced-concrete bearing walls and reinforced-concrete partitions rigidly connected to roof and floor increase resistance.

3. The general stiffness of the building can be increased at very small expense by connections between stiffening walls and the floor and roof, such as corner fillets.

Copies of the manual are available for one dollar from the Superintendent of Documents, U. S. Government Printing Office, Washington 25, D. C.

Another recent publication of interest in this field is the report of Armour Research Foundation of Illinois Institute of Technology on research done for the Air Materiel Command of the U. S. Air Force. *A Simple Method for Evaluating Blast Effects on Buildings* can be obtained from AMC headquarters, Wright-Patterson Air Force Base, Dayton, Ohio.

Some of the earlier FCDA publications, available from Superintendent of Documents, U. S. Government Printing Office, Washington 25, D. C.:

*United States Civil Defense* (1950), 168 pp. — 25 cents. The national plan for organizing the civil defense of the United States.

*The Effects of Atomic Weapons* (1950), 456 pp. — \$1.25.

*Damage from Atomic Explosions and Design of Protective Structures* (1950), 32 pp. — 15 cents.

*Fire Effects of Bombing Attacks*, Doc. 130 (1950), 48 pp. — 15 cents.

*Shelter from Atomic Attack in Existing Buildings*, Part I, Pub. TM-5-1 (1952), 53 pp. — 20 cents. Methods for determining shelter needs and shelter areas.

*Shelter from Atomic Attack in Existing Buildings*, Part II, Pub. TM-5-2 (1952), 26 pp. — 15 cents.

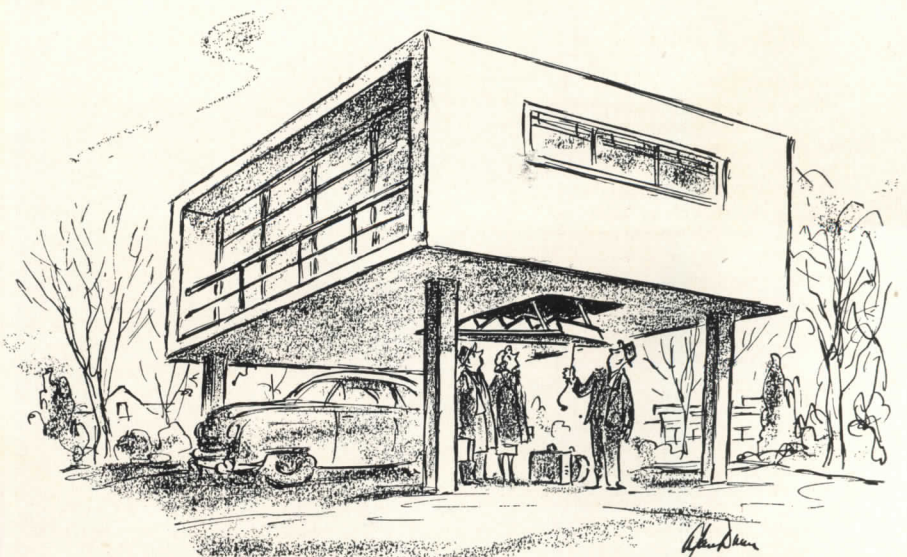
*Interim Guide for the Design of Buildings Exposed to Atomic Blast*, Pub. TM-5-3 (1952), 34 pp. — 15 cents.

Publications by the American Institute of Architects, available from Publications Order Department, The A.I.A., 1741 New York Avenue N.W., Washington 6, D. C., at 25 cents each:

*Civil Defense, the Architect's Part*

*Defense Measures in Multi-Story Buildings*

*Defense Measures in Schools*

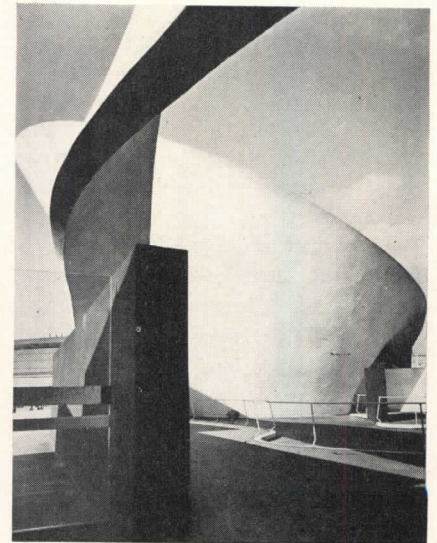
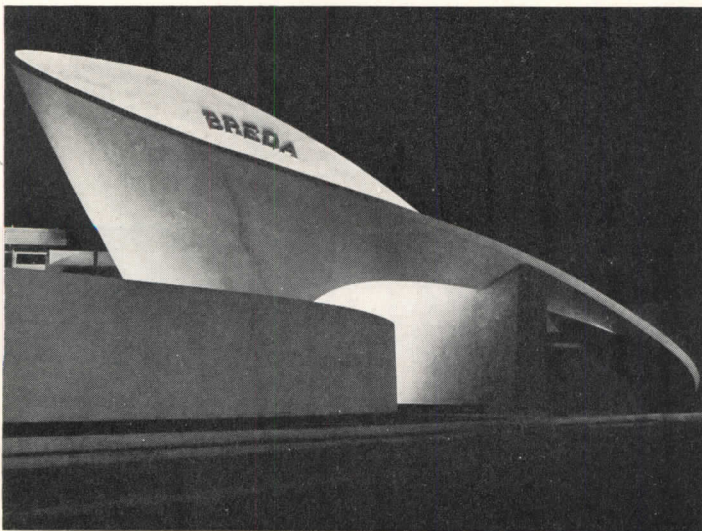
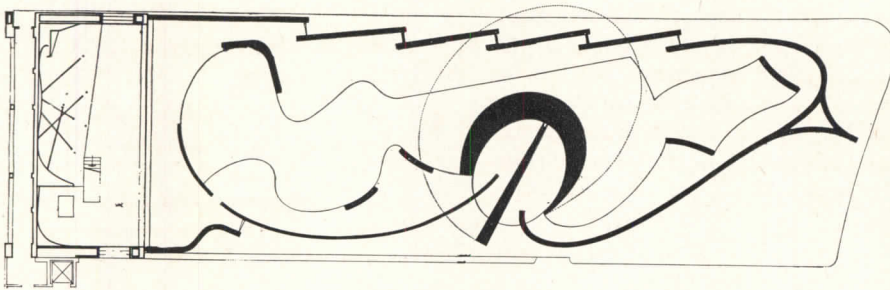
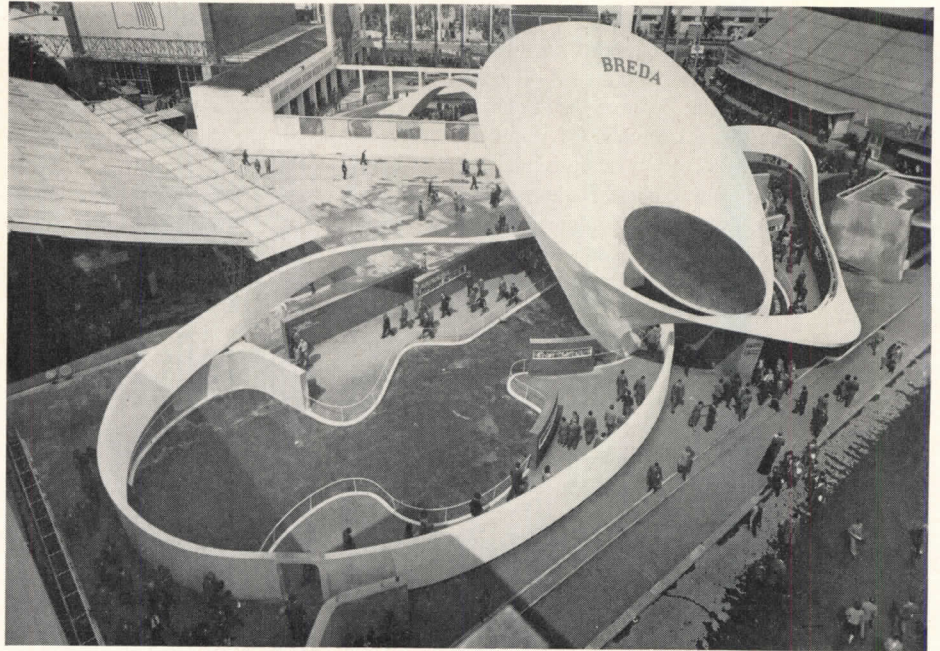


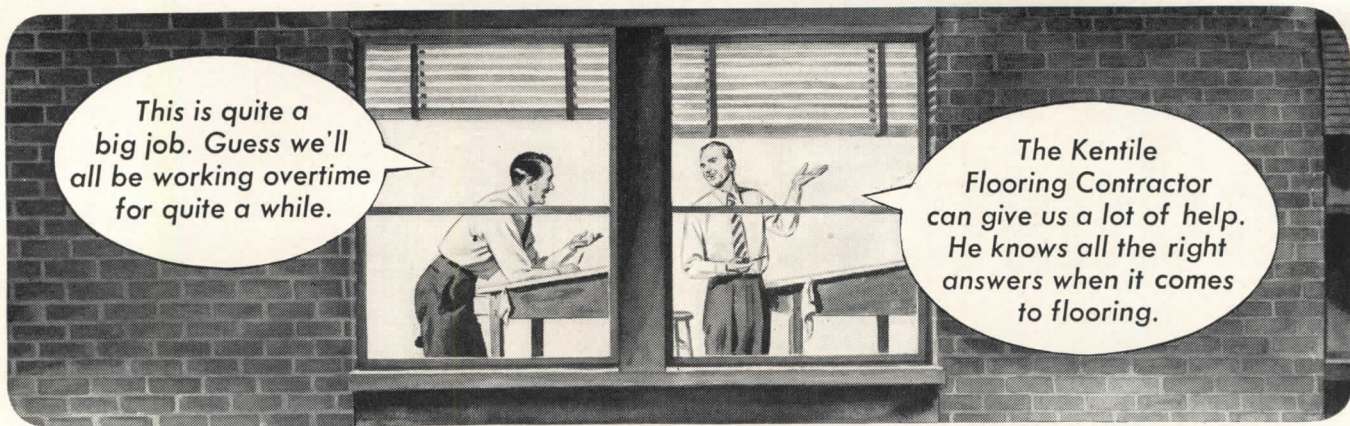
— Drawn for the RECORD by Alan Dunn

## THE RECORD REPORTS

### DESIGN FOR INDUSTRY: ARCHITECTURE AS SCULPTURE

THE STEEL AND PLASTER construction shown here was the official exhibit at the 1952 Milan World's Fair of La Breda Company, a 55-year-old Italian industrial concern which was reorganized last year into eight companies coordinated by a holding company. "Yesterday one, today unitary" was the theme the concern asked Architects Luciano Baldesari and his collaborator Marcello Gri-sotti to express in a structure that became a sort of fantastic hyperbole of the traditional "booth" (no samples!). Some 50 tons of steel frame were covered with cross wires and plaster; the cochlea, reaching a height of more than 50 ft with a maximum overhang of about 25 ft, was supported by 40 steel ribs; the "ribbon" was achieved by means of four 35 mm steel reinforcing bars along the four edges of the perimeter and fixed in place by stiff metal diaphragms.





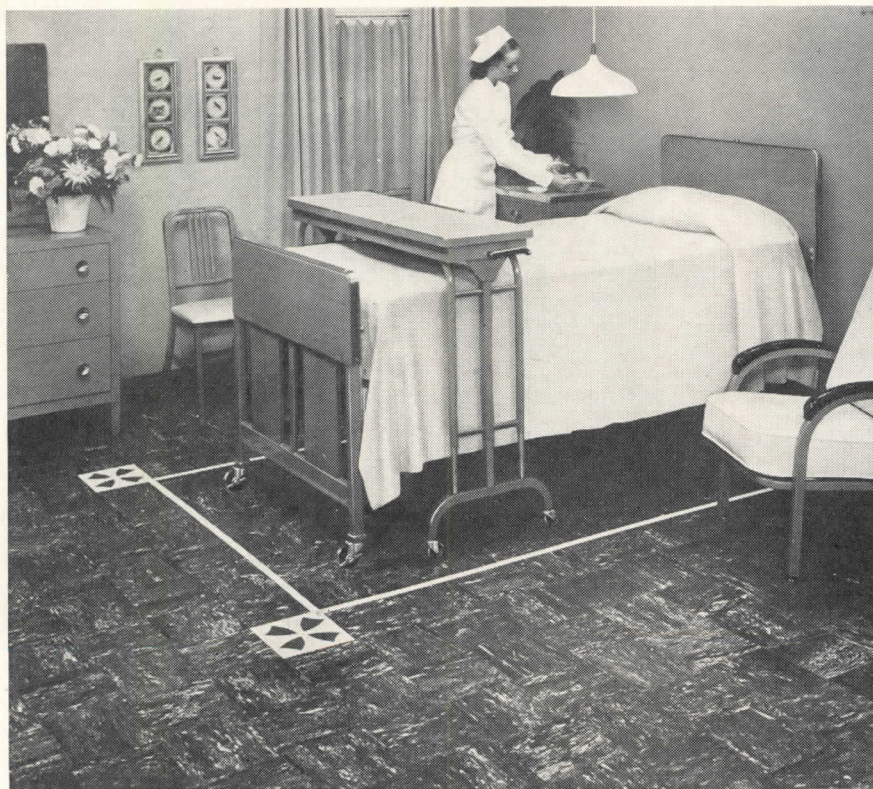
This is quite a big job. Guess we'll all be working overtime for quite a while.

The Kentile Flooring Contractor can give us a lot of help. He knows all the right answers when it comes to flooring.

## Consider the Kentile Flooring Contractor a willing addition to your staff

DUE to the complexities of modern flooring materials available today, selection is increasingly a job for trained flooring experts... men like the Kentile Flooring Contractor whose years of study and experience qualifies him to choose the right floor for every installation... the one floor that has most to offer in appearance, durability,

and economy in the use to which it will be put. Whether the problem is one of new construction or the remodeling of existing facilities, the Kentile Flooring Contractor is available night and day to help you select the floor that will give you the most for your money. Call on him as you would any member of your actual staff.



**KENRUBBER TILE FLOORS** are an excellent choice for hospital rooms, wards and corridors. Special advantages include unequalled quiet and comfort underfoot... the property of muffling the disturbing sounds and clatter of hospital carts and vehicles. And, KenRubber cuts maintenance cost. It cleans easily with mild soap, and an occasional waxing is the only "re-surfacing" it ever needs during long years of heavy traffic. Specify KenRubber, too, for its modern colorful beauty... an important morale factor for patients and staff alike.

KENTILE • SPECIAL (Greaseproof) KENTILE • KENRUBBER • KENCORK



KENTILE, INC., 58 Second Ave., Brooklyn 15, New York • 350 Fifth Ave., New York 1, N. Y. • 705 Architects Bldg., 17th and Sansom Sts., Philadelphia 3, Pa. • 1211 NBC Bldg., Cleveland 14, Ohio • 900 Peachtree St. N.E., Atlanta 5 Ga. • 2020 Walnut St., Kansas City 8, Mo. • 4532 South Kolin Ave., Chicago 32, Ill. • 1113 Vine St., Houston 1, Texas • 4501 Santa Fe Ave., Los Angeles 58, Calif. • 452 Statler Bldg., Boston 16, Mass.

# industry's

# New work

National Electric "Plug-In" Busway  
and "Lo-Loss" Feeder Busway... The only  
busways with such rugged construction!

National Electric Busways are especially designed to meet the rugged requirements of American industry. They offer the most economical, convenient, flexible and salvable layout possible for industrial or commercial installations. Check these *money-saving* "workhorse" features:

**TOUGH**—National Electric busway incorporates a heavy 12 gauge steel channel to independently support and protect the insulator.

**EFFICIENT**—With "Lo-Loss" Busway, voltage drop is less than 2.2 volts per 100 feet for a concentrated load. Where the load is distributed, the voltage drop is approximately 1 volt per 100 ft.

**FLEXIBLE**—"Lo-Loss" is approved by Underwriters' Laboratories for horizontal or vertical mounting.

**CONVENIENT**—Factory fabricated sections go up *quick*. With "Plug-In" Busway, machinery can be "plugged-in" anytime without shutting down the production line. Especially convenient for congested areas.

Approved by the Underwriters' Laboratories, Inc.

EVERYTHING IN WIRING POINTS TO  
**National Electric Products**  
PITTSBURGH, PA.  
3 PLANTS • 7 WAREHOUSES  
42 SALES OFFICES



## "PLUG-IN" BUSWAY

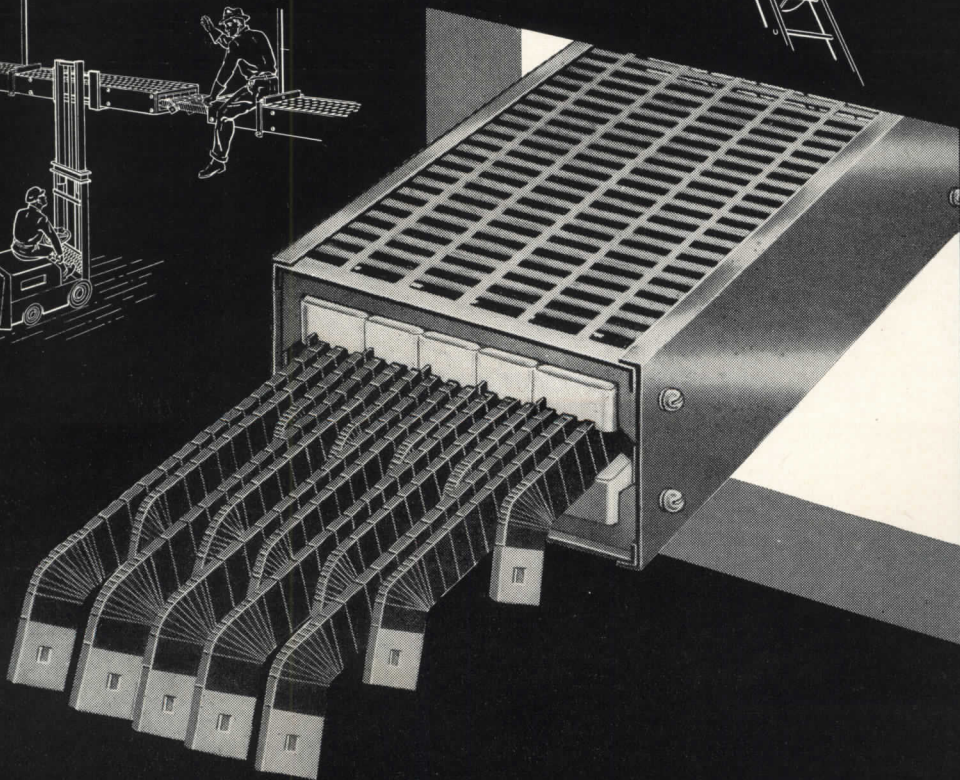
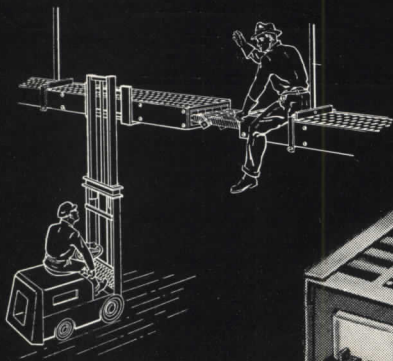
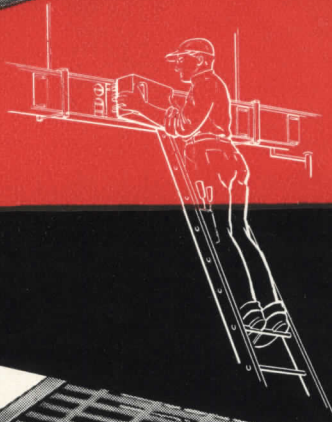
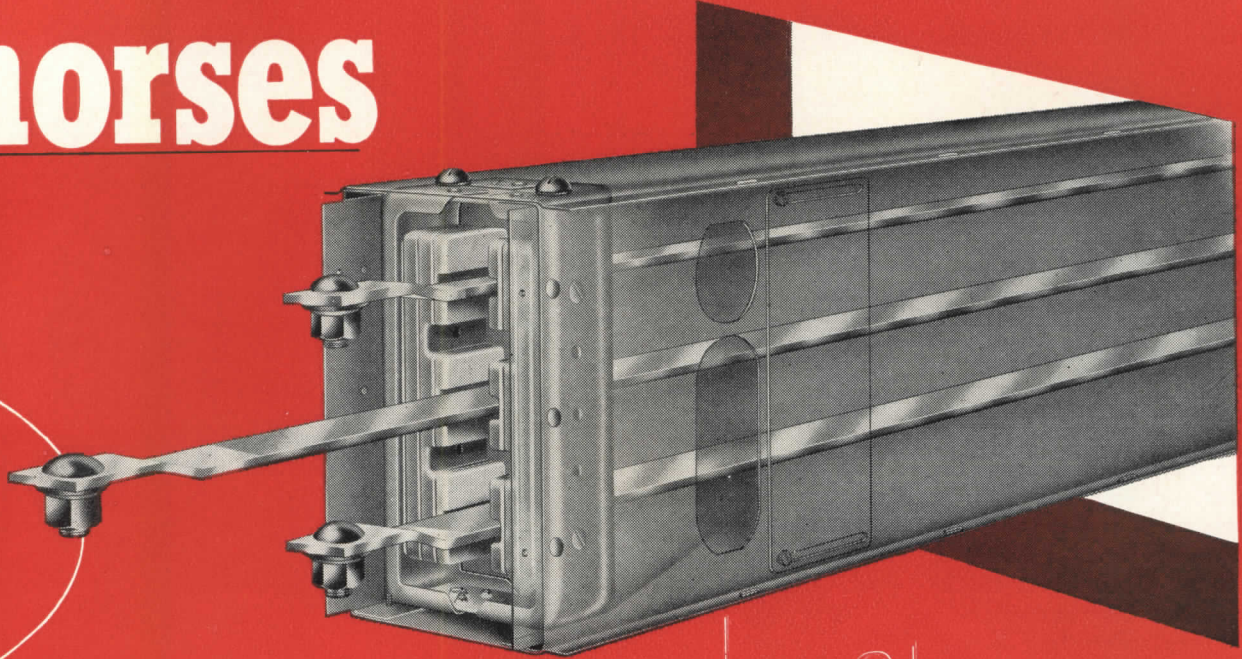
- Rolled Edge Copper Bus Bars.
- All Bus Bar Joints are electro-silver-plated and have a heavy coat of silver.
- Simplified, fool-proof, sliding type "plug-in" opening covers. No removable parts or springs.
- Neutral gray finish baked to a hard surface inside and out.
- Insulators supported in a sturdy 12 gauge steel channel frame withstand rough handling during shipment.

## "LO-LOSS" FEEDER BUSWAY

- "Lo-Loss" Feeder Busway is economical and efficient for conducting long runs of alternating current where voltage drop must be kept to a minimum. It is easy to install because single bolt contacts are used when joining sections.
- "Lo-Loss" Feeder Busway is designed for transmission of electrical current up to 4000 Amperes at 600 Volts or less.



# horses



# THE RECORD REPORTS

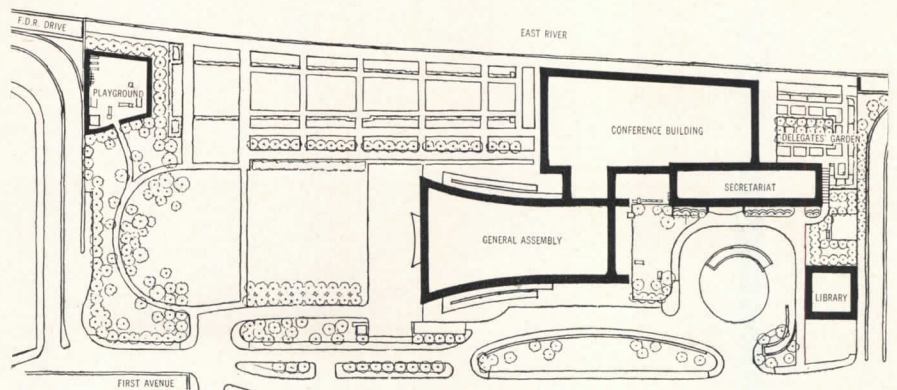
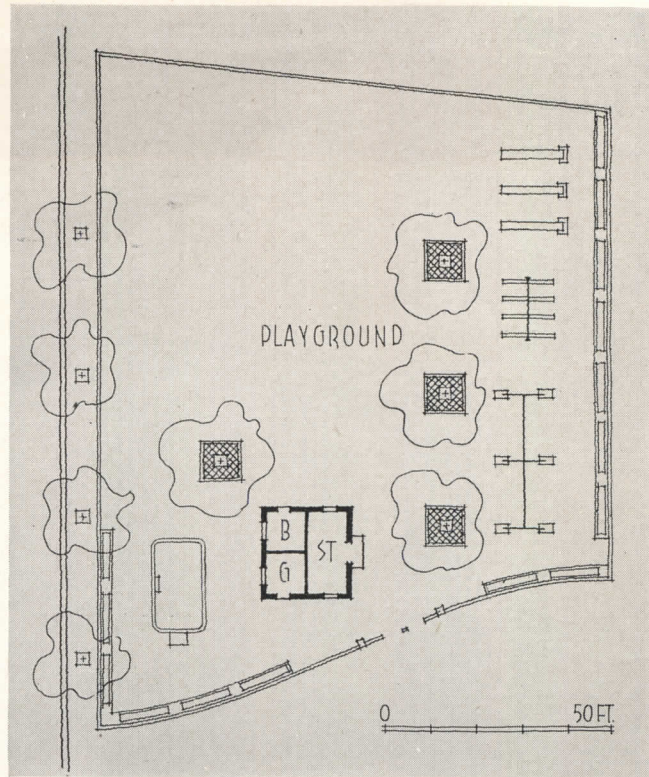
## APPROVE FINAL PLAN FOR DISPUTED U.N. PLAYGROUND

PLANS for the playground to be constructed as a part of the site development for United Nations Headquarters have been approved by the Headquarters Planning Office. Construction is to start when the site has been cleared and safe access has been provided, according to Assistant Planning Director Michael M. Harris.

The playground is intended primarily for use by neighborhood children, although it will probably also be used by children accompanying visitors to the U.N. Designed by Gilmore Clarke, who has done many projects for the New York Department of Parks and who will also be in charge of landscaping for the entire U.N. site, the project will be a variation of the standard type of playground for New York parks.

Announcement of acceptance of the Clarke scheme is the latest, but perhaps not the final episode in what has been one of the most spirited of the controversies concerning the U.N.'s permanent home. The dispute began when a group of New Yorkers offered to donate \$75,000 for the construction on the U.N. site of a playground scheme designed by architect Julian Whittlesey and sculptor Isamu Noguchi. This scheme was re-

*(Continued on page 366)*

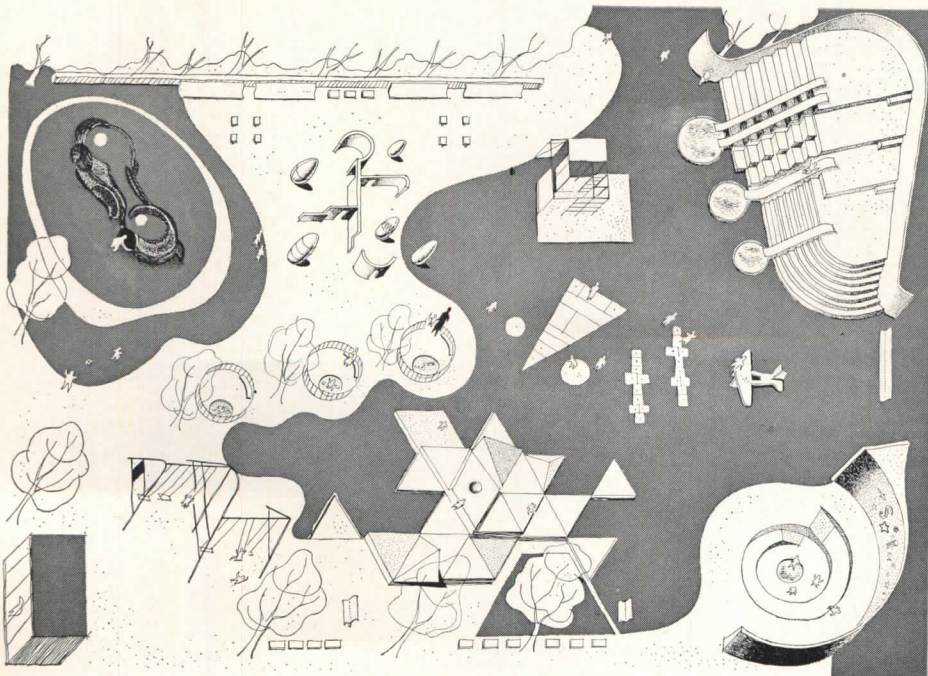


Grotto

Dodger

Jungle House

Climb and Slide



Swings

Sand Circles

Mountain

Aeroplane

Arena and Spray Pool

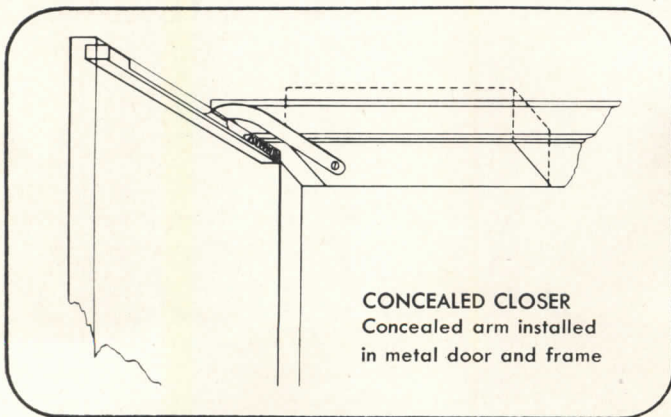
Top: accepted playground plan by Gilmore Clarke is variation of standard New York playground, will be paved with asphaltic concrete. Center: diagram shows location of playground in relation to principal U.N. buildings. Left: rejected scheme by Whittlesey and Noguchi. Designers emphasize that this is a collection of ideas for a playground rather than an actual solution for a specific problem



GEN. CONTRACTORS:  
Merritt-Chapman & Scott Corp.  
ARCHITECT:  
William Gehron, New York



## They've specified the special features of **NORTON CONCEALED DOOR CLOSERS** for the new **Utica State Hospital**



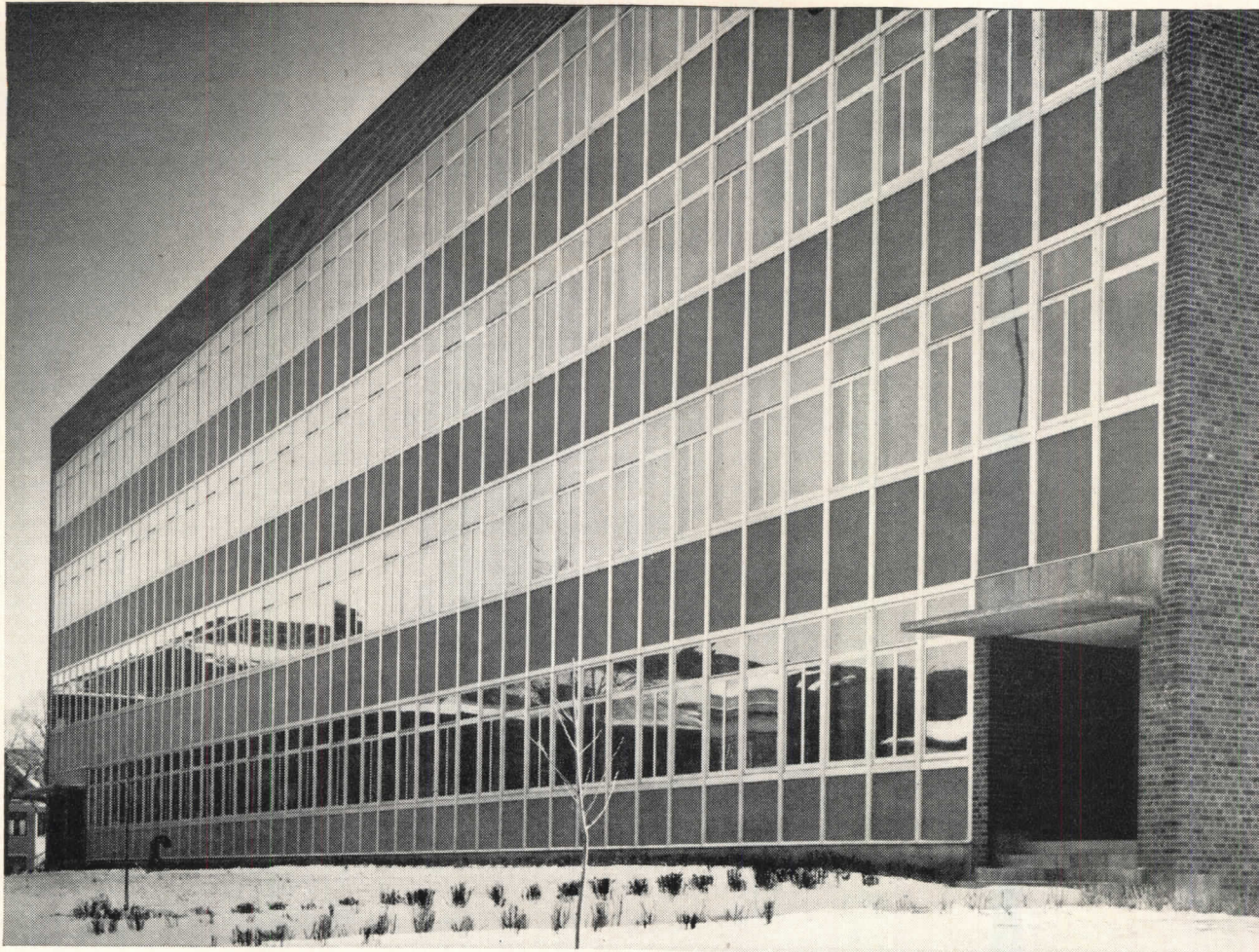
● Long range dependability is a **MUST** for all hospital equipment. That's why they've specified Norton Concealed Door Closers for the new Utica State Hospital. The ultimate in simplicity, this famous Closer is *the only one of its kind to employ a double piston operation*. Providing a special back check feature, this principle also permits application on either left or right hand opening doors. And, in addition to Norton durability, the Concealed Closer has a new synthetic rubber packing to give extra years of faultless service under the severest of operating conditions. For details, see your distributor or write to the Norton Door Closer Company, Berrien Springs, Mich.

# **NORTON**

**NORTON DOOR CLOSER COMPANY**

division of The Yale & Towne Mfg. Co.  
Berrien Springs, Michigan

**Norton Door Closers Are Preferred For Hospitals Everywhere**



# ...FOR FLEXIBILITY...DESIGN IN ALUMINUM...

In this laboratory, the designer, making skillful use of the many shapes, colors and textures available in aluminum, has made the window-spandrel pattern an expression of both the building's purpose and of the three-foot, eight-inch modular unit used throughout.

As the architects state, "The clean lines of the exposed aluminum surfaces give a straight forward appearance to the entire structure, which seems appropriate in view of the function of the building. Aluminum seemed the natural choice for its light-weight construction, ease of maintenance and regional climatic considerations."

In the planning stages of this, and nearly every other outstanding architectural use of aluminum, Alcoa sales engineers worked with the architects and engineers. They are at your service. For information on any form of aluminum, call your nearby Alcoa sales office or write:

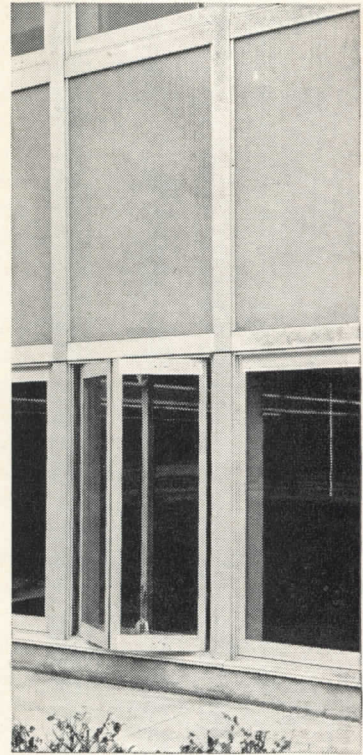
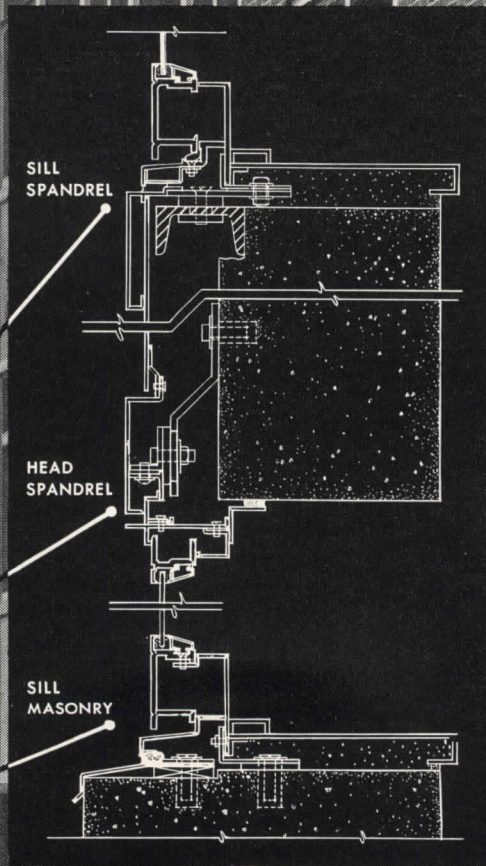
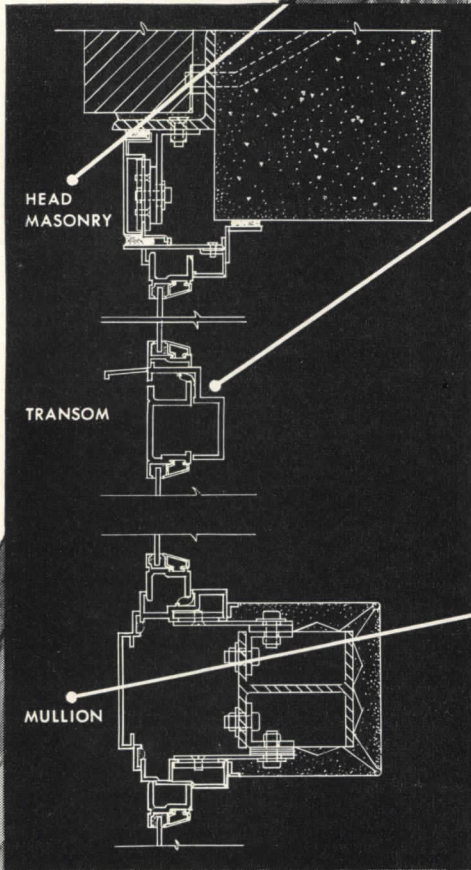
# ALCOA

FIRST IN



ALUMINUM

**ALUMINUM COMPANY OF AMERICA**  
1888-K GULF BLDG. • PITTSBURGH 19, PA.



Chemical Engineering Building, University of Minnesota, Magney, Tusler & Setter, Architects. Roy Jones, University of Minnesota Advisory Architect. H. M. Leighton Company, General Contractor. The Flour City Ornamental Iron Company, Ornamental Metal Subcontractor, including windows. Alcoa Aluminum used in windows, spandrels, entrance frames and trim, stairway handrails and copings.

## THE RECORD REPORTS

### Centennial (Continued from page 11)

by his own criteria for the "complete building" of "functional workability and beauty" there is evidence today of a good deal of progress in the design of such buildings as factories, stores, schools and shopping centers.

In the area of community planning Mr. Merrill saw a "major challenge to architects and engineers everywhere. We cannot be satisfied with the quality of our all-too-few new buildings when the majority of our people are forced to live in antiquated structures which have long outlived their usefulness."

Dean Grinter traced the evolution of structural design from the realm of art to the realm of science through the gradual development of methods of analysis, experimentation and — finally — standardization.

These are the tools of science which have produced a fabulous contrast: "The ancient world during three or four millenia produced a few hundred structures that kindle our imagination. We have produced thousands of equally astonishing structures in a generation."

Dean Grinter foresaw an ever increasing influence of analysis and experimentation upon design — in the next century, he suggested, three-dimensional stress analysis may well be as common as analysis of two-dimensional shapes or assemblages is today.

But design has "other faces" — social and economic considerations, esthetic and functional aspects; and "design will therefore always require the exercise of highly developed judgment which is an application of art tempered and guided by scientific knowledge."

Atomic power, plastics, prestressed concrete, heating and ventilating and architectural design: these, according to Professor Voss, are the fields to watch for major developments affecting building materials and methods.

Some of the possibilities: *prestressed concrete* made of low-cost blocks assembled at ground level and prestressed to fabricate larger units — for walls, beams and slabs; *exterior walls* of buildings as massive heating or ventilating ducts with apparatus concentrated in basement and roof areas; *air conditioning equipment* no longer custom-built for each building but made in movable units provided with strategically-located wall shafts and used only when necessary; growing use of *movable partitions* and *design for multiple usage*.



A.S.A. panel on "A New Approach to Cost Reduction in the Building Industry": above: William F. Scheick, William S. Kinne; below: F. M. Hauserman, Arthur Bohnen. Willard Chevalier of McGraw-Hill served as moderator



## MORE KNOWLEDGE SEEN AS KEY TO MODULAR ACCEPTANCE

WHAT'S NEEDED TO speed the progress of the modular method is more knowledge about modular coordination in every segment of the building industry, from drafting board to building site.

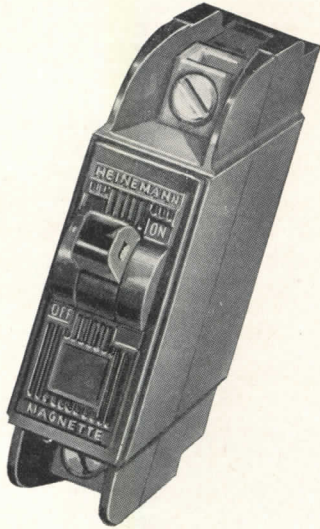
This was the consensus of the speakers on the panel discussion sponsored jointly by the American Institute of Architects, the National Association of Home Builders and the Producers' Council at one session of the Third National Standardization Conference of the American Standards Association at Chicago September 8.

Members of the panel, a building materials manufacturer, two architects and a house builder, also agreed that experience has proved the modular method can yield significant savings in time and money for any member of the building team who will use it, though savings will certainly be greatest if everybody

connected with a given project uses it.

William F. Scheick, A.I.A., executive director of the Building Research Advisory Board, urged that an effort be made to collect evidence of successful applications of modular as proof of its value for members of the industry who have been reluctant to try it.

William S. Kinne Jr., professor of architecture at the University of Illinois, described the method used to present modular to students not as a separate subject but as one of their tools in design. F. M. Hauserman, president of the Producers' Council and of E. F. Hauserman Company, and Arthur Bohnen of the National Association of Housing Officials and the National Association of Real Estate Boards, testified to their own experiences with the economies of modular and their belief in its potential for the industry.



THIS IS NOT  
 a **TAFT-HARTLEY**  
 CIRCUIT BREAKER

Unique in the field of circuit protection equipment, **HEINEMANN** Circuit Breakers do not require a "cooling-off period." Immediately after correction of a fault, either short circuit or overload, **HEINEMANN** Circuit Breakers can be turned ON. There is no waiting for a thermal element to cool . . . no wasted production time . . . no reset procedure . . . just restore service by throwing the switch to the ON position.

**NO WAITING TO RESET . . . YET NEVER NUISANCE TRIPPING**

While there is no waiting to reset after tripping, **HEINEMANN** Circuit Breakers do provide time delay before tripping to allow for **temporary, harmless** overloads, thus avoid nuisance tripping. This allows for the initial inrush of starting motors and other equipment.

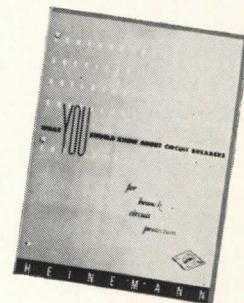
**TIME DELAY FOR OVERLOADS . . . YET INSTANTANEOUS SHORT CIRCUIT PROTECTION**

Beyond providing time delay for overloads, the hydraulic-magnetic operating principle of **HEINEMANN** Circuit

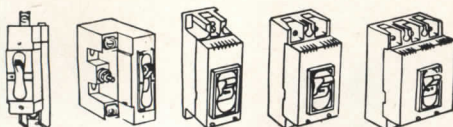
Breakers differentiates between overloads and short circuits. **HEINEMANN** Circuit Breakers always trip instantly at ten times the rated current . . . providing the fast protection you must have for your wiring and equipment even at the low short circuit values.

**KNOW THE FACTS . . .**

Send for this new informative booklet entitled, "WHAT YOU SHOULD KNOW ABOUT CIRCUIT BREAKERS." Ask for Manual 101 . . . no obligation, of course.



**HEINEMANN ELECTRIC COMPANY**  
 115 Plum Street • Trenton 2, N. J.



Heinemann Circuit Breakers. One, two and three pole. 10 milliamps to 100 amperes.



## NEWS FROM CANADA by John Caulfield Smith

### *Prestressed Concrete Used For Municipal Grandstand*

A LINEAL PRESTRESSED CONCRETE grandstand believed to be the first of its kind in North America is under construction as a civic project at Sherbrooke, Que. Cost is estimated at \$255,000.

Frames of the grandstand are precast, as are bleacher seats and roof slabs. Both seats and slabs are produced at Cap St. Martin, Que., then shipped to Sherbrooke.

Architects are Audet, Tremblay & Audet; consulting engineers are Crepeau, Cote & Lemieux. Both are Sherbrooke firms.

### *Make Awards Next Month in Second Massey Competition*

THE SECOND NATIONWIDE COMPETITION for the Massey Medals for Architecture will end next month with announcement of the winners at the opening of the exhibition of entries in the National Gallery in Ottawa. Closing date for receipt of entry forms is October 6.

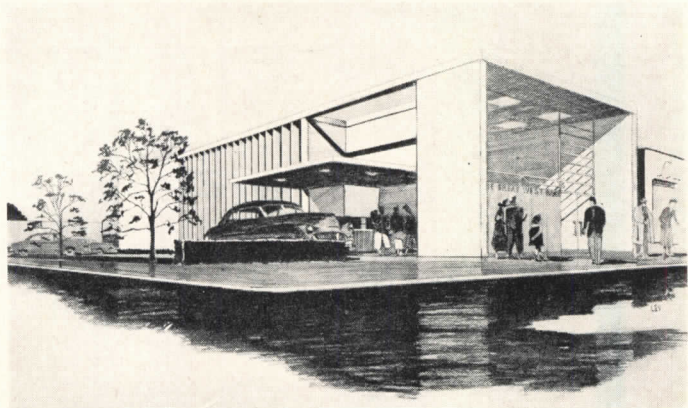
The initial competition sponsored by the Massey Foundation to encourage national recognition of architectural distinction and to stimulate public interest in architecture was held in 1950. It was announced then competitions would be held every two or three years.

The three-man jury has been chosen according to a ruling that two members must be Canadian architects, the third a nonresident architect. John B. Parkin of Toronto and John A. Russell, director of the School of Architecture of the University of Manitoba, are the Canadians; Pietro Belluschi, dean of architecture and planning at Massachusetts Institute of Technology, is the non-resident.

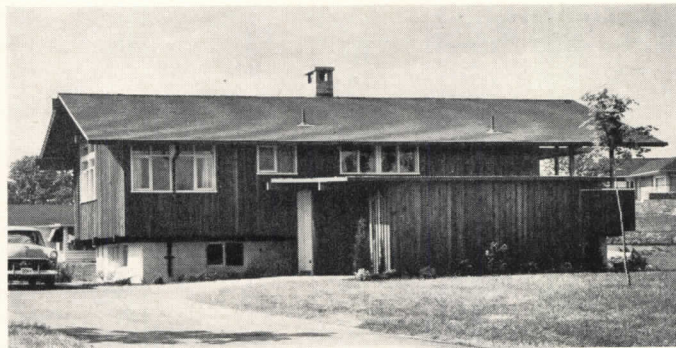
Silver medals will be awarded to the architect or firm whose work is considered most distinguished in each of 15 categories; a gold medal will be presented for the work found outstanding among all the entries.

In line with the effort to have the competition serve to educate the lay public to the architect's service, the winning entries and some others will be sent on a nationwide tour. Rt. Hon. Vincent Massey, C. H., Governor General of Canada, will be present to open the exhibit November 21.

(Continued on page 32)

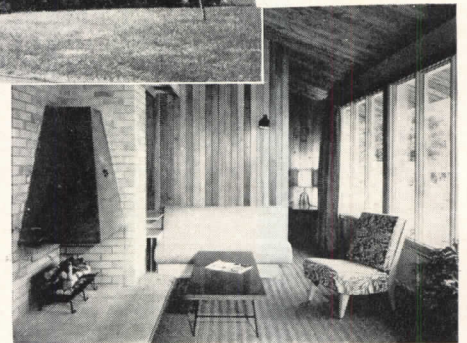


Above: Drive-In Bank, North York, Ont., is part of suburban Toronto's Craig Plaza Shopping Development. Architects, Venchiarutti & Venchiarutti



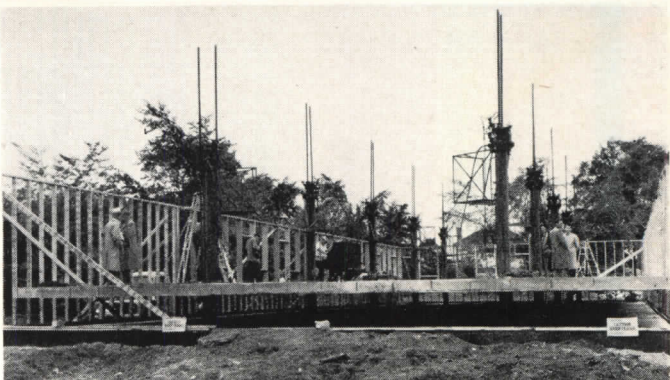
Ken Bell

"Trend House," above and right, in Thorncrest Village near Toronto, was designed for the British Columbia Lumber Manufacturer's Association to display advantages of wood as building material. Architects: Sharp & Thompson, Berwick, Pratt, Frederick S. Brodie, Associate



Below: first application in eastern Canada of the Youtz-Slick lift-slab technique was employed in plant for Isotope Products, Ltd., Oakville, Ont. Architects for the project were Crawford & Hassig

Gilbert A. Milne



# ANNOUNCING an ARCHITECTURAL COMPETITION

Dedicated to ideas for  
bathrooms, kitchens and utility rooms

---



**Four Awards of \$3,000 each. Four Awards of \$1,500 each. Four Awards of \$750 each and 20 Awards of \$100 each. Total \$23,000**

Sponsored by Crane Co., Chicago, Illinois

Approved by the Committee on Competitions of the American Institute of Architects

Professional Adviser, Howard L. Cheney of Chicago, Illinois, Fellow of the American Institute of Architects

Competition closes 5 P.M. Monday, Dec. 15, 1952

---

Because bathrooms, kitchens and utility rooms are functional centers around which family life revolves, each of these rooms involves common human problems.

Ideas are needed that will help solve these problems in ways that will make each of these rooms more useful, more practical, more convenient and more attractive.

These ideas may be suited for new construction or for remodeling existing homes.

Competition is open to architects, designers, draftsmen and college students of architecture who are residents of the continental United States, except that the following are not eligible: Contest Jury members and families, employees and families of the Crane Co.,

its subsidiaries and its advertising agencies.

All awards will be made on the basis of the originality and practicability of the ideas submitted.

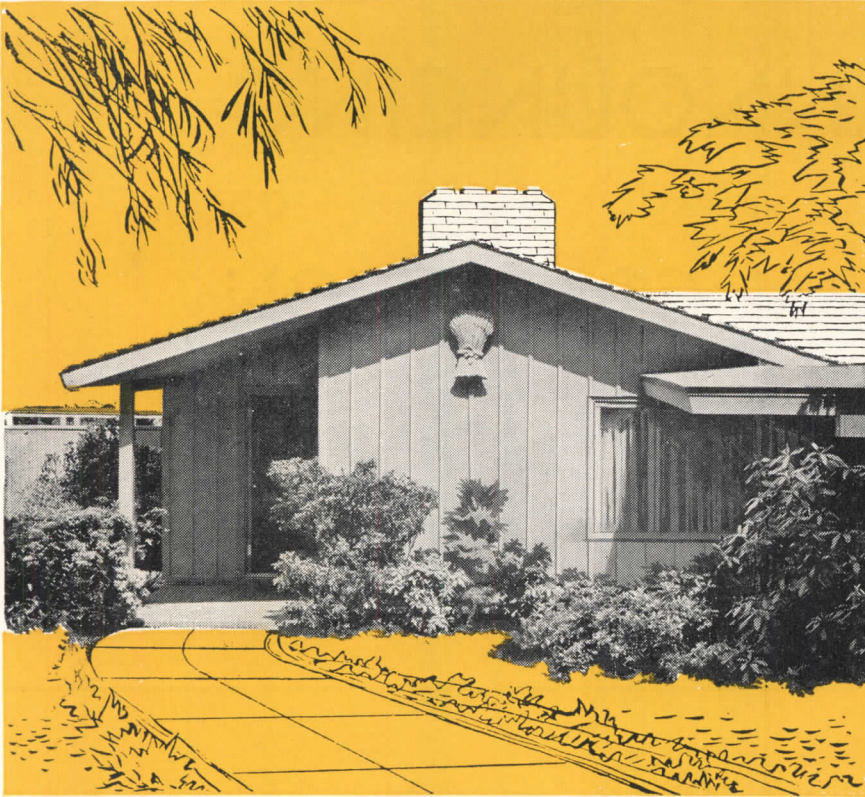
Winning entries will be decided by a Jury which will consist of three architects, a homebuilder and an industrial designer, whose names will be announced after the Jury has met and selected the winning solutions.

Information given here is to be considered as an announcement only. Mandatory requirements and detailed information as to the procedure to be followed are fully covered in a program now ready for mailing.

Your copy of the program will be mailed promptly upon request to:

## CRANE CO.

836 South Michigan Avenue, Chicago 5, Illinois



## Beauty, Adaptability, Economy— Get All 3 With Plywood Siding\*

OF ALL SIDING MATERIALS, Exterior plywood is the most adaptable to various design treatments. It can be used to create board and batten siding . . . flush surface . . . or cut in third or half panel widths and applied as extra-wide lapped siding. It can be used in combination with other materials such as brick or masonry to achieve interesting texture contrasts.

And of all *quality* siding materials, Exterior plywood is least expensive. Least expensive in two ways: first, Exterior plywood actually costs the same or *less* per square foot than other quality materials; second, plywood's large size and easy workability speed work, cut labor and application time and costs up to *one-third!*

Exterior plywood siding is durable, too. It won't shatter, split, or puncture. And the completely waterproof adhesives used between plys are *more durable* than the wood itself!



**Douglas Fir**  
**Plywood**

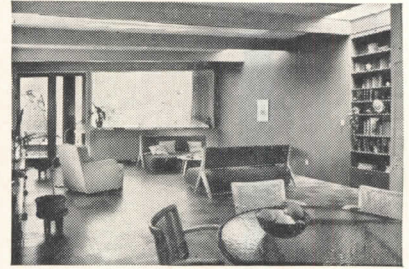
AMERICA'S BUSIEST BUILDING MATERIAL



\*PlyShield® is the siding grade of waterproof-bond Exterior-type plywood. One side is of highest appearance; for economy, limited defects are permitted in back. For use as siding, gable ends, etc. Other Exterior grades with 2 faces of highest appearance are available for single wall partitions, fences, etc.

## PANEL DISCUSSION

### California Architects Use Plywood Shear Walls

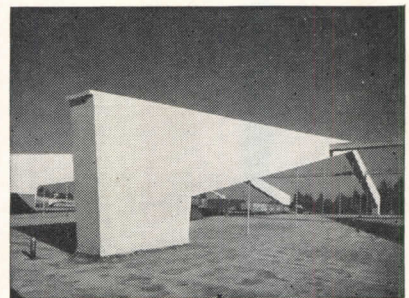


Architects Smith and Williams, Pasadena, Calif., are making use of plywood shear walls in many of their current homes to permit use of large glass areas on exterior walls. Box-girder type shear walls compensate for loss of rigidity and also permit great freedom in placement of nonbearing interior partitions.

The shear walls are carefully engineered to handle the wind and seismic loads which might be encountered. Calculations are based on the weight of the house, exterior surface area and floor area. Studs 2x4, 2x3 and 1x3 are used depending on strength requirements. According to the architects, plywood is the only material which can be used satisfactorily with such small studding. In the photo above, shear wall is at right; it is the only one in this particular home which uses 2x4 studding.

Where the shear wall is on the inside,  $\frac{3}{8}$ " PlyPanel grade plywood is generally used. Exterior plywood is used for the occasional short shear wall that is on an outside wall. Nailing is important and proper nail placement must be calculated; usually it is on six-inch centers. For additional information on shear walls and other plywood use-data, write Douglas Fir Plywood Association, Tacoma, Wash.

### Plywood Shapes Unusual Concrete Roof Frames



Plywood-formed concrete frames were used to replace conventional posts and roof trusses to achieve an unusual degree of interior flexibility in the Fred Meyers Burlingame Shopping Center Building, Portland, Oregon. Photo shows frames viewed from roof; vertical haunches project down through the roof to ground. Trussed wood joists are suspended from tie-beams secured to the frames. Because the frames are a definite architectural feature, concrete had to be smooth, fin-free. According to Leslie E.

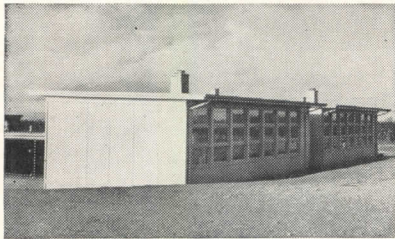
(Advertisement)



Poole, engineer in charge of construction, plywood offered the simplest, least expensive method for obtaining the smooth surfaces. In fact, because of its smooth, neat appearance, the concrete required no further finishing once forms were stripped. Exterior PlyForm panels were re-used up to eight times in forming the five frames. The building was designed by Engineer Leslie E. Poole; contractor: H. M. Hocken, Portland.

### Portable Units Help Solve Schoolroom Shortage

To solve pressing classroom shortages due to shifts in population, school systems in many communities are turning to portable classrooms as a quick and economical solution. In Tacoma, Washington, 60 are used by the city's schools. Thirty-five are of lightweight plywood construction; ten were built last year by E. Goettling & Sons, general contractors, from revised designs by Mock and Morrison, architects.

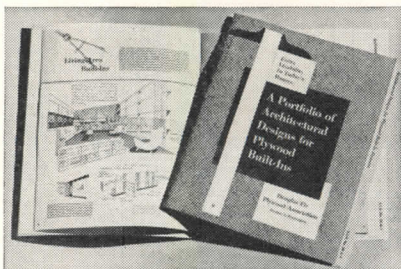


"We've been using plywood for four years," says James Hopkins, assistant superintendent of schools in charge of construction. The portable schoolrooms are fully as well built as the average house and we expect them to be good for 50 years. Plywood construction is lighter and gives maximum bracing strength—a must in movable buildings."

Each building is 24'x36'. Plywood is used for subfloors, roof sheathing, paneling, built-ins and exterior siding. Modular design, based on standard plywood panels, helps speed work and cut costs. Plywood not only makes a sounder, tighter building, but it presents a clean, modern appearance—a far cry from the unpleasant "temporary look" of other similar structures.

### Design Portfolio Available

A portfolio of prize-winning designs for plywood built-ins is now available to architects, designers and builders. The booklet contains over 50 designs judged best in the "Better Living Home" architectural contest. For free copy write Douglas Fir Plywood Association, Tacoma 2, Wash.



(Advertisement)



# Nail down building costs with PlyScord® Subflooring

THE REAL STORY of construction costs isn't always shown on the bill of materials. It's the *applied* cost that counts! PlyScord subflooring can be laid in less than half the time required for lumber subflooring. Big, work-speeding panels are light, easy to handle . . . cover large areas quickly . . . fit standard joist spacing without wasteful sawing and fitting . . . require far fewer nails.

PlyScord subflooring means *better* construction, too. Plywood's rigid plate-like action protects against violent racking action of wind or earthquake. Strong, rigid panels provide a solid, squeak-free base for finish flooring . . . protect against drafts from below. PlyScord subfloors won't cup, shrink or swell. Result: finish floors look better, last longer.

Plan now to include PlyScord in your next bill of materials—for better construction, for building economy.

*Douglas Fir*  
**Plywood**



AMERICA'S BUSIEST BUILDING MATERIAL



® PlyScord is the unsanded construction grade of Interior-type plywood bonded with highly water resistant glues. For subflooring, sheathing, backing, one-use forms. PlyScord is a registered grade-trademark identifying quality plywood manufactured in accord with U. S. Commercial Standards and inspected by Douglas Fir Plywood Association (DFPA).

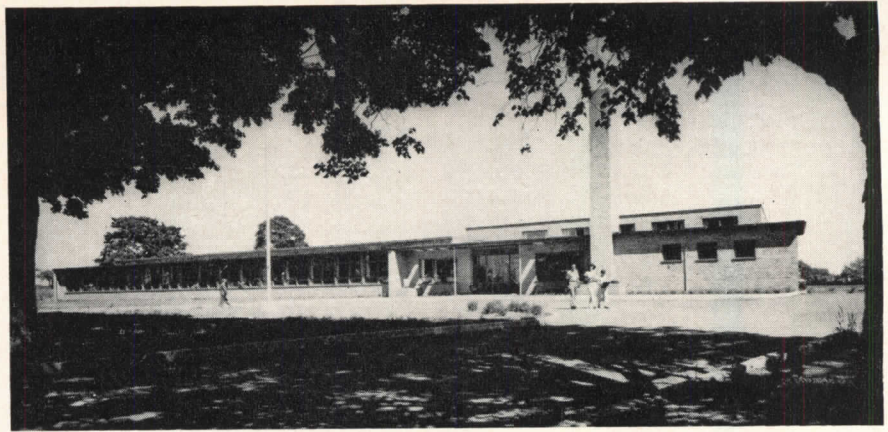
# THE RECORD REPORTS

## CANADA

(Continued from page 28)

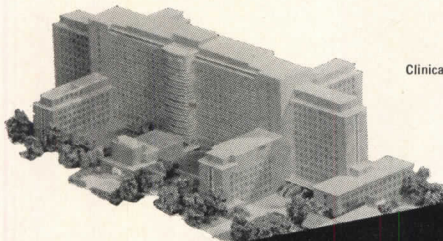
### August Contract Awards Off, But Housing Shows Increase

Total value of construction contract awards for August was \$175.7 million, \$11.8 million below the figure for the same month last year. The residential



Panda

Markdale, Ont., High School; architects were Shore & Moffat, Toronto



Clinical Center, National Institutes of Health  
Bethesda, Maryland

category was the only one to reflect an increase; at \$41.3 million it was 6.1 per cent over the August 1951 level.

The cumulative eight-months total as reported by MacLean Building Reports Ltd. also shows a decrease—\$472.8 million. The eight-months figure for 1952 was \$1219.9 million.

**Von Duprin**  
Protects millions of lives... daily!

O'Connor Hospital San Jose, Calif.

Maguolo & Quick, Frank T. Georgeson, Architects - Engineers



### Engineering Students Honored For Papers on Construction

Leonidas Zariff, a recent honor graduate in civil engineering at McGill University, has received the top award in this year's Canadian Construction Association competition for the best thesis on construction subjects prepared by senior engineering students at Canadian universities.

The subject of Mr. Zariff's thesis was the Peribonka Cableway, a specialized heavy-duty cableway set up at a cost of \$500,000 to speed construction of a hydroelectric power development at Chute du Diable on the Peribonka River in Quebec's Lake St. John area.

Purpose of the Association's competition is to stimulate interest among engineering students on construction problems in the hope of developing new techniques.

In addition to Mr. Zariff's prize of \$150 and an engineer's handbook, awards of \$50 each and books were made to the following students:

R. A. MacDonald, University of British Columbia—The Erection of the Salmon River Bridge; J. M. Crook and O. K. C. Mang, University of Saskatchewan—Prevention of Frost Heave in Curling Rinks; J. H. Dick and W. A. Johnson, University of Manitoba—Investigation of Ground Movement;

(Continued on page 34)



Ease and safety combined

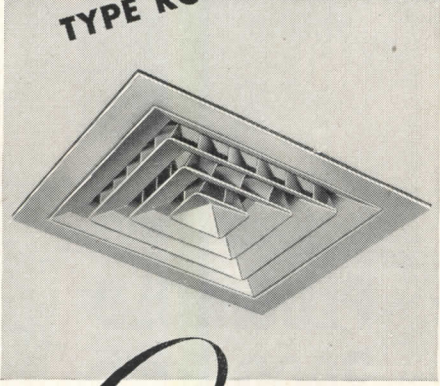
VONNEGUT HARDWARE CO. • VON DUPRIN DIVISION • INDIANAPOLIS, INDIANA

● Hundreds of hospitals from coast to coast are equipped with Von Duprin exit devices—And for good reason! Since Von Duprin originated this "safe exit" device more than 40 years ago, Von Duprin devices have been constantly refined and improved to earn the confidence and trust of millions of people.

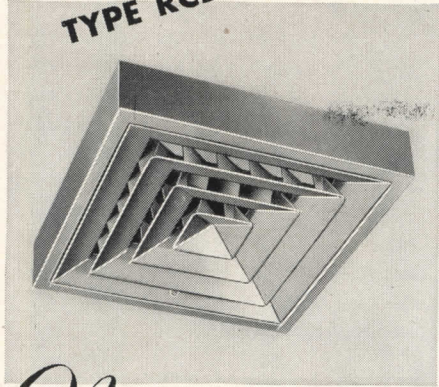
Peace of Mind and Security of both patients and staff—these are the advantages of safeguarding your hospitals with Von Duprin—"the safe way out!"



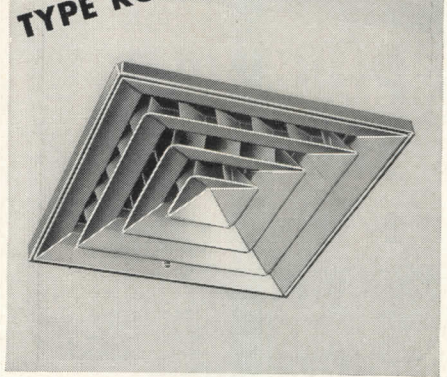
TYPE RC . . . For Standard Installations



TYPE RCDF . . . For Drop Frame Installations



TYPE RCTC . . . For Tile Ceilings



*Announcing New...*

# AGITAIR<sup>®</sup> TYPE RC

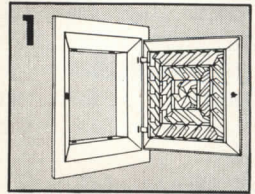
## WITH REMOVABLE DIFFUSER CORE

. . . and three distinct styles of mounting frames. Highly efficient in performance, attractive in appearance and designed to meet any and all conditions.

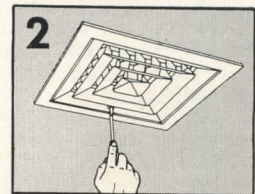
The New AGITAIR diffusers are the result of painstaking research to provide you with square and rectangular air outlets that are practical from every standpoint. The removable core with unlimited air distribution pattern possibilities, and the new mounting frames incorporate many AGITAIR exclusive features and desirable functional qualities.

AGITAIR "RC" diffusers are available in a wide variety of sizes and patterns . . . easy and economical to install. For complete engineering and application data contact your nearest AGITAIR representative or write direct to Air Devices Inc.

### 1-2 YOU'RE THRU...



*Insert diffuser "slide hinges" into frame slots*



*Turn mounting lock 90° with screw driver*

WRITE FOR COMPLETE INFORMATION

## AIR DEVICES INC.

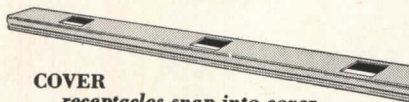
17 EAST 42<sup>nd</sup> STREET • NEW YORK 17, N. Y.

AIR DIFFUSERS • AIR AND GREASE FILTERS • EXHAUSTERS

# FASTER TO INSTALL

## PLUGMOLD 2000 *with* SNAPICOIL by WIREMOLD

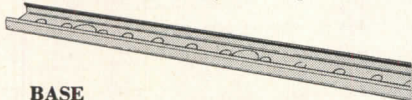
**TIME-  
SAVING  
FEATURES**



**COVER**  
receptacles snap into cover . . .  
cover snaps into base



**SNAPICOIL**  
pre-wired in 50-foot Snapicoils



**BASE**  
mounts in a continuous run

Installing multiple convenience outlets is a real "snap" with Plugmold 2000 and Snapicoil! You *snap* the receptacles into the cover and *snap* the cover into the base—a few simple snap-over fittings complete the job! Takes minutes instead of hours.

Write today for new, free Plugmold 2000 book!

### PLUGMOLD 2000

WIREMOLD'S *New*  
multi-outlet system

THE WIREMOLD COMPANY  
Hartford 10, Connecticut

## THE RECORD REPORTS

### CANADA

(Continued from page 32)

Glen A. Weaver, University of Toronto — Winter Concreting.

Also N. D. Garbutt, Queen's University — Prestressed Concrete for Culvert Construction; P. G. Beaulieu, Ecole Polytechnique de Montreal — Application de la Méthode de Distribution des Moments Encastres au Caleul d'un Cadre Rigide; B. B. Blais, Université Laval — Caserno pour Logement de Troupes-Citadelle, Quebec; J. H. Whalen, University of New Brunswick — The Duplessis Bridge.

### News Notes

- Ramsay Traquair, emeritus professor of architecture of McGill University, died in the Memorial Red Cross Hospital at Guysborough, Nova Scotia, an institution he had a large share in creating after his retirement in 1939. Professor Traquair had been known for archaeological and antiquarian as well as architectural interests.

- Seven massive metal doors, Canada's gift to the United Nations, are being installed in the main entrance to the new General Assembly Building at UN headquarters in New York. The doors are simple in design, made of an untarnishable alloy with four glass panels set horizontally in each door. Beside each panel is a plaque incorporating figures symbolizing truth, peace, justice and fraternity. Ernest Cormier, Montreal architect, designed the doors.

- Construction workers are averaging 21 per cent better pay this year than last, according to Bureau of Statistics reports. On June 1 they were getting 142.3 cents an hour compared with 125.9 cents on the same date last year. Weekly wages of construction workers averaged \$58.91 as of June 1, compared with \$53.70 for factory workers.

- The interest rate under the National Housing Act is 5¼ per cent on new joint loans approved as from September 1. The previous rate, established in June 1951, was five per cent.

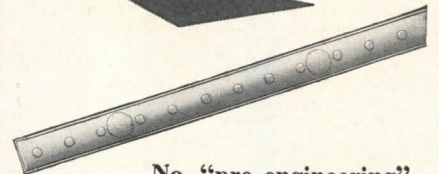
Interest rates on new loans of other types under the Act are also being in-

(Continued on page 36)

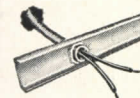
# EASIER TO INSTALL

## PLUGMOLD 2000 *with* SNAPICOIL by WIREMOLD

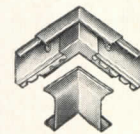
**CUTTING  
and  
FITTING  
reduced  
to a minimum**



No "pre-engineering" when you install Plugmold 2000 multiple convenience outlets . . . every step you take gets the job done! . . . Plenty of knockouts for feeding and mounting in Plugmold 2000 base—no drilling! . . .



You can feed in at any convenient point—no special fittings required! . . . Elbow fitting covers snap on and overlap—no precision cutting required!



Write today for new, free Plugmold 2000 book!

### PLUGMOLD 2000

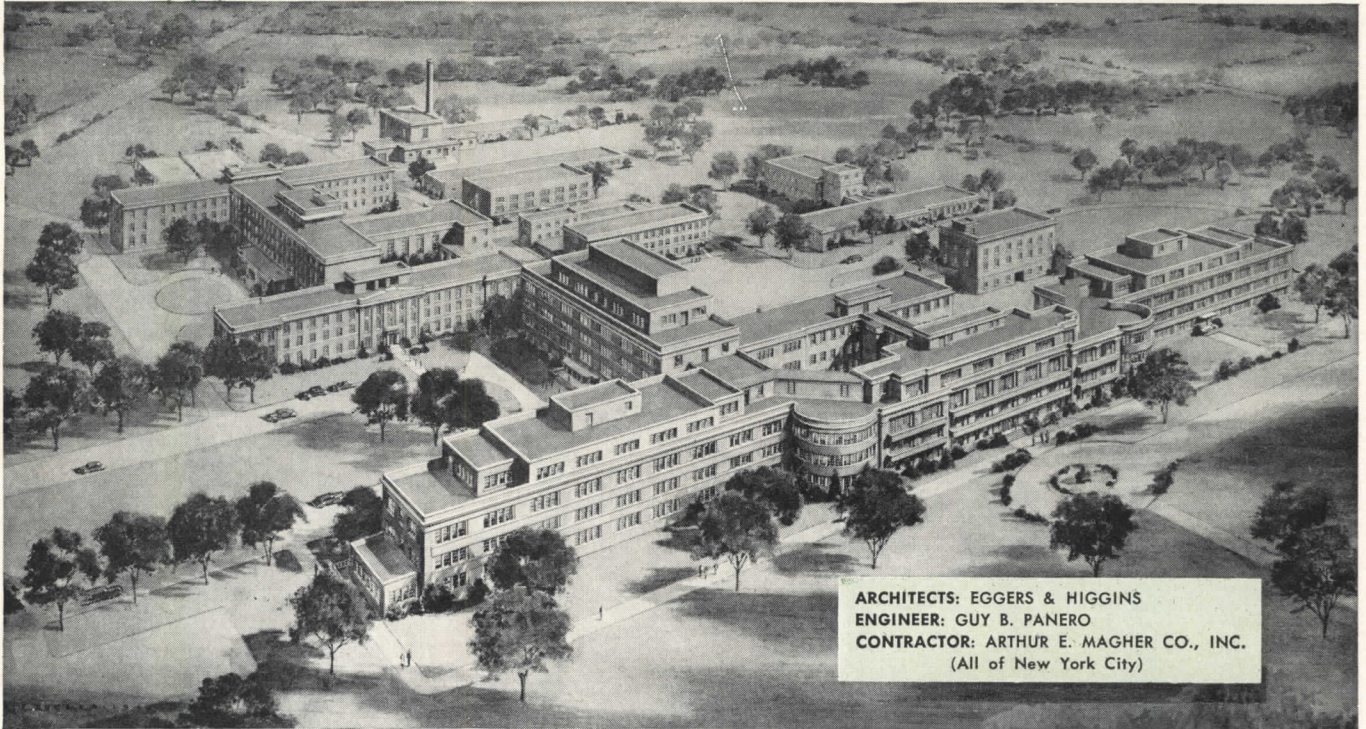
WIREMOLD'S *New*  
multi-outlet system

THE WIREMOLD COMPANY  
Hartford 10, Connecticut

# POWERS

AIR CONDITIONING  
RADIANT HEATING  
HOT WATER HEATER

Control



ARCHITECTS: EGGERS & HIGGINS  
ENGINEER: GUY B. PANERO  
CONTRACTOR: ARTHUR E. MAGHER CO., INC.  
(All of New York City)

## Used in MEADOWBROOK HOSPITAL

East Meadow, Long Island, N. Y.

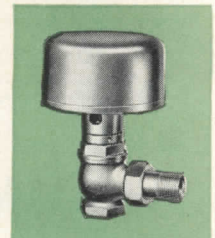
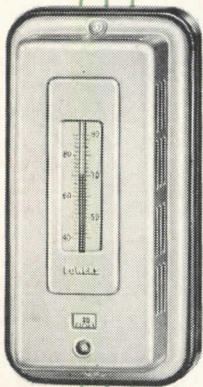
**Modern Hospital Planning** now includes greater attention to the importance of accurate control of air conditions in patients' rooms as well as operating, labor, delivery, nursery, radiograph, cystoscopy, fluoroscopy and anesthesia rooms — which are POWERS controlled at Meadowbrook Hospital.

**Greater Comfort of Patients** aided by Powers Automatic Temperature Control helps hasten recovery enabling them to return home sooner. Increased turnover enlarges hospital's capacity to serve more people.

**Important Fuel Savings**—Much higher fuel costs—a big item of expense—can be substantially reduced by prevention of OVER-heated rooms with Powers Control. Fuel savings alone make it a more profitable investment now than ever before.

**15 to 25 Years of Reliable Service** with very little for repairs is often reported by users of Powers Control. It is unsurpassed for low operating and maintenance cost.

For the right solution to your control problems call Powers. Take advantage of our many years of experience in supplying temperature and humidity control for all hospital requirements, including hydro-therapy controls.



(a68)

Established in 1891 • THE POWERS REGULATOR COMPANY • SKOKIE, ILL. • Offices in Over 50 Cities

CANADA

(Continued from page 34)

creased by one quarter of one per cent. This increase, according to Minister of Resources and Development Robert H. Winters, reflects the upward movement in the general interest rate structure.

Provision is made in the Act for the interest rate on new loans to fluctuate in accordance with changes in the interest yield on long-term Government bonds; there has been an increase in such interest of about one half of one per cent during the past year.

- Doubt that current training and immigration programs for construction workers are sufficient to look after Canada's needs was expressed in a recent address by P. G. Wilmut, president of the Canadian Construction Association, before the Builders' Exchange at Kingston, Ont.

Calling on contractors to provide employment opportunities for apprentices in greater numbers, Mr. Wilmut stressed that apprenticeship programs pay off.



Dr. E. G. Faludi, managing director of Town Planning Consultants Ltd., has been appointed planning consultant by the Oakville-Trafalgar (Ont.) Planning Board. Ford of Canada Ltd. is building a giant industrial plant in Trafalgar Township, on the outskirts of Oakville, and more new manufacturing concerns and a population increase of upwards of 20,000 are expected to create planning problems for an area which has been till now largely rural



James A. Britton, A.I.A.  
ARCHITECT  
315 FEDERAL STREET, GREENFIELD, MASS.

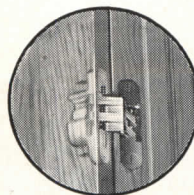
I am delighted with the Soss Invisible Hinge installation which we used at various locations throughout the building. When an architect constructs his own building, the public views the structure with mixed admiration and scrutiny. I am pleased to say that the installation of Soss hinges has received many compliments from the hundreds of people who have visited our new establishment.

Very truly yours,  
James A. Britton  
JAB:K

Architect Streamlines  
Own Office Building  
with ...



THE SOSS INVISIBLE HINGE is the hinge that has no ugly, protruding hinge butt. It lets architects fulfill the demands of modern design for flush, smooth, streamlined interiors. You will find SOSS hinges ideal for all types of doors, wall panels and cupboards . . . in every type building! The more you use this beautifying hinge the more compliments you, too, will receive on your good taste in modern design.



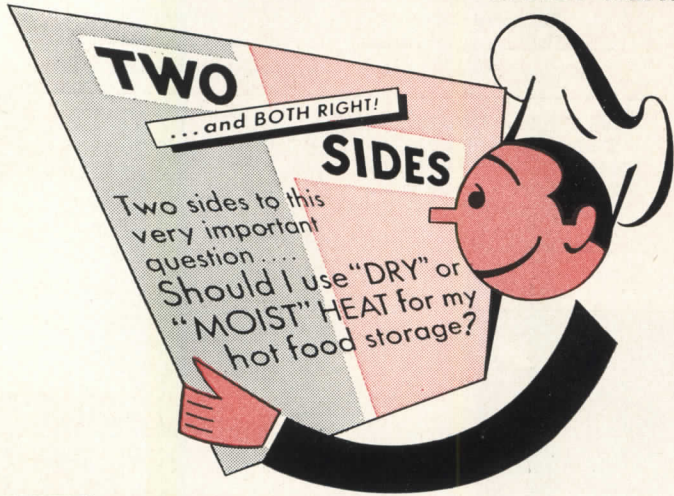
Write for free blueprint catalogue to—

**SOSS MANUFACTURING CO.**

21769 Hoover Road, Detroit 13, Mich.



**FACTS:** • CERTAIN FOODS "STORE" BETTER WITH "DRY" HEAT;— AND CERTAIN FOODS DEMAND "MOIST" HEAT



**BUY SECO\*-MATIC** and *get both!* \*Trade Mark Reg.

**DRY OR MOIST SECO-MATIC DRY MOIST**

**CONVERTIBLE HOT FOOD TABLE** COMBINATION FOOD STORAGE PATENT APPLIED FOR



Showing 5-opening Gas; Enclosed Base, Sliding Doors; with Glass Protector Guard and S. S. Shelf.  
12 Basic Gas or Electric Models; 2 to 7 top openings; Open, Semi, and Enclosed Base  
**ALL MODELS A. G. A. OR U. L. APPROVED**

Yes... SECO-MATIC HOT FOOD TABLES are the answer to BOTH types of HEAT—Either "Dry-or-Moist" heat... convertible or combination—and ALL from the SAME table operation... with the TYPE OF REGULATED Sectional heat BEST SUITED for EACH food!

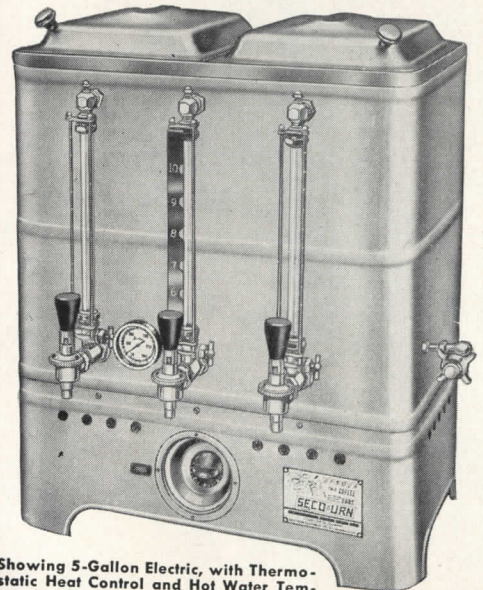
**A  
N  
N  
O  
U  
N  
C  
I  
N  
G**

**YOUR KEY TO... GREATER COFFEE CAPACITY**

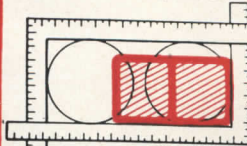


SECO\*-URNS are SQUARE inside and out—offering Up to 50% GREATER COFFEE AND WATER CAPACITY\*\*—Utilizing every inch of MINIMUM stand or counter space!  
\*\*Over Conventional Round Liner Twin Urns

**DIE-STAMPED STAINLESS STEEL SQUARE TWIN COFFEE URNS**  
NON-PRESSURE  
NON-SYPHON  
SEAM-WELDED



Showing 5-Gallon Electric, with Thermo-static Heat Control and Hot Water Temperature Gauge.  
12 Basic Gas, Electric, Steam Models; 2-3-4-5 Gallon Capacities.



**More Coffee served in LESS Space at LESS Cost!**

**MAIL TODAY FOR NAME OF NEAREST SOUTHERN DEALER**

- BUDGET PRICED**
- Send SECO-MATIC Catalog SDM-6850 EE
  - Send SECO-URN Catalog STU-50 EE
  - Have Representative Call

Name.....  
Address.....  
City..... Zone..... State.....  
Attention.....  
Test Series Adv.T/P-3

**SOUTHERN EQUIPMENT CO. Custom-Built by Southern 5017 S. 38th ST. LOUIS 16, MO., U.S.A.**

**FRANK CREEDON NAMED TO HEAD MILITARY BUILDING**

FRANK R. CREEDON, who has been director of the Facilities and Construction Bureau of the National Production Authority, has been named to the newly-created post of director of installations for the Department of Defense.

**PROJECTS APPROVED UNDER THE HILL-BURTON HOSPITAL PROGRAM**

Fiscal Year	No. of Projects	Estimated Cost		Additions	
		Total Cost	Federal Share	Hospital Beds—Health Centers	
1948	450	\$283,511,131	\$ 74,782,018	25,541	51
1949	367	275,841,588	74,929,305	18,024	48
1950	537	442,919,409	149,918,909	26,931	85
1951	266	239,617,921	84,874,002	12,200	50
1952	215	185,670,061 <sup>1</sup>	73,488,523	9,898	57

The latest consolidated summary prepared by the Division of Hospital Facilities of the U. S. Public Health Service, the agency within the Federal Security Agency which administers Federal construction funds under the Hill-Burton program, reports the picture as of July 31 as shown in table above

The office was established in an amendment to the 1952 military public works authorization bill to provide a civilian construction expert to "maintain direct surveillance over the planning and construction by the military departments of all public works projects."

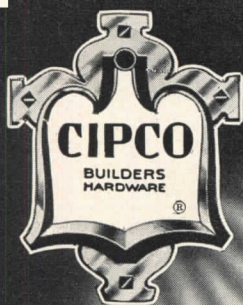
Mr. Creedon, who will have a small staff with construction experience, will report directly to the Secretary of Defense on status, progress and cost of all military public works projects.

(Continued on page 322)

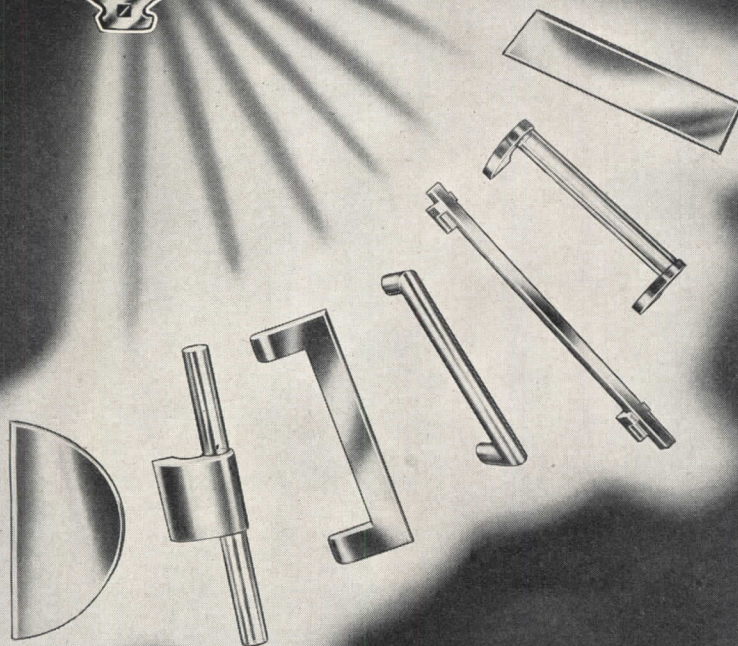
**Regulation X Suspended; Commercial Curbs Ended**

SUSPENSION OF REGULATION X, the two-year-old curb on housing credit, and full suspension of Federal Reserve Board restrictions on commercial construction loans, became effective September 16.

As the Bureau of Labor Statistics reported seasonally-adjusted housing starts in August fell below the 1.2 million figure for the third successive month, Housing and Home Finance Agency announced down payments on home loans aided or made by the Federal government would revert to the original statutory limitations; and the Federal Reserve Board announced suspension of Regulation X on conventional residential credit as well as full suspension of any restrictions on conventional lending on real estate.



*Contemporary*  
**ARCHITECTURAL HARDWARE**



Manufacturers  
of Fine Hardware  
for Over 28 Years

**SPECIFY**  
"Cipco Built" for your  
special designs.  
Your Architectural Hardware  
Consultant will be happy  
to work with you.

**CIPCO CORPORATION**

22nd and COLE STREET • ST. LOUIS 6, MISSOURI



# For *Steam* Heating, too, it's **Sarcotherm!**

**E**ffective control of steam heating systems for single or multiple buildings is best accomplished by continuously modulated flow of steam, proportioned automatically by outdoor temperature.

The carefully engineered SARCOSTAT SYSTEM shown diagrammatically in Fig. 1 fulfills these requirements perfectly. Many are now in successful operation.

The heart of the system is the Sarcostat hydraulic-electric control valve (Fig. 1) installed in the main steam supply line to each zone and positioned by the combined effect of the outdoor temperature and the influence of steam pressure existing on the downstream side of the valve.

Successful operation is predicated on careful sizing of orifice plates in each radiator or convector, which is part of the engineering service provided by Sarcotherm.

If you are seeking trouble-free heating control of steam systems of any size or type, we shall be glad to place our experience at your disposal without obligation.

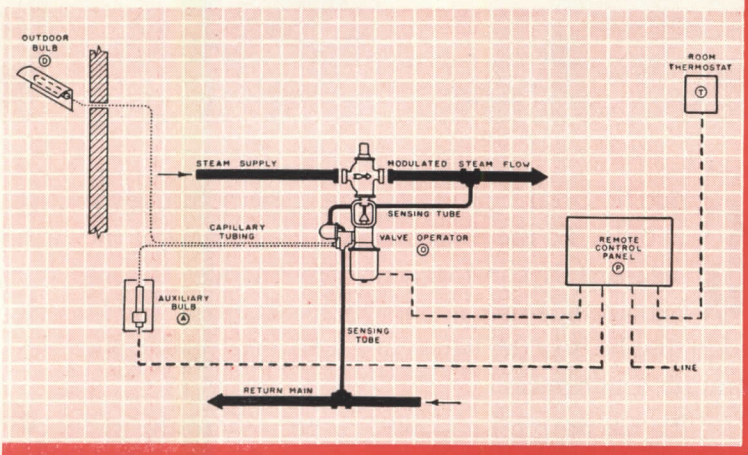


Fig. 1, Typical Hook-up of Sarcostat System.

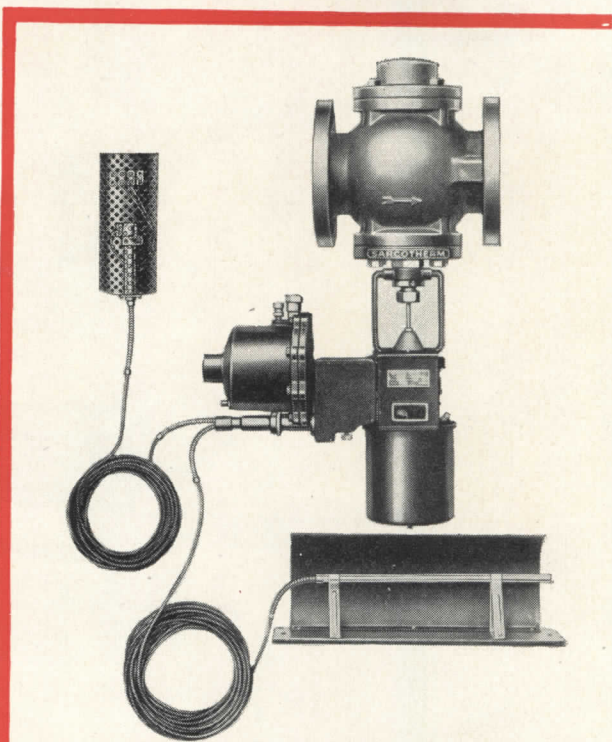
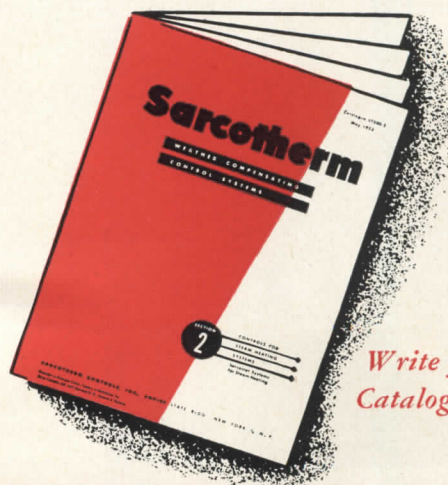
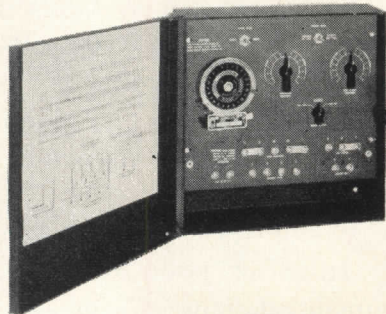


Fig. 2, Sarcostat Modulating Control Valve, Type W-1.



Fig. 4, Type WSA Remote Program Control Panel, adds to the features of type W a time clock to provide automatic morning pickup and night setback, and other features as specified.

Fig. 3, Type W Manual remote Control Panel is equipped with temperature adjusting knob for "warmer" and "cooler," also a four-position Selector Switch for "Automatic," "Full Heat," "Heat Off," and "Summer."



Write for **NEW**  
Catalog **ST500-2**

25

**SARCO THERM CONTROLS, INC.**

Empire State Building, New York 1, N. Y.

A SARCO PRODUCT



## What do we mean

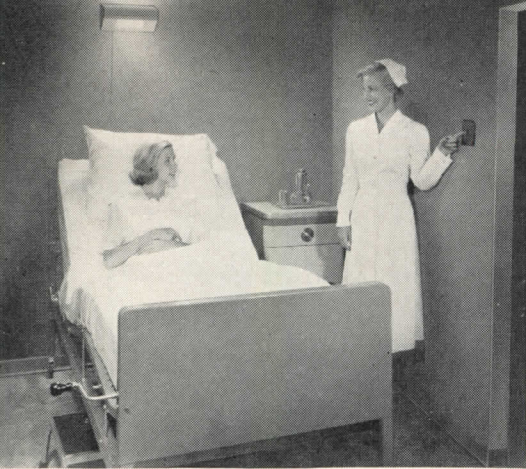
**G**ood hospital lighting *can* mean many things to many people. To the patient, good local lighting means a measure of comfort and convenience . . . and the reassurance that inevitably results from the knowledge that he is in the hands of a well-managed, up-to-the-minute organization.

To the hospital visitor . . . especially to the patients' loved ones . . . good lighting means a lasting impression of 20th Century efficiency and the highest standards of cleanliness . . . and the reassurance inherent in these benefits.

To the staff . . . professional and non-professional alike . . . good general lighting means a more pleasant place to work and freedom from tension and nervous fatigue due to eyestrain.

And to the hospital administrator, good lighting means a staff that works better, more efficiently . . . with fewer mistakes and less loss of time, effort, and money due to employee turnover.

In short, good hospital lighting means better "human relations" . . . greater public acceptance. And even when hospital beds are at a premium, a favorable public attitude is important to *every* hospital.



Soft, indirect general purpose lighting is controlled by nurse from a switch panel inside Patient Room door. Day-Brite Bed Lamps are designed for maximum patient comfort and convenience . . . are built for years of trouble-free performance.



Recessed Day-Brite Nite Lights are also controlled from a switch panel inside the Patient Room door, provide up to 100 watts of illumination—ample for normal patient needs. They're ideal for hospital corridors and wards, too.



More and more of the nation's hospitals are going Day-Brite throughout. Because Day-Brite provides the quantity and quality of illumination that creates better working conditions for the staff and a more pleasant atmosphere for patients.

# by Good Hospital Lighting ?

**GOOD HOSPITAL LIGHTING** starts with the patient's room . . . "home" to the person who must live there for days or weeks or months. Good lighting takes some of the "sick" out of the sick room . . . helps create a more comfortable, more relaxing atmosphere.

For example, in a typical Day-Brite lighted private or semi-private room (like the one pictured on the opposite page), there are no harsh brightness contrasts common with ordinary ceiling fixtures. Patients get both direct light for reading and soft, indirect illumination for general use from a single glare-proof bed lamp that has been specifically designed for his comfort and convenience.

The 3-lamp Day-Brite Bed Light is mounted 7-feet up on the wall at the rear of the patient's bed . . . out of the patient's reach. A pull switch enables him to turn on the 60-watt reading lamp at will. End lamps for indirect lighting are controlled by the nurse at the door. A handy electrical outlet completes this Day-Brite unit.

On the ward, Day-Brite Bed Lamps using a

single direct-beam reading lamp are ideal supplements to general ceiling lighting.

Aside from decidedly more comfortable lighting, there are other qualities that make Day-Brite your best bet in patient room lighting. Day-Brite stainless steel construction, for example, makes these fixtures easier to keep clean . . . gives them a permanent finish that preserves a truly modern appearance for years and years.

Important, too, is the glass top-side panning that helps diffuse light and protects against dust and dirt deposits that cut down efficiency and create maintenance problems. And Day-Brite Bed Lamps are ventilated at top and bottom for cooler, safer operation. All Day-Brite fixtures are Underwriter Approved, of course.

In the patient's lavatory, Day-Brite Lavatory Units using one 50 or 60 watt lamp for direct/indirect illumination are also of stainless steel construction and feature the glass top, convenience receptacle, and top and bottom ventilation.

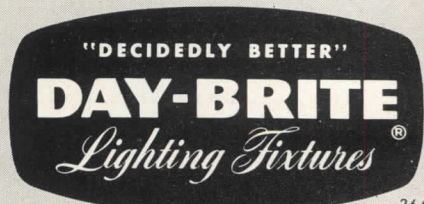
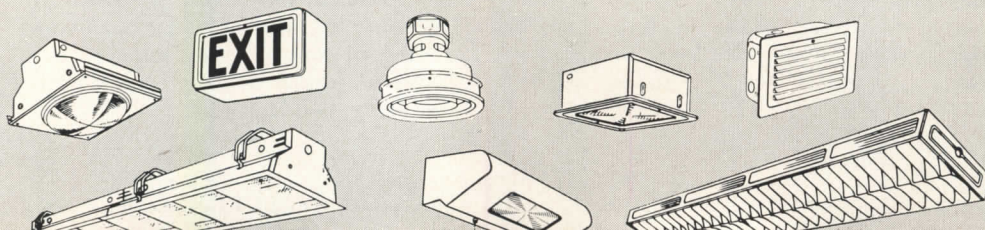
For after visiting hours, Day-Brite louvered hinged face Nite Lights—with wattages up

to 100—provide ample illumination for normal sick room needs. These recessed units are usually placed 24 inches from the floor to right or left of the door. Staggered at intervals of 18 feet, Day-Brite Nite Lights are ideal for hospital corridors, too.

Patient Room lighting by Day-Brite is amazingly simple and inexpensive. It provides really comfortable illumination for the patient, and its remote control features for indirect and night lighting save time and trouble for busy hospital nurses.

There's a Day-Brite fixture for practically every hospital lighting need—for lobbies and admitting rooms, for corridors, offices and clinics; for central supply rooms and pharmacies and hospital laboratories; for every service area. Day-Brite has long been an outstanding leader in the manufacturing of the finest industrial, commercial, and hospital lighting fixtures. Why not let Day-Brite's experienced engineers help solve your hospital lighting problem? For complete information, WRITE: Day-Brite Lighting, Inc., 5465 Bulwer Ave., St. Louis 7, Mo. In Canada: Amalgamated Electric Corp., Ltd., Toronto 6, Ontario.

## "Decidedly Better" Day-Brite Fixtures for Decidedly Better Hospital Lighting



CONSTRUCTION COST INDEXES

Labor and Materials

United States average 1926-1929 = 100

Presented by Clyde Shute, manager, Statistical and Research Division, F. W. Dodge Corp., from data compiled by E. H. Boeckh & Assocs., Inc.

NEW YORK

ATLANTA

Period	Residential		Apts., Hotels Office Bldgs. Brick and Concr.	Commercial and Factory Bldgs. Brick and Concr.		Brick and Steel	Residential		Apts., Hotels Office Bldgs. Brick and Concr.	Commercial and Factory Bldgs. Brick and Steel	
	Brick	Frame		Brick	Frame		Brick	Frame		Brick	Frame
1925	121.5	122.8	111.4	113.3	110.3	86.4	85.0	88.6	92.5	83.4	
1930	127.0	126.7	124.1	128.0	123.6	82.1	80.9	84.5	86.1	83.6	
1935	93.8	91.3	104.7	108.5	105.5	72.3	67.9	84.0	87.1	85.1	
1939	123.5	122.4	130.7	133.4	130.1	86.3	83.1	95.1	97.4	94.7	
1940	126.3	125.1	132.2	135.1	131.4	91.0	89.0	96.9	98.5	97.5	
1946	181.8	182.4	177.2	179.0	174.8	148.1	149.2	136.8	136.4	135.1	
1947	219.3	222.0	207.6	207.5	203.8	180.4	184.0	158.1	157.1	158.0	
1948	250.1	251.6	239.4	242.2	235.6	199.2	202.5	178.8	178.8	178.8	
1949	243.7	240.8	242.8	246.4	240.0	189.3	189.9	180.6	180.8	177.5	
1950	256.2	254.5	249.5	251.5	248.0	194.3	196.2	185.4	183.7	185.0	
1951	273.2	271.3	263.7	265.2	262.2	212.8	214.6	204.2	202.8	205.0	
May 1952	277.5	274.0	270.1	273.5	270.0	218.1	220.3	211.3	208.6	212.5	
June 1952	277.5	274.0	270.1	273.5	270.0	217.7	219.9	210.8	208.2	212.1	
July 1952	278.1	275.0	270.9	273.8	271.4	219.1	220.7	213.5	211.5	215.5	
July 1952	125.2	124.7	% increase over 1939 107.3			105.2	108.6	% increase over 1939 124.5		117.1	127.6

ST. LOUIS

SAN FRANCISCO

1925	118.6	118.4	116.3	118.1	114.4	91.0	86.5	99.5	102.1	98.0	
1930	108.9	108.3	112.4	115.3	111.3	90.8	86.8	100.4	104.9	100.4	
1935	95.1	90.1	104.1	108.3	105.4	89.5	84.5	96.4	103.7	99.7	
1939	110.2	107.0	118.7	119.8	119.0	105.6	99.3	117.4	121.9	116.5	
1940	112.6	110.1	119.3	120.3	119.4	106.4	101.2	116.3	120.1	115.5	
1946	167.1	167.4	159.1	161.1	158.1	159.7	157.5	157.9	159.3	160.0	
1947	202.4	203.8	183.9	184.2	184.0	193.1	191.6	183.7	186.8	186.9	
1948	227.9	231.2	207.7	210.0	208.1	218.9	216.6	208.3	214.7	211.1	
1949	221.4	220.7	212.8	215.7	213.6	213.0	207.1	214.0	219.8	216.1	
1950	232.8	230.7	221.9	225.3	222.8	227.0	223.1	222.4	224.5	222.6	
1951	252.0	248.3	238.5	240.9	239.0	245.2	240.4	239.6	243.1	243.1	
May 1952	260.7	254.0	251.6	258.1	250.2	247.6	242.4	241.7	244.6	245.1	
June 1952	260.7	254.0	252.2	258.6	251.5	252.9	247.8	247.2	251.0	251.0	
July 1952	260.9	254.2	252.8	259.0	252.9	253.1	248.0	247.8	251.4	252.4	
July 1952	136.8	137.6	% increase over 1939 114.2			116.2	112.5	% increase over 1939 111.1		106.2	116.7

The index numbers shown are for combined material and labor costs. The indexes for each separate type of construction relate to the United States average for 1926-29 for that particular type — considered 100.

Cost comparisons, as percentage differences for any particular type of construction, are possible between localities, or periods of time within the same city, by dividing the difference between the two index numbers by one of them; i.e.:

index for city A = 110  
index for city B = 95  
(both indexes must be for the same type of construction).  
Then: costs in A are approximately 16 per cent higher than in B.

$$\frac{110-95}{95} = 0.158$$

Conversely: costs in B are approximately 14 per cent lower than in A.

$$\frac{110-95}{110} = 0.136$$

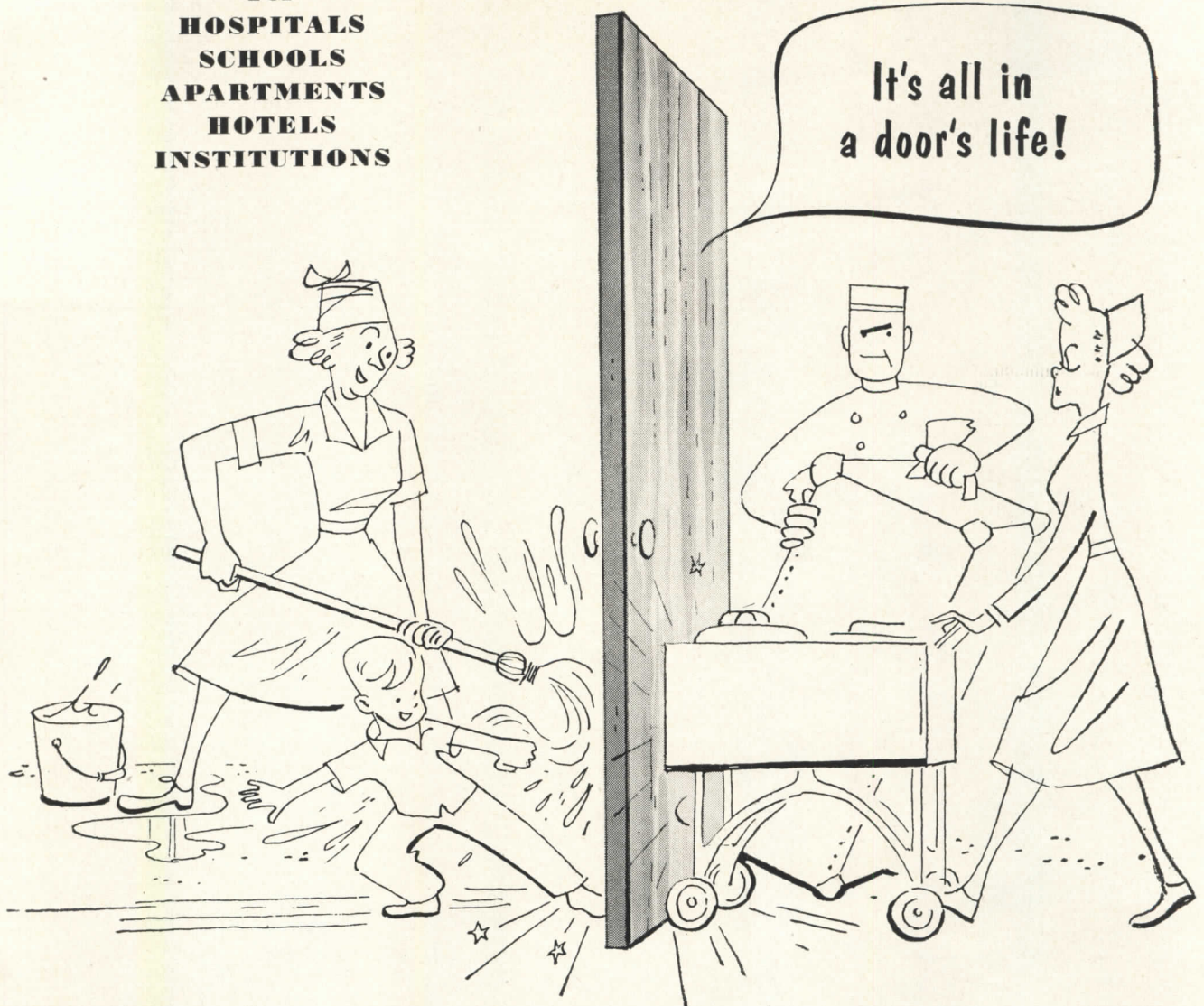
Cost comparisons cannot be made between different types of construction because the index numbers for each type relate to a different U. S. average for 1926-29.

Material prices and wage rates used in the current indexes make no allowance for payments in excess of published list prices, thus indexes reflect minimum costs and not necessarily actual costs.

These index numbers will appear regularly on this page.

# For tough assignments, specify Roddiscraft solid core flush doors

For  
HOSPITALS  
SCHOOLS  
APARTMENTS  
HOTELS  
INSTITUTIONS



**Doors lead a tough life in public buildings. Roddiscraft Solid Core Flush Veneered Doors are built to take it.**

**FIRE RESISTANT** — exceed a regular fire test for over 40 minutes. Provide extra protection where needed in multiple and single dwelling units.

**SOUND RESISTANT** — develop an average sound transmission loss of 30.9 decibels — only a little less than specially constructed sound retardant doors of much greater cost.

**RESISTANT TO ABUSE** — core, crossbandings and face veneers welded into a single unit with the inherent strength of true plywood construction.

**WATERPROOF** — for exterior and interior use. Phenolic resin glue provides two completely waterproof shields over entire area of the door on each side of the core.

**STANDARD THICKNESS FACE VENEERS** — provide greatest resistance to checking and abuse — permit better matching.

*Specify Roddiscraft Solid Core Flush Veneered Doors for the tough assignments.*

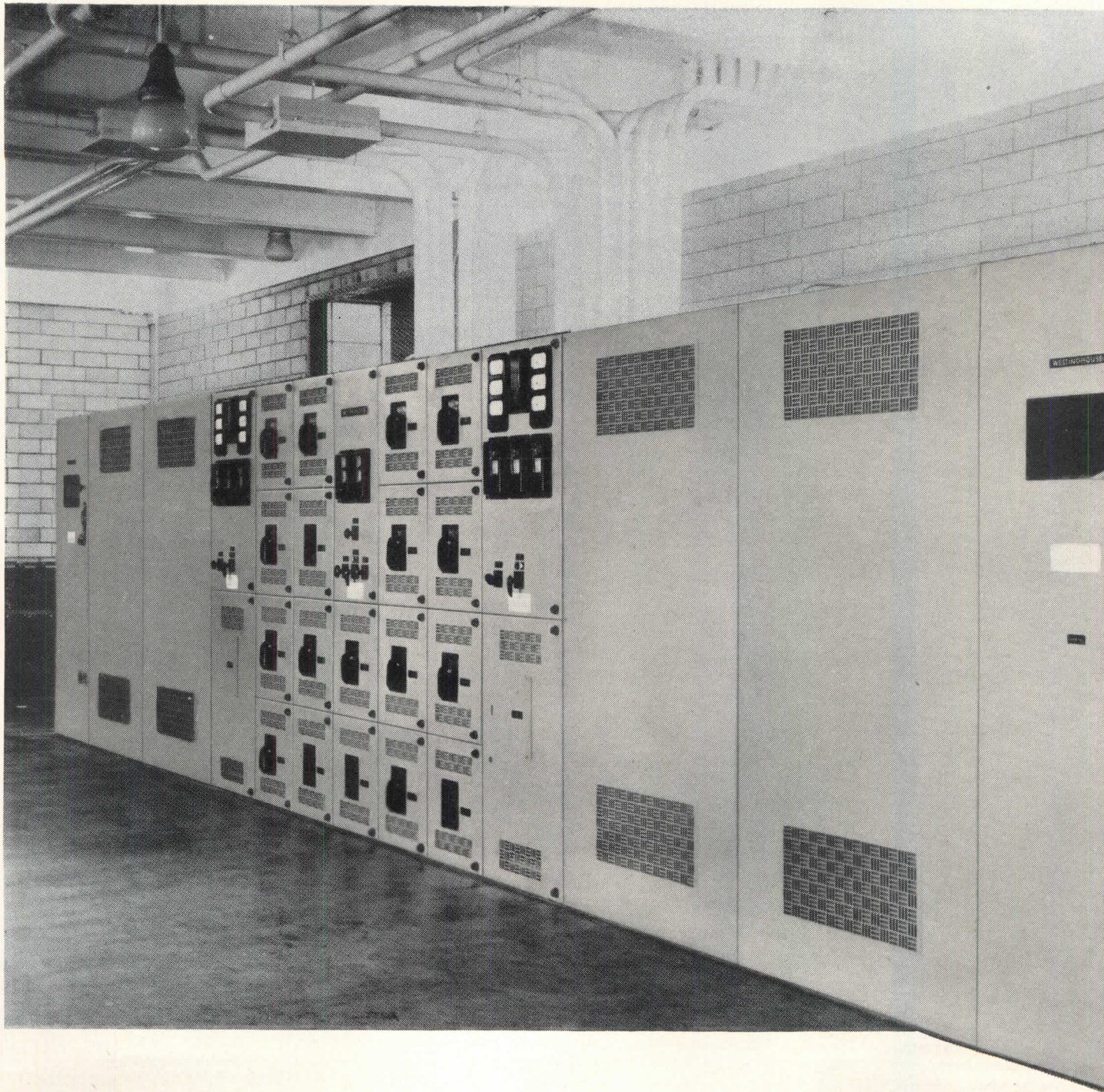
## NATIONWIDE Roddiscraft WAREHOUSE SERVICE

Cambridge, Mass. • Charlotte, N. C. • Chicago, Ill. • Cincinnati, Ohio • Dallas, Texas • Detroit, Michigan • Houston, Texas • Kansas City, Kan. • New Hyde Park, L. I., N. Y. • Los Angeles, Calif. • Louisville, Ky. • Marshfield, Wis. • Milwaukee, Wis. • New York, N. Y. • Port Newark, N. J. • Philadelphia, Pa. • St. Louis, Mo. • San Antonio, Texas • San Francisco, Calif. • Miami, Fla. • San Leandro, Calif.

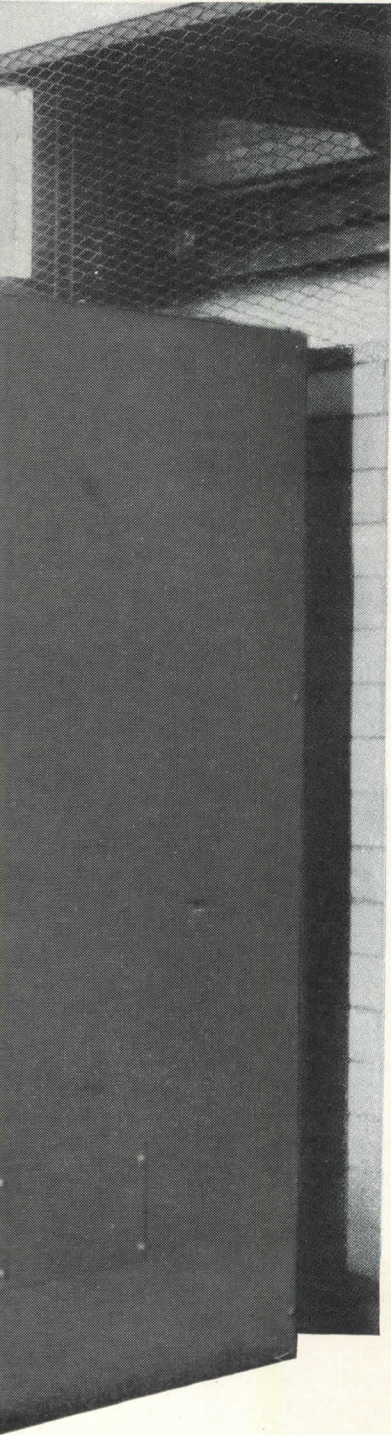
## Roddiscraft

RODDIS PLYWOOD CORPORATION

Marshfield, Wisconsin



# Westinghouse *POWER CENTERS* provide for efficient power distribution at Eastman Kodak



Westinghouse Power Centers consisting of dry-type transformers and switchgear are serving the modern power distribution system at Eastman's Kodak Park Works at Rochester, N. Y. Here's how this user rates their performance in this key function.

*"In recent years, a number of Westinghouse Power Centers have been installed at the Kodak Park Works. These units all have ASL dry-type transformers and are supplied at either 2,400 or 13,800 volts. Capacities range from 300 kva to 1,500 kva. Maintenance has been nominal and no serious trouble of any kind has been experienced. We are well satisfied with the equipment."*

Many specific advantages of Westinghouse Power Centers contribute to such approval of these installations. For example . . .

**They cost less to maintain . . .** no liquids to test, recondition or replace . . . no gaskets, valves or gauges. All parts are readily accessible.

**They're more economical . . .** because they eliminate the need for costly vaults and can be located near the center of load . . . resulting in shorter secondary circuits, lower line losses, better regulation.

**They're safer . . .** from the hazards of fire and explosion; they have no exposed live parts. Breakers and switches have positive interlocking mechanisms, each in its separate compartment.

## GET THE COMPLETE STORY

Westinghouse Power Centers provide better service continuity, greater flexibility, better regulation . . . all the things that contribute to efficient power distribution. Most important, they provide the simplest, lowest-cost way of attaining the power system that best meets your operating requirements.

Booklet B-4162 covers Westinghouse Power Centers in detail. Booklet B-4045 discusses various types of plant distribution systems wherein power centers offer maximum advantage. Contact your Westinghouse Representative or write: Westinghouse Electric Corporation, P. O. Box 868, Pittsburgh 30, Pennsylvania.

J-60765

YOU CAN BE **SURE**...IF IT'S  
**Westinghouse**

**POWER CENTERS**

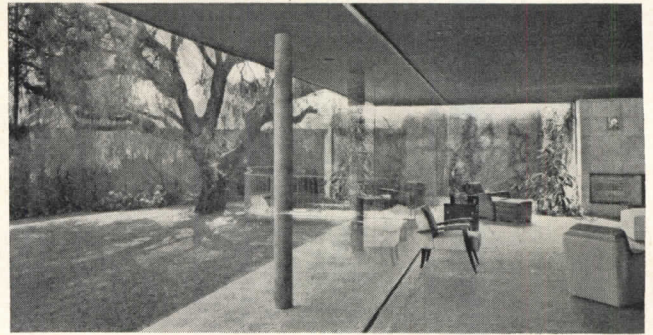


# REQUIRED READING

## MODERN ARCHITECTURE IN MEXICO



W. Reuter



Above: church in Monterey — Enrique de la Mora, architect; Herbert Hofman, sculptor. Top right: house — Victor de la Lama, architect. Right: Mexico City office building — Juan Sordo Madaleno & Augusto H. Alvarez, architects



Guillermo Zamora

*Mexico's Modern Architecture.* By I. E. Myers in cooperation with The National Institute of Fine Arts of Mexico. Architectural Book Publishing Co., Inc. (112 W. 46th St., New York 36, N. Y.) 1952. 8½ by 10½ in. 264 pp., illus.

The vitality and quality of the work being done by contemporary architects in Mexico is well evidenced in this book. For readers who have never been to the country, and whose only previous knowledge of its modern buildings has come through earlier books, such as Esther Born's 1937 survey, both the quality and the quantity of the buildings shown here will perhaps come as a revelation. In the space of little more than 25 years, since the first buildings that could in any sense be called modern were built, Mexico seems to have evolved a body of architecture which on the whole invites comparison with contemporary building anywhere, including its more publicized neighbors to the south.

The idiom of modern building in Mexico may be largely traced to the International Style of the 1920's. In this, of course, it resembles much of the work done not only on the European continent, but also in the United States,

Great Britain or, for that matter, Hong Kong. In most of these structures the devices associated with this source predominate; widespread use of materials such as concrete and glazed tile for exteriors, large expanses of glass, clean unbroken lines and flat surfaces, a machine-like quality of precise formality and an avoidance of clutter which amounts almost to bareness. In these contemporary Mexican houses, offices, hospitals and schools, as in their siblings over the world, there is reflected everywhere the theories and practices of architects such as Le Corbusier, Mies, Gropius and Neutra. None of this is to say that the work being done in Mexico is in any way derivative or mere copy-book modernism. Although the standard elements are all employed, they are carefully thought out and imaginatively applied. Native and natural materials help give them a flavor which is somewhat distinct, if not unique. And, most important, the majority of the buildings pictured in this book show a boldness and directness which is admirable. In the very scope of some of the projects shown, such as the President Miguel Aleman

Multiple Dwellings, the Benito Juarez Dwellings and the giant University City project, it has given the United States a model to aim for.

As a pictorial catalog of these buildings, Mr. Myers' book serves a useful function and will be a welcome addition to the architect's or student's library. The illustrations are, for the most part, large and clear and are seemingly well-chosen. With the plans it is a different matter. No attempt at standardization has been made, and, while this is by no means an absolute necessity, some of them tend to be a little confusing. It seems to me, too, that the value of the book would have been enhanced if a more convenient and complete identification of each building had been furnished, including dates and — at least in the case of private houses, apartments and commercial buildings — street locations. As it is, a certain amount of confusion exists, particularly when similar houses follow each other in the presentation.

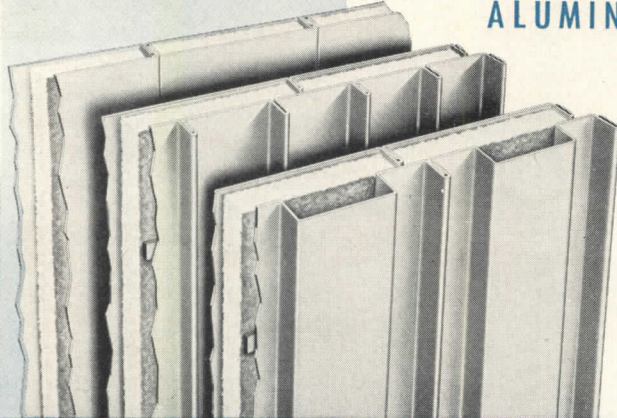
More serious exceptions can be taken to some aspects of the textual material.

(Continued on page 48)



# INSULATED METAL WALLS

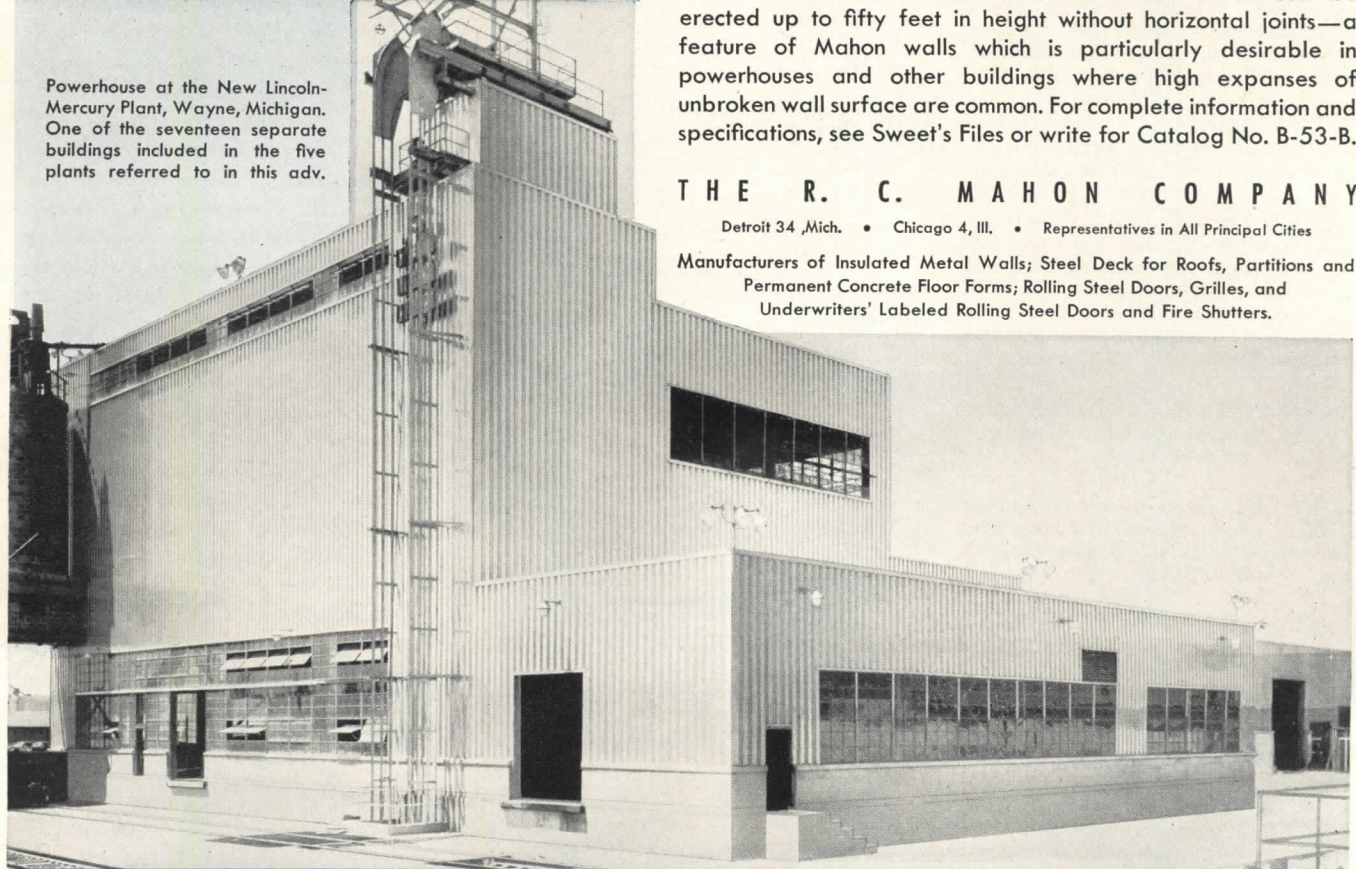
for INDUSTRIAL and COMMERCIAL BUILDINGS  
 ALUMINUM, STAINLESS or GALVANIZED STEEL



**FLUSH, RIBBED, or FLUTED**  
 Over-all "U" Factor of Various Types is Equivalent  
 to or Better than Conventional 16" Masonry Wall

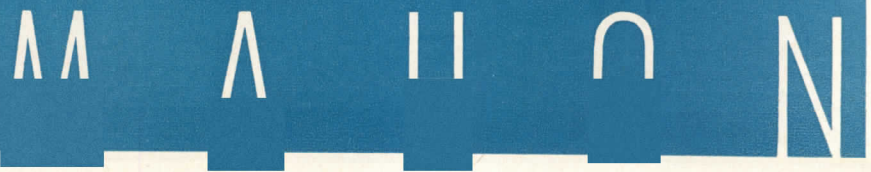
As evidence of the trend to Insulated Metal Walls in modern construction, the following statements are presented: 520,000 sq. ft. of Mahon Insulated Metal Walls with aluminum exterior plates were employed in the construction of three complete new industrial plants built by one manufacturer in three widely separated localities. More than 66,000 sq. ft. of the same type of wall was employed in the construction of two complete new plants for another manufacturer. In the five new plants referred to, there were seventeen separate buildings of various industrial types. The fact that additional plants were subsequently built by both of these manufacturers, employing the same identical wall construction in each case, indicates the degree of enthusiasm among architects and owners for the striking appearance of the finished buildings, as well as the time and labor-saving advantages of this type of permanent, firesafe construction. Mahon "Field Constructed" Insulated Metal Walls can be erected up to fifty feet in height without horizontal joints—a feature of Mahon walls which is particularly desirable in powerhouses and other buildings where high expanses of unbroken wall surface are common. For complete information and specifications, see Sweet's Files or write for Catalog No. B-53-B.

Powerhouse at the New Lincoln-Mercury Plant, Wayne, Michigan. One of the seventeen separate buildings included in the five plants referred to in this adv.



**THE R. C. MAHON COMPANY**  
 Detroit 34, Mich. • Chicago 4, Ill. • Representatives in All Principal Cities  
 Manufacturers of Insulated Metal Walls; Steel Deck for Roofs, Partitions and Permanent Concrete Floor Forms; Rolling Steel Doors, Grilles, and Underwriters' Labeled Rolling Steel Doors and Fire Shutters.

Giffels & Vallet, Inc., L. Rossetti, Architects and Engineers. Bryant & Detwiler Co., Gen. Contrs.



# The Answer is *Yes* to All 6 Questions

Simplified Planning?

Utmost in Sanitation?

Lifetime Service?

Utility?

Low Installation Cost?

Low Maintenance Cost?

When you specify JUST Line Stainless Steel equipment for any new building or modernization project, you can be sure that your clients will receive the utmost in—

**SIMPLIFIED PLANNING**—Because JUST Line Stainless Steel equipment is custom built to your specifications, it simplifies planning and meets every individual requirement.

**SANITATION**—The rust-acid-and-stain-resistant surfaces of stainless steel assure the utmost in sanitation.

**LIFETIME SERVICE . . . UTILITY**—JUST Line engineering and craftsmanship and electrically welded construction combined with the highest quality of materials, assure uninterrupted service at lowest installation and maintenance costs.

**MODERN DESIGN**—JUST LINE Stainless Steel equipment is the recognized leader in modern design.

JUST Line Stainless Steel Equipment is ideal for Government and private institutions, laboratories, hospitals, schools and industrial plants.

#### FOUR JUST LINE INSTALLATIONS:

The four installations illustrated here show the wide variety of equipment we are able to furnish you: Sterile Laboratories, The Upjohn Co.; Instrument Cabinet, Hines Veterans' Hospital; Sterile Storage Room, Hotel Dieu Hospital; Domestic Science Class Room High School.

Write today for new illustrated Catalog R-1052. It contains Architects' Specifications, Construction Details, numerous installations and other valuable information.



**JUST** Manufacturing Co.  
9233 King Ave., Franklin Park, Illinois



## REQUIRED READING

(Continued from page 46)

As is sometimes the case with such books, the organization often seems a little choppy. This is accentuated because little effort is made to tie the pictorial matter and the textual sections together. Mr. Myers' historical and sociological sketches are adequate as far as they go, but often seem too incomplete to be as valuable as they might have been. This is particularly true of his chapter on the modern movement itself, which just skims the surface. A fuller history than the author's is given in the foreword to the book by Enrique Yanez. Mr. Myers refers to pioneer buildings by Jose Villegran Garcia, Juan O'Gorman and others, but nowhere are these structures pictured. Only later works by these architects have found their way into the book. It is true that Mr. Myers has intended neither a sociological nor a historical work, but a book about modern building in Mexico must furnish a minimum of historical material—both textual and pictorial—if it is to be comprehensible, and the material offered here seems to me to be below that expected minimum. Space limitations alone cannot be argued as a complete extenuation of the omissions since Mr. Myers has found space for generalizations on the nature of architecture (sometimes, but not always, a little platitudinous) and other subsidiary comments which are not particularly integral to the sort of book he has written.

The book is printed in both Spanish and English, and this is certainly in itself to be commended. However, the Spanish text is printed completely in italics, and even though it is comparatively short, reading is made a little difficult. The limiting of descriptions of the individual buildings to English only is questionable.

Despite these shortcomings, it is good to have a work such as this available to supplement earlier material. It deserves and will probably find a ready audience; and in so doing, it will perform a valuable service both for the reader and for the leaders in Mexico's architectural revival.

### A BACKGROUND FOR STRUCTURAL DESIGN

Structure in Building. By W. Fisher Cassie and J. H. Napper. The Architectural Press  
(Continued on page 400)

PHOTOS BY HEDRICH-BLESSING



STRIP



BLOCK

*Take your choice  
...or take all three!*



RANCH  
PLANK

■ Today you can give home owners delightful variety along with the charm, beauty and other well-known advantages of Bruce Hardwood Floors.

Distinctive Bruce Blocks are ideal for modern as well as formal styles, and can be installed directly over concrete or wood subfloors. The new, glamorous Ranch Plank Floor (with alternate widths and walnut pegs) is perfect for rambling, informal homes in all price ranges. Then, of course, a Bruce Strip Floor is in good taste in any setting.

For a beautiful decorative effect at reasonable cost, use two or three types of Bruce floors in the same home. Specify "prefinished" to get the famous Bruce penetrating finish . . . and to save time and money on the job.

See our catalog in Sweet's and write us for booklets with color photos of Bruce Hardwood Floors.

**Bruce**  
**HARDWOOD FLOORS**

PRODUCT OF E. L. BRUCE CO., MEMPHIS 1, TENN.



World's largest maker of  
hardwood floors

# Keystone System of Stucco Application

Plaster Reinforcing

Stucco Reinforcing  
Overcoating Reinforcing

Corner and Joint  
Reinforcing

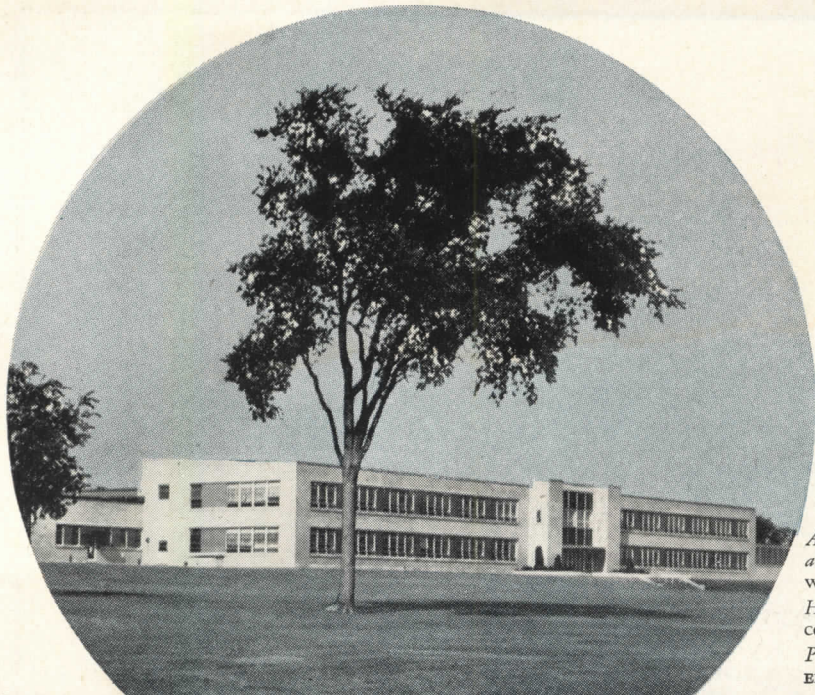
Simulated Stone  
Reinforcing

Terrazzo and Tile  
Underbed Reinforcing

Economical, easy to handle, Keymesh provides strength, attractive appearance and durability for exterior or interior reinforcement of plaster or concrete—for commercial or residential buildings of all types. Write for complete information.

# Keymesh

Keystone Steel & Wire Company  
Peoria 7, Illinois

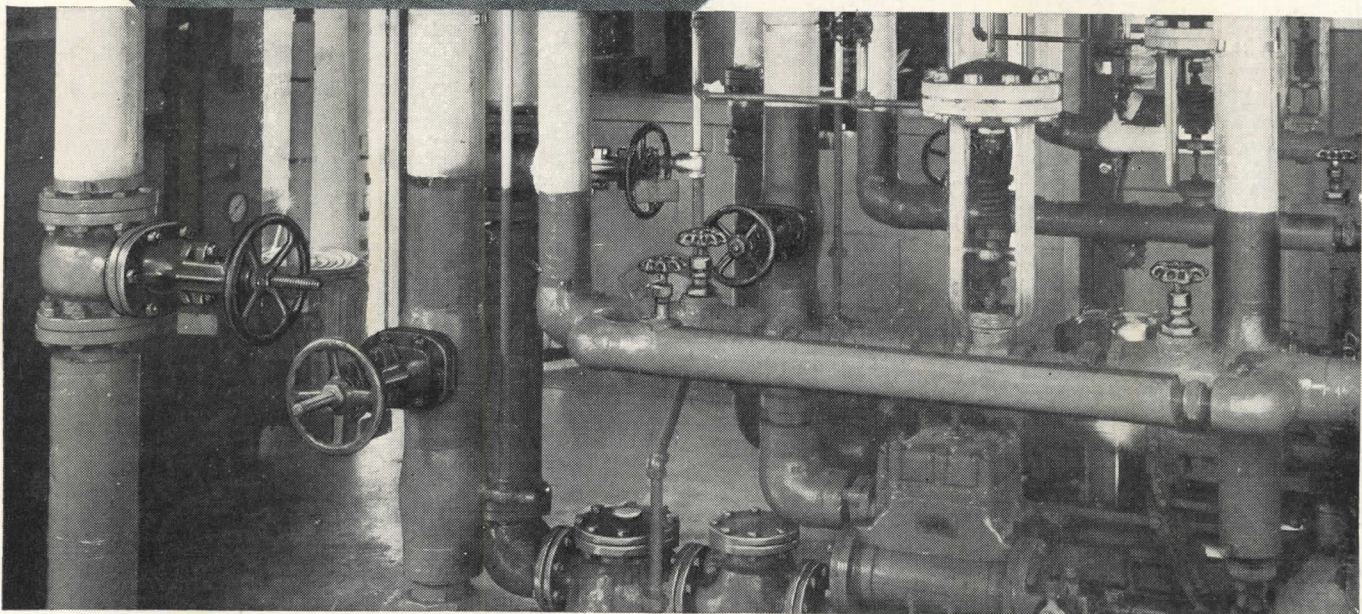


for future economy

# CHICAGO PNEUMATIC

equips its modern  
plant at Utica with  
**JENKINS VALVES**

*Architects, Design Engineers  
and General Contractors*  
WALTER KIDDIE CONSTRUCTORS, INC.  
*Heating Sub-Contractor*  
COURTER AND COMPANY, INC.  
*Plumbing Sub-Contractor*  
EDWARD B. KEARNEY COMPANY, INC.



Chicago Pneumatic Tool Co., which can look back with pride upon fifty years as manufacturers of pneumatic and electric tools, believes in looking ahead as well. Good example of this is the consideration given to future operating costs at the Company's newest plant at Utica, N. Y.

To insure lasting efficiency and maintenance economy, Jenkins Valves were installed throughout the plant on the recommendation of the architects and design engineers. These men, like so many of today's top-flight building specialists, know that the *extra measure* of efficiency and endurance built into Jenkins Valves pays dividends.

Despite this extra value, *you pay no more* for Jenkins Valves. For new installations, for all replacements, let the Jenkins Diamond be your guide to lasting valve economy. Jenkins Bros., 100 Park Avenue, New York 17; Jenkins Bros., Ltd., Montreal.

**JENKINS VALVES ARE STANDARD** at Chicago Pneumatic's new Utica plant. More than 1500 are in service on air, steam, water, sanitation and other essential pipelines. Above, Jenkins Valves control pipelines serving three return pumps in the boiler house. View at left, above, shows the Administration Building at the front of the 12-acre manufacturing plant.

**JENKINS**  
LOOK FOR THE DIAMOND MARK  
**VALVES**

SINCE 1864 TRADE MARK JENKINS MARK

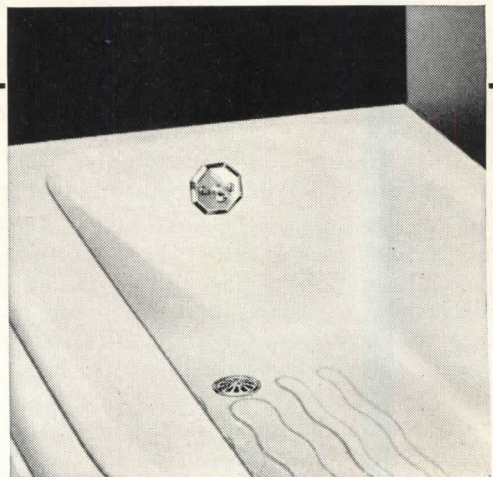
*Jenkins Bros*

SOLD THROUGH LEADING INDUSTRIAL DISTRIBUTORS EVERYWHERE



*For the acid test . . . count on a BRIGGS bathtub—  
it's stain-proof!*

Stain-proof (acid-resistant) porcelain enamel is only *one* of the safety, comfort and luxury extras which have placed Briggs Beautyware 'way out in front of the field. Only Briggs makes the tub with the famous Safety Bottom. Other features include the wide-rim seat . . . greater area of level bottom . . . straight panel ends eliminating cutting and fitting of adjoining wall tile . . . and leak-proof edges, tub to walls. Only Briggs gives you all this revolutionary designing in the four famous Briggs decorator colors and sparkling white. Write *now* for new catalog featuring Briggs plumbing fixtures and Briggs brass. Briggs Manufacturing Co., 3001 Miller Ave., Detroit 11, Mich. ©1952



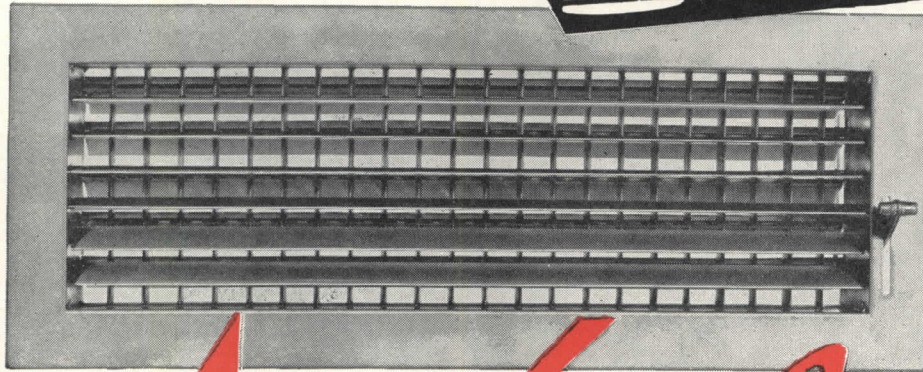
**BRIGGS** *Beautyware*

ALL Briggs bathtubs are furnished in stain-proof (acid-resistant) porcelain enamel. Both exposed and unexposed surfaces have the protection of a porcelain enamel coat. It pays to specify genuine Briggs Beautyware!

**MAKES ANY  
AIR CONDITIONING SYSTEM  
A BETTER AIR  
CONDITIONING SYSTEM**

● Illustrated below—  
#276 4-way multi-shutter register  
... features front louvers and rear damper  
blades parallel to long dimension ... second row  
louvers parallel to short dimension.

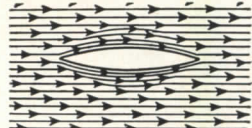
**Yet it COSTS  
LESS.....**



# Airfoil

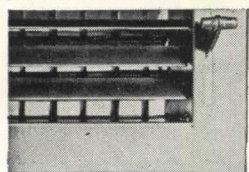
## 4-WAY MULTI-SHUTTER REGISTER

### SOLID-SECTION AIRFOIL LOUVER



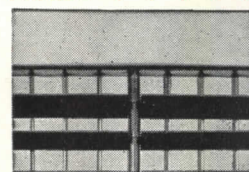
● Louver knifes air in wind tunnel tests. Turbulence has been almost eliminated giving noiseless control of air.

### LEVER CONTROL



● Inconspicuous lever in face of frame controls dampers for complete shut-off.

### EXTRA-STRENGTH FRAME.....



● New, exclusive Titus concealed support eliminates unsightly mullions and butted construction.

The smartly designed #276 combines 4-way #270 grille with the multi-shutter damper to assure maximum directional control with positive volume control and shut-off. Damper blades interlock for complete shut-off.

The two front sets of louvers are individually adjustable with blades on 3/4 inch centers.

Dampers are controlled from face of grille by inconspicuous lever. Removable lever furnished at no extra cost.

**EXTRA STRENGTH—LONGER LIFE**  
Sound, inspired know-how engineering gives the #276 superb simplicity of design with no unnecessary parts—no clumsy bulk. A special patented, *concealed support* eliminates unsightly mullions and butted construction permitting superior strength with no added weight.

### EASY TO INSTALL

#276 grilles are light in weight—easy to carry—easy to fit—easy to put in place. *Save much costly time and labor.*

### EXTRA VALUE AT LOWER COST

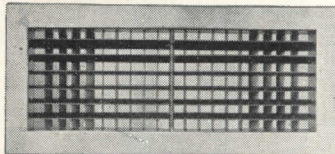
AIRFOIL grilles are priced down to give you more value—more performance—more efficiency—at less cost.

### NOTE THESE OUTSTANDING AIRFOIL FEATURES...

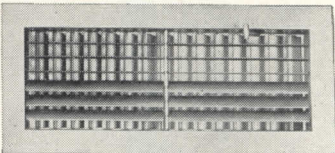
- Smooth-as-glass AIRFOIL louvers.
- Positive shut-off.
- Extra-heavy frames.
- Individual louver adjustment.
- Airtight rubber gasket.
- Removable lever.

### LOOK TO AIRFOIL

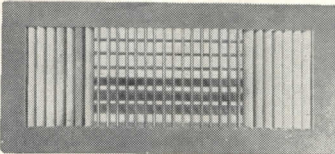
### FOR THE FINEST



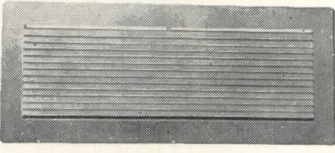
**L-270** 4-way directional grille for complete control of air stream.



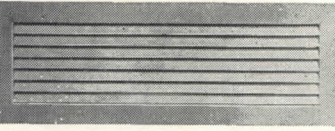
**L-274** Double directional grille with multi-shutter damper.



**S-8** 4-way grille with louvers on 1/2" spaced front.



**RL-21** Return air grille of fixed deflection type with closely spaced louvers.



**RL-230** Return air grille incorporates rugged construction and smart design.



**AG-25** Volume controller designed to fit behind grille.

#### CHECK TYPE OF GRILLE ON WHICH INFORMATION IS DESIRED

- |   |  |
|---|--|
| <input type="checkbox"/> Air conditioning outlets         | <input type="checkbox"/> Perforated metal and ornamental grilles |
| <input type="checkbox"/> Return air grilles and registers | <input type="checkbox"/> Door ventilators                        |
| <input type="checkbox"/> Volume controllers               | <input type="checkbox"/> Special made-to-order grilles           |

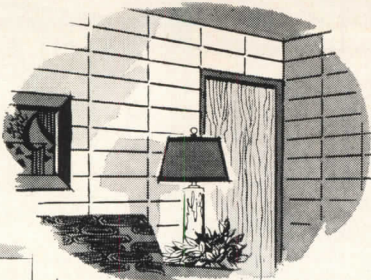
TITUS MANUFACTURING CORP., WATERLOO, IOWA

- \_\_\_ Rush Information on 276.
- \_\_\_ Send complete catalog.
- \_\_\_ Send literature on above checked items.

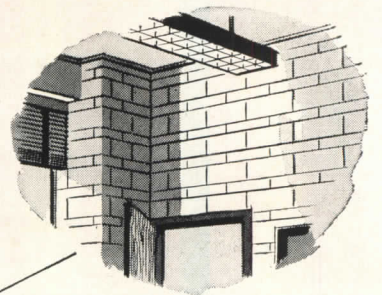
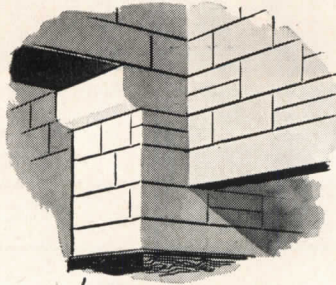
NAME \_\_\_\_\_  
ADDRESS \_\_\_\_\_  
CITY \_\_\_\_\_ STATE \_\_\_\_\_

Coursed Ashler variation with 4" & 8" units

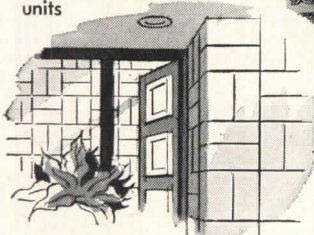
Horizontally stacked 8" x 16" units



4" x 16" and 8" x 16" courses

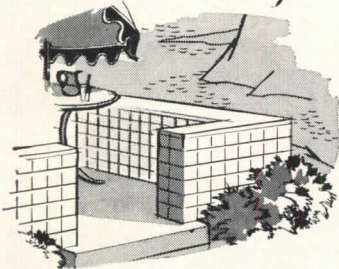
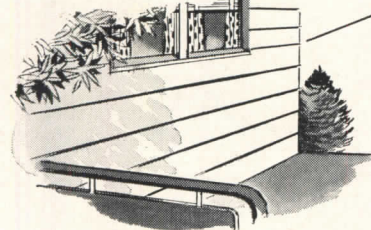


Basket-weave using 8" x 16" units

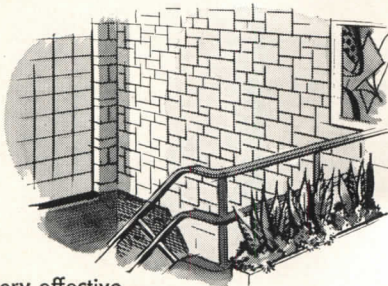


# Theme and Variations

Tooled horizontal joints; verticals wiped out



Here 8" x 8" units are stacked



A very effective patterned Ashler

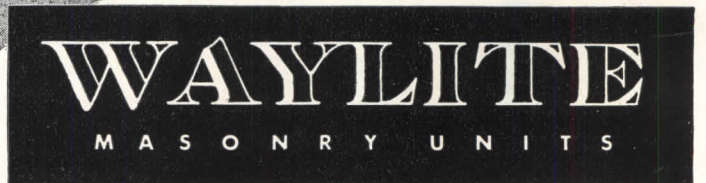
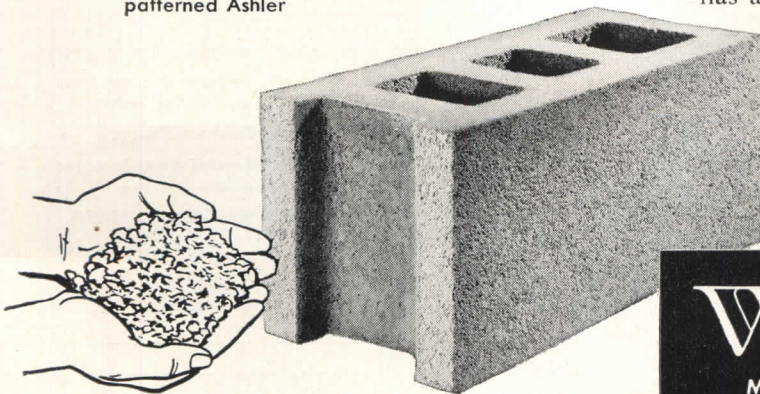


THE FAMILIAR THEME—8" x 16" FACE UNITS IN RUNNING BOND

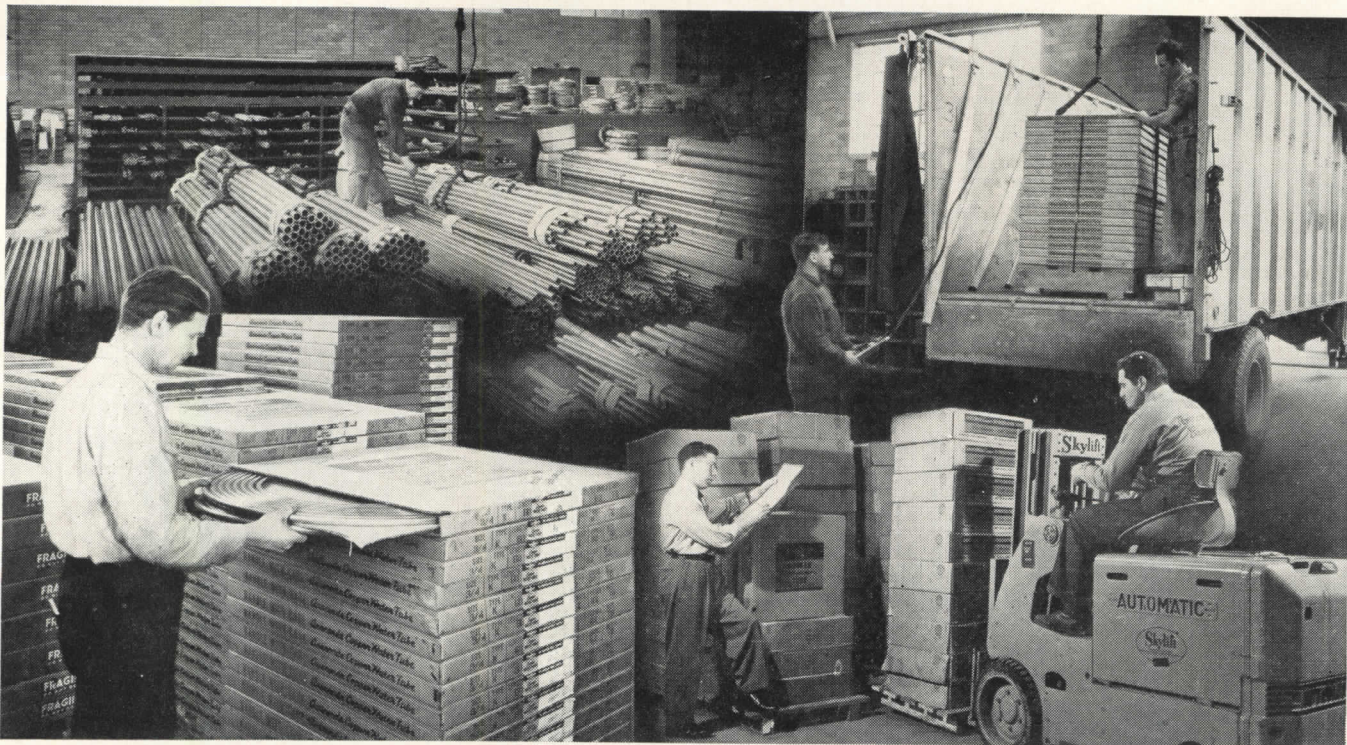
## ...with exposed **WAYLITE** Partitions and Bearing Walls

The vast musical literature of the world is limited to a maximum of 13 tones in any one octave . . . similarly there is a very wide range of harmonious effects to be obtained with Waylite masonry walls of any thickness . . . a few of the different handlings are shown here . . . they are achieved very simply. . . .

Waylite masonry has adequate structural strength—superior thermal insulative qualities—and exposed Waylite interior walls need no acoustical treatment. The Waylite Co., 105 W. Madison Street, Chicago, or Box 30, Bethlehem, Pa.







**STOCKS OF COPPER** are already in better shape at wholesale outlets. Contractors can now bid on the basis of adequate supplies of copper.

# COPPER IS NEWS!

New NPA ruling substantially increases amount of copper permitted for residential work— and new Anaconda production facilities will help keep copper supplies rolling.

The amount of copper now allowed per family dwelling unit virtually means that once again copper may be used for all water piping, for soil, waste and vent lines, and for all sheet metal work required for the

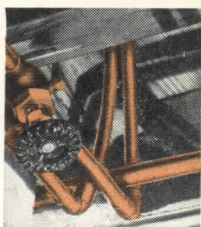
average-sized residence. And copper will continue to be available from Anaconda's new production facilities, such as the Greater Butte Project, the Chuquicamata development in Chile and Anaconda's newly modernized tube and rolling mills.

Now you can assure your clients that their plumbing and sheet metal work will give lasting service. For you can specify copper knowing that its labor-saving economy will add little, if any, to the total cost of their homes.

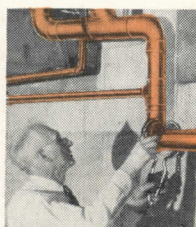
Every home you design is a *better* home when you specify copper. Every *client* becomes a more *satisfied* owner as year after year his plumbing and sheet metal work requires no attention or expense due to rust deterioration. The American Brass Company, Waterbury 20, Connecticut.

5205

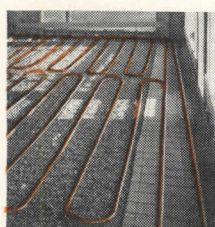
**Don't forget—now you can use copper for:**



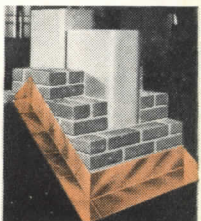
**WATER SUPPLY LINES**



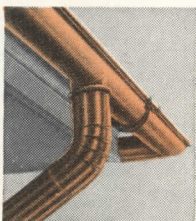
**SOIL, WASTE AND VENT SYSTEMS**



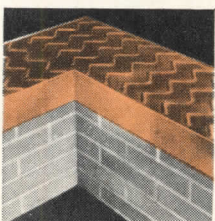
**RADIANT PANEL HEATING**



**EXTERIOR FLASHING**



**GUTTERS AND LEADERS**



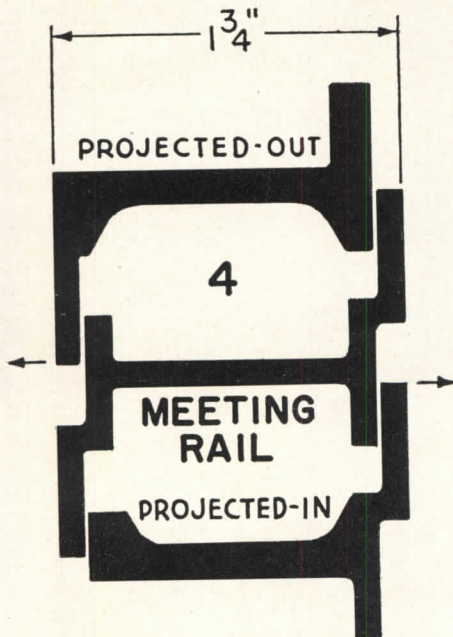
**THROUGH-WALL FLASHING**

BUILD IT BETTER WITH  
**ANACONDA<sup>®</sup>**  
 COPPER

# Where the *other* services also count — it's always BAYLEY WINDOWS

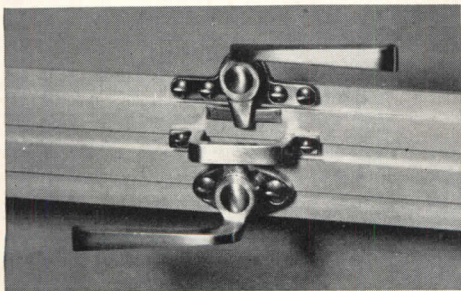
Clinton Memorial Hospital, Wilmington, Ohio  
Marley W. Lethley, Archt., Springfield, Ohio  
Sever Williams Co., Bldr., Washington C. H., Ohio

Two of the many important features of BAYLEY design



**Extra Deep Sections:** This full size section of the combined meeting rail and ventilator section (full  $1\frac{3}{4}$ " horizontally and  $2\frac{3}{4}$ " vertically) show how "Thermopane" or "Twindow" glazing can be accommodated. Also, ample room between ventilators and frame members is provided for substantial built-in hardware, such as ventilator shoes and limit arms.

**Rugged White Bronze Hardware**  
Sturdy, positive-acting handles fit neatly to the flat surface of the window and are securely mounted with grommets embedded in the section. No mechanical parts to become loose or require maintenance!



**73** Years of  
**RELIABILITY**



## Bayley Aluminum Projected Windows

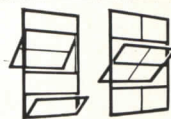
*Add Efficiency and Economy to Modern Hospital Design*

Bayley's ceaseless endeavor to better serve through all the building stages — from a hospital's inception to its occupancy — is further exemplified in the Bayley Aluminum Projected Window. In addition to carrying Bayley's "hallmark" of quality construction, it provides the design features that Hospital Authorities have requested to be incorporated in a window for most efficient hospital use. A few of these features are:

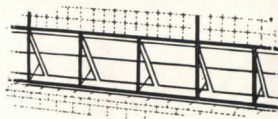
- Modern appearance
- Economy — painting unnecessary
- Permanence — long carefree life
- Simplicity — no complicated mechanism
- Adaptable to all types of construction
- Glazing outside — flat surface inside
- Easily washed from inside
- Prepared for screens
- Permits use of accessories, such as draperies, shades, curtains, venetian blinds or awnings.

These features — and still others — reflect Bayley's years of specialized window experience and recommend your discussing your needs, regardless of the requirement, with Bayley. Write or phone.

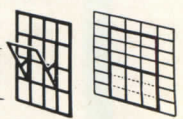
See Bayley in Sweet's. Complete catalogs on aluminum windows, 17a/BA; steel windows, 17b/BAL; Saf-T-Gard Hospital Detention Window, 17b/BAY.



PROJECTED PIVOTED



VueLINE



GUARD SAF-T-GARD

## THE WILLIAM BAYLEY COMPANY

Springfield, Ohio

District Sales Offices:

Springfield

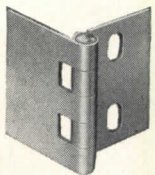
Chicago 2

New York 17

Washington 16

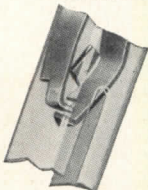
Compare Them  
for DURABILITY  
SECURITY  
TOP VALUE

**SAG-PROOF HINGES**



Rugged 5-knuckle hinges, with  $\frac{3}{16}$ " semi-recessed pins, are made of 14-gauge steel, both welded and bolted into place.

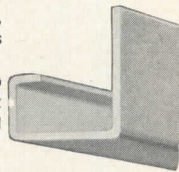
**GREATER SECURITY**



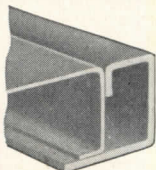
Only Medart Lockers have this patented pick-proof "dual latch" mechanism concealed in the lock rod channel. It's pre-locking, positive in action whether door is slammed or gently closed.

**STRONGER**

Entire frame — top, bottom and sides — is channel-shaped steel electrically welded into a single solid, rigid unit that stays square and true.



**STURDY BOTTOMS**



Built to take brutal punishment — won't break or sag. Full  $\frac{1}{4}$ " flange of bottom is tied solidly to steel frame. Compare this feature with ordinary lockers!

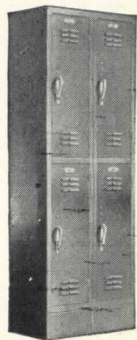
**ADJUSTABLE LEGS**

Heavy malleable iron. Front legs are adjustable up or down to compensate for unevenness of floor.



# MEDART

## STEEL LOCKERS

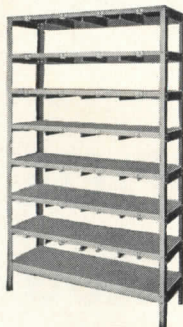


**MEDART LOCKERS**

are built in all standard types and sizes, both recessed and free-standing.

**BASKET SHELVING**

sturdy and very rugged, both permanent and portable, in many sizes is built by Medart.



A better constructed, stronger, more serviceable locker can't be bought! More than that, because Medart originated virtually every practical feature used in modern steel lockers, Medart builds the locker that includes them *all* — not just those above, but many more!

By actual comparison you'll find the skillful engineering, best quality metals and precision manufacture in Medart Lockers are a better paying long-term investment in extra years of service, far less maintenance, appearance that stays new indefinitely, and thoroughly dependable tamper-proof protection.

Medart offers 80 years of engineering experience to help analyze and solve the most complicated locker problem. No matter how modest your budget, Medart Lockers give you more for the money!

*Ask for Catalog*



**FRED MEDART PRODUCTS, INC.**

3540 DE KALB STREET  
ST. LOUIS 18, MISSOURI

*World's Only Complete Single Source For Gymnasium Equipment*

Telescopic  
Gym Seats

Lockers & Wire  
Basket Shelving

Lockerobes  
& Grade-Robes

Basketball  
Backstops

Physical Fitness  
Apparatus

Basketball & Football  
Scoreboards

Physical Therapy  
Equipment



**EVERY HEATING MAN SHOULD HAVE**



**IT'S fedders NEW AND COMPLETE  
CONVECTOR-RADIATOR CATALOG**

**FEDDERS-QUIGAN CORPORATION**

57 Tonawanda St.

Buffalo 7, N. Y.

# THIS VALUABLE NEW WORKING TOOL

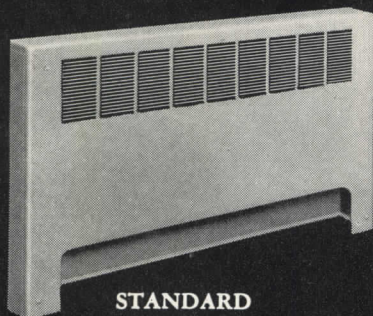
● This new 40 page book is more than a catalog . . . it's a handbook. Compiled by heating men for heating men, it gives complete, helpful selection and installation data for architects, consulting engineers and contractors.

It covers Fedders complete line of Convector-Radiators for residential, commercial, industrial and institutional uses including latest type Convector-Radiators for installation under picture windows.

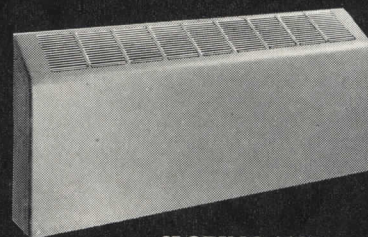
## CODE RATED

The ratings of Fedders Convector-Radiators are in conformance with Commercial Standards CS140-47, as developed co-operatively by the trade and the National Bureau of Standards, U. S. Department of Commerce, and the said ratings have been approved by the Convector Rating Committee.

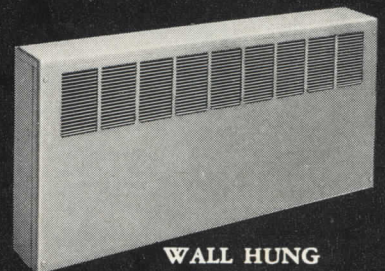
Write or send coupon for your personal copy of this useful handbook.



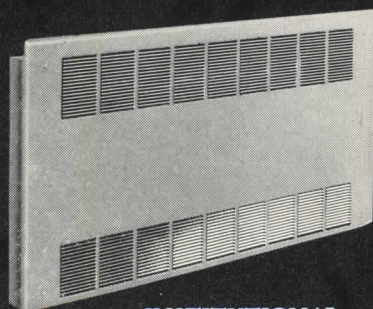
STANDARD  
TYPE F



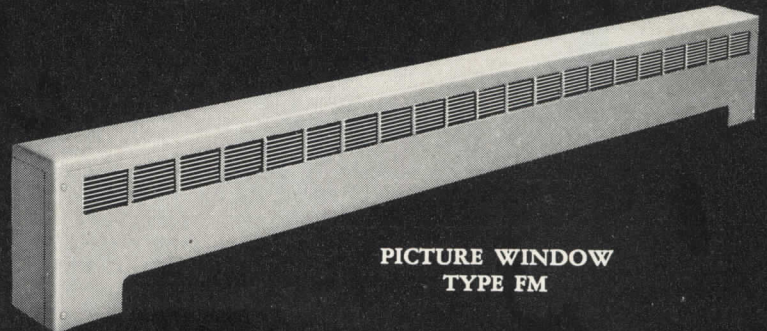
SLOPING TOP  
TYPE S



WALL HUNG  
TYPE W



INSTITUTIONAL  
TYPE RCB



PICTURE WINDOW  
TYPE FM

*Completes Types for Every Installation Need*

*Mail this coupon  
today for your  
personal copy*

FEDDERS-QUIGAN CORPORATION  
Heating Division  
57 Tonawanda Street, Buffalo 7, N. Y.

Kindly send—copies of new Convector-Radiator Catalog  
addressed to my personal attention.

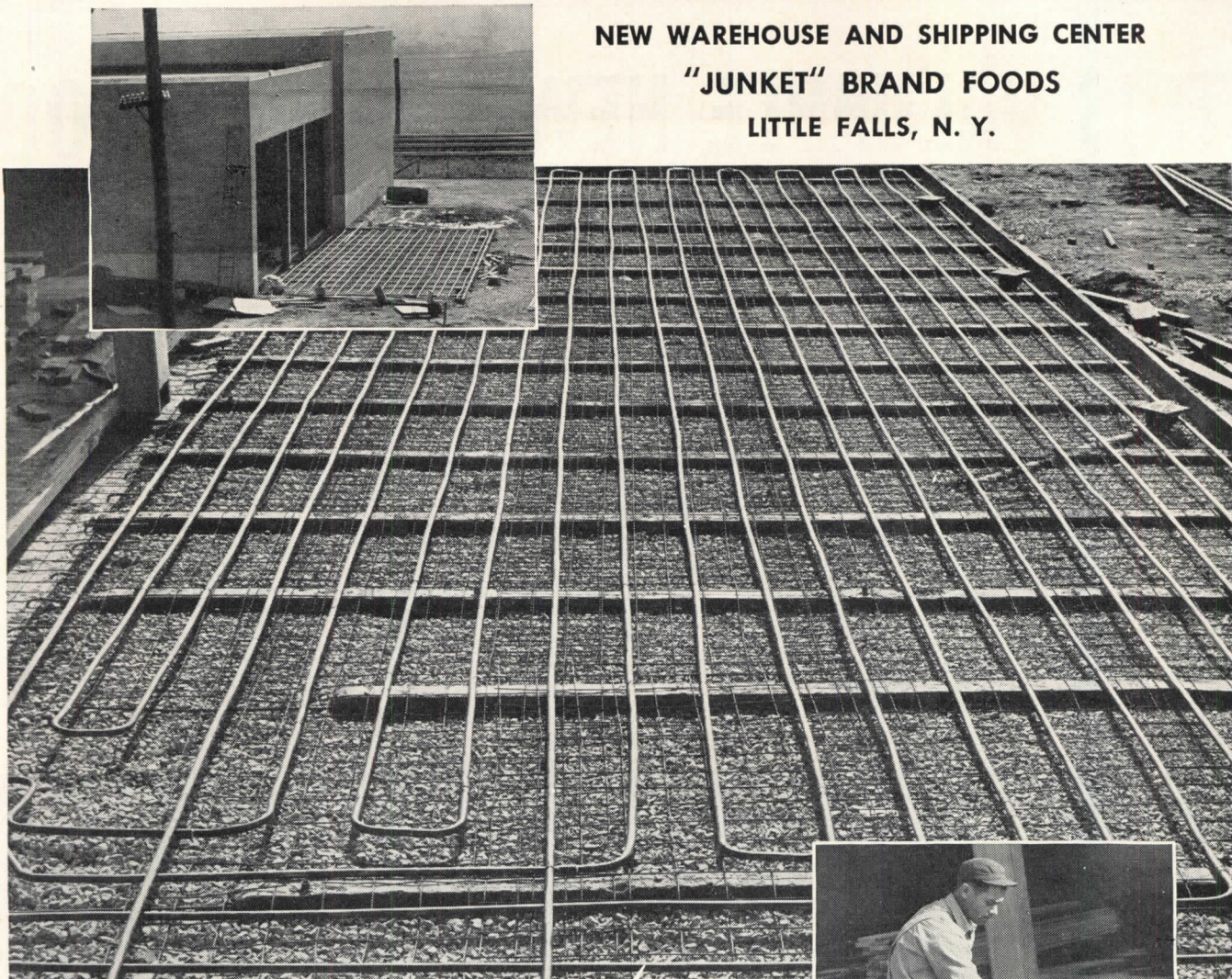
Name \_\_\_\_\_

Concern \_\_\_\_\_

Street \_\_\_\_\_

City \_\_\_\_\_ State \_\_\_\_\_

**NEW WAREHOUSE AND SHIPPING CENTER  
"JUNKET" BRAND FOODS  
LITTLE FALLS, N. Y.**



**ANOTHER CASE OF**

*Copper*

**WHERE IT COUNTS!**

During the winter months there will be no snow or ice troubles at the truck entrance of the new "Junket" Brand Foods Warehouse. A snow-melting system of Revere Copper Water Tube in the 20' x 60' concrete slab sees to that. This building was designed by Architects, Bagg and Newkirk. Heating Contractor was H. J. Brandeles Corp. Revere Copper Water Tube was supplied by the Crane Co., all of Utica, N. Y.

The contractor found the light-weight, 60' length coils of Revere Copper Water Tube easy to handle and install. Also, its soft temper permitted bending, reducing the number of fittings used. Other features that architects, contractors and builders like about Revere Copper Water Tube are: Because it is non-rusting it will last indefinitely . . . the solder or compression fittings used make it possible to use a thinner wall tube than is possible when threaded fittings are used, with a substantial saving in metal.

Now, with restrictions eased, and quantities permissible without allotments greatly increased, there isn't any reason why your next job can't have the many lasting benefits of Revere Copper Water Tube for hot and cold water lines, radiant panel heating, underground service lines, processing lines, and waste stack and vent lines. See the Revere Distributor nearest you today. And, if you have technical problems, he will put you in touch with Revere's Technical Advisory Service.



GUIDE PLANK is used by workman to facilitate installation of 1" Type K soft temper Revere Copper Water Tube. Revere Tube also comes in hard and soft tempers in straight lengths of 20 ft.

LARGE PHOTO ABOVE shows Revere Copper Water Tube in place ready for pouring concrete.

**REVERE**

**COPPER AND BRASS INCORPORATED**

*Founded by Paul Revere in 1801*

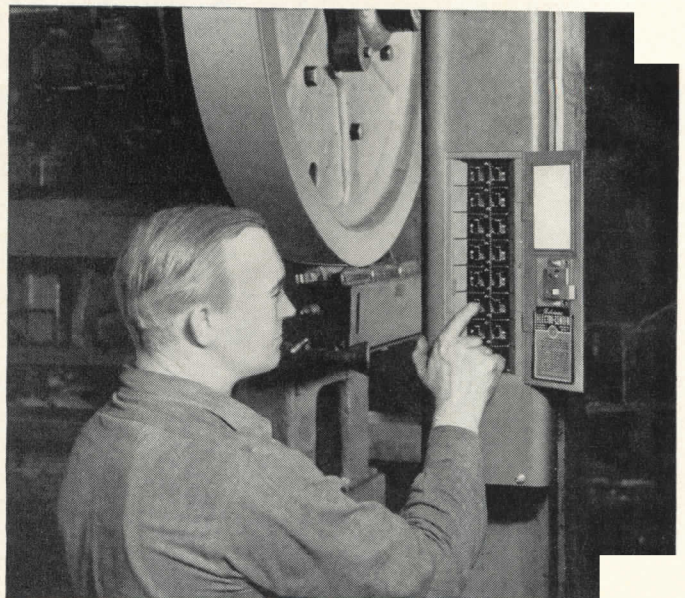
230 Park Avenue, New York 17, N. Y.

*Mills: Baltimore, Md.; Chicago and Clinton, Ill.; Detroit, Mich.; Los Angeles and Riverside, Calif.; New Bedford, Mass.; Rome, N. Y.—Sales Offices in Principal Cities, Distributors Everywhere.*

**SEE REVERE'S "MEET THE PRESS"  
ON NBC TELEVISION EVERY SUNDAY**



NPB Electri-Centers blend into surroundings naturally, don't have that "electrical look." Wireway extensions replace exposed conduit pipes on wall leading from ceiling to panel cabinet. Column may be extended to floor if desired.



Slim dimensions make it easy to install NPB panels where wall space is limited or not available. They slip easily inside a standard 8" H-beam, fit snugly because of rounded corners. Front overlaps back for deep recessing.

## LIGHTING PANELS CAN BE ATTRACTIVE

No maze of conduit pipes or cables leads into these compact lighting panels! Architects who specify NPB's can be sure that they will have top-notch appearance when installed, will cut installation costs for clients.

Specify NPB Electri-Centers for any commercial or industrial surface-mounted lighting-panel installation up to 32 circuits. They get rid of "open-plumbing look" in offices, hallways, factories and shops. They may be mounted against walls, on columns, or in H-beams. Streamlined for appearance and safety; no sharp corners to snag, scrape or bump. No jutting cabinet on columns to hamper traffic of personnel or mobile mechanical equipment. Beautiful gray enamel finish.

**BullDog** NPB Electri-Center lighting panels let your clients eliminate the high expense of bending pipes to fit panel knockouts, and of pulling wires down through conduit pipes. All wires, from ceiling to panels, are contained in wireway extensions. Neutral wires are attached to neutral bar in Pull Box at ceiling (or in false ceiling), eliminating individual neutral wires down to cabinet. Wiring can be inspected any time by simply removing front. Pushmatic® Circuit Breakers, interchangeable from 15- to 50-amps., make NPB Electri-Centers compact, versatile.

Investigate NPB Pushmatic Electri-Centers now! Write for NPB Bulletin, or request call from a BullDog field engineer.

**BullDog Narrow Column (NPB) Pushmatic Electri-Centers make attractive lighting panels; give easier, lower-cost installation; eliminate unsightly conduit pipes and cables.**

### NPB FEATURES ARE YOUR ADVANTAGES!

- NPB's are only 6¾" wide, 6⅝" deep. Come in 16-, 24-, and 32-circuit capacities. Listed by Underwriters' for 1 ph., 3 wire, s.n., 120/240V A.C. or 3 ph., 4 wire, s.n., 120/208V A.C.
- Wireway extensions reach to ceiling or false ceiling regardless of height, or to wiring in truss-constructed buildings.
- Lightweight, easy to handle; no loose parts to misplace.
- "Open-plumbing look" eliminated with wireway extensions.
- Numbered wire retainers are attached to back of box for circuit identification. All wiring, including main lugs, can be done before interior is installed.
- Attractive, interchangeable Bull-Dog Pushmatic Circuit Breakers make NPB Electri-Centers compact, versatile.
- All copper current-carrying parts silvered for greater conductivity.
- Sell for price of ordinary panels; much cheaper to install.



# BULLDOG

**BULLDOG ELECTRIC PRODUCTS COMPANY**

DETROIT 32, MICHIGAN • FIELD OFFICES IN ALL PRINCIPAL CITIES  
IN CANADA: BULLDOG ELECTRIC PRODUCTS OF CANADA, LTD., TORONTO

**PIONEERS IN FLEXIBLE ELECTRICAL DISTRIBUTION SYSTEMS**

1902-1952 . . . SERVING INDUSTRY FOR 50 YEARS WITH FINER ELECTRICAL PRODUCTS

# America's No. 1 Public Seating Buy!



2900 Series  
Spring-Cushion Chair

2700 Series  
Padded-Seat Chair

\* 2600 Series  
All-Steel Chair

2025 Series  
Plywood-Seat Chair

8102 Series  
Masonite-Top Table

# Samson Folding Chairs

## SPECIAL LOW PRICES

**On America's Number One  
Public Seating Buy!**

● Your local Samson distributor can offer you especially low prices on quantity purchases. Ask him for a quotation on your public seating needs or write us direct for information.

**Posture-Designed For Extra Comfort! Steel Construction For Extra Strength! Special Folding Action For Extra Safety!**

SAMSON FOLDING CHAIRS are definitely your best public seating buy because they offer you: (1) low cost; (2) long life; (3) real comfort; (4) unsurpassed ease of handling!

\*Impartial laboratory tests by Pittsburgh Testing Laboratories found the Samson 2600 series chair: "Substantial, well-balanced, easily set up or folded, storing in the most compact space,

weight uniformly distributed, folding mechanism guards against injury, seat rigidly supports framework, back is properly shaped for comfort."

### Leading Users Choose Samson:

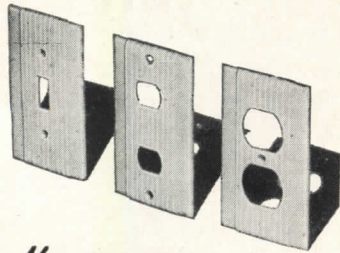
United States Navy; Transcontinental World Airlines, Inc.; E. I. DuPont de Nemours & Co.; Denver University Arena; American President Lines; Federal Reserve Bank, *Richmond, Virginia*; National Broadcasting Co., Inc.; Stix, Baer & Fuller Co., *St. Louis, Missouri*.

THERE'S A **Samson** FOLDING CHAIR FOR EVERY PUBLIC SEATING NEED

**Shwayder Bros., Inc., Public Seating Div., Dept. J-9, Detroit 29, Michigan**

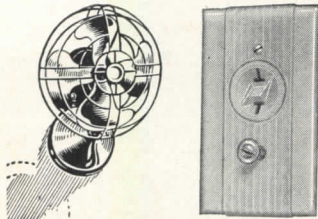
ALSO MAKERS OF FAMOUS SAMSON FOLDAWAY FURNITURE FOR THE HOME AND SMART SAMSONITE LUGGAGE FOR TRAVEL





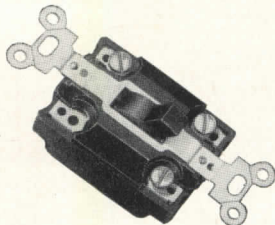
### New UNILINE PLATES

One attractive design to fill all wall plate needs. Blends with all interiors; provides complete architectural uniformity. Available in Bakelite and Ivorylite for Standard and Interchangeable devices.



### FAN HANGER OUTLET

This neat device provides in one unit both electrical connection and mechanical support for fans. Modern Uniline design in Bakelite or Ivorylite. Easily installed in standard 4" box. 15 Amp. 125 V., 10 Amp. 250 V.



### BACK-OR-TOP-WIRED SWITCH

Installed without bending or looping wire. Ideal for use with heavier wiring needed to meet modern electrical demands. Specification grade, T rated. 10 and 20 Ampere sizes with Brown or Ivorylite levers or lock.



### BACK-OR-SIDE-WIRED CONVENIENCE OUTLETS

Advanced design for fast installation. An exclusive H&H feature allows instant conversion from Duplex to 2-Circuit receptacle by removing detachable fin. 15 Amp. 125 V., 10 Amp. 250 V.



## ELECTRICAL AVAILABILITY

*Important to*

**SCHOOLS, OFFICES  
HOSPITALS, STORES**

Build your reputation by jobs done well. Make sure your specifications provide the full, modern electrical availability so important to your clients. Look to the complete H&H line; for every circuit requirement there's an H&H wiring device to give the ultimate in performance, convenience and dependability. You can make your electrical planning jobs easier, better; send today for your copy of our big, fully illustrated catalog. Just write to 1910 Laurel Street, Hartford 6, Connecticut.

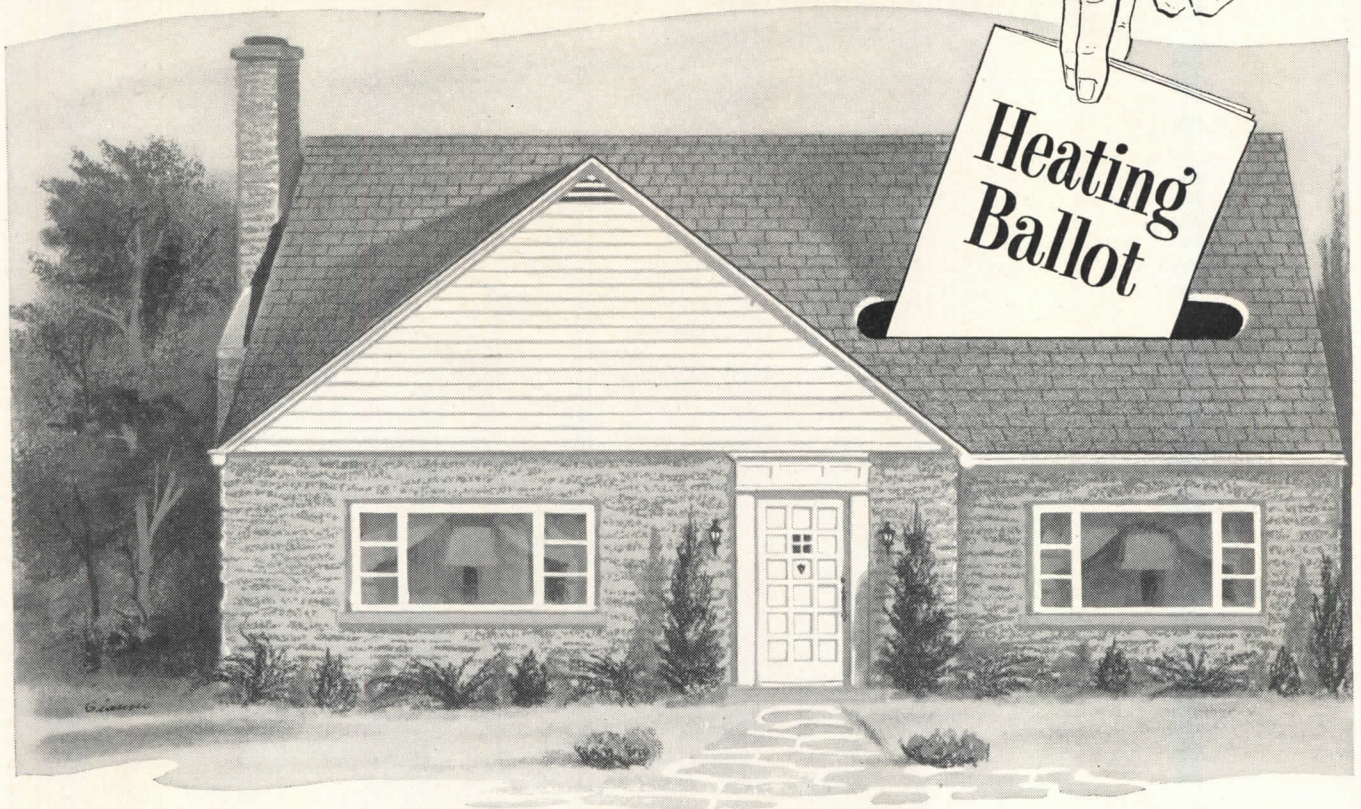


*Wiring Devices*  
AND ENCLOSED SWITCHES

THE ARROW-HART & HEGEMAN ELECTRIC CO., HARTFORD, CONN.

Branches in: Boston, Chicago, Dallas, Denver, Detroit, Los Angeles, New York, Philadelphia, San Francisco, Syracuse. In Canada: Arrow-Hart & Hegeman (Canada) Ltd., Mt. Dennis, Toronto.

# Why they all voted for RADIANT PANEL HEATING



## for the New House!



Architect

"Keeping up with the Joneses took on a new meaning for me when they asked me to plan their new house. They knew what they wanted and they wanted the most modern of everything. But when it came to the heating system I was way ahead of them. When I explained Radiant Panel Heating they went for it in a big way!"



Wife

"I wanted what my husband did, too, but more than that I wanted *freedom to decorate*. Because our Radiant Panel heating units are concealed beneath the floor, or in the ceiling, every inch of every room is now mine to use. My rooms seem larger! I can place my furniture as I please!"



Husband

"After dreaming about building a new house for years I knew exactly what I wanted in a heating system. Comfort, warm floors, uniform temperature, freedom from drafts, more vital air, no hot or cold spots. Radiant Panel Heating was the answer."



Builder

"Radiant Panel Heating is easy to install in a new house, and my heating men *know* steel pipe. They're used to handling it. They know it's been proved in more than 60 years of hot water and steam heating applications; that it's formable and weldable for fabricating coils and grids. That's why, for radiant heating, snow melting, and other applications, *steel* is the most widely used *pipe* in the world!"

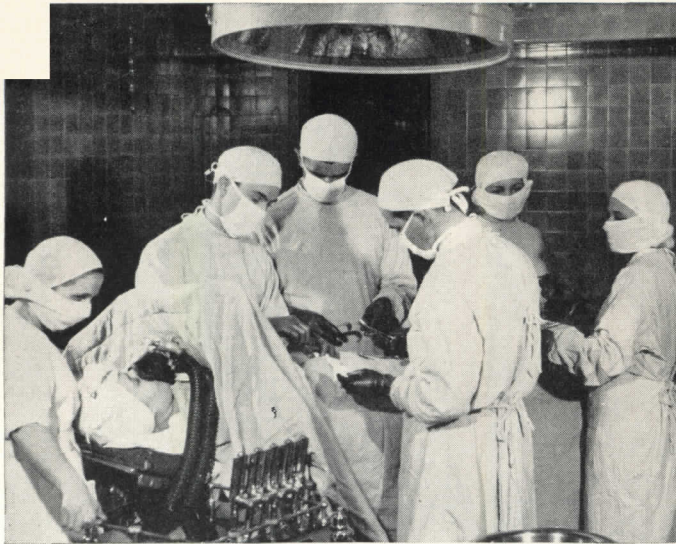
A free 48 page color booklet "Radiant Panel Heating with Steel Pipe" is available. Write for your copy.

**Steel Pipe  
is First Choice**

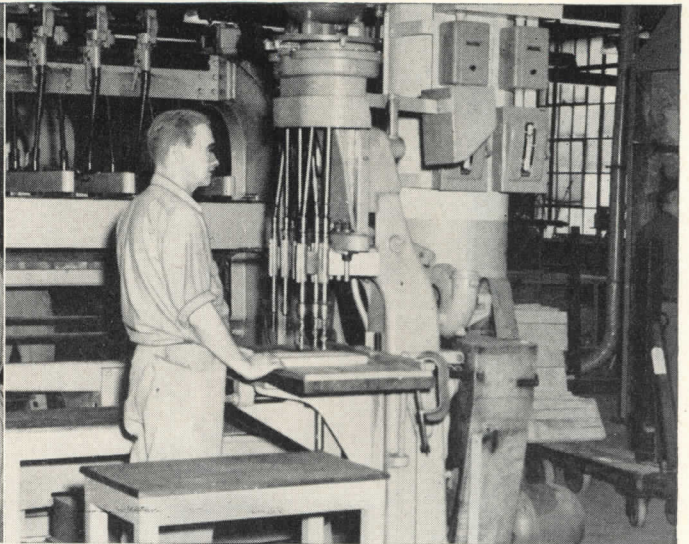
**COMMITTEE ON STEEL PIPE RESEARCH**

AMERICAN IRON AND STEEL INSTITUTE

350 Fifth Avenue, New York 1, N.Y.



HOSPITALS



FACTORIES

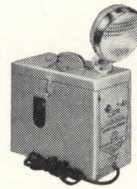
# Exide

## EMERGENCY LIGHTING

### Dependable protection from hazards of lighting failure

Safeguard the buildings you design against lighting failure. In many cities emergency lighting protection is a legal requirement for hospitals, schools, stores, theaters, restaurants, factories and other buildings where large numbers of people assemble. Similar legislation is being considered in other cities. It is important, for despite all precautions of utility companies, storms, fires, floods and accidents can interrupt normal supply of current.

Exide provides units and systems for every emergency lighting requirement. Large systems for entire buildings and groups of buildings. Other systems and units for selected rooms, corridors, stairways, exits. Small portable units—the Exide Lightguard—for localized needs. In each system and unit, batteries are always fully charged and ready to respond *instantly* and *automatically*.



#### EXIDE LIGHTGUARD

Here's a portable, low cost unit that can be plugged into any 115 Volt, 60 Cycle A.C. lighting socket. When normal current is cut off, a built-in relay instantly and automatically turns on the powerful floodlight. After normal service is restored, the relay shuts off floodlight and turns on the charging current. The Exide battery is always fully charged ready for immediate action.

THE ELECTRIC STORAGE BATTERY COMPANY  
Philadelphia 2

*Exide Batteries of Canada, Limited, Toronto*  
"EXIDE" and "LIGHTGUARD" Reg. Trade-Mark U. S. Pat. Off.

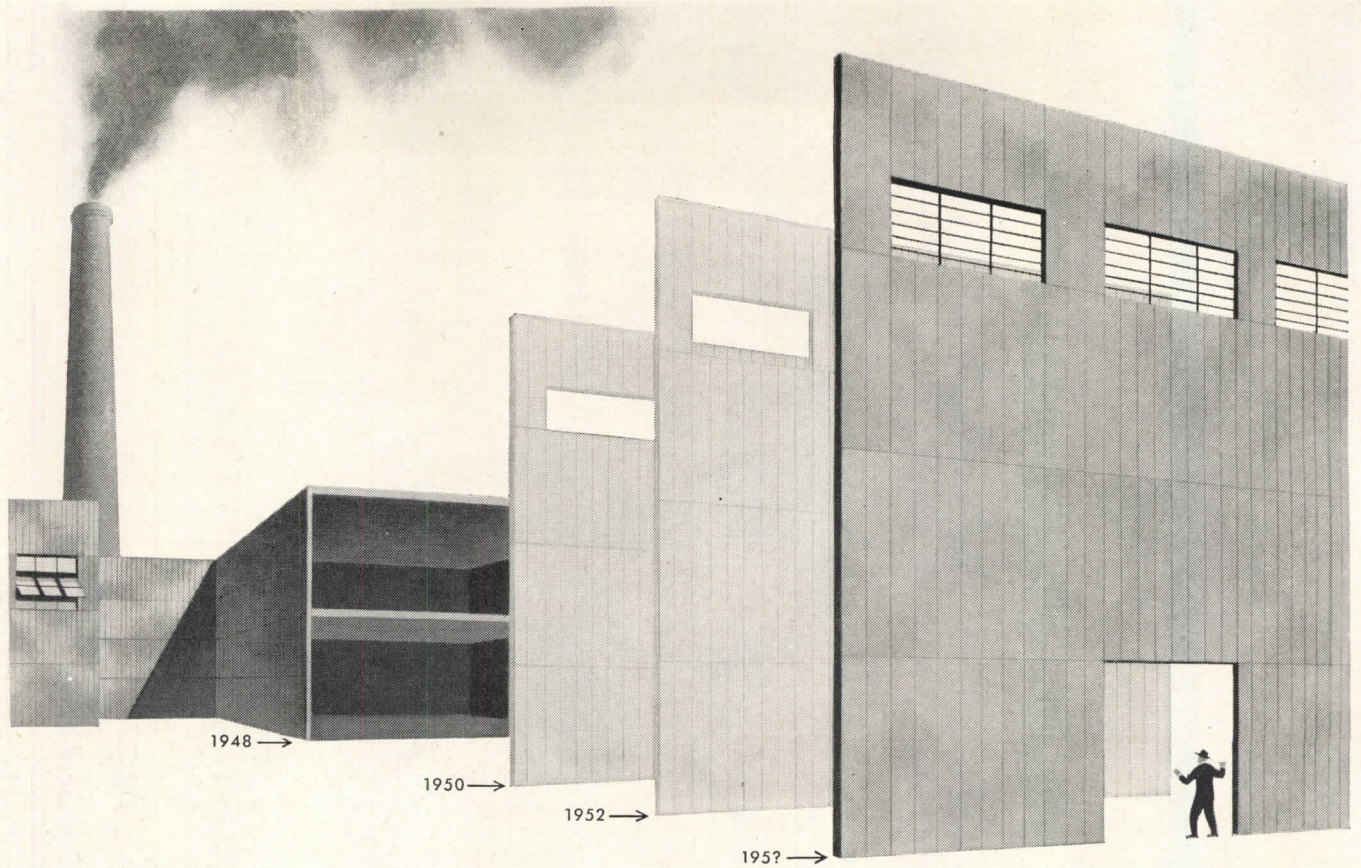


STORES



SCHOOLS

**1888—DEPENDABLE BATTERIES FOR 64 YEARS—1952**



## CASE OF THE WALKING WALL

Twice this wall stepped out to let the plant expand. It could just as well be twenty times.

You simply take the wall apart and move it further out, saving the materials and money involved in building a new one. That's what they did at Dayton Power & Light.

The walls of this building are locked-together Fenestra\* "C" Panels . . . long, strong, steel metal units with glass fiber insulation sealed inside.

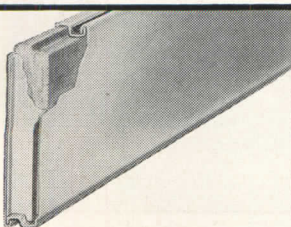
And, if you build *your* new building of Fenestra "C" Panels, you'll see it go up area by area instead of inch by inch.

You'll see your walls rise 16 square feet a leap . . . complete inside-outside, insulated walls. Fine-finished walls that are either prime-painted steel, or aluminum . . . so smooth that dirt and grease can't get a grip. Walls that are noncombustible. Walls that will *walk* when you need extra space.

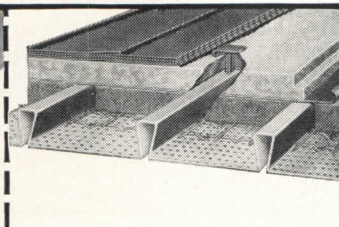
Look at the close-ups of Fenestra Metal Building Panels shown below. Let us explain how they can help you speed the construction of your new building, save structural steel, cut the cost of labor. Write to Mr. Earle C. Hodges, Vice President, Detroit Steel Products Company, Dept. AR-10, 2252 E. Grand Blvd., Detroit 11, Michigan. \*Trademark

# Fenestra METAL BUILDING PANELS

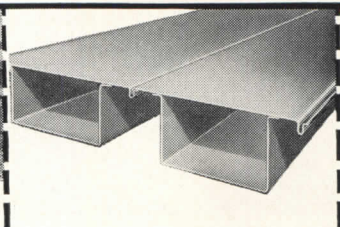
. . . engineered to cut the waste out of building



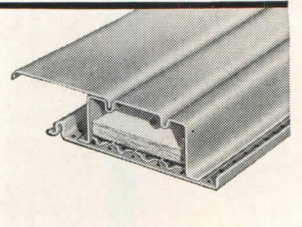
"C" Insulated Wall Panels. Width 16". Depth is 3". Steel or aluminum.



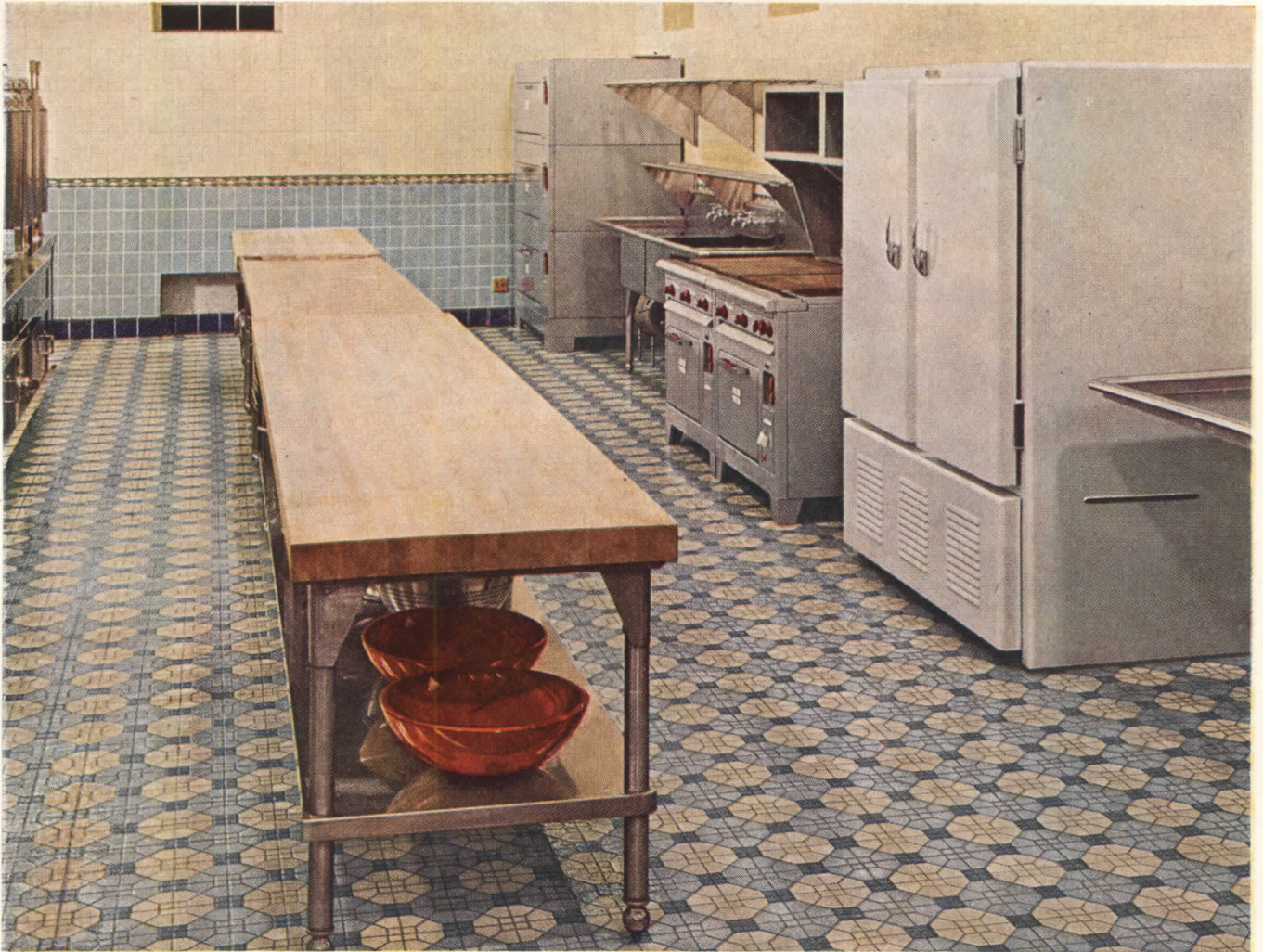
Acoustical Holorib for acoustical-structural roof. Width 18". Depth 1½".



"D" Panels for floors, roofs, ceilings. Standard width 16". Depth 1½" to 7½".



Acoustical "AD" Panels for ceiling-silencer-roof. Width 16". Depth up to 7½".



In this efficient kitchen tile is used on ceiling areas as well as walls, for easy cleaning.


## NEW Booklet... modern short cut to LOWER *Maintenance* and HIGHER *Morale*

Kitchens, washrooms, locker rooms and similar areas can be the brightest spots in a factory, when walls and floors are tiled. They are bright spots for management because maintenance costs are low, and janitor costs are slashed to the bone. Bright spots for workers' morale, too, since unsightly washrooms are a major cause of labor unrest.

American-Olean's new booklet on Industrial Installations is packed with helpful facts. Pages of color photographs show actual installations. You preview colors and make selections

from accurate color plates... ready-to-use specifications are included in this convenient, file-size reference booklet.

There's no other booklet like it. Write now for your free copy.



**AMERICAN-OLEAN TILE COMPANY**  
930 Kenilworth Avenue, Lansdale, Pa.

Gentlemen:  
Please send me my free copy of Booklet 300,  
Modern Industrial Washrooms.

Name \_\_\_\_\_ Title \_\_\_\_\_  
Firm Name \_\_\_\_\_  
Street \_\_\_\_\_  
City \_\_\_\_\_ State \_\_\_\_\_

### AMERICAN-OLEAN TILE COMPANY

Executive Offices, 930 Kenilworth Ave., Lansdale, Pennsylvania

## Make your next houses Weathermaker Homes

It's the sensible way to air condition your new houses.

Because you design the house around the Carrier Weathermaker that heats and cools, you don't need wings, offsets or ells, movable sash, screens, fans, porches or louvers. And you save your client the cost of all those halfway measures to halfway comfort.

Because you design the house to keep heat out, you reduce the first cost and the operating cost of the air conditioning.

Because you can ignore outside ventilation, you have the freedom to design a better, more convenient, more spacious-looking home.

So make your next houses Weathermaker Homes!

It won't hurt a bit to get the full story. So write--today!

### Carrier

AIR CONDITIONING REFRIGERATION

---

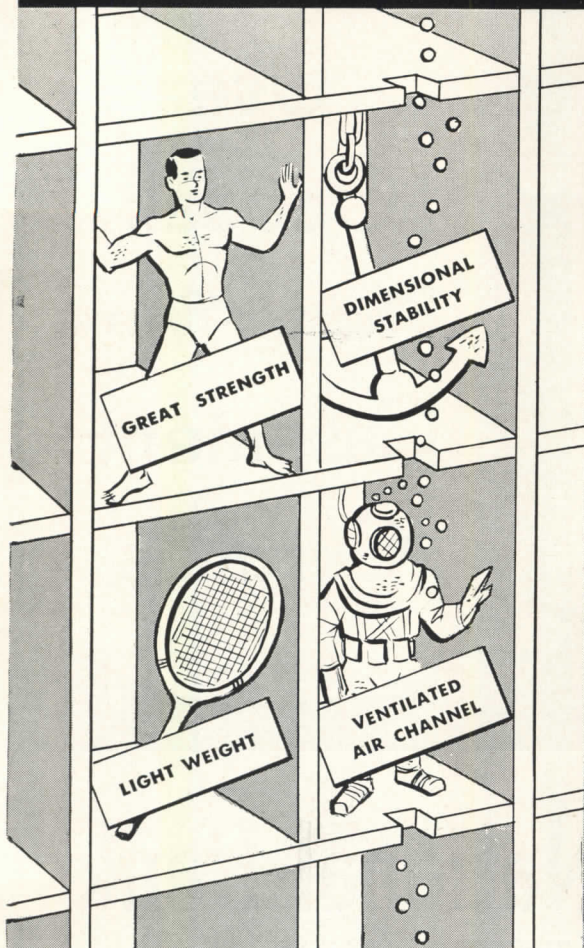
Carrier Corporation  
312 S. Geddes Street  
Syracuse, New York

Please send me the full facts on the Carrier  
Weathermaker and the Weathermaker Home.

Name \_\_\_\_\_  
Street \_\_\_\_\_  
City \_\_\_\_\_ State \_\_\_\_\_

# You can SEE the *Engineered Strength in* **PAINE REZO DOORS**

T. M. REGISTERED



IT'S SO EASY to fit the strongest — and best — flush door into your building plans, for the structural superiority is plainly evident . . . and the cost is fully in line with the market price for commonplace doors. Paine Rezo offers you exclusively: the ventilated air-cell principle that maintains the same atmospheric conditions inside the door as exists outside; the interlocked, interwoven all-wood core that provides unmatched stability.

The case history of this original construction goes back in the building industry to 1936. It has so impressed architects and contractors everywhere that they have decided more than five million times to install the Paine Rezo door — a decision that has made the company behind it the world's largest mills devoted exclusively to the production of hollow core flush doors. See Sweet's File, or write today for an illustrated factual bulletin.

*Manufactured by the*

**PAINE LUMBER CO., LTD.**

*Oshkosh  
Wisconsin*

ESTABLISHED 1853



Leading  
Companies  
Use  
Goodall  
*Blended-to-Perform*  
Casement  
Curtains



# The Chase National Bank

BROADWAY, CORNER OF 73rd STREET, NEW YORK CITY

## is another famous Goodall Installation

**Richer Beauty**—Goodall Casements add modern beauty to offices in a wide range of luxurious weaves . . . and diaphanous textures. Patterns, solids, and decorator colors harmonize with or set the decorating theme.

**Light Control** — Goodall Casements cut the harsh glare of sunlight, help provide soft, natural light at maximum distance from windows.

**Noise Control**—Goodall Casements actually absorb sound instead of bouncing it back like hard, flat surfaces. This noise-muffling property helps cut distracting office clatter.

**Longer Wear** — Goodall Casements are *Blended-to-Perform* . . . a variable blend of Angora, mohair, rayon and acetate. Each fiber is chosen for its virtues . . . for longer wear as well as beauty and luxury.

**Low Maintenance** — Goodall Casements resist wrinkling, stay fresh longer. Dust virtually slides off their smooth surface. Thanks to multiple processes that minimize shrinking, sagging, or stretching . . . they can be washed or dry cleaned.

For full information on the wide choice available write: Goodall Fabrics, Inc., Casement Div., 525 Madison Ave., New York 22, New York.

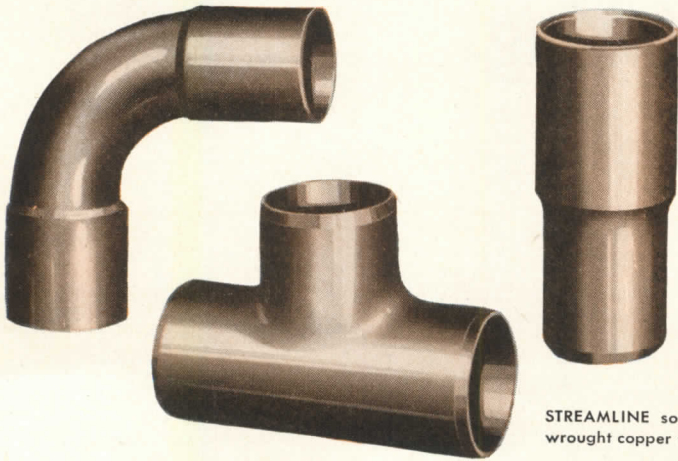
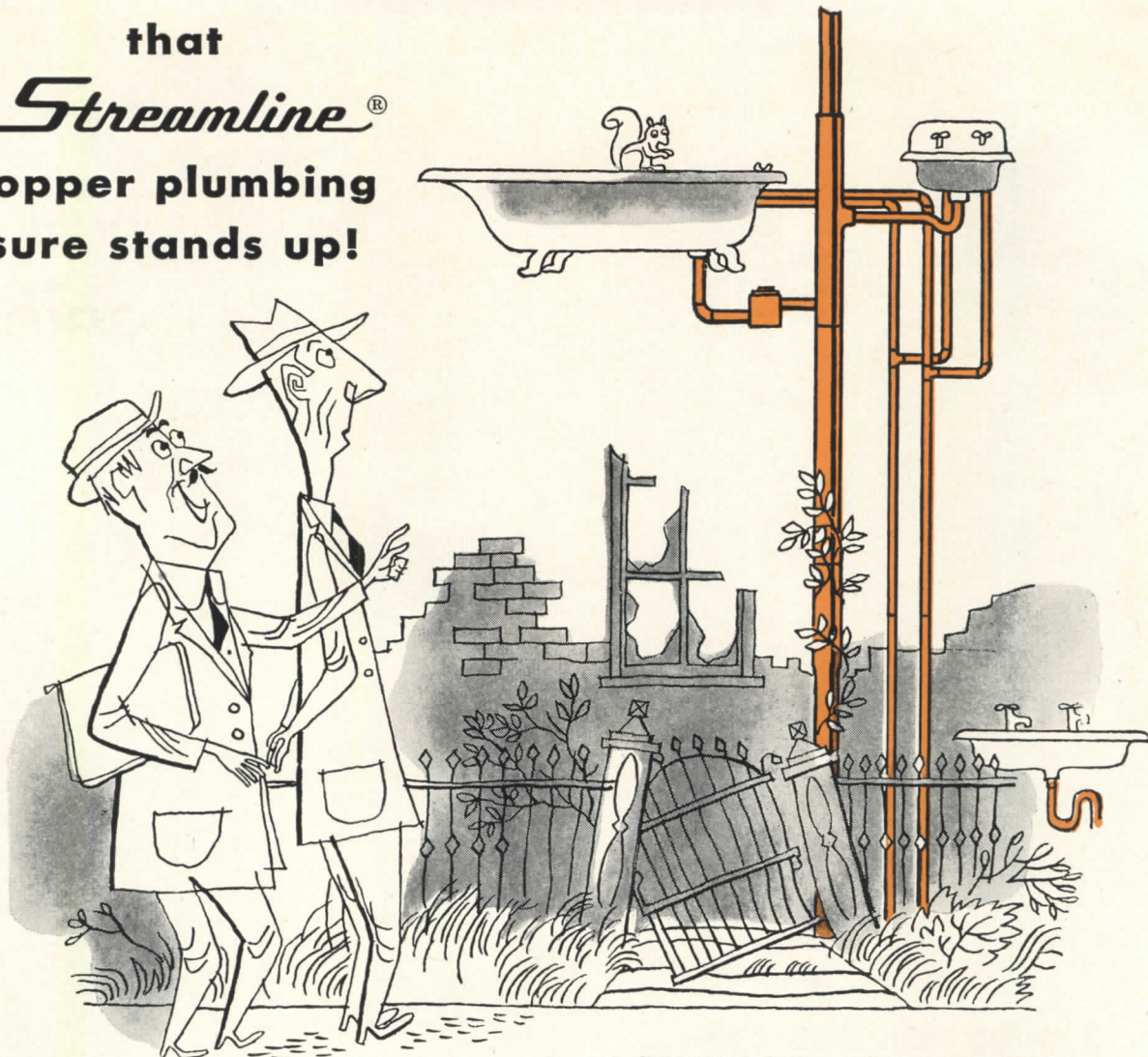
\*Reg. T. M.



© 1952, Goodall Fabrics, Inc. Subsidiary, Goodall-Sanford, Inc. (Sole Makers of World-Famous PALM BEACH\* Cloth)  
GOODALL FABRICS, INC. NEW YORK • BOSTON • CHICAGO • DETROIT • SAN FRANCISCO • LOS ANGELES



that  
*Streamline*<sup>®</sup>  
 copper plumbing  
 sure stands up!



STREAMLINE solder type wrought copper fittings.

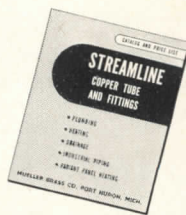


STREAMLINE threaded cast bronze fittings.

STREAMLINE fittings won't rust, are clog-resistant, and they can't be loosened by vibration. So when you install STREAMLINE solder type fittings, you can be sure you're installing a permanently reliable plumbing system that will last for years and years—even under the toughest conditions.

STREAMLINE wrought fittings are easy to install because they are light in weight . . . dimensions are accurate . . . and because solder joints are the same uniform depth to make it easy to compute the tubing length. By reducing handling time, STREAMLINE fittings increase the number of jobs you, as a contractor, can handle.

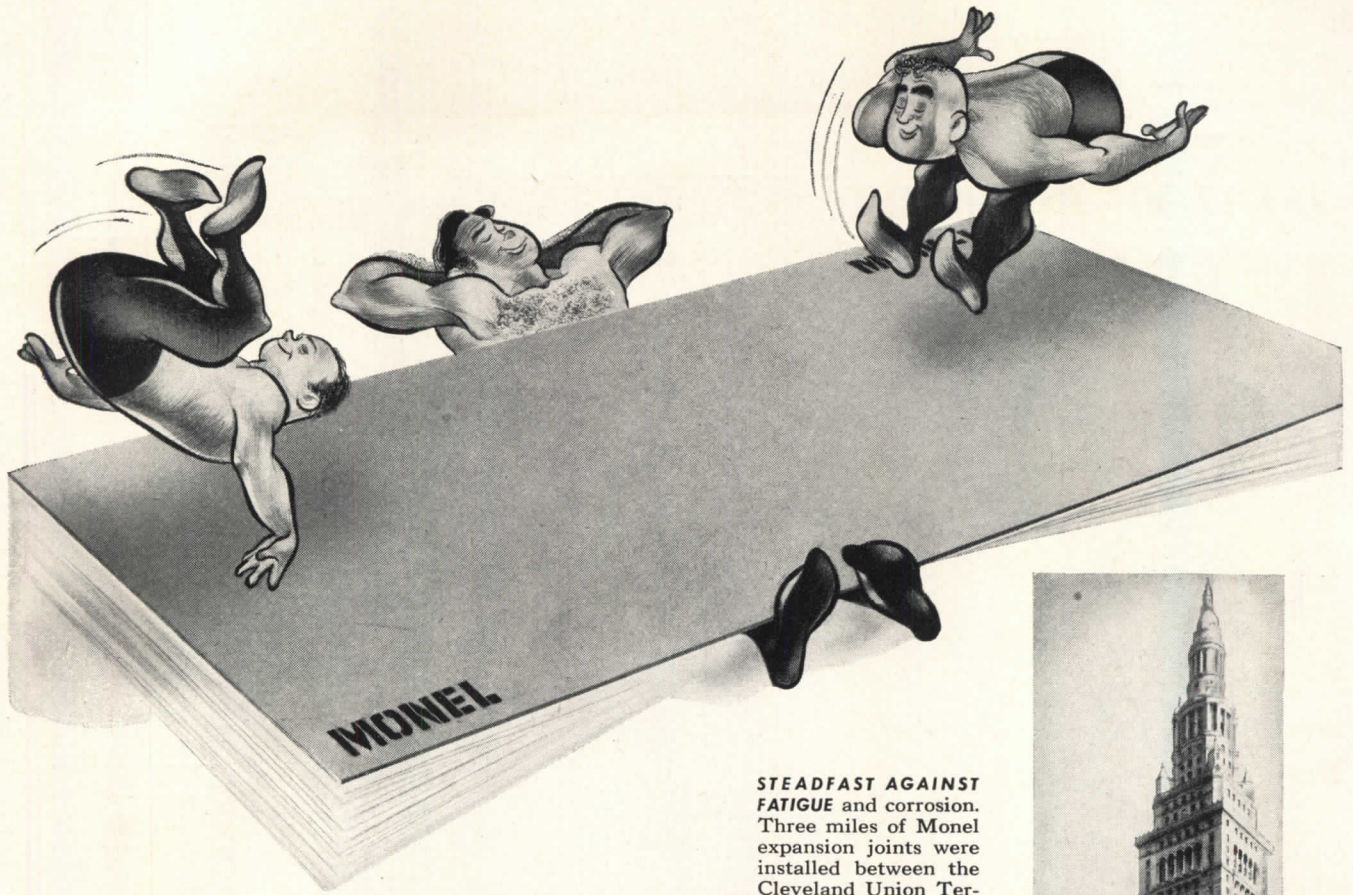
STREAMLINE fittings provide an attractive, snug-fitting system that tests leakproof on the first try and won't develop leaks later. Next time you install a plumbing, air conditioning or industrial system, be sure it's a STREAMLINE system.



See your jobber for further information or write for catalog S-352 describing our complete line of STREAMLINE wrought copper and cast bronze fittings.



**MUELLER BRASS CO.** PORT HURON 7, MICHIGAN



**STEADFAST AGAINST FATIGUE** and corrosion. Three miles of Monel expansion joints were installed between the Cleveland Union Terminal and surrounding buildings, sidewalks and pavements when the station was erected in 1928. Periodic inspections have shown the Monel joints still in excellent condition.



A roofing sheet to remember ...

## It takes worlds of flexing without cracking!

A **roof** is no "resting place" for metal!

*It gets pushed and pulled and twisted by heat and cold . . . by high winds and heavy loads.*

**That's why** a roofing sheet like Monel® is worth remembering. Its excellent fatigue strength keeps it from cracking.

How do we know? We've proved it—in tests that show Monel Roofing Sheet can withstand a load of 24,500 psi through 100 million bending and flexing cycles!

**Right now** — because of the demand for nickel and nickel alloys in the defense program — Government orders prohibit use of Monel for building applications.

**In time**, though, there'll be enough Monel available for normal roofing needs. Until then, let INCO help you in planning for the future. Write our Architectural Section and ask them to keep you supplied with the latest technical information and literature. There's no obligation, of course.

THE INTERNATIONAL NICKEL COMPANY, INC.  
67 Wall Street, New York 5, N. Y.



**MONEL** ... "For the Life of the Building"

# BUS DUCT IS FLEXIBLE

## Meets rapidly fluctuating load demands in vast Onondaga County War Memorial Auditorium

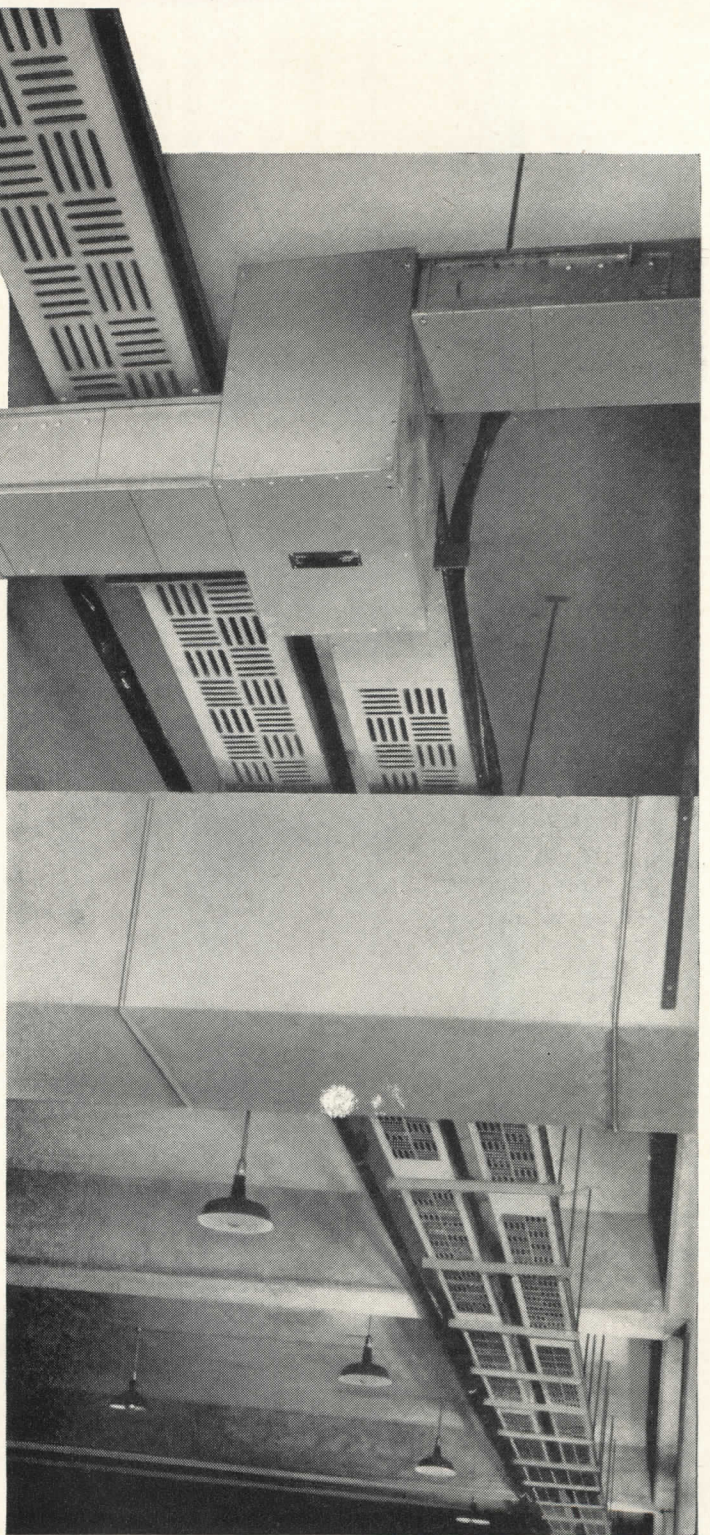
Costing \$4,000,000, this new building covers a full city block in Syracuse, New York. Because it is used as a combination auditorium, convention hall, sports arena, concert hall, exhibit area and for office space, load demand changes swiftly day to day, night to night.

*Westinghouse Bus Duct systems handle any such load demand or service condition efficiently . . . economically.*

Neat, clean, safe and out of the way, Westinghouse Bus Duct fits attractively into the structural elements of buildings. Duct is ideal for carrying power from source to load in institutional and municipal buildings, as well as in industrial plants.

Four types are available for any load up to 5,000 amperes. Completely prefabricated sections come in any desired length up to 10 feet, are highly adaptable to long runs and tight layouts. Sections are easy to handle, easy to install.

Get the complete details from your Westinghouse Representative or write for B-4272-A, Westinghouse Electric Corporation, P. O. Box 868, Pittsburgh 30, Pa. J-30109



YOU CAN BE SURE...IF IT'S  
**Westinghouse**

**BUS DUCT**



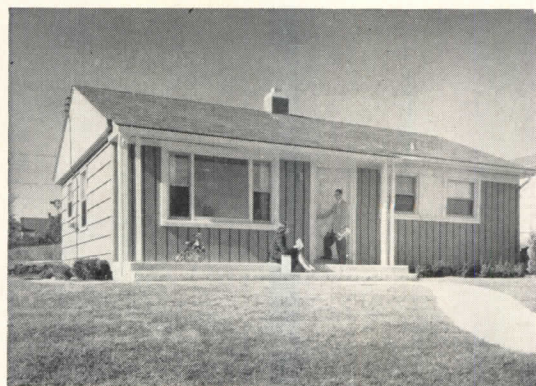
# Big, Little or In-Between...

## RUSCO OFFERS MORE VALUE



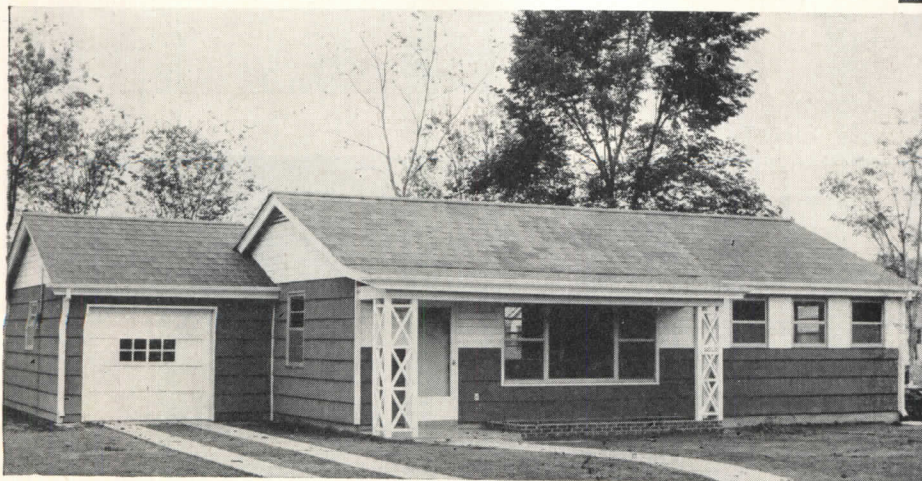
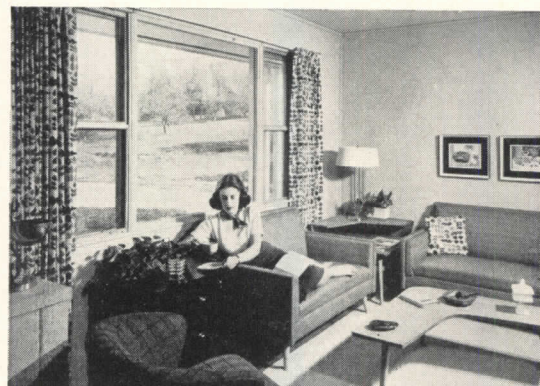
### EDGEWATER TOWERS, LAKEWOOD, OHIO

Rusco Prime Windows are used throughout this superbly-appointed, 11-story luxury apartment on the shores of Lake Erie. Apartment has 205 suites, with 1668 windows. ARCHITECT AND BUILDER: THE BYRNE ORGANIZATION, WASHINGTON, D. C.



### SPEED OF INSTALLATION AND OTHER COST SAVINGS

have resulted in choice of Rusco Prime Windows for P & H Prefabricated Homes, Port Washington, Wis. Exterior view above, interior view below.



### GARDEN PARK SUBDIVISION, GRETNA, LOUISIANA

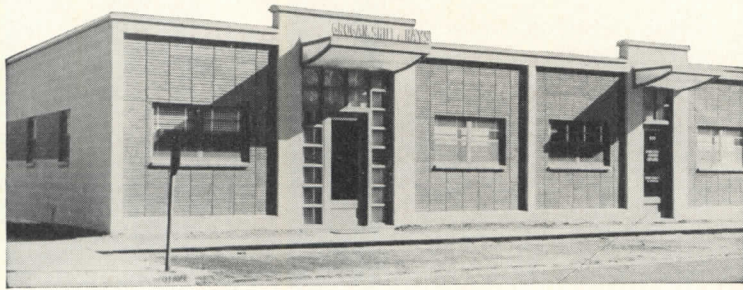
This project of 140 two and three bedroom homes in the \$10,000 to \$16,500 range is now featuring Rusco Prime Windows with their many superior advantages.

# They all report the same!

# RUSCO CUTS BUILDING COSTS

**THE NEAT,  
STREAMLINED  
APPEARANCE**

of Rusco Prime Windows harmonizes perfectly with the modern architecture of this business establishment in Amarillo, Texas.



## A Fully Pre-Assembled Window Unit

Factory-Painted, Hardware Attached—  
All Ready to Install in Window Opening!

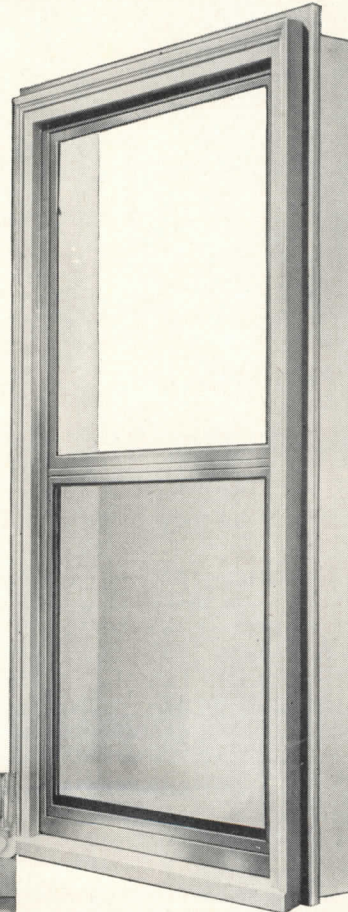
**GLASS • SCREEN**

**BUILT-IN WEATHERSTRIPPING**

**INSULATING SASH\***

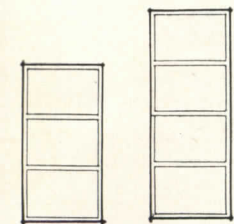
**WOOD OR METAL CASING**

**... OR STEEL FINIS**



\*OPTIONAL

Glass and Screen Inserts easily removed from inside for convenience in cleaning. The Rusco removable sash feature has tremendous appeal as a convenience and safety feature.



Also available in 3-light and 4-light styles for commercial and industrial construction.

Completely Installed  
in as little as  
**5 minutes!**



**1.** Rusco Prime Window, with glass and screen panels removed, is taken from stockpile . . .



**2.** . . . placed in stud opening and plumbed . . .



**3.** . . . nailed to studs . . .



**4.** . . . glass and screen panels slipped into slides . . .



**5.** . . . and in less than 5 minutes the fully-installed window is ready for service!

# RUSCO

Galvanized Steel

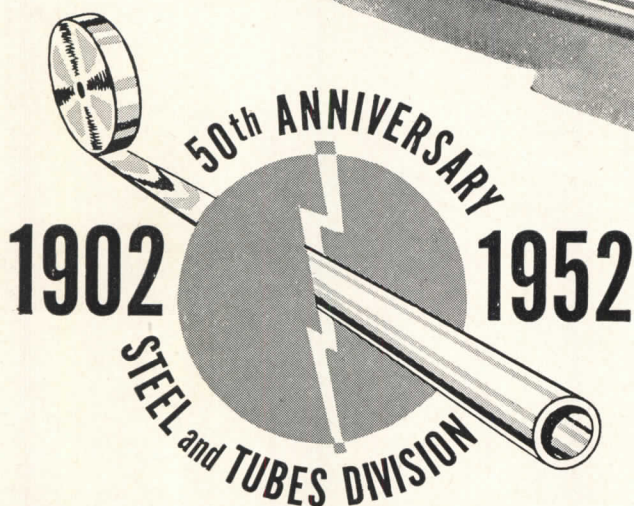
# PRIME WINDOW

VERTICAL SLIDE

**THE F. C. RUSSELL CO.**

DEPARTMENT 7 AR-102, CLEVELAND 1, OHIO • IN CANADA: TORONTO 13, ONTARIO

# By golly!...We're 50!



## ELECTRUNITE TUBING

And you'd scarcely believe the improvements we've made in welded steel tubing since 1902.

Over 30 years ago, the famous ELECTRUNITE process of electric welding replaced the old-fashioned brazed and gas-welded methods. Today, every foot of length, every inch of circumference in an ELECTRUNITE tubular product is equally strong, equally resistant to corrosion, equally smooth and round.

We've improved techniques and added many products to the ELECTRUNITE line, too. At right you'll see examples of all the products we make at our big, modern plants in Cleveland and Elyria, Ohio, Brooklyn, New York, and Ferndale, Michigan.

ELECTRUNITE tubular steel products help many industries make things stronger . . . or lighter to move . . . or attractive longer . . . or safer . . . and at lower cost.

These first 50 years are only a start on new and wonderful developments in ELECTRUNITE Stainless and Carbon Tubing for mechanical and pressure applications, "Inch-Marked®" E.M.T. and Conduit for electrical installations.

### The ELECTRUNITE Line



"Inch-Marked" E.M.T. . . . Electrical Metallic Tubing . . . light, strong steel tubing raceway to protect electrical wires against fire, moisture, and impact.



Mechanical Carbon Steel Tubing . . . made in a wide range of grades, sizes, and wall thicknesses to make all types of products lighter, stronger.



"Dekoron-Coated" E.M.T. for complete, longer-lived protection of wires in highly corrosive atmospheres.



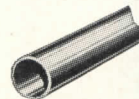
Stainless Steel Tubing and Pipe in a full range of sizes, types and wall thicknesses for chemical and food processing equipment, and mechanical applications.



Rigid Conduit . . . heavy-wall steel protection for wires in explosive and hazardous locations.



Heat Exchanger Tubes, both carbon and stainless steel, for all types of heat exchangers, condensers, process equipment, and heaters.



Boiler Tubes for large boilers or small, high pressures or low.

**REPUBLIC STEEL CORPORATION**  
STEEL AND TUBES DIVISION  
224 EAST 131st STREET • CLEVELAND 8, OHIO

*Republic*  
**ELECTRUNITE E.M.T.**



Another  
**FIRST**  
by  
**Crawford**

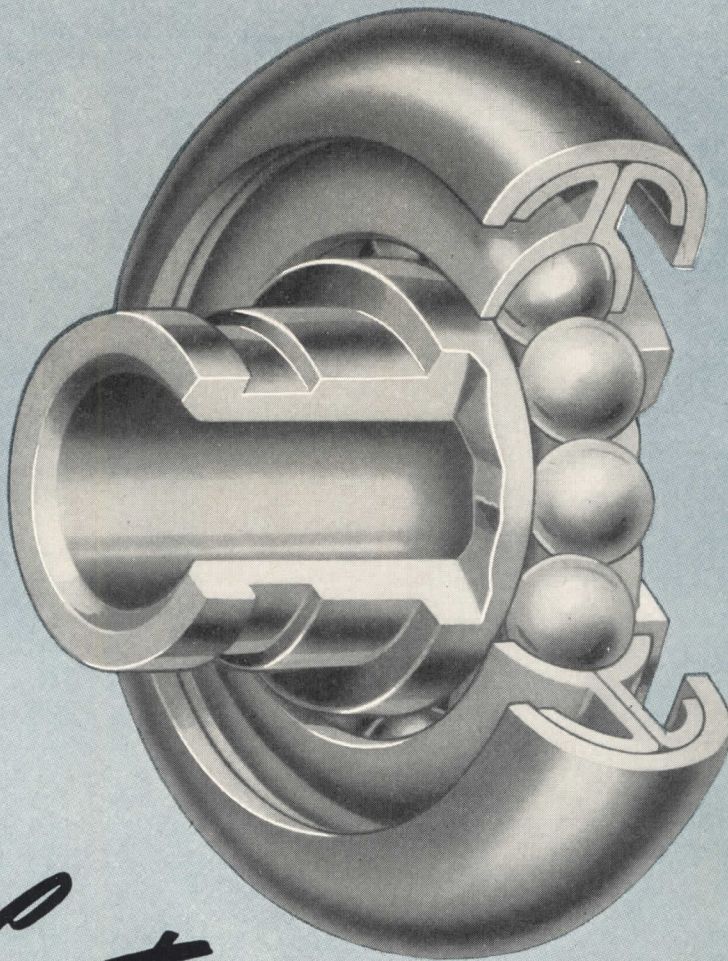
This  
**Zin-Cote**  
Plated Roller . . .

OUTWEARS ordinary rollers  
2 to 1.

NEVER needs oil—bearings  
are plated, too.

Collects NO dirt.

Withstands 50-Hour SALT  
SPRAY STEEL test.



**Zin-Cote**

PLATED HARDWARE

This roller typifies the quality that goes into every part of the Crawford Marvel-Lift Door.

The hard steel sleeve is half-an-inch wide, grooved to provide a raceway for ten quarter-inch, hardened, steel roller bearings.

The body is built up of two hard steel plates which enclose the roller bearings and form the outer raceway.

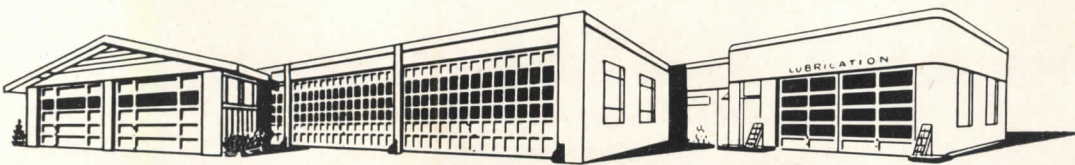
The steel tire is rolled on in one piece and never wears flat.

(Many ordinary rollers have *no* sleeve, *no* tire, and as few as *five* bearings.)

The entire assembly is made to fine limits of precision to prevent looseness and avoid running sound. The distribution of load over such large bearing surfaces spreads wear and prevents looseness. Zin-Cote Plating on *all* surfaces—sleeve, bearings, body, tire—further reduces wear. No other rollers are so well made or last so long.

Our entire product is made with equal care. You can specify Crawford Marvel-Lift Doors with complete confidence. Call your local Crawford Door Sales Company, listed in your local phone book under "DOORS." Crawford Door Company, 106-401 St. Jean, Detroit 14, Mich.

**Crawford MARVEL-LIFT Doors**



RESIDENTIAL

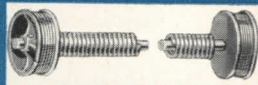
INDUSTRIAL

COMMERCIAL

Fabricating plants in 10 centers. Service warehouses in 79 major cities. Sales and service companies everywhere.

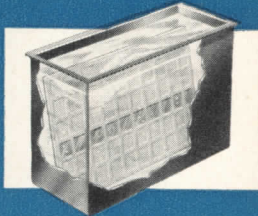
Fabricated and Distributed in Canada by

ROLL CALL  
OF  
**Crawford**  
SPECIAL  
FEATURES



**MARVEL-LIFT  
MECHANISM**

Standard equipment at  
no extra cost.



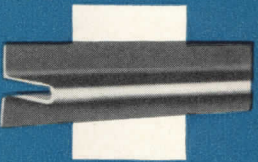
**MAGI-COTE  
WOOD SEAL DIP**

Only protective treat-  
ment in the industry  
Standard on Crawford  
Marvel-Lift Doors at  
no extra cost.



**ZIN-COTE PLATING**

On all hardware at-  
tached to the door—  
standard at no extra  
cost.



**NO-SAG TRUSSING**

To prevent vertical and  
horizontal distortion—  
standard on all larger  
doors at no extra cost.

**FEATHER-  
WEIGHT  
ALLOY  
REMOVABLE  
MULLIONS**

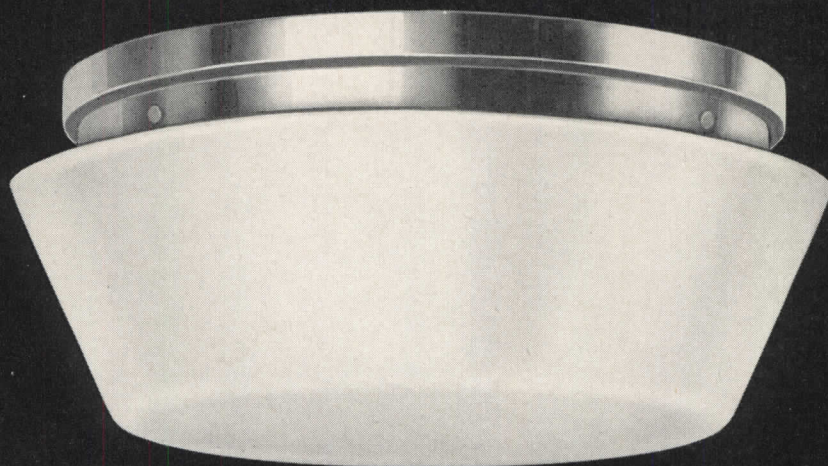


Between doors in bat-  
teries—only mullions  
that can be handled  
easily by one man.



**24-HOUR SERVICE**

Most anywhere in the



A new circular incandescent lighting form in close to the ceiling band units. Provides light to the ceiling with uniform surface brightness for visual efficiency.

Write  
for  
detailed  
release sheets  
on new  
products

**THE ART METAL COMPANY**  
CLEVELAND 3, OHIO

**Manufacturers of Engineered Incandescent Lighting**



# "Our Mills walls save time and money"

General Office, United Gas, Shreveport, Louisiana



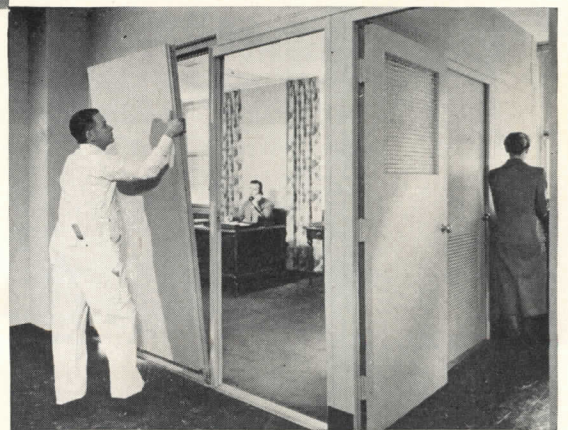
"We saved money every time we made a change in layout of our office space during the last 12 years", says D. B. Cook, building Maintenance Supervisor for United Gas, Shreveport, Louisiana, "because our Mills Movable Walls cost so little to rearrange to meet our changing requirements, as compared to the cost of conventional masonry type walls.

"Add to this the fact that offices could be rearranged over a week-end without disturbing normal operations of our personnel. Then too, we effected real savings in maintenance, for our Mills Walls are still fresh and modern looking, have required little attention or expense to preserve their attractive appearance. An occasional washing usually does the job. They have certainly saved us time and money."



Mobilize your space for efficiency—make your interiors flexible—save time and money—with Mills Movable Metal Walls. This 48 page book tells you how. Just ask for Catalog No. 50.

United Gas saved a great deal of *time* as well as *money* in using more than a mile of Mills Walls in its main office building. Mills Walls permit earlier occupancy of new offices because they are delivered completely pre-fabricated, can be installed in one-third to one-tenth the time required for tile and plaster walls.



*No lost time, no materials wasted, no dust or debris when Mills Walls are moved.*

**MILLS**

*Movable*

**METAL WALLS**



THE MILLS COMPANY, 955 WAYSIDE ROAD, CLEVELAND 10, OHIO

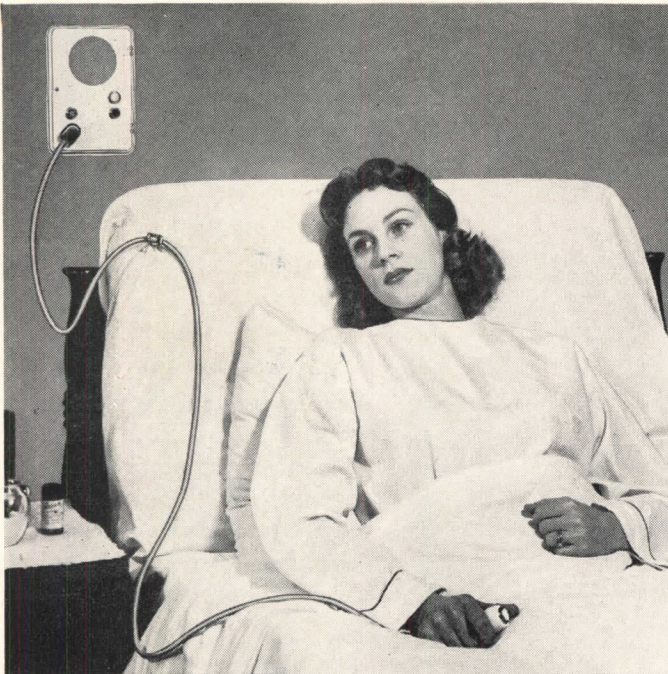
# AUTH'S "whisper-control" Nurses' Call System—

a brilliant new aid to

# HOSPITAL EFFICIENCY

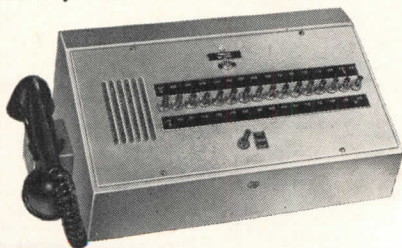
*"Like having a private nurse"  
says the patient!*

*"Like having one private patient"  
says the nurse!*



Yes, they're both happier — and with good reason. The patient has the psychological advantage of knowing that her smallest need will get immediate attention. She knows she will be heard when she wants to be heard even if she whispers, no matter in what direction she faces. So long as she can move her thumb and make a sound, she's sure of attention. Knowing this, she is less demanding, more relaxed.

And the Nurse? Well, she's actually been multiplied several times. Her energy and time are conserved, her spirits improved, her efficiency immeasurably increased. And so is the efficiency of the whole hospital. For that's the wonder of the new AUTH Vokalcall. It's the finest single aid to hospital efficiency that was ever devised.



Nurses' control available in two styles: With speaker-microphone and telephone handset for auxiliary use . . . or with telephone handset only.

In addition to Vokalcall Systems for hospitals Auth also produces standard visual nurses' call systems, doctors' paging and in-and-out systems, clock systems and operating room timers, intercom telephone and fire alarm systems, and night lights.

**More information?** Write for complete descriptive literature to Auth Electric Company, Inc., 34-20 — 45th Street, Long Island City 1, New York.



**FOREMOST IN THE DESIGN AND MANUFACTURE OF ELECTRICAL  
SIGNALING, COMMUNICATION AND PROTECTIVE EQUIPMENT**

## For Roof Systems . . . Floor Joists

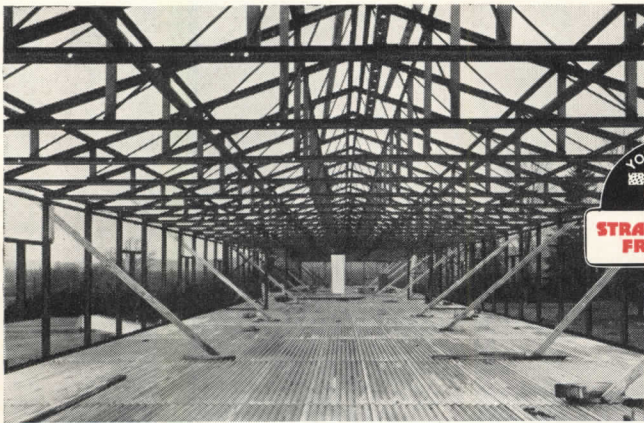
*Specify*

# Stran-Steel® Framing

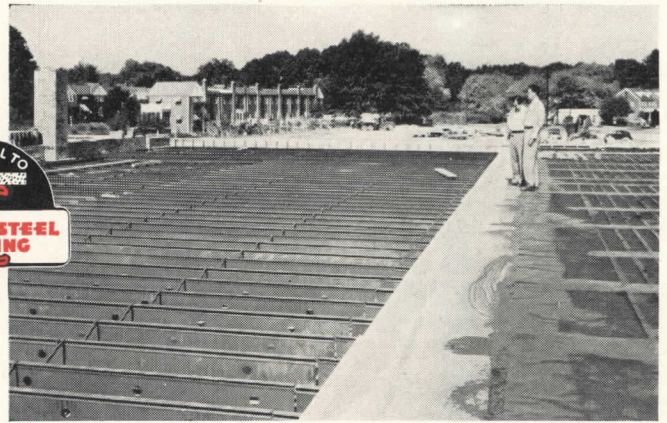
Stran-Steel framing members bring twofold savings when specified for commercial and industrial construction. There's the initial saving of time and money during construction—and the permanent saving over fire hazards. With Stran-Steel roof systems and floor joists, the destructive effects of fire can be reduced to a minimum.

Stran-Steel framing is easily adapted to modern design, has great rigidity, and is precision pre-cut for rapid assembly. The nailable feature of Stran-Steel framing allows a wide choice of collateral materials and speeds building close-in. Interior work can proceed before exterior completion, thus saving delay in sub-trade work.

Write for complete literature and specifications data on Stran-Steel framing; or see Sweet's Architectural or Builders' files.



Non-combustible Stran-Steel framing members were used for exterior walls, interior partitions, roof trusses, and floor joists in New York State Conservation Department building at Sherburne, N. Y.



Virginia Square Shopping Center in Arlington County, Va., uses Stran-Steel joists on the first and second floors and roof. Roof construction includes poured Pyrogyp deck plus built-up roofing.



FREE—Write us today for your file-size copy of our 138-page Architects' Reference Manual. Fully illustrated. Complete engineering tables.

**GREAT LAKES STEEL CORPORATION**

Stran-Steel Division

Ecorse, Detroit 29, Mich.

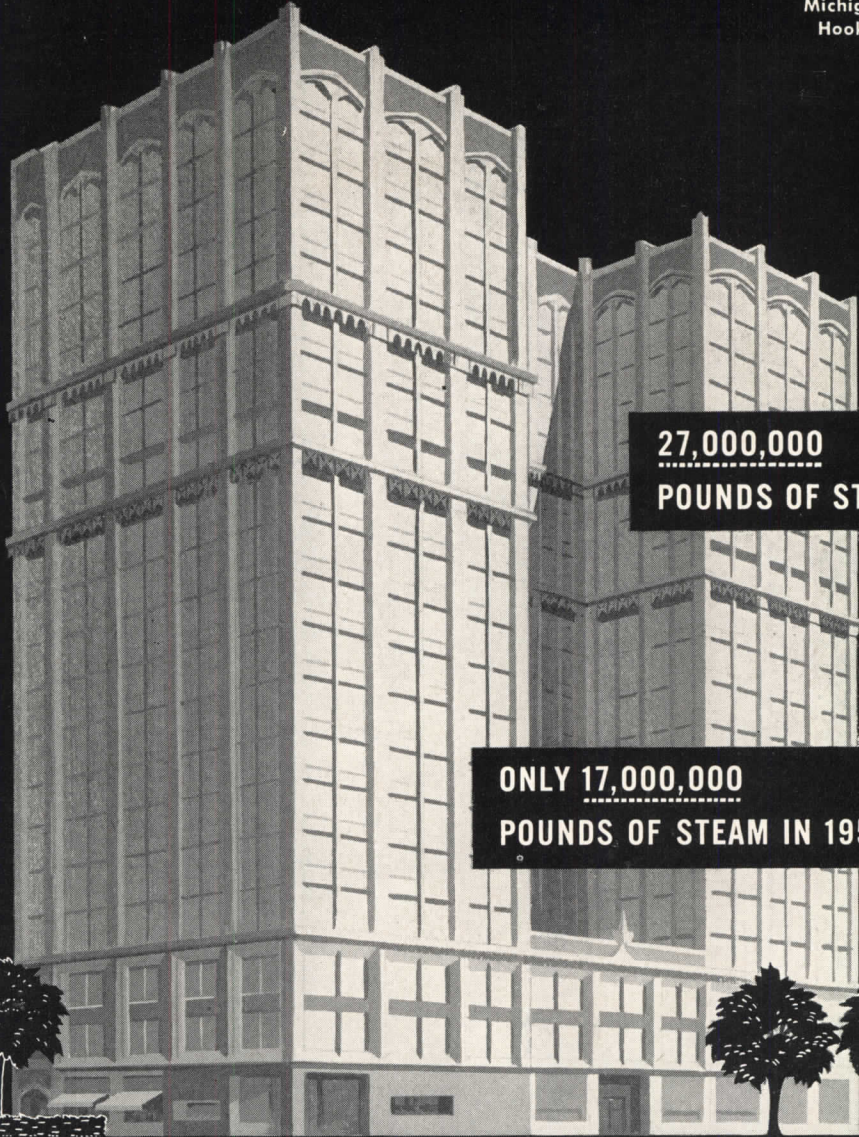
**NATIONAL STEEL CORPORATION**



**CORPORATION**



Michigan Boulevard Building  
Hooker & Randell, Agents



27,000,000  
POUNDS OF STEAM IN 1948

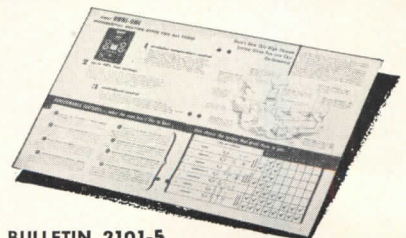
ONLY 17,000,000  
POUNDS OF STEAM IN 1951

## The Difference (10,000,000 lbs.) Is Dunham Vari-Vac Heating

Yes, Dunham Heating makes a difference. In the Michigan Boulevard Building, Chicago—a medical building where temperatures must be precisely controlled, this Dunham difference amounted to—*10,000,000 pounds of steam saved*, during an unusually severe winter.

Substantial fuel savings are brought about regularly for all types of buildings, through Dunham's patented controls operating on high vacuum steam lines.

Dunham Heating can bring you *greater comfort... far greater operating economy*. Full cost-cutting facts are at your disposal... as are Dunham Sales Engineers, located in most principal cities. Why not call or write for a free heating survey?



### BULLETIN 2101-5

... tells you how Dunham Vari-Vac Differential Heating works, how it can be applied to your building to increase comfort, decrease operating costs. Write for your free copy to C. A. Dunham Company, 400 West Madison Street, Chicago 6, Illinois.

# DUNHAM

## VARI-VAC HEATING

C. A. DUNHAM COMPANY • HEATING SYSTEMS AND EQUIPMENT • CHICAGO • TORONTO • LONDON

**FOR SAFE, DEPENDABLE  
POWER and LIGHT CONTROL  
for All types of Buildings**

Specify



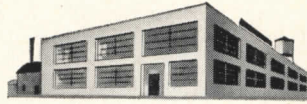
RESIDENTIAL



COMMERCIAL



INDUSTRIAL



HOSPITALS  
AND INSTITUTIONS

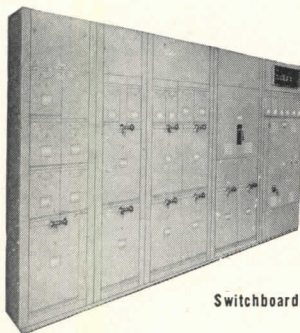


YOU'RE SURE of getting the maximum in Quality when you specify FA Electrical Products for all types of buildings you design — whether small homes or large industrial, commercial or institutional structures.

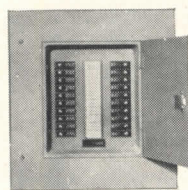
FA has specialized in the field of power and light distribution for more than 60 years, during the course of which it has built an enviable reputation for quality workmanship and materials — products

that are safe, dependable, efficient, economical, long-lasting and trouble-free.

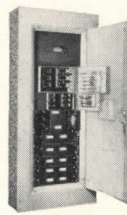
The next time you have a job that involves power and light distribution and control — whether it is a small load center or service equipment, or even a heater for a home, or a switchboard, panelboard or busduct for a major industrial or institutional installation — specify FA. You'll find that it pays handsome service dividends.



Switchboard



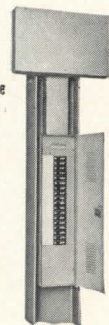
Quicklag  
Panelboard



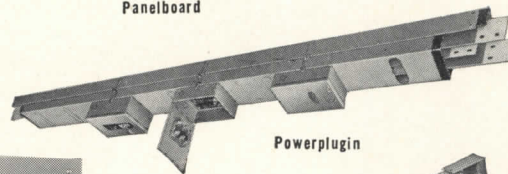
Feeder  
Panelboard



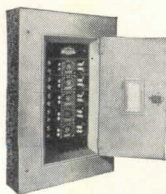
Main and  
Range Unit



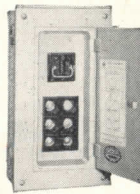
Column Type  
Panelboard



Powerplug



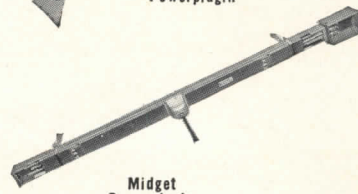
LNT  
Panelboard



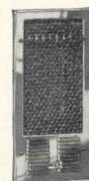
Fuse Type  
Service Equipment



QP Quicklag P  
Load Center



Midget  
Powerplug



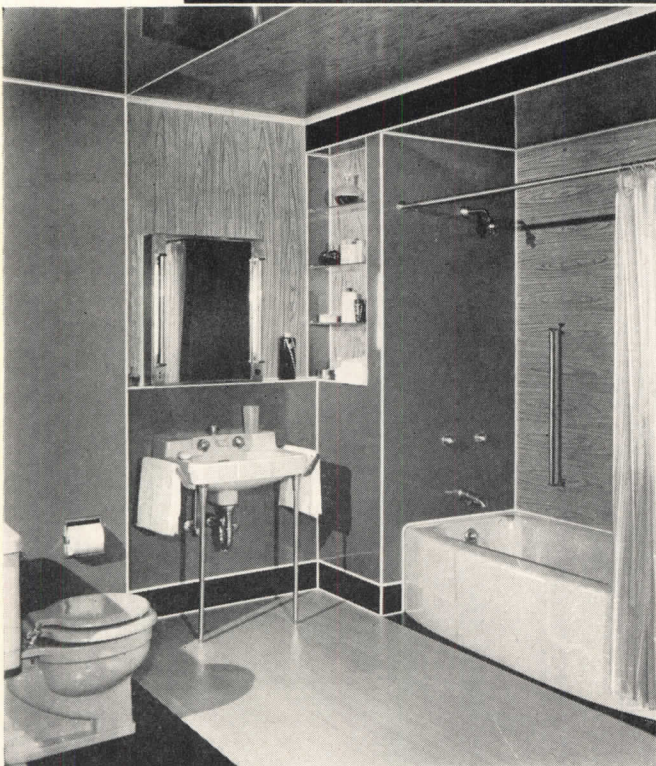
Quikheter

*Frank Adam Electric Co.*

P. O. BOX 357 ST. LOUIS 3, MISSOURI

Makers of BUSDUCT • PANELBOARDS • SWITCHBOARDS • SERVICE  
EQUIPMENT • SAFETY SWITCHES • LOAD CENTERS • QUIKHETER





BATHROOM DESIGN BY EUGENE VOITA, A.I.A.

## Beautiful Marlite Hi-Gloss and Woodpanel mean more client satisfaction

Now you can offer your clients low-cost maintenance, striking beauty, and long range permanence with these two great Marlite plastic-finished panels.

**MARLITE WOODPANEL**, in authentic reproductions of fine, fully-finished wood grains, makes possible beautiful, economical interiors in dens, recreation rooms, libraries, living room, offices, corridors, waiting rooms, bars, lounges, etc.

**MARLITE HI-GLOSS**, a new low-cost panel in Plain, Horizontal, and Tile Patterns, is ideal for maintenance-free bathrooms, kitchens, utility rooms, laboratories, rest rooms, operating rooms, etc. And every Marlite panel features the exclusive high-heat-baked finish which resists moisture, grease, acids, heats, alkalis, and stains.

**SPECIFY GENUINE MARLITE** — your clients' guarantee of satisfaction. Choose from 67 striking color and pattern combinations for creating beautiful residential, commercial, industrial, and institutional interiors.

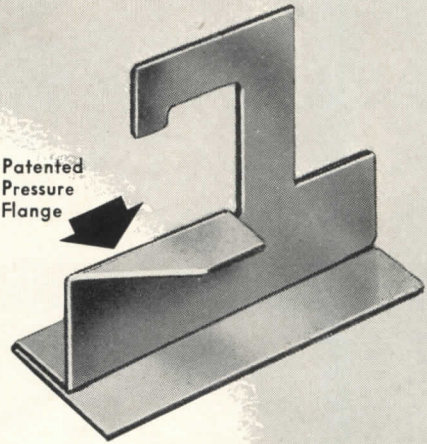
A continuous national advertising campaign is pre-selling your clients on Marlite's many benefits. MARSH WALL PRODUCTS, INC., Dept. 1005, Dover, Ohio, Subsidiary of Masonite Corporation.

**Write for new literature.** Full color catalog and Hi-Gloss and Woodpanel folder are now ready.



*Mr. Architect:*  
**This IS important  
 for Good mechanical  
 application of  
 acoustical units . . .**

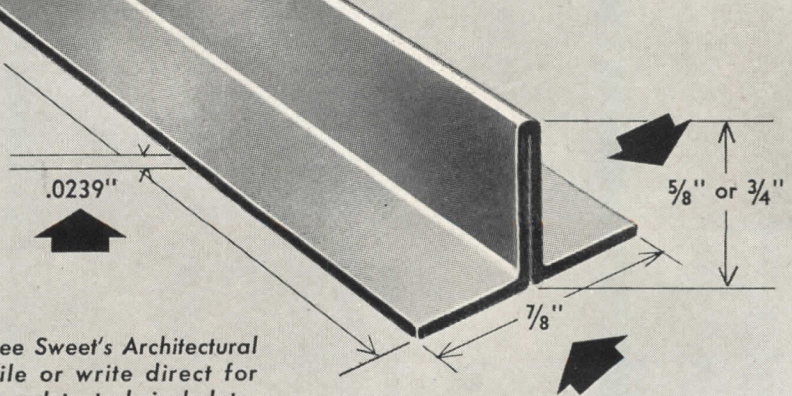
Patented  
 Pressure  
 Flange



Clips properly manu-  
 factured of rust resistant  
 steel with pressure  
 flange for rigidity to  
 prevent up and  
 down movement

Tee-bars  
 properly manu-  
 factured of  
 rust resistant steel  
 with  
 dimensions as shown

*Quality Costs No More.*



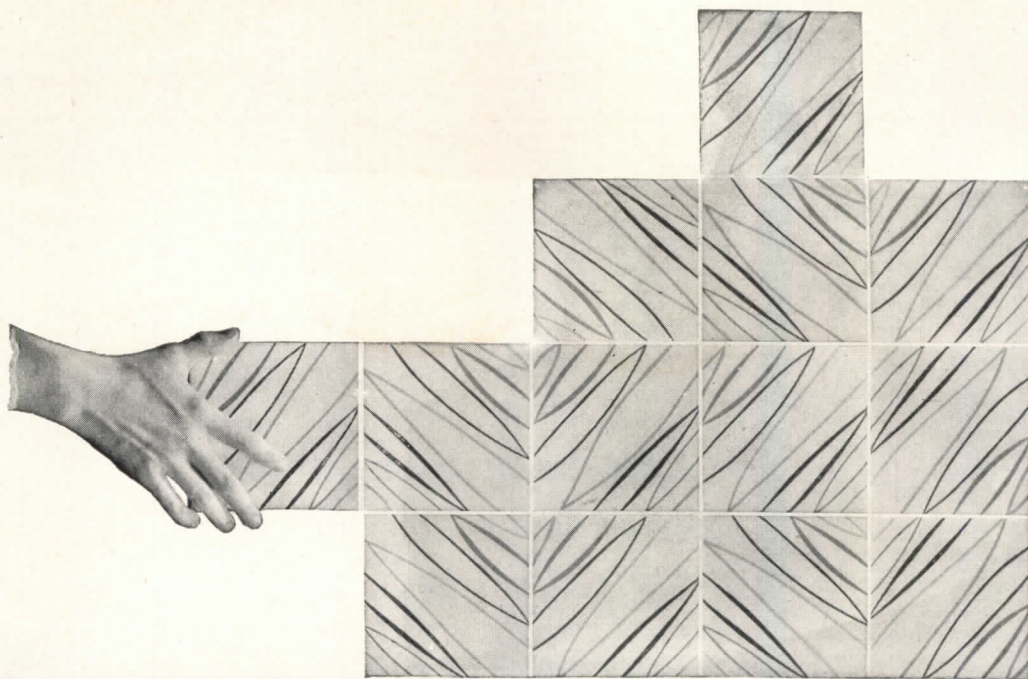
See Sweet's Architectural  
 File or write direct for  
 complete technical data.



W. J. **HAERTEL** & CO.

832 West Eastman Street • Chicago 22, Illinois

West Coast Distributor **FREY & HAERTEL, Inc.**, 125 Barneveld Ave., San Francisco 24, Calif.

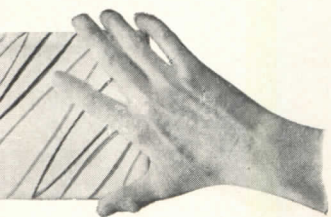


*unlimited  
decorative  
opportunities  
at your  
fingertips!...*

Mosaic Formfree Decorated glazed wall tile is easy to install. The tiles "tumble" into place at random, forming their own provocative pattern. No set plan for the tile setter is needed.

Study the illustration at the top of the page. Note how the pattern unfolds to form an ever-changing, ever-interesting design as installation progresses.





# Mosaic's Formfree Decorated Wall Tile



Floor-to-ceiling fireplace of Mosaic Formfree Decorated Wall Tile highlights this Eastern home. Julius Gregory, Architect; Robert Chuckerow, Builder; R. L. Leonardi, Inc., Tile Contractor. The floor is finished in time- and grime-defying Granitex® Mosaic Pattern No. 1779-A3.

With Mosaic Formfree Decorated Wall Tile, the architect has no design limitations. Here is design freedom in inspiring latitude . . . ceramic tile that's equally successful for decorative panels and large continuous vertical surfaces.

Recommend Mosaic Tile without hesitation or reservation for any area where beauty, durability and resistance to moisture, stain, abrasion, fading and fire are prime essentials.

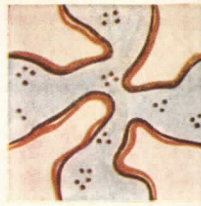
Once Mosaic Tile is installed, the cost of maintenance takes an immediate nose-dive, while repair, redecoration and replacement expense is stopped permanently.

For quick facts about Mosaic Formfree Decorated Wall Tile, and other Mosaic Tile, visit your nearest Mosaic Office, your Tile Contractor, or write Dept. 30-11, The Mosaic Tile Company, Zanesville, Ohio.

For Free Estimates on MOSAIC Tile, see your phone book for the name of Your Tile Contractor (Ceramic)



**FREE!** Write today for your copy of Mosaic's new Formfree Decorated Wall Tile Book.



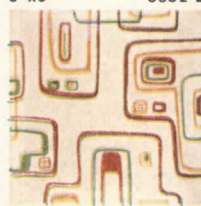
6"x6" 6050-A



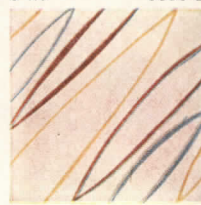
6"x6" 6051-A



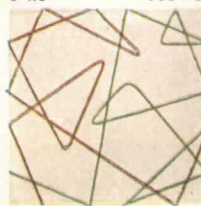
6"x6" 6052-B



6"x6" 6053-B



6"x6" 6054-B



6"x6" 6055-A



## THE MOSAIC TILE COMPANY

(Member—Tile Council of America)

Offices, Showrooms and Warehouses across the nation.

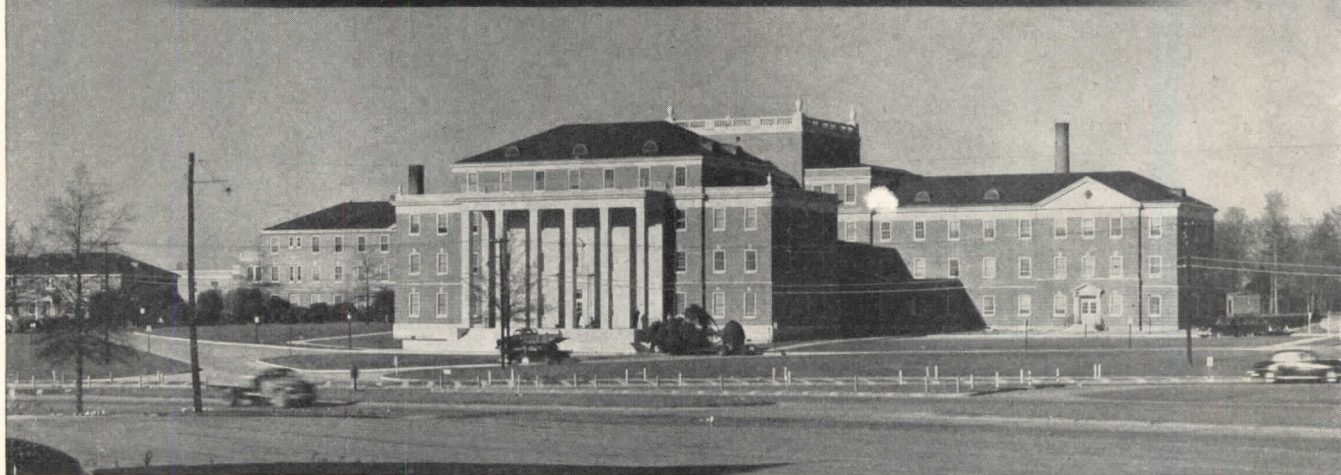
OVER 4000 TILE CONTRACTORS TO SERVE YOU

Sales Offices:

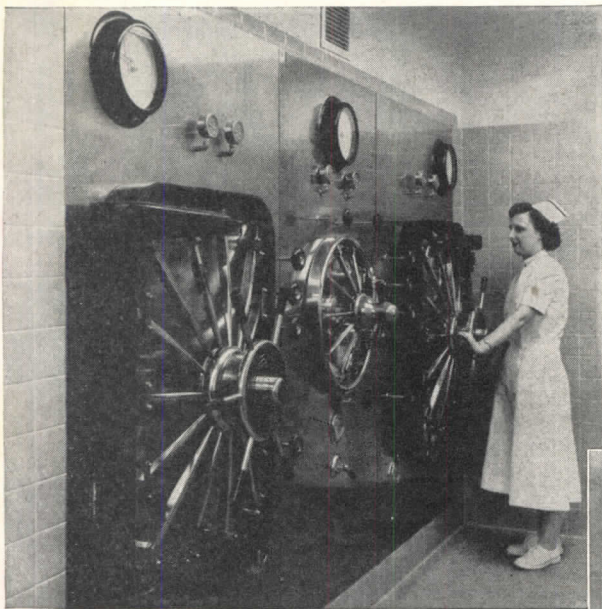
- Atlanta • Boston • Chicago • Denver • Detroit • Hollywood • Little Rock • Miami • New York • Philadelphia • Portland • Salt Lake City • San Francisco • Seattle • Washington, D. C.

# FULLY *Castle* EQUIPPED

... on the basis of engineering know-how



There are varying physical characteristics in every hospital which pose individual and often difficult installation problems. Only wide and sound engineering experience can provide that degree of equipment efficiency necessary to insure lasting satisfaction.



**A *Gratis* Service** — our experienced Planning Department is available to assist the hospital, the architect and hospital consultant in any project involving sterilization and surgical lighting. . . . WRITE TODAY.

In close collaboration with J. N. Pease & Co., architects, every facility for safe sterilization and surgical lighting in the new Cabarrus County Hospital, Concord, N. C., is Castle designed and made.

- ▶ **In Patient Safety** — innovations and improvements are constantly being developed by our technical staff to provide even greater measures of safety for the patient and protection for the operating personnel.
- ▶ **In Time-Saving Efficiency** — the simplicity and dependability which characterize Castle equipment contribute towards marked economy in time, labor and money.
- ▶ **In Long Service** — engineering know-how, careful selection of basic materials, advanced production methods, skilled workmanship — all are factors which have established Castle equipment as standard for quality and performance.



**WILMOT CASTLE COMPANY**  
1258 University Ave.      Rochester 7, N.Y.

*Castle* **STERILIZERS AND LIGHTS**

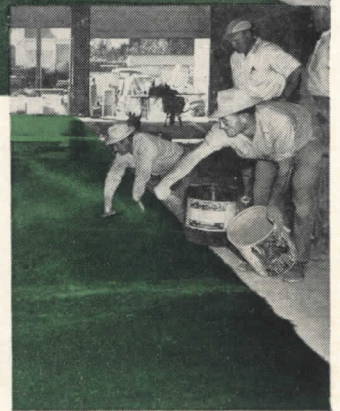


**COLORUNDUM**

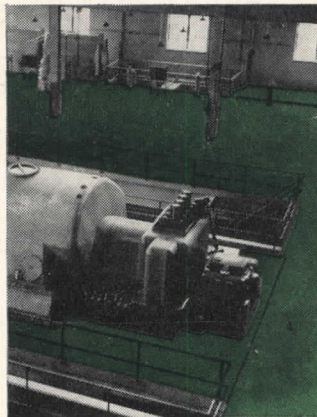
for colored concrete floors  
and sidewalks use **COLORUNDUM**

All over the nation modern building design now includes the use of Colorundum in colored concrete floors, sidewalks, roof decks, industrial and other walkways and driveways. Colorundum is used widely in exteriors or interiors . . . as a wear-resistant and colorful concrete topping of long life . . . at practically the average cost of ordinary concrete. Decorative color combinations are often employed of red, maroon, brown, green, dark green, french grey, black. Colorundum is a dry powder ready for use, composed of coloring mediums, fused aggregates, water-repellent and hardening elements. Colorundum is dusted on and floated and trowelled into the fresh concrete topping. The non-slip, non-metallic surface makes it an ideal flooring on new concrete or when replacing old concrete floors or sidewalks.

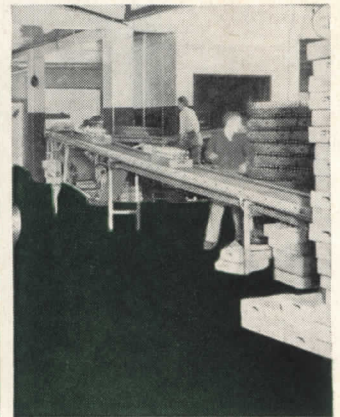
trowelled into the fresh  
concrete topping



Colorundum central fire station floor



Colorundum power plant floor



Colorundum industrial floor

**HORN**

**A. C. HORN COMPANY, Inc.** est. 1897

Manufacturers of materials for building maintenance and construction  
LONG ISLAND CITY 1, N. Y. • Los Angeles • San Francisco • Houston  
Chicago • Toronto **SUBSIDIARY OF SUN CHEMICAL CORP.**

A. C. HORN COMPANY, INC.,  
Long Island City 1, N. Y.

Please send me  complete data on  
COLORUNDUM



free copy of your  
96-page Construction  
Data Handbook



AR-2

NAME \_\_\_\_\_ TITLE \_\_\_\_\_

FIRM NAME \_\_\_\_\_

ADDRESS \_\_\_\_\_

CITY \_\_\_\_\_ STATE \_\_\_\_\_

**WHEN WINTER COMES**

**...have the**



*In construction products* **CECO ENGINEERING**

*makes the big difference*

# answers on condensation

In a few short weeks "that man" will be here again . . .

**"Old Man Winter" . . .**

And with him will come all the problems of condensation in the home.

But you can have the answers to what causes it and more important

what to do about it . . . answers that will be eagerly sought by your customers.

Ceco Steel Products Corporation offers you a comprehensive booklet

on condensation. Use the handy coupon to order your free copy.

You'll discover how steel and aluminum windows can control condensation.

You'll get ideas on how home owners

can free their homes of excessive moisture build-up . . .

you'll want extra copies of Ceco's book to give your clients . . .

they'll be ever so grateful

for this helpful service from you.

## **CECO STEEL PRODUCTS CORPORATION**

General Offices: 5601 West 26th St., Chicago 50, Illinois. Offices, warehouses and fabricating plants in principal cities.

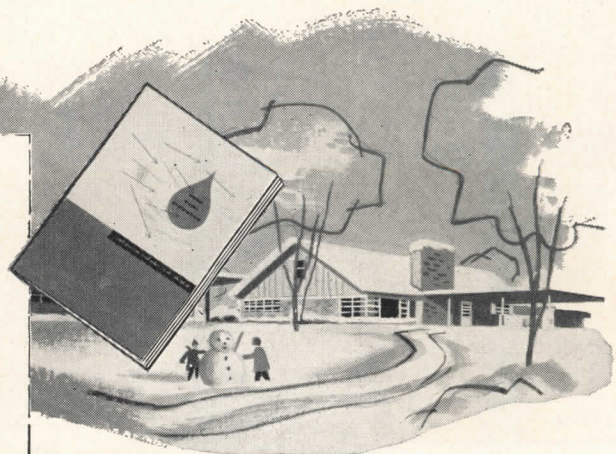
**CECO** Ceco Steel Products Corporation  
5601 West 26th Street . . . Chicago 50, Illinois

Rush me free copy of the booklet . . . "Water, Water,  
Everywhere . . . Condensation and what to do about it."

Name \_\_\_\_\_

City \_\_\_\_\_

State \_\_\_\_\_



**Don't delay . . . clip this coupon today**

★

★

**On land or sea . . . hospitality at their feet**

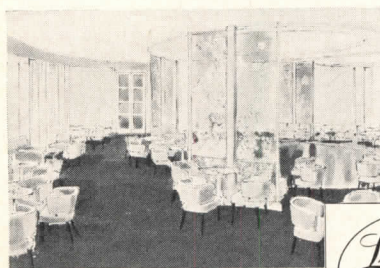
*with those heavenly carpets by* **LEES**

Wherever you live, wherever you travel, life is richer, easier, better on a Lees!

Newport News Shipbuilding & Dry Dock Company, the builders, and The United States Lines, the owners, have selected Lees Carpets *exclusively* to add that final touch of quality and elegance to their great new super-liner, the S.S. United States.

As on United Airlines, Pennsylvania's ultra-modern luxury trains—The Congressional and The Senator, in New York's fabulous new Lever House, hundreds of famous hotels and apartment houses from coast to coast and fine homes everywhere—Lees Carpets are serving every purpose perfectly!

Send for information from James Lees and Sons Company, Contract Carpet Division, Bridgeport, Penna., or offices in principal cities.

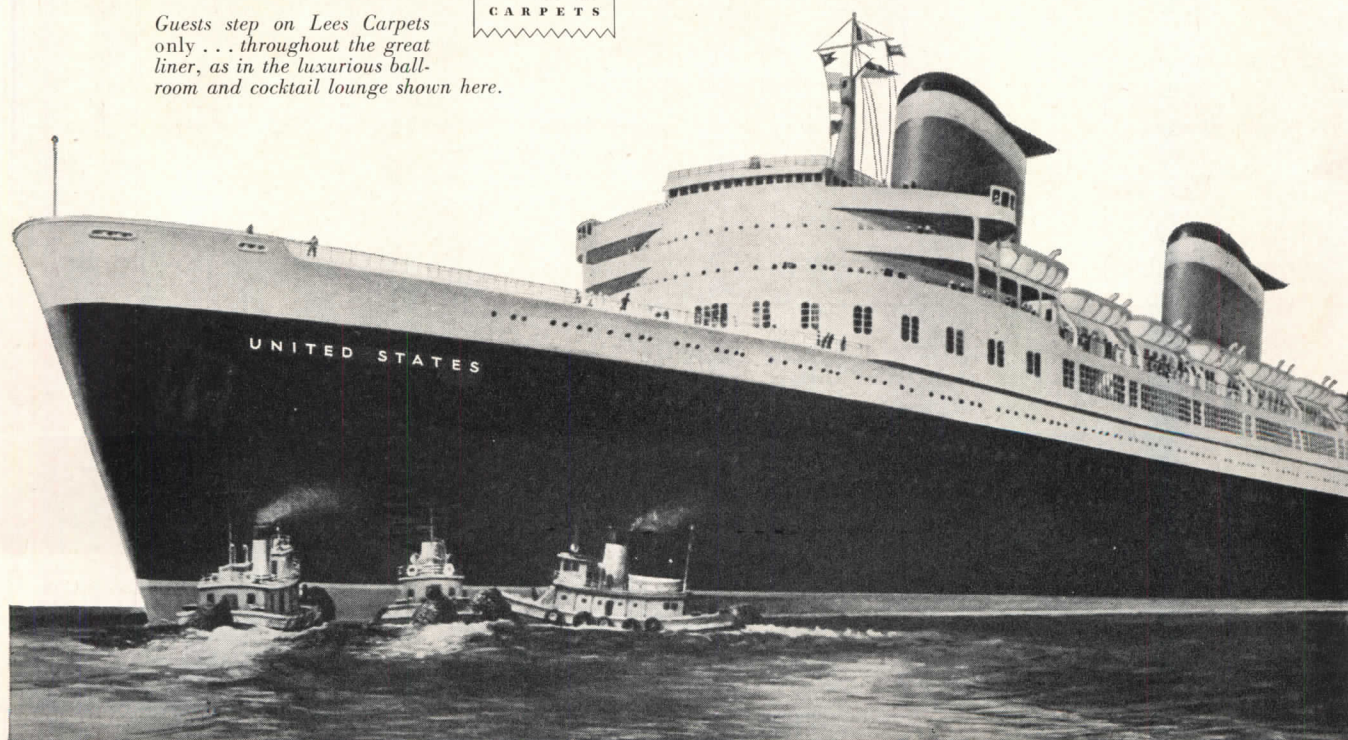


*Guests step on Lees Carpets only . . . throughout the great liner, as in the luxurious ballroom and cocktail lounge shown here.*



JAMES LEES AND SONS COMPANY • BRIDGEPORT, PA.

MAKERS OF LEES CARPETS AND RUGS



**FREE! to hospital  
architects, engineers,  
managers**



**New authoritative guide  
to hospital ventilation**

• Successful solutions to practically any air moving problem in a hospital are pictured and described in this new ILG "Guide." Almost 50 years of experience in helping engineer efficient ventilating systems for hospitals throughout the world are condensed and made available to you in this authoritative booklet. Included are ventilating layouts for all departments in old and new, large and small hospitals. The "Guide" is not designed for general distribution—but specifically for architects, engineers, and executives interested in hospital building and maintenance. If you have this interest, we shall be glad to send you a copy without charge or obligation. Just mail coupon or phone our nearby Branch Office (consult classified directory).



# VENTILATION

ILG ELECTRIC VENTILATING CO.  
2818 N. Crawford Ave., Chicago 41, Illinois  
Offices in more than 50 Principal Cities

*Free!*—new authoritative guide to modern practices in hospital ventilation. Get your copy now.

Send FREE copy new ILG "Guide"

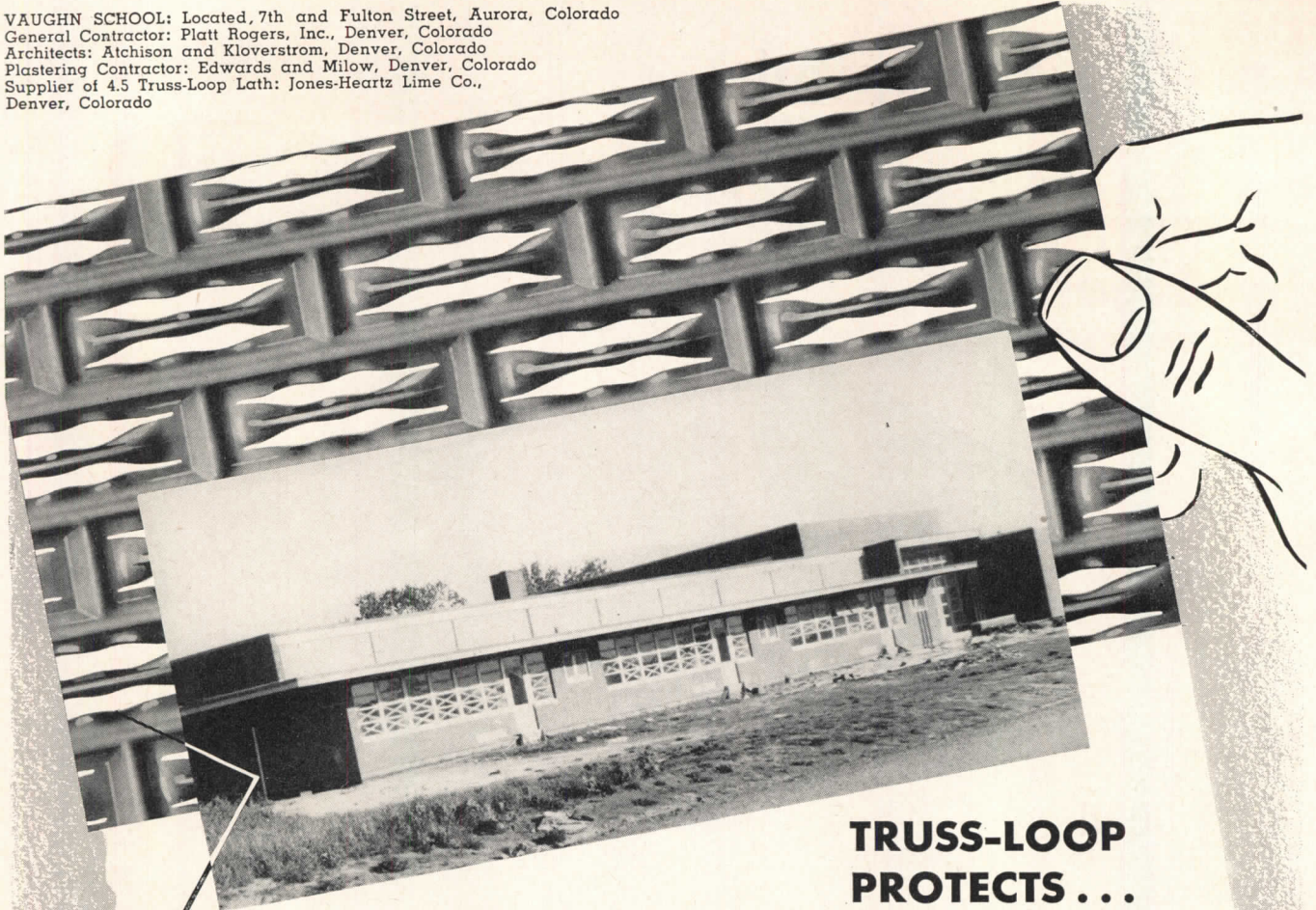


Name \_\_\_\_\_

Address \_\_\_\_\_

City \_\_\_\_\_ State \_\_\_\_\_

VAUGHN SCHOOL: Located, 7th and Fulton Street, Aurora, Colorado  
General Contractor: Platt Rogers, Inc., Denver, Colorado  
Architects: Atchison and Kloverstrom, Denver, Colorado  
Plastering Contractor: Edwards and Milow, Denver, Colorado  
Supplier of 4.5 Truss-Loop Lath: Jones-Heartz Lime Co., Denver, Colorado



## TRUSS-LOOP PROTECTS . . .

*Saves time, materials—*

Architects Atchison and Kloverstrom, Denver, Colorado, included Truss-Loop Metal Lath in their architectural designs of the two new Aurora, Colorado, schools. Bostwick's Truss-Loop Metal Lath stands as a highly rated fire barrier that protects lives and property. Rigid, ribbed construction, greater metal surface and triple-bond plaster key combine strength with firmness that withstands impact and assures maximum fire protection.

Here are some advantages of Truss-Loop Metal Lath which may interest you. Ribbed construction

means extra savings: Savings in material—Truss-Loop Lath adds self-supporting strength to the wall structures, permitting wider center placement of studs and joists. Placing loops inward allows space for the plaster key oversupports and often saves furring strips. Truss-Loop's triple-bond key firmly grips mortar, preventing waste of plaster. Savings in time—Truss-Loop's flat, rigid surface steps up troweling speed.

Specify Bostwick Truss-Loop Metal Lath. Write today for complete specifications of Truss-Loop and other Bostwick products.

**HE**

**Bostwick**

105 HEATON AVE. • NILES, OHIO

**S E E L L A T H C O M P A N Y**



Peerless  
public servant  
of millions

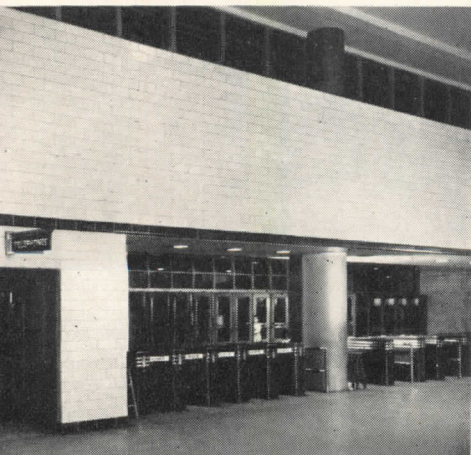
## STARK GLAZED FACING TILE

for  
heavy-duty  
interiors  
of  
lasting beauty

### SERVING 30 MILLION COMMUTERS A YEAR

Walls of Stark Glazed Facing Tile assure low-cost maintenance and a cheerful, clean environment in New York's new Staten Island Ferry Terminal.

Madigan-Hyland, Architects and Engineers.  
Caldwell-Wingate Co., General Contractors.



In buildings designed to serve the public, versatile Stark Glazed Facing Tile offers unique advantages.

**Stark Glazed Facing Tile** withstands the abuse of steady public usage—in transportation terminals like the one shown here, in schools, hospitals, civic centers and commercial buildings. Its glass-hard surface will not mar, stain or fade. Maintenance costs are cut to a minimum—walls by Stark wash clean as a dish, never need redecorating.

**Stark Glazed Facing Tile** eliminates construction materials, gives you a load-bearing wall and a quality finish in a single time-

saving step. Made in modular dimensions, it reduces cutting and pares high on-the-job labor costs.

**Stark Glazed Facing Tile** permits you to build good looks as well as rugged durability into public areas. Stark's range of colors will meet your most exacting requirements for good light-reflection, visual benefits, and a cheerful environment.

We welcome your inquiries. If you wish a copy of our new brochure on Modular Masonry, or other information, just write us on your own letterhead. Address your request to Dept. AR-10. See Sweet's Catalog 4f-St.



## STARK CERAMICS, INC.

(formerly the Stark Brick Co.)

14305 Livernois Ave.  
Detroit 4, Michigan

Canton 1, Ohio

15 East 26th Street  
New York 10, N. Y.

# Why did 47 people rush out to



In his first project, Mr. Smithson sold Mrs. J. W. McLeane a house with



"I'm so glad this G-E Dish-washer was included in the original cost of the house, Mr. Smithson. I probably would have felt that I could not afford it at the time!



"Getting a G-E Disposall® that automatically flushes away garbage certainly appealed to me when we bought the house! I'd never want to be without it from now on!



"Of all the refrigerator brands you could have picked, the G-E is my favorite! It's so good-looking, so quiet, and never has given me a minute's trouble from the time we moved in!



"It's so nice to have these frozen foods right on hand . . . not to wait in line at the grocer's every other day! This G-E Freezer is such a convenience and a money-saver, too!

say . . .

"I'll take it!"

**T**HIS photograph was snapped one Sunday afternoon in April of this year in R. O. Smithson Jr.'s new Conant Village development in Beverly, Massachusetts.

The people in these cars were not just snooping. They came out to look at houses and to buy houses. Within the next few days, a total of 47 people said, "I'll take it!"

**What makes this success story even more interesting is the fact that new houses near by—which had been on the market for several months—were NOT selling!**

Why did everybody prefer Mr. Smithson's houses?

Let Mr. Smithson tell you. His experience may help you to sell houses faster, too.

"Anybody with two eyes in his head," says Mr. Smithson, "can see that the place a woman starts for almost as soon as she sets foot into a house is the kitchen.

"Our prospects are delighted not only to see the fine array of General Electric Appliances in our \$14,500 home, but to know that the monthly outlay for them is no more than a typical telephone bill!

"You see, the cost of these G-E Appliances is figured over a long-term mortgage, and the actual cost to the homeowner is less than \$5.00 a month, a sum they can easily afford!"

*calls back, too!*

"Furthermore," says Mr. Smithson, "I've been calling back on the people who bought my houses to find out whether they are *completely* happy with their new G-E All-Electric Kitchens.

"These call-backs convince me, more than ever, that not only is it good business to include G-E Appliances in my new homes, but for the long-range outlook it's *one of the smartest things a builder can do today!*

"I wouldn't think of putting up houses today without a G-E Kitchen."

*a suggestion for you*

We would like to work hand-in-hand with you to achieve similar results for you in *your* area. We can help you *pre-sell* your houses just as we have for so many other builders throughout the United States.

Get complete facts about the G-E Kitchen-Laundry through your local G-E distributor, or write to the Home Bureau, General Electric Company, Louisville 2, Kentucky.

## GENERAL ELECTRIC

**a G-E Kitchen. Here you see him calling back to get her reactions.**



"So easy just to sit here and watch this G-E Rotary Ironer do the clothes in a fraction of the time it used to take. Most all my friends want G-E Appliances, too!"



"This G-E Range is so much cooler than the old stove I had to pamper! So easy to use, and so easy to keep clean, too. You couldn't have picked a better range, Mr. Smithson!"



"It was nice to know when we signed up for the house that we wouldn't have to spend a lot of money for an automatic washer or other necessary labor-saving appliances!"



Mr. Smithson knows that when he sees a G-E emblem on a water heater, refrigerator, or any other appliance, he can rest assured that it's *reliable*. G.E. is famous for its dependability.

*The Name*

# HOPE'S

*Guarantees*

## CHURCH WINDOWS



*Church of St. Thomas the Apostle, East Norwalk, Conn.*

*Edward F. Allodi, William J. Boegel Associates, Architects*

*Wm. J. Lyons Construction Co. Inc., Builders*

Hope's Steel Windows with "Biltin" Sub-Frames solve many problems in both design and detail in church fenestration. They offer the most satisfactory provision for the use of leaded art glass, with or without protective exterior glazing. Their layout variety provides the widest choice in sizes and

design of panes and glass areas, and the most convenience in arrangement of ventilators. Their trustworthy quality assures freedom from operation and maintenance difficulty for many, many years. Each of Hope's offices offers engineering services in connection with church windows. Write for booklet 128A.

### HOPE'S WINDOWS, INC., Jamestown, N. Y.

THE FINEST BUILDINGS THROUGHOUT THE WORLD ARE FITTED WITH HOPE'S WINDOWS

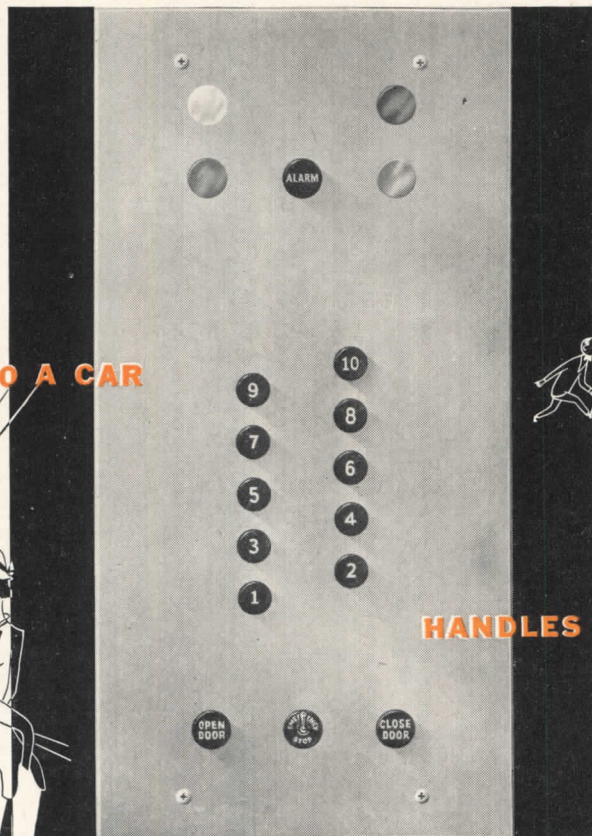


**AUTOTRONIC<sup>®</sup>**

*Without Attendant*

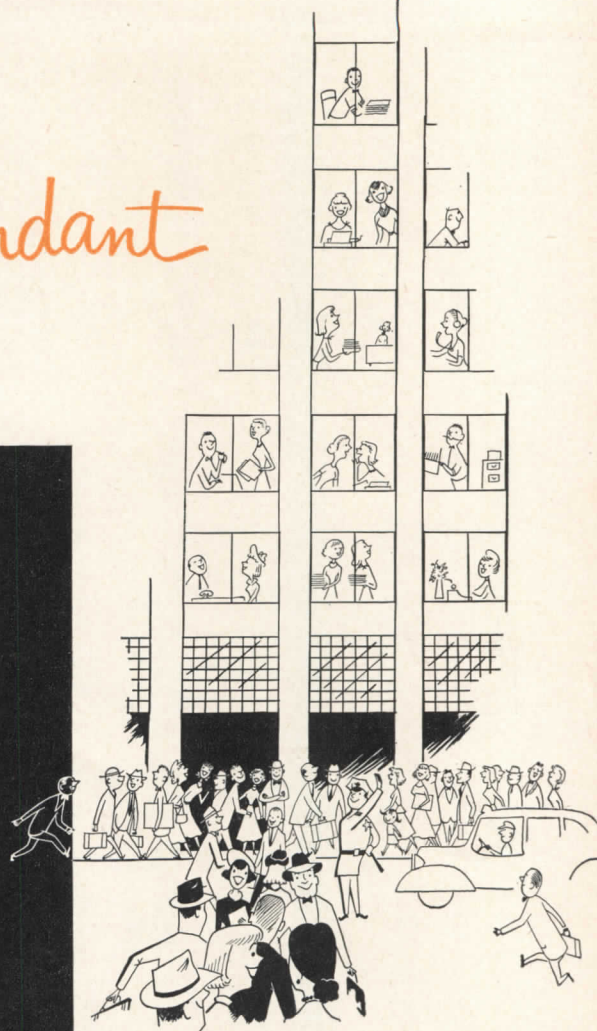
**ELEVATORING**

**SAVES UP TO \$5,500 A CAR**



*Simplified Car Operating Panel*

**HANDLES HEAVY BUILDING TRAFFIC**

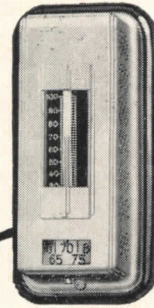


Autotronic—WITHOUT ATTENDANT—Elevating offers the only substantial saving in building operation that is available today. It saves up to \$5,500 a car, each year.

Passengers simply step into the car and press the buttons for the floors they want. The car operation is completely automatic.

Autotronic—WITHOUT ATTENDANT—Elevating has been in successful operation for more than two years. It has proven itself in single-purpose buildings. It has handled diversified traffic to everyone's satisfaction. It has the speed and the automatic group supervisory control needed in many large buildings, yet is adaptable to small buildings. It can be used in hospitals. Its specific application is a matter of individual study.

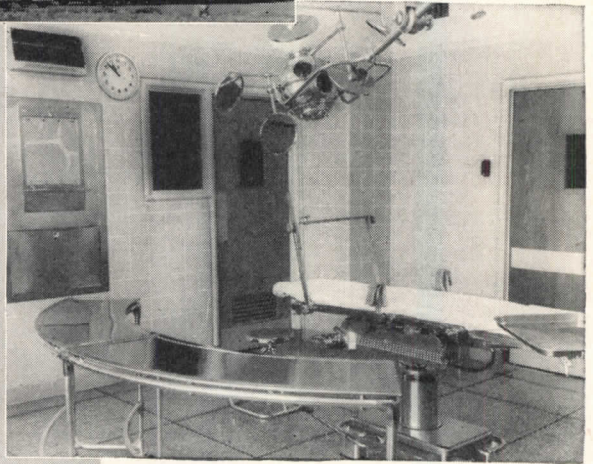
Why not visit an actual Autotronic—WITHOUT ATTENDANT—Elevating installation in a new or modernized building? Talk with the tenants and management. Ask any of our 266 offices for details. Otis Elevator Company, 260 11th Avenue, New York 1, N. Y.



St. John Hospital, Detroit, Michigan. Maguolo & Quick, architects; Davis Brothers, heating and air conditioning contractors; both of Detroit.

# JOHNSON AUTOMATIC TEMPERATURE CONTROL

**INSURES SAFETY  
SAVES VALUABLE STAFF TIME  
INCREASES EFFICIENCY**



Man must rest but the mechanical "brains," which man has developed, work with precision . . . and with no time off. Johnson temperature control systems serve automatically, every minute of each hour.

At the St. John Hospital, as in most American hospitals, the small, busy thermostats on the wall are important, indeed, to the hospital's health service.

But, above all else, hospital equipment must be safe. Johnson Control, because it is pneumatically operated, affords positive protection against explosive gases and the dangers of static electricity.

Comfort and health of St. John Hospital patients are constantly guarded by Johnson *Individual Room* Thermostats which operate Johnson Mixing Dampers to secure precisely the proper temperatures and humidities in the air-conditioned operating rooms and nurseries. The ventilating system for the kitchen also is automatically

controlled by Johnson:

Correct temperatures and humidities increase efficiency and aid in the recovery of patients, but hospital management looks to precision control of temperatures for still another important service . . . fuel savings.

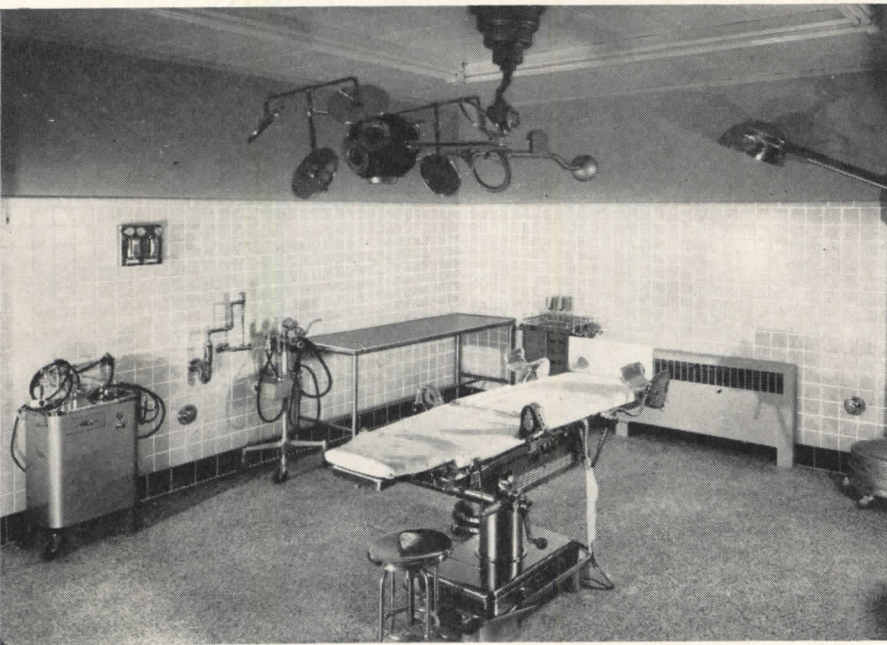
Perhaps your building presents a temperature control problem? The Johnson staff is nationwide. Let a nearby Johnson engineer talk over the desirable features and savings that the Johnson engineered control will bring to your building. Yes, older buildings also can be equipped to offer the comforts of the newest in temperature control and, often, the Johnson Control Systems will pay for themselves in fuel savings alone. Call a nearby Johnson engineer for a conference at your convenience and without obligation. JOHNSON SERVICE COMPANY, Milwaukee 2, Wisconsin. Direct Branch Offices in Principal Cities.

**JOHNSON** *Automatic Temperature and Air Conditioning* **CONTROL**  
MANUFACTURE • APPLICATION • INSTALLATION • SINCE 1885

*softly-shaded and functionally correct . . .*

# the new, beautiful *Suntile* colors

## increase the efficiency of any HOSPITAL INTERIOR!



*you get the right color  
plus the permanence  
of real clay TILE!*

Can color help hospital interiors fulfill their functions *better*?

Color authorities say "yes."

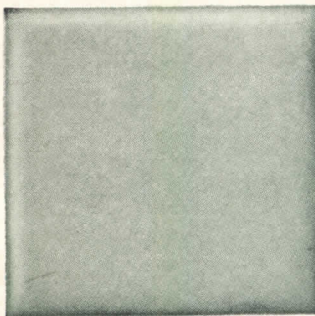
There's a *right* color—a most suitable, most beneficial color—for surgeries, wardrooms, corridors, and cafeterias . . .

The *right* color can relieve eye strain of doctors—impart visual and emotional benefits—provide a restful and cheerful environment for both patients and staff.

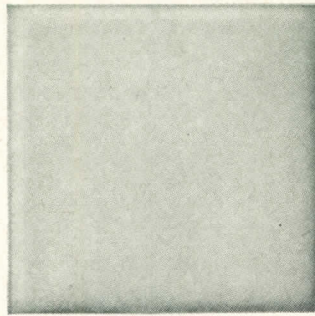
Suntile's beautiful new line of softly shaded colors has been scientifically developed to *fit the function of interiors*—not only in hospitals but in schools, institutions, commercial and industrial buildings.

This "color-fitted-to-the-function" feature" gives you another reason for selecting color-balanced Suntile for walls and floors. Other well-known reasons for choosing this *real* clay tile are: permanence, ability to withstand heavy use, sanitation, ease of cleaning, low maintenance!

Write Dept. AR-10 for our new color booklet "Suntile Functional Color Recommendations." See your local Authorized Suntile Dealer. The Cambridge Tile Mfg. Co., P.O. Box 71, Cincinnati 15, Ohio.



Sea Green 511



Light Sea Green 513

## *Suntile* SEA GREEN, LIGHT SEA GREEN

**Recommended for hospital surgery**

Shown above are two tones of Suntile Sea Green—an original and modern color designed by Suntile with the aid of Faber Birren, nationally known color authority. The soft tone Sea Green is recommended for surgeries and operating rooms; the bright tone Light Sea Green for other service areas. Both of these are carefully balanced green tints with a special satin finish. The tint is complementary to the color of human tissue and complexion—and will aid vision and reduce ocular fatigue for the surgeon. Both of these Suntile backgrounds present a dignified appearance, are visually restful and physically durable. These are only two of a complete Suntile line of 12 functional colors, adaptable to all parts of a hospital.

### WEST COAST OFFICES

The Cambridge Tile Mfg. Co.  
470 Alabama Street  
San Francisco 10, California

The Cambridge Tile Mfg. Co.  
1335 S. La Brea  
Los Angeles 19, California



**SUNTILE OFFERS YOU BOTH • BETTER TILE • BETTER INSTALLATION**

# LEVER HOUSE

combines safety and beauty  
with  
**Weldwood® Fire Doors**

The ultra-modern new LEVER HOUSE, in New York City is beautiful throughout. It is also smoothly *functional* and *safe* from top to bottom.

In fact, it was for these three qualities... beauty, utility and safety... that LEVER HOUSE selected Weldwood Fire Doors.

These *wood-faced* fire doors carry the Underwriters' Label for all Class B and C openings. Should a fire break out in any of the offices, it would be isolated. Should it attempt to invade from elsewhere, Weldwood Fire Doors, with their remarkable mineral core, stand ready to give the kind of protection for which they are famous.

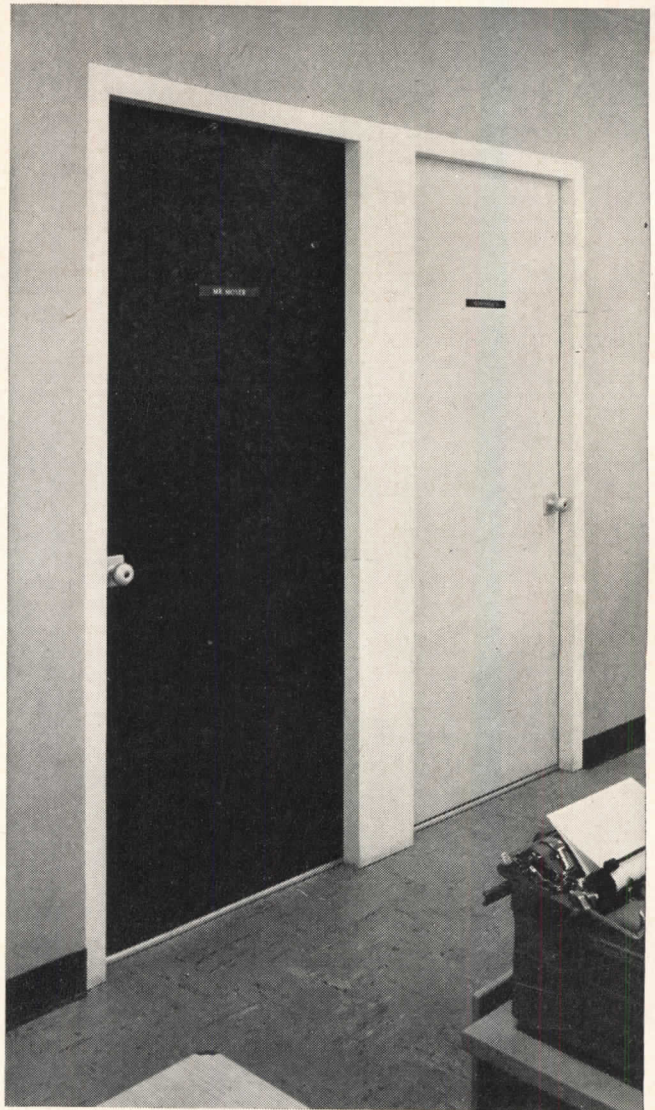
In addition, the Weldwood Fire Door is so dimensionally stable that when properly installed, it is guaranteed not to warp for the life of the installation.

Also, it is lighter in weight than other fire doors, which means that it opens and closes more easily.

The *Weldwood Stay-Strate Door* is available in the same wide range of beautiful hardwood faces as the Weldwood Fire Door...and offers the same advantages except that the edge banding is not fireproofed.

Like the Weldwood Fire Door, it has striking beauty...unusual light weight...exceptional stability...extraordinary durability...and is proof against rot, vermin and decay.

Send for complete information about both these Weldwood Flush Doors today.



Weldwood Fire Doors in the LEVER HOUSE, New York City.  
Arch: Skidmore, Owings & Merrill.



## WELDWOOD® FLUSH DOORS

Manufactured and distributed by

**UNITED STATES PLYWOOD CORPORATION**

*World's Largest Plywood Organization*

55 West 44th Street, New York 18, N. Y.

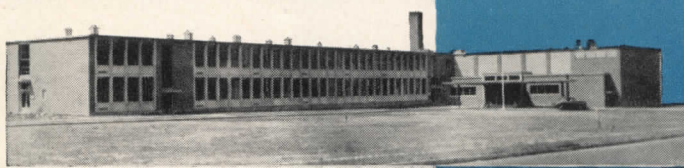
Branches in Principal Cities • Distributing Units  
in Chief Trading Areas • Dealers Everywhere

United States Plywood Corporation carries the most complete line of flush doors on the market, including the famous Weldwood Fire Doors, Weldwood Stay-Strate Doors, Weldwood Staved Lumber Core Flush Doors and Mengel Solid Core and Hollow Core Flush Doors, 1 $\frac{3}{8}$ " and 1 $\frac{3}{4}$ " with a variety of both foreign and domestic face veneers.



### 1. Randolph High School

Architect: Harry J. Korslund •  
Gen. Contr.: Hayes & Watkins  
Constr. Co. • Plbg. Contr.: C. H.  
Cronin & Co.



### 2. West High School

Architect: J. William Beals &  
Sons • Gen. Contr.: Platt Con-  
tracting Co., Inc. • Plbg. Contr.:  
E. W. Diegoli & Sons

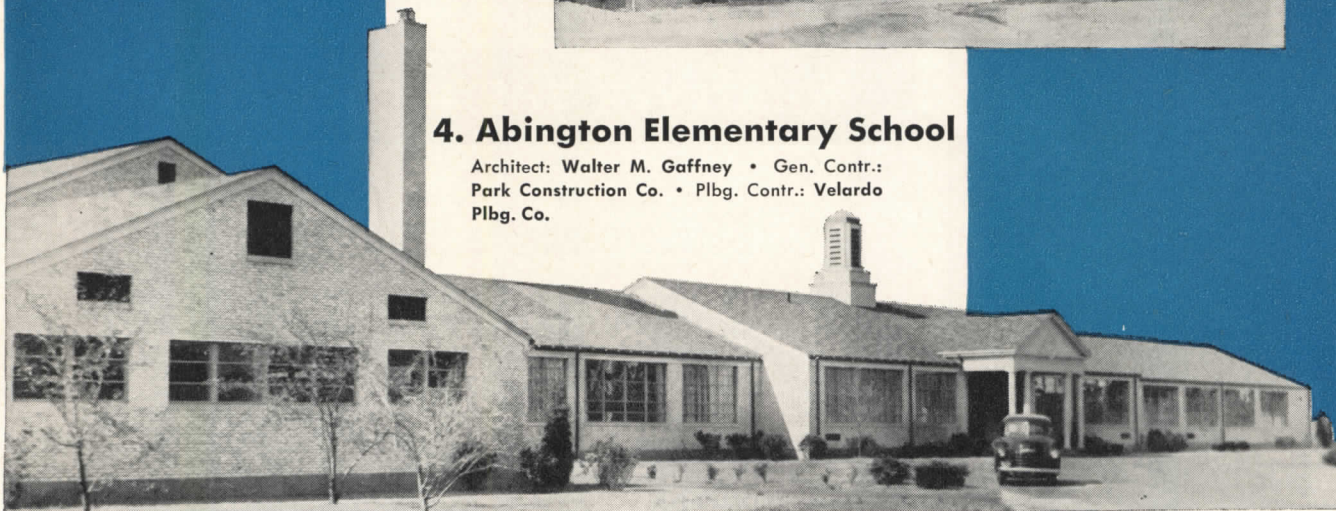
### 3. Mahomet Elementary School

Architect: Walter M. Gaffney •  
Gen. Contr.: C. A. Batson Co. •  
Plbg. Contr.: Velardo Plbg. Co.



### 4. Abington Elementary School

Architect: Walter M. Gaffney • Gen. Contr.:  
Park Construction Co. • Plbg. Contr.: Velardo  
Plbg. Co.



## School after school *requires* **RICHMOND**

Today's modern school requires sturdy, efficient, well-designed plumbing fixtures. That's why these 4 new schools are equipped throughout with Richmond. Architects, Builders and Plumbing Contractors know Richmond's "whiter-white"

lavatories, drinking fountains, service sinks, water closets and urinals stand up to hard usage...stand out in appearance...are designed for easy sanitary maintenance.

Why not rely on Richmond's complete line for all your institutional and industrial plumbing requirements?



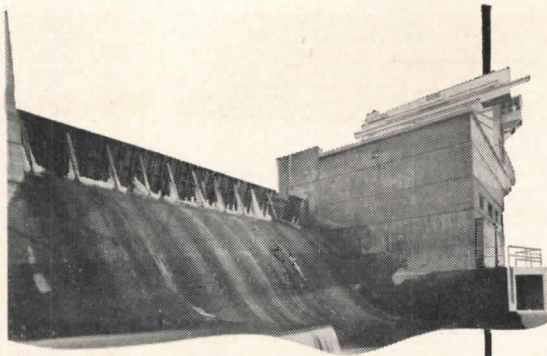
# RICHMOND

RICHMOND RADIATOR CO.—AFFILIATE OF REYNOLDS METALS CO.

See your wholesaler or Mail Coupon Today:

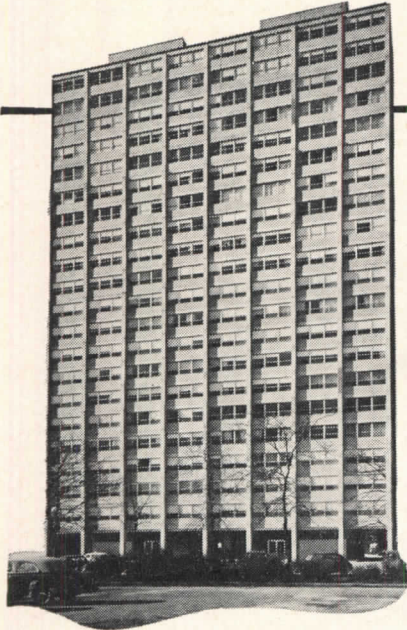
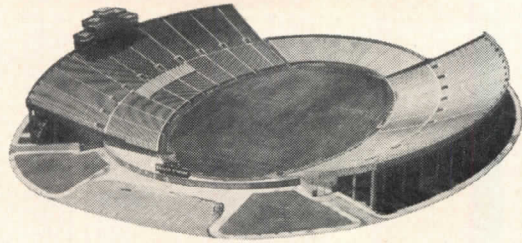
Richmond Radiator Company AR/10  
19 East 47th Street, New York 17, New York  
Please send me additional information on  
Richmond fine plumbing fixtures. No obliga-  
tion, of course.

NAME.....  
COMPANY.....  
ADDRESS.....  
CITY..... ZONE..... STATE.....  
We are  plumbing wholesalers  plumbing  
contractors  building contractors.

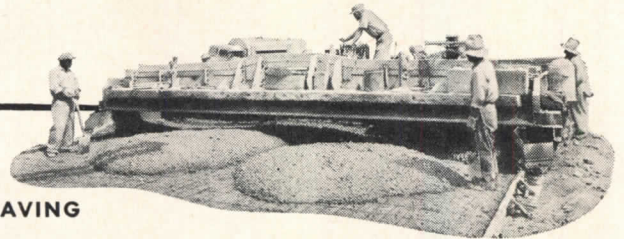


MASS

STRUCTURAL



ARCHITECTURAL



PAVING

## WHATEVER THE JOB...

### Better concrete at no extra cost made with **DURAPLASTIC\***

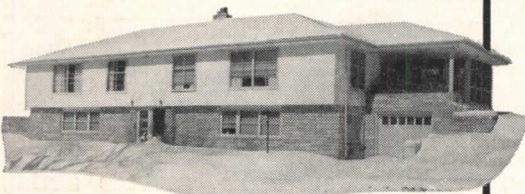
**WHEN YOU FIND** that one cement makes better concrete for everything from a modern superhighway to a drain tile, you can readily understand the growing trend to *specify* it. Atlas Duraplastic makes concrete more durable and improves surface appearance as well. And there are mighty good reasons why this is so.

Duraplastic is the original air-entraining portland cement. It requires less mixing water for a given slump. Too, it minimizes water gain and segregation. This gives increased resistance to effects of freezing-thawing weather, and in paving helps avert the scaling action of de-icing salts.

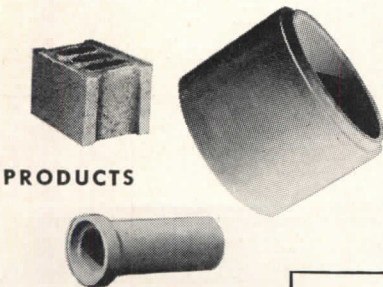
You'll especially like the on-the-job advantages of a Duraplastic mix. Construction men find the greater plasticity aids proper placement. Highway builders have learned that less mixing water and less bleeding permit finishing closer to the paver, earlier protection for curing. Products manufacturers report less breakage of green products.

You can have these advantages simply by specifying Atlas Duraplastic. It costs *not one penny more than regular cement*. No extra bother . . . just ordinary good care and procedure. Complies fully with ASTM and Federal Specifications. For more information, write Universal Atlas Cement Company (United States Steel Corporation Subsidiary), 100 Park Avenue, New York 17, N. Y.

\*"Duraplastic" is the registered trade mark of the air-entraining portland cement manufactured by Universal Atlas Cement Company.



STUCCO



PRODUCTS

**ATLAS®**

# DURAPLASTIC

AIR-ENTRAINING PORTLAND CEMENT



AR-D-142

**Makes Better Concrete at No Extra Cost**

"THE THEATRE GUILD ON THE AIR"—Sponsored by U. S. Steel Subsidiaries—Sunday Evenings—NBC Network



Above: St. Jude's Hospital, Montgomery, Alabama. Architect: James C. Maschi. Red Kalistron on dados and furniture, contrasting Kalistron above chair rail.

## UNBELIEVABLE DURABILITY

*on our hospital walls and furniture...*

That's the comment frequently heard about *Kalistron* installations. When walls, doors, columns or furniture are covered with *Kalistron*, they literally defy the wear and tear of "heavy duty" service. Years after installation, the *Kalistron* is still in excellent condition . . . unmarred, unscratched, with practically no sign of wear.

*Kalistron* is different because its color is fused to *underside* of clear sheet of wear-resistant Vinylite. Since nothing can touch this under-surface, *Kalistron's* beauty stays fresh and new-looking.

*Kalistron* cannot chip, crack or peel; minimizes maintenance costs. Cleans easily with a damp cloth. In 28 standard colors: special colors matched.

SEND COUPON BELOW for sample of *Kalistron* and nail-file. Test *Kalistron* yourself . . . prove its unbelievable durability.

**Kalistron** †  
PAT. APPLIED FOR  
 ← COLOR FUSED TO UNDERSIDE  
 PLASTIC COVERING MATERIAL

U. S. Plywood Corp., Dept. F-15  
 55 West 44th St., New York 18

Please send me FREE Nail-File Test (swatch of *Kalistron* plus actual nail-file) and folder "Facts About *Kalistron*."

NAME \_\_\_\_\_

ADDRESS \_\_\_\_\_

Distributed by: U. S. PLYWOOD CORPORATION, N. Y. C. and  
 by: DECO SALES, 408 Freylinghuysen Ave., Newark, N. J.  
 In Canada: PAUL COLLET & CO., LTD., MONTREAL

Color fused to  
 underside of  
 transparent vinyl  
 sheet . . . backed  
 by flocking

# LOOKING FOR WAYS TO CUT COSTS?

Your only answer may be in using your labor more efficiently..

1. No More Shoveling, Men Are Free For Other Duties... A Tremendous Saving In Man-Power Alone! Then Consider All The Other Low-Cost Advantages....

2. SIDE DUMP ASH PLATES, AN OPTIONAL FEATURE OF CANTON BINFEEDS, ELIMINATE SMOKE, FUMES, DUST IN BOILER ROOM... ASH SPRAY PIPES SIMPLIFY CLEANING.

4.

AS AUTOMATIC NOW, AS GAS OR OIL.

3.

COMPLETE CONTROL PANEL ENGINEERED FOR THE JOB IS WIRED AND TESTED AT THE FACTORY — PAYS FOR ITSELF BY SIMPLIFYING WIRING ON THE JOB SITE AND GUARANTEEING PROPER CONTROL OPERATION. MODULATING COMBUSTION AND DRAFT CONTROLS ARE AVAILABLE ON ALL MODELS.

5.

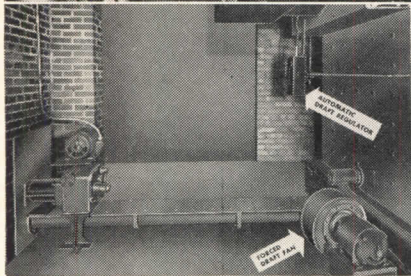
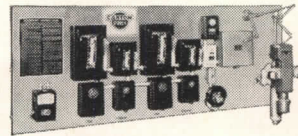
CANTON BINFEED STOKERS HOLD STEAM PRESSURES CONSTANT, REDUCE FUEL COSTS BY PRODUCING MORE HEAT FROM THE FUEL; ALLOW CHEAPER GRADES AND SIZES OF COAL TO BE USED EFFICIENTLY.

6.

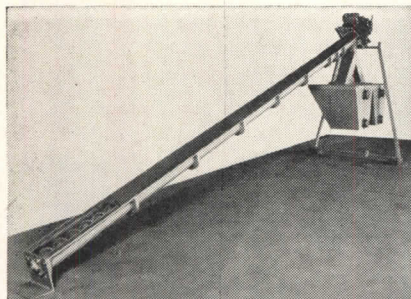
NO NEED FOR SEPARATE INCINERATOR WITH CANTON SIDE DUMP BINFEEDS, AS THEY PROVIDE FOR BURNING REFUSE.

7.

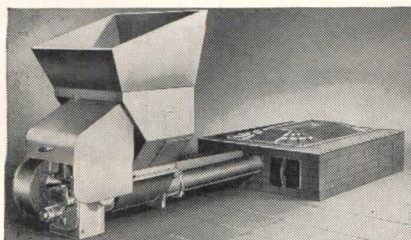
FLAT PLATE TOP OF WORM CASING CAN BE INSTALLED AT FLOOR LEVEL, WHEN DESIRABLE, FOR TRUCKS OR TRAFFIC TO PASS OVER.



New Canton Binfeed with coal conveyor rear of boiler. Note fan and automatic draft regulator are also at rear of boiler, out of the way.



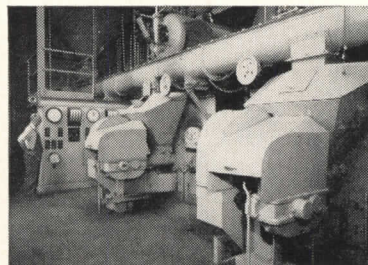
Flo-Tube Coal Conveyors fill one or more hoppers direct from bin or pile. Are also used horizontally as in picture at right, with gate valves to control hopper feeding.



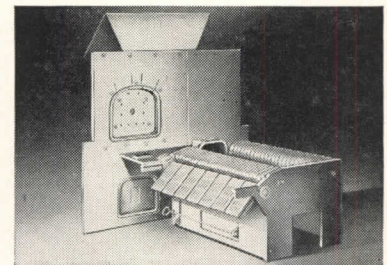
For larger Boilers, ample active burning area is provided by Canton's newest Tuye design with measured air graduation and fin-cooling ribs. Dead plate type illustrated here... also available in side ash dumping type.

## LOOK AT THE NEW CANTON STOKER DEVELOPMENTS

Binfeed Stokers cut costs immediately for every heat and power demand by allowing more efficient use of labor. High wages, going higher, have speeded up the need for automatic handling of coal—the lowest price fuel. It will pay to look into the new developments by Canton Stoker, specialists in COAL FIRING, HANDLING and CONTROL equipment. Representatives in principal cities of the U. S. have complete information, or write direct.



Ever see a neater installation? This photo is NOT RETOUCHEd. It is Canton Stoker installation, St. Mary's Hospital, Niagara Falls, New York. Hoppers are fed horizontally, direct from bin by screw conveyors.



New Canton "SINGLE-SIDE-DUMP" model, engineered and built for narrow boilers.



"TURBO-AIRE" JETS — for smoke abatement, firing efficiency.



WRITE FOR NEWEST BROCHURE on Binfeed Stokers. It contains blue-prints and plan of a model stoker installation. A great help in planning or remodeling.



CANTON STOKER CORPORATION

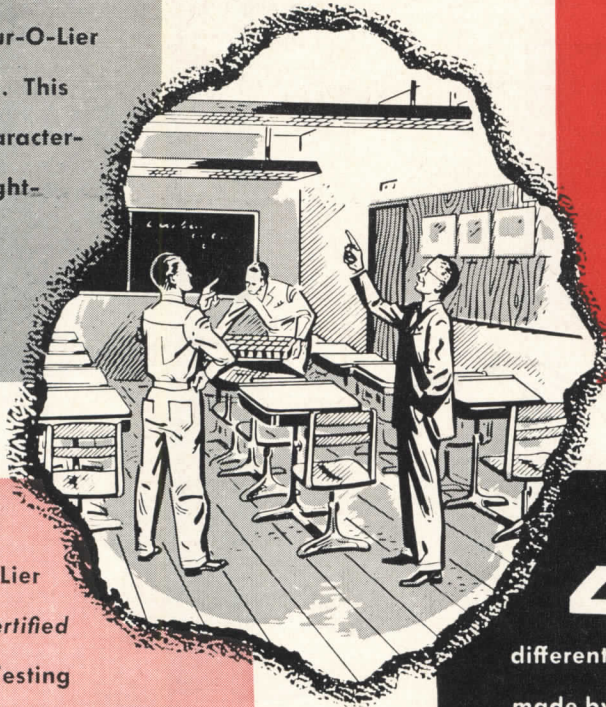
2300 ANDREW PLACE S. W.

CANTON, OHIO

# YOU GET 4 EXCLUSIVE ADVANTAGES WHEN YOU SPECIFY

## FLEUR-O-LIER

**1** Only Fleur-O-Lier fixtures are rated on the Fleur-O-Lier Index Rating System. This gives illuminating characteristics, shielding, brightness, etc., for each fixture.



**2** Complete photometric test data including distribution curves and coefficients of utilization tables are computed by Electrical Testing Laboratories, Inc., and are provided for every Fleur-O-Lier luminaire.

**3** Fleur-O-Lier fixtures are certified by Electrical Testing Laboratories, Inc., as complying with rigid specifications covering electrical and mechanical construction.

**4** More than 300 different Fleur-O-Lier fixtures made by nearly 30 manufacturers give you a wide selection from which to choose.

THESE 4 ADVANTAGES ASSURE *Lighting Satisfaction* WHEN YOU SPECIFY FLEUR-O-LIER

*Free Booklet*

Write for your free copy of the new booklet giving complete details of the Fleur-O-Lier Index System.

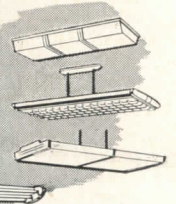


## FLEUR-O-LIER

*Manufacturers*

2116 Keith Building • Cleveland 15, Ohio

Fleur-O-Lier is not the name of an individual manufacturer, but of a group of fixtures made by leading manufacturers. Participation in the Fleur-O-Lier program is open to any manufacturer who complies with Fleur-O-Lier requirements.



# For A Better Job ...

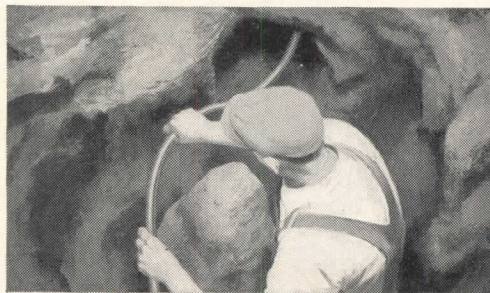
## CHASE<sup>®</sup> COPPER WATER TUBE

**Put it here!**



What could be better than long-lasting Chase Copper Water Tube for domestic hot and cold water lines! It is made in hard and soft temper...straight lengths and long coils. Type L hard temper is especially suited for new construction. Soft temper comes in 60 and 100' coils that can be snaked behind walls and under flooring for replacement jobs.

**Put it here!**



For underground installations there's nothing better than Chase Type K, Copper Water Tube. Type K in soft temper can be easily bent around obstructions...it moves with the earth and settling won't harm it. Long lengths up to 100 feet in coils make few fitting connections necessary. Chase Copper Water Tube resists corrosion, does not clog with rust.



**Chase**  **BRASS & COPPER**

WATERBURY 20, CONNECTICUT - SUBSIDIARY OF KENNECOTT COPPER CORPORATION

• The Nation's Headquarters for Brass & Copper

Albany†	Cleveland	Kansas City, Mo.	New York	San Francisco
Atlanta	Dallas	Los Angeles	Philadelphia	Seattle
Baltimore	Denver†	Milwaukee	Pittsburgh	Waterbury
Boston	Detroit	Minneapolis	Providence	
Chicago	Houston†	Newark	Rochester†	(†sales office only)
Cincinnati	Indianapolis	New Orleans	St. Louis	

# Add Sales Appeal with the NEW TIMKEN *Silent Automatic* Gas Furnace Line!

**New Engineering! New Styling! New Sales Opportunities!**

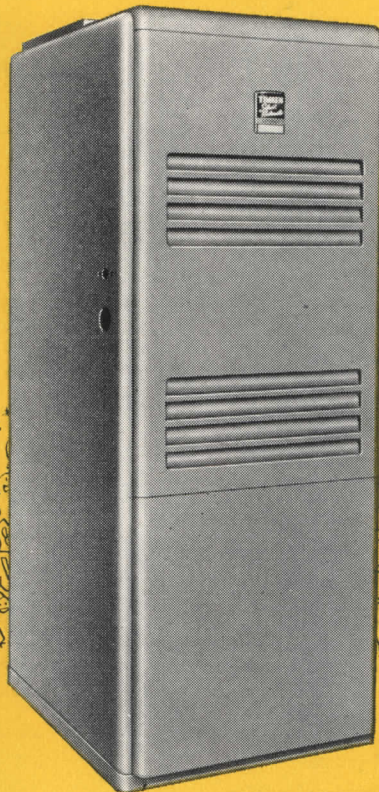
## A BIGGER LINE FOR FASTER HOME SALES AND BIGGER PROFITS!

Here's sure-fire sales opportunity for architects and builders! It's the all-new, feature-packed Timken Silent Automatic gas furnace line—one of the finest, most complete lines of gas-fired furnaces ever offered by one manufacturer!

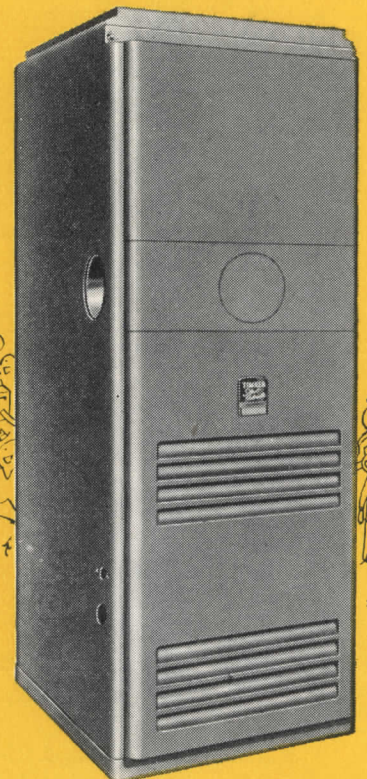
These furnaces have everything! Spanking new and good looking, they're competitively priced to meet rigid construction budgets! And they're *experience-engineered* by men with more than 25 years of heat engineering behind them.

Architects and builders who feature this most advanced of all forced warm air gas furnace lines are going to sell their homes faster! Home buyers recognize quality in the Timken Silent Automatic name, and *quality* sells homes!

APPROVED BY AMERICAN GAS ASSOCIATION



▲ HI-FURNACES. For basement or utility room installation, ideal for homes where space is at a premium. Six sizes with input capacities from 75,000 to 200,000 Btu. Height is 63 inches, depth 29 inches, with widths varying from 16 to 34 inches.



▲ COUNTERFLOW-FURNACES. For small basementless homes, especially those using perimeter heating systems. Three sizes with capacities from 75,000 to 125,000 Btu. Height is 63 inches, depth 29 inches, with widths varying from 12 to 23 inches.

◀ LO-FURNACES. For basement installation. Especially suitable where ceilings are low. Six sizes with input capacities from 75,000 to 200,000 Btu. They are 41 inches high, 42 inches deep and vary in width from 16 to 34 inches.



The new Timken Silent Automatic forced warm air gas furnaces are the latest addition to a complete line of quality-built gas-fired equipment for every home heating need. Other models include boilers, conversion burners and oil-to-gas conversion kits.

## Only Timken Silent Automatic Offers All These Outstanding Sales Features!

- **NEW ENGINEERING!** Years were spent in developing these superior furnaces. Each unit combines all the finest, most wanted gas heating features in one handsome cabinet!
- **NEW STYLING!** These furnaces are lifetime beauties! Sturdy modern construction and a silvertan baked-enamel finish give them real eye-and-buy appeal!
- **NEW BURNER!** Advance-designed ribbon-type burner is pre-

cision die-formed of stamped steel, vitreous enameled inside and out to prevent corrosion. Assures efficient, dependable operation at all times!

- **NEW FEATURES!** Adjustable blower speeds . . . flame-proof filters of spun glass . . . quiet, rubber-mounted motor . . . completely automatic controls!

- **NEW SALES OPPORTUNITIES!** Fifteen different models and sizes make it possible to meet the heating

needs of your homes with dependable, top-quality equipment!

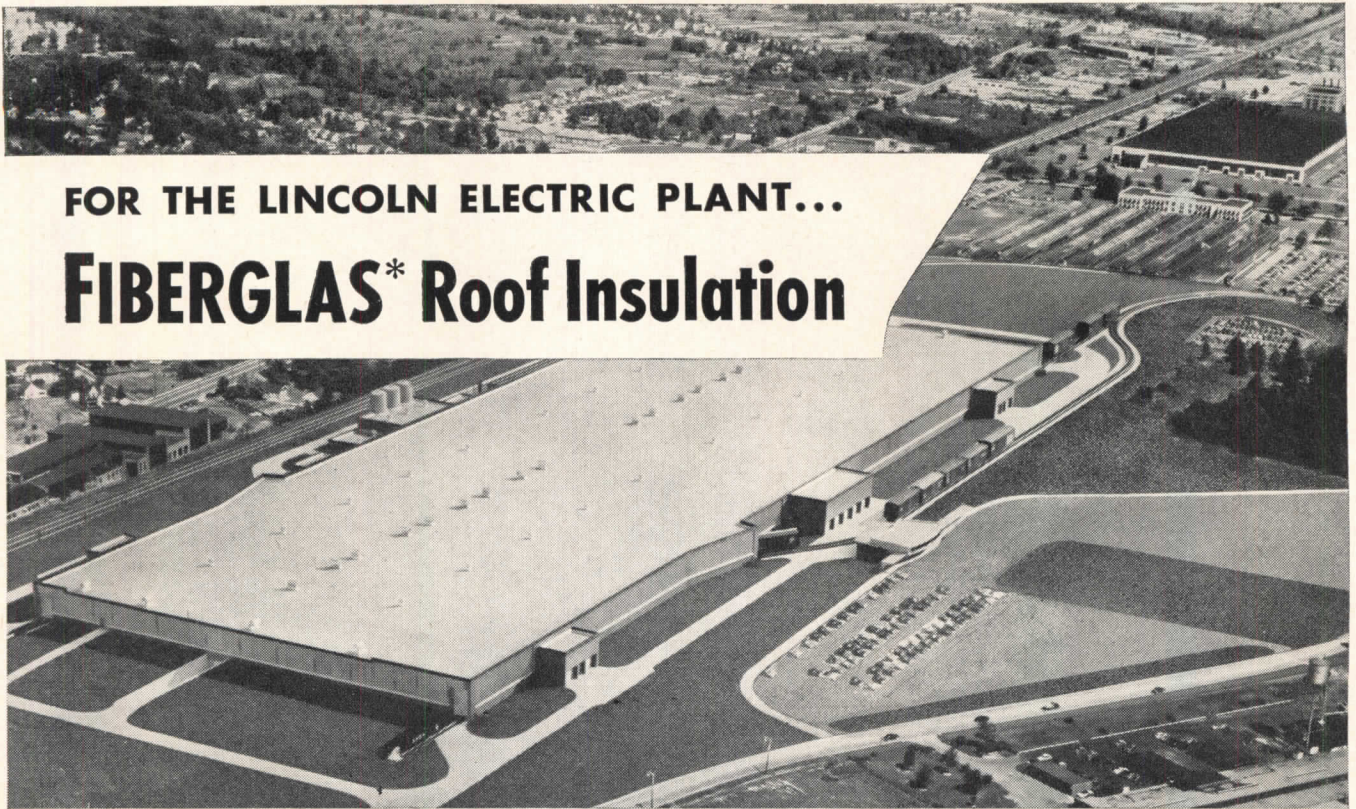
- **NEW ADAPTABILITY!** They function perfectly at both normal and high altitudes with any city gas, LP or LP-Air mixture.

- **AND REMEMBER!** When you advertise that your homes are Timken Silent Automatic equipped, they'll sell faster! There's no substitute for the Timken Silent Automatic quality reputation!

# TIMKEN *Silent Automatic* GAS HEAT

TIMKEN SILENT AUTOMATIC DIVISION  
The Timken-Detroit Axle Company • Jackson, Michigan  
The Timken-Detroit Axle Company of Canada, Ltd., Toronto, Ont.





**FOR THE LINCOLN ELECTRIC PLANT...**  
**FIBERGLAS\* Roof Insulation**

**... Another example of why it pays to bid  
 Fiberglas Roof Insulation!**

**JOB DATA:**

**Building:** Lincoln Electric Co. . . . . Cleveland  
**Design and Construction:** The Austin Company . . . . Cleveland  
**Year of Completion:** 1951  
**Type of Deck:** Steel  
**Type of Built-up Roof:** 4-ply tar and gravel  
**Insulation:** Fiberglas Roof Insulation, approximately 750,000 sq. ft.  
**Roofer:** Industrial Roofing & Sheet Metal, Inc., Cleveland

These outstanding advantages of Fiberglas Roof Insulation apply to both large and small jobs:

- ★ **Competitively priced!** The exceptionally high insulating values of Fiberglas Roof Insulation give your customers maximum insulation, dollar for dollar.
- ★ **Mechanics like to apply it!** Fiberglas Roof Insulation is lightweight, easy to handle, cut and apply, and provides an excellent mopping surface.
- ★ **Designed for built-up roof use!** Made of non-combustible, durable fibers of glass, Fiberglas Roof Insulation provides a firm, sound, underlying layer of insulation. It will not warp, rot, buckle or swell.
- ★ **Proved in use!** Leading roofers use Fiberglas Roof Insulation. Bonded by outstanding built-up roofing firms.



\*Fiberglas is the trade-mark (Reg. U. S. Pat. Off.) of the Owens-Corning Fiberglas Corporation for a variety of products made of or with fibers of glass.

Call your nearest Fiberglas Branch Office today for complete details, or write to: Owens-Corning Fiberglas Corporation, Department 68-J, Toledo 1, Ohio.

**WRITE FOR FIBERGLAS DESIGN DATA**

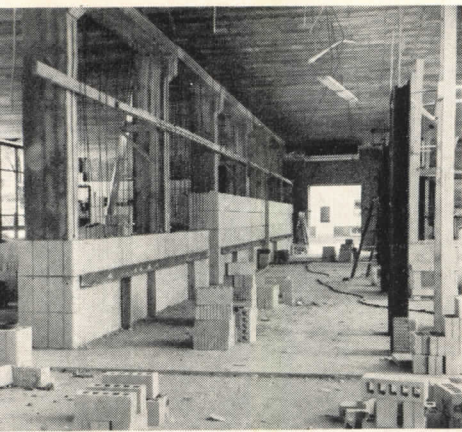
ROOF INSULATION    FORM BOARD    BUILDING INSULATION    PERIMETER INSULATION    INDUSTRIAL INSULATION    DUCT INSULATION    CENTRAL SYSTEM FILTERS    ACOUSTICAL TILE





# WHEN SCIENCE IS YOUR CLIENT

## build with Facing Tile



Facing Tile laid vertically in stack bond provides a handsome, permanent finish in the Science and Pharmacy Buildings, Drake University. Saarinen, Swanson and Saarinen, Architects. Brooks-Borg, Associate Architects.

### FOR ALL THE FACTS ABOUT FACING TILE

glazed or unglazed, send for free booklet, "Catalog 52-C," "The Scientific Approach to Color Specification" and "Facing Tile Construction Details." Just address your request to any Institute Member or Dept. A-7-0 of our Washington or New York offices.

### LOOK FOR THIS SEAL



It is your assurance of highest quality Facing Tile. This seal is used only by members of the Facing Tile Institute. In the interest of better Facing Tile construction these companies have contributed to the preparation of this advertisement.

**BELDEN BRICK CO.**  
Canton, Ohio

**CHARLESTON CLAY PRODUCTS CO.**  
Charleston 22, West Virginia

**THE CLAYCRAFT CO.**  
Columbus 16, Ohio

**HANLEY CO.**  
New York 17, New York

**HOCKING VALLEY BRICK CO.**  
Columbus 15, Ohio

**HYDRAULIC PRESS BRICK CO.**  
Indianapolis, Indiana

**MAPLETON CLAY PRODUCTS CO.**  
Canton, Ohio

**METROPOLITAN BRICK, INC.**  
Canton 2, Ohio

**McNEES-KITTANNING CO.**  
Kittanning, Pennsylvania

**NATIONAL FIREPROOFING CORP.**  
Pittsburgh 22, Pennsylvania

**ROBINSON BRICK & TILE CO.**  
Denver 9, Colorado

**STARK CERAMICS, INC.**  
Canton 1, Ohio

**WEST VIRGINIA BRICK CO.**  
Charleston 24, West Virginia

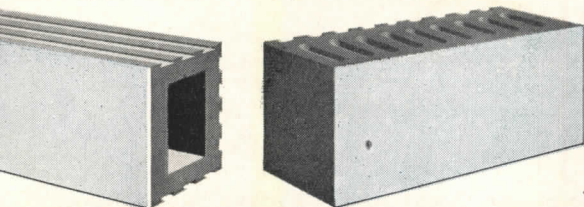


It's easy to see why interiors of Facing Tile are specified wherever modern science is at work—in today's finest hospitals, industrial plants and research laboratories.

Facing Tile promotes cleanliness—prime requisite in so many buildings designed to serve science. Its hard-burned surface offers no place for dirt to hide, stays lustrous as new with only an occasional washing.

Facing Tile is "color-engineered"—its controlled range of colors permits you to create environments precisely fitted to the most exacting scientific tasks. With these colors you can improve vision, aid lighting, increase productivity, and boost the morale of the staff.

Facing Tile assures the long-range maintenance savings that count heavily with management. It's not only durable and easily cleaned—it provides a structural wall and a beautiful, lasting finish in one economical operation.



## FACING TILE INSTITUTE



## In Honolulu they use Bigelow carpet on the walls!

**Most people** use carpets on the floor—but not the Waikiki Branch of Bishop First National Bank of Honolulu. So many of their customers track sand in, they have to use marble on the floor. As you can imagine, this made things a bit noisy underfoot.

So to cut down on the noise, they put Bigelow on the walls. They chose Bigelow's Ceredo because of its amazing insulating and sound-absorbing qualities.

This is only one of the unusual, difficult installation jobs accomplished by Bigelow's Carpet Council every year!

Are you having carpet troubles? Need a new spark

to your décor... need a *seemingly* impossible installation job... or do you simply need a new carpet?

Whatever your problems, Bigelow's expert Carpet Council is ready to help you. They will work with you, your architect or decorator—and will give valuable advice on colors, patterns and weaves in the price range you prefer.

Why not contact Bigelow's Carpet Council today?

**This Service Is Absolutely Free!** Just write to Bigelow Carpet Council, 140 Madison Avenue, New York, N. Y. Your inquiry will receive prompt attention.

# BIGELOW Rugs and Carpets

*Leaders in the development of home and commercial floor covering since 1825.*

**Bigelow sales offices are located in the following strategic cities:** Atlanta, Ga.; Baltimore, Md.; Boston, Mass.; Buffalo, N. Y.; Chicago, Ill.; Cincinnati, Ohio; Cleveland, Ohio; Columbus, Ohio; Dallas, Tex.; Denver, Col.; Detroit, Mich.; Hartford, Conn.; High Point, N. C.; Indianapolis, Ind.; Kansas City, Mo.; Los Angeles, Calif.; Milwaukee, Wis.; Minneapolis, Minn.; New York, N. Y.; Philadelphia, Penna.; Pittsburgh, Penna.; St. Louis, Mo.; Salt Lake City, Utah; San Francisco, Calif.; Seattle, Wash.



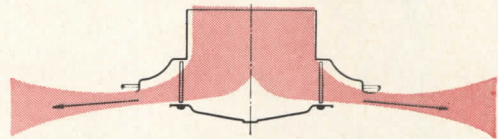
## Handsome air diffusers that do a better job

● With no other tool than a screw driver, you can easily and accurately adjust the air flow from a Kno-Draft Air Diffuser from horizontal to almost vertically downward — and do it *after* installation.

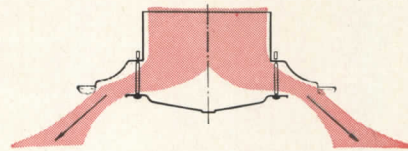
Think what this can mean in reducing your preliminary figuring for a job . . . and increasing customer satisfaction with the operation of the system. Kno-Draft *Adjustable* Air Diffusers are top performers under all conditions.

Yet adjustability after installation is only one of many reasons why Kno-Draft Air Diffusers are rapidly becoming the preferred units for both commercial and industrial installations.

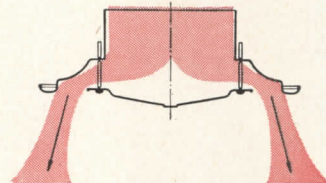
For the complete Kno-Draft story, mail the coupon today to W. B. Connor Engineering Corporation, Danbury, Connecticut.



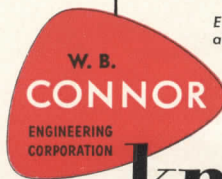
Horizontal air discharge — best for cooling and low mounting height without flush ceiling.



Moderate downward air discharge — best for average conditions.



Extreme downward air discharge — best for warm air heating and high mounting without flush ceiling.



# kno-draft®

adjustable air diffusers

W. B. CONNOR ENGINEERING CORP.

Dept. E-102, Danbury, Connecticut

Please send me the *new edition* of the Kno-Draft Data Book—without obligation, of course.

Name.....

Position.....

Company.....

Street.....

City..... Zone..... State.....

# REVOLUTION ON THE SKYLINE

**Sealuxe** metal-glass facades are creating a revolution on the skyline. They are functional! They are beautiful!

**UNIVERSAL** can help solve your design and engineering problems. Universal Corporation has authorized agents in ALL of the architectural centers to assist you with your preliminary drawings.

Miracles In Metals

## Sealuxe

ENGINEERED  
ACCESSORIES

- Browne "Folding Flue" Windows
- Ventilating Picture Windows
- Cellular Spandrels and Fascias
- Rectangular Fins
- Polygonal Fins
- Dormer Surrounds
- Canopies (Eyebrows)
- Solar Shades
- Weather Controls
- Integral Radiation and Conduit Compartment

All Sealuxe Installations are erected by Universal's own field organization.

Home of Famous Browne "Folding Flue" Windows

J. P. TRAVIS, *President*



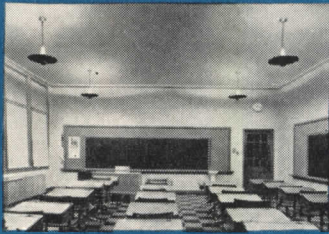
Sealuxe Model 51 Thermo-Vista Windows  
Sealuxe Solar Shades  
550 BUILDING - MIAMI, FLORIDA  
ARCHITECTS: Robert Law Weed & Associates  
Miami, Florida

# Universal CORPORATION

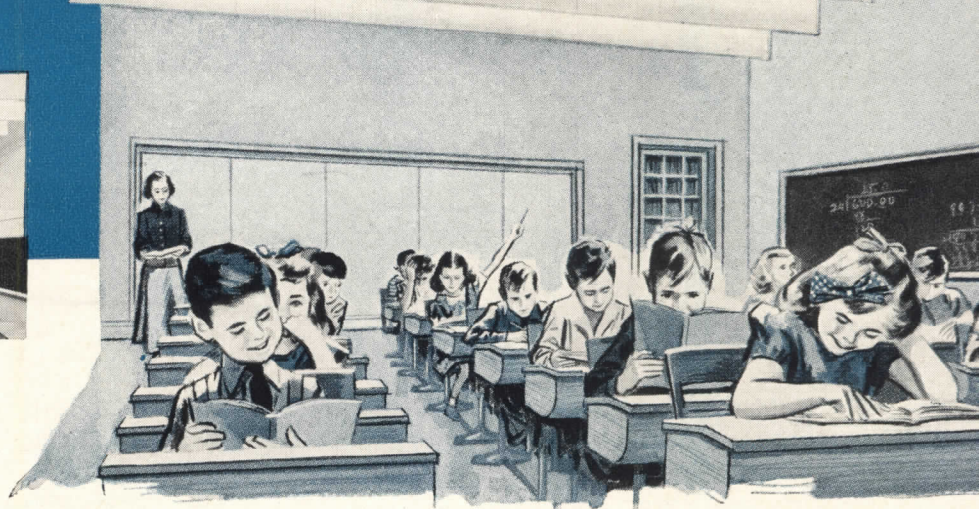
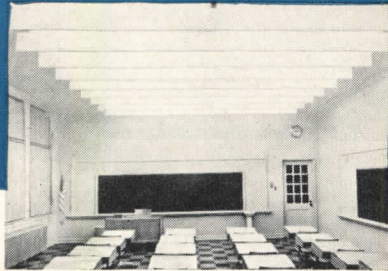
6710 Denton Drive, Dallas 9, Texas



*The lighting every young American deserves  
is here at last!*



Yesterday's Illumination Standards  
are now superseded by this shadow-dispelling  
ceiling of comfortable light.



**NOW! Here, at last, is the  
COMFORT-BRIGHTNESS  
BALANCE**

long sought by Educators

**no forest of fixtures...no annoying glare  
...no disturbing brightness...**

The dream of every educator...*more useable illumination with greatly improved comfort-brightness balance*—is now brought to realization through Benjamin's newest engineering advancement... the "Grid-Lite" Lighting System.

"Grid-Lite", through its translucent louvers, literally creates an entire ceiling of light... yet without involving excessive cost.

The translucent louver not only provides proper shielding... but imparts a unique quality to the light that makes for ease of seeing... a complete unawareness of high level lighting... a sense of comfort which promotes attention and concentration.

"Grid-Lite" triumphs over cost. It puts the entire system into a single package... ready to install. A descriptive bulletin is ready for your inquiry. Write Benjamin Electric Mfg. Co., Dept. Q-1, Des Plaines, Illinois.

*Latest Engineering Achievement by* **BENJAMIN**

*"Grid-Lite"*  
A COMPLETE LIGHTING SYSTEM IN A PACKAGE  
READY FOR ECONOMICAL INSTALLATION

When you  
figure  
the pipe  
you can  
be sure—



*if it's* **National**

• A lot of people have faced a lot of piping problems over the last 60 years. During that time, so many of them have solved their requirements with one pipe—NATIONAL Steel Pipe—that they have made NATIONAL the largest selling pipe in the world.

Other things have helped too . . . the fact that one integrated organization has complete control of U·S·S NATIONAL Steel Pipe production, from the raw material to the finished product . . . the fact that advanced steel-making facilities and special pipe manufacturing processes are here combined with the experience of thousands of skilled craftsmen to produce steel pipe of uniformly high quality and utmost dependability.

As a result, when you decide on NATIONAL Steel Pipe you can be sure you'll always get pipe whose metallic structure, strength, sound joints, superior cutting, bending and threading properties assure easy installation and long, trouble-free performance.

These are the reasons why "old timers" swear by NATIONAL Steel Pipe and why NATIONAL is being consistently specified by the new generation of architects, engineers and contractors. In turn they have found that for low cost, easy installation and *proved* reliability in service, no other pipe quite fills the bill like NATIONAL.

So when you need an all-purpose steel pipe . . . make it NATIONAL.

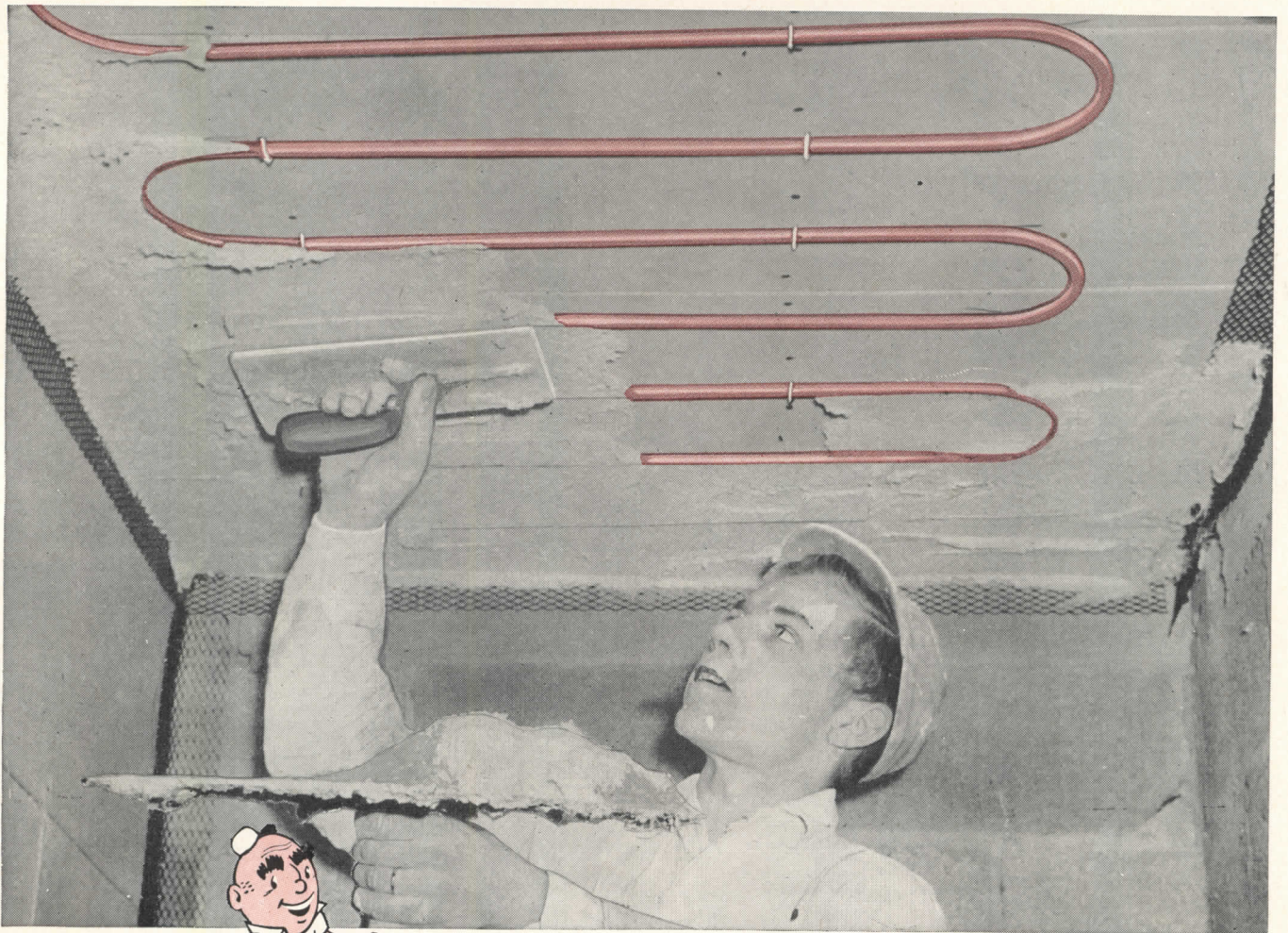


NATIONAL TUBE DIVISION, UNITED STATES STEEL COMPANY, PITTSBURGH, PA.  
COLUMBIA-GENEVA STEEL DIVISION, SAN FRANCISCO, PACIFIC COAST DISTRIBUTORS  
UNITED STATES STEEL EXPORT COMPANY, NEW YORK



**U·S·S NATIONAL Steel PIPE**

U N I T E D S T A T E S S T E E L



Extra-strong, lightweight coils of Bundyweld Tubing are easily mounted onto ceilings. Lying flat and straight, coils are quickly plastered over, with small chance of damage from rough handling or accidental hammer blows.

## Place your houses in top demand— with Bundyweld Ceiling Radiant Heating

Here's your chance to move your houses out in front of competition with Bundyweld Ceiling Radiant Heating.

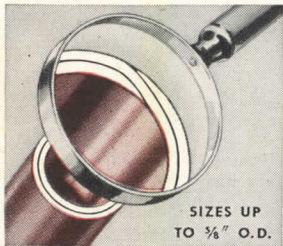
The market's ready-made, fast-growing. And for good reason! Present users hail this clean, economical and convenient way to heat homes. They're sold on the idea of walls without dirt streaks, of warmth that's always even, of freedom from drafts, of lower fuel bills. And they're enthusiastically passing the word along to friends.

Thousands and thousands of prospective home owners are demanding more information. They're reading Bundy

ads in *Better Homes & Gardens* and *American Home*. They're sending in a landslide of coupons requesting literature—and names of builders and architects handling Bundyweld Ceiling Radiant Heating. Many of these coupons come from prospects in your locality.

Send the coupon for details on Bundyweld Ceiling Radiant Heating. It may be the most important step you'll take in years.

Radiant Heating Division  
**BUNDY TUBING COMPANY**  
Detroit 14, Michigan



SIZES UP  
TO 3/4" O.D.

### Key to Low Cost

Bundyweld is the only tubing double-walled from a single strip, copper-brazed through 360° of wall contact. It's leak-proof, thinner walled, yet stronger. It transmits heat quickly, has high bursting strength. It saves on material costs and installation time.

Standard 20' or 24' lengths of Bundyweld are easily formed into coils in shop or on job site. Expanded ends (furnished when specified) are quickly soldered into leakproof union. Joined, lightweight coils are easily mounted onto ceiling, quickly plastered over.

SEND FOR  
**FREE** »  
**LITERATURE!**



Bundyweld  
Ceiling Radiant Heating

→ Radiant Heating Division, Dept. AR-1052  
Bundy Tubing Company, Detroit 14, Mich.

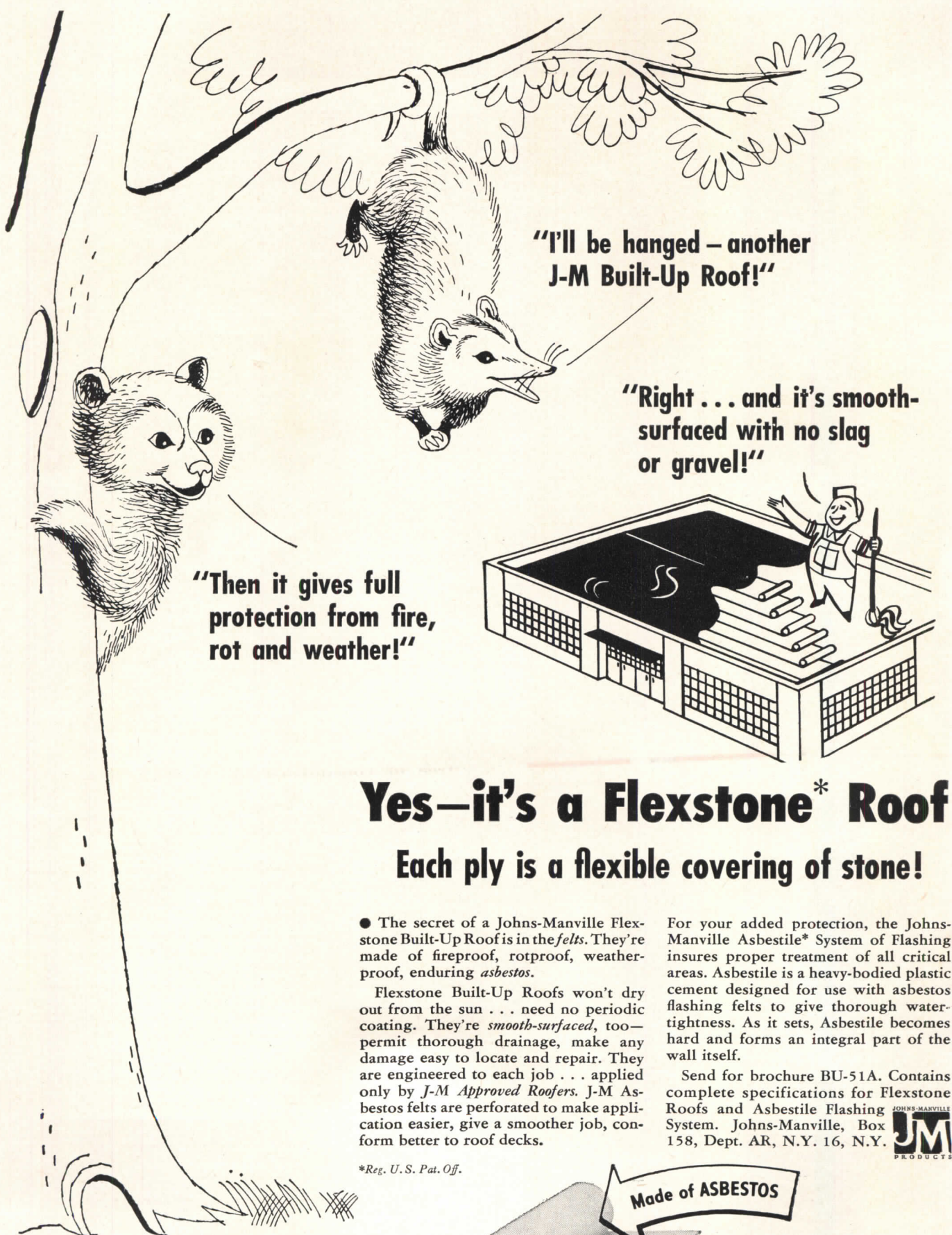
- Send free 20-page nontechnical brochure explaining Bundyweld Ceiling Radiant Heating.
- Send Bundy technical radiant heating pamphlet.

Name \_\_\_\_\_ Title \_\_\_\_\_

Company \_\_\_\_\_

Address \_\_\_\_\_

City \_\_\_\_\_ Zone \_\_\_\_\_ State \_\_\_\_\_



"I'll be hanged - another J-M Built-Up Roof!"

"Right . . . and it's smooth-surfaced with no slag or gravel!"

"Then it gives full protection from fire, rot and weather!"

## Yes—it's a Flexstone\* Roof

Each ply is a flexible covering of stone!

● The secret of a Johns-Manville Flexstone Built-Up Roof is in the felts. They're made of fireproof, rotproof, weatherproof, enduring *asbestos*. Flexstone Built-Up Roofs won't dry out from the sun . . . need no periodic coating. They're *smooth-surfaced*, too—permit thorough drainage, make any damage easy to locate and repair. They are engineered to each job . . . applied only by *J-M Approved Roofers*. J-M Asbestos felts are perforated to make application easier, give a smoother job, conform better to roof decks.

For your added protection, the Johns-Manville Asbestile\* System of Flashing insures proper treatment of all critical areas. Asbestile is a heavy-bodied plastic cement designed for use with asbestos flashing felts to give thorough watertightness. As it sets, Asbestile becomes hard and forms an integral part of the wall itself. Send for brochure BU-51A. Contains complete specifications for Flexstone Roofs and Asbestile Flashing System. Johns-Manville, Box 158, Dept. AR, N.Y. 16, N.Y.



\*Reg. U. S. Pat. Off.

Made of ASBESTOS

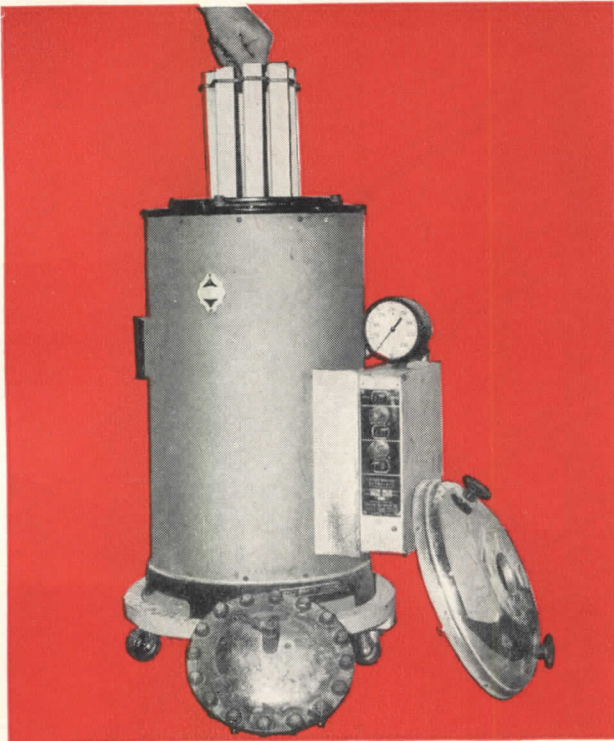
# Johns-Manville FLEXSTONE\* Built-Up Roofs

ASBESTOS CORRUGATED TRANSITE\* • ACOUSTICAL CEILINGS

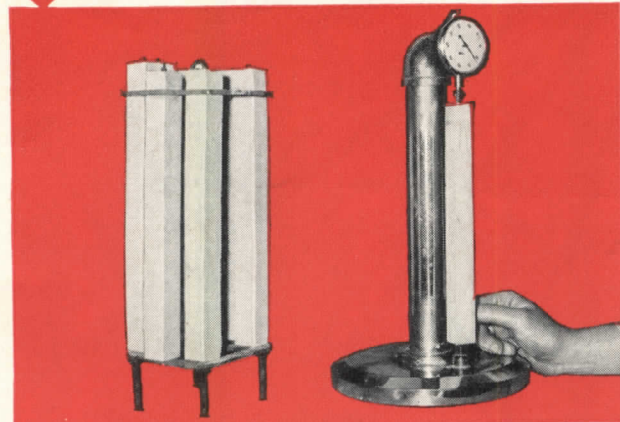
DECORATIVE FLOORS • MOVABLE WALLS • ETC.



# BRIXMENT MEETS AUTOCLAVE TEST!



The autoclave test requires the use of a high pressure steam chest (above). Masonry cement bars approximately 1" x 1" x 10" are exposed to 295 lbs. steam pressure, 420° F., for 3 hours. Measurements of the bars are made before and after test as shown below.



Below: Bars of Brixment, and of Portland cement and a lime which does not meet the autoclave test. The expansion of the Portland cement and lime bar, after autoclaving, is quite evident.

- B—Brixment, not autoclaved.
- B-a—Brixment, autoclaved.
- PL—Cement and lime (1 to 1) not autoclaved.
- PL-a—Cement and lime (1 to 1) autoclaved.

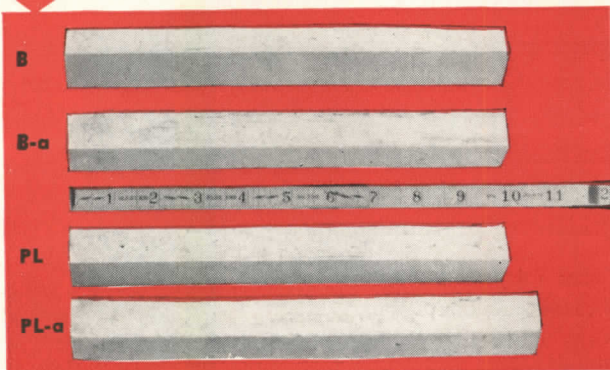
At its meeting in June, the A.S.T.M. Sponsoring Committee on Masonry Cement recommended a new specification requirement for masonry cement — an autoclave test for soundness.

Sound mortar is essential for strong durable brickwork. To be sound, mortar must be free of constituents which may cause abnormal expansion after long exposure to weather.

Unsoundness in mortar material is readily detected by the autoclave test. This severe test rapidly accelerates the chemical reaction of mortar materials, and the slightest unsoundness is immediately revealed by excessive expansion.

Brixment more than meets the autoclave test. Therefore when Brixment is used, sound mortar and strong, durable brickwork are assured.

Louisville Cement Company, Incorporated  
Louisville 2, Kentucky

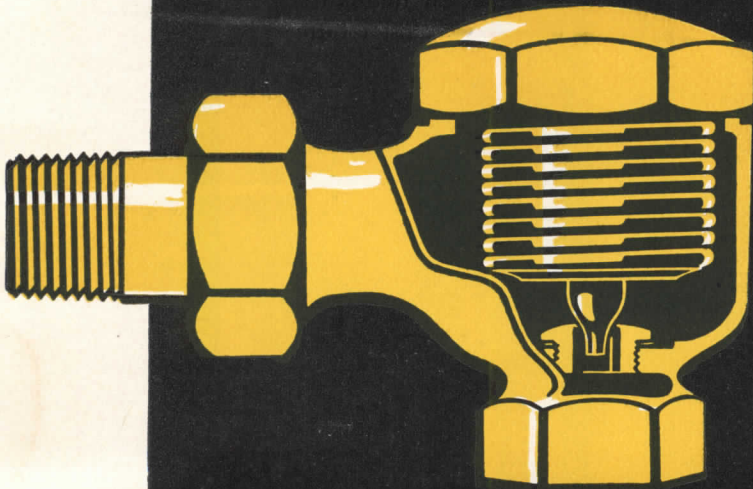




**SPIDER WEB OF STEEL**—This interesting worm's-eye photograph shows the steel framework for the dome section of a new three-story building for the Ford Motor Co. The new structure, a carefully planned engineering building, is nearing completion at Dearborn, Mich. The large dome is one story in height. It has a diameter of approximately 100 ft. This portion of the building is to be faced with brick, with aluminum sash and trim. Used in the steel framework for the dome, and also for its companion structure, were some 250 tons of Bethlehem Structural Shapes.

Owner: Ford Motor Co., Detroit • Architects and Engineers: Voorhees, Walker, Foley and Smith, New York  
Contractors: Bryant and Detwiler, Detroit • Steel Fabricator and Erector: Whitehead & Kales Company, Detroit





## WHY?

### WHY IMPORTANT?

... because more thermostatic steam traps are used in heating systems than any other type. The efficient operation of the heating system depends upon the selection of traps which will perform satisfactorily over a long period with a minimum of maintenance.

### WHY DO ARCHITECTS AND ENGINEERS SPECIFY SARCO?

... because from experience they know that Sarco Thermostatic steam traps operate to the client's satisfaction.

### WHY ARE SARCO TRAPS SUPERIOR?

... because of continuous laboratory research, rigid control of raw materials, master craftsmanship, careful inspection of component parts — all of which are manufactured in the Sarco plant . . . because each trap, before shipment, is tested under actual working conditions.

### WHY DO CONTRACTORS PREFER SARCO?

... because they pay no premium for Sarco quality and performance . . . because they know that the first cost is the only cost. The *complete* Sarco line provides them with a single, dependable and reliable source of steam and hot water heating specialties and industrial controls described in the *Sarco heating bulletins*.

**SARCO** saves steam

sarco quality assures satisfaction

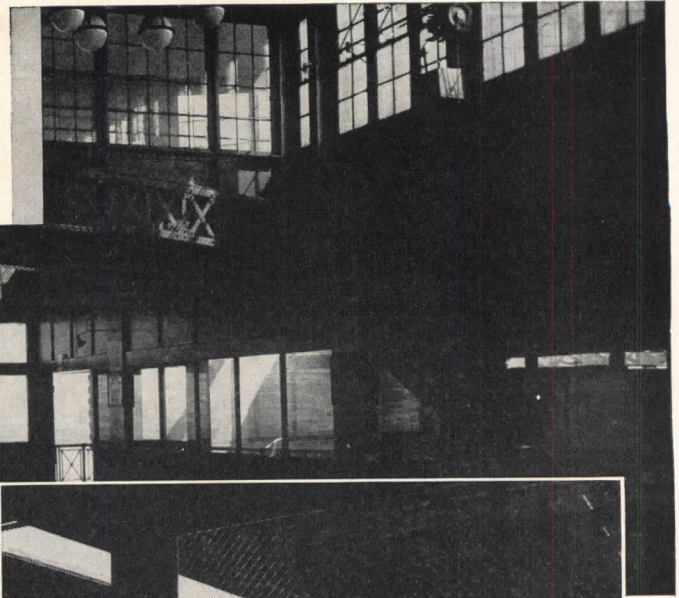
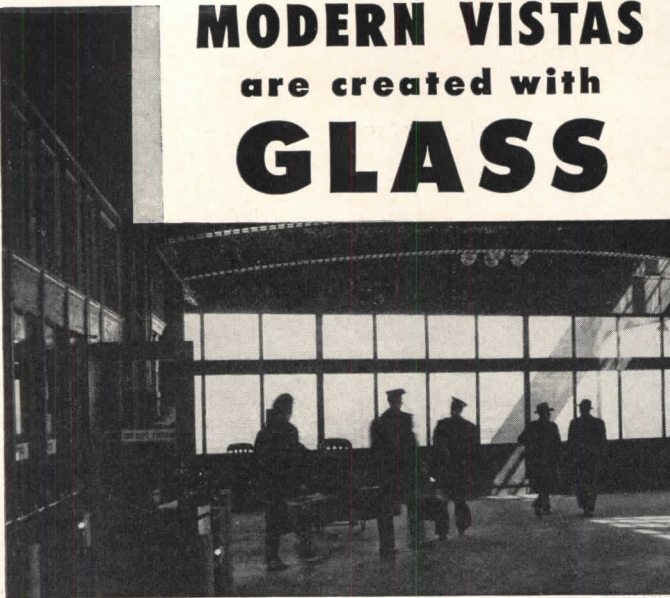
#### SARCO COMPANY, INC.

Empire State Bldg., New York 1, N.Y.

REPRESENTED IN PRINCIPAL CITIES

Sarco Canada Ltd., Toronto 8, Ont.

# MODERN VISTAS are created with **GLASS**



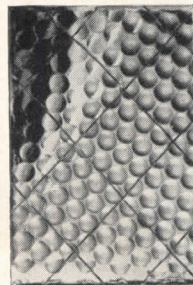
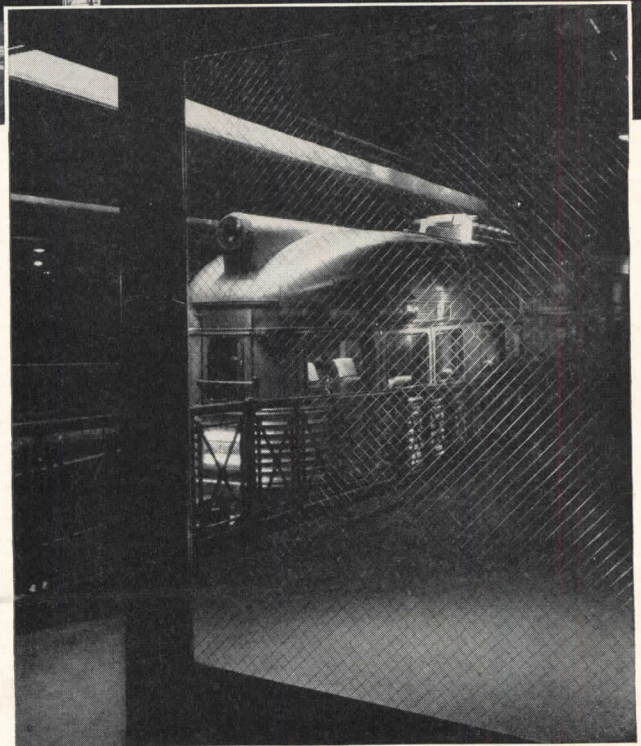
## Misco Polished Wire Glass Combines Beauty, Utility and Safety in a Strikingly New, Modern Pattern

As advanced in design as the sleek California Zephyr seen through it, Polished Misco Wire Glass\* is used extensively throughout Chicago's famous Union Station to protect its thousands of travelers daily. This rugged glass, so modern in design, separates lobby and loading platforms... withstands the eager pressure of waiting crowds, rumbling vibrations of heavy traffic, and serves as an inconspicuous but effective fire wall against any conflagration in the area.

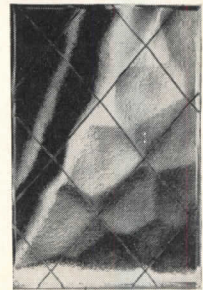
For over half a century, architects and engineers have specified Mississippi Wire Glass as a dependable defense against the spread of fire. It was the original solid wire glass on which the Underwriter's Standard was based in 1899. Mississippi Wire Glass affords constant protection at minimum cost in windows, doors, transoms, skylights, partitions — wherever fire or breakage protection is required. And the handsome new Polished Misco Wire Glass actually enhances any installation with its highly interesting design.

**Specify Polished Misco Wire Glass when building or remodeling. Available through leading distributors of quality glass. Where full vision is not required, obscure Mississippi Wire Glass is available with either Hexagonal or Misco Wire Netting.**

\*Approved Fire Retardant No. 32



HAMMERED MISCO WIRE



SMOOTH ROUGH MISCO WIRE

Wire Glass by Mississippi, highest achievement of the rolled glass manufacturer's art, combines the utmost in protection with modern beauty—helps hold fires within bounds of origin.

**MISSISSIPPI** *Glass* **COMPANY**

88 ANGELICA ST. SAINT LOUIS 7, MO.  
NEW YORK • CHICAGO • FULLERTON, CALIF.



Listed in Sweet's  
Catalog.

Send today for  
Catalog No. 52. Free  
samples on request.



WORLD'S LARGEST MANUFACTURER OF ROLLED, FIGURED AND WIRED GLASS

# STOP RUST!

with

# RUST-OLEUM®

**The Practical Coating!  
Beautifies As It Protects!  
In All Colors, Aluminum and White!**

Cut maintenance costs. Apply RUST-OLEUM directly over rusted surfaces without removing all the rust! Just wirebrush and use sharp scrapers to remove rust scale and loose particles, then apply by brush, dip, or spray. Costly sandblasting and chemical precleaning are not usually required. Specify RUST-OLEUM for every rustable metal surface. Prompt delivery from Industrial Distributors in principal cities.

### RUST-OLEUM CORPORATION

2515 Oakton Street, Evanston, Illinois



**FREE SURVEY:** A RUST-OLEUM specialist will gladly survey your rust problems. He'll make specific tests and recommendations. No cost or obligation. See Sweets for complete catalog and nearest RUST-OLEUM distributor, or write for literature on your company letterhead.

*Protects Tanks, Girders  
Fences, Stacks, Metal Sash,  
Roofs, Buildings, Marine  
and Railroad Facilities*

Stopping Rust with  
RUST-OLEUM  
769 D.P. Red Primer

Look for this label. Be sure  
it's genuine RUST-OLEUM!

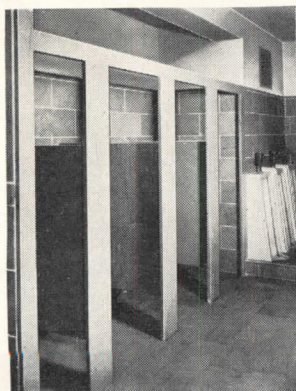
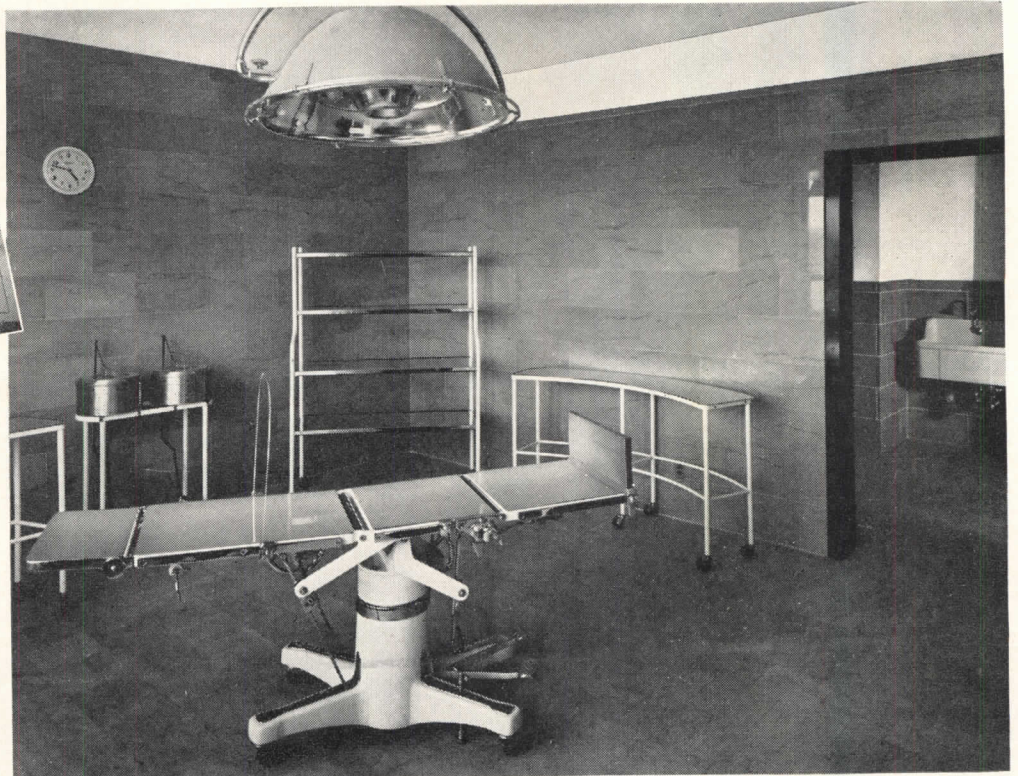
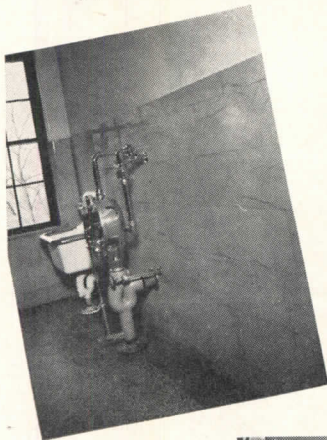
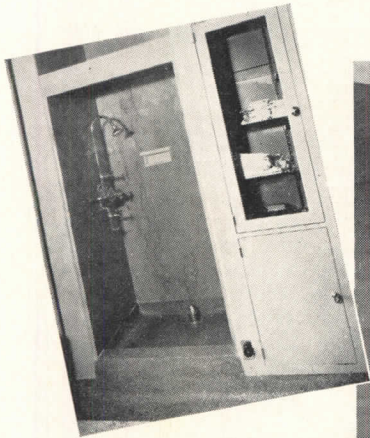


**CLIP THIS TO YOUR LETTERHEAD  
MAIL TO: RUST-OLEUM CORPORATION  
2515 Oakton Street • Evanston, Illinois**

- Have a Qualified Representative Call
- Full Details on Free Survey
- Complete Literature
- Nearest RUST-OLEUM Source

# marble

the Doctor's *first* assistant!



In every part of the Hospital, Cleanliness must be above suspicion—a Cleanliness in operating rooms, laboratories, wards, corridors, toilets, kitchens and reception lobbies, that extends beyond mere appearance and approaches the standards of sterilization established for bandages and surgical instruments.

Marble meets fully all such demands. It is the easiest and cheapest of building materials to maintain or keep clean.

*New Brochure on Low Maintenance Costs Available Free.  
Write:*



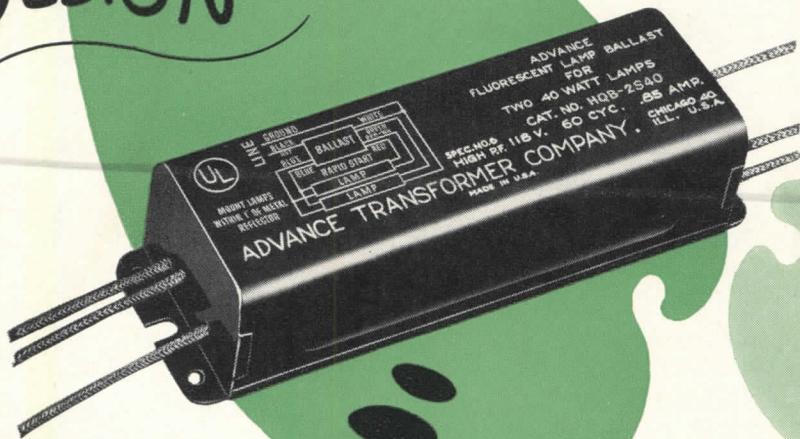
**Marble Institute  
of America, inc.**

108 FORSTER AVENUE, MOUNT VERNON, N. Y.

To meet the **ADVANCE** in latest  
fluorescent **LAMP** developments...

**NEW**  
*Rapid  
Start*  
**Ballasts**

*BLENDED  
DESIGN\**



Made by the  
**WORLD'S LARGEST MANUFACTURER**  
devoted **EXCLUSIVELY** to the  
engineering and design of  
**FLUORESCENT BALLASTS**

\* *Blended to the design of Rapid Start  
Fluorescent Lamps*

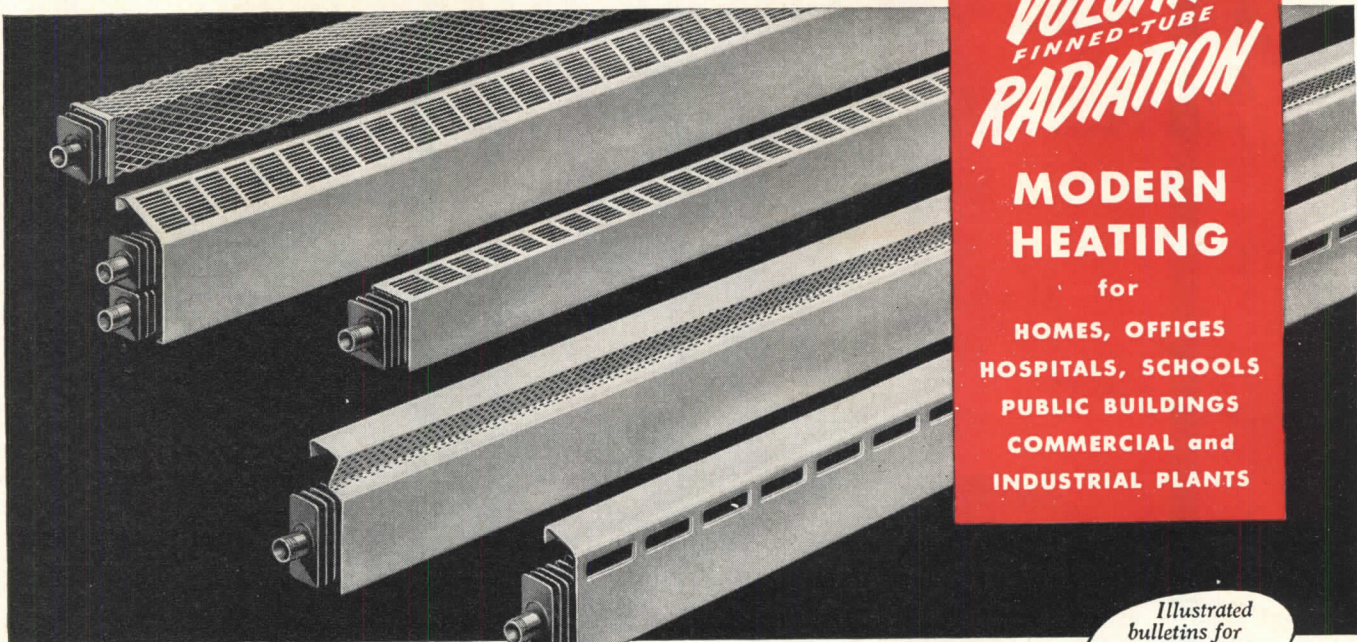
**ADVANCE  
TRANSFORMER  
CO.**

- LQ-140 LOW POWER FACTOR (single lamp)
- HQ-140 HIGH POWER FACTOR (single lamp)
- HQ-2S40 HIGH POWER FACTOR (two lamp)
- HQB-2S40 HIGH POWER FACTOR (two lamp) BRICK

*The Best  
Ballast  
Buy*

CABLE ADDRESS:  
ADTRANS

1122 W. CATALPA AVE., CHICAGO 40, ILL., U.S.A.



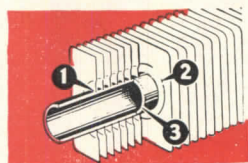
**VULCAN**  
FINNED-TUBE  
**RADIATION**

**MODERN  
HEATING**

for

**HOMES, OFFICES  
HOSPITALS, SCHOOLS  
PUBLIC BUILDINGS  
COMMERCIAL and  
INDUSTRIAL PLANTS**

The **VALUE** in **VULCAN** . . .



**1. FINS IMBEDDED** for best heat transfer (patented). **2. FINS OFF-SET** for rigidity and permanence. **3. PRESSURE TUBE:** best steel pressure tube or Type K water tube.

See Sweets Architectural File

The Vulcan line is the style line in fin-tube radiation. Attractive, easy-to-install covers, shown above, designed for both commercial and residential installations.

Illustrated  
bulletins for  
drawing board  
reference



The **VULCAN RADIATOR Co.**  18 FRANCIS AVENUE  
HARTFORD 2, CONNECTICUT

## The New Statler's

1275 watertight  
bath tub installations . . .

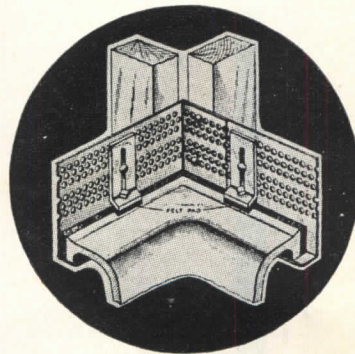


Statler Center, Los Angeles, California  
Holabird, Root & Burgee, Architects

William B. Tabler, Associate Architect  
Mehring & Hanson, Los Angeles, Plumbing Contractors

## Feature LUCKE

LEAKPROOF  
BATH TUB HANGERS



Check these Advantages . . .

- **No Unsightly Cracks** occur at tub rim with a Lucke Bath Tub Hanger installation. Sagging is impossible.
- **No Water Damage** to walls, floors, ceilings and decorations beneath the bath when you specify Lucke Hangers.
- **No Unsanitary Conditions** if a Lucke Hanger is used. Dirt, grease, germs or soapy water cannot lodge and drip behind tub, causing unpleasant odors or rotting joints.
- **No Repair Expense** is caused due to open cracks and water damage. Lucke Hangers prevent these troubles.



Sold by Leading Plumbing  
Supply Houses

MANUFACTURED BY

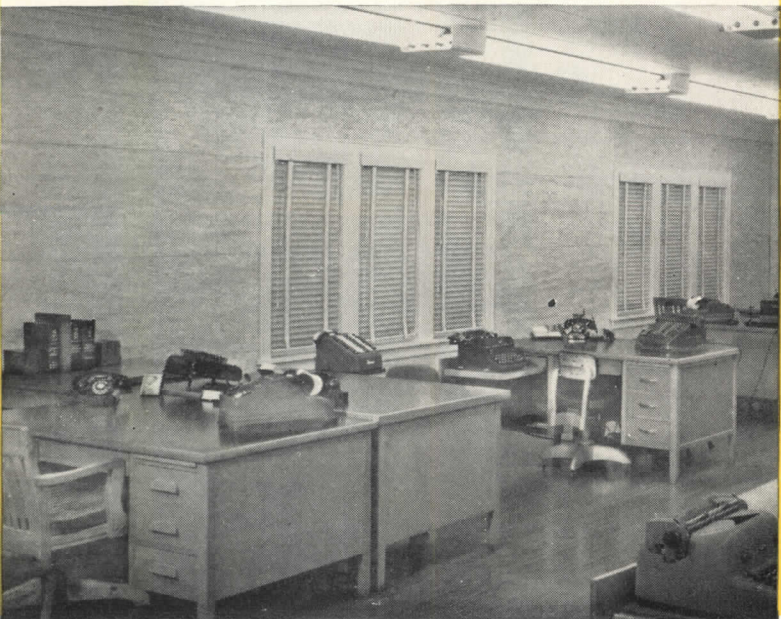
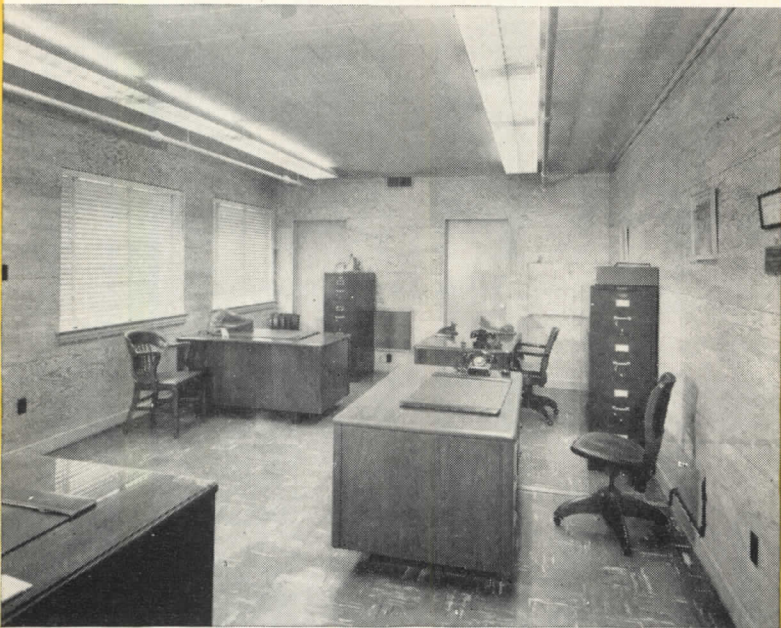
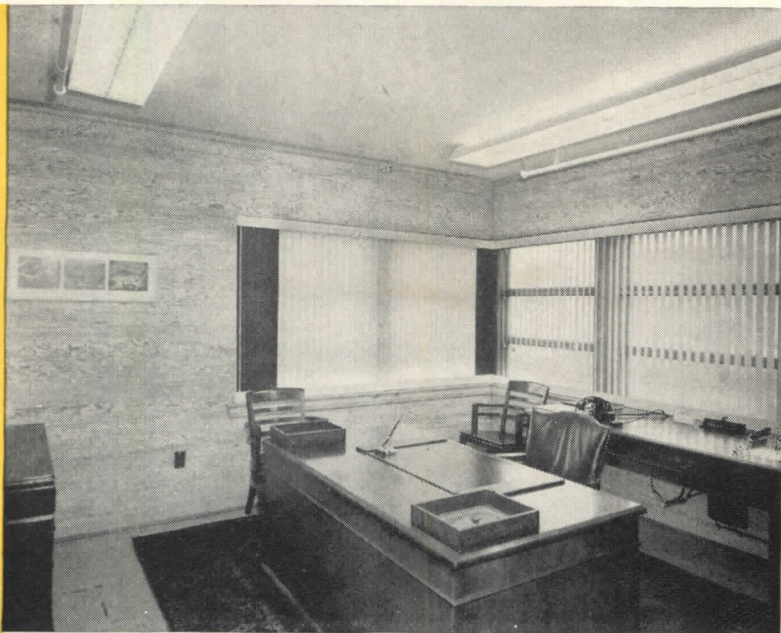
**W. B. LUCKE, Inc.**

Wilmette

Illinois







**you are looking at  
offices done in...**



APMI's decorative plywood is setting a new style in offices from coast to coast. This three dimension Douglas fir plywood is beautiful, practical and versatile. In natural warm wood tones, or painted in soft pastels, it is pleasing to the eye and easy on the pocketbook.

*Sea Swirl* comes in 4'x8' panels, 5/16" thickness (other sizes on special order). Perfect for remodeling and new construction. Exterior and interior types are sold at APMI sales warehouses exclusively. See the one nearest you, or write for booklet.



## **ASSOCIATED Plywood Mills, Inc.**

**General Offices: Eugene, Oregon**

Mills at Eugene and Willamina, producing *Sea Swirl*; Douglas fir plywood; mahogany-faced plywood; *Plyron*; Handy Panels; vertical grain plywood.

### **BRANCH SALES WAREHOUSES:**

4268 Utah Street, St. Louis, Missouri  
 4814 Bengal Street, Dallas, Texas  
 4003 Coyle Street, Houston, Texas  
 1026 Jay Street, Charlotte, North Carolina  
 111 Welborn St., Greenville, South Carolina  
 925 Toland Street, San Francisco, California  
 Eugene, Oregon

### **SALES OFFICES:**

31 State Street, Boston, Massachusetts  
 First Trust Building, Pasadena, California



nothing protects  
against sudden  
shower scalds

like

**SAFETYMIX**



GIVE THEM THIS EXTRA SHOWER SAFETY  
... AT NO EXTRA COST!

**SHOWER SAFETY**

... No scalds ... no chills. Protects against both sudden scalds and chills. Even with pressure fluctuations up to 85%, Safetymix keeps shower temperature constant. Automatically shuts down flow when either hot or cold water fails.

**LIFETIME QUALITY**

... Only one moving part. Designed and manufactured by engineers and approved by architects, pressure-actuated Safetymix is the most rugged shower control valve made. Only Safetymix has the patented Flow Control Spindle with but one moving part to control all valve functions.

**FREE FROM MAINTENANCE**

... Easy to fix as a faucet. Safetymix is designed with self-cleaning action to prevent clogging. Saves water. All parts accessible from front.

**COSTS NO MORE**

Because it costs no more than ordinary shower valves and is guaranteed to be entirely as represented, architects specify Safetymix and engineers recommend it. Safetymix gives the extra safety and satisfaction that builds better reputations. Safetymix is used in thousands of schools, colleges, hotels, industrial plants, institutions and better homes from coast to coast.

See Sweets Architectural File or your Domestic Engineering Catalog.

Send for bulletin and prices.

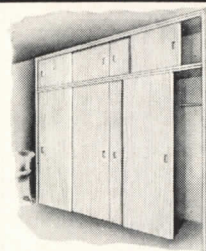
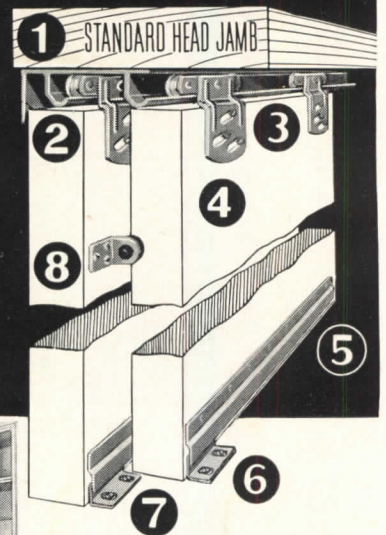


# Here's Why

**LEADING ARCHITECTS AND BUILDERS**

use and recommend

**Sterling**  
600 SERIES  
**SLIDING DOOR HARDWARE**



**Saves Time! Saves Money!**

**Easy to Install and Adjust!**

- 1** USE STANDARD DOOR FRAME. No special header construction needed. No grooving!
- 2** APRON CONCEALS HANGERS AND TRACK. May be painted if desired. No extra trim necessary.
- 3** ONLY ONE INCH HEADROOM REQUIRED. No need for extra headroom for hardware.
- 4** ADJUSTABLE HANGERS. Slotted screw holes make it easy to plumb door with jamb.
- 5** GUIDE STRIPS eliminate troublesome grooving of doors. Not visible from the outside.
- 6** DOOR GUIDES can be installed after doors are hung. Slotted screw holes permit easy adjustment.
- 7** NO TRACK ON THE FLOOR to catch dust and dirt ... floor is clear and clean at all times.
- 8** DOOR STOP keeps flush pull on rear door always accessible. Fingers can't get pinched.

Write for Catalog on Sterling line of Sliding Door Hardware for wardrobes, pocket doors, side doors in home garages and other Sterling products.



*Nationally Advertised*

★ See our Catalog in SWEET'S Architectural File 18d/ST and Builders' File 4e/ST

★ Visit our Display at ... The Architects Samples Corp., New York City



**STERLING HARDWARE MANUFACTURING CO.**  
2345 W. Nelson Street Chicago 18, Illinois



stainless  
is  
valuable  
these days

Since stainless *is* so valuable, plan to make it go further.

Specifically, this means selecting a grade or finish of stainless that, besides doing the job adequately, will be in less demand than one you have been figuring on.

Here is where Crucible can help you out. The matchless experience of our metallurgists and stainless fabricating specialists can help you get the most out of your share of stainless.

Call upon us to help you.

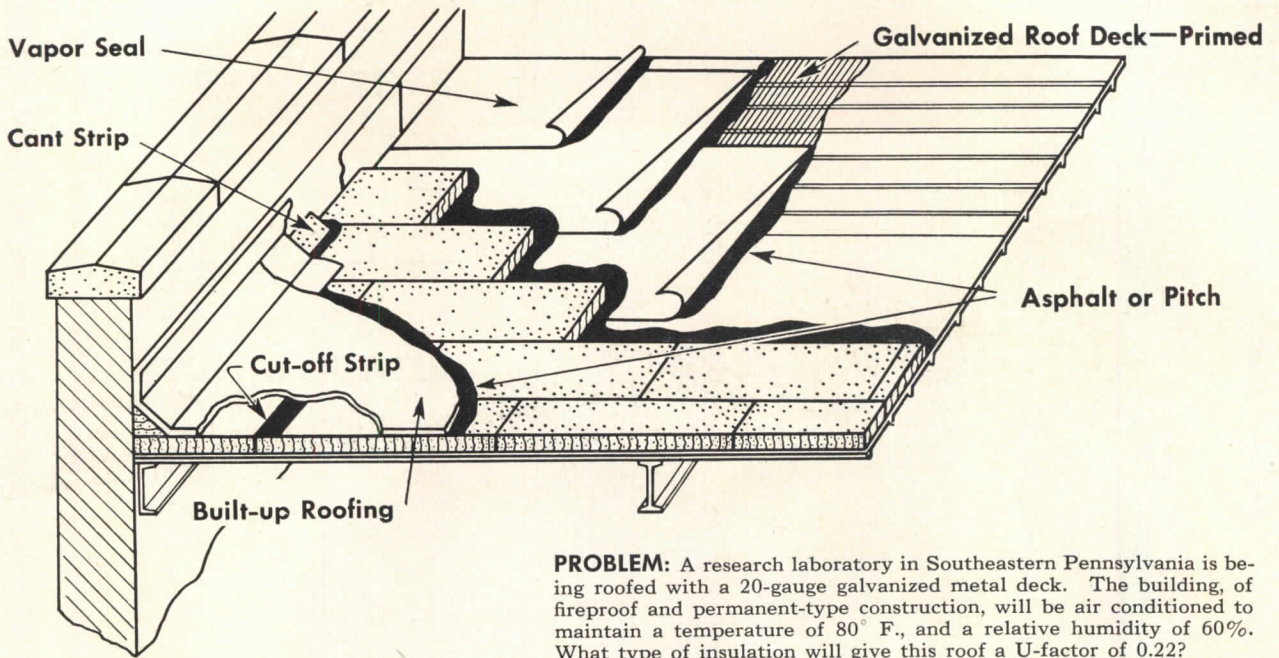
**CRUCIBLE**

first name in special purpose steels

52 years of *Fine* steelmaking

**STAINLESS STEEL**

CRUCIBLE STEEL COMPANY OF AMERICA, GENERAL SALES OFFICES, OLIVER BUILDING, PITTSBURGH, PA.  
REZISTAL STAINLESS • REX HIGH SPEED • TOOL • ALLOY • MACHINERY • SPECIAL PURPOSE STEELS



**PROBLEM:** A research laboratory in Southeastern Pennsylvania is being roofed with a 20-gauge galvanized metal deck. The building, of fireproof and permanent-type construction, will be air conditioned to maintain a temperature of 80° F., and a relative humidity of 60%. What type of insulation will give this roof a U-factor of 0.22?

*Which insulation for this roof?*

**SOLUTION:**

Durability and fire safety guide the choice of roof insulation for this building. The specifications call for a material that is long lasting and will not contribute to the spread of flames. Armstrong's Corkboard meets these requirements. A 1" thickness of corkboard applied over a vapor seal will give the roof the desired U-factor needed to assure low operating cost for the air conditioning.

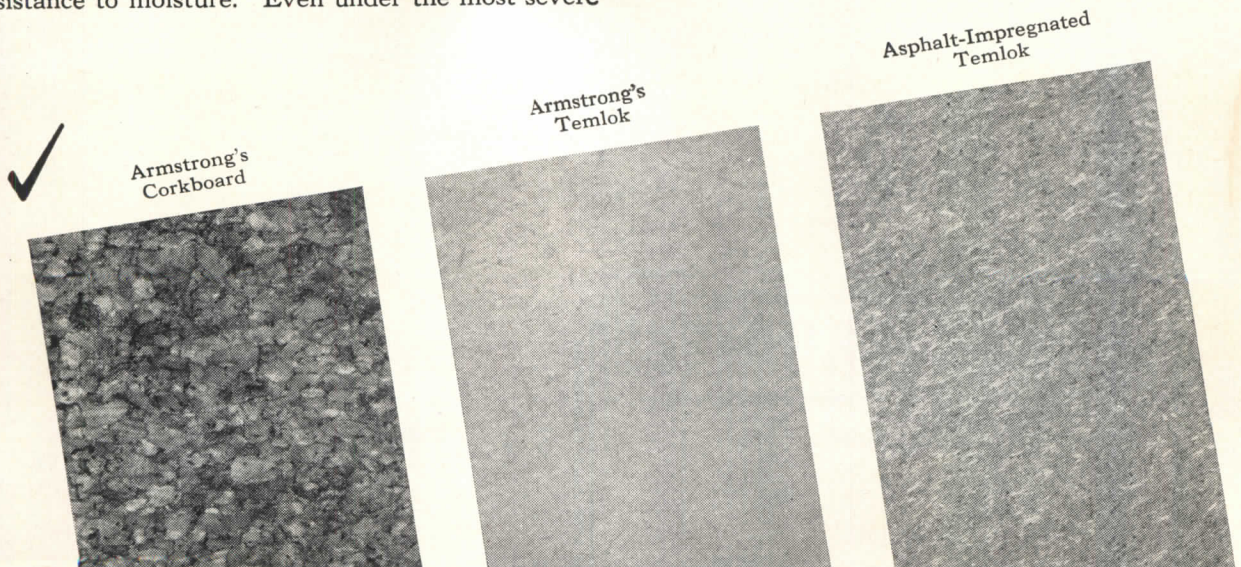
Applied in accordance with Armstrong's application specifications, Armstrong's Corkboard is the standard choice of many architects and engineers, for all types of buildings. Made entirely of pure cork granules, its cellular structure gives Armstrong's Corkboard high insulating efficiency and great resistance to moisture. Even under the most severe

conditions, corkboard will provide trouble-free service for many years.

On low-budget jobs, you may want to specify Armstrong's Temlok®. Available in either regular or asphalt-impregnated forms, it is an efficient, economical fiberboard. For complete information, call your nearest Armstrong Office or write Armstrong Cork Company, 2410 Concord Street, Lancaster, Pennsylvania.



**ARMSTRONG'S  
ROOF INSULATIONS**





A R C H I T E C T U R A L     R E C O R D

## RIO SPORTS CENTER: A PROGRESS REPORT

*Raphael Galvão, Pedro Paulo Bastos, Antonio Dias Carneiro,*

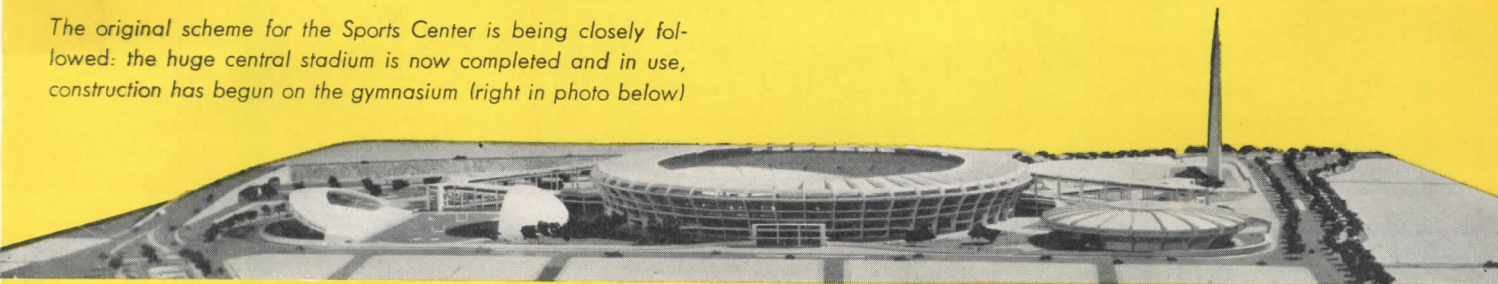
*Orlando Azevedo, Architects*

RIO DE JANEIRO, BRAZIL

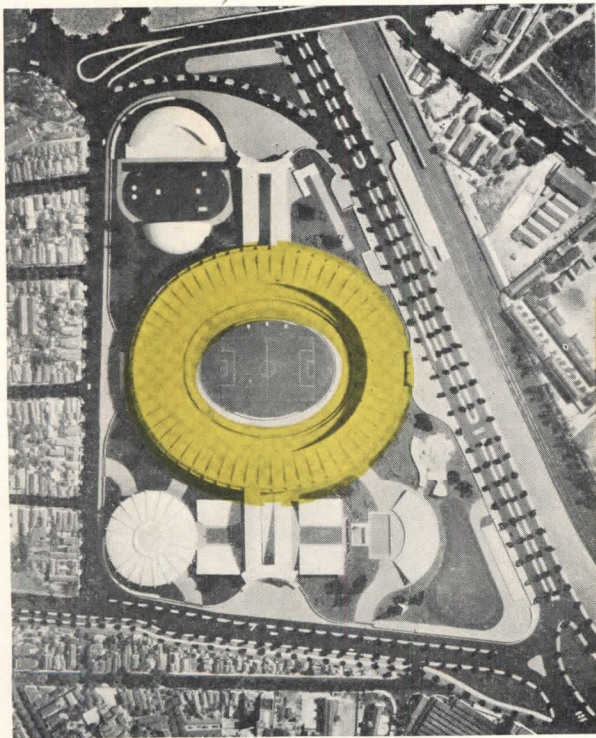
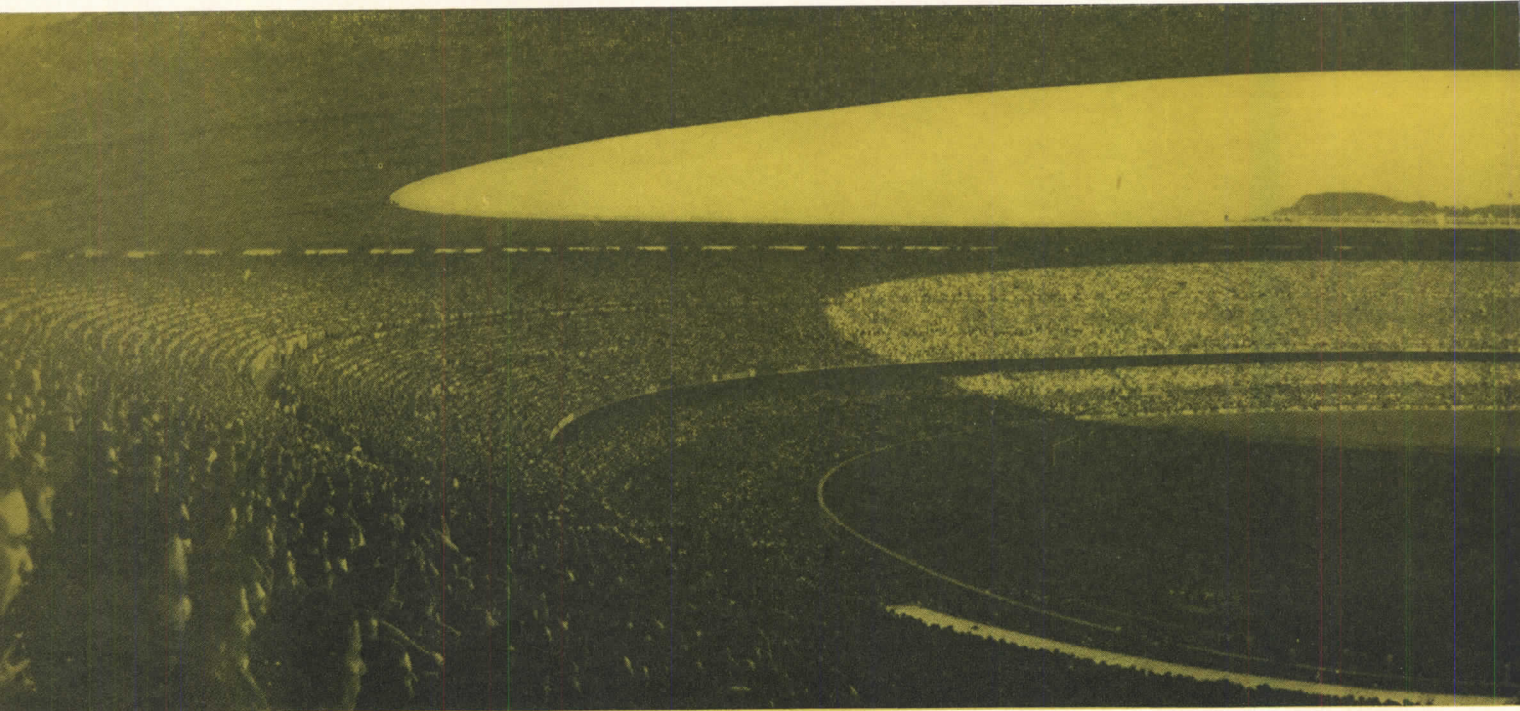
**T**HIS MONUMENTAL PROJECT for a sports center in the heart of Rio enters the second stage of construction with the completion of its enormous 150,000-person capacity stadium, and the beginning of foundation work for the second largest unit, an enclosed gymnasium which will hold 35,000 people.

First presented in the August 1949 issue of ARCHITECTURAL RECORD, the project has been underway since early 1948. When entirely completed, the center will also include a swimming pool, tennis and basketball courts, a velodrome, a rifle range, a music shell, a track field and a children's playground.

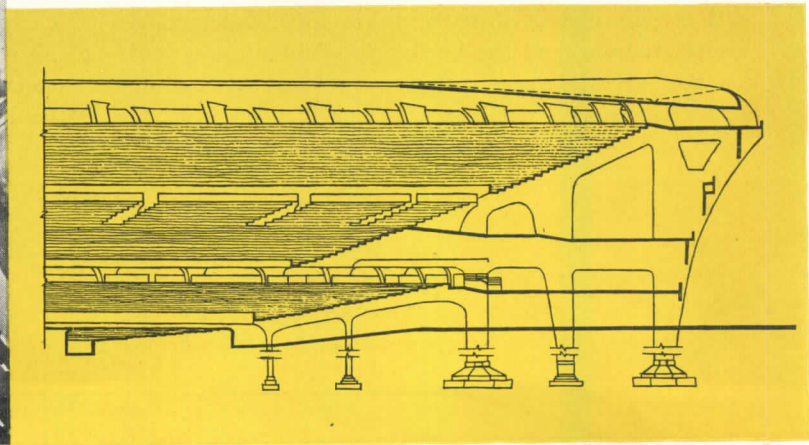
*The original scheme for the Sports Center is being closely followed: the huge central stadium is now completed and in use, construction has begun on the gymnasium (right in photo below)*



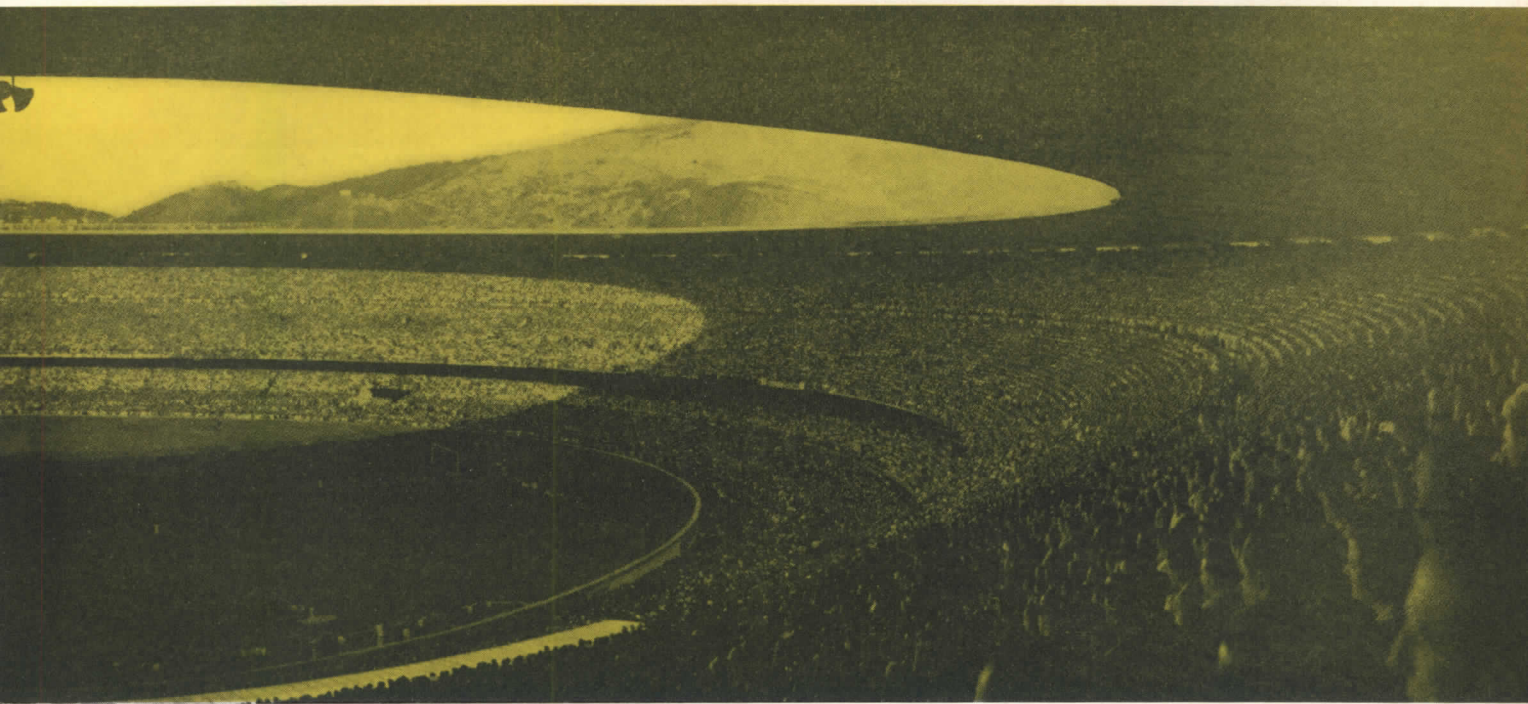
The careful calculations which went into the planning of the stadium have more than proved themselves, now that the structure is in use. Good visibility is provided for each of the 150,000 spectators, ramps are wide enough to empty stadium in 15 minutes. The roof is cantilevered over 98 ft



This first unit of what will eventually be a very complete sports center might be noted, aside from the fact that it has proved to be quite comfortable and convenient, for the lean, pared-down design of its reinforced concrete structure. The countless studies which preceded its construction led to a reliance on proportions



The circular stadium will form the dominating central element of the sports center. Other units will have simple plastic forms suited to their uses. Stadium section (above, right) shows use of several levels for horizontal circulation and for convenient placement of concessions, toilets, athletes' lockers and sleeping quarters, administration and other facilities



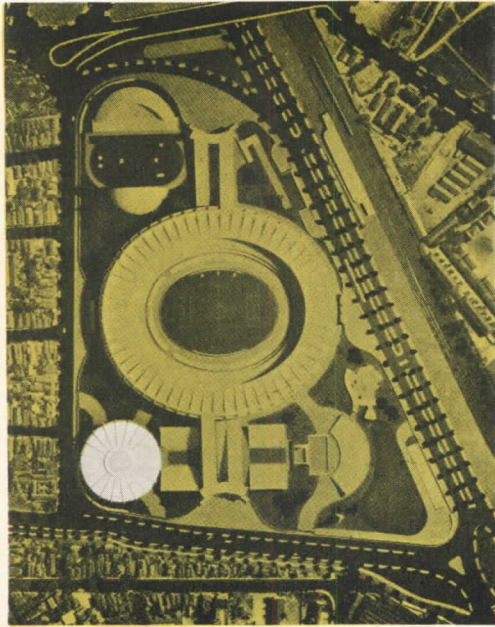
and the repetitive value of the supports to produce a light, elegant, almost festive quality well suited to its purpose. The same approach is being used in the design of each of the projected units, along with studies of their relationships to each other. The project will be completed by Galvão, Bastos and Azevedo, due to the

recent untimely death of Antonio Dias Carneiro, one of the original team of architects.

Structural design for the stadium was the responsibility of Paulo Fragoso, Noronha, Baungart, and Costa, Engineers. Engineering for the remaining structures will be done by the architects.

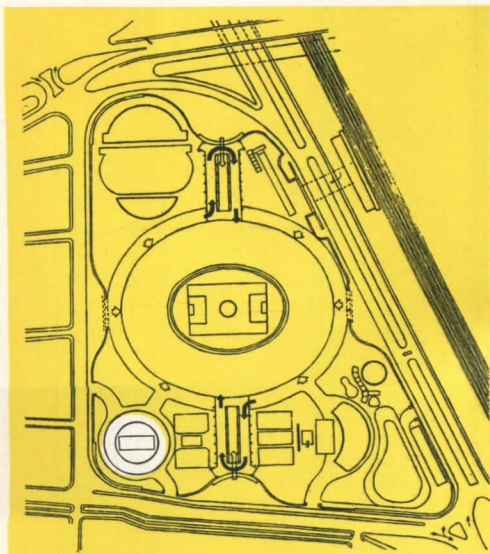
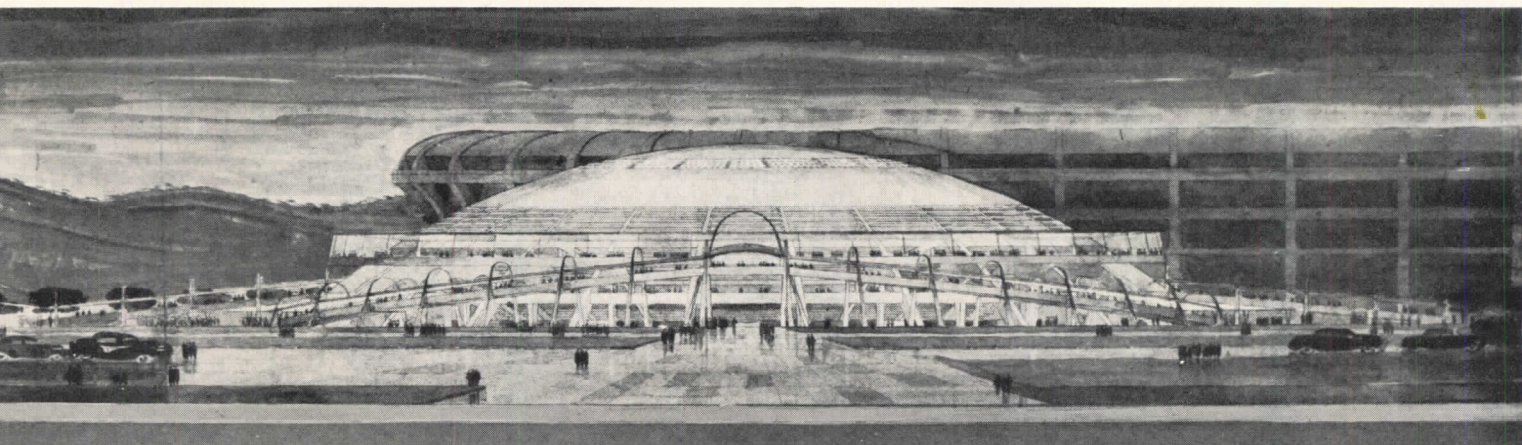


*The stadium is 23 meters high (75.5 ft). Its enormous size is quickly apparent when contrasted with the other buildings in the photo at right*



**Gymnasium for 35,000 Spectators, Second Largest Unit of Sports Center, Is Under Construction**

Although seemingly small by contrast with the enormous stadium it adjoins, the gymnasium for the sports center is actually of considerable size and presented most of the same problems as its big neighbor. Preliminary studies were made using the same structural shapes as the stadium, but as its roof is nearly as high as the stadium—21 meters (68.3 ft)—it was felt that big and little versions of the same scheme would appear distorted placed side by side. The final design harmonizes well with the stadium, but maintains a

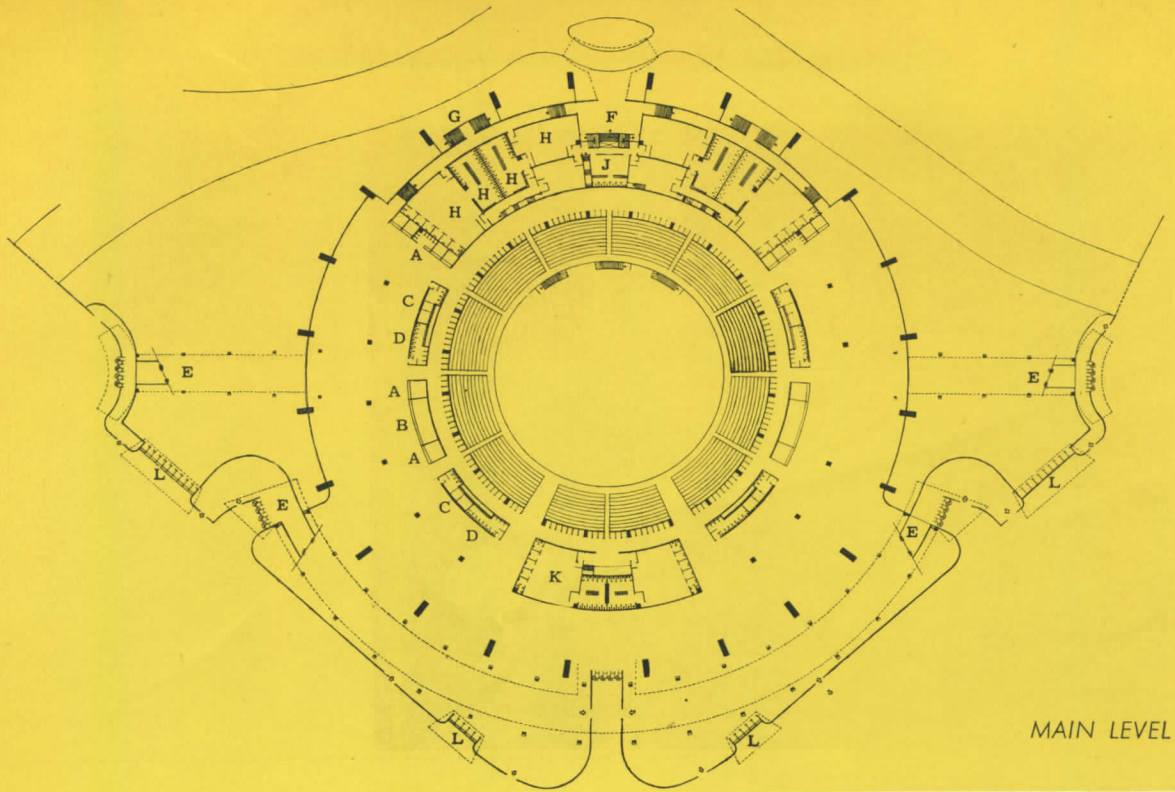


Above: plan of complete center. Track field, band shell, rifle range are at top, ball courts, pool, velodrome below

vigorous individuality of its own. The light sectional dome is balanced on arched ribs and encircled by horizontal passageways and ramps. The latter have a maximum slope of 10 per cent and are supported by thin arches. The entire structure is of reinforced concrete. A heavy monolithic effect was avoided by piercing the dome with utilitarian louvers for natural ventilation, and with glass inserts for daylighting. There is no heating system, or any forced ventilation except for locker rooms and toilets—all of which also have direct light and ventilation.

Provisions for the 35,000 spectators are divided into categories, each with separate entrances. Facilities for athletes and performers are at a lower level, completely apart from those of the spectators. Dressing rooms are connected by subterranean passages to the arena. The main level of the gymnasium is allotted to 114 boxes, with seats for 684, and 4450 reserved seats. A mezzanine has a special section and reception rooms for honor guests. The second level has unreserved benches for 21,220; the third has standing room for 8529.

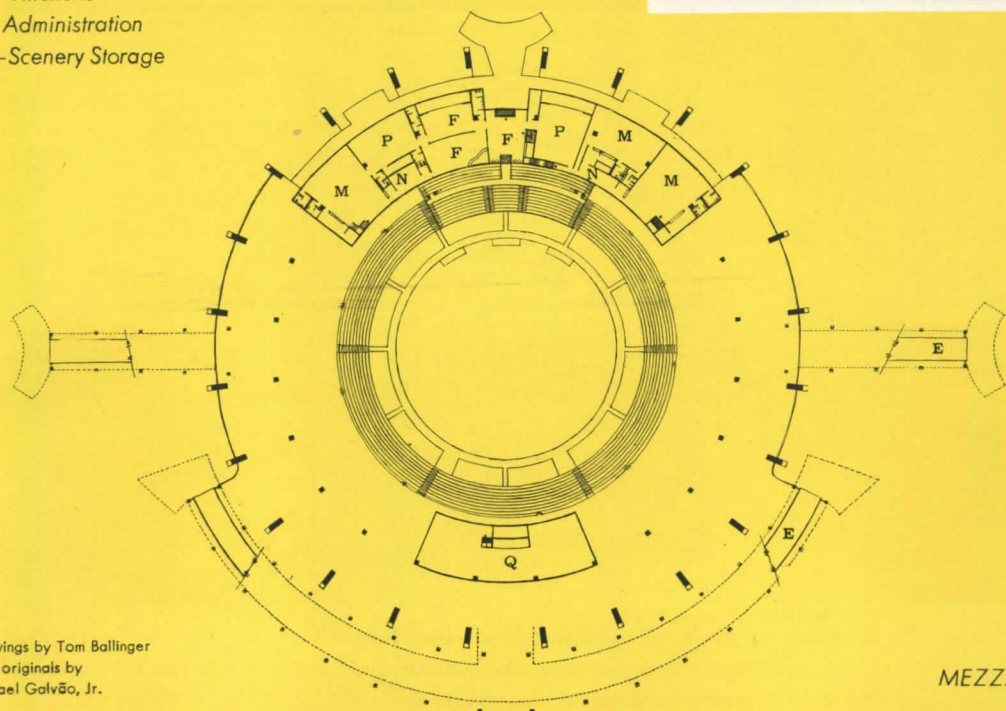
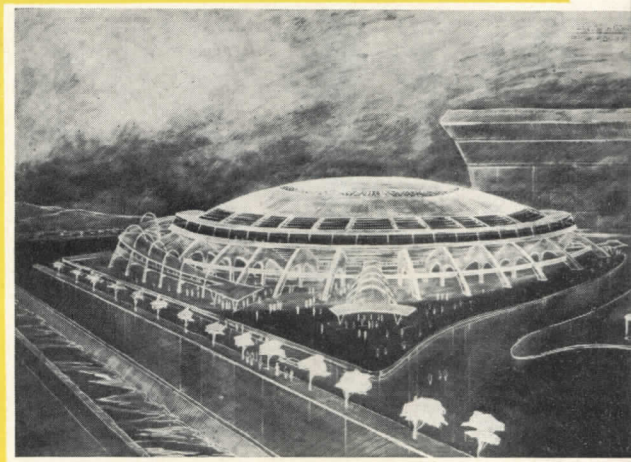




MAIN LEVEL

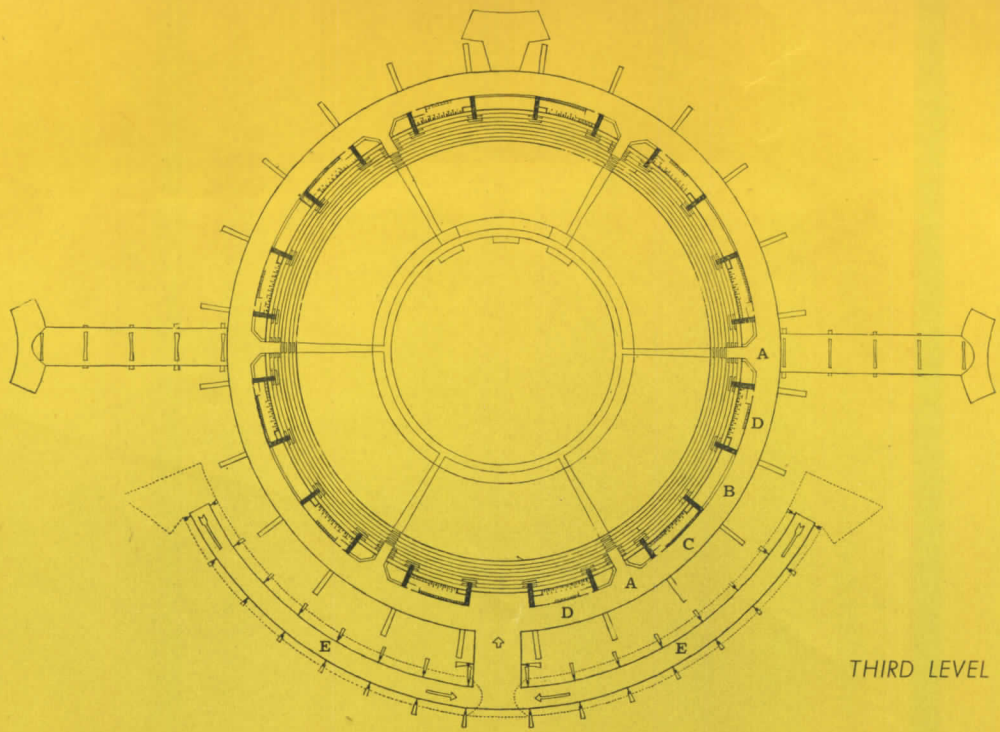
LEGEND

- A—Concessions
- B—Bar
- C—Men
- D—Women
- E—Ramps
- F—Dignitaries
- G—Athletes' Entrance
- H—Athletes' Showers and Lockers
- J—Judges
- K—Artists
- L—Tickets
- M—Restaurants
- N—Kitchens
- P—Administration
- Q—Scenery Storage

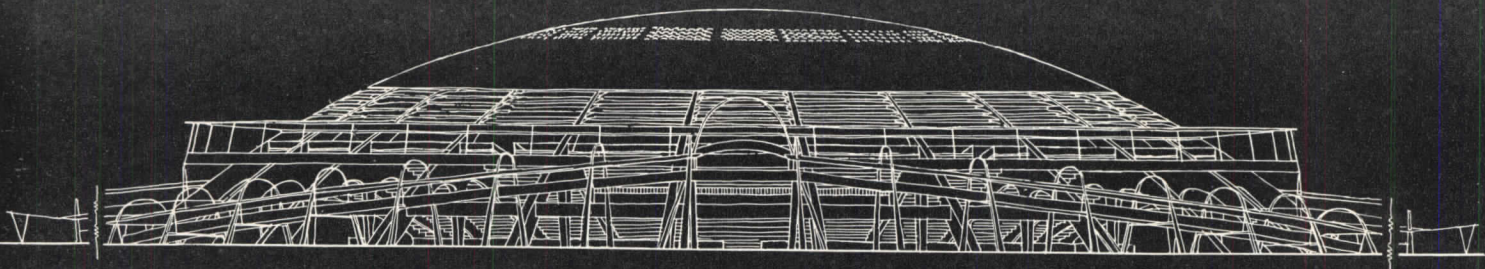


MEZZANINE

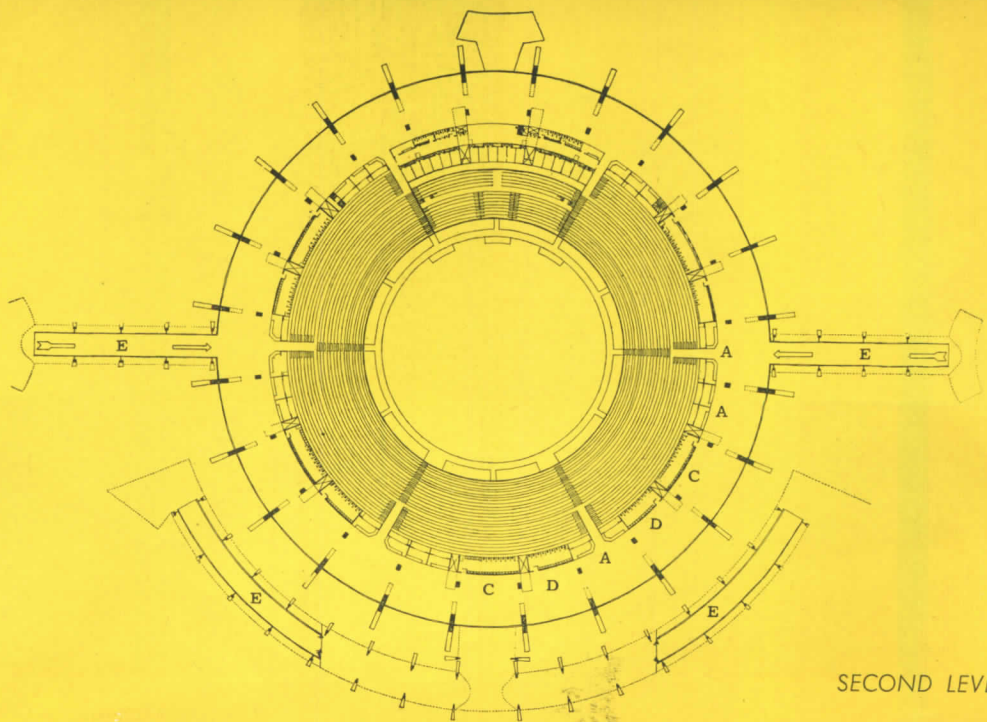
Drawings by Tom Ballinger  
from originals by  
Raphael Galvão, Jr.



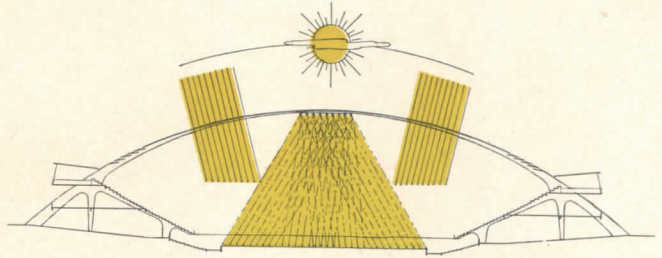
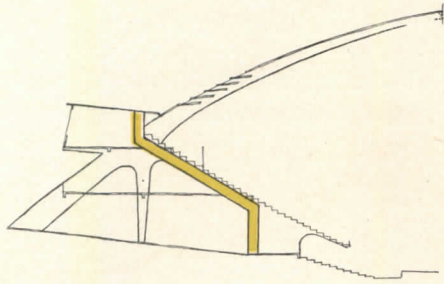
THIRD LEVEL



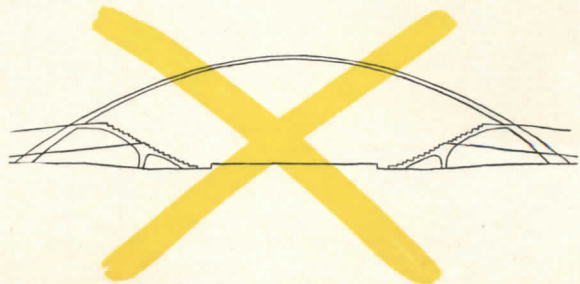
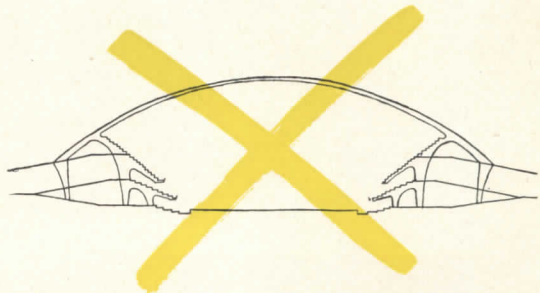
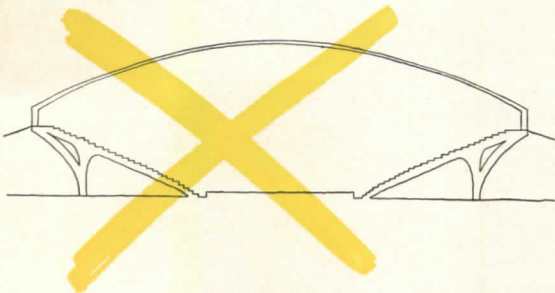
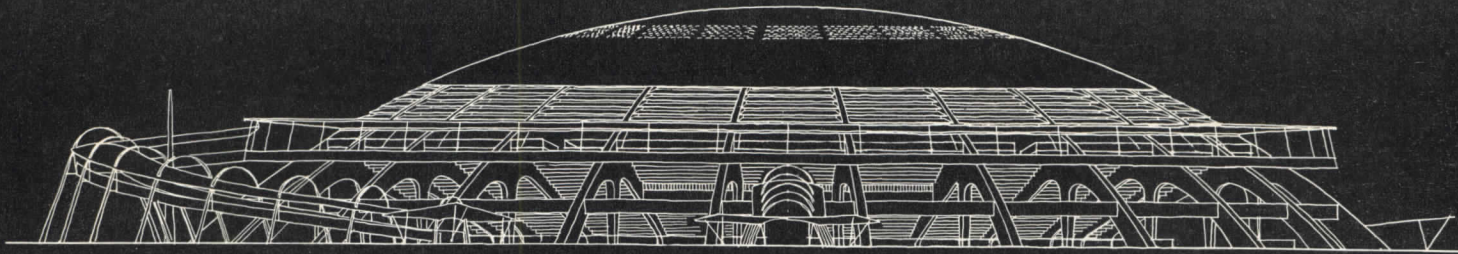
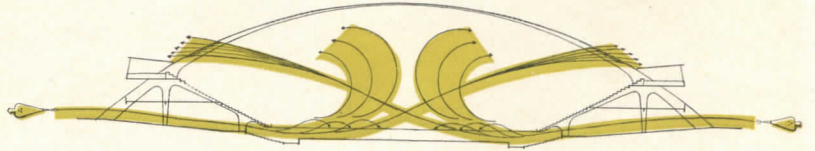
- LEGEND
- A—Concessions
  - B—Bar
  - C—Men
  - D—Women
  - E—Ramps



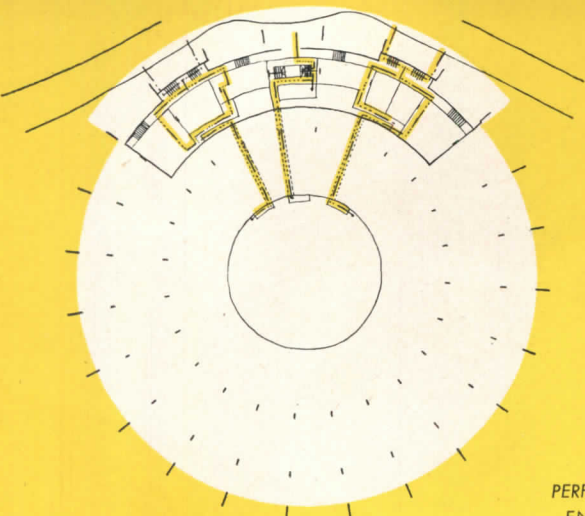
SECOND LEVEL



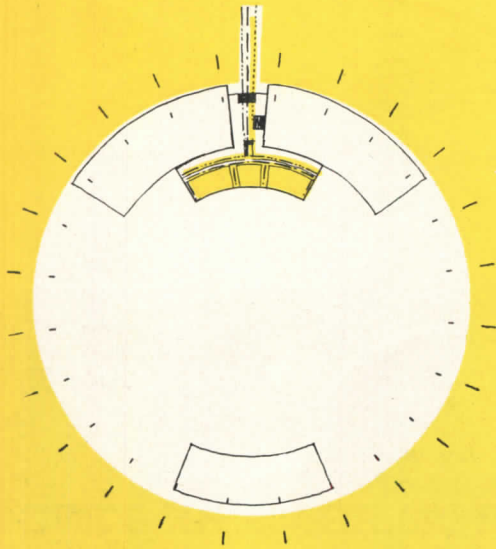
A great number of studies were made to arrive at the structural shape. The three at bottom of page are typical, ranging from an adaptation of the larger stadium to a simple dome. The latter approaches the accepted design, but has insufficient seating area. Glass inserts in concrete shell will provide daylighting (above, right), movable asbestos louvers will control natural ventilation (right). Locker rooms and wash rooms have supplementary ventilation ducts (above)



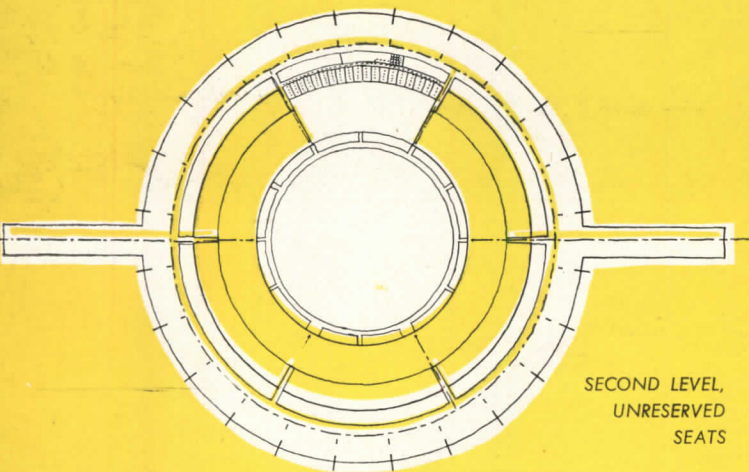
**Circulation patterns for 35,000 people is major planning problem in Gymnasium**



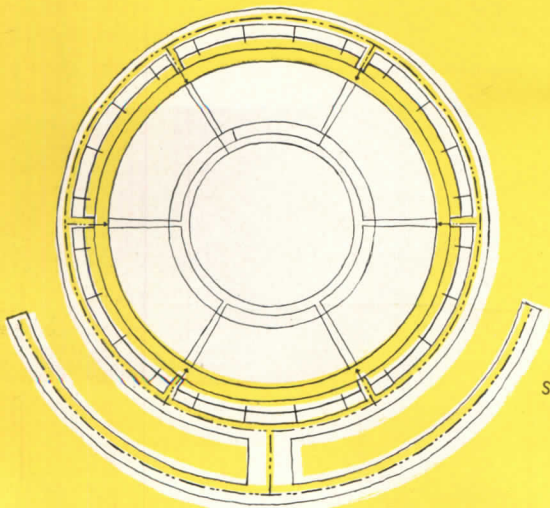
PERFORMERS' ENTRANCE



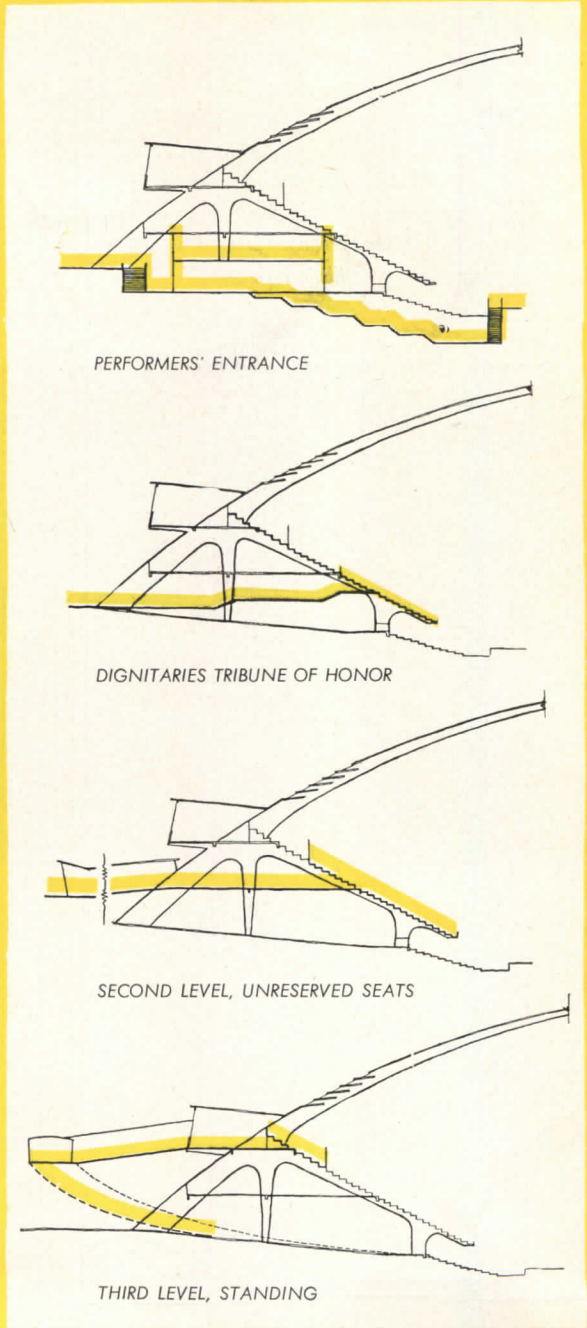
DIGNITARIES TRIBUNE OF HONOR



SECOND LEVEL, UNRESERVED SEATS



THIRD LEVEL, STANDING



PERFORMERS' ENTRANCE

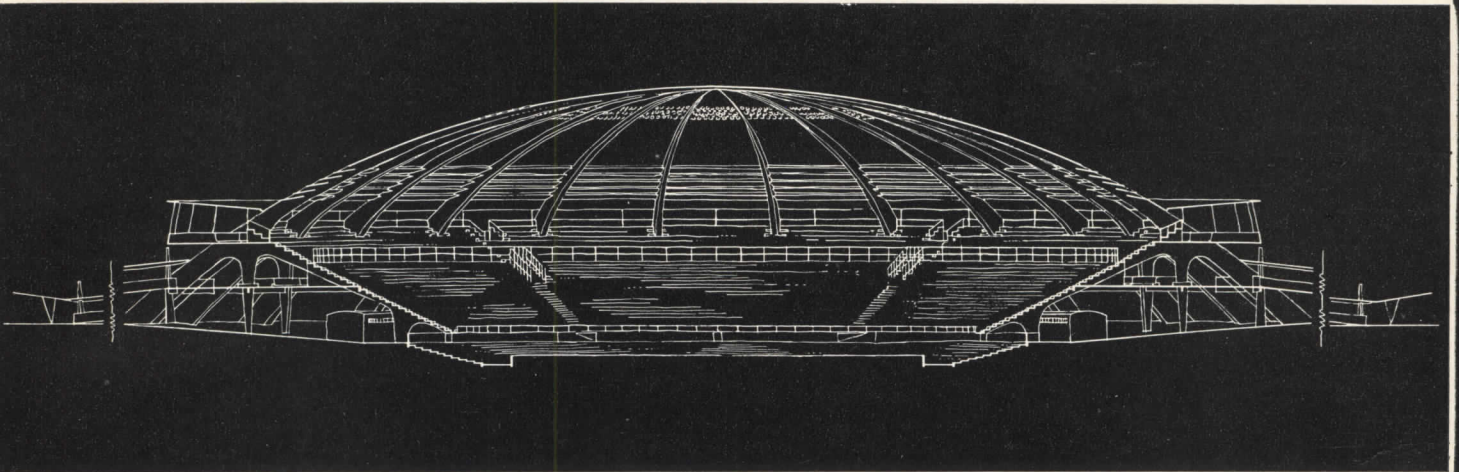
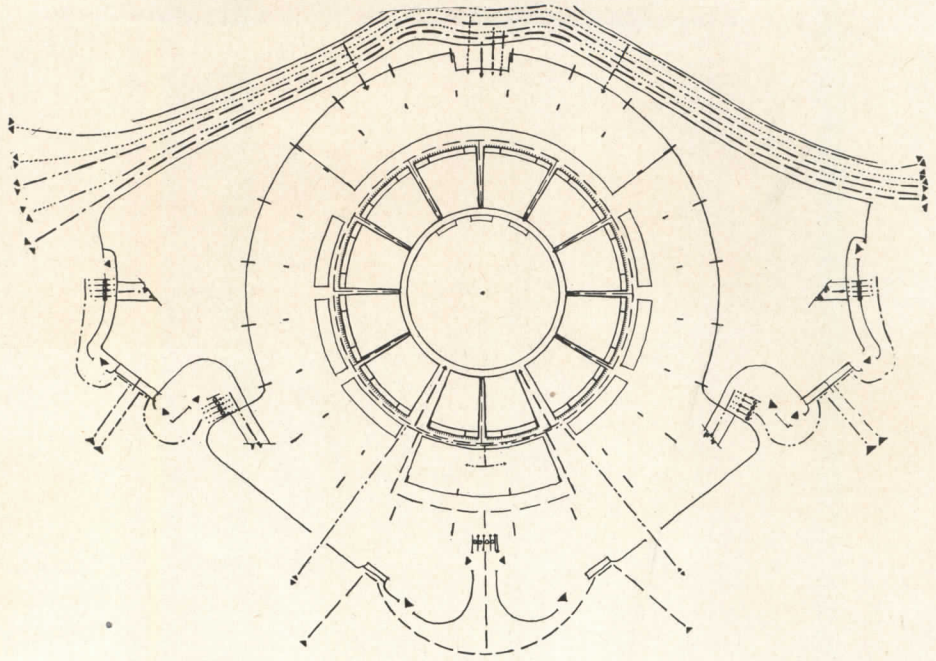
DIGNITARIES TRIBUNE OF HONOR

SECOND LEVEL, UNRESERVED SEATS

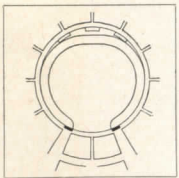
THIRD LEVEL, STANDING

*Ease of circulation, both for convenience and safety, becomes a big problem when planning for such large crowds of spectators. As in the larger stadium, all ramp widths are calculated to empty the gymnasium in 15 minutes, none exceeds 10 per cent slope*

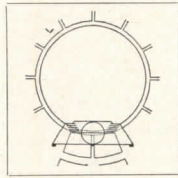
Entrances to the various levels are dispersed around the building to avoid undue congestion. Main level (right) is entered by low-angle ramp from ground level.



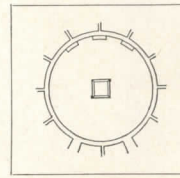
The arena was planned to accommodate a variety of events:



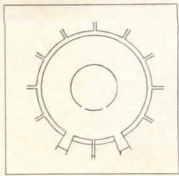
CONTESTS AND PARADES



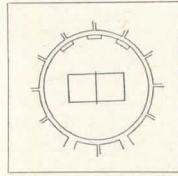
THEATER



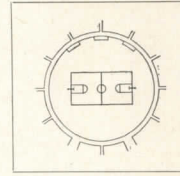
BOXING



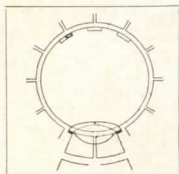
CIRCUS



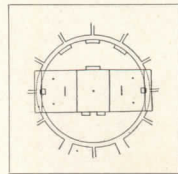
VOLLEYBALL



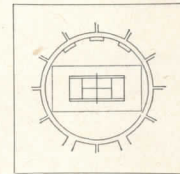
BASKETBALL



CONCERTS

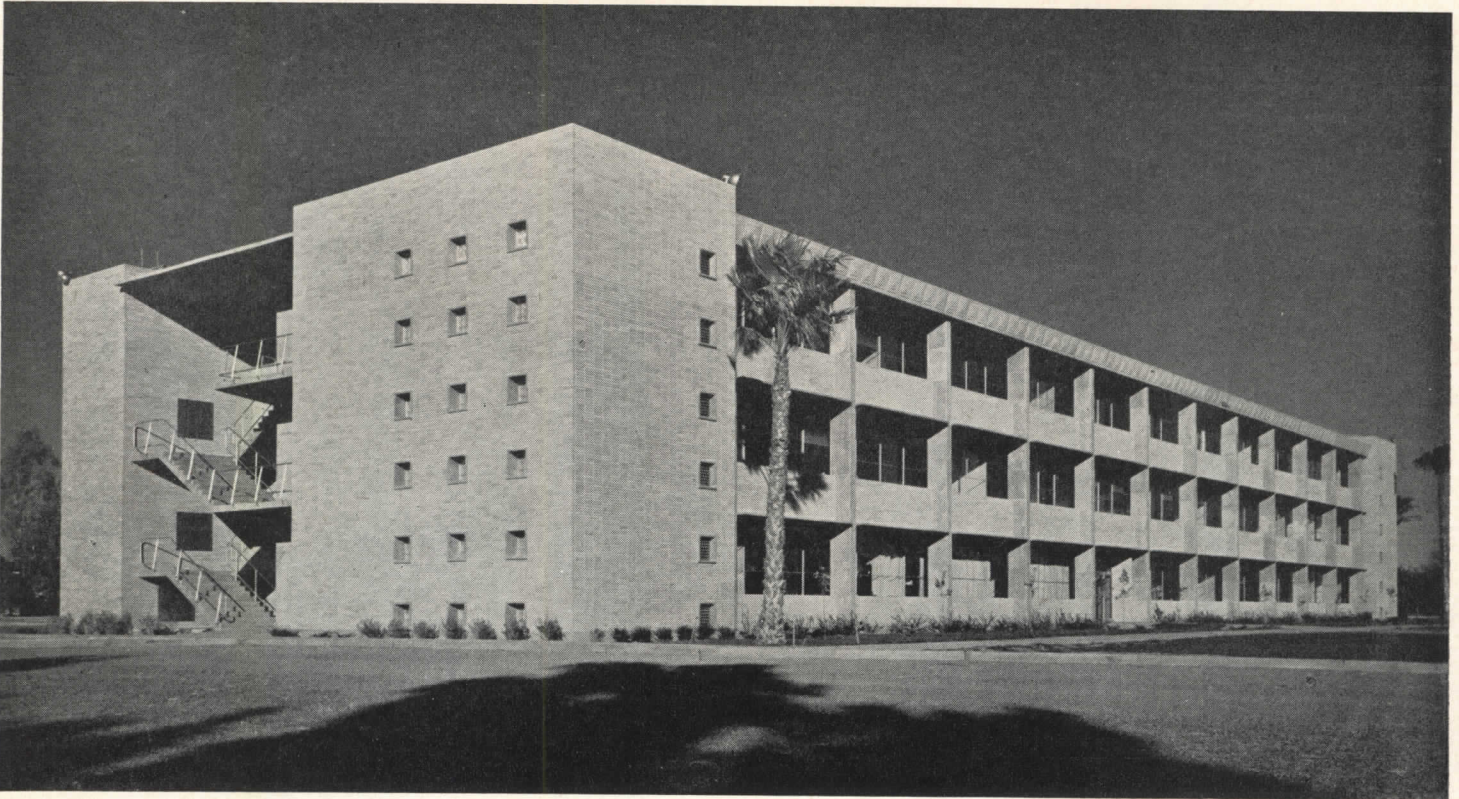


ICE HOCKEY



TENNIS





## AIR CONDITIONING PLAYS MAJOR DESIGN ROLE

*Business Administration, Agriculture and Administrative Offices Building  
Arizona State College, Tempe, Arizona  
Edward L. Varney Associates, Architects & Engineers*

**T**HIS DESIGN DEMONSTRATES how climate and air conditioning can play a part in determining structural and architectural shapes and placements to produce a pleasing synthesis of all elements. The program required double-loaded corridors, which meant both north and south exposures for the three-story teaching wing, shown above and at left. This led to an eggcrate pattern of deep reveals serving to shade the glass and cut down the air conditioning load. The continuous box-like spandrels then became lateral ducts feeding air upward at the glass. Placing the structural columns outside the fenestration plane disengaged the structure from the module pattern of the mullions and transverse partitions so that vertical risers could travel without beam interference. In using the entire corridor volume as a return-air plenum, the conventional furred corridor ceiling was eliminated.

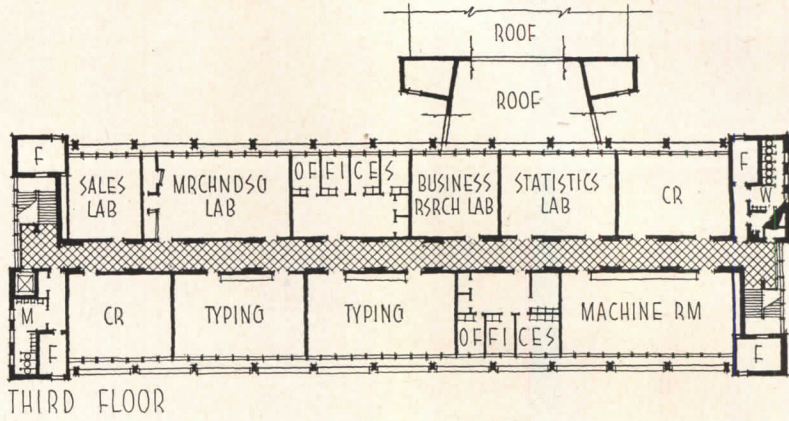
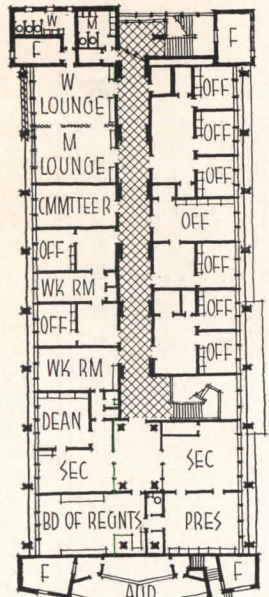
Air conditioning machinery is located in eight vertical stacks, two at each end of each wing. Each stack

has a compressor at the bottom, air handling equipment at each floor and a condenser at the top, which means that refrigerant is pumped from the lower level through coils at each floor and on to the evaporative condenser above. Air is blown over the coils, into the hollow spandrel and circulated at each level. Such a system is flexible, since each unit covers only a quarter of a floor, and economical, due to short runs of both refrigerant and air.

Because of a legislative technicality, three separate functions had to be accommodated in a single structure — thus the building comprises a two-story wing for college administration and a three-story wing for the schools of agriculture and business administration. In the latter, class and lecture rooms are common to both departments but the laboratories are separated.

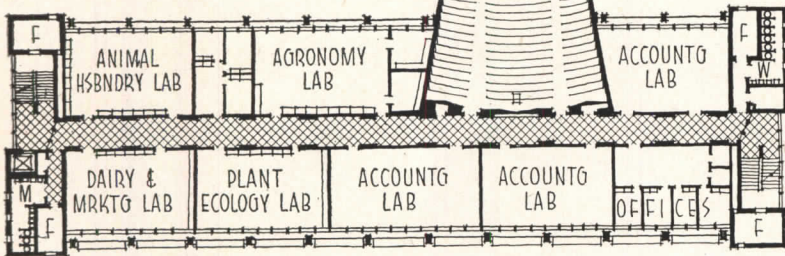
Completed in 1951, the cost of the building including a 300-ton air conditioning plant and all except movable furniture and equipment was \$9.96 per sq ft.

**COLLEGE BUILDINGS**  
ARIZONA STATE

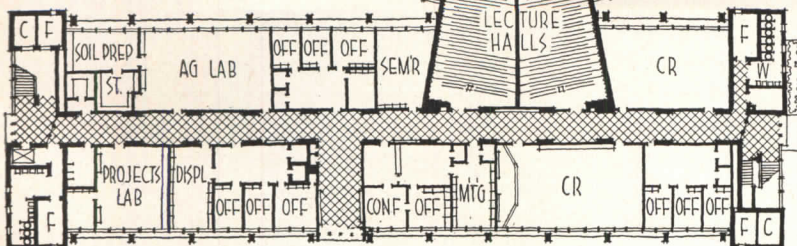
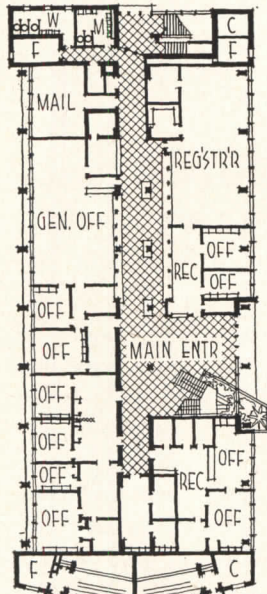


THIRD FLOOR

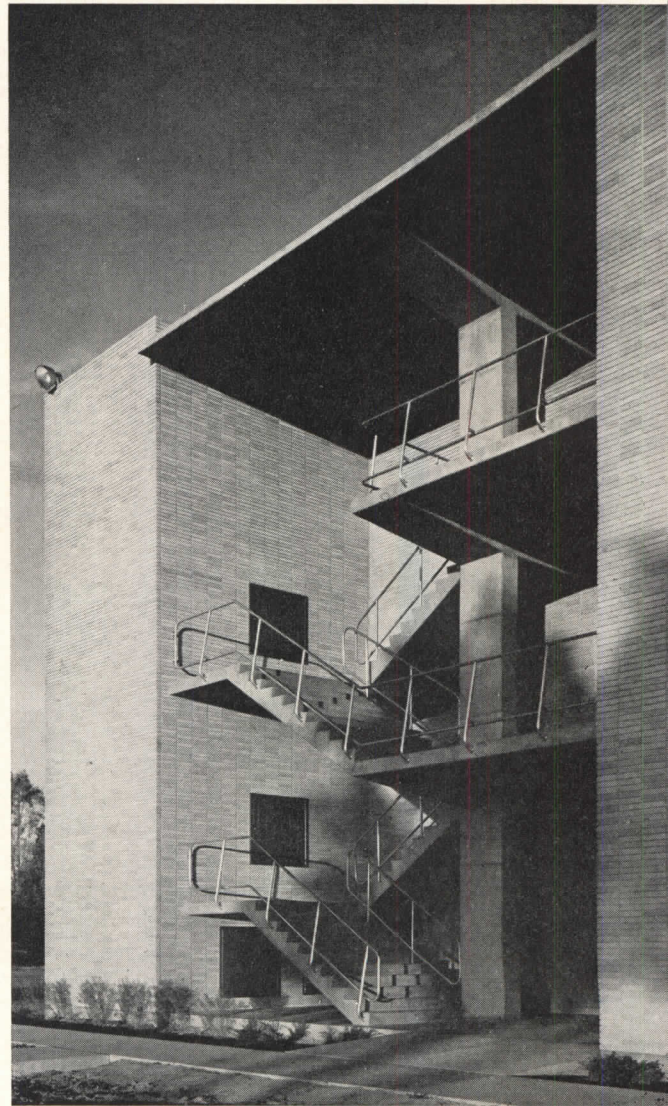
Plans at left: the two-story administration wing runs north and south—the three-story teaching wing runs east and west. At their juncture the auditorium-lecture hall link completely separates these two main elements. F indicates fan room—C compressor room



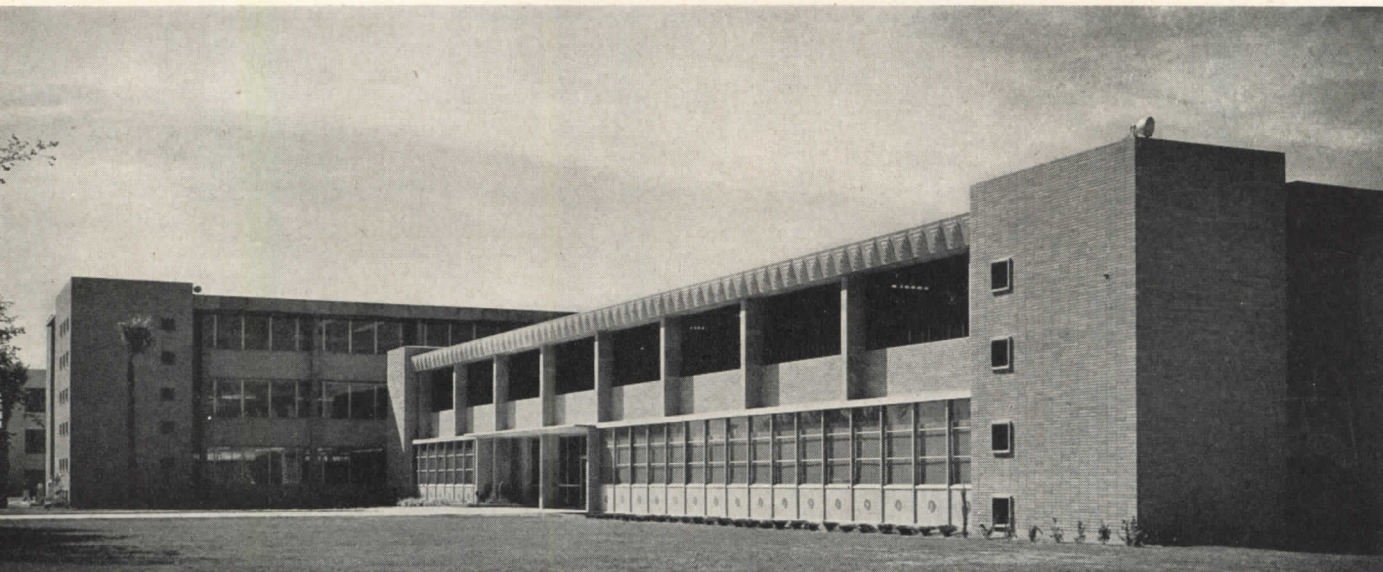
SECOND FLOOR



FIRST FLOOR

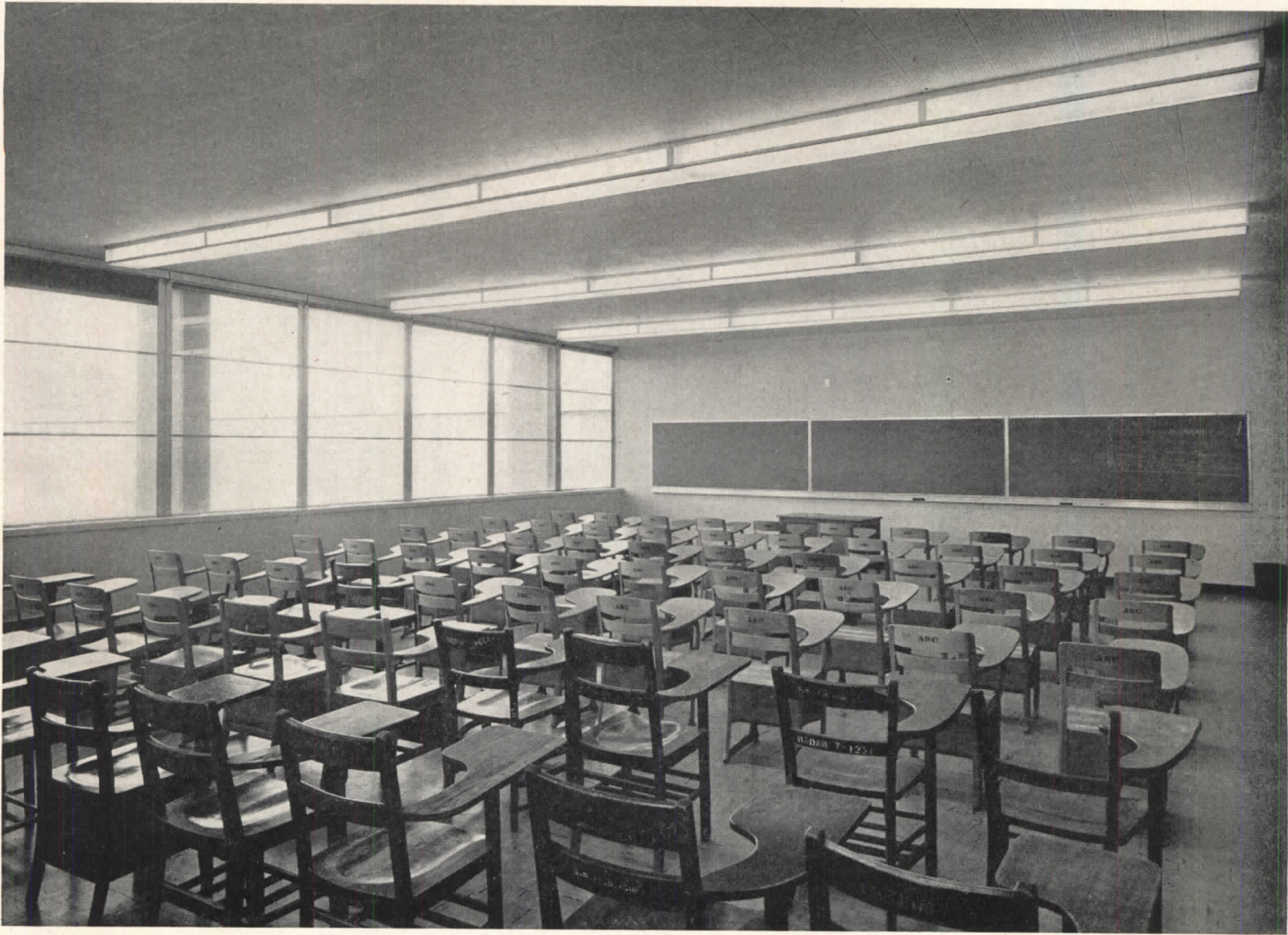




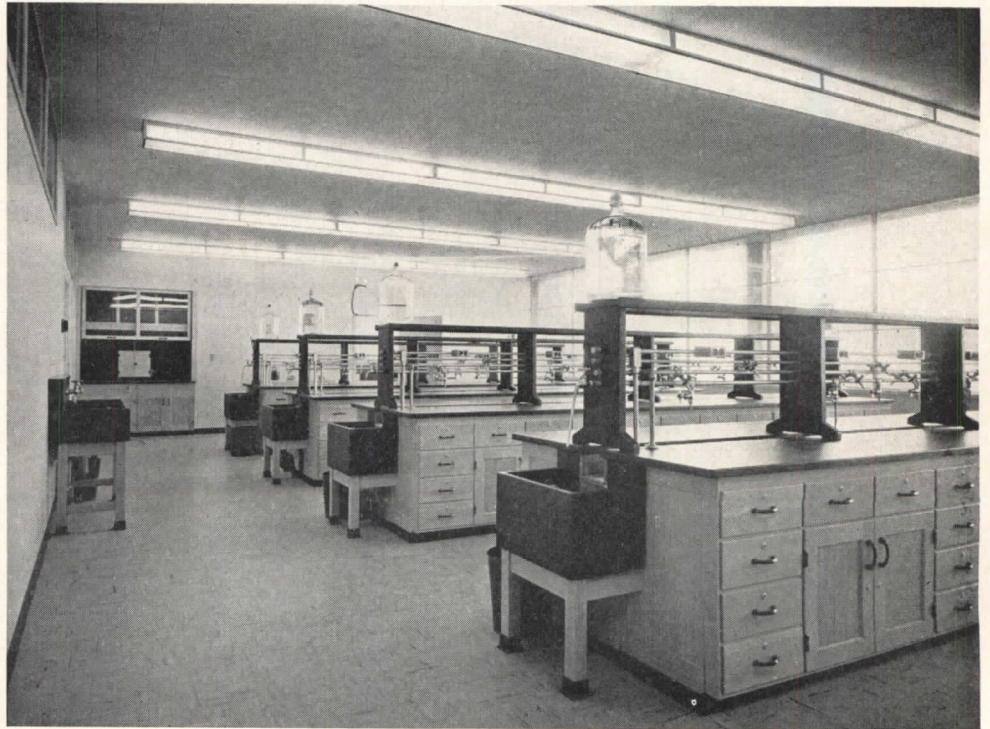


*Photo above and on left page: spandrels and corner towers of buff brick—exterior stair of reinforced concrete, interestingly cantilevered from a central column—fireproofing for exterior steel columns of precast rather than poured concrete—all exterior metal aluminum, including sash and entrance doors. Below: stair in administration wing lobby is reinforced concrete with terrazzo finish, aluminum rail*



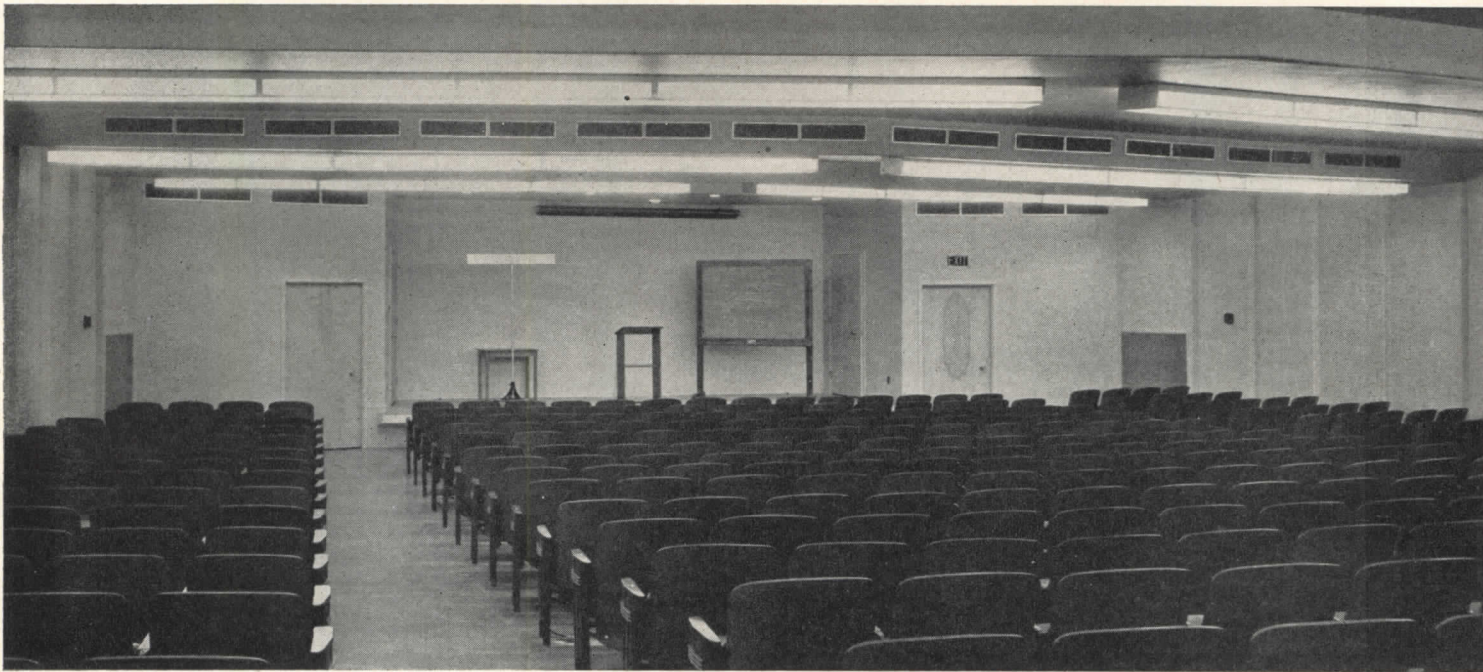


Stuart A. Weiner

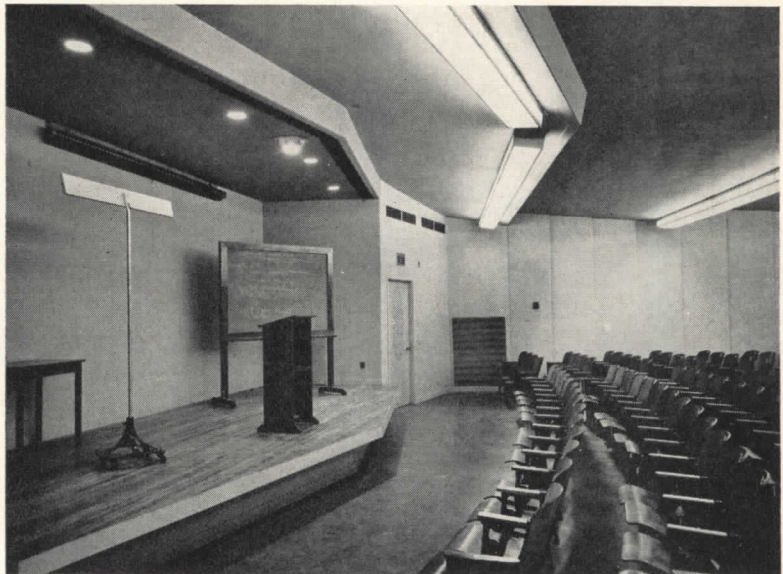


## COLLEGE BUILDINGS

ARIZONA STATE

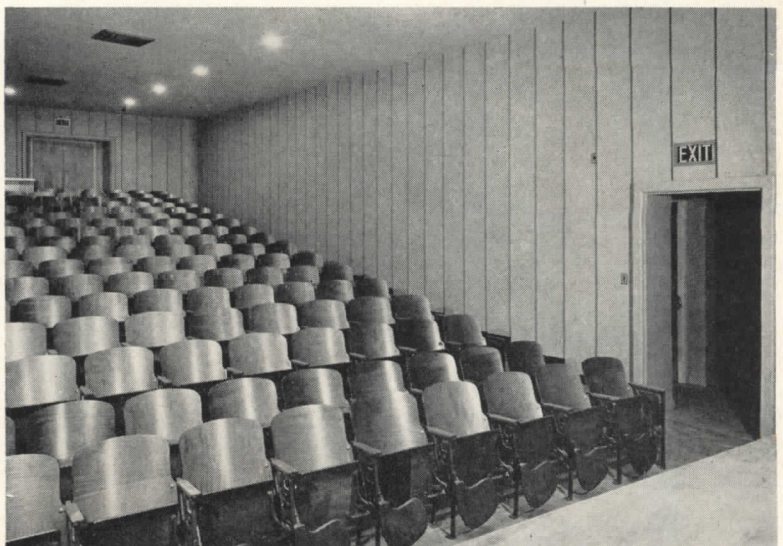


The two photographs on facing page show interiors of typical classroom and laboratory: note how exterior structural columns stand free of glass and independent of mullion module pattern. Classrooms are shared in common by the two academic departments in the building—laboratories are designed for a specific use within one department



Above and top right: auditorium for lecture and demonstration—this element forms the link between the two wings since daylight is not desirable here. Auditorium occurs at second floor level

Bottom right: view of one of the twin lecture amphitheatres located below the auditorium at first floor level



## COLLEGE BUILDINGS

ARIZONA STATE



*Meeting room for the Board of Regents (above) has wood panelled walls; architect designed cases and planting box*

*Below: office of the college president—built-in bookshelves and cabinets, white oak wall panelling, acoustical ceiling*

Stuart A. Weiner





# RECREATION CENTER WITH MODERN INTERIORS

*Student Union Building, Ohio State University, Columbus*  
*Bellman, Gillett and Richards, Architects & Engineers*  
*Howard Dwight Smith, University Architect*  
*Knoll Associates, Interior Consultants*

Jay Oistad





Ground floor ballroom from terrace

THESE ARCHITECTS had not made interiors a part of their regular service until this opportunity arose. For this project they contracted for a complete job, including all furnishings, and called in consultants to advise on fabrics, furniture, etc. The joint effort produced a group of interiors widely praised.

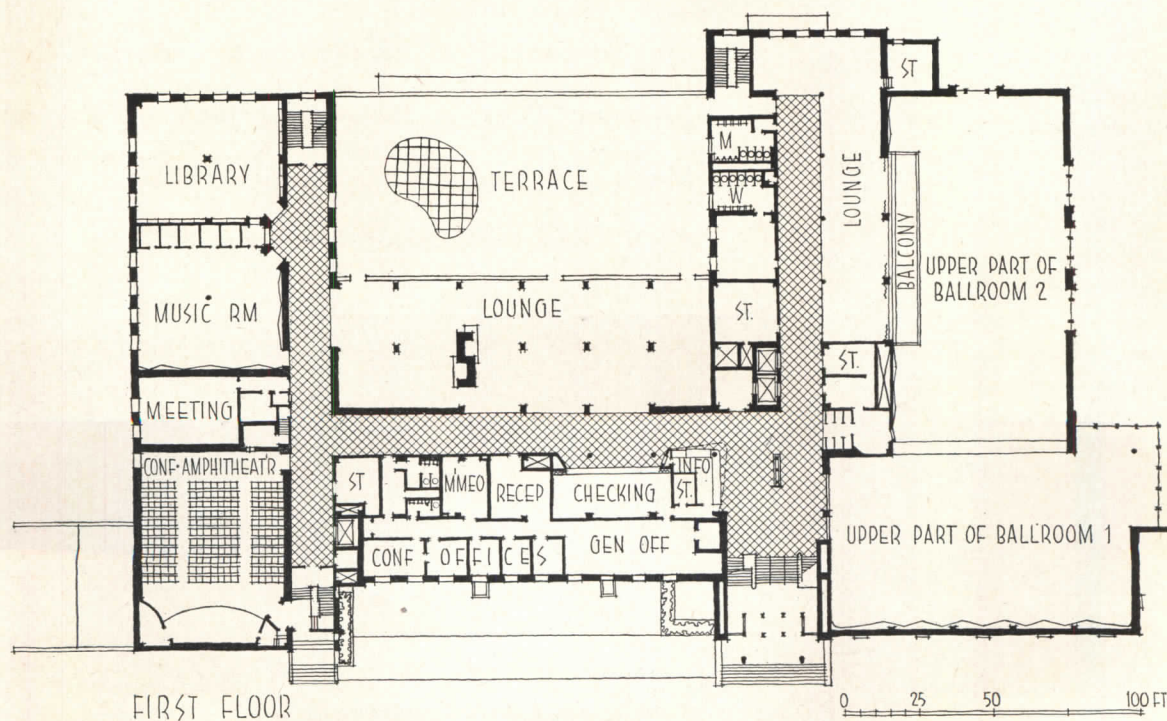
As a result of this happy experience the architects have taken on several additional interior jobs, thereby adding to the volume and scope of their practice.

Ohio State students wanted a Union Building, but were advised that more urgent needs for a hospital, laboratories and dormitories would have preference before the legislature. They therefore organized a campaign and circulated a petition to the university trustees. Despite knowledge that the building could not be completed during their student days, 14,235 students signed in three days, agreed the project must be self-liquidating and pledged a maximum of \$5 per quarter. The trustees approved, assigned a site, and a committee of students, faculty and alumni worked a year on the program, after which the architects started their plans.

The building follows four main divisions: (1) recreation at basement level, (2) dining and ballroom facilities at ground floor level, (3) lounges and administration on the first floor, and (4) student activities offices and private dining on the second floor.

The principle of locating kitchens, deliveries and dining at campus level was followed; also the idea of facing principal rooms and terraces toward "Mirror Lake Hollow," traditional campus beauty spot.

Heat is furnished by converting steam from the central plant into circulating hot water. There are pipe coils in terraces and approaches to melt winter snow.





1



2

Joy Oltstad

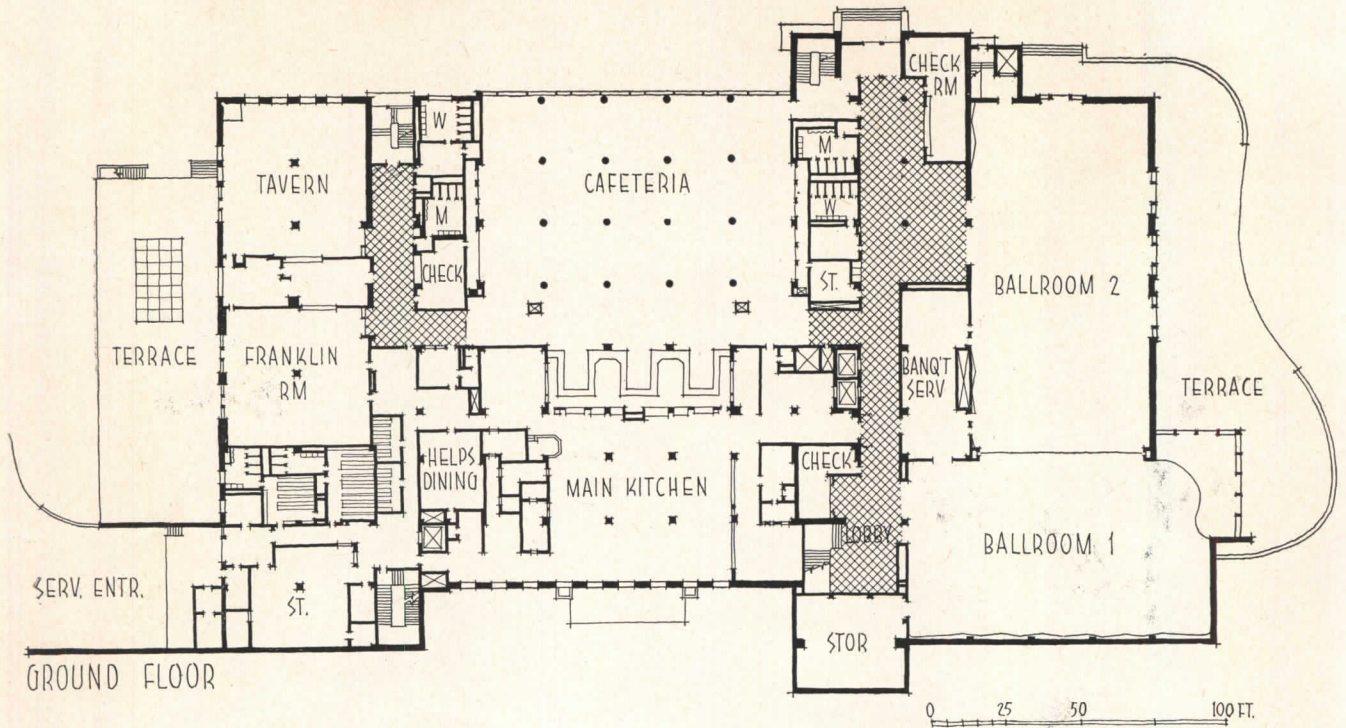
- 1 Main Lounge
- 2 Browsing Library
- 3 Auditorium

*In addition to an administration suite, music room and meeting room, the principal rooms at first floor level are the large lounge which opens through a glass wall to a flagstone terrace facing the campus "hollow"; a browsing library offering periodicals; a conference auditorium seating 250, used for forums and small concerts*



3

**COLLEGE BUILDINGS**  
**OHIO STATE**

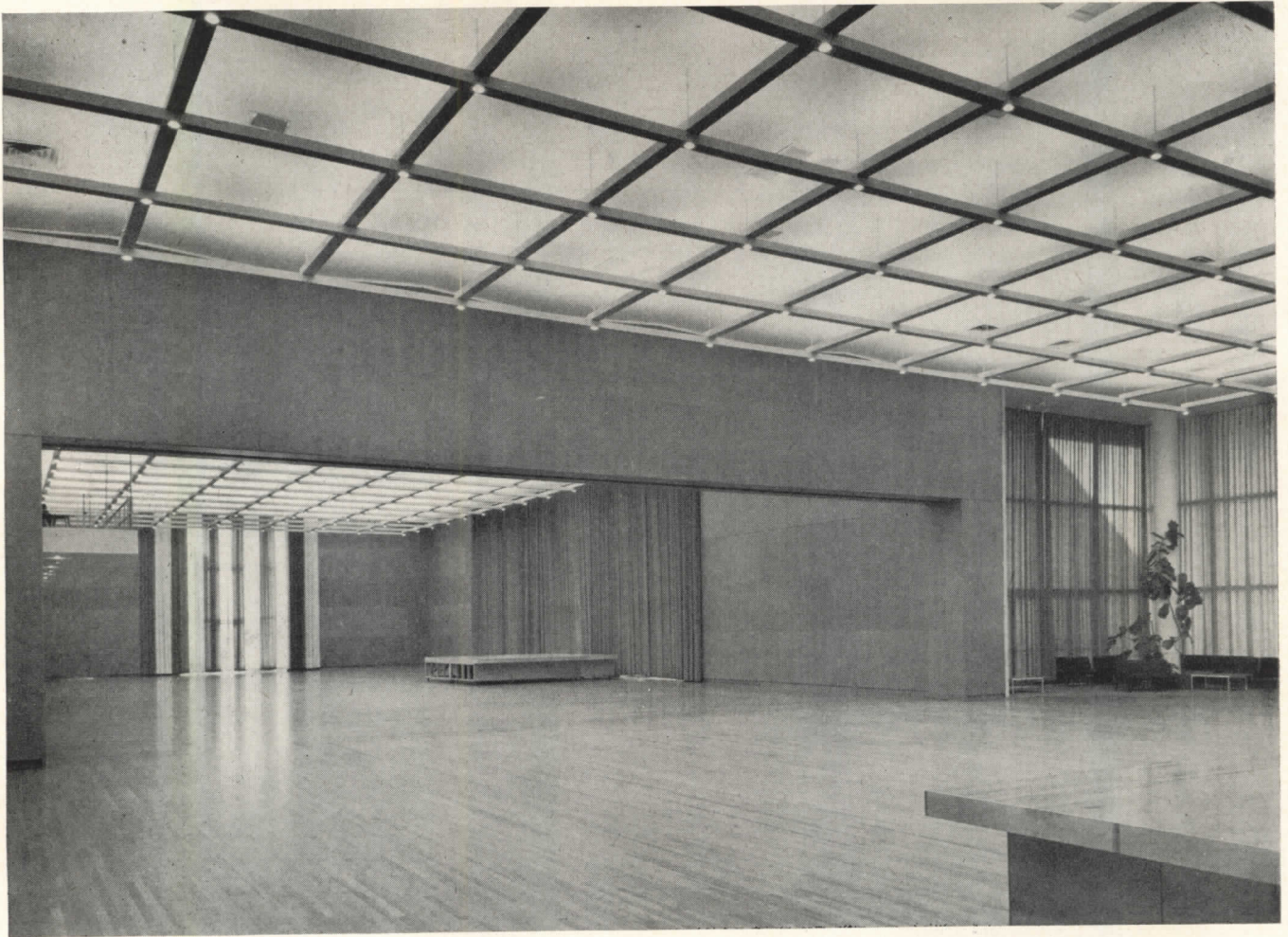


The two ground floor ballrooms (top right) open to a terrace facing campus view; can be separated or combined by a motorized wall; four-color fluorescent lighting is adjustable to any color



Principal stair has terrazzo treads and risers, satin-finished aluminum handrails, ends at ground floor level in lobby for ballroom





Jay Oistad



Cafeteria (above) has three counters, two 40-ft conveyors for soiled dishes. Tavern (right) features fireplace, brick and cherry plank walls





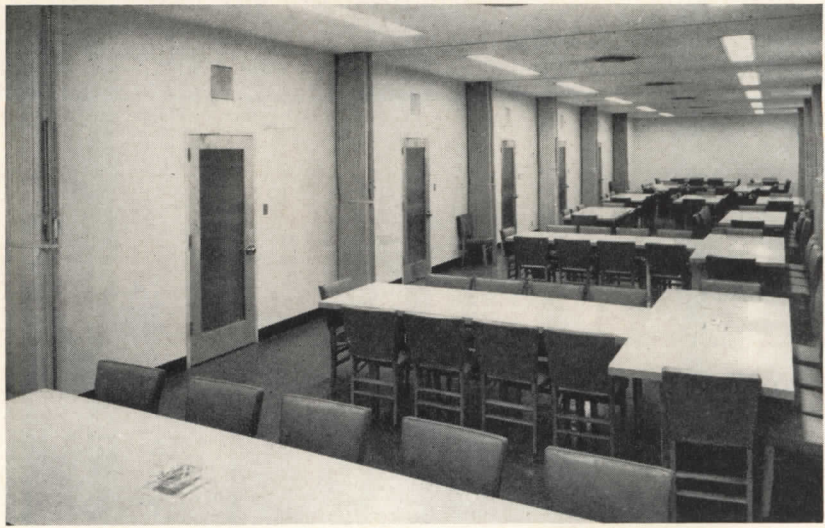
**COLLEGE BUILDINGS**

**OHIO STATE**

*Basement recreation facilities include 16 bowling alleys (above), 18 billiard and pool tables (below), a card room, a room for eight tennis tables, photography darkrooms, a hobby room*



*In addition to a 10,000 sq ft wing devoted to offices for student activities, the top or second floor provides 17 private dining rooms (two photos at right). Collapsible partitions divide these areas and provide maximum flexibility for accommodating either large or small groups. Photographs show the space with partitions in open and closed positions*



*The second floor dining room (below) seating 100, opens to a terrace for outdoor dining in favorable weather, and is adjoined by a large lounge used occasionally for art exhibits. A soft, pleasing light for dining results from suspending plastic eggcrate diffusers below flush downlights*



Jay Oistad





COLLEGE BUILDINGS

## DESIGNED FOR 600-LB

*Engineering Building*

*University of California, Los Angeles Campus*

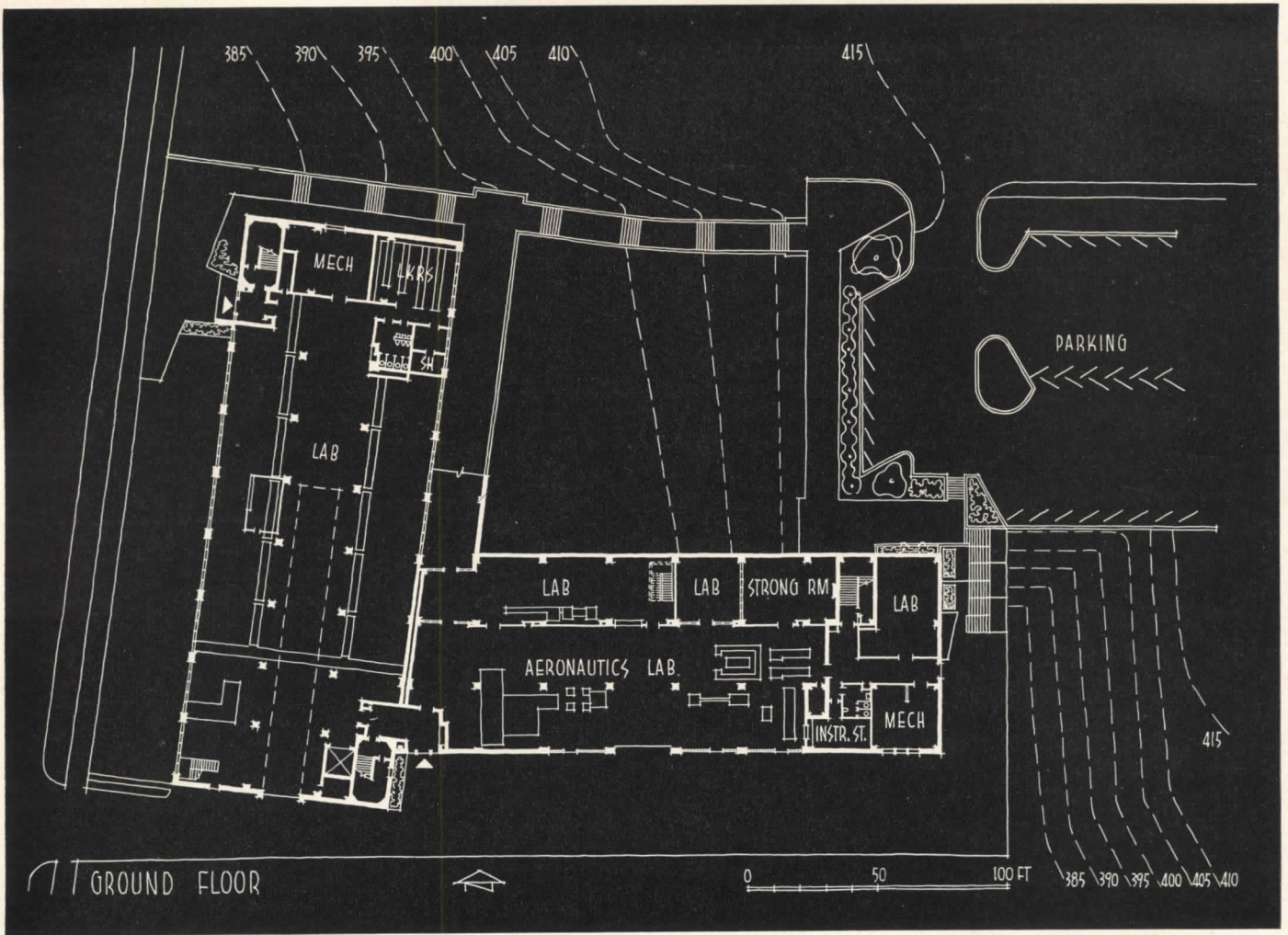
*Allison and Rible, Architects*

*Welton Becket & Associates, Supervising Architects*

**T**HIS BUILDING is the first unit in a projected group for engineering study at UCLA. Built at the foot of a hill on a site facing Westwood Boulevard, the main planning problem was to relate the engineering labs to the remainder of the campus buildings, located on a higher level at the top of the hill. Eventually, the main entrance to the engineering group will be located at the higher level, facing the campus.

Designed for heavy duty usage, the buildings will accommodate live loads ranging up to 600 lb per sq ft. Provisions were made for craneways, open wells, elevators, trucks and for free movement of a tractor-trailer with a 7-ton load on all levels and on portions of the





## LIVE LOADS

Elevations at street level (left page) face away from main campus group. Plot plan (above) shows parking area (below). Aeronautics wing (below) contains 62,500 sq ft



Julius Shulman

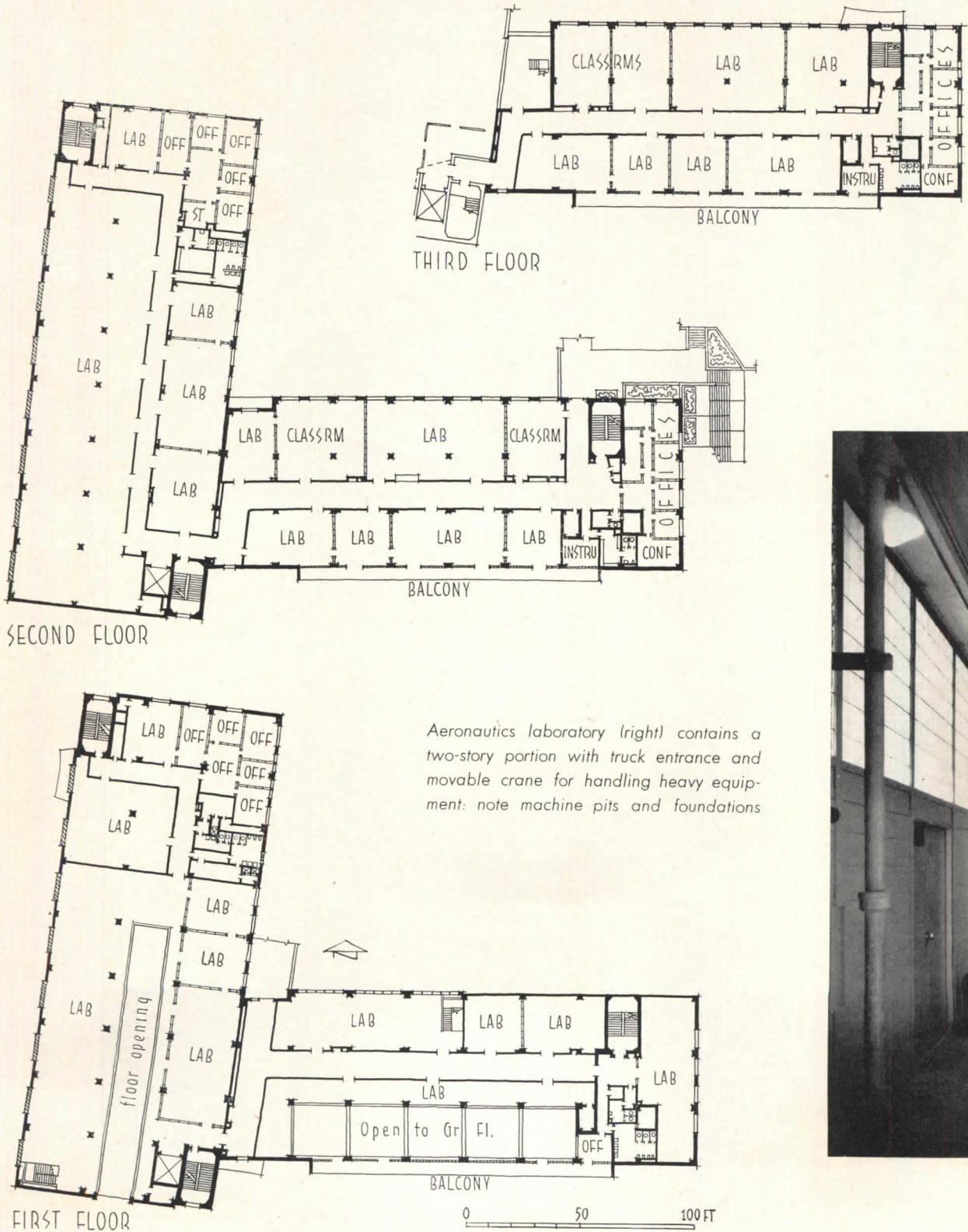
**COLLEGE BUILDINGS**

UCLA

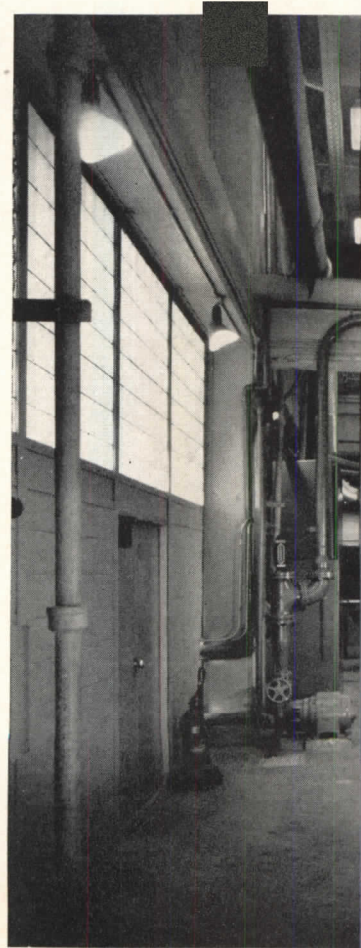
roof. For added convenience in handling large engineering apparatus horizontally and vertically as well as indoors and out, there are ports in floor and roof slabs, masonry panels are removable and balconies afford ac-

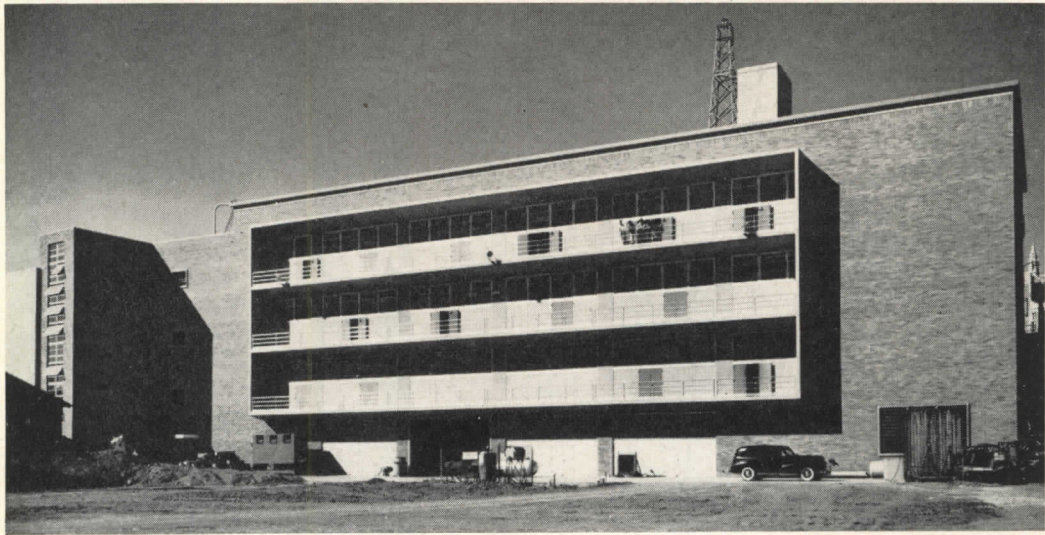
cess to outdoor experimental setups. A 7 ft 6 in. parapet effectively shields outdoor project activities on the roof from the higher campus view.

The structural frame is of reinforced concrete; portions of the exterior are of red brick selected to harmonize with the existing buildings; all windows and grills are aluminum, as is the ornamental metal work at the Westwood Boulevard entrance.

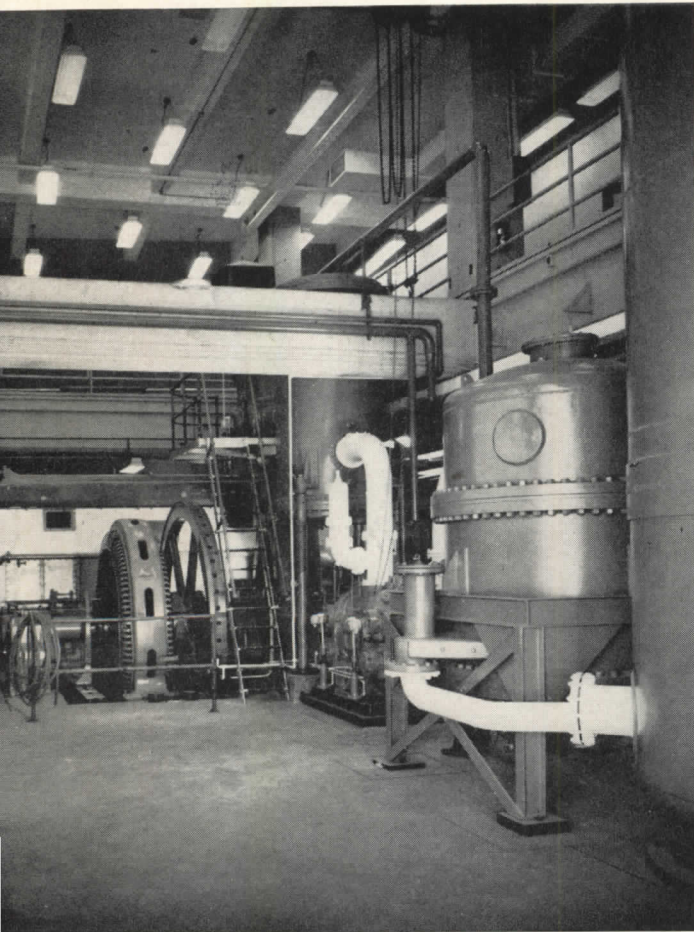


*Aeronautics laboratory (right) contains a two-story portion with truck entrance and movable crane for handling heavy equipment: note machine pits and foundations*





Balconies and roof with high parapet (above) are used for outdoor study. Hydraulics laboratory (below, right) has high central area and motor-operated doors for truck entrance

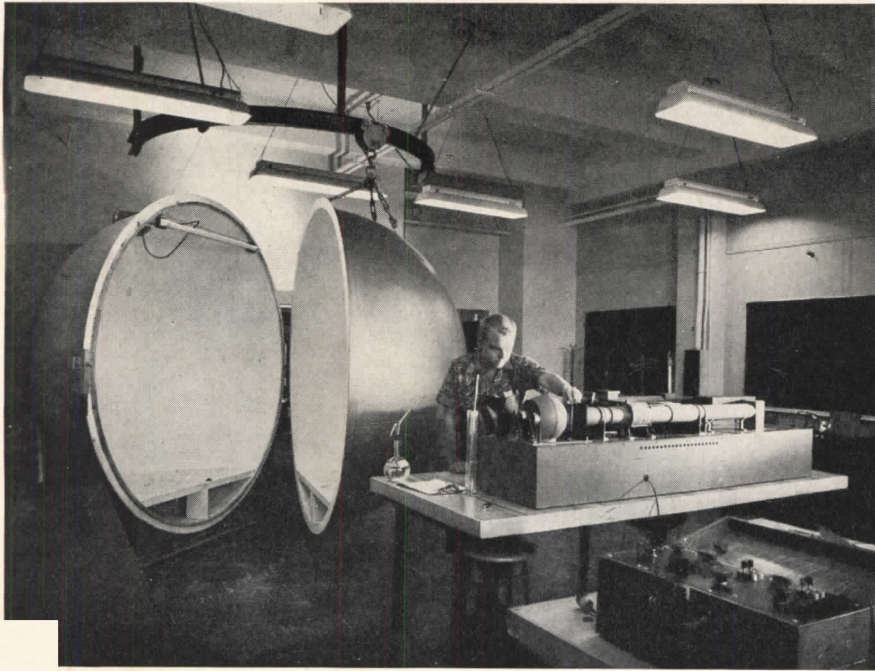


Julius Schulman



## COLLEGE BUILDINGS

UCLA



Julius Shulman



Physics experiment (top left) in one of the small laboratories on the upper floors

Stairway (above) is located at end of aeronautics wing; serves as vertical link between lower or street level and remainder of campus. Warm colored brick walls; aluminum windows and grills; stainless steel railing; concrete treads and risers

Entrance at Westwood Boulevard (left) features aluminum marquee, entrance doors and louvers; exposed concrete and brick walls





# CONTEMPORARY DESIGN AMIDST COLLEGIATE GOTHIC

*Classroom Building for Graduate Study*

*Concordia Seminary, Clayton, Mo.*

*Kenneth E. Wischmeyer, Architect*

THE EVANGELICAL LUTHERAN SYNOD OF MISSOURI commissioned Charles Z. Klauder to design the original buildings for Concordia Seminary. Located in the suburbs of St. Louis on a rolling, tree-dotted campus, the "collegiate gothic" group was completed in 1925, served without addition until this classroom building was begun.

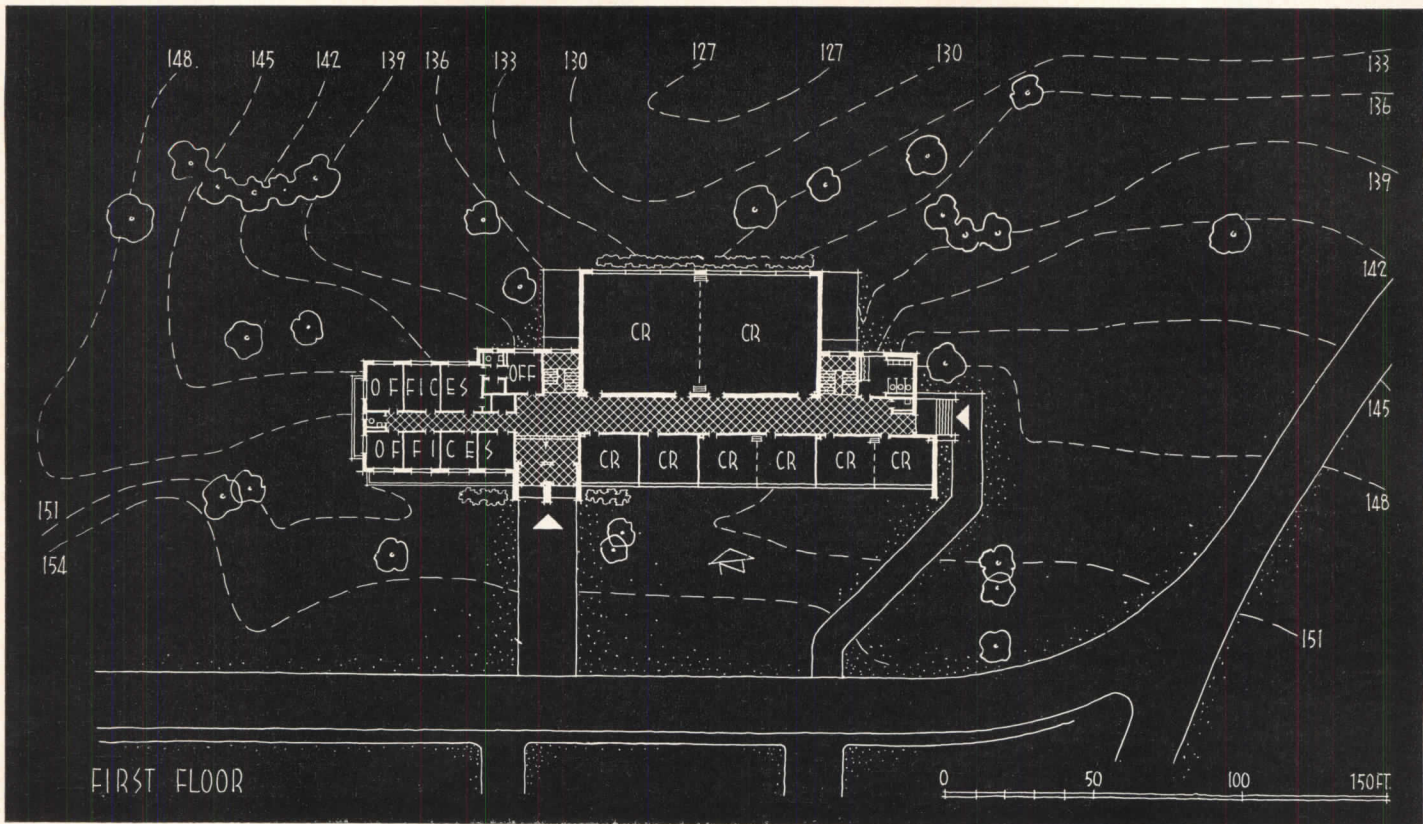
The Board of Control held originally that any new structure should conform in spirit to those existing, but finding their desires exceeding their budget and the need very great, finally consented to a straightforward

building devoid of mouldings or ornament for the new graduate building. The resulting modern design met the budget and cost \$11 per sq ft. There has been universal praise for the interiors, while reaction to the exterior has been mixed. The building has probably set a precedent which may clear the way for similar, unpretentious projects in the future.

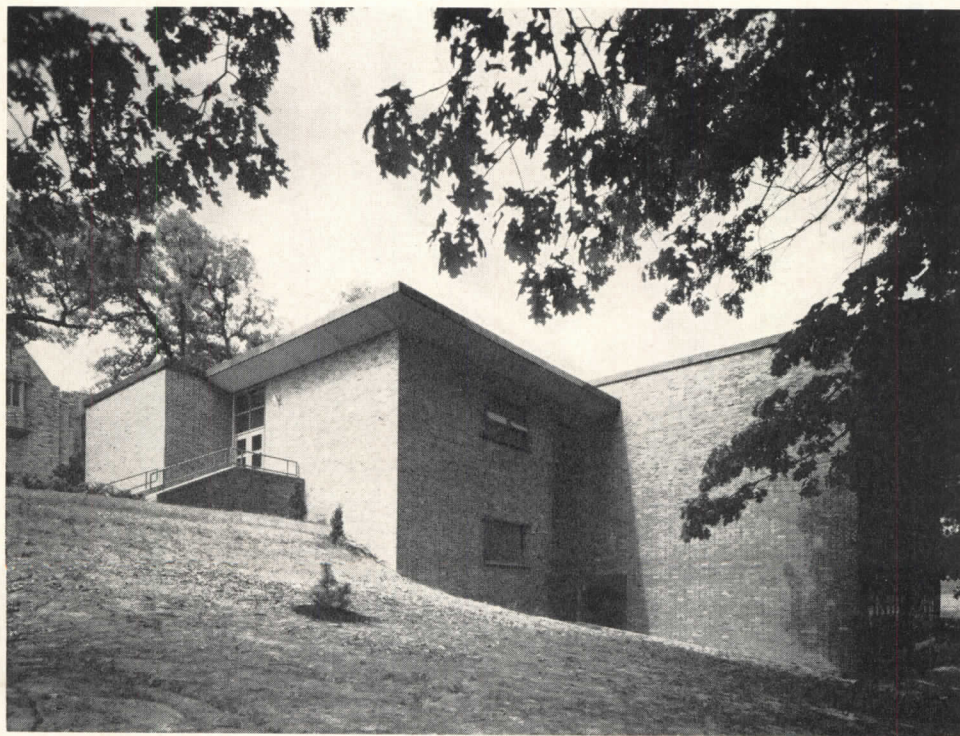
Structure is steel frame and joists with concrete floor slabs — exterior red brick and stock steel sash — interior walls are exposed lightweight block, painted — floors are asphalt tile — ceilings are acoustic tile.

Hedrich-Blessing



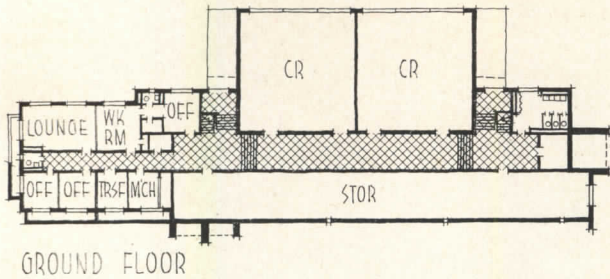


Hedrich-Blessing



## COLLEGE BUILDINGS

### CONCORDIA



*Benching the structure into the rake of a hill sloping downwards 15 ft from front to rear (see opposite page) resulted in a one-story elevation toward the road and a full two-storied building at the rear*

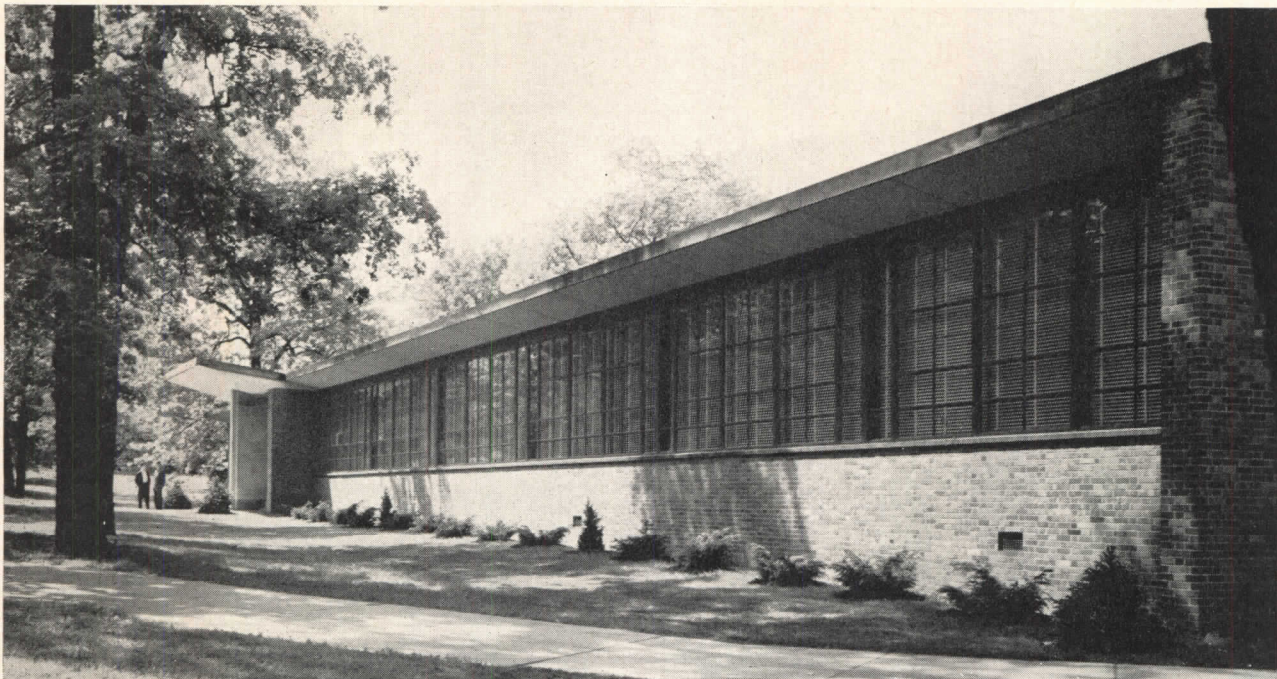
*Below: large lecture-classroom at first floor level can be divided into two smaller classrooms by closing the lateral folding partition. Note the duplicate lecterns and sound equipment for bilocular use*



## COLLEGE BUILDINGS

### CONCORDIA

Hedrich-Blessing



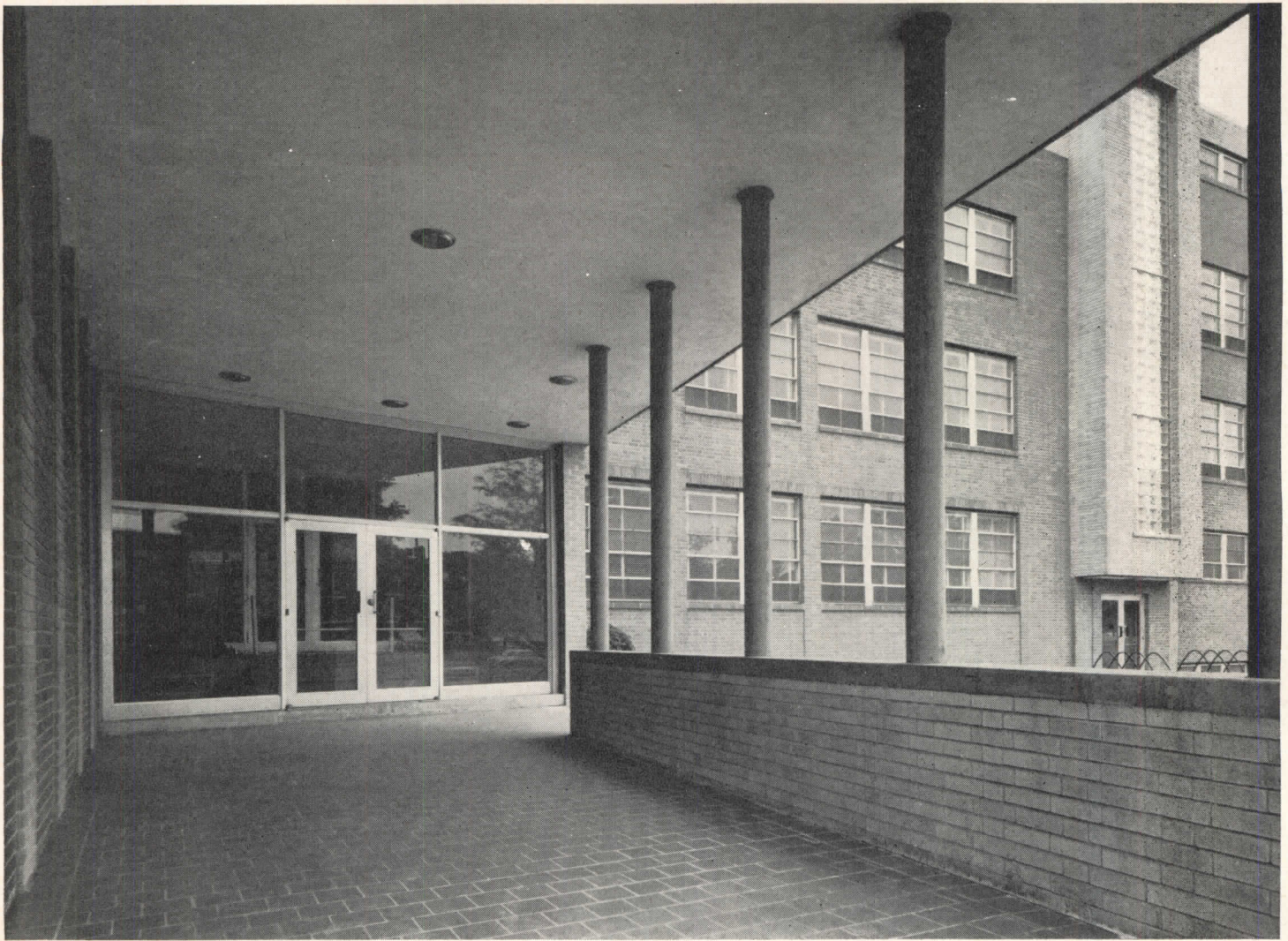
Street elevation (above) shows use of stock sash to produce an unbroken horizontal band

Right: steel pan stairways with cement-filled treads and acoustical tile soffits provide a neat and economical connection between ground and first floors. Railing is of welded steel pipe in a simple, attractive design. Note exposed painted block, laid in an interesting bonding to yield a low-cost, good looking wall

Right page: at the rear two-story portion, brick verticals sheathe the steel columns, express the structure. The entire remaining panel from grade to roof becomes a pattern of standard steel sash and insulated steel panels, broken only by the unit ventilator grills. Overhanging roof soffit is precast lightweight plank



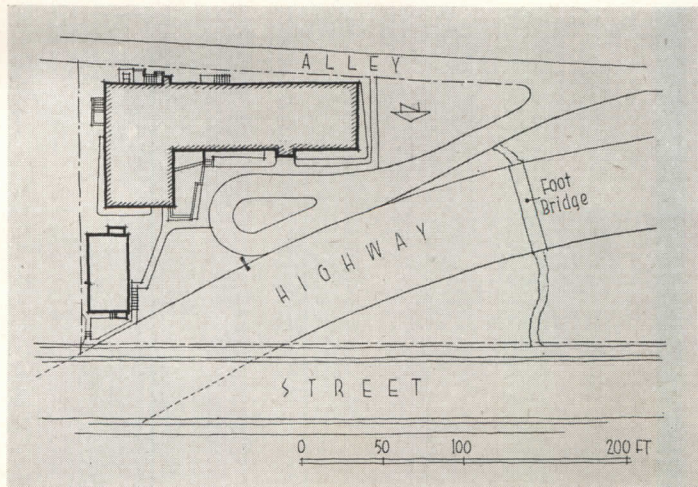




Hedrich-Blessing

# LABORATORIES AND CLINIC, CENTRAL INSTITUTE

*William B. Ittner, Inc., Architects*



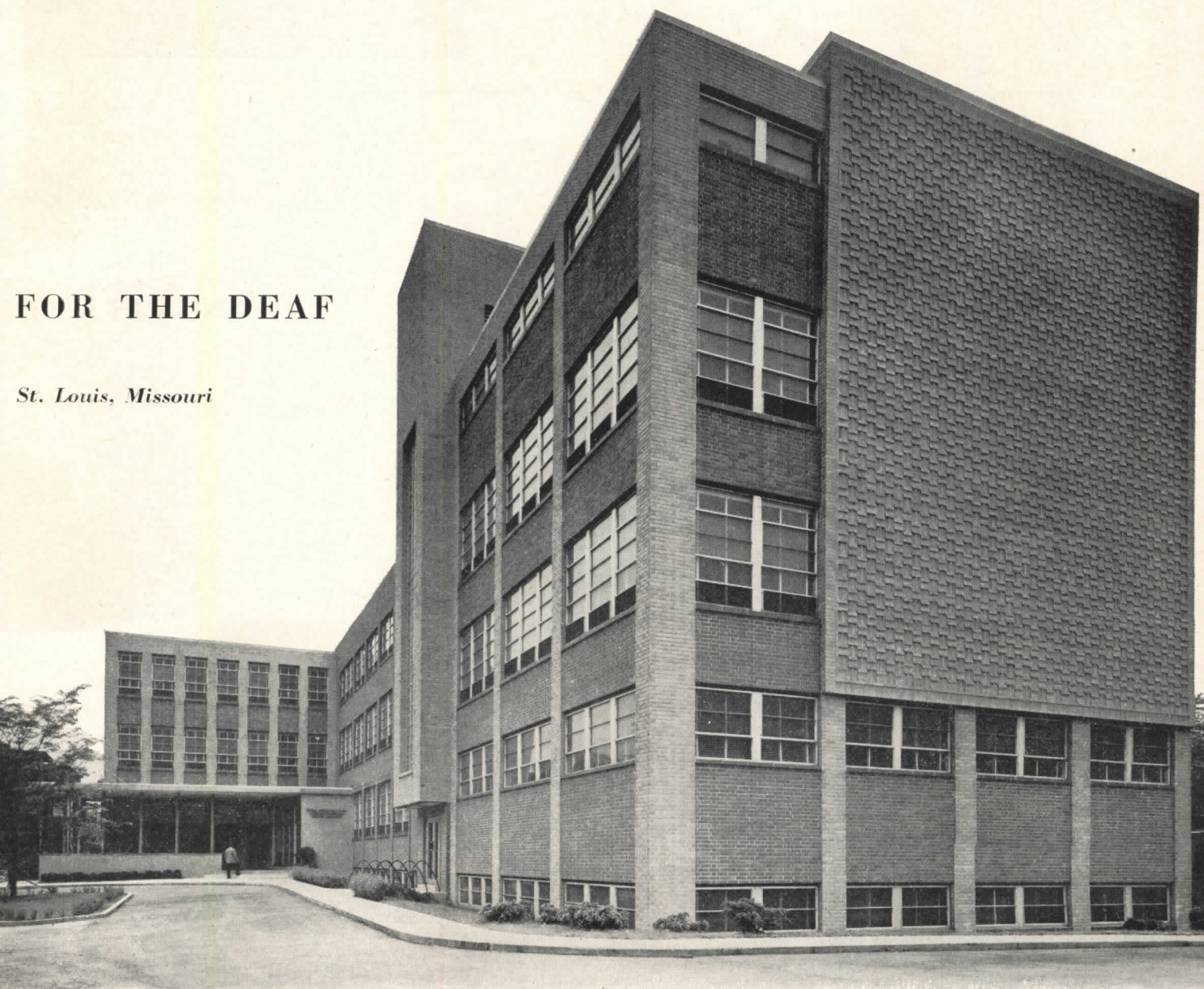
**T**HE Central Institute for the Deaf was founded in St. Louis by the late Dr. Max Goldstein, in 1914. It began in limited quarters over the office in which he practiced as an ear specialist. Now it is an internationally known private center comprising a school for deaf and speech defective children, a training college for teachers of the deaf and of speech correction, hearing aid and auditory training clinics, psychological and research laboratories, library, and engineering shops. It maintains close liaison with the adjacent teaching hospital and Washington University.

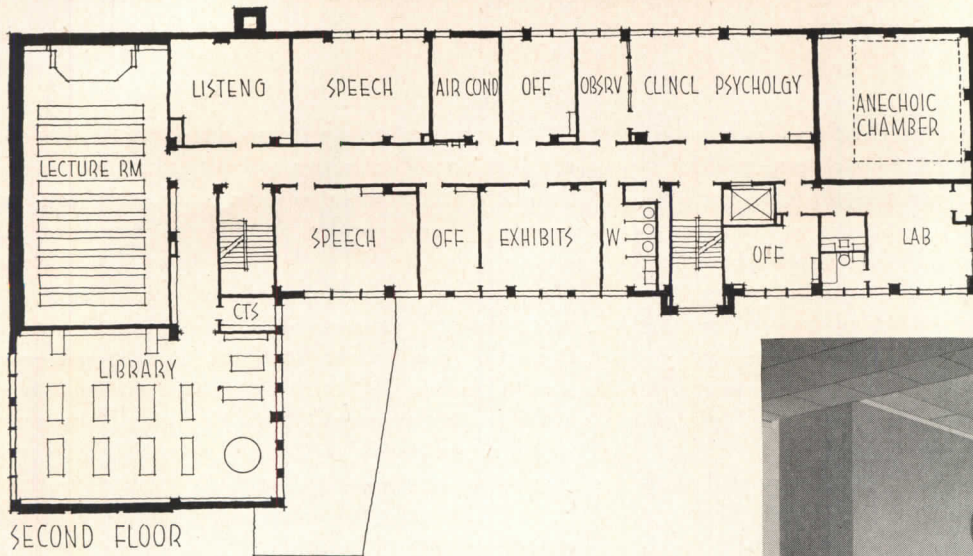
Early in 1951 the new research laboratory and clinical building was completed. As the site plan shows, a depressed superhighway passes close to the new building. Since research into the nature of sound is an important part of the Institute's program, the vibration and noise caused by heavy traffic might have been expected to cause trouble. However, soil conditions were excellent, and the reinforced concrete columns and floor slabs, gypsum tile partitions, and full acoustical treatment of interiors — all required in any event — eliminated interference with sound control.

It is unusual to find associated under one roof the combination of activities which the Institute carries on. Fundamentally these are: research, teaching, teacher training. They require pursuit of basic, applied and clinical sciences and training in education and in audiology (study of problems of oral communication both receptive and expressive). The building is departmentalized approximately by floors, with shops — the Institute builds its own electronic equipment — and archives on the ground floor, clinics and other areas to which many people need ready access on the first floor, classrooms on the second, and laboratories on the third. In addition to clinics and laboratories, the building contains elaborate equipment and affords opportunities for studies in physiology (especially neuro-physiology and electro-physiology), psychology, speech pathology, physics and engineering as applied to acoustics and otology. At one end is a two-and-a-half story anechoic chamber, shown on subsequent pages, in which virtually 100 per cent of sound is absorbed. All these facilities provide means for studying the absolute nature of sound and its effect on human beings.

## FOR THE DEAF

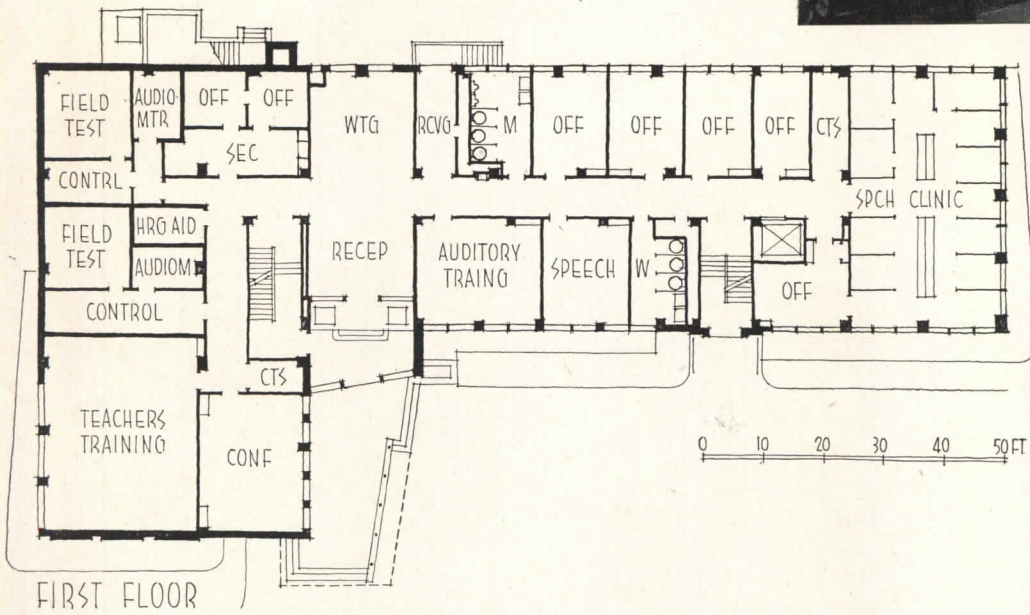
*St. Louis, Missouri*



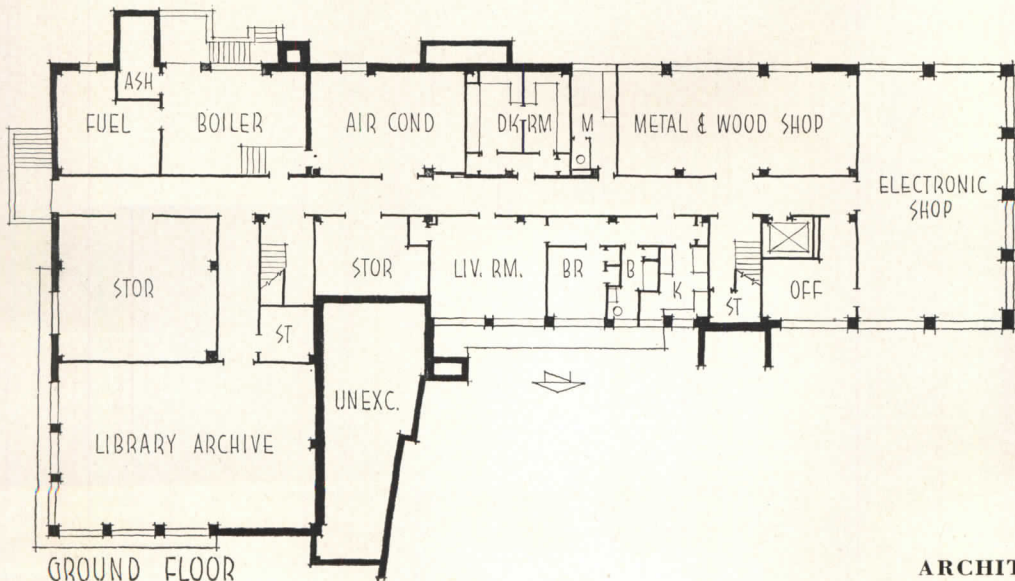


SECOND FLOOR

Right, reception room corner. Plans show lower three floors: ground (semi-basement) floor, shops where Institute makes its own equipment, archives, storage, caretaker's apartment; first floor, clinics; second floor, classrooms. Between clinical psychology room and observation room is a one-way-vision glass partition which permits observation of pupils or patients undergoing test without interference



FIRST FLOOR



GROUND FLOOR



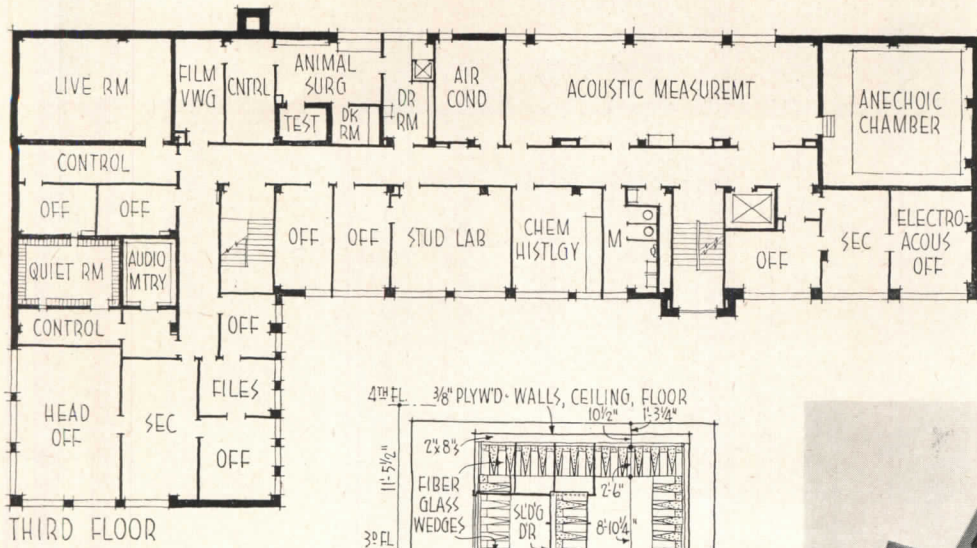
**CENTRAL INSTITUTE  
FOR THE DEAF**



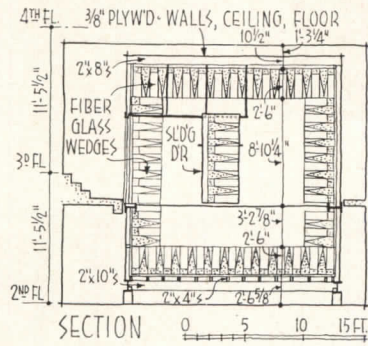
Hedrich-Blessing



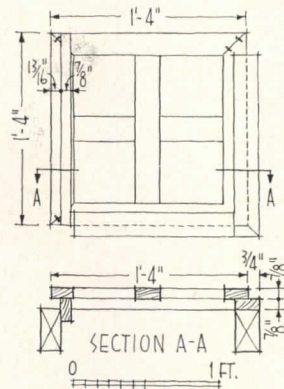
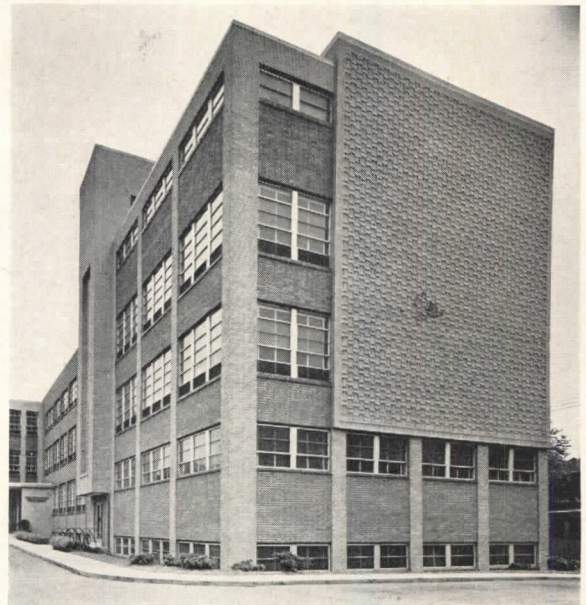
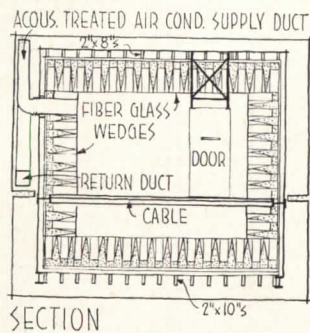
*Top: rooms used by public, pupils or patients are furnished as pleasantly as possible. Throughout, floors are asphalt tile and ceilings acoustical tile. Below, speech clinic contains cubicles large enough for teacher, pupil and a parent or friend to help put pupil at ease*



SECTIONS THROUGH ANECHOIC CHAMBER showing sliding door



Showing air conditioning ducts



Wood frames for Glass fiber wedges

Hedrich-Blessing



Plan of third floor shows laboratory facilities, including rooms of various degrees of liveness with control rooms adjacent. Intensities, nature, effects of sound are studied electronically; effects on animals and people are accurately measured by recording nerve responses to the stimulus of sounds. Sections, detail and photo at right show anechoic ("without echo") chamber; photo above, position of anechoic chamber is expressed on exterior by patterned brick panel; left, control room



# PATTERSON-BRADFORD REXALL

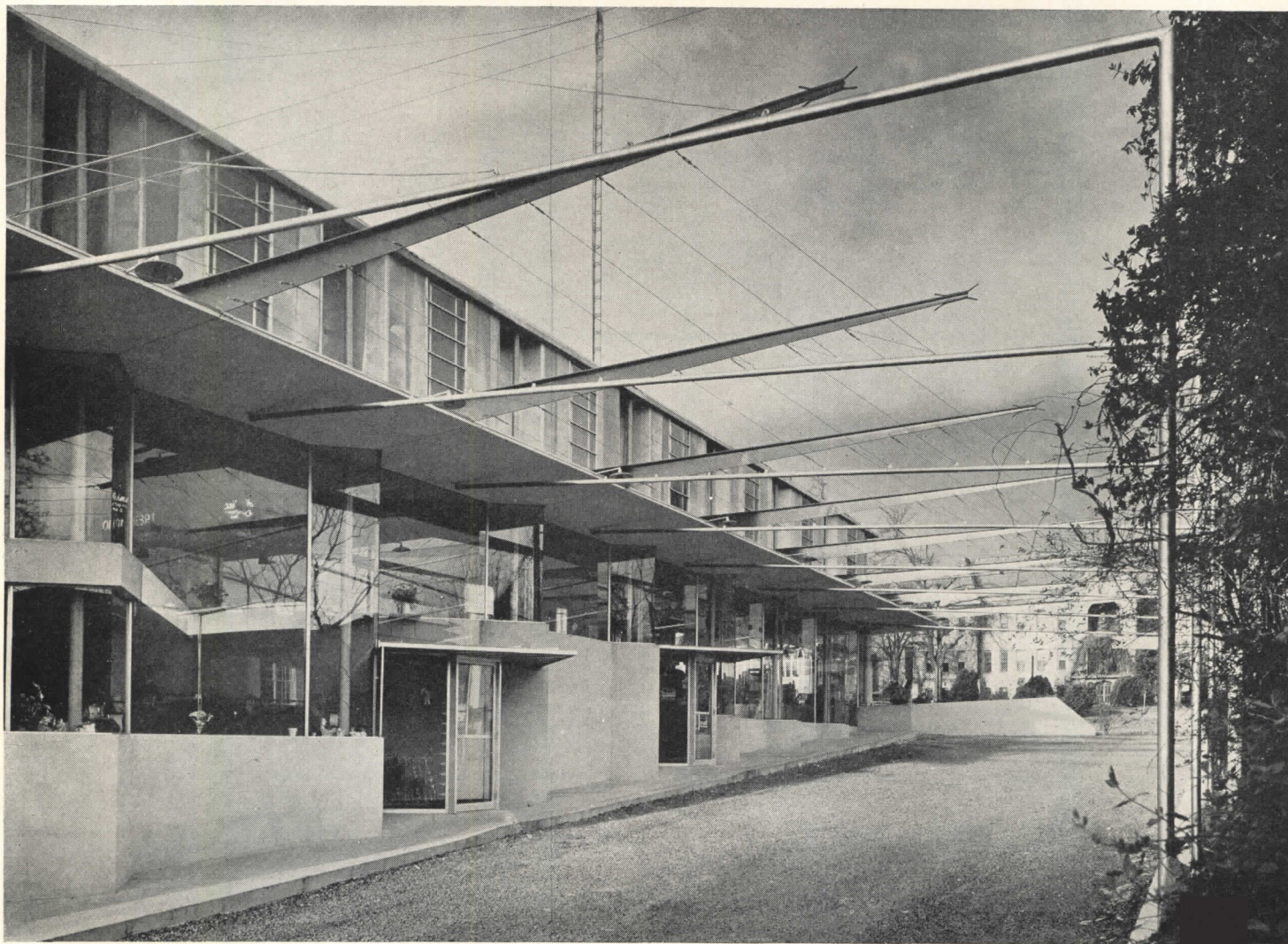
Joseph W. Molitor



# DRUG STORE

*Jackson, Mississippi*

*N. W. Overstreet & Associates, Architects*



A CIRCULAR GLASS-ENCLOSED STAIR, angled show windows, and a wire trellis over the parking area give this store and office building in Mississippi a look of light openness very welcome in the South.

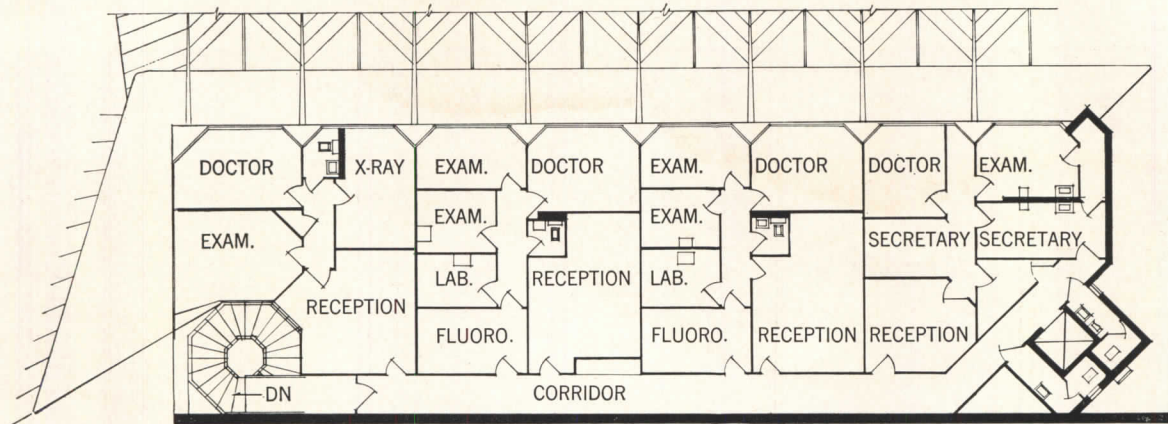
The building, designed by Robert K. Overstreet, an associate in his father's firm, is in a suburban business section of Jackson. The main floor is an unbroken sales area; glass walls along the north (parking) side and across the front permit customers to see the whole store as they enter, whether they arrive by car or by foot. The druggist, too, has a clear view of the entire floor from his office — a balcony at the rear, beneath which is tucked a florist's shop opening to the parking area. Storage space is in the basement.

The second floor of the building (plan next page) consists of several suites of doctors' offices, complete

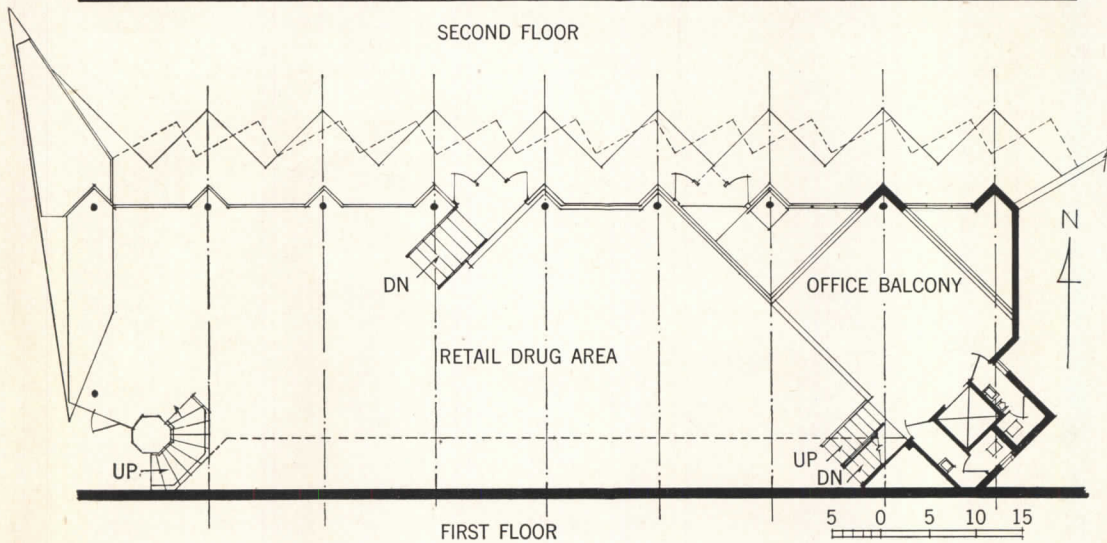
with laboratories, X-ray and fluoroscopy rooms. An elevator is provided for the use of patients who do not wish to or cannot use the circular stairs at the front. Those stairs, of course, are not merely an attractive feature of the building, but a sound merchandising feature as well: from them the second-floor visitors get a full view of the store's displays.

The exterior of the building has a flair about it which again indicates the merchandising sense of the architect. Over the parking area is a trellis of aluminum wire and stock steel shapes trimmed to a delicate profile; vines eventually will cover the wires, cutting down show-window reflections and *providing a cool greenness*. Across the front is a reinforced concrete canopy, roughly triangular, from which protrude decorative aluminum rods.

# DRUG STORE



SECOND FLOOR



FIRST FLOOR

*Druggist's office balcony is 5 ft above main floor; site slopes to rear, permitting florist's shop below balcony. Heating and air conditioning equipment is in basement. Building is reinforced concrete, built-up roof, 4-in. glass wool thermal insulation*

Joseph W. Molitor



# COUSINS FURNITURE AND APPLIANCE STORE

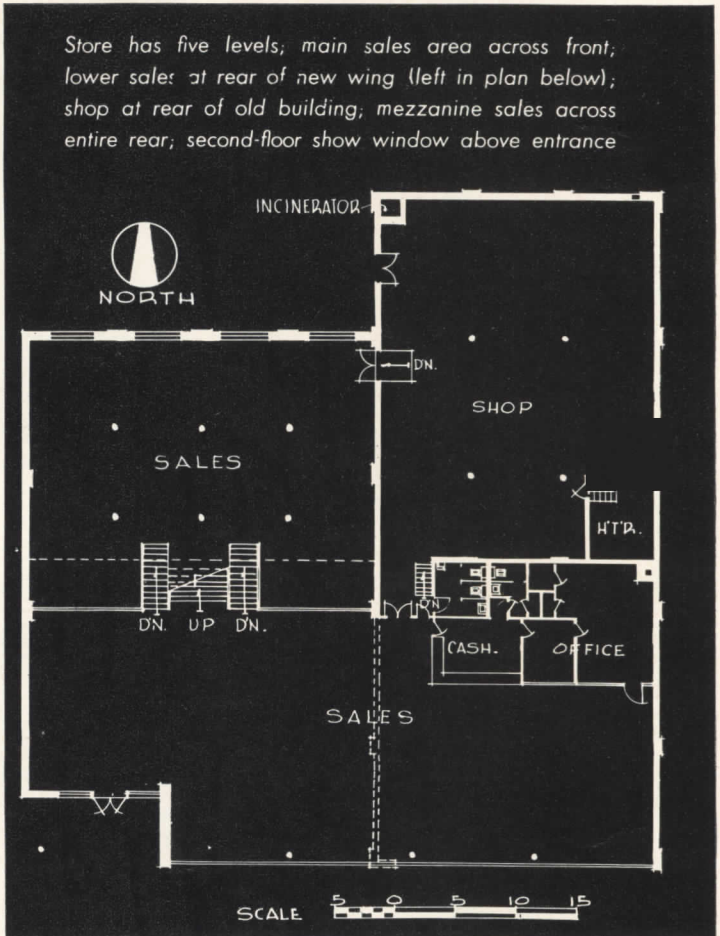
*Johnson County, Kansas*

*Kivett & Myers, Architects*

THE SITE of this store is on a highway leading to one of the better residential sections of Kansas City. Half of the building formally was a supermarket which was badly damaged by fire and subsequently remodeled; the other half (left on plan below) is new. The second

floor show window was the result of the owner's request for display space which could be seen by approaching motorists from the top of a nearby hill.

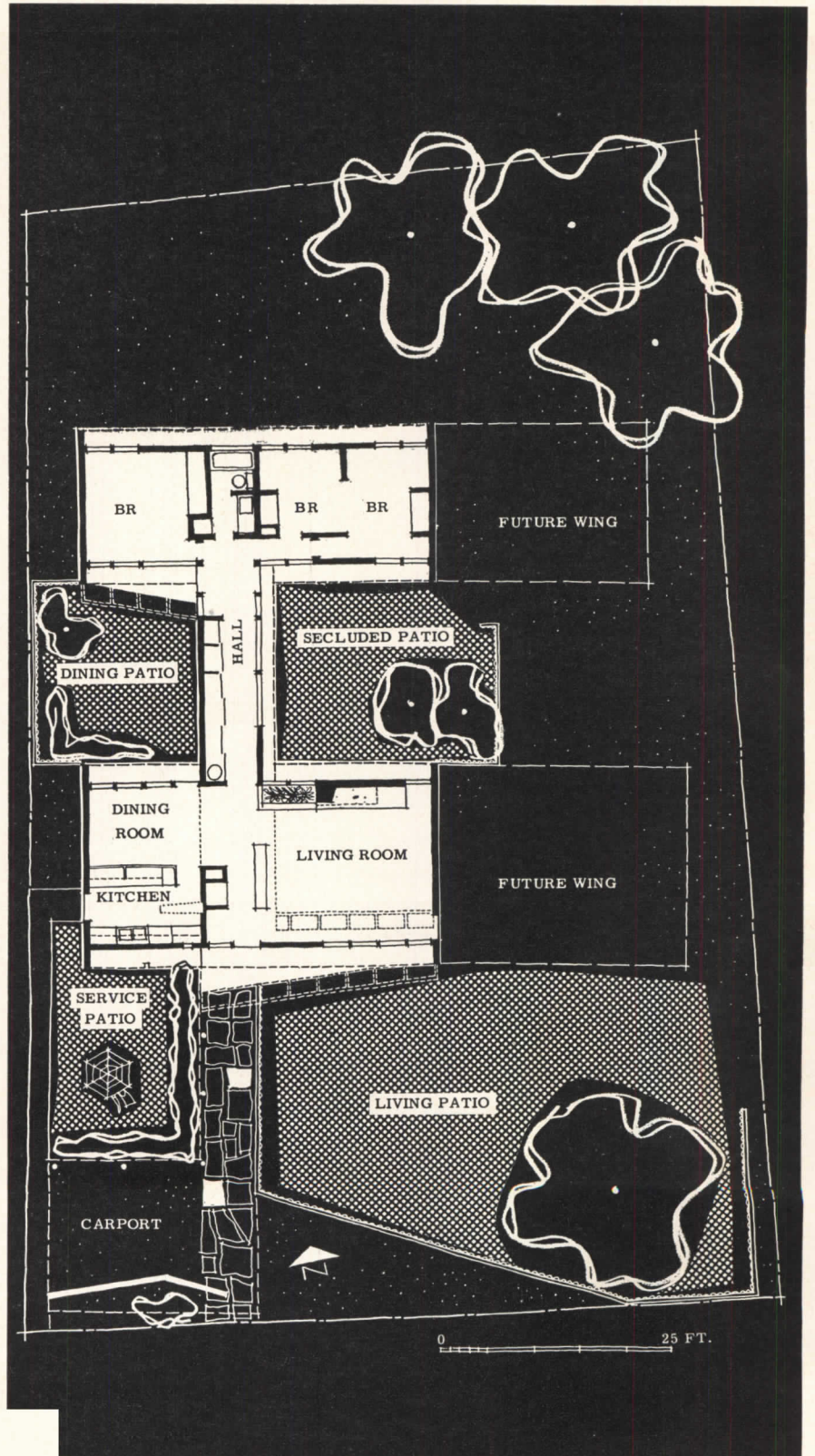
Foundations are stone (old portion of the building) and concrete block; exterior walls are red brick.



# MODERN INTERPRETATION REMINISCENT

*Residence for Mr. and Mrs. John J. Taylor,*

The function of the courtyard—that dominant characteristic of houses in New Orleans' French Quarter—is here freshly interpreted in a contemporary suburban house. Situated on a small lot with other houses adjacent, and in a climate that is very hot for nine months of the year, the bi-nuclear plan (right) resulted from the owners' requirements of the utmost in privacy and adequate ventilation. Fences and unbroken wall areas add to seclusion, and high ceilings contribute to additional air circulation besides creating a spacious effect. Carport and extension of wings are planned for future



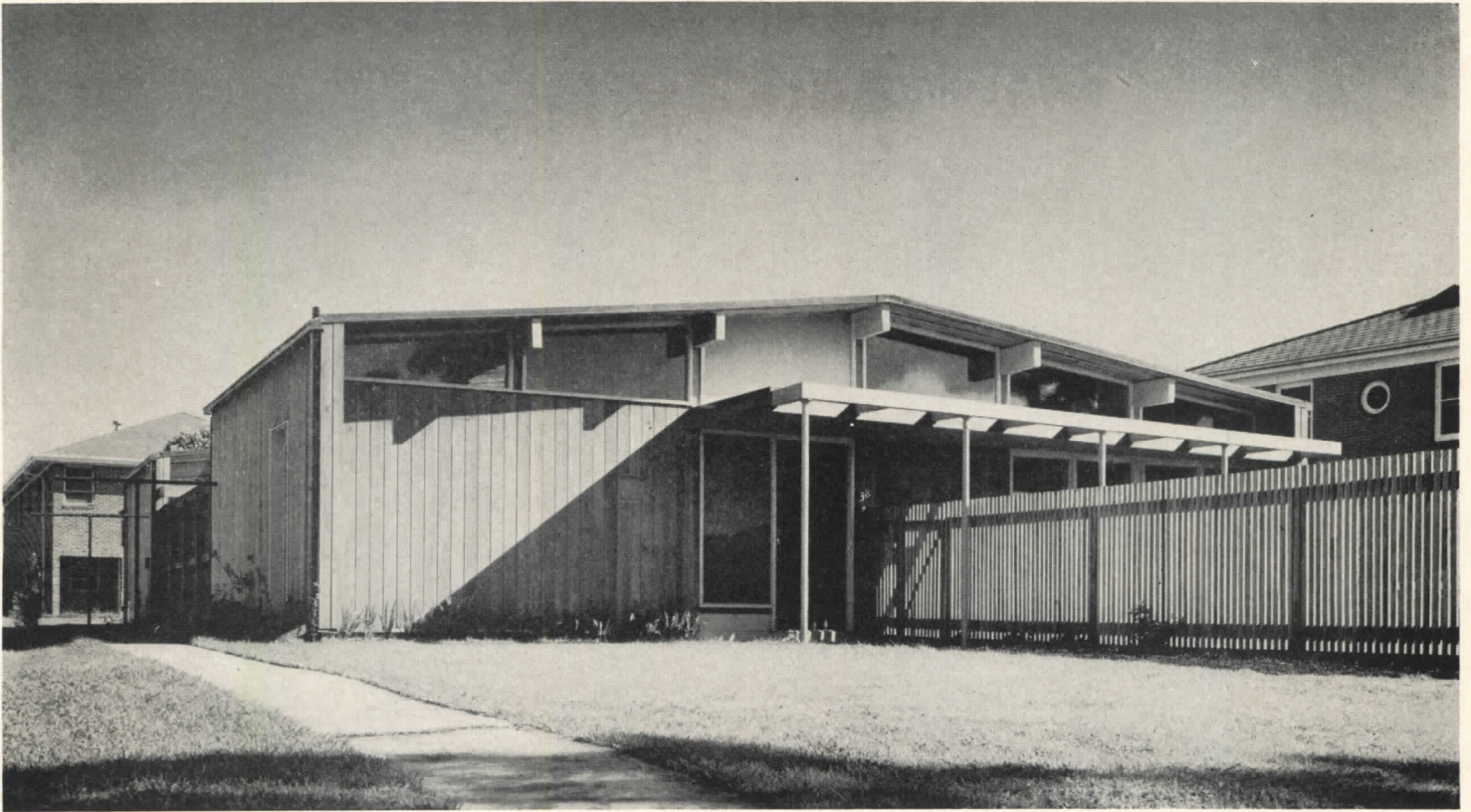


# OF OLD FRENCH QUARTER

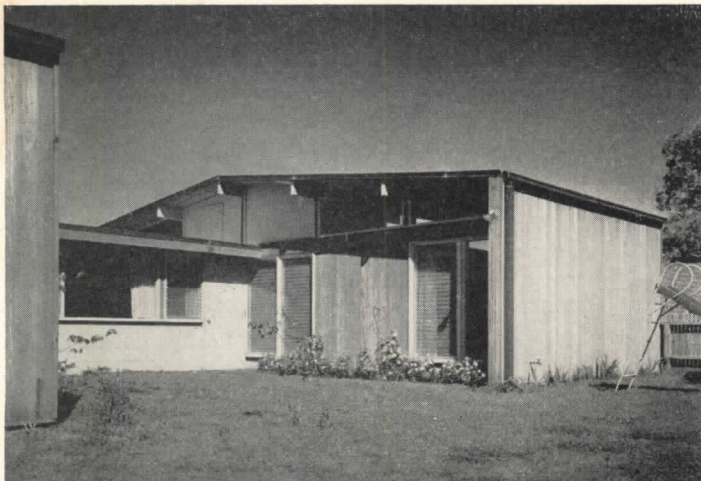
*New Orleans, Louisiana*

*Curtis & Davis*

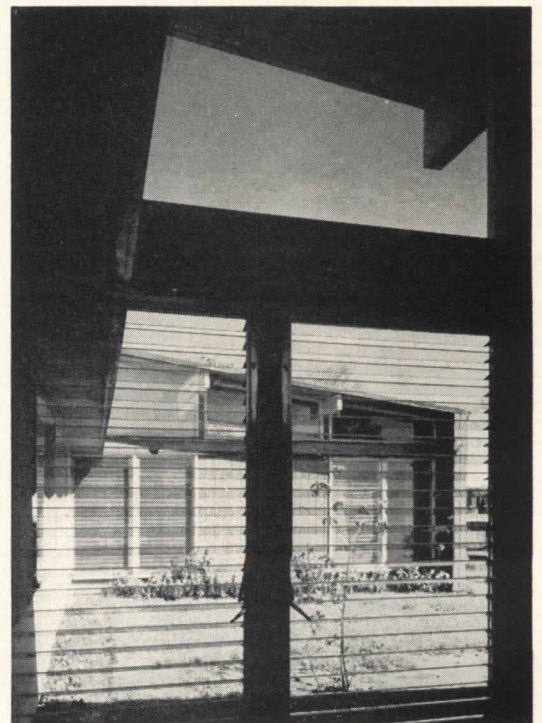
*Architects*

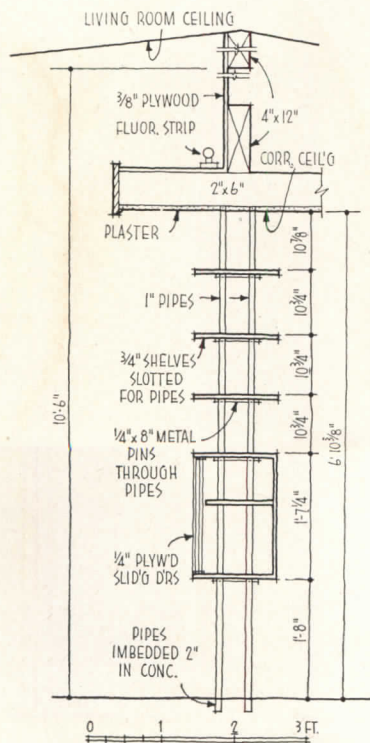


*Photo above illustrates how proximity to neighboring residences is relieved by fences and unbroken wall areas. Below: bedroom wing and view of courtyard*

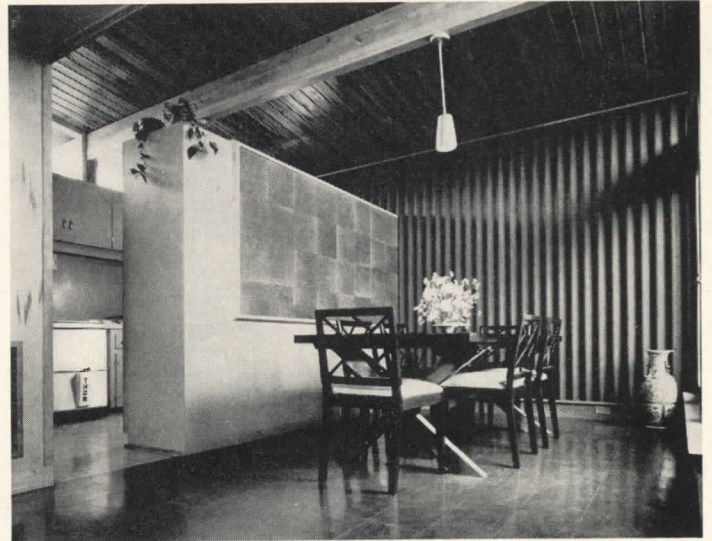
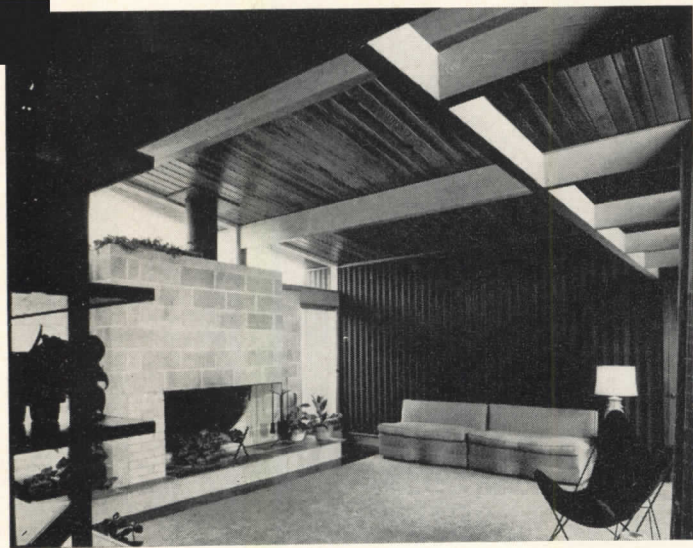
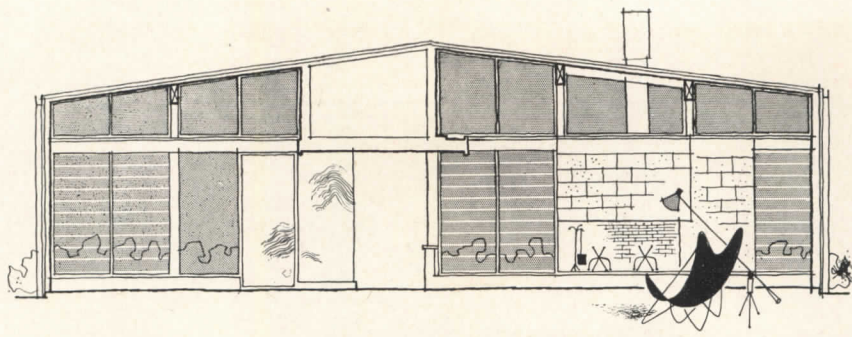


Joseph McIlhorr

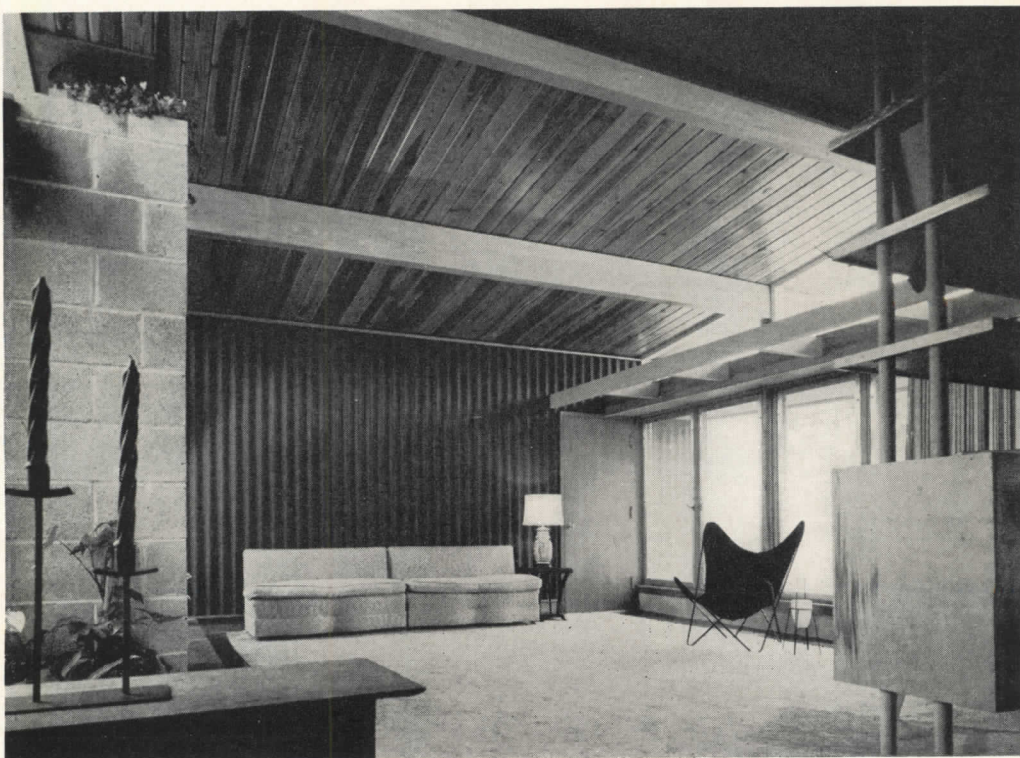




DESIGNED for a young couple with two small daughters, the house is located in a sub-division near New Orleans. Built on land reclaimed from Lake Pontchartrain, the house rests on a concrete slab which is poured over 6-in. shell fill and membrane waterproofing. Framing and siding are of Southern yellow pine, protected by a creosote stain, and the roof is heat-reflecting white marble chip composition over 2 in. of rigid insulation material. Roof sheathing of 2-in. tongue and groove decking has been left exposed inside. A spacious atmosphere has been attained through very high ceilings — broken only by interior extension of outside overhangs and a lowered ceiling in connecting corridor. Radiant heating system is located above connecting corridor, with two forced warm air heaters, one at either end. Outdoor patios may be reached from any part of the house, and childrens' room leads directly to play yard. Except for the bathroom, none of the partitions extends to the ceiling, contributing to improved air circulation throughout the house.

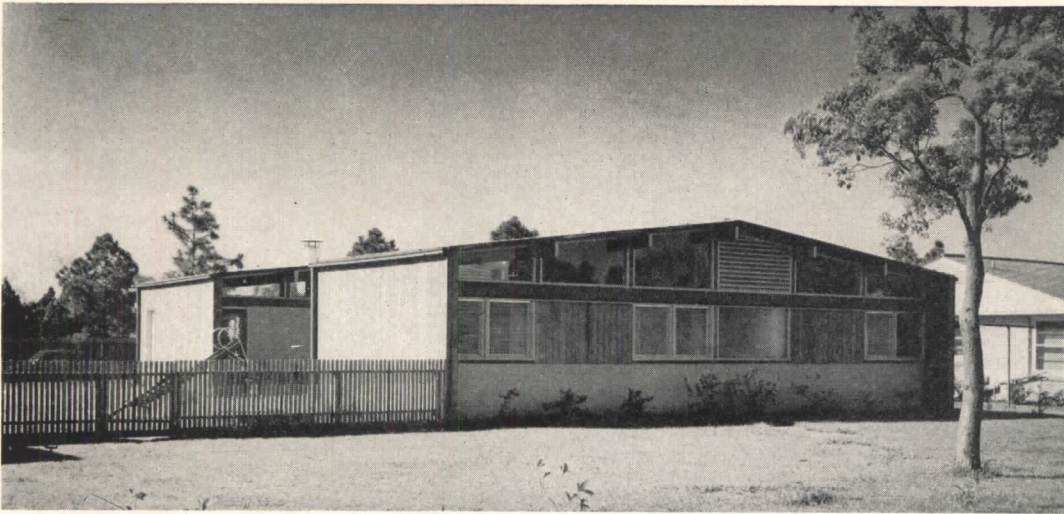


*Interiors are pine, plywood and corrugated asbestos sheeting. Future mural will be set in space provided on dining room wall. Detail at top is section of dining and living room wall. Bookcase (opposite) and low corridor ceiling help to recall domestic scale*



Joseph Mollitor

## LOUISIANA HOUSE

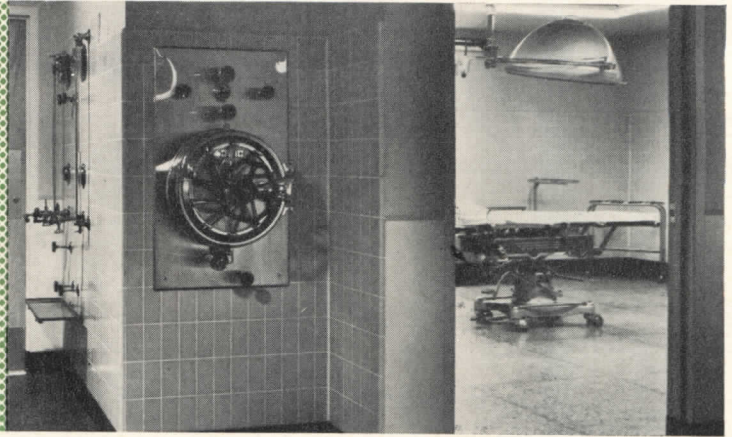


Joseph Molitor

*All openable portions of glazed walls are fitted with screened adjustable glass louvers, easily operated and providing excellent ventilation. Floors are asphalt tile and there is an exceptional amount of storage space for a house of this size. High ceilings are appropriate for Louisiana climate*



ARCHITECTURAL RECORD'S  
BUILDING TYPES STUDY  
NUMBER 191



Roger Sturtevant

# HOSPITALS

IN THE LAST YEAR or so the earlier Hill-Burton hospitals have been completed, adding substantially to the health facilities of the country. Only now are we seeing the tangible results of many years of study and effort, by Marshall Shaffer and his staff of architects in the U.S. Public Health Service, by many hospital agencies in the states, and by architects who have translated it all into building plans.

It has been interesting to watch so much concerted study of hospital planning, beginning a decade or more ago, and still going on. Major developments include: "Coordinated Hospital Service Plan," ARCHITECTURAL RECORD, Aug. 1945; "Elements of the General Hospital," A R, June 1946; "Plans of General Hospitals for the Coordinated Hospital System," A R, Jan. 1948; and revisions of the elements, A R, April 1952. Reprints of these U.S. Public Health Service reports have been circulated by the thousands, have become a considerable compendium of information on hospital planning. Incidentally, they are all being brought up to date and will soon be published in book form.

It has been especially interesting to see how these planning tools have been used. There were a few dire predictions that architects would "copy them cold," that "standard plans" would block advances in planning, would stifle initiative, would hamstring architects with bureaucratic control. But none of these woeful things has happened. Architects have welcomed the information, have used various elements as suggested, have learned much about planning, and they have planned better hospitals. There has been nothing restrictive or arbitrary in the process. Architects have invariably adapted the information to individual needs and circumstances, have invented new combinations; incorporated new ideas, have satisfied special requirements or whims of hospital boards and administrators, have added flexibility and expandability. The various planning aids have encouraged many architects to enter what was once a specialized field, have helped them

learn about hospitals, and have encouraged them to go on learning.

Several important developments have happened since the program started:

1. Sizes of hospitals have followed individual community needs. There are many more small hospitals than first proposed, and the really small ones have better equipment than was originally considered possible.

2. The expandable hospital has arrived — the "50-bed hospital on a 100-bed chassis," for example.

3. More equipment has become the rule, not only for contemplated expansion, but also for early ambulation. As the hospital stay has shortened, the use of hospital facilities has increased, so hospitals must now be planned for this increased turnover.

4. Personnel problems have also added to equipment. Hospital management is using the tricks of factory management, using more mechanical gadgets to cut labor costs.

5. Many medical developments have been accommodated in planning — the recovery room, for example, or provisions for a few mental patients in the general hospital, or increased toilet facilities or other devices to encourage self-help by patients. Or more facilities for occupational therapy, or more dayrooms for ambulant patients. Or, in some instances, more diagnostic facilities for out-patients.

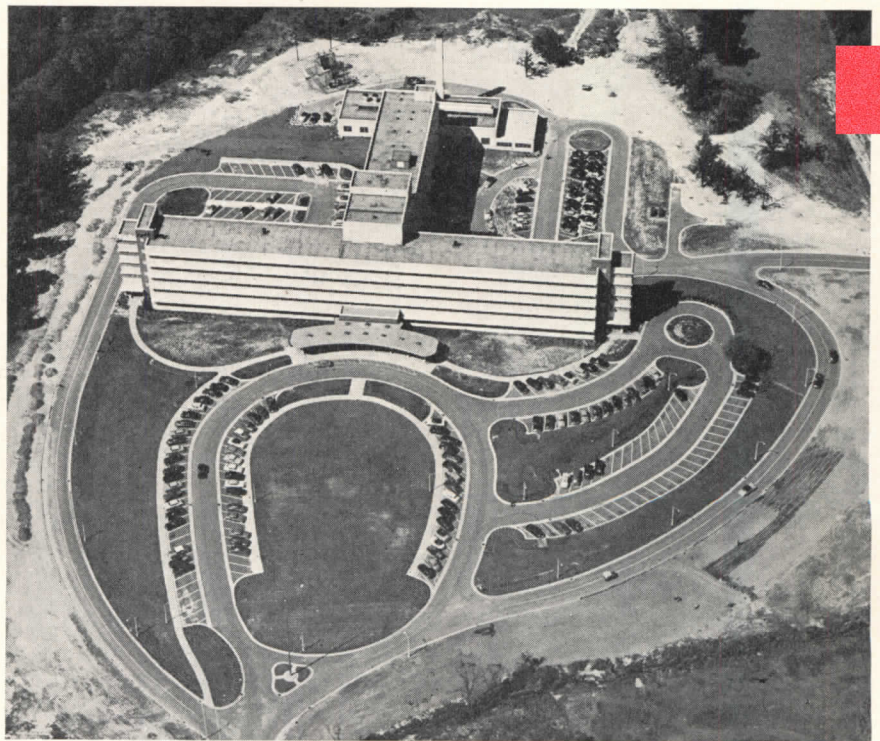
6. Costs have skyrocketed. Federal funds, against present costs, have become a mere trickle. Nevertheless the Hill-Burton program has made hospital care available in many communities which never had it before, has "sold" hospital care, and the demand is still increasing.

This Building Types Study comprises six carefully selected Hill-Burton hospitals, in representative sizes from 20 to 285 beds. All show evidences that the basic planning information has been well assimilated; more important perhaps, they all show great ingenuity by their individual architects.



Thigpen

*Mobile Infirmary occupies a large wooded site, formerly a golf club. There is approximately a mile of roadways and several acres of parking space. Scheme contemplates later construction of a nurses' building for residence, recreation and training of nurses*





*Mobile Infirmary, Mobile, Alabama  
Platt Roberts & Company, Architects*

*Reg. F. Taylor, Mechanical Engineer*

*R. S. Christiansen, Structural Engineer*

*W. C. Pauley, Landscape Architect*

*Clyde Sibley, Medical Consultant*

## 285-BED HOSPITAL PLANNED FOR TRAINING

**T**HOUGH it has not at present fully reached that status, this hospital fits into the coordinated hospital system as a teaching hospital. It is quite large, 285 beds, and is one of relatively few of its classification to have assistance from the Hill-Burton program.

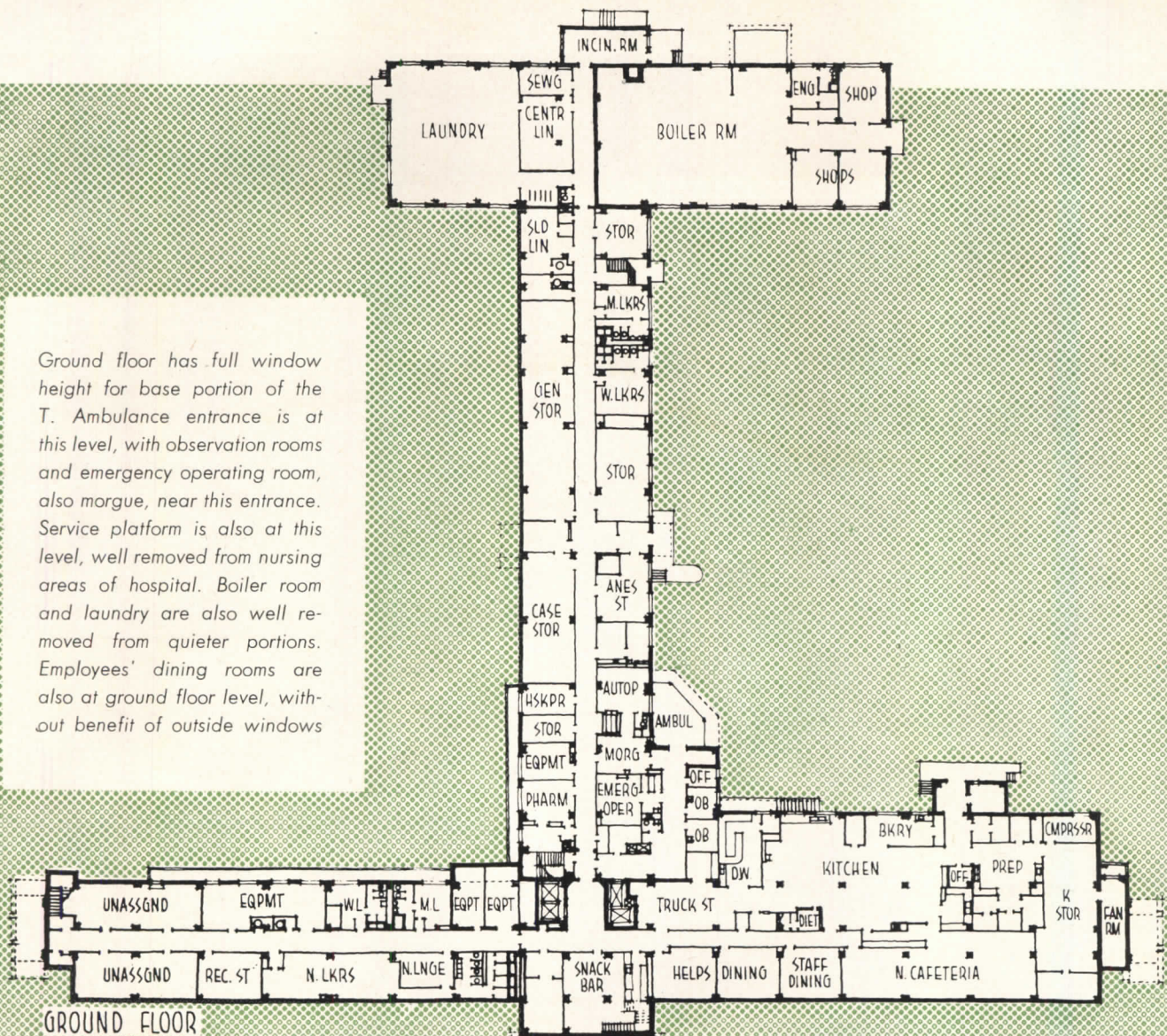
Perhaps it should be explained that this is primarily a hospital, not an educational institution, and its classification for teaching has not greatly affected its planning. It is, in short, a normal general hospital, larger than most in the program, with the usual elements and facilities but more of them. The final scheme contemplates a nurses' building, with living quarters, recreational and teaching facilities. Meanwhile there is a teaching room in connection with each nurses' station, where instruction can be given.

The design assumes visiting doctors, no provisions being made at the present for interns or resident doctors;

the building can be expanded to fulfil these requirements if they prove necessary.

The plan of the hospital is interesting; in general it is conventional, a T form for the separation of medical facilities and nursing units. It might be said that the scheme is a combination of the horizontal and vertical concepts of hospital planning, striking a reasonable balance between horizontal and vertical travel distances. The distances through the medical departments seem fairly long, but with departments the size of these, a great deal of walking is unavoidable, no matter how the departments are disposed. And confining the building to five major floors obviates certain of the vertical travel. Where travel distances are most important — within the nursing units — it is well confined, with nurses' station and facilities centrally located, and with corridors at least partially double-loaded. Each nursing

Ground floor has full window height for base portion of the T. Ambulance entrance is at this level, with observation rooms and emergency operating room, also morgue, near this entrance. Service platform is also at this level, well removed from nursing areas of hospital. Boiler room and laundry are also well removed from quieter portions. Employees' dining rooms are also at ground floor level, without benefit of outside windows



Thigpen



unit has a nominal capacity of 26 beds, the two-bed rooms without toilets placed closest to the nurses' station.

The building is reinforced concrete frame construction with concrete floor and roof slabs and masonry curtain walls. Face brick is light buff and dark maroon. Architectural stone copings are light buff, spandrels dark coral pink. Concrete hoods over windows and portico are painted concrete; windows are aluminum.

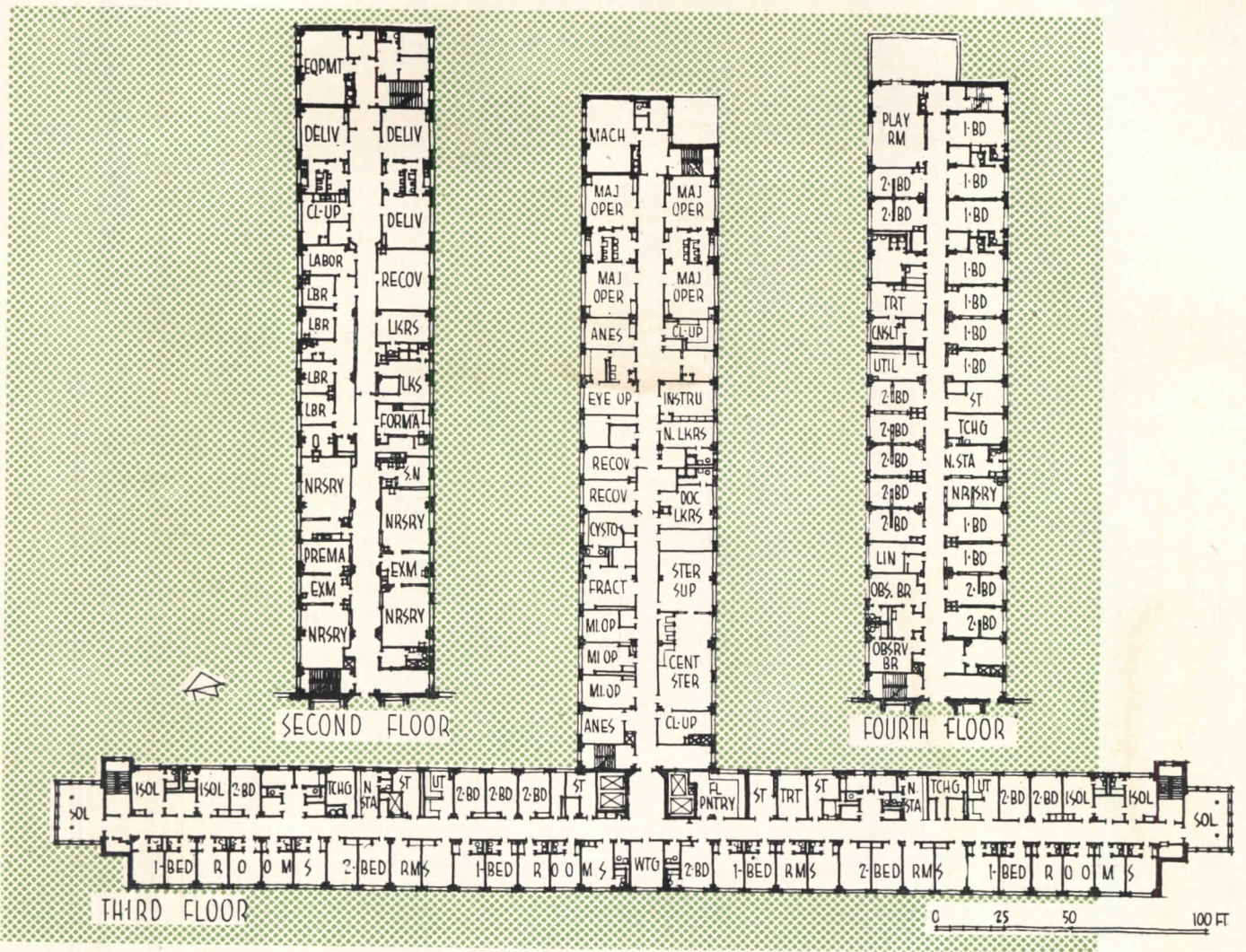
In the interior, walls and ceilings are generally of plaster. Floors are ceramic, quarry, asphalt or rubber tile and terrazzo. At present air conditioning is confined to public areas, operation, delivery and service suites, though provisions have been made for air conditioning bedrooms where desired.

The site is exceptionally good; it is close to the city but quite beautiful. It was originally a golf course.

Costs are given at \$3,100,000 for building construction, \$4,500,000 including equipment. Total area is 210,000 sq ft.







Thigpen

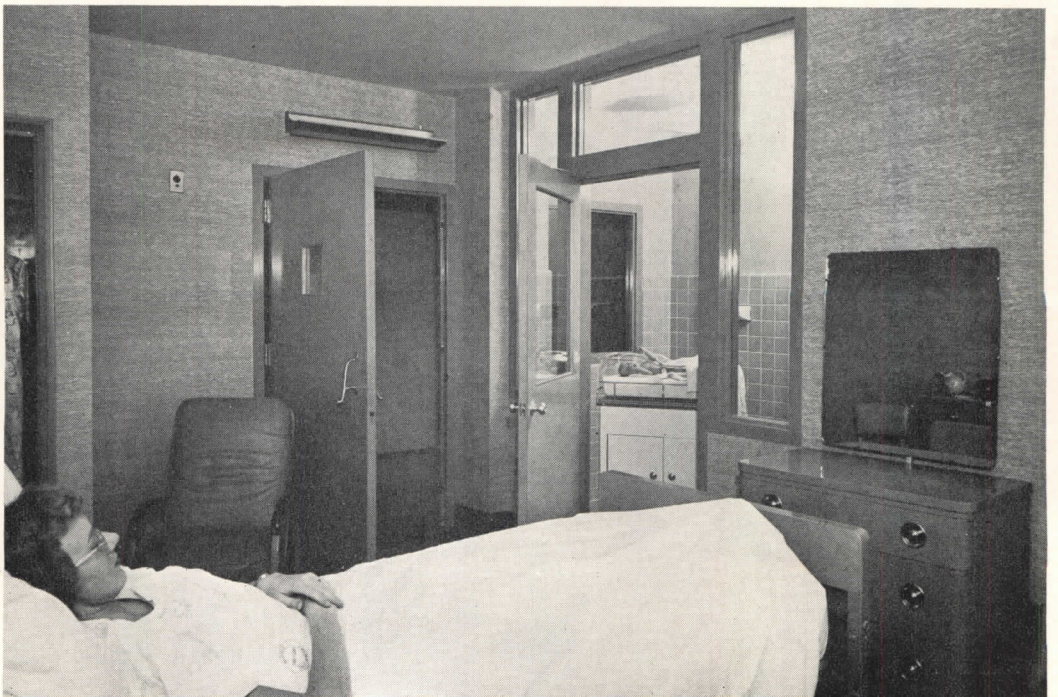
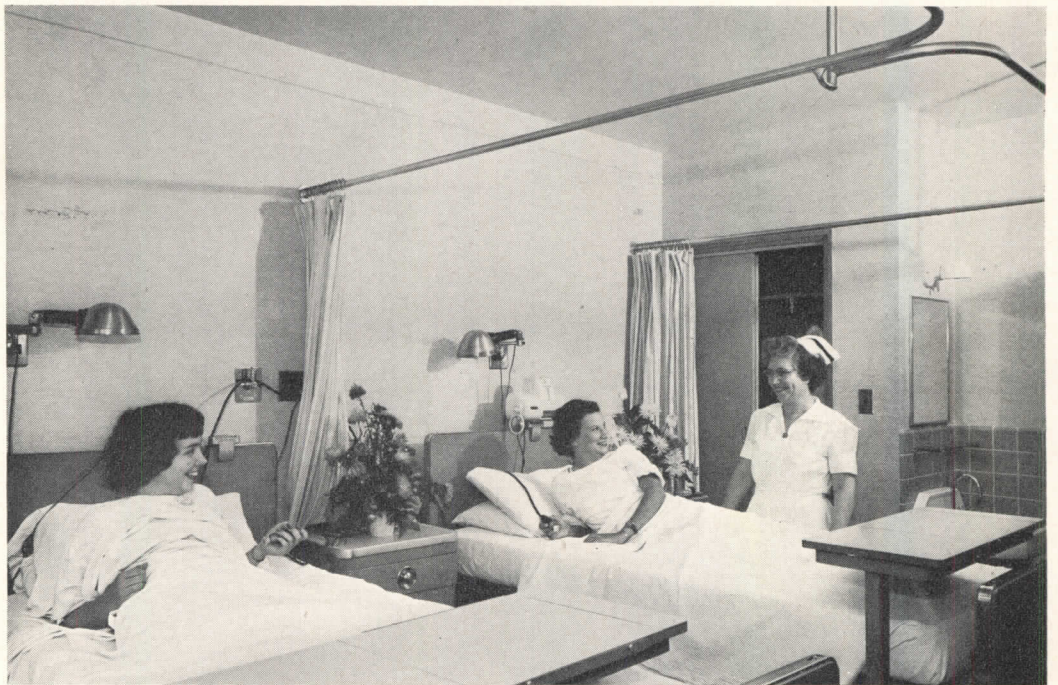


Upper floors are the same in the main portion, with two nursing wings per floor, differ as shown in the rise of the T: obstetrical and nurseries on the second, surgical department on the third, pediatrics on the fourth. Pediatrics section is exceptionally large and well-equipped



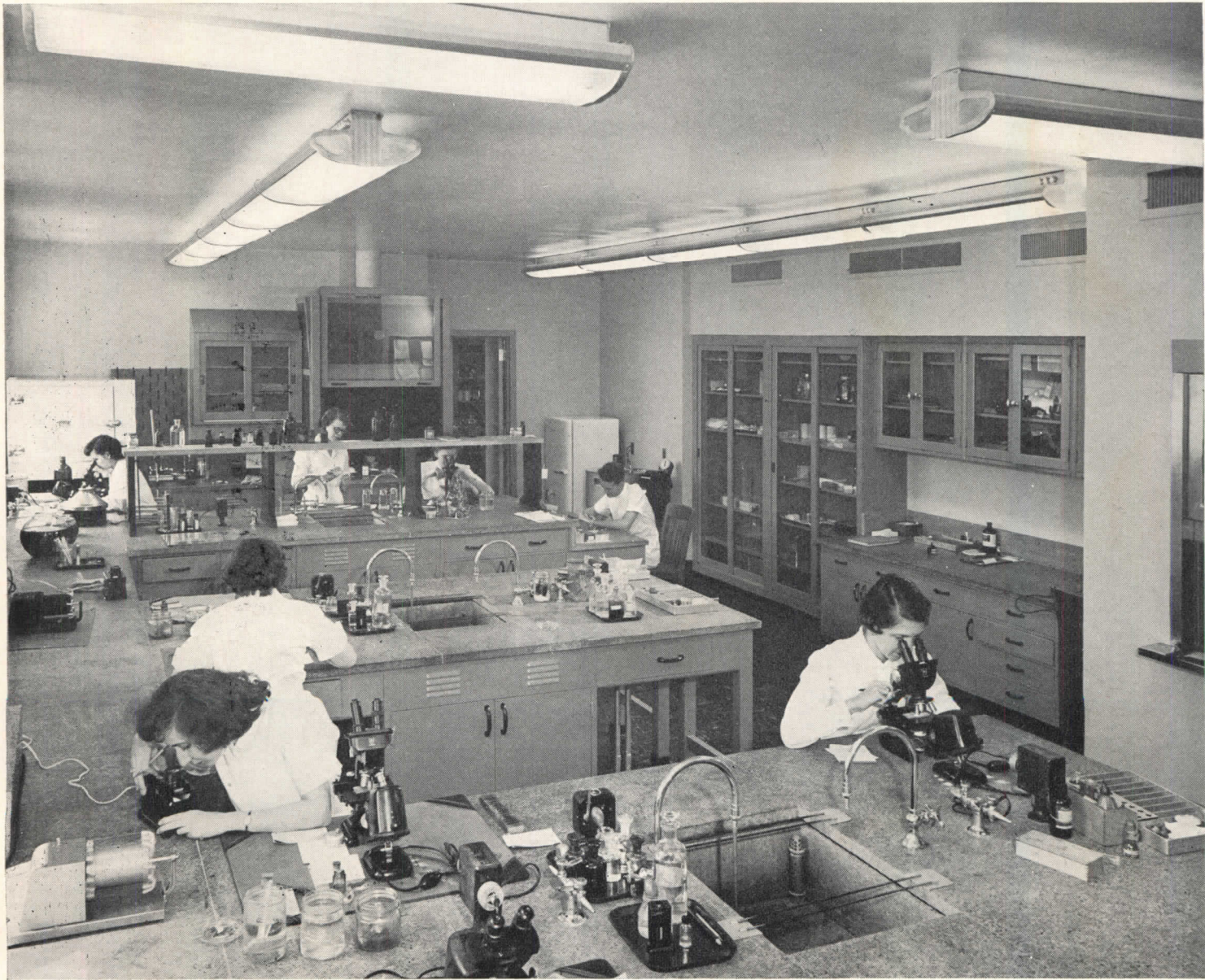
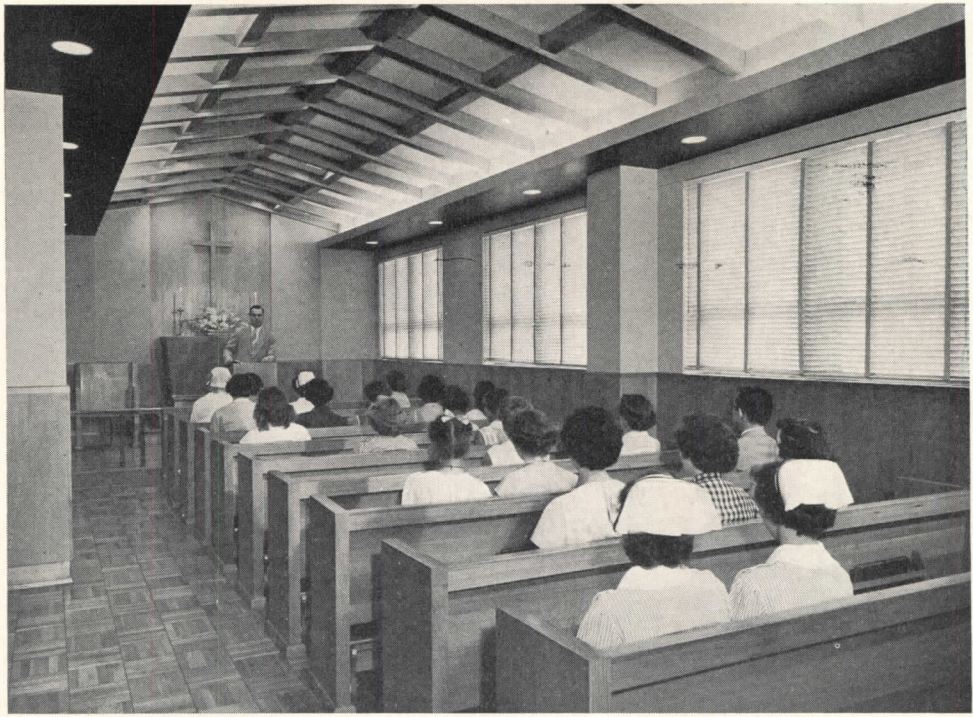
Opposite page: cashiers' counter is conveniently but unobtrusively placed near main lobby but not within it. Above: lobby is finished in pink marble and is air conditioned. Right: outpatient department opens directly off lobby





Opposite page, upper: typical private room, equipped with window air conditioning unit; center: typical two-bed room; lower: isolation room, looking toward sub-utility room. Below: one of the nurseries, as seen from the examining room where doctors see babies

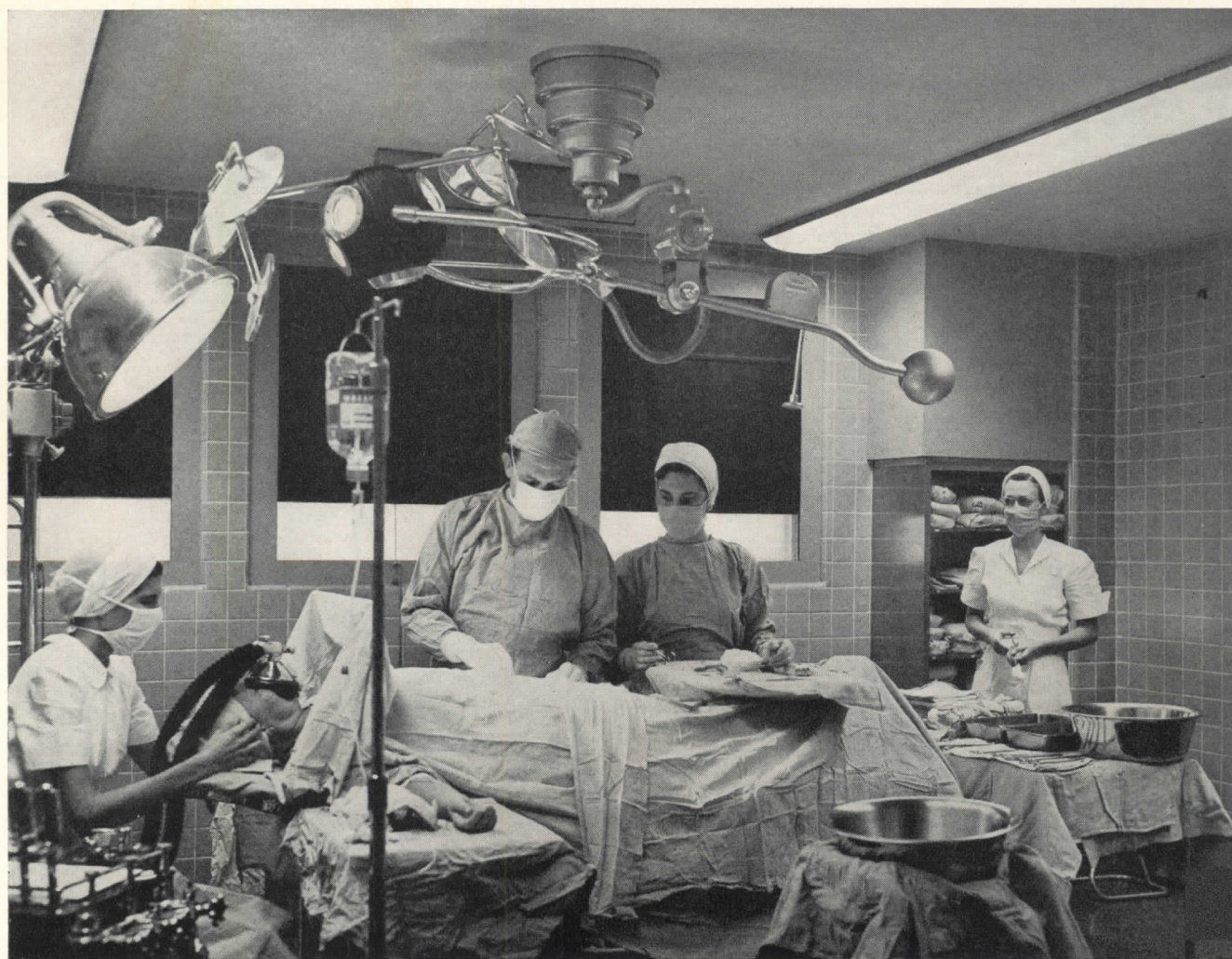






*Opposite page: chapel for worship by patients or personnel. Left: food carts for distributing meals from main kitchen to floor pantries. Opposite page, below: general laboratories. Below: one of the major operating rooms in use. Lighting is carefully controlled, with light-tight shades at windows, plenty of general lighting to obviate strong brightness contrast between strong local light and the surrounding background of the room*

Thigpen





## PACE-SETTER HOSPITAL STRESSES EQUIPMENT

*Marin General Hospital, Greenbrae, Calif.*

*Robert Stanton, Architect*

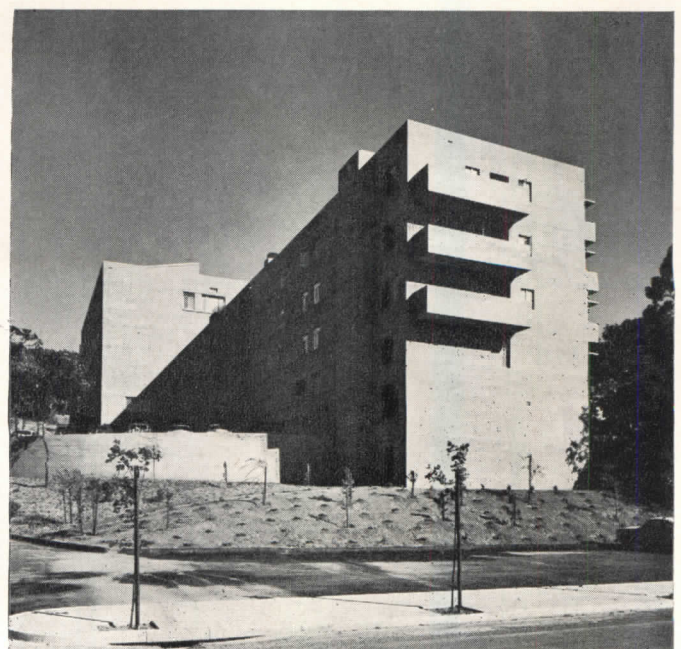
*Dr. J. A. Katzive, Consultant*

*Henry X. Jackson, Consultant and Administrator*

*MacD. Perkins, Structural Engineer*

*Clyde E. Bentley, Mechanical Engineer*

*Lawrence Halprin, Landscape Architect*





A PACE-SETTER in many respects, this hospital is especially notable for its equipment and facilities. Nominally a 100-bed hospital, it has operating department and adjunct facilities for a hospital perhaps twice that size, not primarily because large expansion is planned, but rather because early ambulation and modern medical techniques mean that medical facilities are more important than bed count.

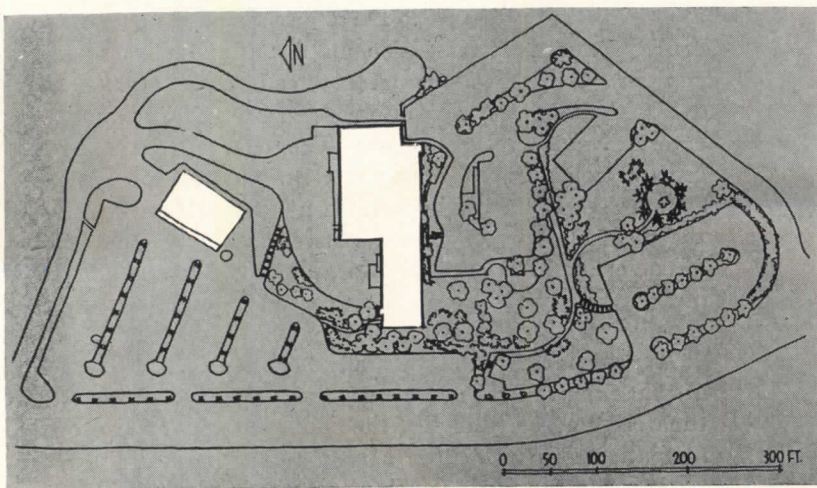
The operating suite has five major operating rooms. Though two of these are specially designated — orthopedic and cystoscopic — both are full-scale and fully equipped. In addition, the two in the emergency department — one designated as fracture room — are also full-scale operating rooms. There is also, of course, the separate obstetrical suite, with two delivery rooms.

The dictate of full medical facilities has added heavily to the equipment of this hospital in many departments. There is, for example, a variable temperature control room (fourth floor). It is used as a diagnostic aid for cardio-vascular disorders. The room may be taken through a series of rapid temperature changes from 0 to 75 deg C; by measuring the response or the rate of skin temperature change, the extent of damaged nerves and tissues can be determined. There are two allergy rooms, with air conditioning and electrostatic filters. There are two "maximum security" rooms. Laboratory and X-ray departments are exceptionally well equipped, also the physical therapy department. Both pediatrics and nursery sections are especially well planned.

Equipment generally is generous. For a few items: toilet facilities in all rooms; two-way communication system from bedside to nurses' station; piped in oxygen;



Roger Sturtevant



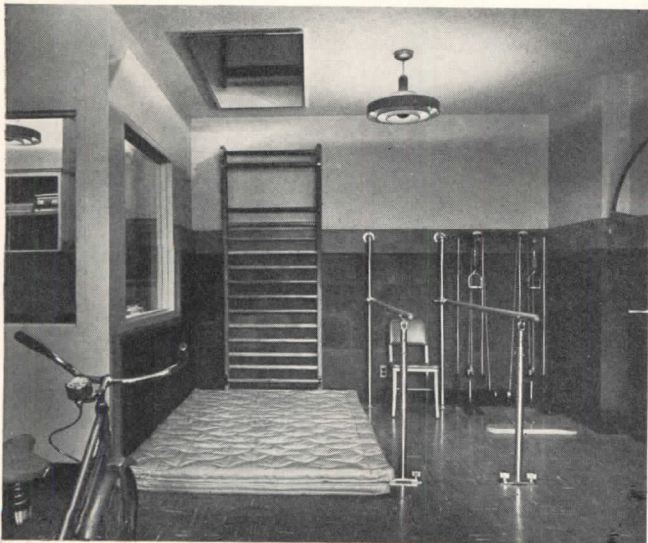
Building in rear is small storage warehouse





Roger Sturtevant

*Physical therapy suite (first floor) is compact, but exceptionally well equipped, and is very heavily used*

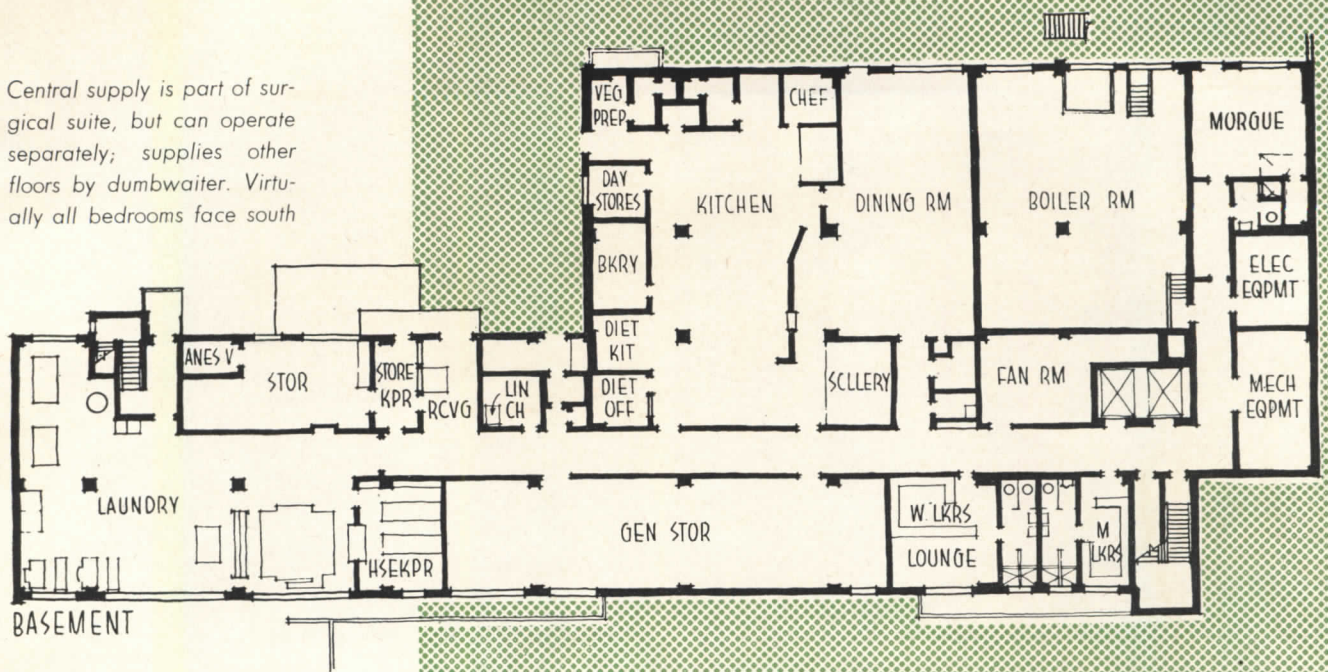


telephone jacks in all rooms; mail chutes from nurses' station to office; central dictating system, with 12 substations, for doctors to dictate their records. The need for cracked ice on the floor "has been completely obviated by piping ice water to the nourishment rooms, and using vacuum jugs at bedside, and by using iceless oxygen tents and freez-a-bag units instead of ice bags."

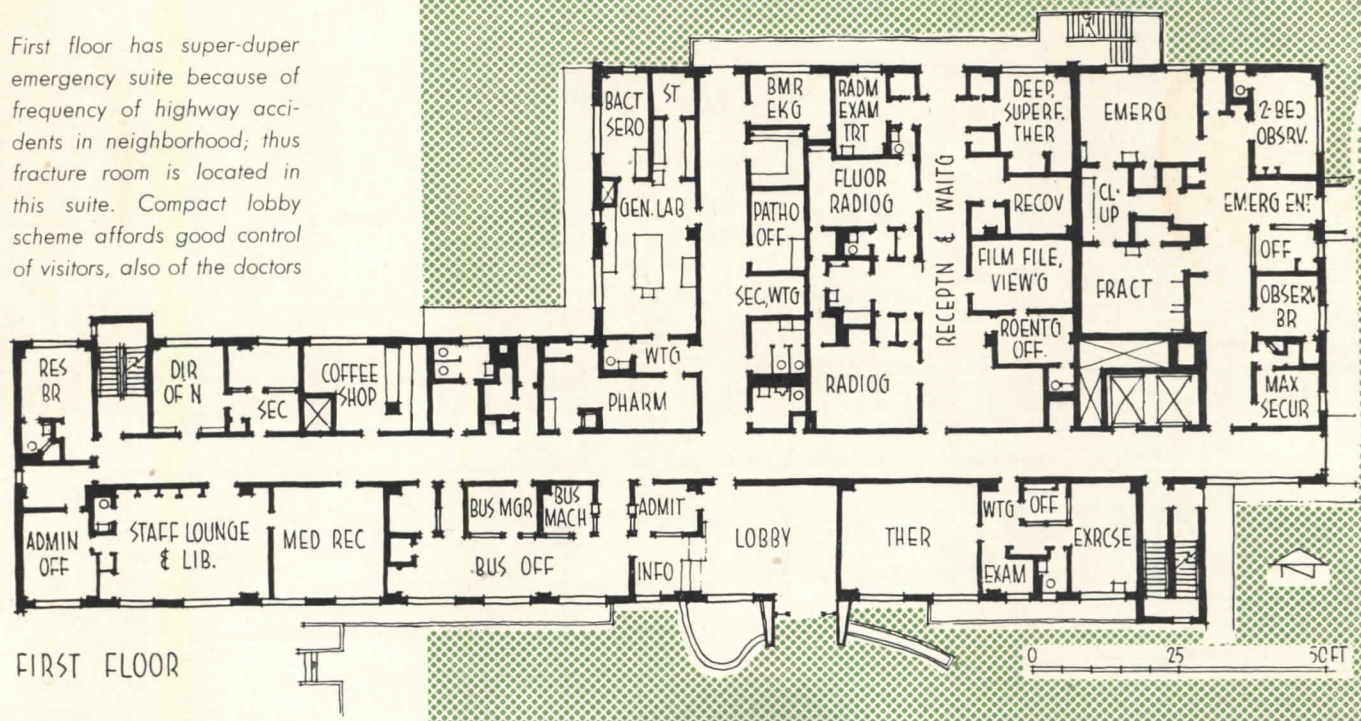
The building is of reinforced concrete frame and exterior walls and sunshades. The concrete has the integral color that has become almost a trademark of Stanton's hospitals. The color is a light salmon pink; the surface is sometimes sandblasted to give the effect of travertine. The integral color, plus the use of aluminum sash, virtually obviates exterior maintenance expense.

The site is large and naturally beautiful, with views of that famous Mt. Tamalpais, the view exposure fortunately corresponding to the desirable sun exposure for patients' rooms. Since Marin County is entirely a vehicular community, parking space has been provided for more than 300 cars.

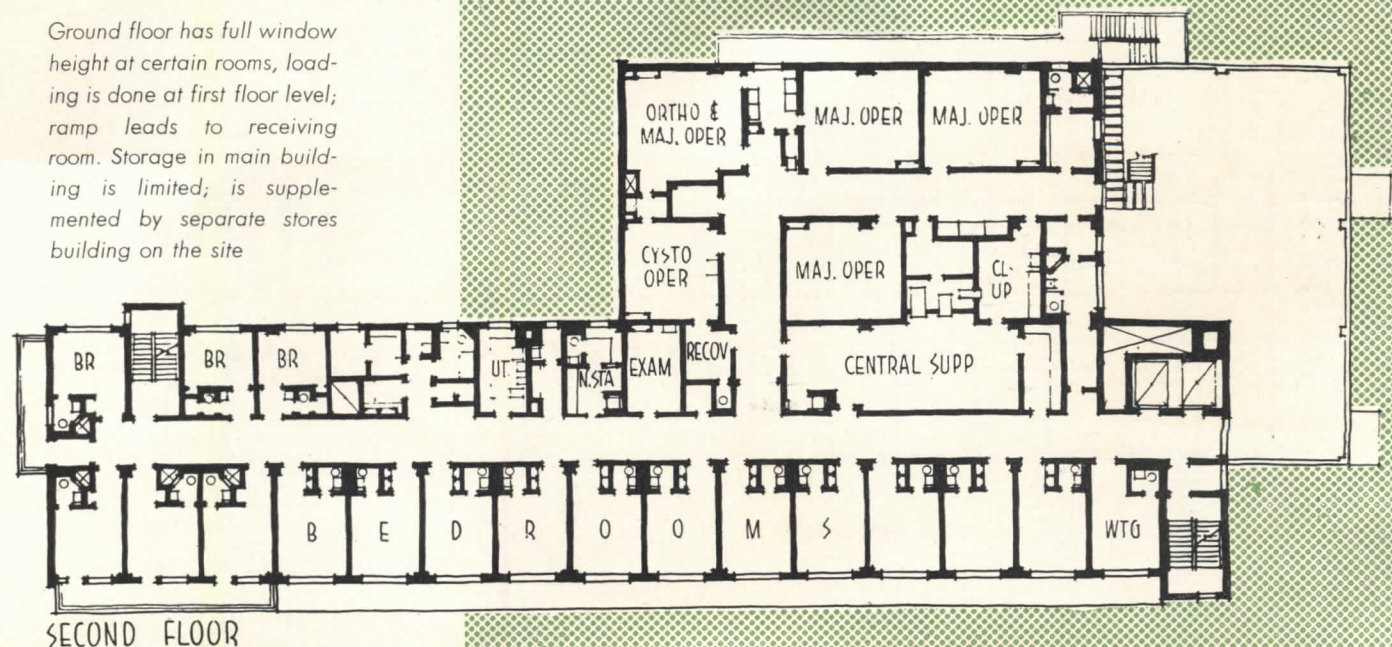
Central supply is part of surgical suite, but can operate separately; supplies other floors by dumbwaiter. Virtually all bedrooms face south

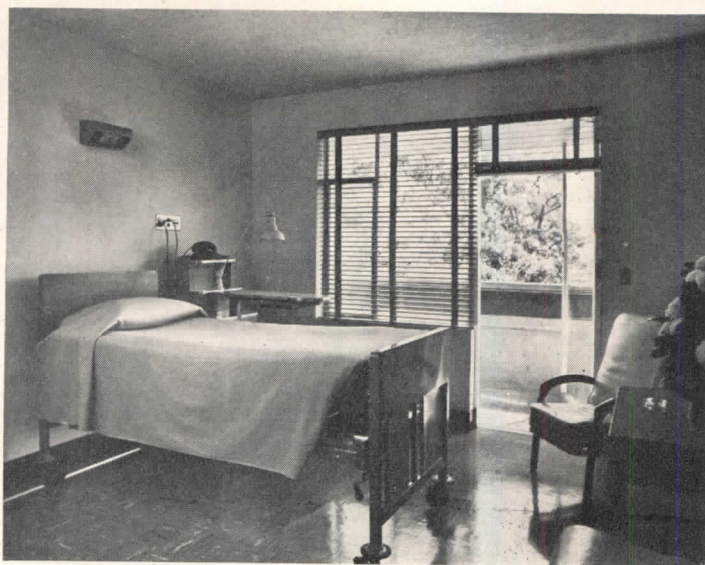


First floor has super-duper emergency suite because of frequency of highway accidents in neighborhood; thus fracture room is located in this suite. Compact lobby scheme affords good control of visitors, also of the doctors

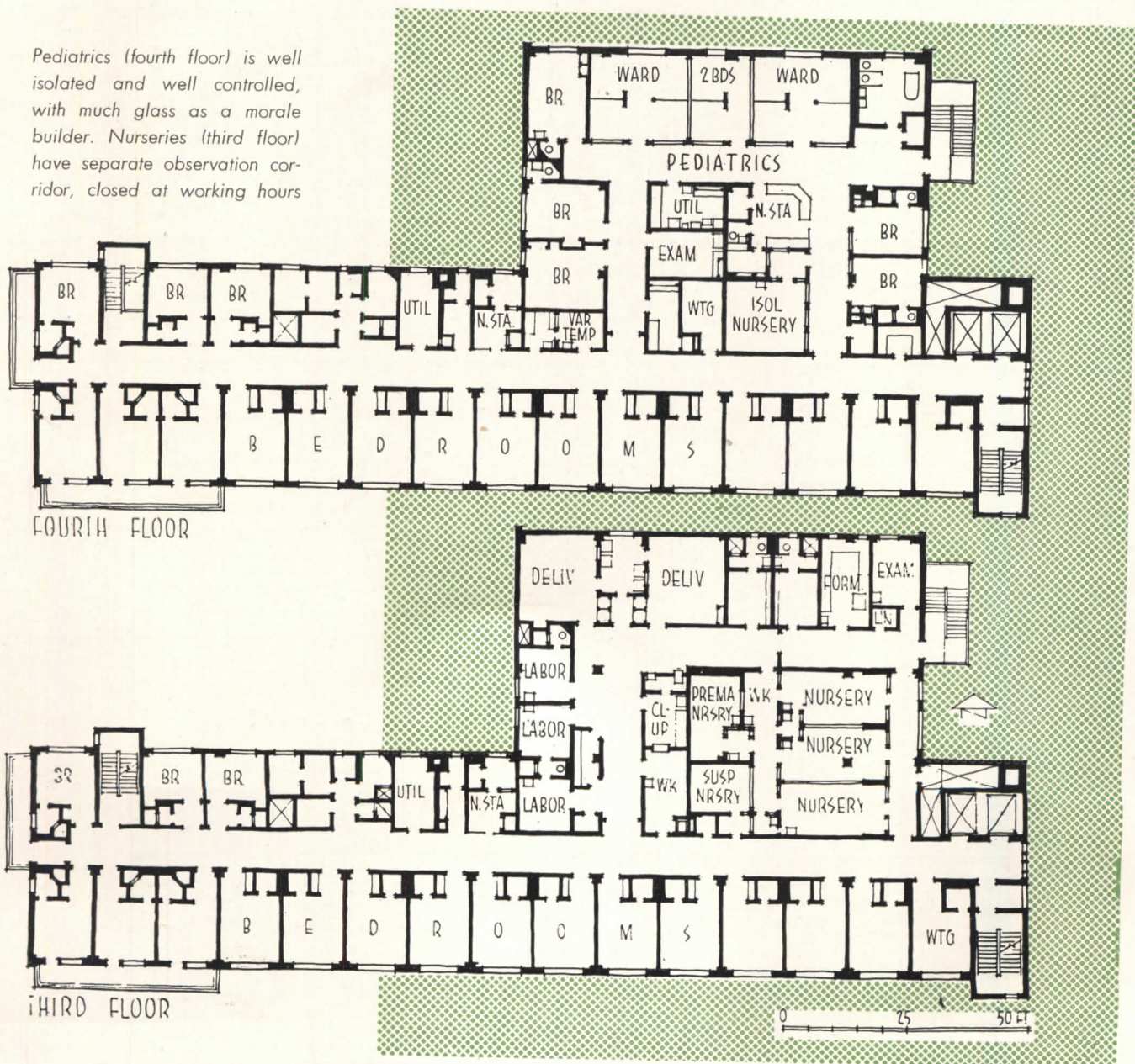


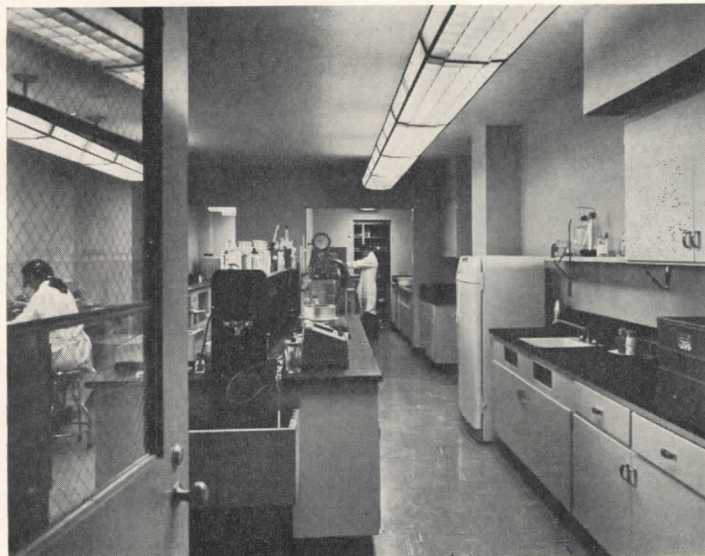
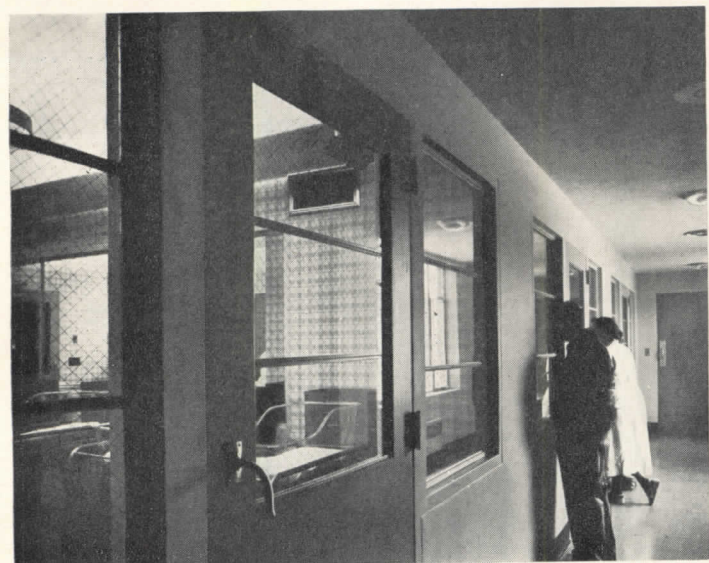
Ground floor has full window height at certain rooms, loading is done at first floor level; ramp leads to receiving room. Storage in main building is limited; is supplemented by separate stores building on the site





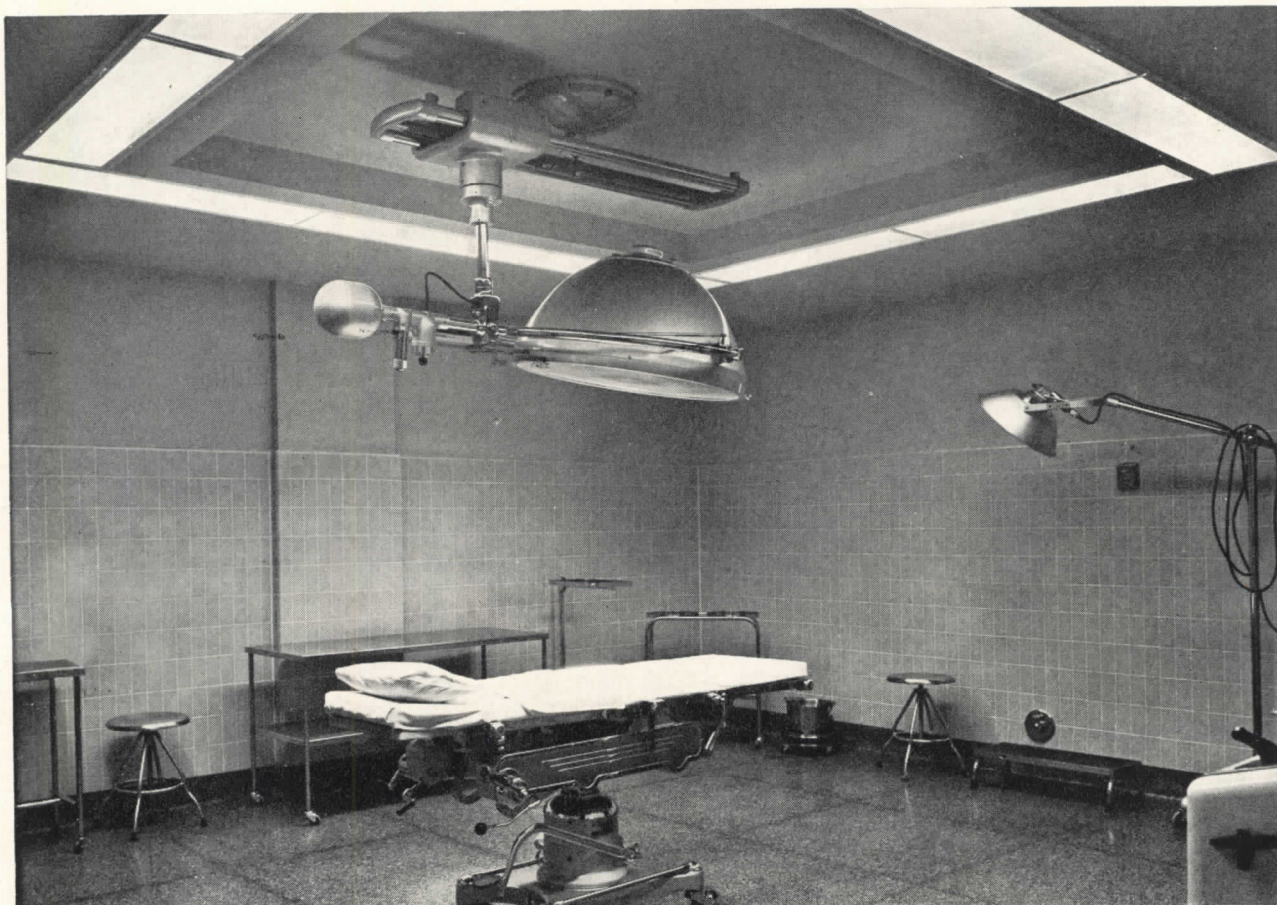
*Pediatrics (fourth floor) is well isolated and well controlled, with much glass as a morale builder. Nurseries (third floor) have separate observation corridor, closed at working hours*



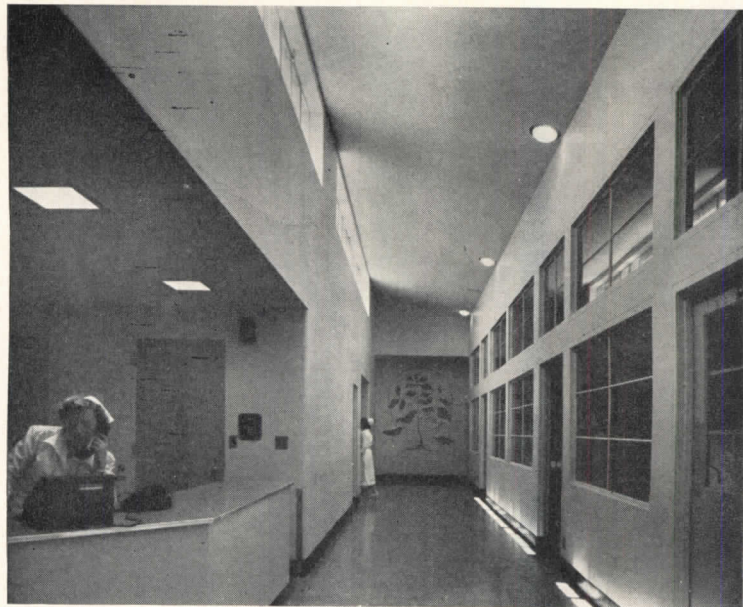


*Left to right: nurses' station; view of private room; nursery observation gallery; laboratory. Below: one of the major operating rooms. Note the peripheral lighting around operating table, to keep down brightness contrasts for surgeons*

Roger Sturtevant



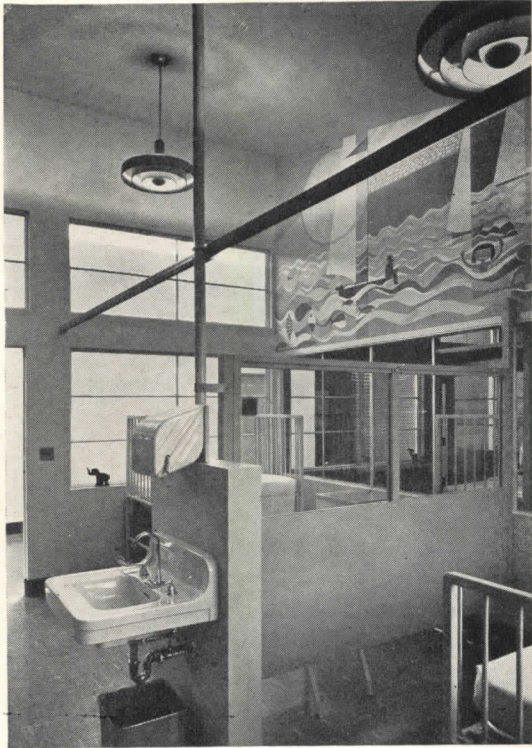
*Laundry works on assembly line basis, has full daylight. Right: nurses' station for pediatrics*



*Below: kitchen uses individual tray system, with preheated pyrex units to keep food hot. Trays are prepared, to individual orders, on one serving counter. Kitchen is quite compact*

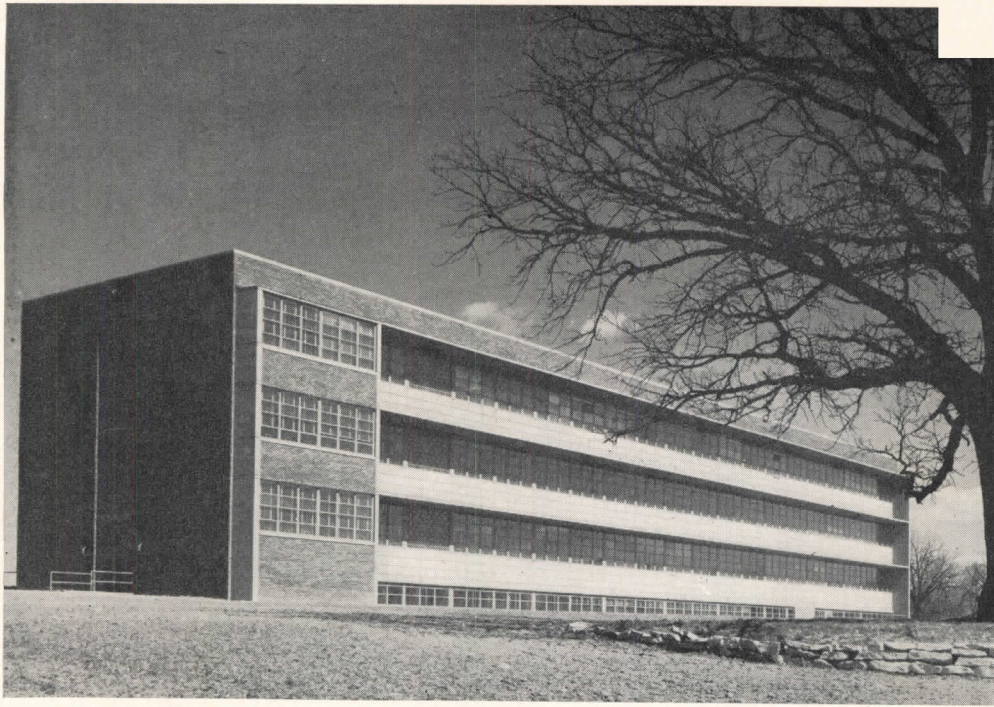


Roger Sturtevant

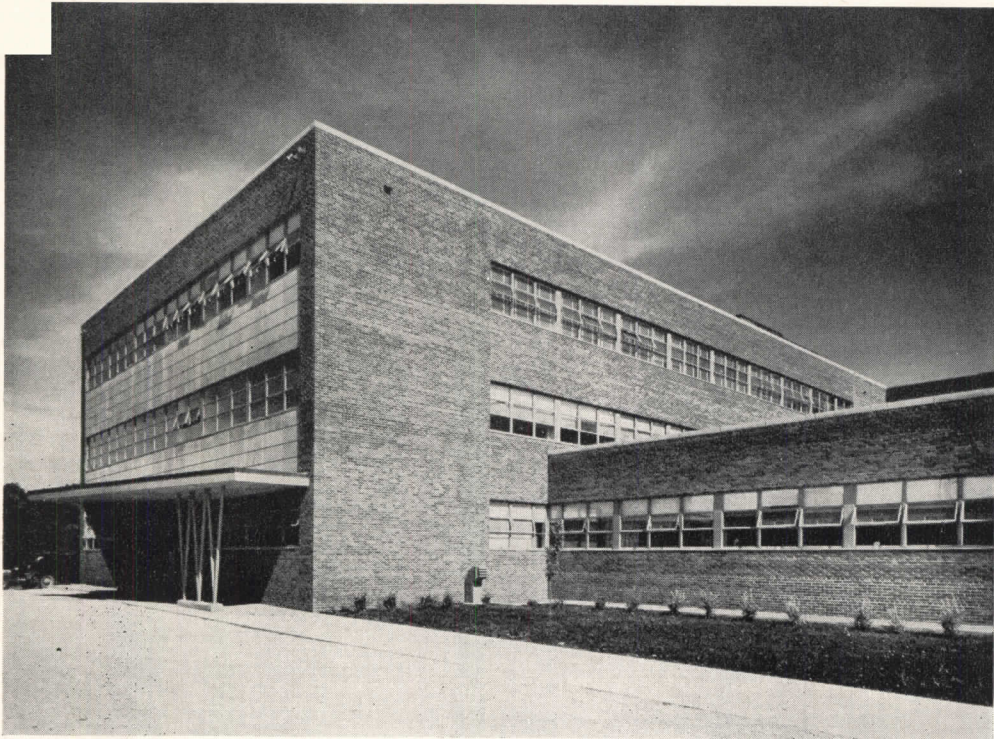
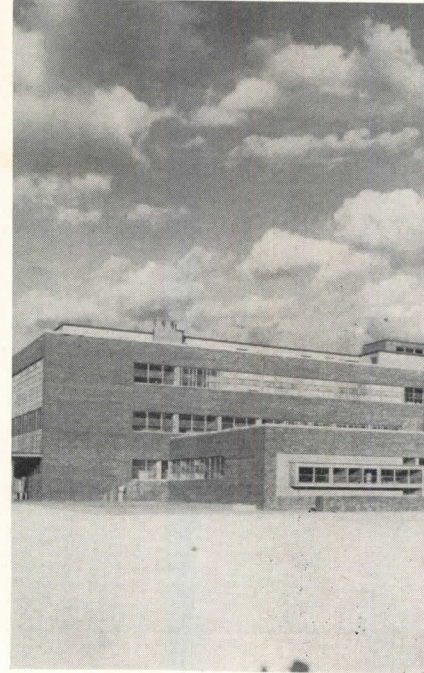


Above: glass partitions in pediatric departments tend to keep children amused and cooperative. Upper right: view of main lobby, looking toward information desk. Right, center: information desk is just that — cashier's counter is recessed off the main corridor. Right: another view of nurses' station in pediatric department





Thigpen



*Ottumwa Hospital,  
Ottumwa, Iowa  
Morgan-Gelatt &  
Associates, Architects*

## 133-BED HOSPITAL PLANNED FOR EXPANSION

**O**TTUMWA HOSPITAL is a representative example of planning for expansion; it replaces a hospital group which for 60 years had struggled with space problems, so that its planners were not intending to get caught within the foreseeable future with overcrowding. The normal capacity of the new building is put at 133 beds; it might take 175 patients under emergency conditions. But it can be expanded in virtually all directions, and has facilities all ready to take considerable extension.

The building now is L-shaped; in the next stage it

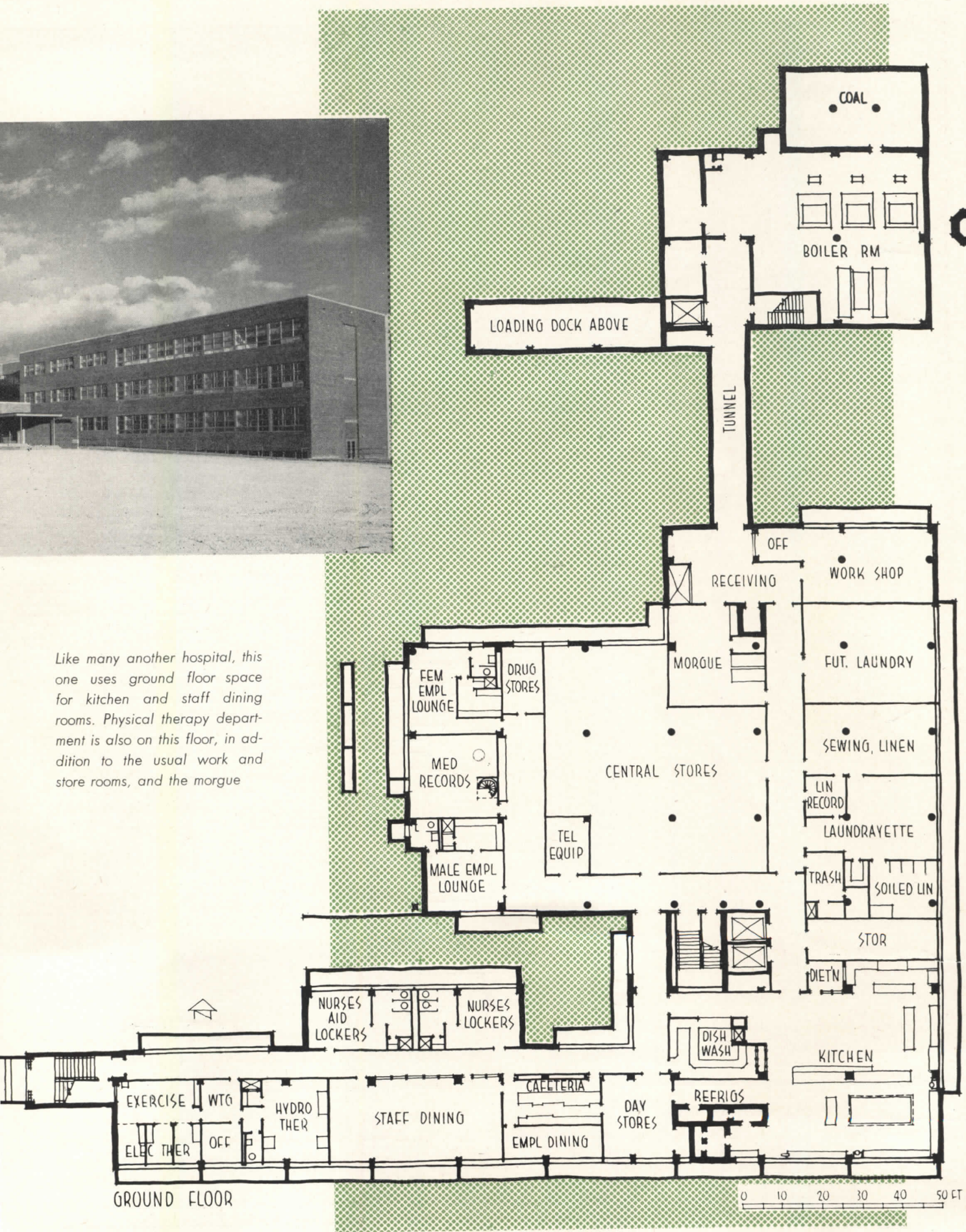
will become T-shaped; and finally it might take the form of an X with an extension out from the top of the T. All of this growth is planned to leave undisturbed the central portion containing kitchen area, administration, laboratories, surgical and obstetrical departments.

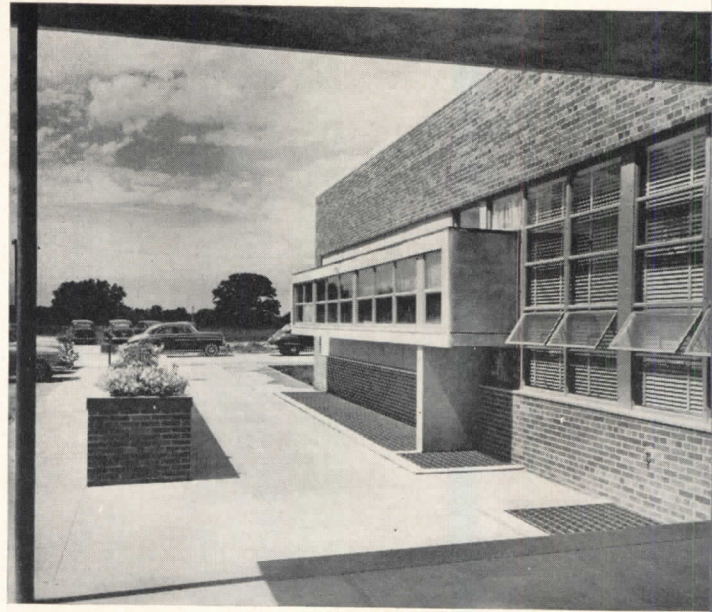
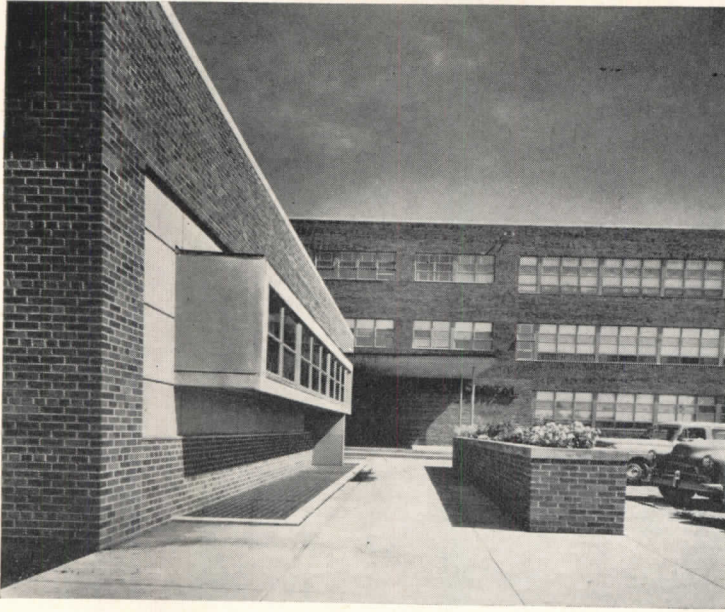
The building is oriented on a large site to give most of the patient rooms a southeast exposure, both in the present form and in the first expansion of the nursing wings. In the nursing portion the plan uses a single-loaded corridor, with only nursing station and utility



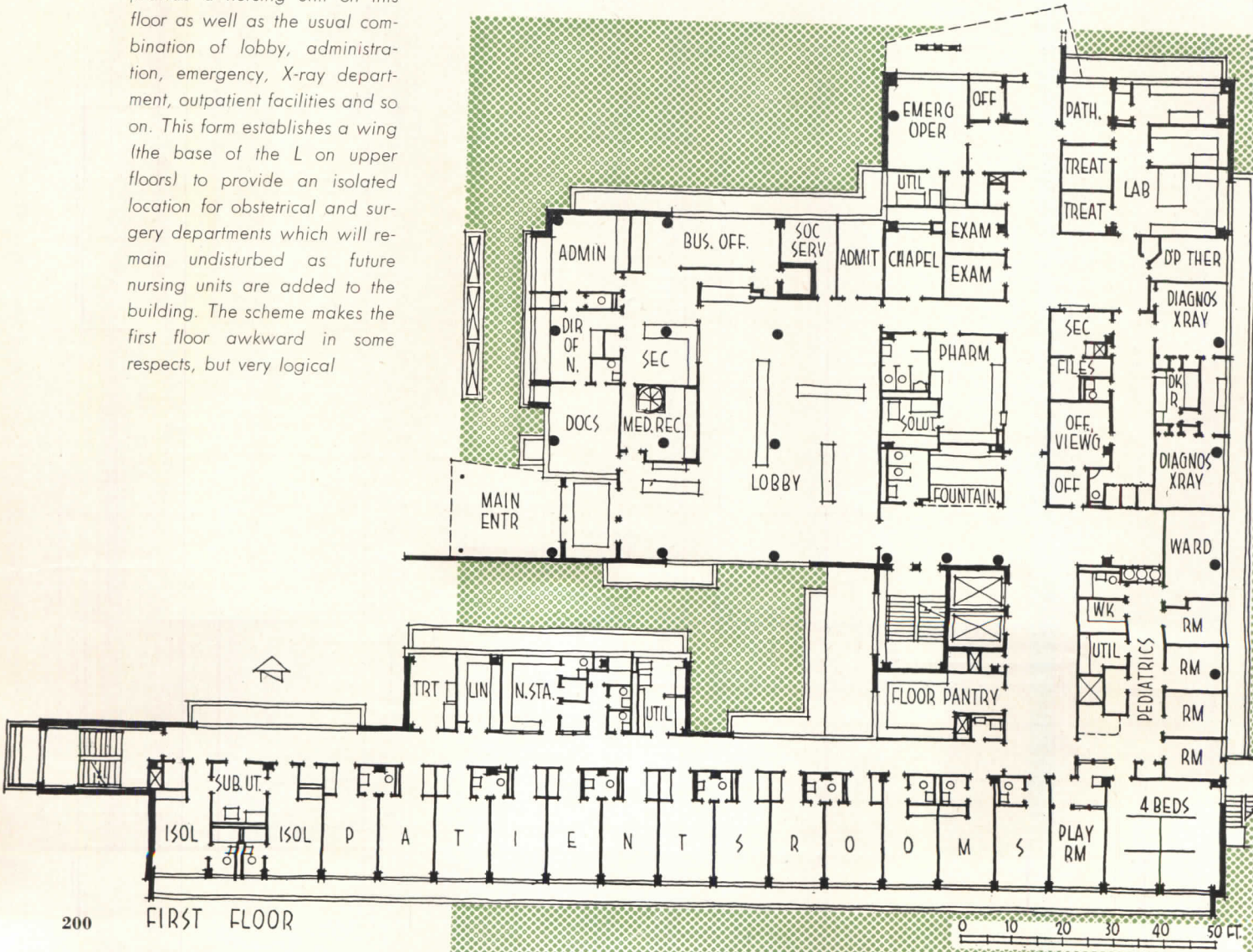


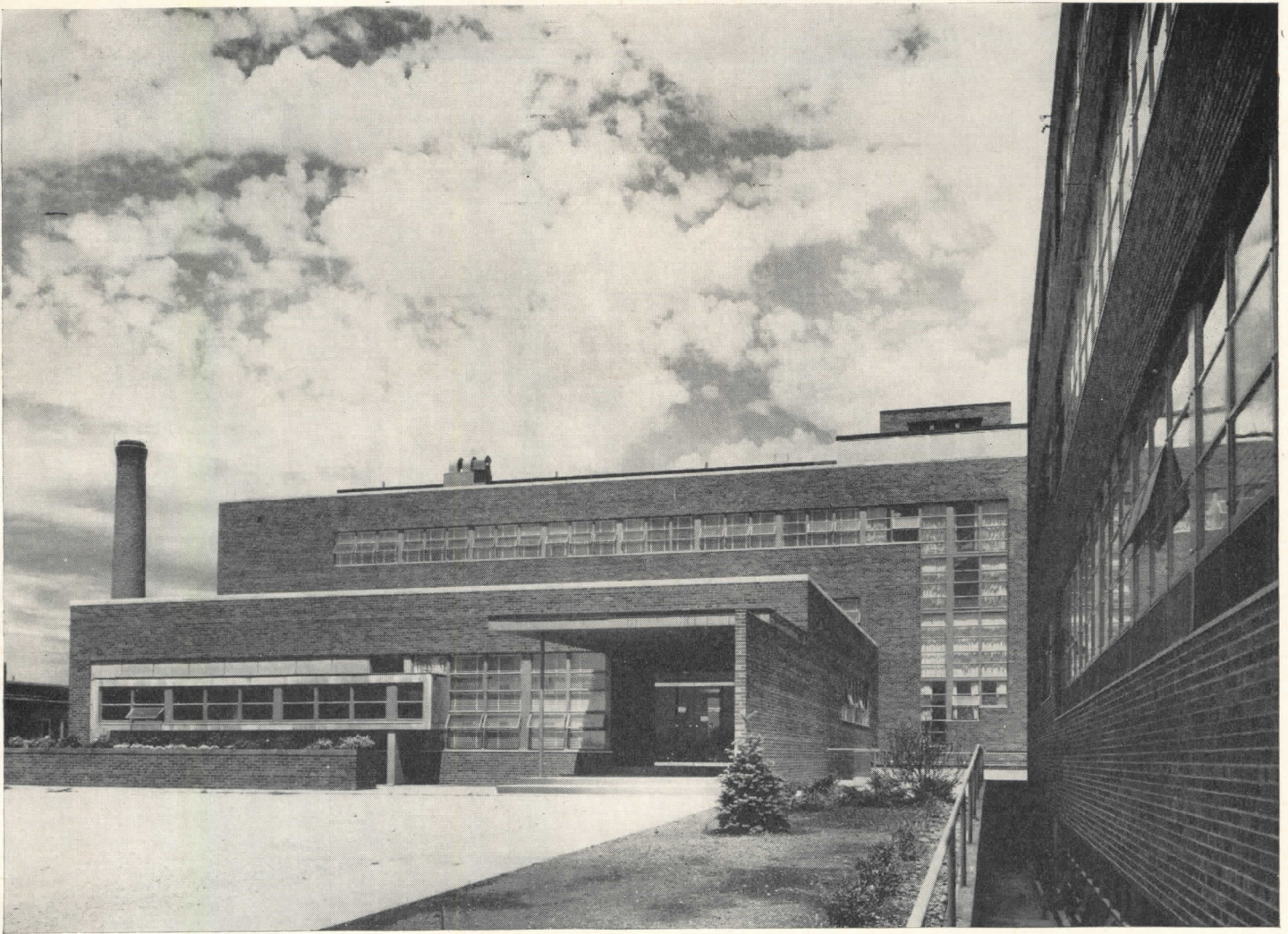
Like many another hospital, this one uses ground floor space for kitchen and staff dining rooms. Physical therapy department is also on this floor, in addition to the usual work and store rooms, and the morgue





Ottumwa Hospital develops its first floor quite extensively to provide a nursing unit on this floor as well as the usual combination of lobby, administration, emergency, X-ray department, outpatient facilities and so on. This form establishes a wing (the base of the L on upper floors) to provide an isolated location for obstetrical and surgery departments which will remain undisturbed as future nursing units are added to the building. The scheme makes the first floor awkward in some respects, but very logical





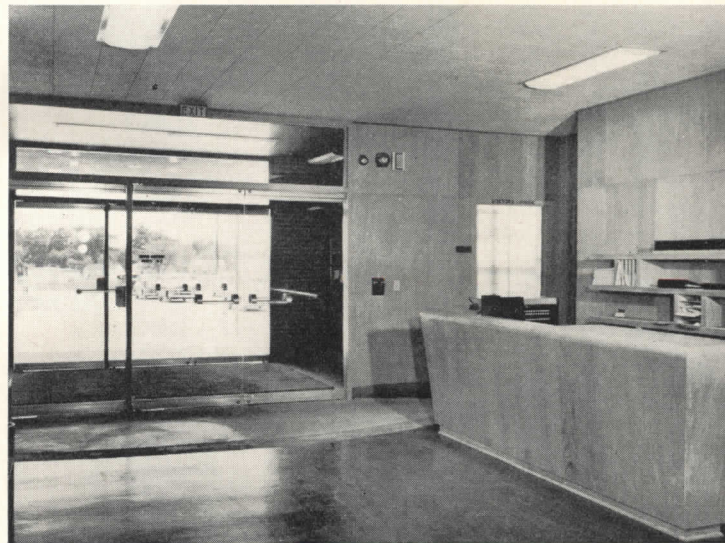
*Main entrances located within the form of the L sacrifice a certain monumental quality, but preserve logic of plan. This also, by the way, saved substantially on driveway costs*

rooms centrally located on the opposite side of the corridor.

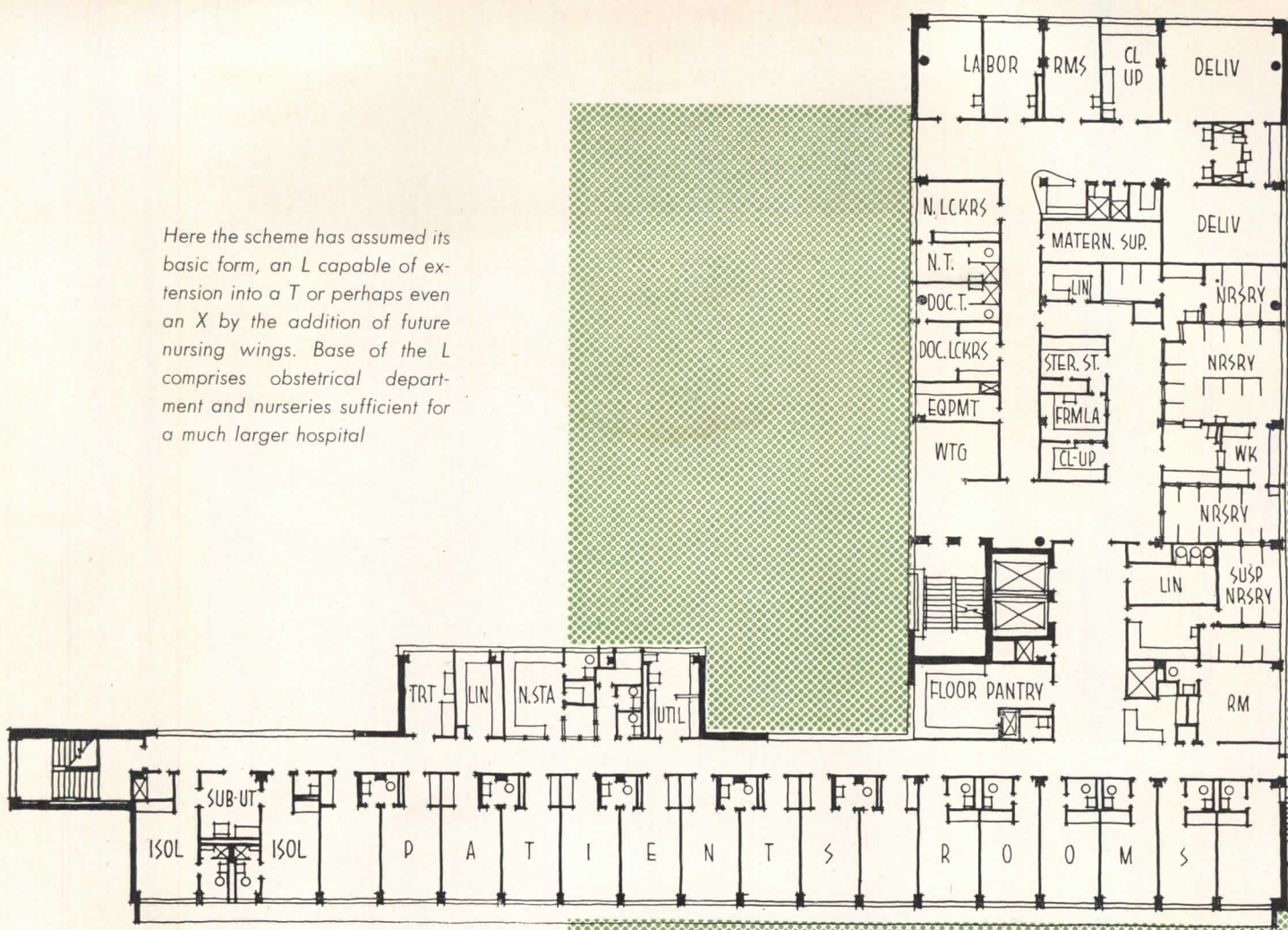
The scheme outlined above, to give an extra large chassis and maintain it undisturbed by expansions, had the effect of straining the lower floors just a bit. Also of putting the kitchen and dining rooms down on the ground floor. However, this level has above-grade windows on two sides to relieve the unpleasantness of basement space. It also introduced a rather awkward problem of handling supplies at ground level, down in an elevator, and through a tunnel to the kitchen and storage areas. This does have the advantage, however, of keeping noisy, unsightly operations well-screened.

The building is of reinforced concrete construction, with concrete spandrels and sun hoods, and thin, high-strength columns. Red brick was used, to contrast with the gray of the concrete.

Total construction cost is given at \$1,417,704. This works out to \$12,789 per bed; \$14.88 per sq ft; \$1.21 per cu ft. These costs include construction, equipment and fees.

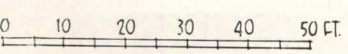
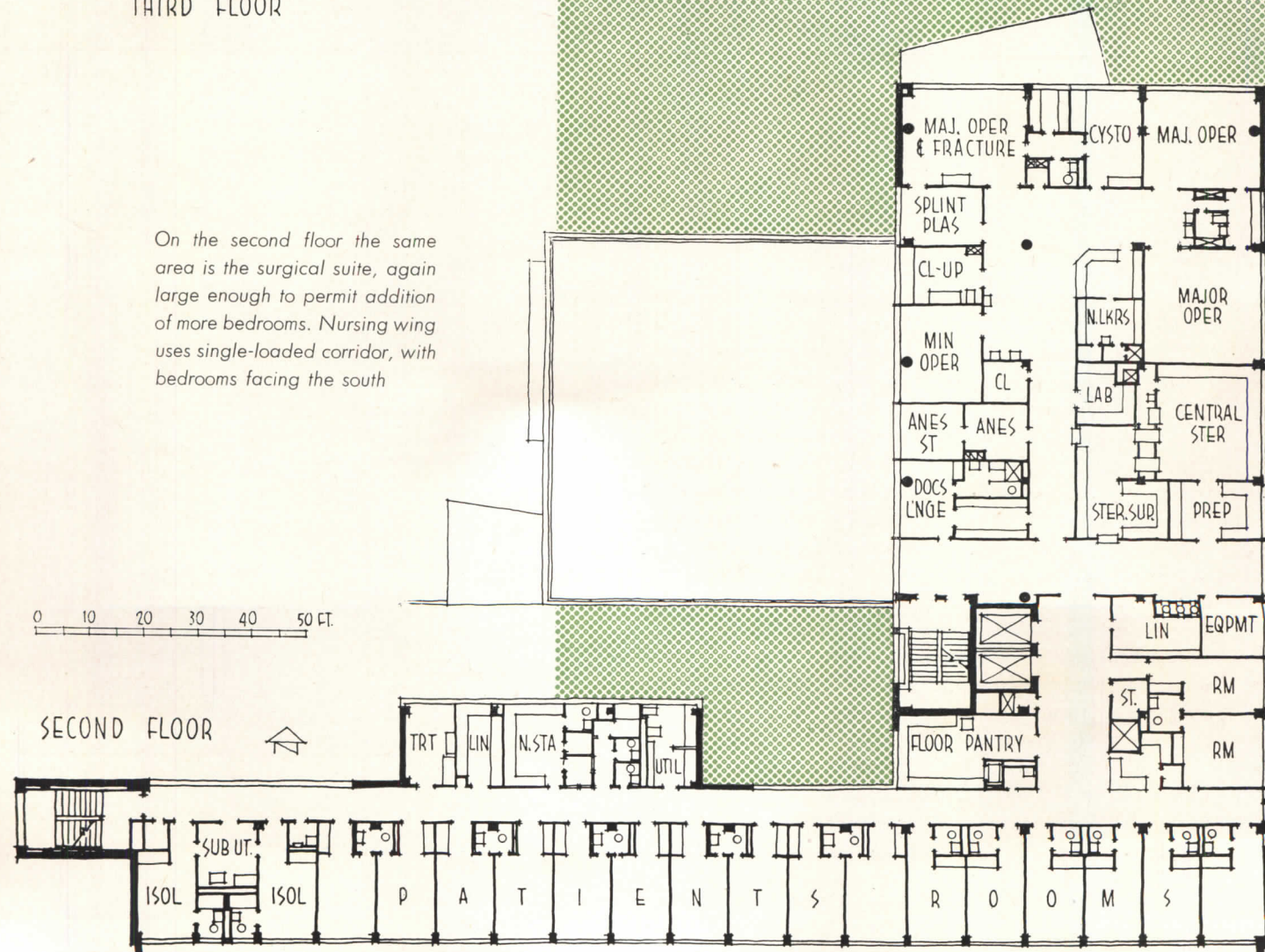


Here the scheme has assumed its basic form, an L capable of extension into a T or perhaps even an X by the addition of future nursing wings. Base of the L comprises obstetrical department and nurseries sufficient for a much larger hospital



THIRD FLOOR

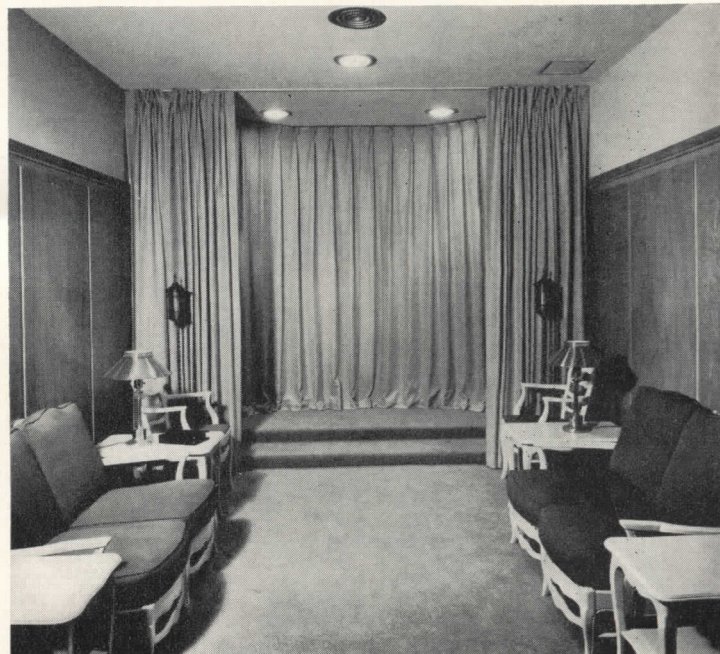
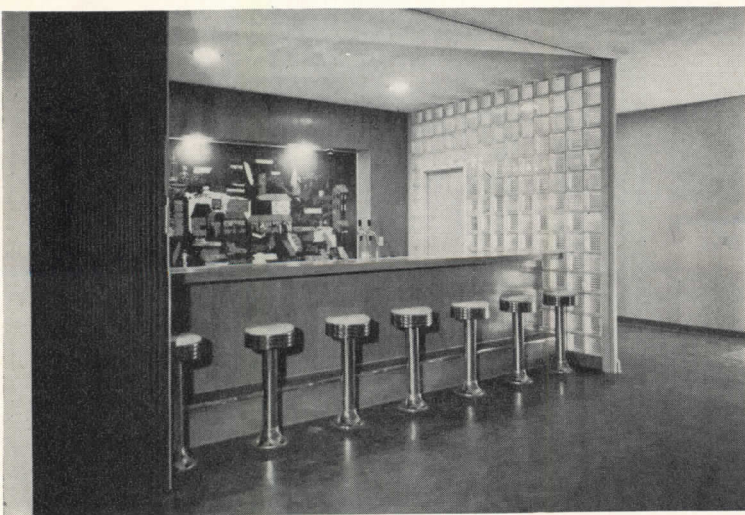
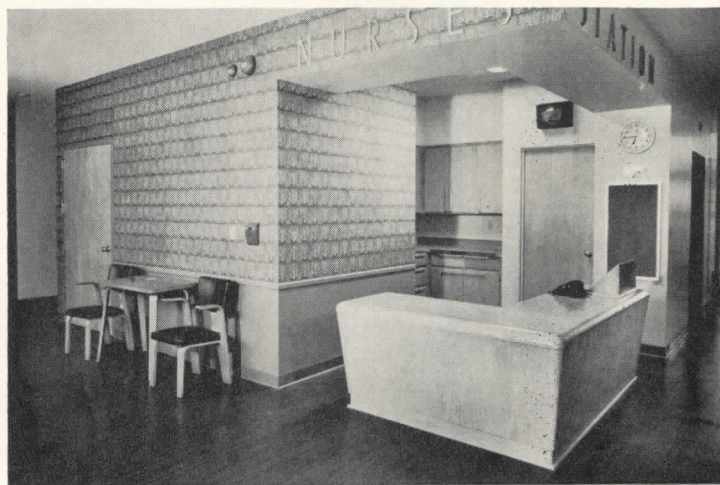
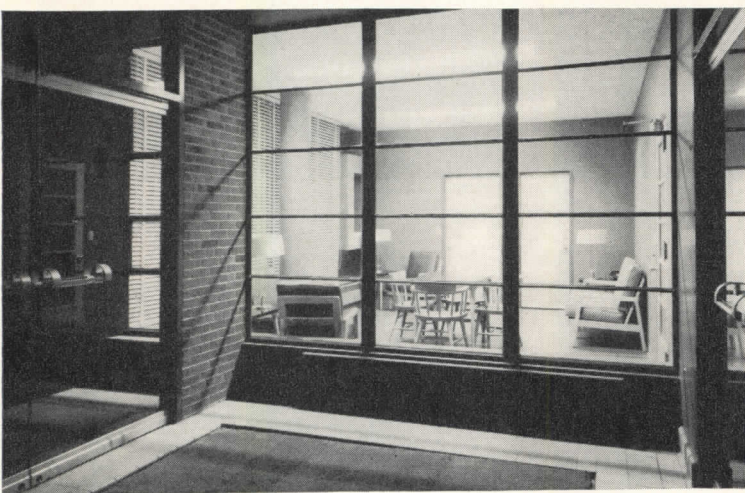
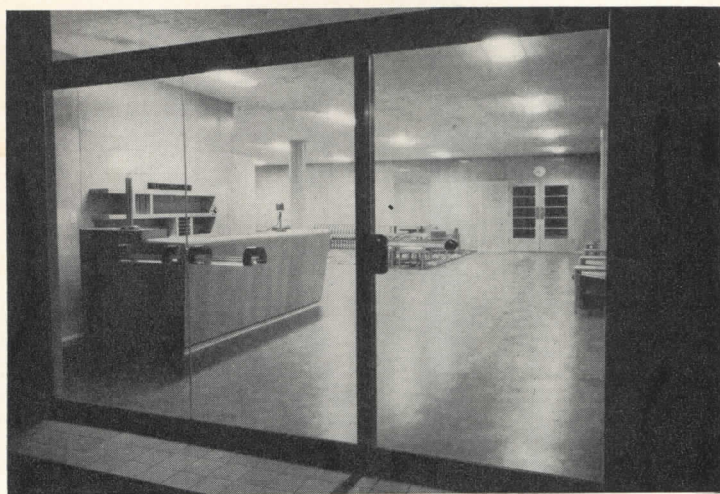
On the second floor the same area is the surgical suite, again large enough to permit addition of more bedrooms. Nursing wing uses single-loaded corridor, with bedrooms facing the south



SECOND FLOOR

Top left: main lobby is unusually colorful. Top right: entrance lobby as seen from outside. Center, left: doctors' lounge as seen from entrance vestibule. Center, right: nurses' station on the second floor

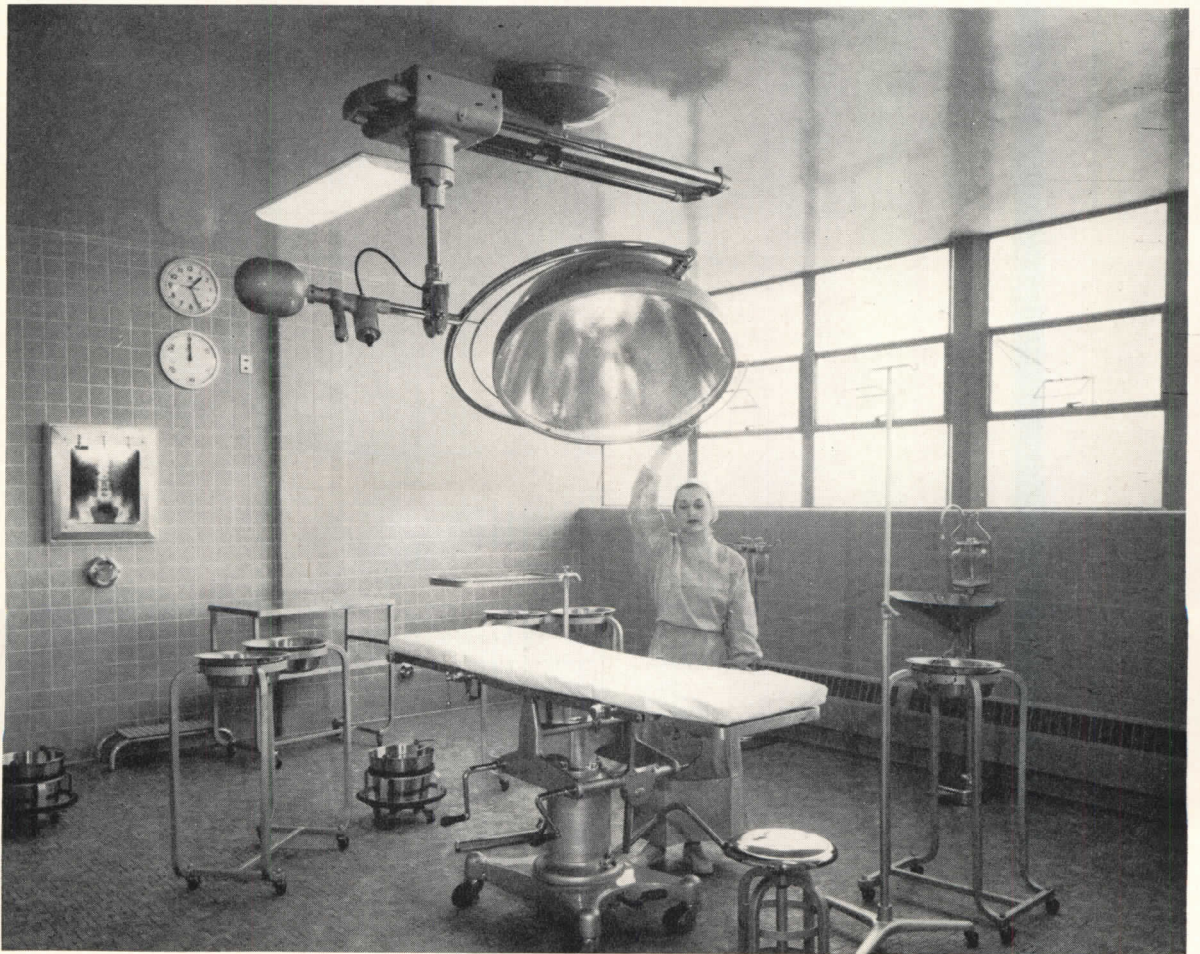
Thigpen



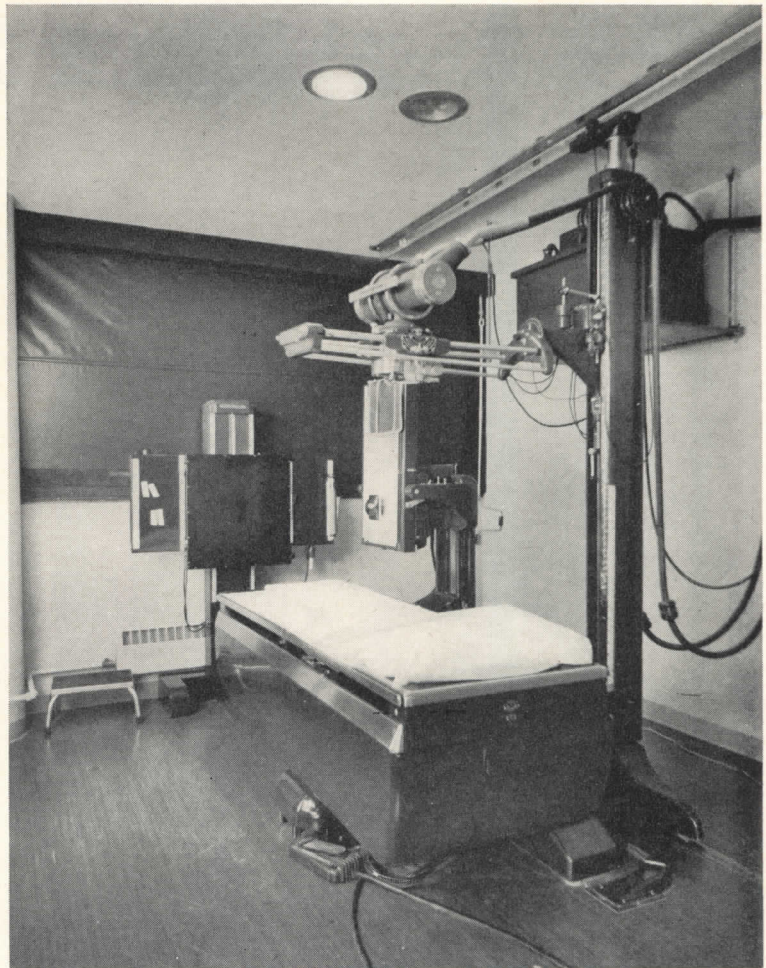
Above: refreshment counter has convenient location near lobby. Right: chapel doubles as lounge or lecture room



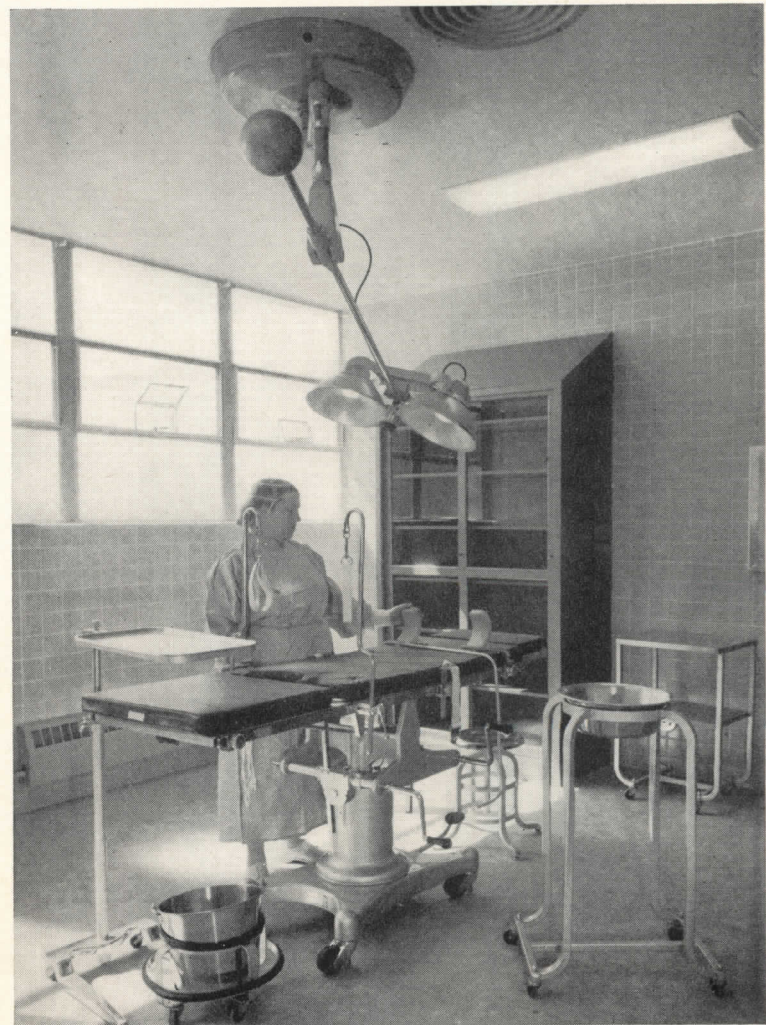
Thigpen



Opposite page, left: view into two-bed room. Interiors use plenty of color, with four color schemes of blue, green, rose beige and peach, with gay draperies. Opposite page, right: one of nurseries



Opposite page: one of the major operating rooms. This one has windows facing north; the other has no windows. Here the usual fracture room is a full-scale major operating room; the minor operating room, this page, right, is almost the equal of a major room. Other photographs on this page show the scrub-up facilities and one of the diagnostic X-ray rooms (first floor)









*Gadsden County Hospital,  
Quincy, Florida*

*Robert and Company Associates,  
Architects and Engineers*

## PLANNED FOR EXPANDABILITY PLUS ECONOMY

**E**XPANDABILITY was one of the basic requirements for this hospital, with a little extra strain toward economy. The proposed expansion in this case is not large, from 70 to 100 beds, but the budget did not allow for heavy original outlay for equipment for the larger hospital, so the problem, in effect, was to get a 70-bed building with facilities for a 100-bed hospital, for little extra cost.

Costs for the finished building were given thus: project cost, \$791,131; cost per bed, \$11,465 including group 1

and 2 equipment; cubic foot cost, \$1.55. The land was a gift to the county for the hospital. These costs seem to indicate good overall economy, with a general compactness which shows in a fairly high cubic foot cost. The floor plans show that this is true; all elements of the building, even including power plant, are kept within the simple form of the building, the corridor is double-loaded, and there are a great many bedrooms without toilet facilities. In general the economy urged did not lead to sacrificing any of the usual facilities in a

*Desire for economy dictated simple, inexpensive furnishing and finishes, but materials were chosen also for minimum maintenance expense, since annual operating expenses frequently strain a hospital board even more than original fund raising*

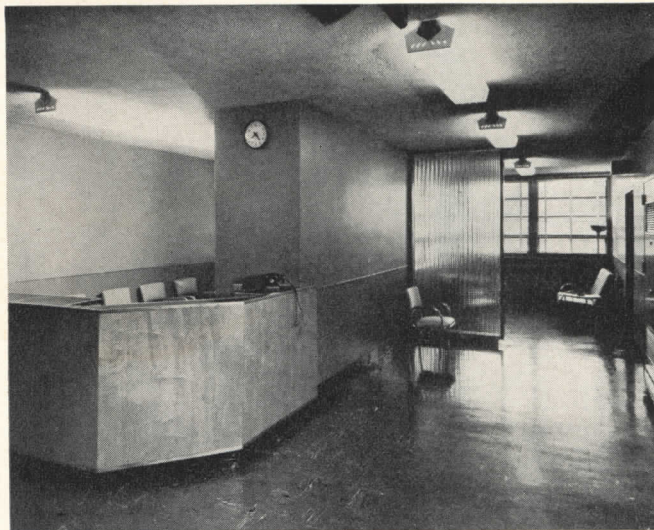




general hospital of high standard, but some economy was achieved by omitting a laundry, also a necropsy room, as it was planned for this type of work to be done elsewhere.

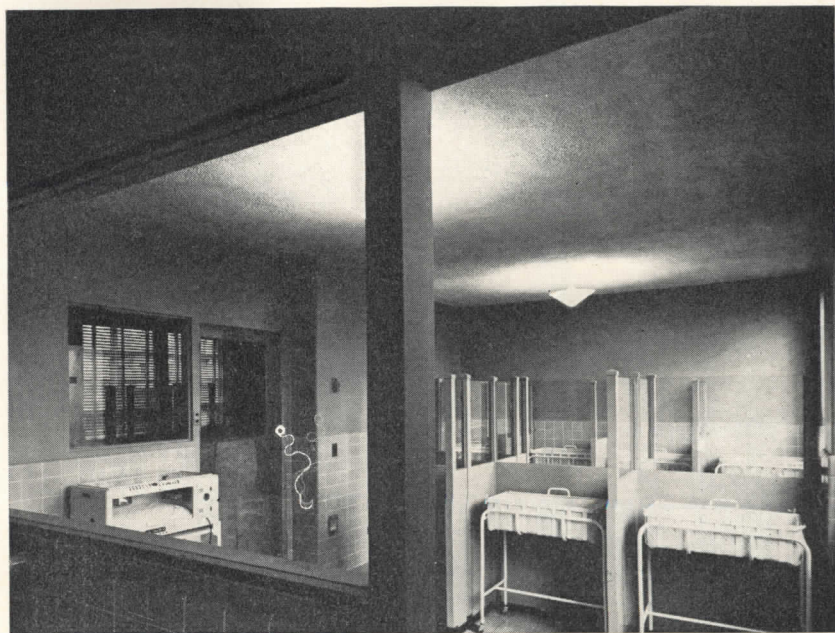
The same considerations also had some effect on the site development, as it was possible to save substantially by careful placing of the building on a fairly rough plot. Nevertheless, the location manages to give most of the bedrooms the desired southwest exposure, for the prevailing breeze and to keep the building away from traffic disturbances.

The economy requirement is not surprising, for the new building replaces an old hospital of only 25 beds, with inadequate facilities, especially in the surgical department. Tripling, and later quadrupling, its size gives a rough idea of how communities are tackling their needs for adequate hospital service.

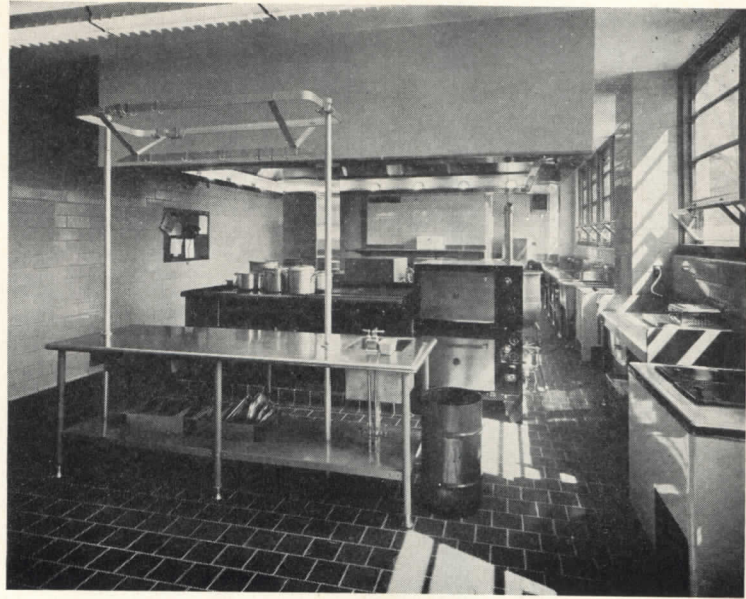
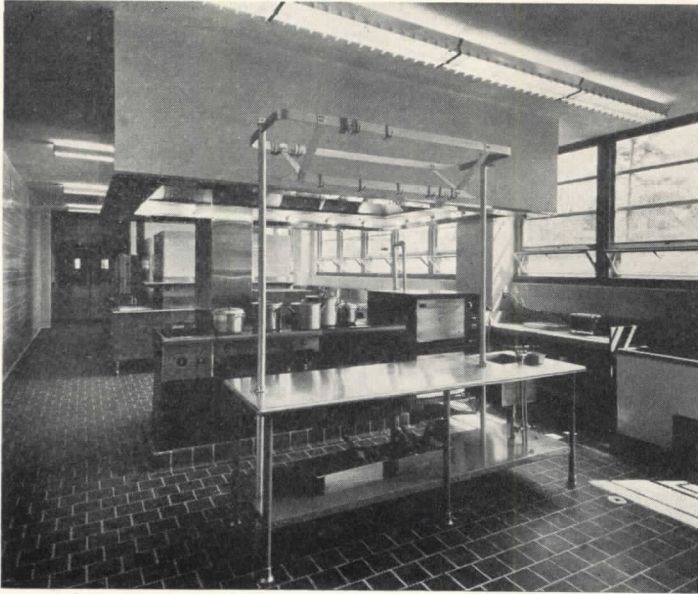


Gabriel Benzur

*Above, right: nurses' station, looking toward visitors' room. Below and right: private room, four-bed ward and nursery*

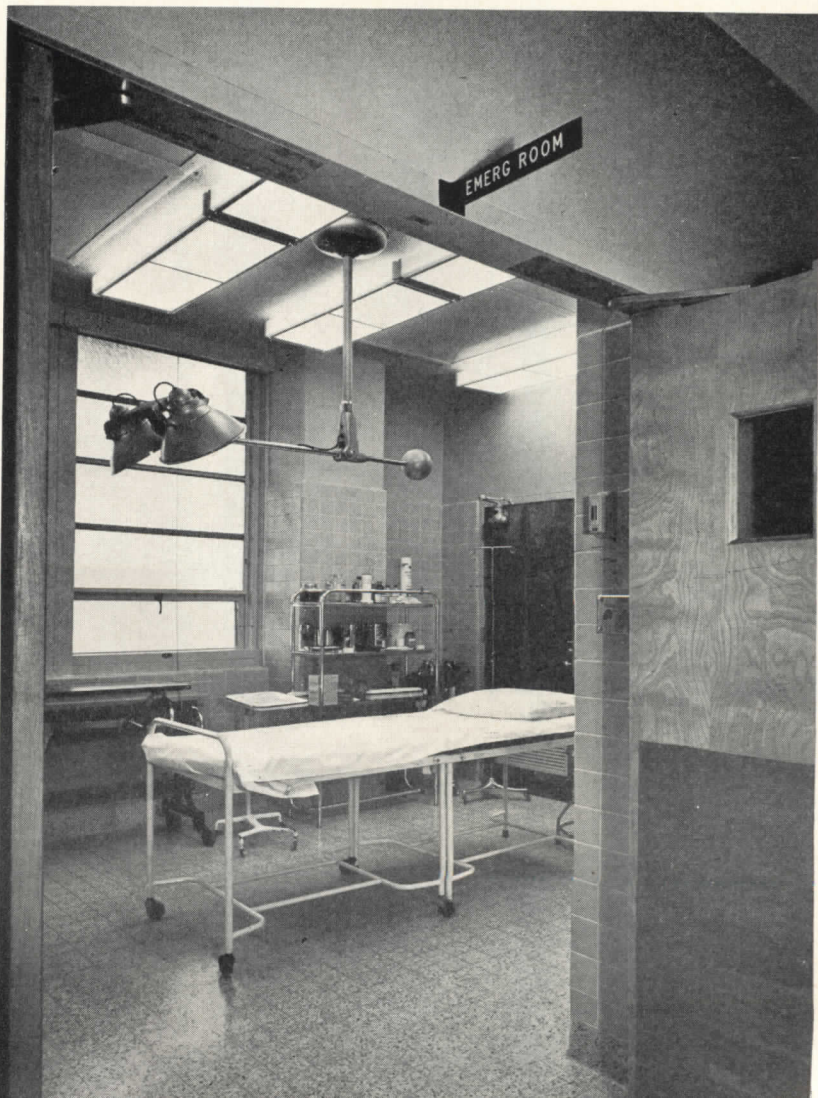






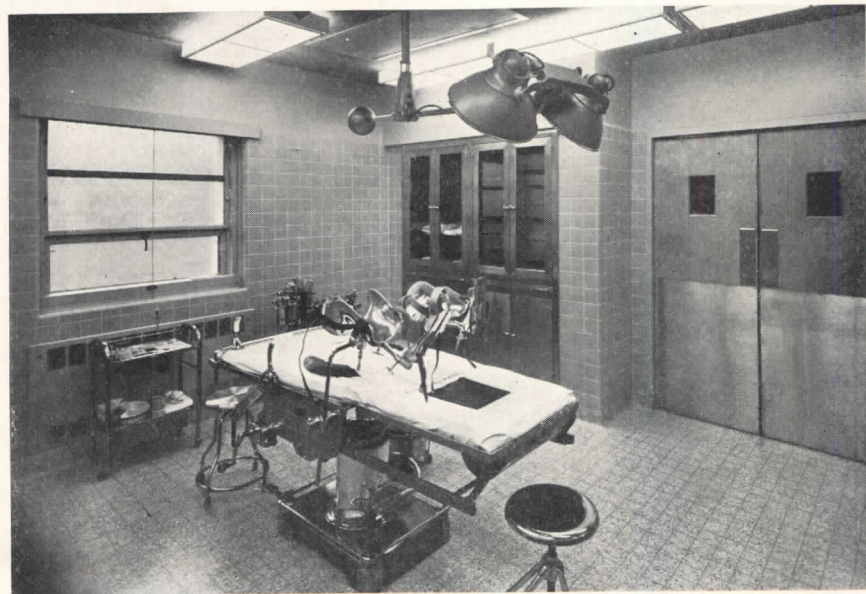
Above: kitchen is long and narrow, and, with first floor location, quite pleasant. Kitchen is large enough to serve 100-bed hospital, though there are now only 70 beds

Gabriel Benzur

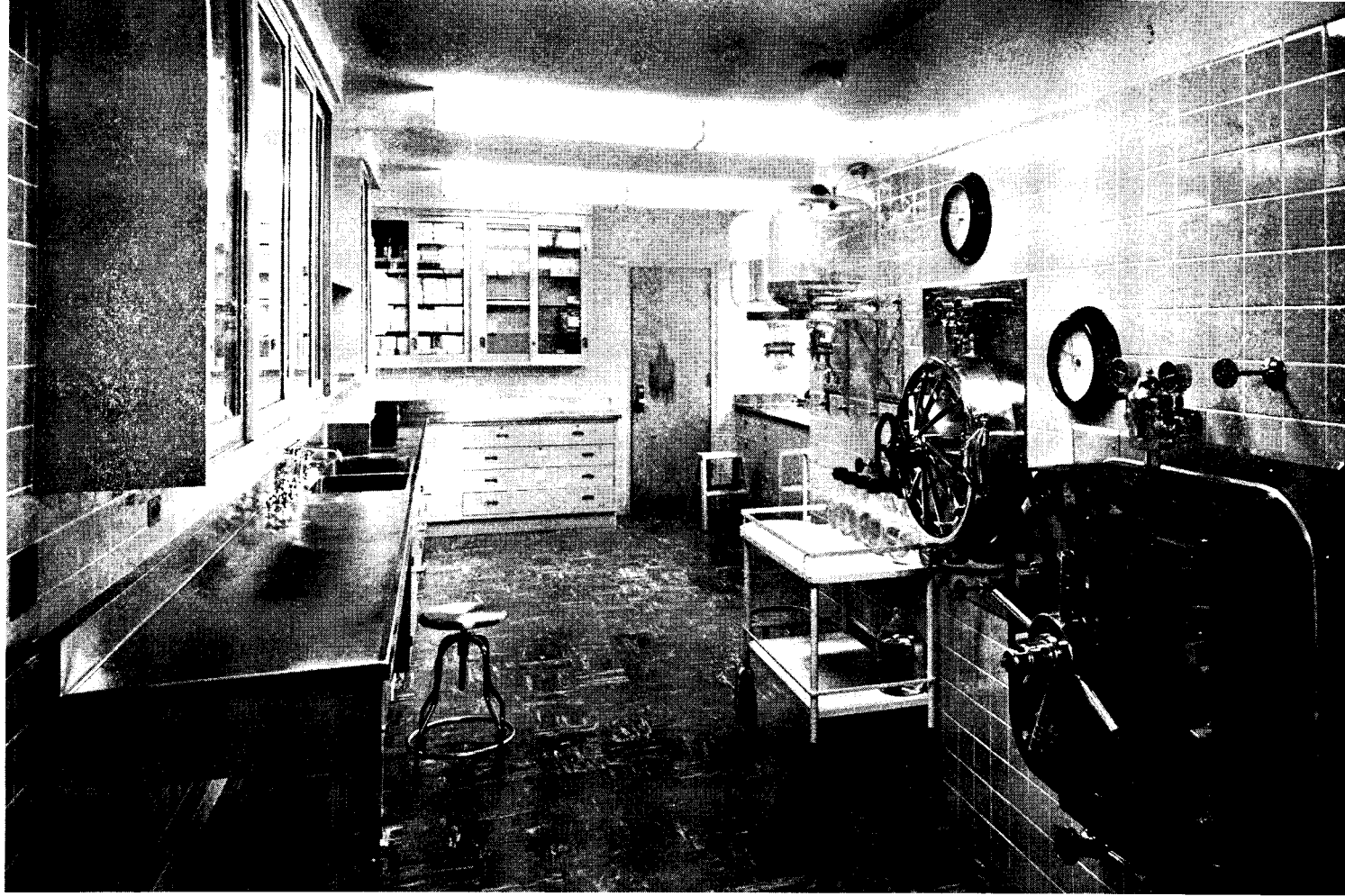


Above: nurses' work room in connection with nursery (see second floor plan). Right: emergency operating room, first floor, has light-tight shades, strong artificial light

*Below, left: central sterilizing room leads past the sterilizers, into sterile supply room; this suite is located with operating rooms. Below, right: scrub-up alcove between the two operating rooms, third floor*

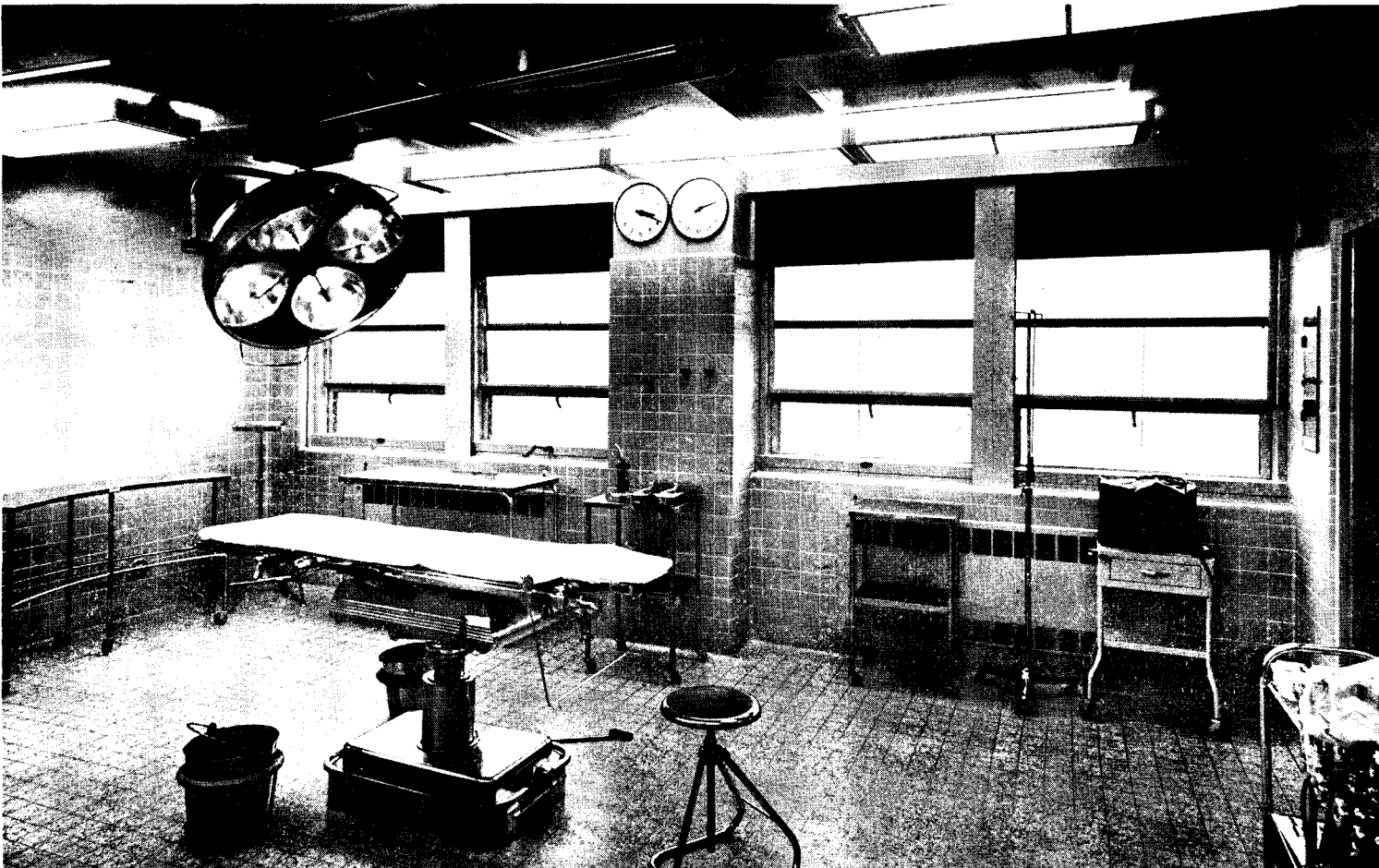


*Above, right: while there is only one full-size delivery room, labor room can also be used for delivery*



*Above: central sterilizing department, as seen from sterile supply room. Below: major operating room*

Gabriel Benzu





## 53-BED HOSPITAL THAT WILL GROW TO 75

*St. Charles Hospital, Bend, Oregon*  
*John W. Maloney, Architect*

*W. H. Witt Co., Structural Engineers*  
*Lezin & Notkin, Mechanical and Electrical Engineers*



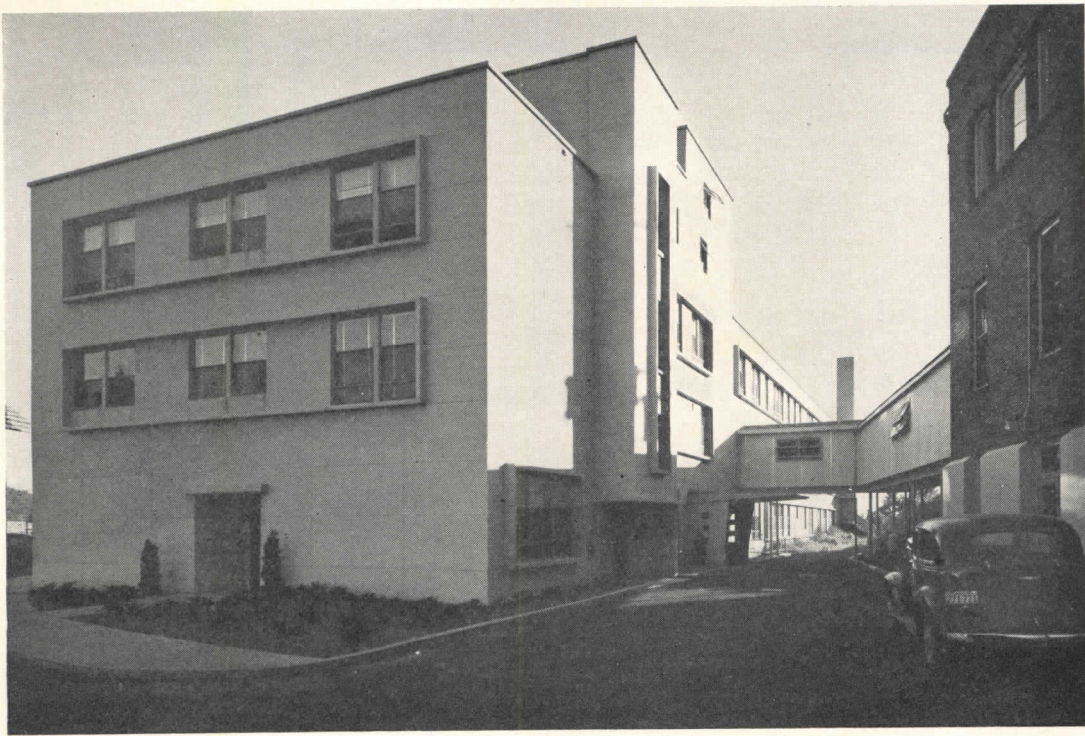
**T**HIS 53-BED HOSPITAL is really a 75-bed scheme with one nursing floor omitted for the present. It connects now to an older building later to be removed; patients classified as medical are housed in the old building until a fourth floor can be added to the new hospital. The new building is complete — missing only laundry and morgue — and does not depend on the old building for any services; rather the patients in the existing building are served from the new.

The site being quite hilly, advantage of the grade was taken to give the kitchen end of the basement full window height, and to locate receiving dock at this level.

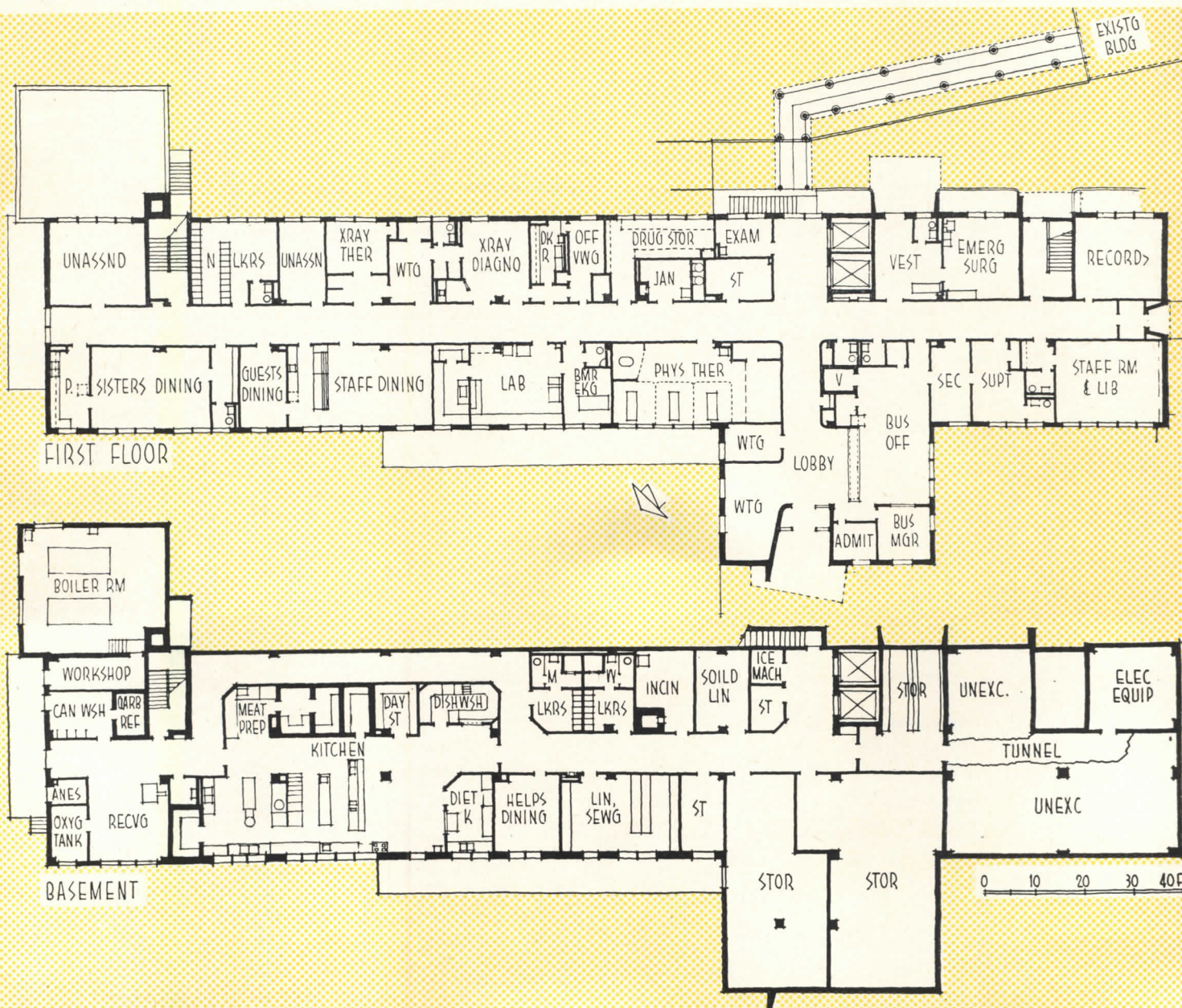
On the first floor, the little extension at the entrance provides extra space needed for lobby and offices, and gives exceptionally good control of visitors and incoming and outgoing patients. Separate emergency entrance and surgery are near elevators, but screened from view.

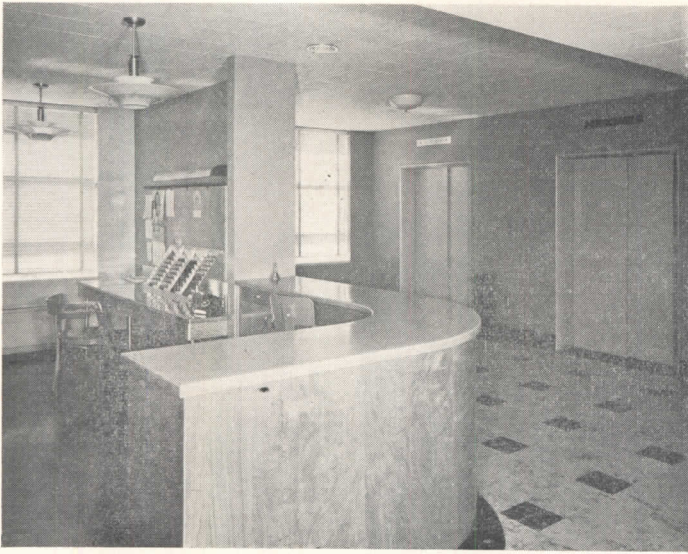
On the second floor, the surgical suite is conventional, with the possible exception that the fracture room also serves as one of the major operating rooms. Central sterilizing is convenient to the surgical department, also to the covered passage connecting to the old hospital. The location of the nurses' station, near the elevators but not central in the nursing unit itself, was the subject of some discussion; it was finally decided





B. J. Allen

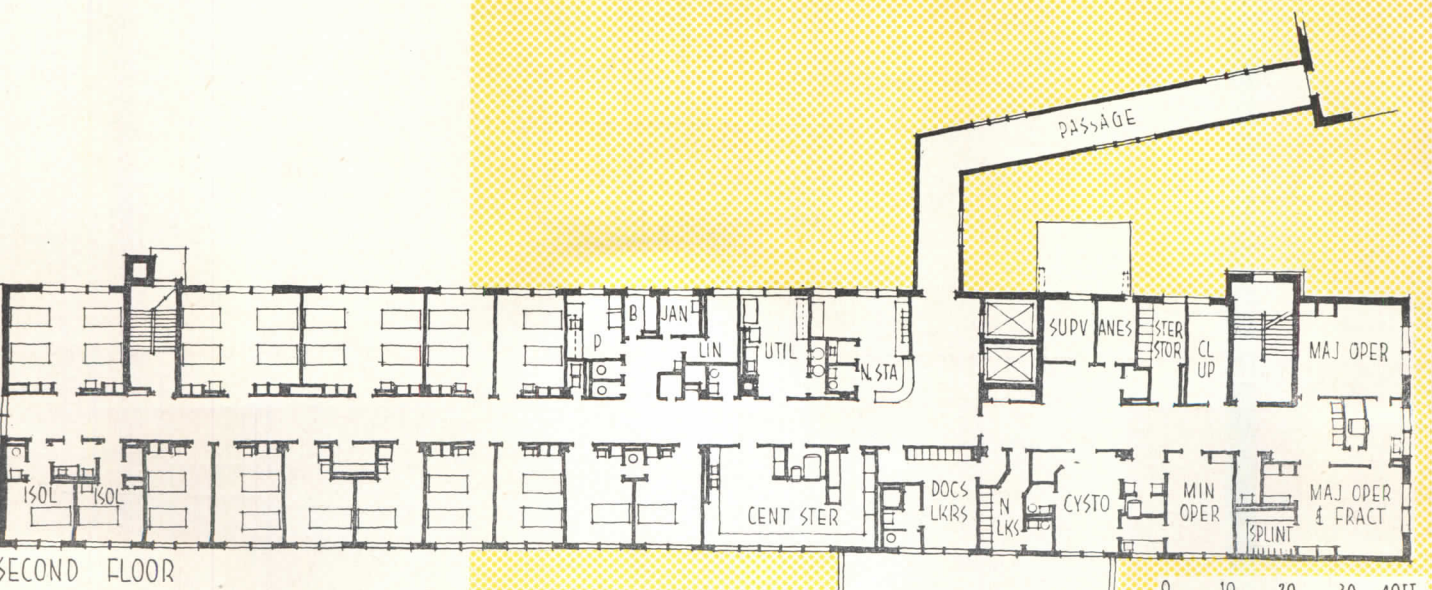
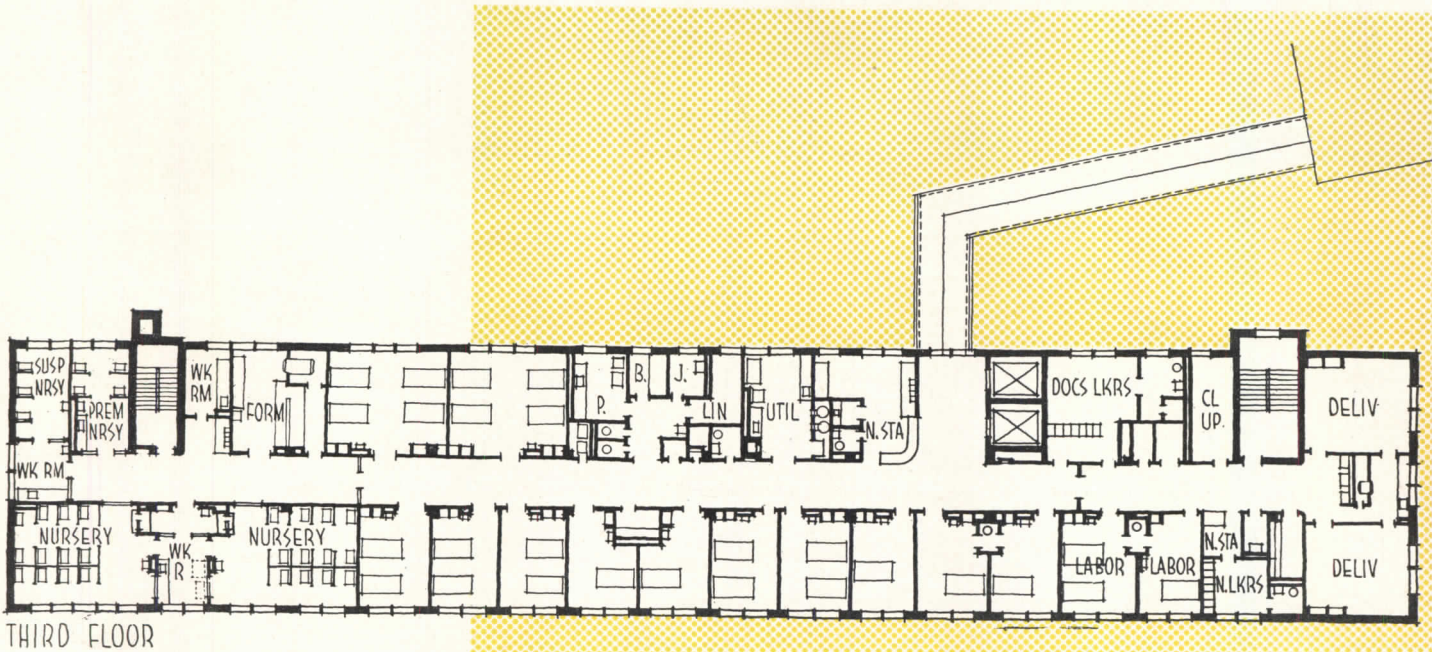


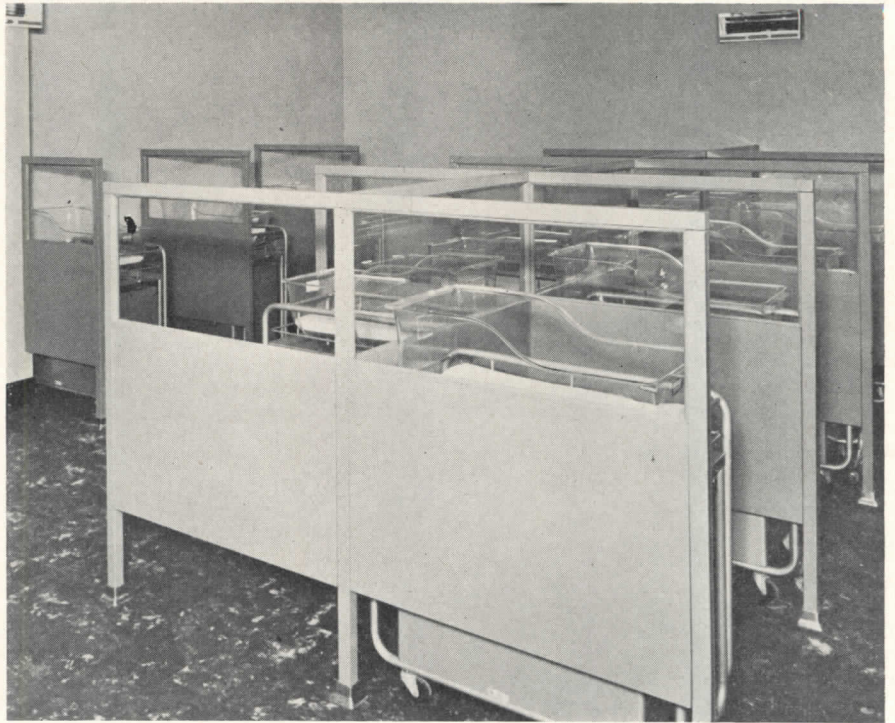


that control was more important here than convenience.

The third floor is similarly planned, except of course that this is the obstetrical and maternity floor. The nurseries follow the now-familiar plan of having the only entrance through the examination and work rooms, so that nobody need enter the nurseries except the nurses themselves.

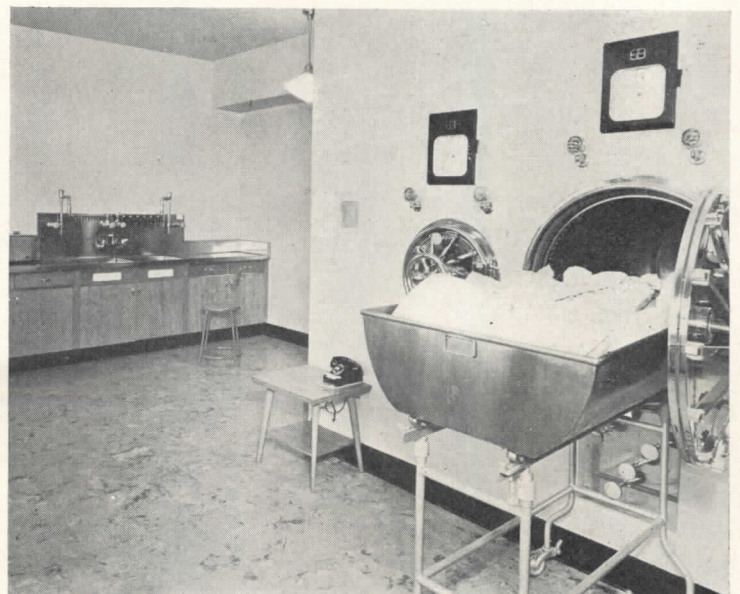
Total construction costs were \$804,781. These work out to \$17.25 per sq ft; \$1.54 per cu ft; \$15,184 per bed.

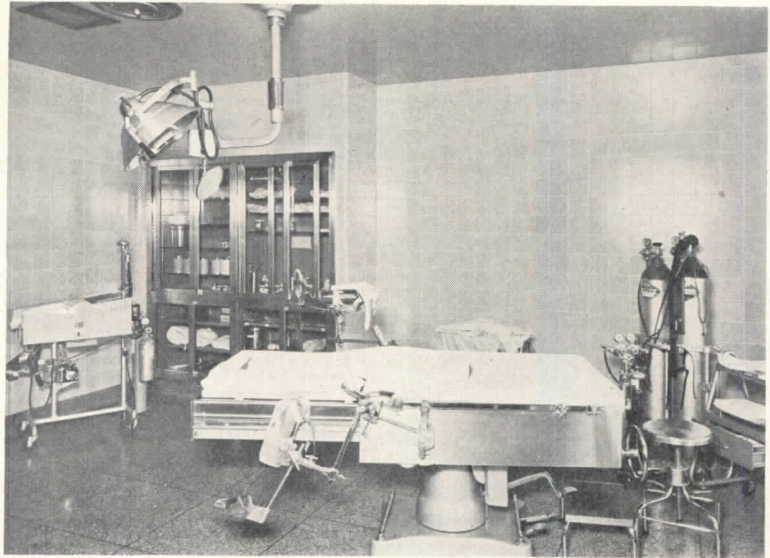
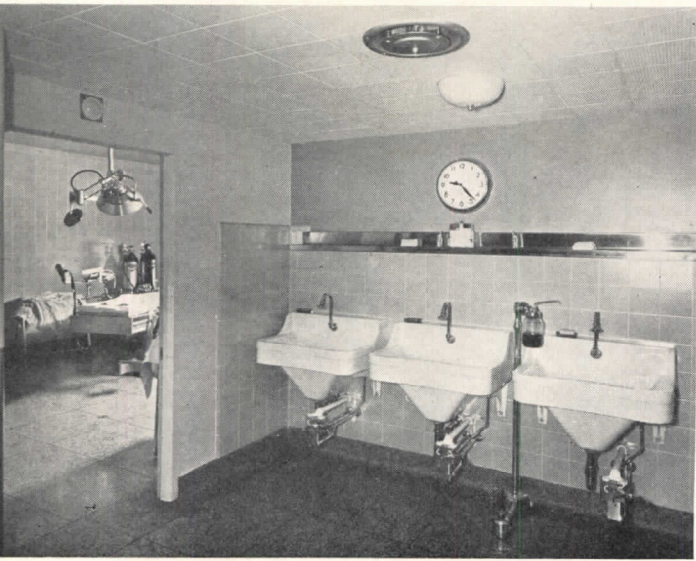




*Left: typical private bedroom; Above: one of the nurseries, using the cubical system of protection. Below, left: kitchen on ground floor serves food to dining rooms above and to patient rooms through heated carts. Below, right: view of the central sterilizing department*

B. J. Allen





Above, left: scrub-up alcove between delivery rooms at St. Charles Hospital. Above, right: one of the two delivery rooms (third floor). Below: one of the major operating rooms; the other, though for fracture work, is fully equipped for any surgery



# 19-BED HOSPITAL OF REMARKABLY LOW COST

*Cozad Community Hospital, Cozad, Nebraska*

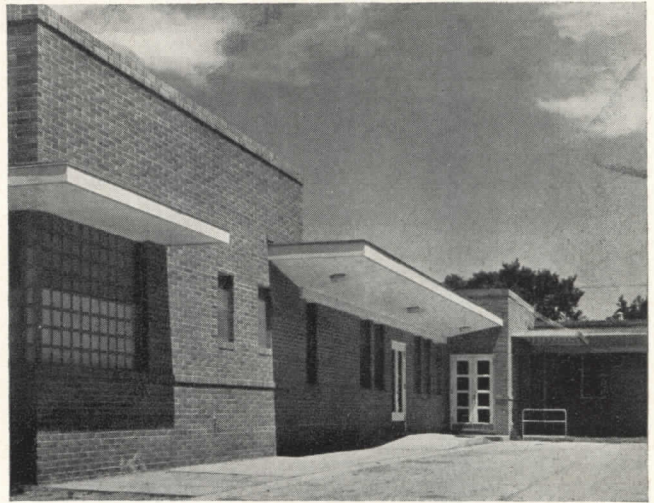
*Frank N. McNett & Company, Architects*

**T**HIS HOSPITAL is an interesting example of the problems of designing the very small hospital. It was once said that nothing under 50 beds could really be called a "hospital," as it could not be fully equipped and staffed for real hospital service and care. Yet here is one of but 19 beds (two more bedrooms have been added since this plan was drawn) with full-size operating room, separate delivery room, sterilizing, X-ray, laboratory, emergency room. The architect's problem was to meet the Federal insistence on standards of equipment and facilities, and yet to stay within a tiny budget.

This he has done by keeping the plan very compact, by keeping cubages down to minimums, by tucking things into corners. And yet most bedrooms have at least connecting toilets. Also the organization of hos-

pital departments has been maintained, and separations are generally clear, although in one or two places the space must do double duty.

The hospital was built for the remarkably low cost of \$144,585, not including equipment. Usable area totals 9262, cubic content 168,492.

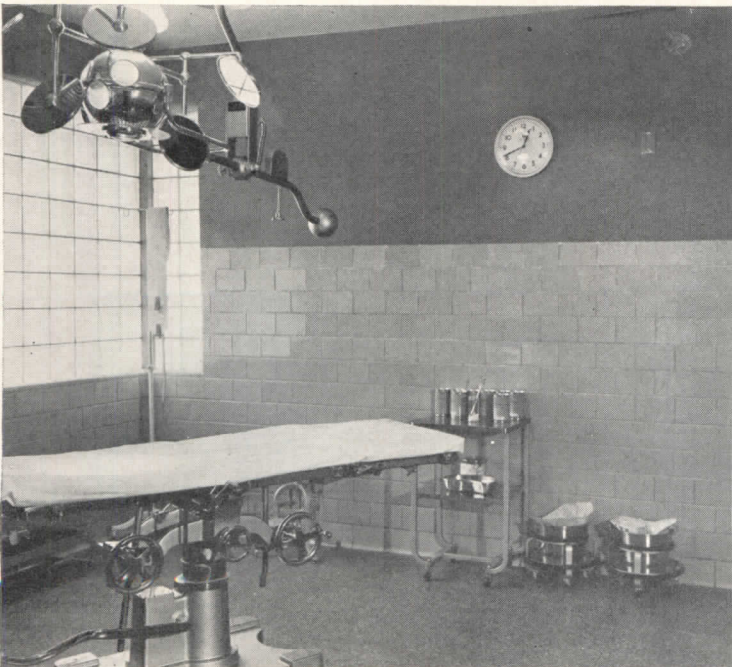
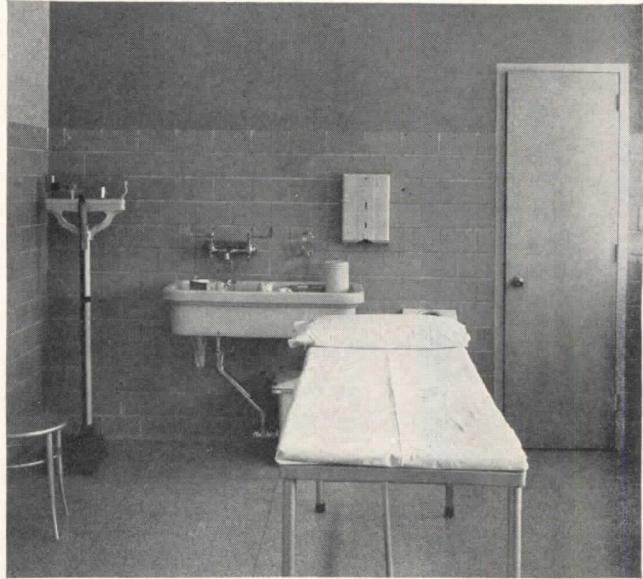
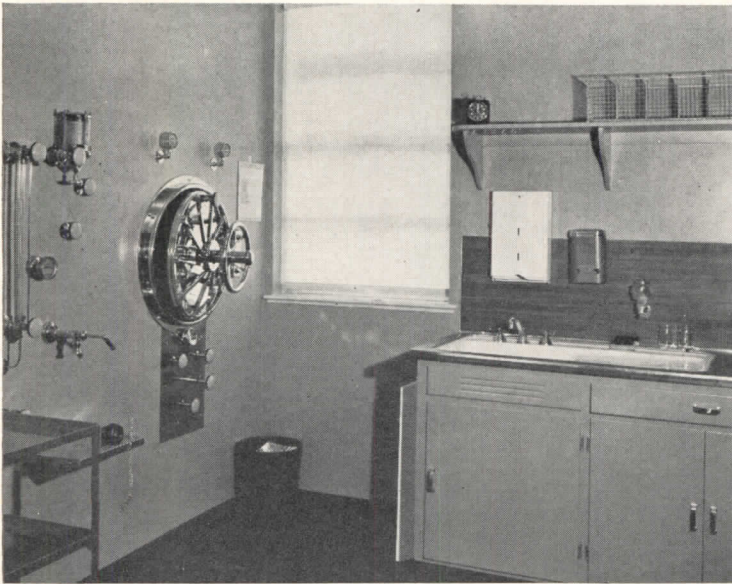


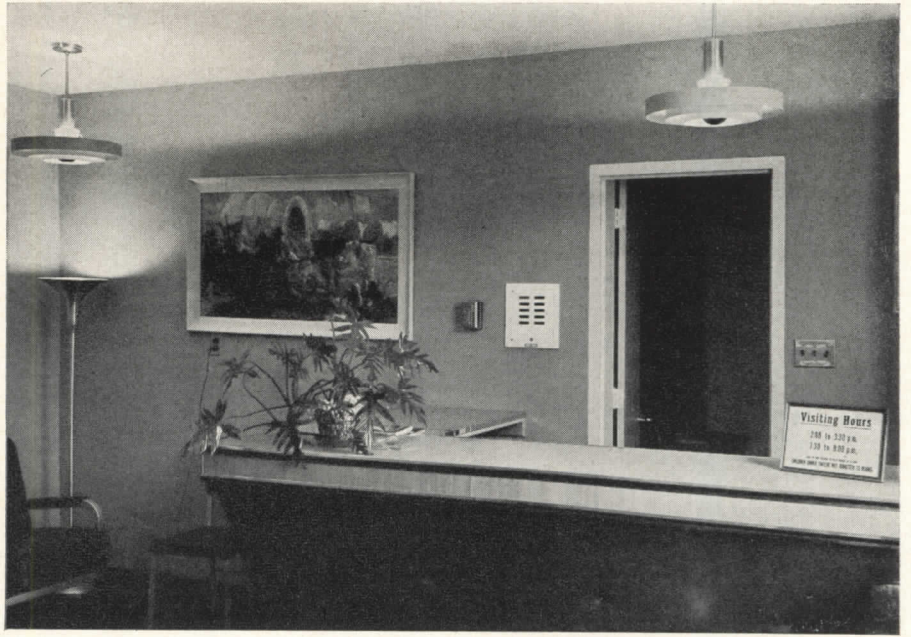
*A minimum hospital on a minimum budget, this one still gives full hospital care, not forgetting out-patient clinic*

Vieregg Studio

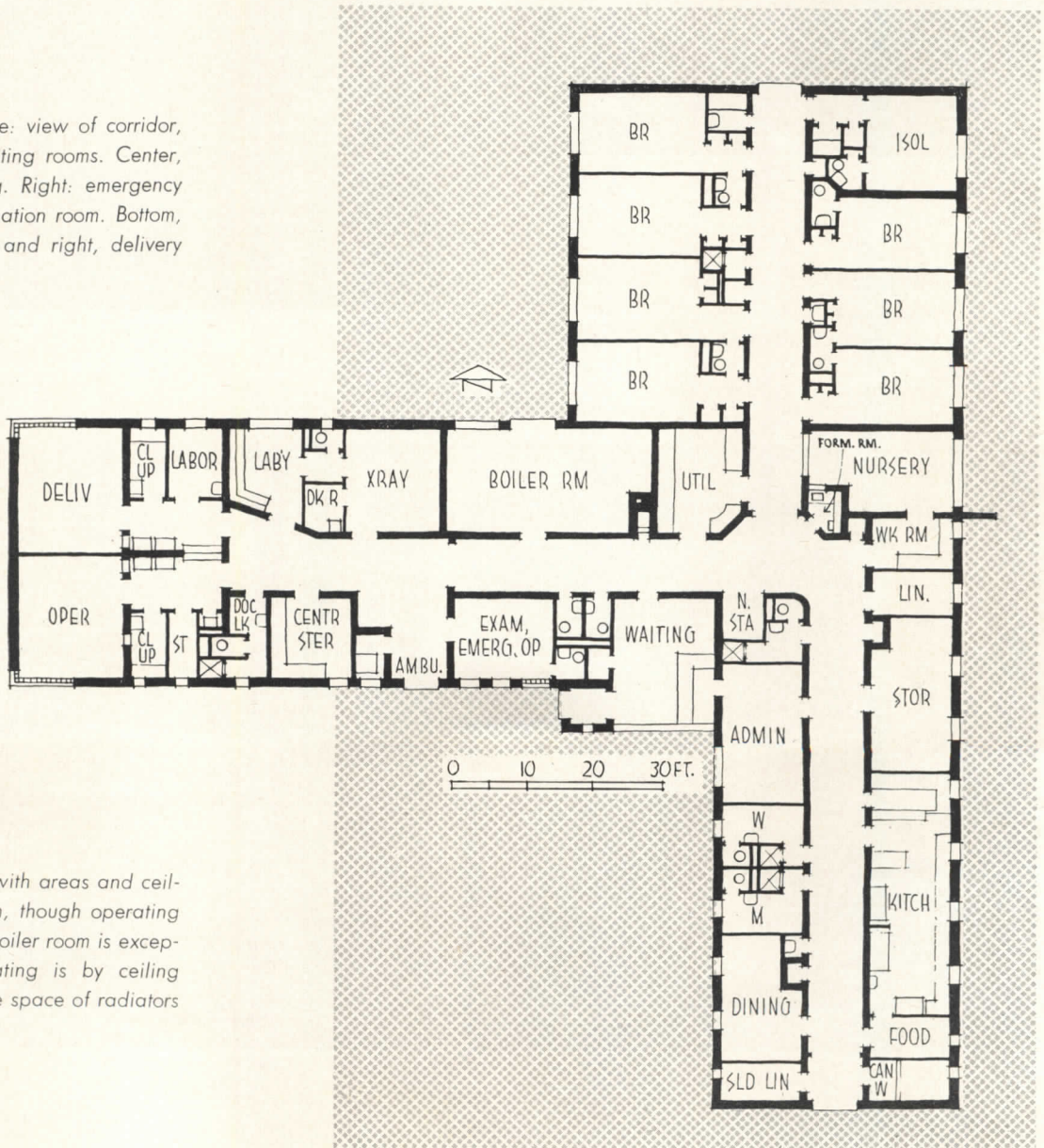


Vieregg Studio



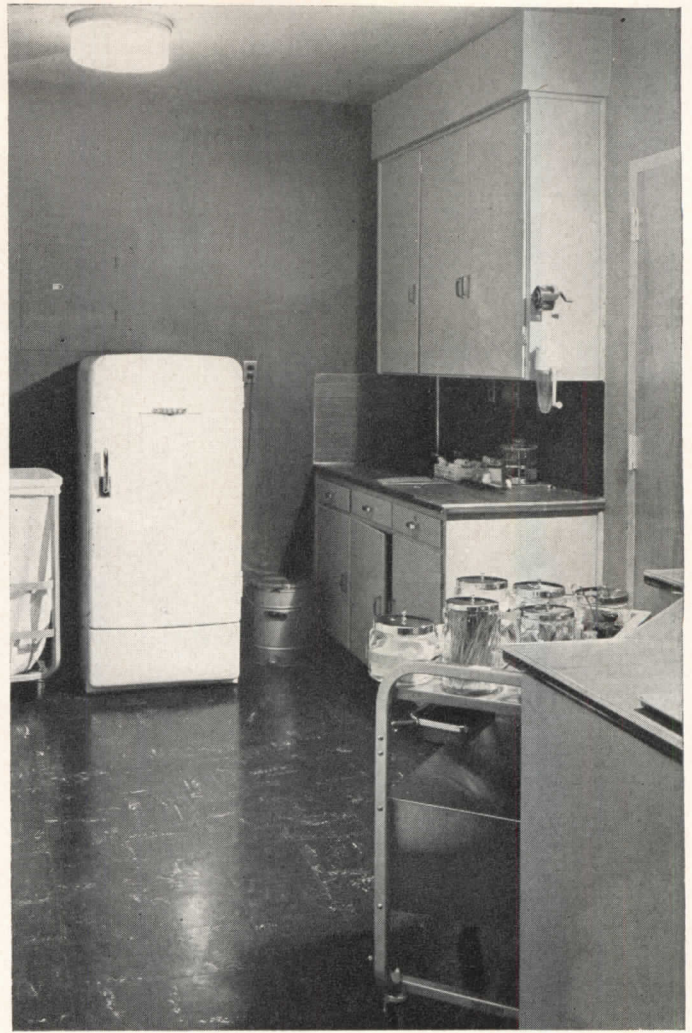


Opposite page, above: view of corridor, looking toward operating rooms. Center, left: central sterilizing. Right: emergency operating and examination room. Bottom, left, operating room; and right, delivery

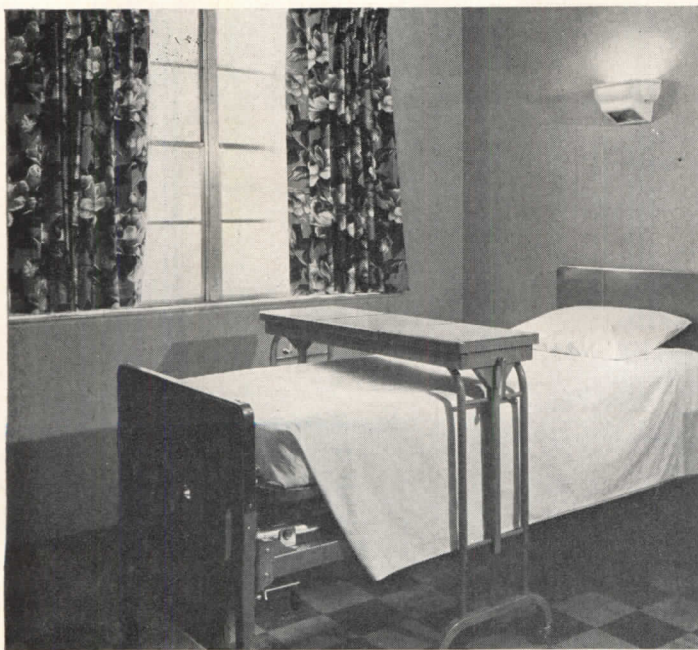


Plan is very compact, with areas and ceiling heights kept down, though operating rooms are full sized. Boiler room is exceptionally compact; heating is by ceiling radiant system, to save space of radiators

Right: utility room of Cozad Hospital is one of the areas not kept to minimum. Below: corridor is kept to narrowest possible, but manages tile for full wainscot

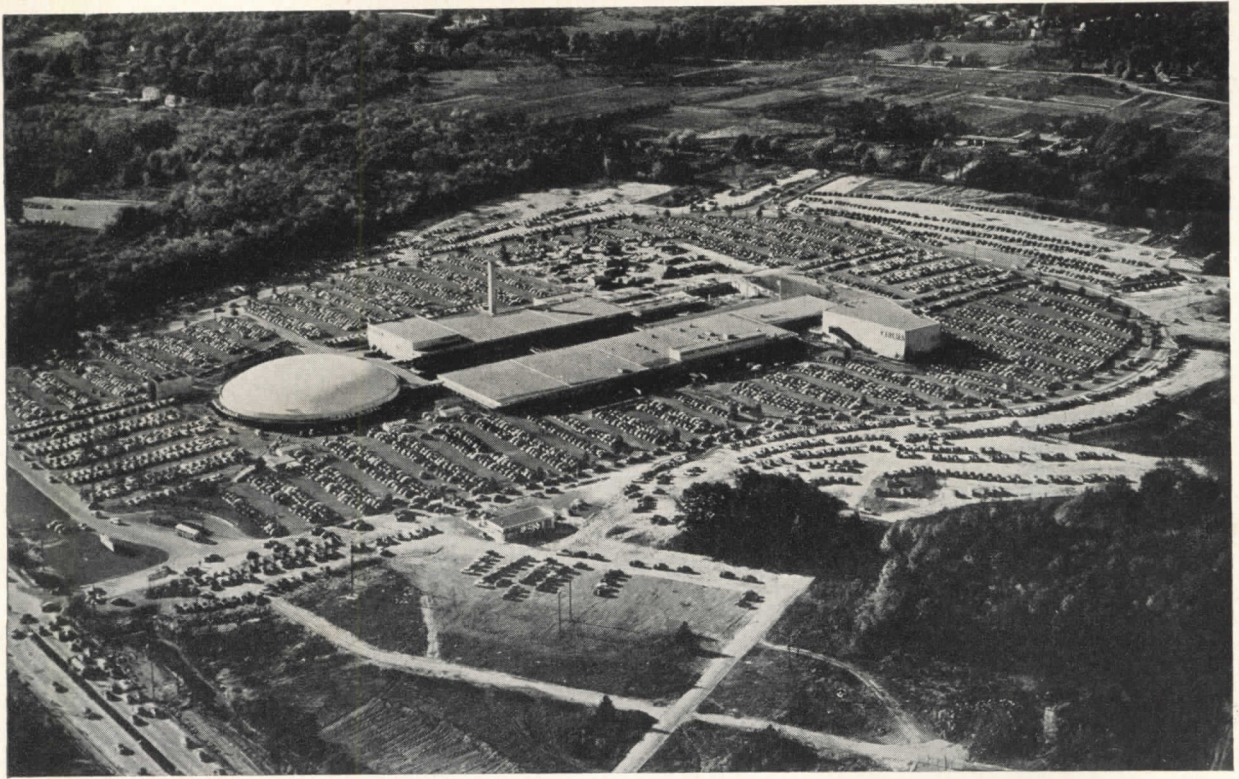


Below: bedrooms are minimal in area, and ceiling heights are low. Ceiling radiant heat saves space of radiators



Vieregg Studio





Shoppers' World at Framingham, Mass., an outstanding example of regional shopping centers, seen at peak parking demand. Additional land in reserve could more than double present parking. Architects: Ketchum, Giná & Sharp

# TRAFFIC PROBLEMS IN SHOPPING CENTERS

## PART 1 PARKING

*How it affects traffic engineering, the site plan and store design \**

*By Kenneth C. Welch, A.I.A., and Bruno Funaro, A.I.A.*

**I**N A SHOPPING CENTER which depends mostly on customers coming by automobile, the design of the parking area — which may have to be so large as to cover more than 80 per cent of the site — is not only a matter of traffic engineering, but is closely integrated with the site plan and the design of the stores proper. This article will be mostly concerned with the latter aspects of parking design.

### **How Much Parking?**

Question number one in the mind of the developer of a new shopping center is "How large should the parking area be?" An answer to this question, even in the nature of an approximate estimate, is essential before any center can be planned.

Insufficient parking will prevent a

\*This article appears concurrently in *Architectural Record* and *Traffic Quarterly*, with the permission of The Eno Foundation, Saugatuck, Conn., publishers of the *Traffic Quarterly*. Privately endowed and affiliated with Yale University, The Eno Foundation is devoted to study and research for highway traffic and parking improvement and also is a publisher of monographs on traffic engineering.

shopping center from reaching the maximum productivity. The merchant who wishes to produce his maximum possible December sales (at which time he makes an important proportion of his annual profit) must be able to take care of all the customers who come at that time.

Evidently, when land is abundant and cheap, it is safer to provide parking in excess of the demand rather than to risk curbing the productivity of the stores because of parking deficiency. The question "how much parking" can, in effect, be divided into three different questions:

1. How much parking will be required at the weekly peaks (which generally occur on Saturday mornings or on those nights on which the stores stay open late)?
2. How much parking will be required at the peak of the Christmas shopping and of special events?
3. How much parking in excess of the current needs should be provided

to meet future increases in parking demand which may be due to increased productivity of the stores, changes in shopping habits, and expansion of the stores?

The reason for three separate questions lies in the fact that we are actually dealing with three physically distinct areas. The parking area which is normally used every week requires paving, lighting and landscaping in quite a different manner than the area reserved for overflow parking which is used only on few occasions during the whole year. The land earmarked for future expansion could be kept unimproved until the demand for it seems imminent.

Realistic answers to these questions can be obtained only from the observation of the actual performance of shopping centers which have been in operation for a number of years. The new large regional centers will undoubtedly provide useful data. So far, whatever data are available from them are incomplete and often misleading because these centers have been open for too

short a period and have not yet reached their full productivity. However, some statements of a general nature can be made safely.

The parking demand, with its weekly and seasonal fluctuations, has been found to follow a very similar pattern in centers similar in size and types of stores. Differences in parking demand can be traced back to foreseeable causes (like extent of public transportation, prevailing types of stores, size of the center).

For a good-sized suburban regional center (of about 500,000 sq ft gross store area), depending almost entirely on shoppers coming by private car, with at least one, perhaps more, department stores, the maximum demand during a typical week will probably have a parking index of 5 (see table this page); during seasonal peaks it can rise to 10 or more. An index of 15 should be pro-

plan. It is evident that the more the parking area is increased, the further it stretches away from the stores, until it will reach a distance, beyond which, its value as parking becomes nil. How far the parking field can extend away from the buildings and still be useful will depend on a variety of circumstances, including the eagerness of the shopper, the state of the weather, and what is offered by other centers within the region.

For design purposes, let us assume 400 ft as the maximum parking distance from the outer fringe of the parking area to the stores, for regular (everyday) parking, and 650 ft (3 minutes walk) as the maximum distance for the overflow parking—a distance which may have to be walked only on very rare occasions. Then as an example, let us take the shopping center mentioned before and translate it into a diagram-

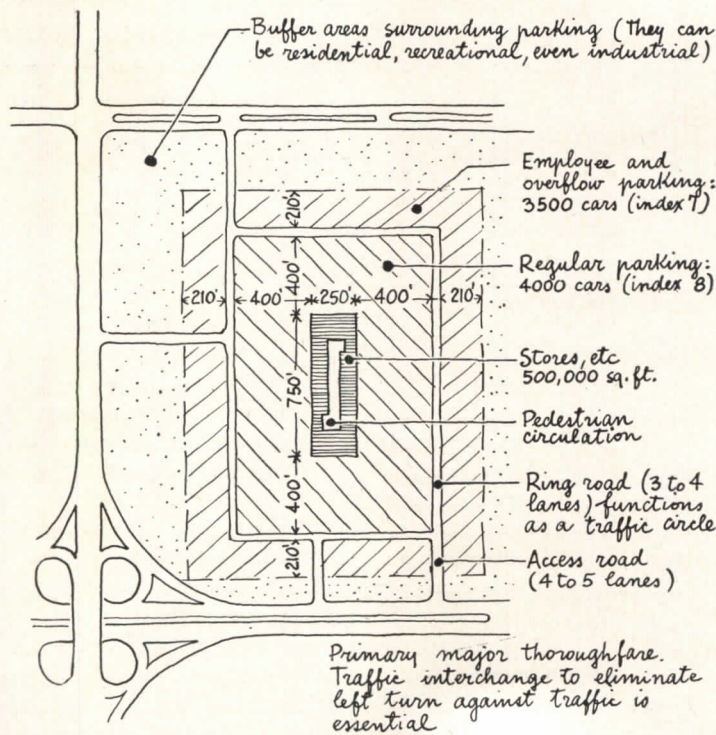
into a multi-level design. The parking belt has an area of 1,440,000 sq ft and holds approximately 4000 cars (counting 360 ft of gross area per space). The parking index is, therefore, 8.

Since this type of site plan—with the parking area all around the stores—provides the largest amount of parking within an established distance from the buildings, the index of 8 seems to be about the top that can be reached for a shopping center of this size, if the assumed 400 ft maximum distance is to be maintained. If the parking area can be extended on all four sides, it would take an additional belt 210 ft deep to provide the additional spaces needed to reach the index of 15.

This example shows that often the geometry of the site may be the determining factor of the relation between parking, access roads and buildings. If, however, the parking index which should be reached in order to achieve maximum store productivity, calls for a more extensive parking area than can be reasonably placed within the site, it will be necessary either to build multi-story parking structures or to resort to a shuttle-bus service, both of which add to operating expense.

#### Circulation in the Parking Area

The shopper should be able to find her (or his) way around easily without any previous study of the site. The



Theoretical plan for a regional shopping center shows how the geometry of the site can be a limiting factor in the development of the parking area

vided for a properly balanced center—which sells 85 per cent shopping goods and which depends over 95 per cent on automobile transportation—when this has reached a 90 per cent of top productivity.

#### Geometrics of the Site Plan

Excessive emphasis on the extent of parking may become meaningless unless the parking can be fitted into the site

matic plan, with the stores grouped around a landscaped mall. The average number of floors for the stores is three (including partial basements and upper stories). The gross store area is 500,000 sq ft.

All around the store buildings there will be a parking belt 400 ft deep. This is the maximum amount of regular parking that can be placed around that store group if we do not want to go

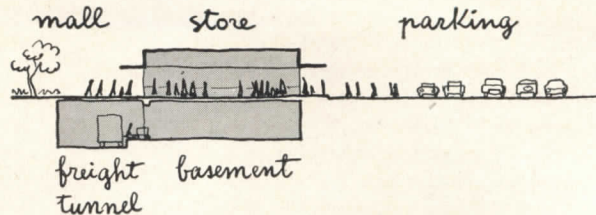
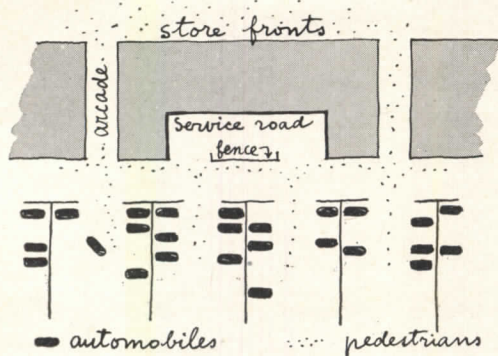
#### PARKING INDEX

The most generally accepted parking index for a shopping center is expressed by the number of car spaces per 1000 sq ft of gross operating floor area of the stores (this includes the floor area of basements, mezzanines and upper stores, but excludes the service area outside of the stores like boiler rooms and freight tunnels). For example, a center with 200,000 sq ft of gross store area and with 1500 parking spaces has a parking index of 7.5

$$\left(\frac{1500}{200} = 7.5\right).$$

most satisfactory pattern consists of parallel parking bins perpendicular to the stores with a major feeder road or ring road at the end of the bins away from the stores.

This road should provide continuous circulation on the site—i.e. to act as a traffic circle. Access to the stores by vehicles should be limited to circulation to arcade and key store entrances, parcel pick-up stations, etc., for the pur-



When store fronts are on the opposite side of the parking area (left), shoppers walking from cars to stores must take a circuitous route. A freight tunnel at the basement level (above) would make store fronts possible on both sides, but the cost might be difficult to justify

pose of picking up passengers. Other circulation adjacent to stores should be discouraged in plan. In this way minimum interference between vehicles and pedestrians is assured. A two-way circulation to the bins is desirable.

Demounted shoppers can walk easily along the bins from cars to stores. When the bins are not longer than 400 ft, there will be surprisingly very little traffic in each one of them even when the parking area is in full of activity. Raised walks between cars are generally undesirable. The shoppers would rather walk on the wide pavement of the bins than on a narrow walk between car fenders. In the north, raised walks are also an obstacle to snow removal. Instead of using walks it would be better to add this space to the width of the bins.

After having walked along the bin, the shoppers cross the road running along the side of the stores (curb parking should be avoided) and are ready to enter the stores — that is, if the entrances of the stores are there. A simple pattern of stores with their fronts facing the parking area (front parking) is undoubtedly the best for directness of access to the stores, but is obviously only suitable for the neighborhood center made up of convenience goods stores.

Shopping goods stores demand maximum ease of pedestrian access between stores. This is the feature that has always made them successful in the downtown district — the only shopping goods center heretofore.

There are, basically, two ways to solve this problem: the first is to lead the shoppers to arcades which pierce through the store building. These arcades have to be frequent enough so that the customers are not forced into an extended walk along the service yards of the stores — shielded as they may be by planting or fences and livened with directional signs and advertisements.

The arcades on the other hand,

should not be too frequent because, while they provide access to smaller, shallower shops and services, they do constitute a structure which is not productive as such, and hence affect the economic picture. If they are too far apart, they obviously increase walking distances from parked car to store.

The second way is to provide a servicing passage underground or below the parking level leading to the great majority of stores at basement level. It is more costly but under certain conditions justified.

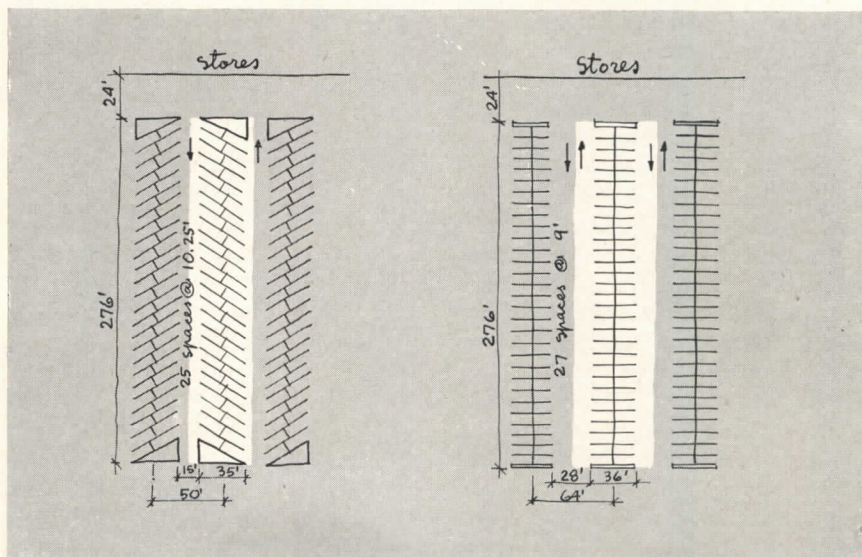
Care must be used, in the type of shopping center shown and described here, not to detract too much from a

### What Angle Parking?

The accompanying diagrams illustrate why the authors are generally in favor of the 90 degree pattern — because this combines economy of space with extra wide bins suitable for two-way circulation, elimination of expensive curbs, improved sight lines and hence, greater safety.

### Parking Analyses for Better Forecasts

Now that a few large planned shopping centers are already in operation — and many more are expected to follow — there is going to be the opportunity to check with actual parking surveys many



Although 90 degree parking with two-way traffic takes slightly more space per car than 60 degree parking with one-way traffic (295 sq ft as compared with 276 sq ft), 90 degree parking is preferable. Cars can move in both directions, and sight lines are improved

concentration of common pedestrian traffic on the interior common area, nor to complicate the operation of some types of stores wherein a two-front entrance can be detrimental. This system, with a greater number of stores which can use two fronts, makes it possible to reduce the number of entrance arcades.

of the theoretical assumptions of the past. It is hoped that some form of standard procedure for parking analyses may be generally adopted so that traffic data collected in independent surveys may be easily compared and different trends may be evaluated. As an example of how this particular type of survey can

be handled, we outline the principal subjects which have been investigated in the course of traffic surveys for shopping centers made by Larry Smith & Co., real estate consultants and Victor Gruen, architect.

1. *Traffic Count at Entrances.* The number of cars entering and leaving each entrance is plotted for every half-hour period during a whole week. Since the activity of a shopping center has a weekly cycle, any complete investigation has to cover the span of a week. Comparison of data collected during different weeks throughout the year will in turn reveal the character of the seasonal fluctuations. It is possible, also, but taking the count at what might be considered an average time, to estimate through a comparison of daily sales the amount of parking space which would be required at the peaks.

2. *Parking Accumulation.* From the traffic count at the gates, it is possible to determine the number of cars which are within the parking area during each half-hour period. These figures reveal the pattern of fluctuation of the parking demand during the week and may assist in forecasting when auxiliary parking or other special measures may have to be provided.

3. *Parking Lot Turnover.* This is obtained by dividing the number of cars which have entered the parking area during the whole day by the maximum number of stalls used during that day.

Turnover and accumulation are an index of the shopping habits of the region. In a shopping center which has both convenience and shopping goods, there may be periods of greater turnover due to intensive short-time convenience shopping, and periods of great accumulation but less turnover when shopping is mostly for shopping goods.

4. *Duration of Parking.* Separate counts are taken in different areas of the parking lot to determine the relationship between duration of parking and the character of the adjacent stores. At certain seasons it is possible to make an aerial photographic record of the use of the parking area which can be tied in with the traffic count.

5. *Automobile Occupancy* (in men, women and children). This will give a better knowledge of the shopping habits of the region. The number of persons per car is definitely greater in a suburban center, appealing to the whole family; on open nights the occupancy will certainly exceed two.

## PART 2 THE PARCEL PICK-UP SERVICE

Prepared by *Kenneth C. Welch,*  
*Bruno Funaro and the editors of*  
ARCHITECTURAL RECORD

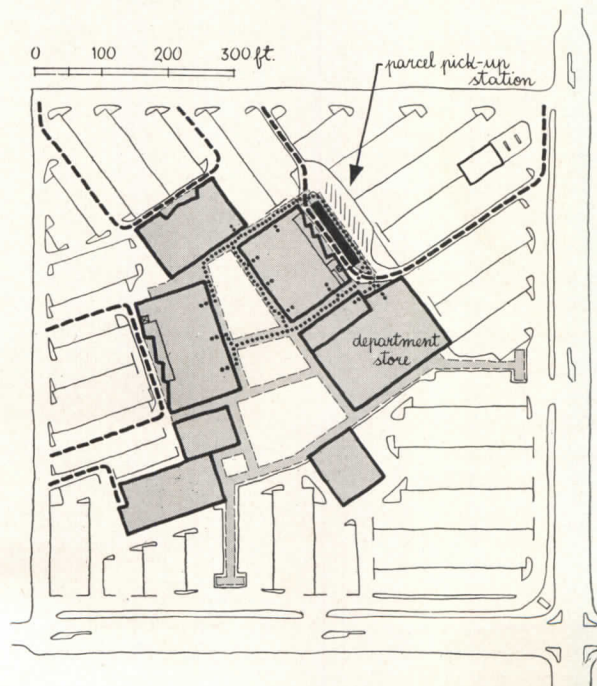
**Packages are transported to customers' cars by a number of systems ranging from pushcarts to long, underground conveyors**

**I**N SHOPPING CENTERS some system is desirable which will encourage the customer to take parcels home in his own car, even with items as large as card tables or small chairs. A system which transports parcels from the store to the customer's car makes shopping easier and can cut down the store's overhead.

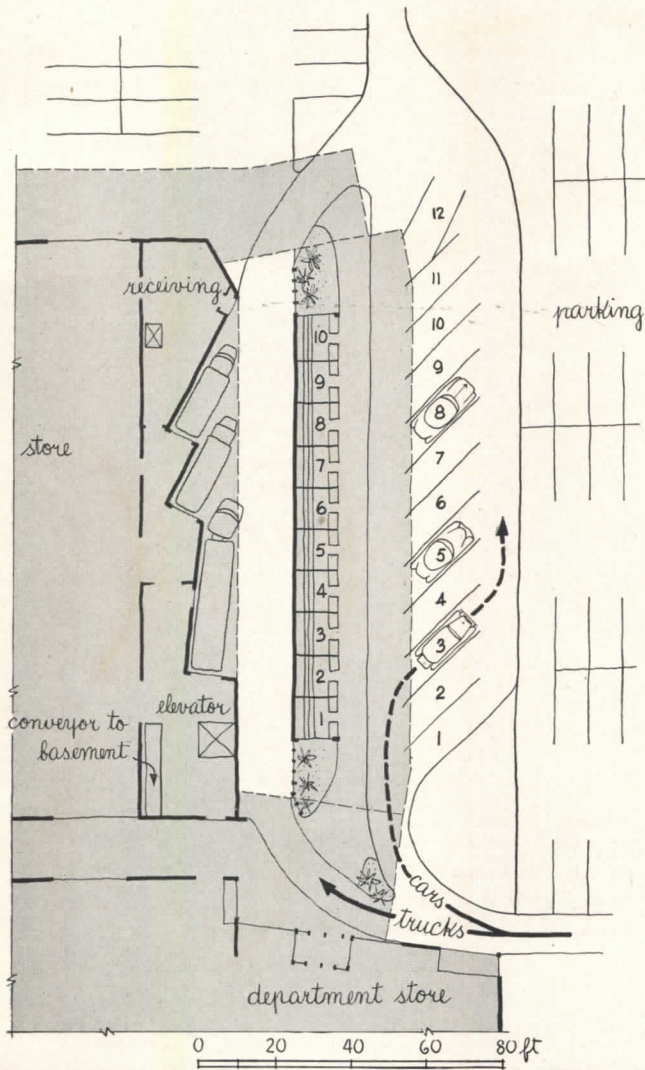
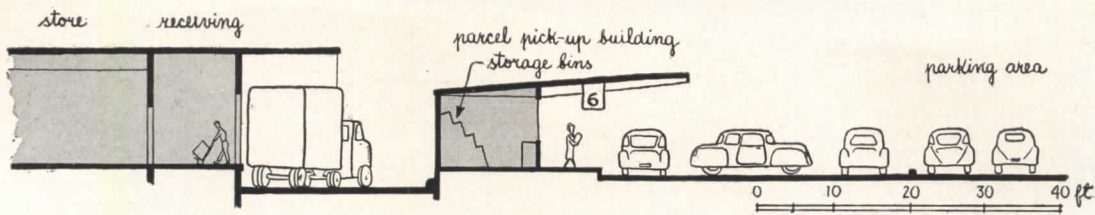
If the shopping center is to reach its maximum sales potential, the customer must want to shop even during the busiest times. He will be more inclined to do so when he can park wherever there is an available spot, shop where he pleases, have his purchases deposited at a parcel pick-up station, and then drive to the pick-up station to get them.

One way this can be done is illustrated here in the drawings for a proposed shopping center in Toledo, Ohio (also AR, Mar. 1951), designed for maximum ease of pedestrian contact between stores.

Parcel pick-up systems are a fairly new idea, and so are not very numerous. They have been used more in supermarkets than for stores dealing in apparel, home furnishings and durable goods. Packages from supermarkets are large in number and are always taken home, so a parcel pick-up arrangement can effect quite a savings in personnel who ordinarily would take the groceries out to cars. Examples are shown on page 228.



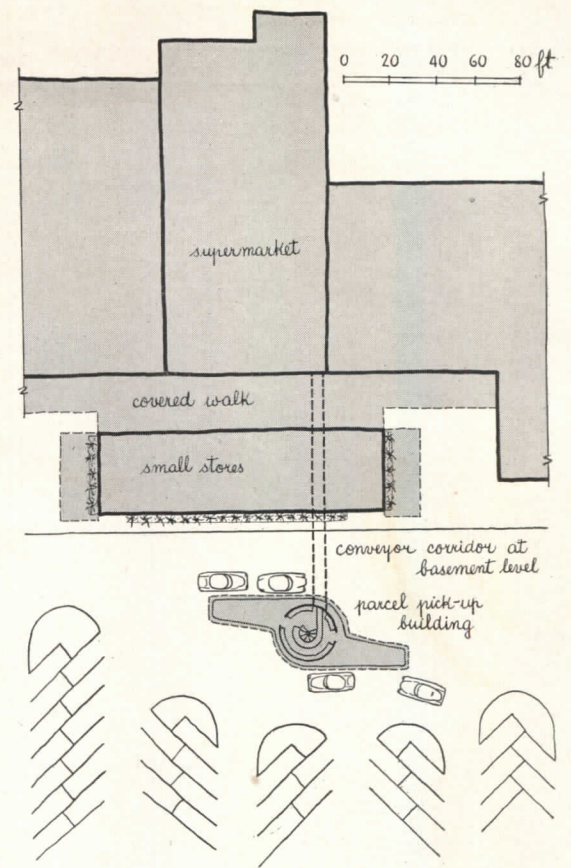
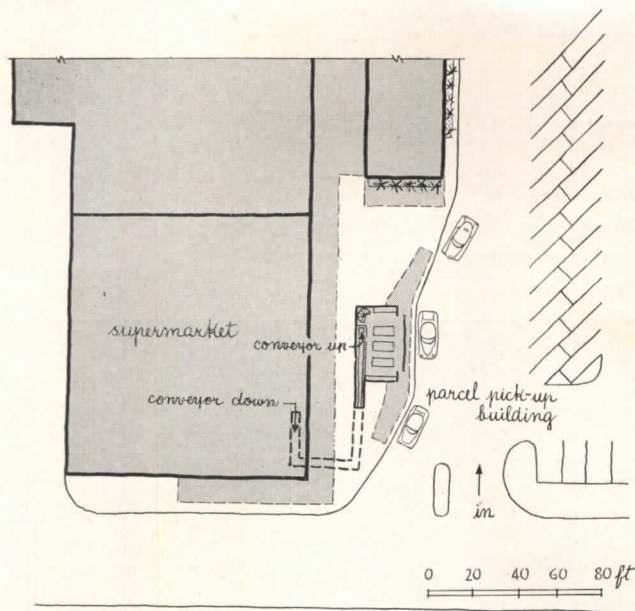
The parcel pick-up station for a proposed Toledo shopping center is next to the department store. Clerks' or customers' travel for taking packages to the pick-up station is indicated by dots; truck travel by dashes. The three buildings in the lower half are, left to right, a supermarket, drug store and restaurant. The remaining stores sell convenience and shopping goods and are only a short distance from the pick-up station. Details of the parcel pick-up station are across page



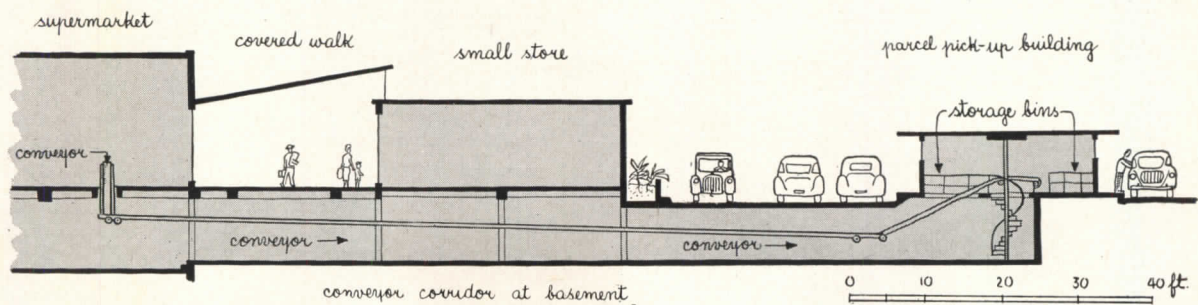
At Wieboldts in Evanston, Ill., the customer leaves her purchase at a Customer Package Desk. Then the package is taken by pushcart across the street to a pick-up station on one of the two levels of the parking garage. The customer has a check with a key number and a plastic card with the last three digits of the check number on it. The customer sticks the plastic card under his windshield wiper and the attendants get the packages ready as she approaches

Above: How the pick-up station works. The customer takes, or the store sends, the packages to the parcel pick-up building. Each package has attached to it a detached portion of the customers claim check. The claim check would be numbered and perhaps colored. Packages would be left at the bin having the number that appears as the last digit on the claim check, and the sign at the bin would be the same color as the claim check. Cars can drive in and out without interference with other cars. Shaded area is covered. Kenneth C. Welch, Architect





Parcel pick-up station for the Kroger Co. (above) has an underground conveyor, "U" shaped because of the proximity of the pick-up station to the store. The Jewel Food Store (right and below) has a straight conveyor. Both stores are at the Evergreen Park Shopping Plaza in Chicago. Howard T. Fisher and Associates, Inc., Architects & Engineers; Holabird & Root & Burgee, Architect-Engineer



Conveyor system at Jewel Food Store in Park Forest, Ill.



Boys Market, Los Angeles, has bins for leaving carts

# A NEW APPROACH TO SAFETY OF BUILDINGS

By Paul Weidlinger\*

The author discusses the potentialities of statistical methods for estimating the safety of a structure. He points out that the real measure is not the factor of safety, but the probability of failure

THE REAL TEST of the underlying assumptions of a structural design is not in the performance under the design load, but in the failure of the structure. A building may be designed under wrong premises, with mistaken methods, and nevertheless may (and very often does), due to fortuitous circumstances, perform adequately for many years, and for many reasons.

The only completely reliable way to test any one structure would be to destroy it and thereby determine its load-carrying capacity over and above the design load. Since this, admittedly, is not a practical means of assuring the safety of our buildings, structural analysis is employed in engineering design. But all not fully empirical methods require two decisions:

1. The choice of a suitable hypothesis as to the behavior of the structure.
2. A rational judgment or a measure of the expected deviations of the real structure from its idealized counterpart on which the analysis is performed.

Both of these points necessarily lead to fundamental considerations. Thus, hypotheses are constantly revised in light of new experiences and sharper or more exact methods of experiments.

Unfortunately these revisions usually involve more complex and cumbersome methods, and the justification of their use in engineering to obtain added precision is thus debatable.

Also, the question of reliability of classical theories reproducing the behavior of the real structure inevitably enters into any judgment of the safety of the structure itself, which leads to the second of the above points. The fact that our assumptions as to the behavior of materials, structures and occurrence of service loads are less than

well-founded is apparent in the use of factors of safety in practically all engineering designs. Any attempt to measure or even estimate such uncertainties involves, consciously or otherwise, some applications of the theory of probability.

The results obtained through it in many fields (insurance, for example) have made it probably one of our most efficient tools of scientific analysis.

In view of this, any discussion of safety factors would be incomplete, or even meaningless, without considering the theory of probability which, in spite of philosophical connotations, is an understandable and quite practical subject, as will be shown in a few simple examples. The purpose is not to develop a rational method of determining safety factors, but to provide an insight of its effect on the performance and other aspects of structures.

## Definition of Factor of Safety

*The factor of safety is a fraction denoting the ratio between the maximum load-carrying capacity and the design load. If the maximum capacity, or resistance is more than the design load, then this fraction is larger than one (structure safe); if the resistance is less than the design load, the fraction becomes less than one (structure unsafe). Instead of maximum load-carrying capacity and design load, other quantities characteristic to the performance may be used. It might be more practical to relate the service conditions, not to the ultimate characteristic, but to some other limitation corresponding to the useful or service limit of the structure.*

The need for a factor of safety larger than one has never been questioned, due to the inherent imperfections, errors, uncertainties and ignorance of all human endeavors, from which structural engineers are not exempt. Both the numerator and denominator of the fraction representing the factor of safety are subject to fluctuation. These fluctua-

From the Code of Hammurabi (Circa 1250 B.C.)

“. . . If a builder build a house for a man and do not make its construction firm, and the house which he has built collapse and cause the death of the owner of the house, that builder shall be put to death . . .”

tions are due to simultaneous variations of many components:

1. Uncertainty in the live load assumptions.
2. Errors in dead load computations.
3. Uncertainty or ignorance as to the physical characteristics of materials.
4. Imperfections or inadequacy of assumptions and methods of stress analysis.
5. Imperfections of workmanship in the execution of the design.

These components may cause, in two different ways, a reduction of safety:

- (a) *Through decrease of the load-bearing capacity* (because of the lower performance of the materials than was assumed).
- (b) *Through increase of the computed stresses or strains* above the actually existing values (because of increase of the loads over those assumed, or because the values given by stress analysis are less than the ones actually existing).

The true factor of safety, therefore, differs from the nominal value by the extent of the above variations. And this factor of safety, which incorporates all predictable unfavorable variations, cannot be less than one in a safe structure.

## Actual Safety Factors

Considering actual numerical values connected with safety factors, the mistaken notion that all ordinary structures are designed with very large safety factors can be dispelled. Actual facts contradict such statements: the working stress used in steel structures is, for instance, 1.75 times that of the yield point strength of the steel.

But this does not mean that such members are 1.75 times as strong as they are supposed to be. This will only happen if the capacity of the actual structure corresponds exactly to the

\* This article is based on excerpts from a chapter of a book Mr. Weidlinger is now writing to be published by F. W. Dodge Corporation.

design assumptions. In a simple practical example, the implication can be observed:

A 1 by 1 in. steel tension bar will support 10 tons with a factor of safety of 1.75. This means that if the yield strength and the dimensions of the bar are exactly as specified, it will support 17.5 tons before a permanent deformation will occur. But this also means that if the bar were fabricated to a size of  $\frac{7}{8}$  in. square instead of 1 in. square (an error of only 15 per cent), and the load happens to be 27 per cent higher than was estimated, then failure will occur. It can be seen that these figures show no relationship to the safety factor of 1.75.

With advancing technology in the production of building materials and improved design methods, it seems only natural that the safety factors employed should be correspondingly reduced. There is always a certain lag between such improvements and the corresponding revisions in building codes. A case in point is structural steel. The strength characteristics of this material have improved so rapidly that during a certain period before codes were finally revised a higher factor of safety was used than in earlier times.

In view of such anomalies, it has become the mark of any progressive architect or engineer to criticize building codes, and especially safety factors, as being archaic. While such criticism is often justified, the argument used to

support it is, in most instances, equally antiquated.

The question boils down to what is actually meant by the factor of safety. As long as it is regarded as some sort of a measure of the actual safety of our structures, such criticisms can produce no fruitful conclusions.

### Probability of Failure

The preceding discussion might have helped to clarify the purpose of the factor of safety or may have only brought into focus some of the complexities of the problem, but it could not tell anything about how big the safety factor should be. At the present time the factors of safety for various materials, types of structures and loading may vary anywhere between 1.3 and 10. They are based on the past experiences and judgment of competent engineers.

The meaning of a given factor of safety is quite nebulous. A factor of 2, for instance, does not mean that a structural element will break or reach its service limit if the design load is doubled. Depending on the chance fluctuation of components it may take considerably more or less than double of its design value.

*The real measure of safety of a structure is not the magnitude of the factor of safety but the numerical value of its probability of failure.* This is actually recognized even in our present day practice, through the use of various factors of safety for different parts of

the same structure or for different types of stresses.

This practice seems to contradict the basic common sense rule that the chain is only as strong as its weakest link. What is the use of making some links in structures weaker than others? The answer lies that in the judgment of the designer (or authors of building codes), the chance of failure is less for some elements than for others.

The cables of suspension bridges, for instance, are made of very carefully controlled materials, so the actual stress can be calculated with greatest of precision. The probability of failure of the cables therefore is less than that of any other main structural element of the bridge. For this reason a lower factor of safety is used in the design of the cable than in other parts.

*In terms of the factor of safety, the cable is the weakest link in the whole bridge; in terms of probability of failure, it is probably the strongest.*

If the probability of failure is the more rational measure of safety, then the question arises as to the suitable value which should be assigned to it. While a certain factor of safety does not tell anything about the actual safety of a building, the fraction expressing the probability of failure at least permits an estimate.

### Mathematical Probability

Mathematical probability is a fraction which can vary between zero and one.

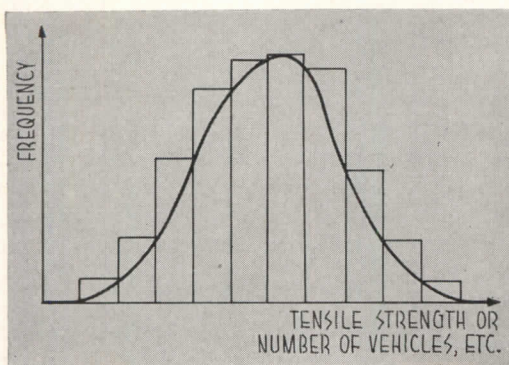
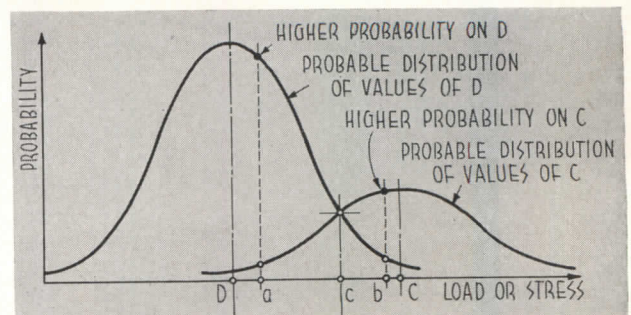


Fig 1. Frequently with a large collection of data, specific numerical values tend to occur more often than other ones. Their distribution can be represented on a "distribution curve." For example, such curves can be drawn for the tensile strength of steel, or for the number of trucks counted in a total number of vehicles passing over a certain bridge

Fig 2. In the design of a particular structure, the values selected for the design load and the load-carrying capacity might in actuality be slightly different due to various inaccuracies. If sufficient statistical data were available on other structures of the same type, it would be possible to plot distribution curves for the design load "D" and the load-carrying capacity "C." Under ideal conditions, the load would be at "D" and the load-carrying capacity at "C." If a failure occurs at "a," there has been overloading, if at "b," the material is at fault, if at "c," it is equally probable that either cause may be at fault





This fraction expresses the probability of the occurrence of an event, whether it will occur one out of 10 times, one out of 1000, etc.

A probability of one means the certainty of occurrence of an event and zero means the impossibility. In applying this to the safety of structures one endeavors, naturally, to obtain a value very close to zero for the probability of failure.

A complete certainty is impossible to obtain, not only in structural design, but in all human activities based on inferences. The best which can be done is to determine the probability of failure and employ the most careful methods of execution.

Marcel Prot, a French engineer, points out that the probability of fatal accidents lies generally between 0.1 and 0.0000001 and adds that experience shows that a chance of 0.0000001, i.e., one in ten million, is considered completely negligible ". . . even if such accident should cost us our life . . . !"

There are only few instances at the present time where it is possible to estimate the probability of failure of structures because of the lack of the necessary statistical data.

The establishing of a desirable value for the probability of failure does not need to be based on a moral judgment of justification of fatal accidents. More compelling economical considerations usually decide or influence this choice.

It is clear that any attempt to predict or estimate the probability of failure of a structure requires the availability and rational interpretation of data which are relevant to the behavior of the structure. There are only a few instances at the present time where this is possible because of the lack of such data.

The structural engineer is interested in the average and maximum load which will be applied on a building during its lifetime, and in the average and maximum strength of the materials which are used in it. All these data are (or should be) determined on the basis of observations.

In many instances a large collection of such data exhibit certain tendencies — specific numerical values tend to occur more often than other ones. Their distribution can be graphically represented in the so-called distribution curve. Such curves can be drawn, for instance, for the tensile strength of steel (Fig 1), or for the number of trucks counted in a total number of vehicles passing over a certain bridge and for most similar types of observations.

Most such curves exhibit a more or less pronounced peak for certain groups. These groups are the ones which will occur most frequently. The uniformity of the group is an important characteristic and is expressed by the dispersion of the observed values around the peak of the curve.

The measure of the dispersal is the "standard deviation" which is the horizontal distance from the peak to the point from where the dispersal becomes more pronounced.

In light of the above discussion and terminology, the factor of safety can be redefined. The capacity *C* and the design load *D* are mean values of collected data which would be found at the peaks of distribution curves on capacities and design loads. The fluctuations of *C* and *D* will depend on the standard deviations corresponding to the distribution curves of *C* and *D*.

Let us assume that it were possible in a given case to represent the distribution of the various values of the capacity and of design loads in two curves drawn on a common coordinate axis (Fig 2). Assuming that the capacity is proportional to the ultimate stress and the design load to the working stress, then the horizontal axis gives the various stresses in pounds per square inch and the vertical axis measures the probability (or the frequency) of the occurrence of such stresses.

As can be seen on the graph, the stress corresponding to the peak of the design stress (load) is less than that corresponding to the ultimate stress (load-carrying capacity), as would be normally the case.

Under ideal conditions the ultimate stress of the material will be exactly at *C* and the actual stress, due to service loads, exactly at *D*. If, however, failure occurs then the ultimate stress and the actual stress will coincide at the moment of failure. This might happen at any value of the stresses due to some unfortunate coincidence of variations enumerated earlier.

Let us consider three different values of the failure stress located on the horizontal axis of the graph at the points *a*, *b* and *c*. For each of these cases certain conclusions can be drawn:

If failure occurs at "a," then it could be attributed to overloading since the existence of an ultimate stress of this value is more probable (or frequent) than the occurrence of an overstressing at the same value.

If failure occurs at point "b," then the opposite situation exists, and it

should be attributed to the material.

Finally, if the failure occurs at "c," then it can be attributed neither to material failure nor to overloading, since the existence of this stress is equally probable for both the ultimate value and the actual stress.

Through the application of statistical methods, it can be shown that the probability of failure is a function of two sets of variables:

- (1) The difference between the values of *C* and *D*, and
- (2) The standard deviations of *C* and *D*.

The first statement is equivalent to the classical concept of safety, since it means that the probability of failure depends on the difference between capacity and service load.

The second statement introduces the statistical concept, inasmuch as it states that the probability of failure is also influenced by the fluctuation of the values of *C* and *D*. This means that the safety of the structure also depends on the quality control of the materials used, the precision of the design, etc.

### Safety of Structures

Most of our structures are made up of many component parts, or, at least, their strength characteristics are determined by a large number of small effects. Typical in this respect is a cable of many strands or laminated wood. Lumber is ordinarily not free from local defects which reduce its strength.

If such a member is sliced into thinner sections and these are again reassembled in a random manner and glued together, then the probability of the coincidence of all imperfections in the same vertical section of the member will be smaller than some other more favorable arrangement (Fig 3 a, b, c). It has been estimated that under certain conditions, 8 to 10 laminations will justify an increase of 100 per cent in the working stresses in laminated members over the solid section.

The service load applied to structures exhibits similar properties. The critical loading, i.e., one that produces maximum stress or strain in a given part of a structure, is usually a combination of a number of loadings in a specific pattern. In structures made up of a large number of components with many possible patterns of loading, the probability of occurrence of the critical loading is smaller than that of less patterns.

This can be seen in considering the columns of a multi-story building. The

maximum load on the first floor column will exist if all floors above it are loaded. This loading pattern, with all floors loaded, is only one of many other possibilities, any of which will produce a lesser load on the column than the first mentioned one. This can become rapidly a very high number with increasing number of floors; if there are 8 floors, there are 255 possibilities; with 20 floors, 1,948,575 possibilities; with 64 floors, the number of possibilities has 20 digits. This fact is recognized in most building codes which do not require the lower columns of multi-story buildings to be designed for the full loading of all floors above it.

*Generally, the larger the number of small effects of a structure which make up its strength characteristics, the lesser will be the probability of failure.*

There is, however, a second important fact favoring the structural engineer. This has to do with the difference between the assumed and actual behavior of our building materials. It has been said that the only reason why we are able to design our structures is that we are permitted to assume that they behave elastically (deformations are proportional to the stress) and the only reason for their remaining undamaged is their unelastic behavior.

This facetious opinion is uncomfortably close to the truth. Ordinary structures are designed on basis of classical structural theories, the assumption of which is, in all instances, that the building materials are ideally elastic and after removal of loads the deformations disappear.

These assumptions are necessary to permit the application of relatively simple methods of analysis, but they have only a limited relationship to the actual behavior of materials. In reality, the elastic behavior is obtained only for a certain limited range of stresses which are below those which would exist at the moment of failure.

The mechanics of the failure itself have not been entirely clarified for all types of materials, but it is clear that at failure only very few are truly elastic. As a matter of fact, many of our structural materials show a more or less marked plastic behavior (permanent deformation) at high stresses and strains. This behavior changes the initial statical and geometrical configuration of the structure, and therefore the initial assumptions as to the distribution and magnitude of stresses become meaningless.

*This can be observed especially in*

statically indeterminate structures (a girder fixed at both ends, for example) which, at high loads, due to the formation of "plastic hinges," are transformed into determinate structures. With the girder fixed at both ends, due to yielding at the supports (i.e., formation of plastic hinges), the structure is transformed gradually into a simply supported girder. During the course of this transformation, due to the redistribution of stresses at a certain stage, the actual load-bearing capacity may be above that of the original member.

In materials which undergo work-hardening during this process the relationships are more complex. In either case, however, the structure at the range of failure does behave differently from the assumed elastic state. Such differences account for the higher load-carrying ability than predicted by the elastic theory.

A significant advance, taking into account the above considerations, is the theory of limit design. As the name implies, it takes into account the limit of strength of the members to be designed, recognizing, however, that this limit is reached at the unelastic range of the material. Investigations of structural members based on the limit design theory require some revisions of traditional concepts as to their safety.

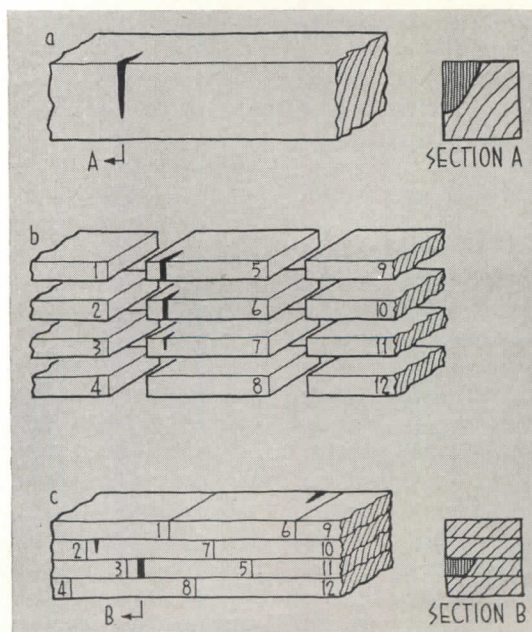
## Conclusions

The design of structures needs to be based on scientific and rational methods, and such methods are available. They have been successfully employed by outstanding engineers in the past and in the present. However, this cannot be shown with respect to safety factors. The rational and scientific methods are available or are constantly being developed, but the pertinent statistical information which should be the basis of their applications are sadly lacking. In view of this, one cannot even rationally answer the question: are our buildings over-designed? The facts prove only that our buildings are not "under-designed" since fatal accidents are relatively rare.

Thanks to the theoreticians, original designing and daring engineering progress are being made in spite of the lack of objective information. Time and again the faith of these pioneers is shattered by the spectacular collapse of structures which, however, gives an added impetus to further research and revision of some basic concepts.

Barring these extreme experiences, a clearer understanding of the meaning of the safety of structures and the knowledge of the factors which influence it will necessarily result in better engineering.

Fig 3. With laminated wood (a number of thin slices of larger pieces, reassembled and glued back together) it has been estimated that under certain conditions, 8 to 10 laminations will justify an increase of 100 per cent in the working stresses as compared with a solid section



## New Coordinated System for Suspended Acoustical Ceiling

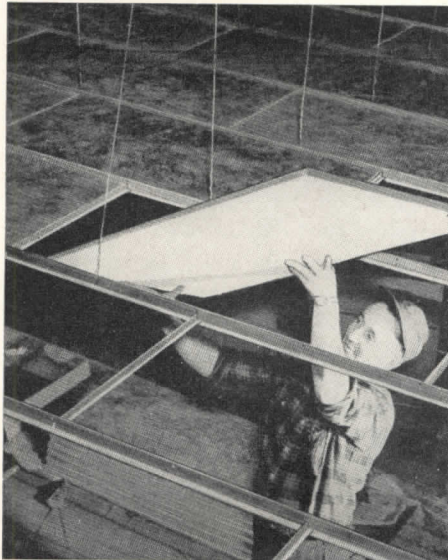
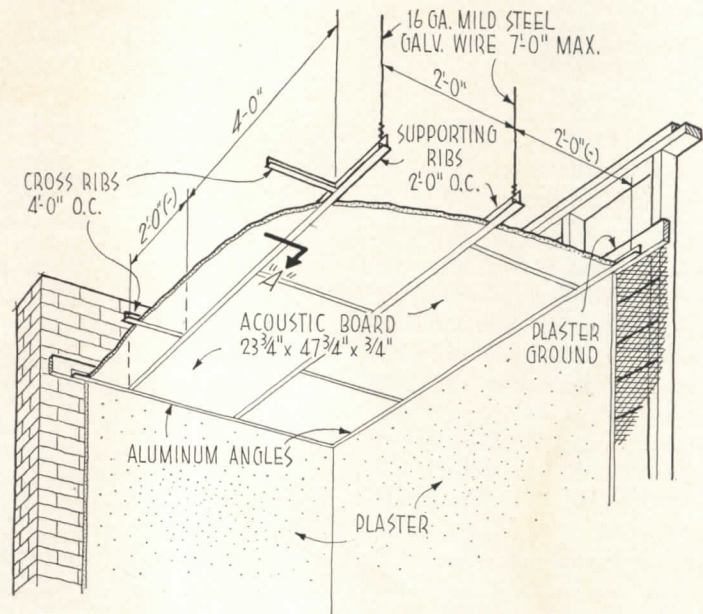
A cooperative venture undertaken by four manufacturers working closely with a client to help solve his particular problem has developed into a flexible coordinated system for suspended ceilings which is now being marketed on a nationwide scale.

When the Blue Diamond Company of Dallas, Tex., was seeking a new, simplified method for roofing supermarkets and similar areas, it called upon two of its suppliers, the Cupples Products Corporation and Owens-Corning Fiberglas Corporation, for help. Blue Diamond engineered a system employing extruded aluminum T-sections and acoustic board. Cupples helped develop a supporting grid system which can be put together, enlarged or reduced like an erector set, and Fiberglas furnished a special, thin and lightweight acoustic board in dimensions coordinated with the grid system. The scheme worked out so well that two lighting manufacturers, Day-Brite Lighting and the Miller Company, were called in to design recessed lighting fixtures which could be supported on the flanges of the grid's T-members without requiring additional support.

As it has now developed, the grid system can be spaced either 24 by 24 in. o.c. or 24 by 48 in. o.c. to accommodate two sizes of ceiling board in either regular or ashlar arrangements. The lighting layouts are extremely flexible, permitting a wide variety of patterns. Day-Brite fixtures are furnished in 2 by 2 ft and 2 by 4 ft units, while Miller fixtures are available in 2 by 4 ft and 2 by 8 ft sizes.

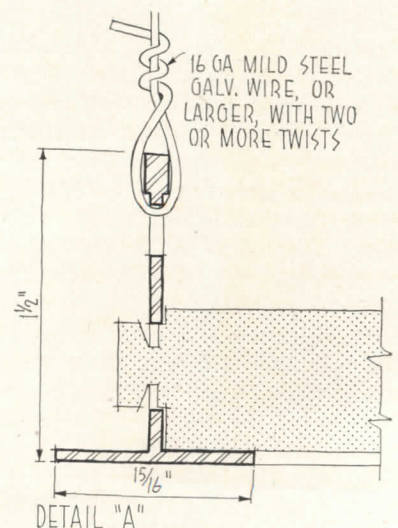
The Fiberglas ceiling board employed in the system is reported to provide an incombustible surface with a noise reduction coefficient of .75 and high thermal insulating value (.33 Btu for  $\frac{3}{4}$  in. thick board). The board is available in two standard finishes, a white-painted, textured finish which may be repeatedly spray-painted for maintenance, and the new *Sonofaced* plastic film surface (reported in ARCHITECTURAL RECORD, August 1952, p. 248). The *Sonofaced* finished is reported to cost only about 10 cents more per sq ft than the regular board and provides a washable

(Continued on page 246)



Suspended ceiling system, shown in diagram above with acoustic board resting on flanges of extruded aluminum T-members. Left, workman installing acoustic panel in grid framework. Note suspension wires

Diagram at right shows assembly and attachment for section A in sketch of system at top of page



## LITERATURE FOR THE OFFICE

### Air Infiltration Through Windows

*Air Infiltration Through Weatherstripped and Non-Weatherstripped Windows*, by C. E. Lund & W. E. Peterson. University of Minnesota Institute of Technology, Engineering Experiment Station Bulletin No. 35. Report discusses results of a three-year research program conducted by the University of Minnesota Engineering Experiment Station in Cooperation with the Weatherstrip Research Institute. Supplementing original studies carried on from 1924 to 1931, the report includes material related to improvements and changes in building construction during the past 20 years. Among the various factors dealt with in the booklet are the following: effect of crack and clearance in window fit; effect of groove clearance on weatherstrip; effect of weatherstripping; effect of locking windows; comparison of infiltration and exfiltration through windows; effect of sash shrinkage; effect of one-piece storm windows. Drawings and photographs of the equipment used in making the tests are included, together with performance tables and charts. 47 pp., illus. Weatherstrip Research Institute, Box 101, Riverside, Ill.

### Color Scheme Files

*Interior Color Suggestions For (1) Hospitals, (2) Hotels, (3) Industrial Plants, (4) Offices, (5) Schools.* These five companion booklets, each with a handy file tab for quick identification, together form a reference file of color schemes for interior decoration of buildings in the enumerated categories. Each has an introduction dealing with special consideration and problems for the particular building type and a set of sheets with color samples. The samples illustrate three separate schemes—ceiling, sidewall and accent, dado or base colors—for particular individual areas in each kind of structure. 92 pp., illus. Devoe and Reynolds Co., Inc., 787 First Ave., New York 17, N. Y.\*

\* Other product information in Sweet's File, 1952.

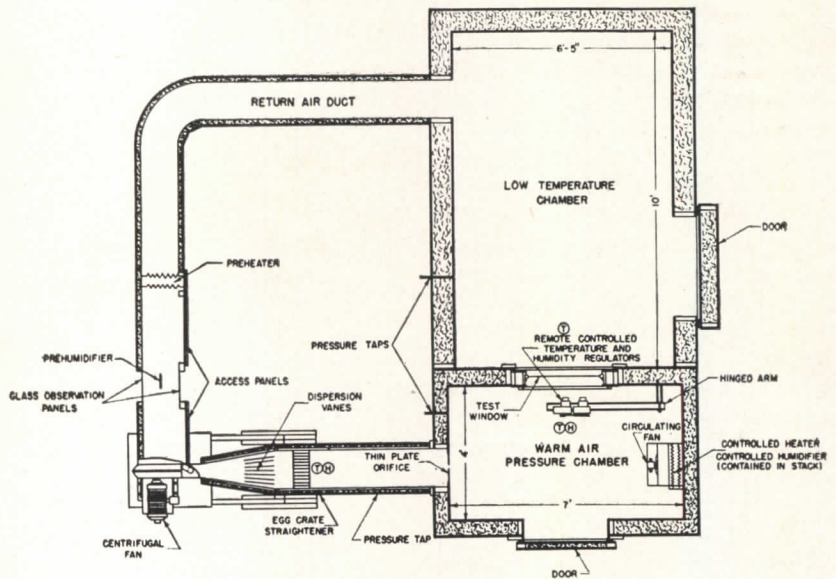


Diagram shows test apparatus used to determine air leakage through windows

### Acid-Proof Materials

(1) *Eonite Pipe and Fittings*, Bulletin 139; (2) *Acid Proof Construction*, Bulletin 160; (3) *Eonite Lacquer*, Bulletin 190. Technical bulletins describe the manufacturer's acid-resistant materials for construction. The first deals with pipe and fittings designed to handle most mineral acids, alkalis and organic solvents. The second booklet discusses methods of constructing acid-resistant pickling and plating tanks; process tanks, vessels and towers; pickling and plating basins and floors. The third bulletin describes a coating for interior or exterior surfaces. 6 pp., 5 pp., 4 pp., all illus. Aqua-Therm, Inc., 37-53 N. Torrence St., Dayton 1, Ohio.

### Aluminum Window Sash

*Thermo-Sash*. Brochure describes the features of the manufacturer's new aluminum window sash. Details of the different series are shown, as are examples of the various installations in which the sash may be employed. 8 pp., illus. Kesko Products, Inc., Bristol, Ind.

### Remote-Control Dictating System

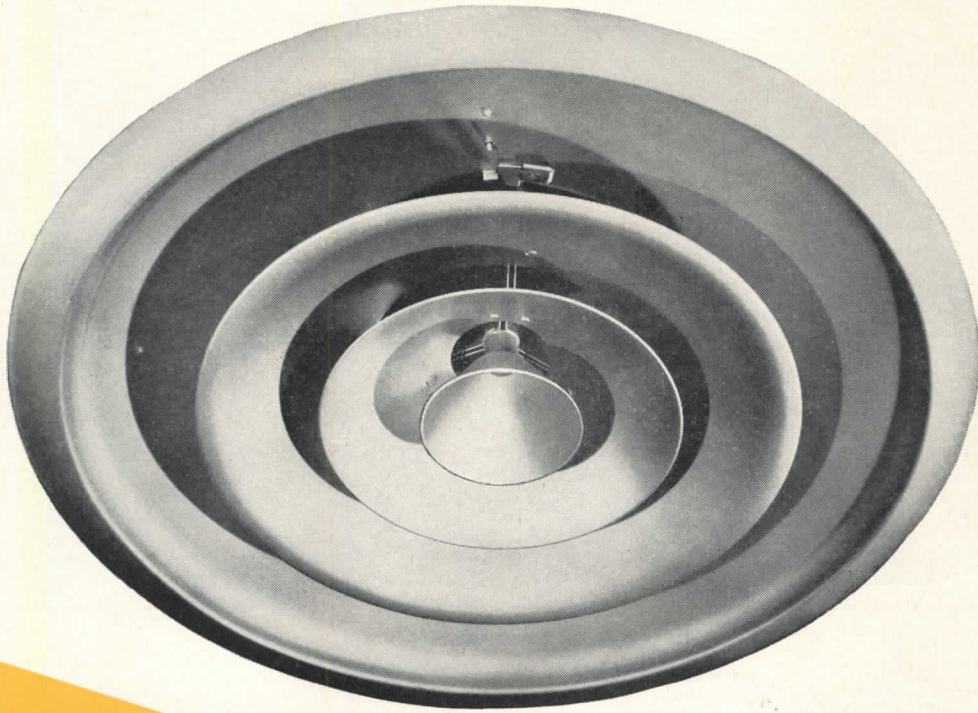
*Edison TeleVoicewriter — The Tele-voice System.* Brochure describes in detail a remote-controlled dictating system for institutional, commercial and industrial use. Informative text is accompanied by photographs of the various available models. Data on switchboards, wiring and wire sizes is also included, and diagrams illustrate typical installation details. 12 pp., illus. Thomas A. Edison, Inc., West Orange, N. J.

### Prefinished Wallpanels

*The Facts About Prefinished Wallpanels.* Pocket-sized booklet has been designed to acquaint the reader with prefinished wallpanels—what they are, how they are used, how applied and where they may be obtained. Answers are furnished to questions frequently asked about this material. 8 pp. Prefinished Wallpanel Council, Keith Bldg., Cleveland 15, Ohio.

(Continued on page 302)

# **N**ot the place to pinch a penny



Type C-1 Adjustable Anemostat Air Diffuser

It makes no sense to cut costs on an air conditioning system by using substitutes for Anemostat air diffusers. Air outlets account for only 4 or 5% of the total cost of an air conditioning system. By saving less than a penny on a dollar, you are more than likely to find your system sadly lacking in comfort due to drafts, stale air pockets or unequalized temperatures.

Anemostat air diffusers, because of their exclusive aspirating design, provide true draftless comfort and uniform air distribution. Don't pinch a penny at the pay-off point. Use Anemostat air diffusers on every air conditioning installation.

*Only Anemostat offers all these types of air diffusers to fill every architectural and engineering need*



ROUND



SQUARE



HIGH VELOCITY



SEMICIRCULAR



STRAIGHT LINE



LIGHTING COMBINATION

**ANEMOSTAT®**  
**DRAFTLESS Aspirating AIR DIFFUSERS**  
**ANEMOSTAT CORPORATION OF AMERICA**

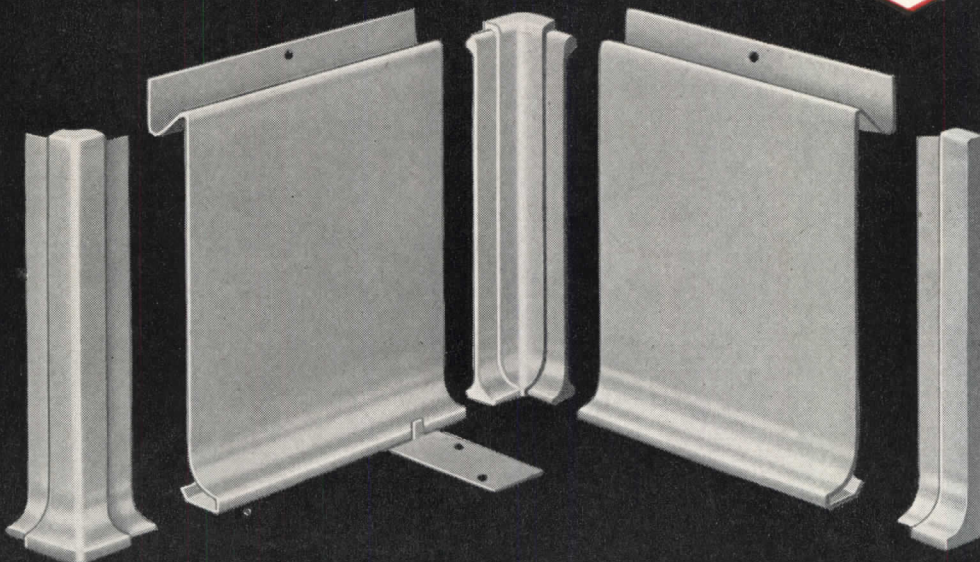
10 EAST 39th STREET, NEW YORK 16, N. Y.

REPRESENTATIVES IN PRINCIPAL CITIES

*"No Air Conditioning System Is Better Than Its Air Distribution"*

**MILCOR**  
REG. U.S. PAT. OFF.

★  
*Anniversary*  
**50<sup>TH</sup>**  
★



**MILCOR**<sup>\*</sup> *No. 605 Plastered-in Metal Base*  
**with friction-fit fittings for faster installation**

**Flush-type plastered-in design** — Base (4" and 6" heights, standard 10' lengths) is punched for nailing to wall. Has slotted plaster flange for easy grouting. Sections of base joined by flat aligning plate, requiring no punching, no screws.

**Fittings require no punching, no screws** — Cast outside and inside corner fittings (square or  $\frac{3}{4}$ " radius) and left-and right-hand end-stops are friction-fit.

**Sanitary, fire-safe, durable** — Ideal for hospitals, schools, hotels, apartments, office and industrial buildings, etc. — with linoleum or any other type floors.

Write for complete information.

\*Reg. U. S. Pat. Off.

**INLAND STEEL PRODUCTS COMPANY**

4035 WEST BURNHAM STREET • MILWAUKEE 1, WISCONSIN

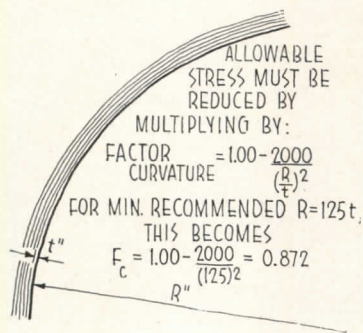
BALTIMORE 24, MD. — 5300 Pulaski Highway • BUFFALO 11, N. Y. — 64 Rapin St. •  
CHICAGO 9, ILL. — 4301 S. Western Blvd. • CINCINNATI 25, OHIO — 3240 Spring Grove Ave.  
• CLEVELAND 14, OHIO — 1541 E. 38th St. • DETROIT 2, MICH. — 690 Amsterdam Ave. •  
KANSAS CITY 41, MO. — P. O. Box 918 • LOS ANGELES 58, CALIF. — 4807 E. 49th St.  
• NEW YORK 17, N. Y. — 230 Park Ave. • ST. LOUIS 10, MO. — 4215 Clayton Ave. M-109

# STRUCTURAL FORMS—8: Long Spans in Wood

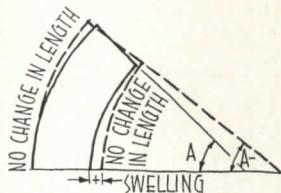
By Seymour Howard, Architect, Instructor at Pratt Institute

## SPECIAL CONSIDERATIONS FOR CURVED MEMBERS

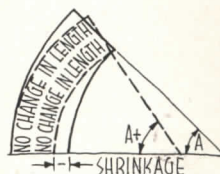
### REDUCTION IN ALLOWABLE STRESS



### EFFECT OF CHANGE IN MOISTURE CONTENT

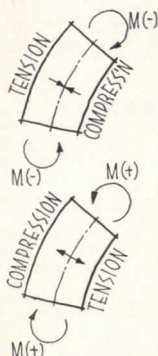


SWELLING causes decrease in angle between two adjacent cross sections



SHRINKAGE causes increase in angle; may create hollow at crown of 3-hinged arch

### RADIAL STRESS CAUSED BY BENDING OF CURVED MEMBER



NEGATIVE MOMENT creates compressive radial stress, stress should not exceed allowable compressive stress perpendicular to grain

MAXIMUM RADIAL STRESS OCCURS ON CENTERLINE PLANE

$$\text{Magnitude} = \frac{3 M}{2 R b h}$$

POSITIVE MOMENT creates tensile radial stress; stress should not exceed (soft woods)  $\frac{1}{3}$  allowable shear stress; (hardwoods)  $\frac{3}{4}$  allowable shear stress

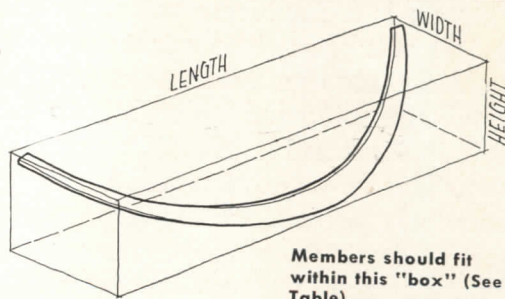
## FABRICATION CONSIDERATIONS

### Transportation clearances

The gluing of laminated wood members is not adaptable to normal job site conditions. Minimum glue pressures are about 100 lbs/sq in. Clamping times, curing processes and temperatures must follow adhesive manufacturers' recommendations closely. Nailing instead of clamping for pressure is not permitted.

Therefore, laminated wood members are best produced in a factory under controlled conditions of humidity, temperature and cleanliness. The size of members is determined by transportation facilities, underpass clearances, state laws on trailer sizes, etc., between factory and job site.

In planning a building for laminated wood construction the architect should contact fabricators as soon as possible.



Members should fit within this "box" (See Table)

#### TRUCK

#### RAIL

#### SHIP

	USUAL	MAX	USUAL	MAX	
Length	45'	80' (110' has been done)	50' (box car) 60' (gondola)	65' 120'	No limitations except size of ship and access to shipping piers by fabricator and by building contractor (site location)
Width	8'	8'	9'-8"	9'-8" 6'-8"	
Height	12'-6"	14'-0"	9'-8" (box) 12'-6"	14'-6"	

Note "Usual" dimensions require no permits; "maximum" dimensions require special truck permits or approved routings by railroad.



St. Francis Hospital, Trenton, N. J. The new \$3,000,000 8-story addition, shown at left, is now under construction. Architects and Engineers: Schmidt, Garden & Erikson, Chicago. Heating Contractor: Wm. F. Hindley Co., Trenton. Operation of St. Francis Hospital is under the direction of the Sisters of the Third Order of St. Francis.

# MEET HOSPITAL REQUIREMENTS

## *with Modern Controlled Steam Heating*

**Balanced Heating . . . Outdoor Thermostat Control . . . Continuous Steam Flow . . . First applied to modernize older buildings . . . Now being installed in new addition.**

Schmidt, Garden & Erikson, Chicago Architects and Engineers noted for their hospital work, are the creators of the completely modern addition now being erected alongside the older buildings of famed St. Francis Hospital, Trenton, New Jersey. This new addition will have modern controlled steam heating incorporating the proven principles adopted in modernizing the original vacuum heating installation in the existing buildings.

The three original buildings, the most recent completed in 1927, were overheated, indicating fuel waste and involving considerable maintenance. In 1949 the original system was changed to a Webster Electronic Moderator System by John G. Carr Co., Inc., Trenton heating contractor.

Reporting results, Chief Engineer A. P. Scharer said that the modernization was

paid for out of fuel oil savings in less than two years. Further, these older buildings are comfortably heated, with a noticeable absence of overheating in mild weather.

Is your hospital in need of modernization? It will cost you nothing to investigate. There are Webster representatives in 65 cities experienced in working with owners, architects, engineers and heating contractors in the solution of specific heating problems. Ask to see your Webster Representative.

Address Dept. AR-10

**WARREN WEBSTER & COMPANY**

Camden 5, N. J. Representatives in Principal U. S. Cities  
In Canada, Darling Brothers, Limited, Montreal

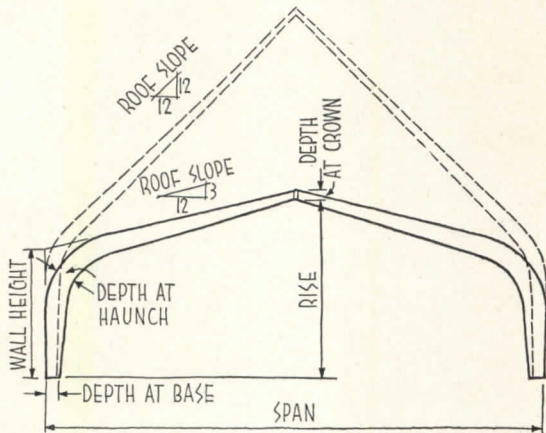
**WEBSTER**  
**MODERATOR**  
**SYSTEM**  
OF STEAM HEATING  
"Controlled by the weather"



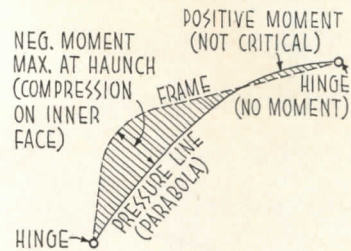
# STRUCTURAL FORMS—9: Long Spans in Wood

By Seymour Howard, Architect, Instructor at Pratt Institute

## THREE-HINGED RIGID FRAMES



Note: Two-hinged rigid frames (as described in TSS sheets on rigid frames in steel, December 1951) are impractical in wood. Fabrication and transportation usually require frame to be made in two parts. A crown connection to take the midspan moment of a two-hinged frame is impractical in wood.

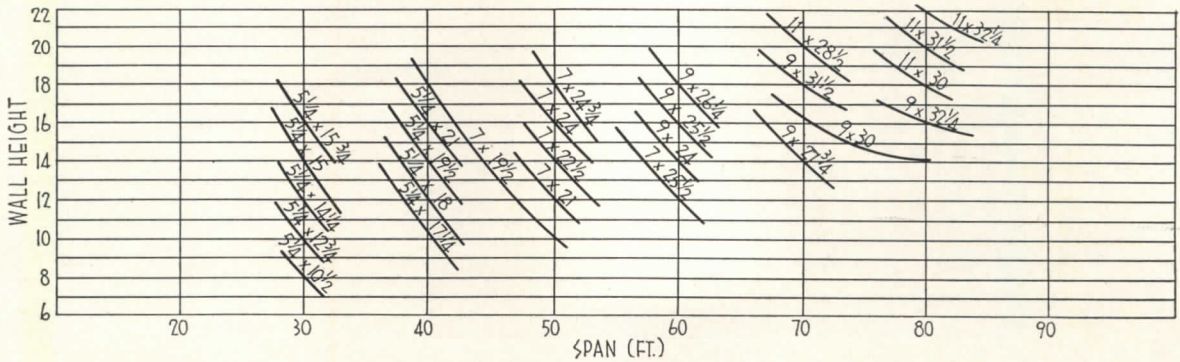


### TYPICAL MOMENT CURVE

Three-Hinged Frame

Uniform loading across entire span (half span only shown)

Note differences between this curve and pressure line for two-hinged frame (Fig 2, Sheet 2, Rigid Frames in Steel)



For vertical load of 1000 lbs/lin ft of span—no wind load (wind load may require heavier sections) and roof slope of 3 in 12 (steeper roof slopes require smaller sections down to about 85 per cent of depth for 12 in 12 slope)

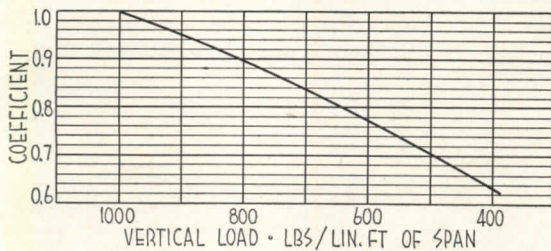
Notes: Based on  $f = 2600$ ;  $c = 2000$  lbs/sq in.

For preliminary approximation of depth at base use:  $0.4 \times (\text{span in feet})'' - 4''$

For depth at crown use:  $0.1 \times (\text{span in feet})'' + 4''$

### DIAGRAM OF FRAME SECTIONS AT HAUNCH (Width'' x Depth'')

(For Preliminary approximation only)



Multiply depth of section by coefficient for other loadings. (Width remains as shown on frame section diagram)

Width Given (b <sub>1</sub> )	Width Wanted (b <sub>2</sub> )	Multiply Depth By = $\sqrt{b_1/b_2}$
3 1/4 in.	5 1/4 in	0.787
5 1/4 in.	3 1/4 in.	1.272
5 1/4 in.	7 ft.	0.866
7 in.	5 1/4 in.	1.155
7 in.	9 in.	0.882
9 in.	7 in.	1.134
9 in.	11 in.	0.904
11 in.	9 in.	1.106

Effect of varying width of section on depth of section for constant section modulus



# NEW! NEW! NEW!

**A dramatically beautiful  
Sound Conditioning  
material unlike any  
other you have  
ever seen!**

Rich, linen-like  
surface that gives  
better light  
diffusion.

Sharp perforations  
of varying size,  
arranged in random  
fashion.

Pattern that  
minimizes joint  
lines, for beautiful  
overall effects.

## Acousti-Celotex RANDOM PATTERN Perforated Tile



Introduced just a few short months ago, Acousti-Celotex RANDOM PATTERN Perforated Tile has already captured the imagination of architects in every part of the country.

Acclaimed the most unusual, most beautiful Sound Conditioning material in 20 years, it offers exciting new decorative possibilities for interiors of every type! Smart, dramatic effects impossible with any other Sound Conditioning product!

But that isn't even the half of it. Like all Acousti-Celotex products, RANDOM PATTERN Perforated

Tile has high sound-absorbing value. Two coats of tough finish, bonded under pressure of a hot knurling iron, give it a surface of superior washability. Can be washed *repeatedly* and painted *repeatedly* without impairing its sound-absorbing efficiency.

**ASK YOUR DISTRIBUTOR** to show you the new Acousti-Celotex RANDOM PATTERN Perforated Tile. If you don't know where to reach him, write to The Celotex Corporation, Dept. B-102, 120 S. LaSalle St., Chicago 3, Ill. In Canada, Dominion Sound Equipments, Ltd., Montreal, Quebec.



### ACOUSTI-CELOTEX

TRADE MARK REGISTERED U. S. PAT. OFF.

*Sound Conditioning*

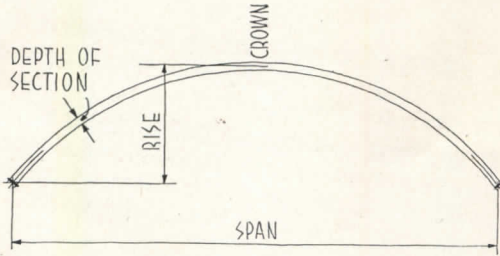
PRODUCTS FOR EVERY SOUND CONDITIONING PROBLEM

THE CELOTEX CORPORATION, 120 S. LA SALLE ST., CHICAGO 3, ILLINOIS

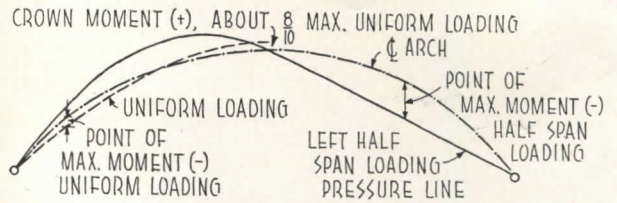
# STRUCTURAL FORMS-10: Long Spans in Wood

By Seymour Howard, Architect, Instructor at Pratt Institute

## TWO-HINGED SEGMENTAL ARCH

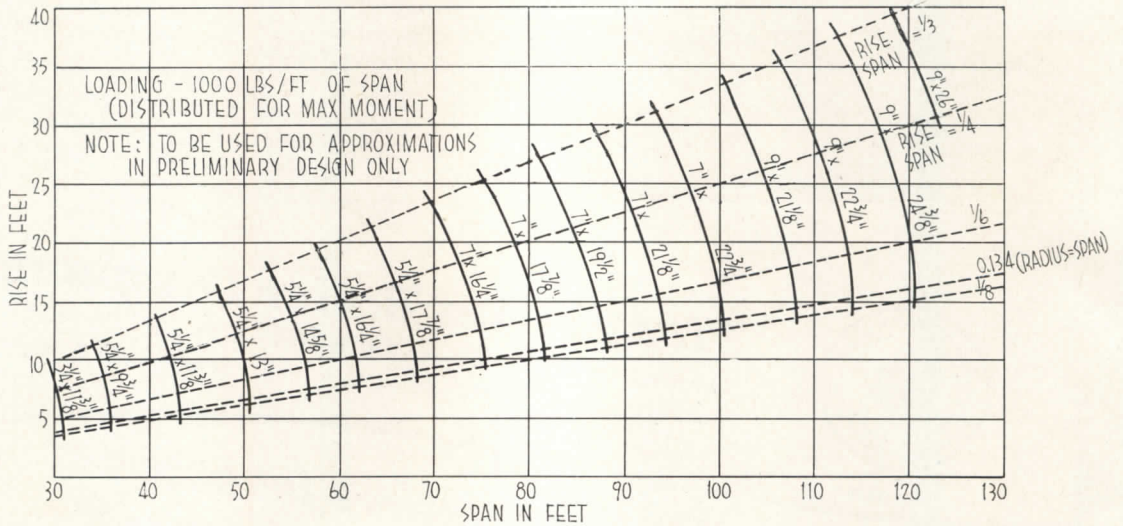


Three-hinged arch similar, with joint at crown



TYPICAL BENDING MOMENT CURVES FOR TWO-HINGED ARCH

Notes: Although the pressure line apparently passes through the centerline at the crown, it may be actually slightly below, indicating some negative moment at this point. For a three-hinged arch, of course, the pressure line for this and all loadings must pass through the centerline of the arch at the crown.



## TYPICAL SECTIONS—TWO-HINGED SEGMENTAL ARCHES

Based on  $f = 2600$  lbs/sq in.;  $c = 2000$  lbs/sq in.  
 For other loadings, multiply depth of section by coefficient from diagram  
 To vary width of section, multiply depth by coefficient from diagram  
 For preliminary approximations, use this diagram for three-hinged arches also

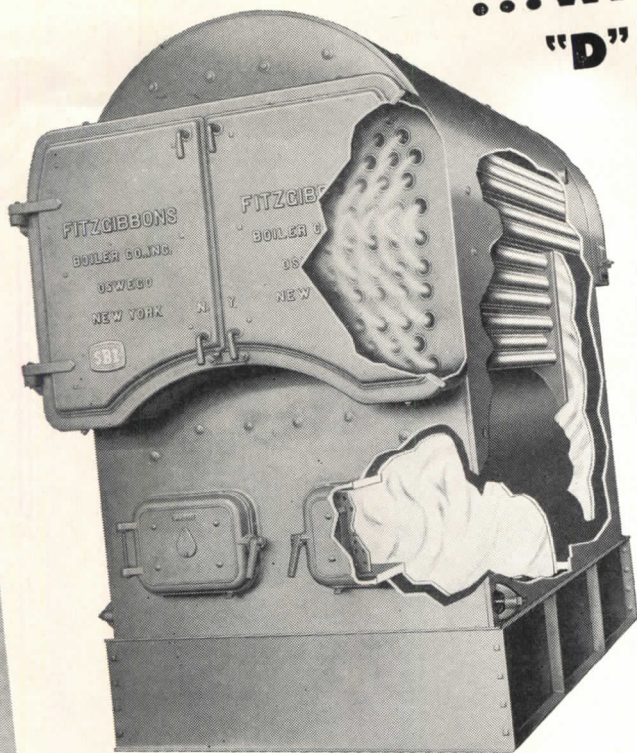
RADIUS =

$$\text{SPAN} \left[ \frac{1}{8} \times \frac{\text{SPAN}}{\text{RISE}} + \frac{1}{2} \times \frac{\text{RISE}}{\text{SPAN}} \right]$$

FOR RISE/SPAN	SPAN X Coeff Below = Radius	NOTES
1/8	1.0625	This ratio commonly used for stock arches
0.134	1.00	
1/7	0.946	This ratio commonly used for stock arches
1/6	0.833	
1/5	0.725	
1/4	0.625	
1/3	0.542	

# Big savings in big buildings

## ...WITH THE FITZGIBBONS "D" TYPE STEEL BOILER



**EXTRA LARGE COMBUSTION CHAMBER** for the efficient burning of any fuel — oil, gas, or coal, stoker or hand-fired.

**RAPID WATER CIRCULATION** induced by the concentration of heat at the high point of the fire-box crown sheet, brings *more water* in contact with *more heating surface* in a given time. The result is:

**QUICK HEAT TRANSFER**, with no time lag to cause waste of fuel. Here is a saving that adds up. The bigger the building the bigger the saving.

FITZGIBBONS CONSTRUCTION THROUGHOUT meaning certified flange quality steel, rigid adherence to the ASME. code in all construction details, hydrostatic test before shipment, and rating as per the Steel Boiler Institute Rating Code. There are no stronger guarantees of boiler quality.

This is the quality boiler that is supplying heat in thousands of commercial and public buildings. Eighteen sizes, from 528,000 Btu to 10,200,000 Btu. For details and specifications write for the "D" Type Bulletin.



**Fitzgibbons Boiler Company, Inc.**  
General Offices: 101 PARK AVENUE, NEW YORK 17, N. Y.  
Manufactured at OSWEGO, N. Y. • Branches in Principal Cities

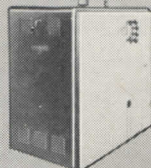


*A steel boiler is a lifetime investment  
—sell "the best in steel boiler heat"—*

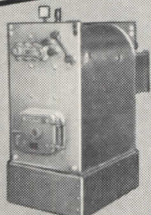
# THE FITZGIBBONS BOILER®



"200" SERIES



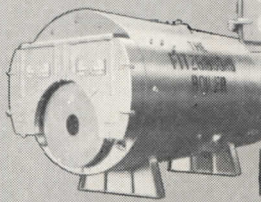
"400" SERIES



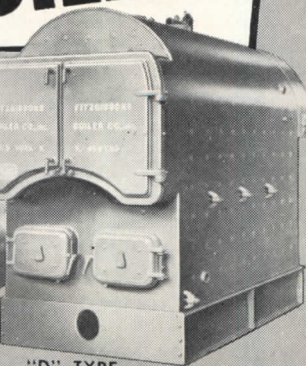
"80" SERIES



"RZU" JUNIOR



"SCOTCH MARINE"



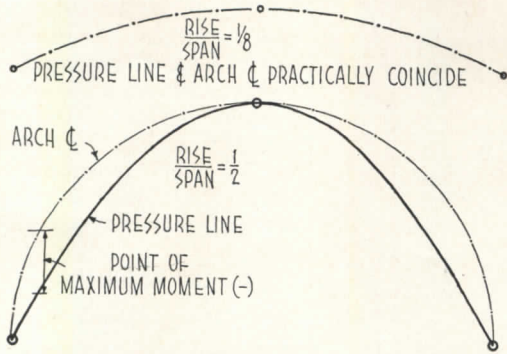
"D" TYPE

# STRUCTURAL FORMS-11: Long Spans in Wood

By Seymour Howard, Architect, Instructor at Pratt Institute

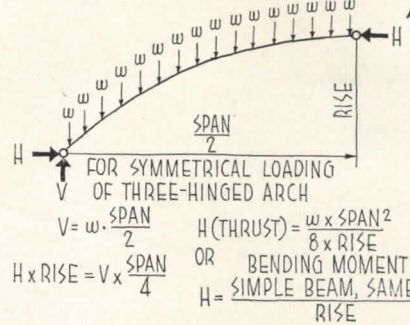
## TYPICAL BENDING MOMENT CURVES FOR UNIFORM LOADING, THREE-HINGED ARCHES

(For half span loading, see sketch on sheet 10 of two-hinged arch)



Note that as  $\frac{\text{rise}}{\text{span}}$  ratio increases, the shape of the arch becomes more important. In designing for high  $\frac{\text{rise}}{\text{span}}$  ratios more care should be given to make arch centerline correspond to actual pressure lines. Glued laminated wood can be used easily for any shape of arch. (Constant sections are usually cheaper than variable sections)

NOTE: JOINT AT CROWN MUST TRANSMIT THIS THRUST



FOR SYMMETRICAL LOADING OF THREE-HINGED ARCH

$$V = w \cdot \frac{\text{SPAN}}{2}$$

$$H \times \text{RISE} = V \times \frac{\text{SPAN}}{4}$$

$$H (\text{THRUST}) = \frac{w \times \text{SPAN}^2}{8 \times \text{RISE}}$$

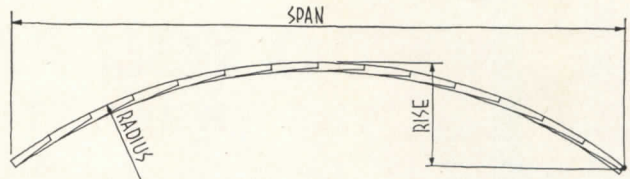
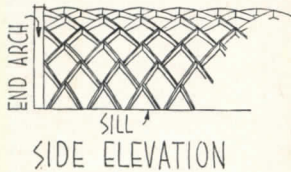
OR BENDING MOMENT FOR SIMPLE BEAM, SAME SPAN

$$H = \frac{\text{BENDING MOMENT}}{\text{RISE}}$$

### THRUST OF THREE-HINGED ARCH

This method can also be used safely for calculating the approximate thrusts of two-hinged arches, which are slightly less

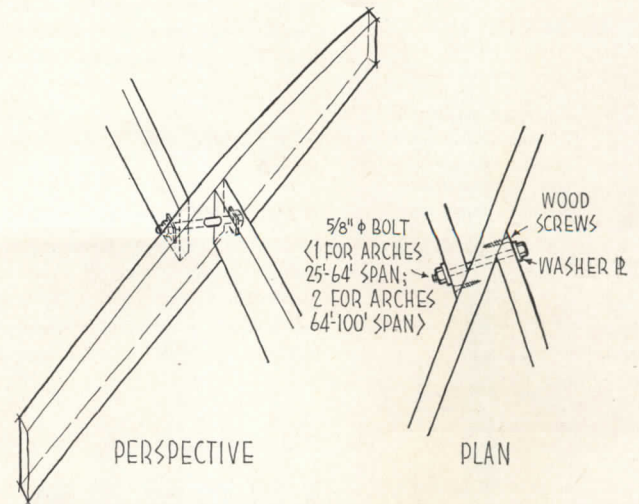
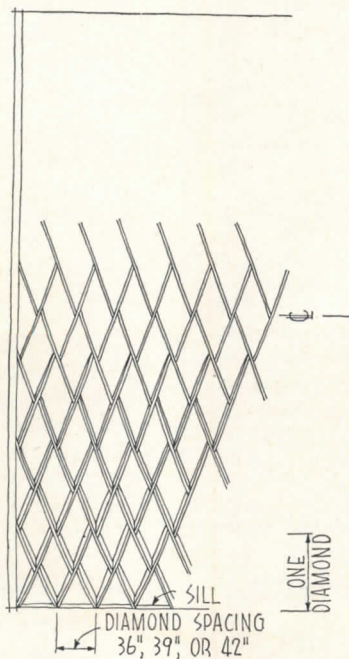
## STANDARD LAMELLA ROOF CONSTRUCTION DATA



### SECTION

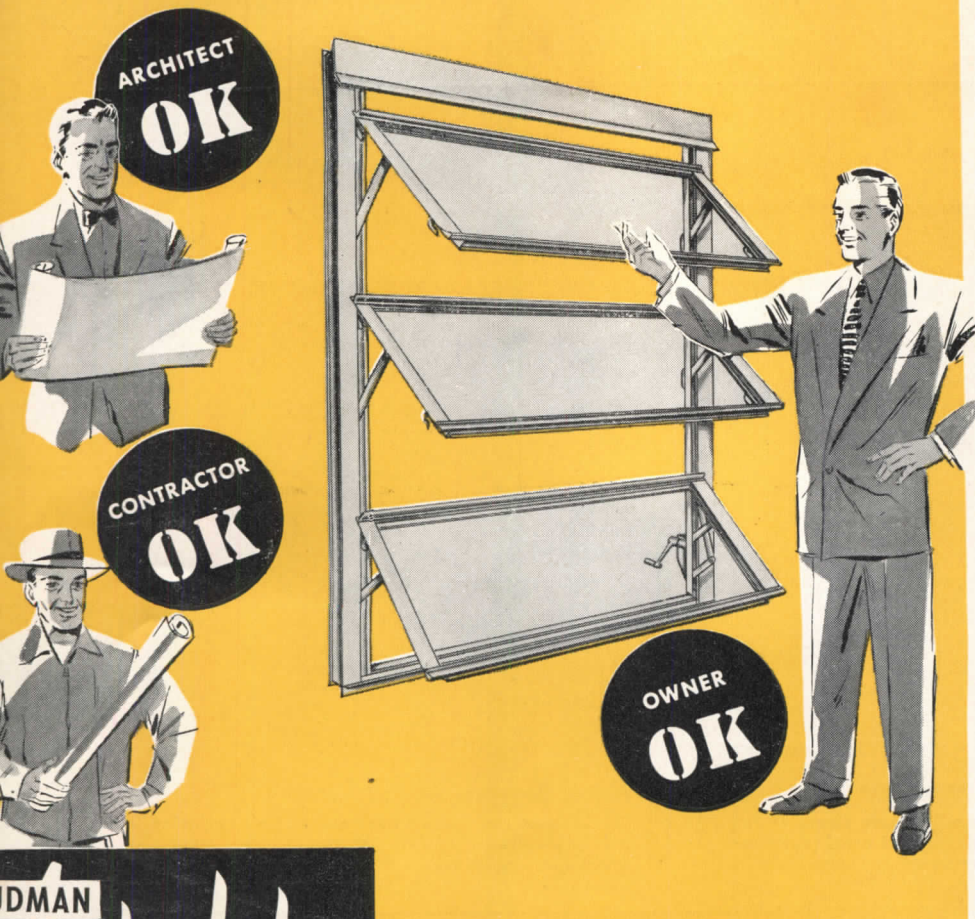
Note that this is essentially a two-hinged arch; thrust must be taken by buttresses or tie rods

Edge support at ends of arch is essential: this may be an end arch, designed to take sidewise thrust (as shown), an end arch with rafters, or a broached lamella arch (with axis at right angles and diagonal ribs at intersection). Tie rods may be used parallel to center line with lighter end arches



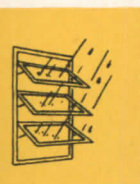
### JOINT DETAIL

Note shape of lamella. Curvature is obtained by cutting upper edge only. Bolt size is minimum. Nails can replace wood screws



**LUDMAN**  
**Auto-Lok**  
INC. LOCKING  
 ALUMINUM  
 WINDOWS

**THE FIRST WINDOW TO MAKE**  
*Weather*  
**TO ORDER**

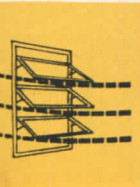


**FRESH AIR WHILE IT'S RAINING**... no more running to close windows. Rain can't enter through slanting sash!

**WARMER IN WINTER** because it seals itself like a refrigerator... keeps heat in, cold out!



**COOLER IN SUMMER**... because it opens widest... scoops air in and up... luxurious ventilation, but no drafts!



*Tightest closing window ever made!*



## Performance Factors

of aluminum awning-type windows

Every day, more and more architects and contractors are turning toward aluminum awning-type windows. These newer, more modern windows are being specified for all types of construction, including factories, commercial buildings, apartments, hotels, schools, hospitals and homes. Over a period of years, the aluminum awning-type window has been subjected to rigid and exhaustive tests to determine its performance characteristics and operating efficiency under every known weather condition. This research has been carried on by the leading manufacturers in cooperation with leading architects.

### THE "OPEN" WINDOW

One important advantage in favor of the aluminum awning-type window is that it can remain "open" to provide ventilation and fresh air circulation even when it is raining. Slanting sash is the answer. One aluminum awning-type window, the Ludman Auto-Lok, goes a step farther in this respect. The bottom sash of the Auto-Lok window is designed to remain slightly open, while the upper sash are closed tight and automatically locked. This feature allows for night ventilation and limited ventilation during inclement weather.

### BETTER VENTILATION... easier to clean

Because of their outward projection, the vents in aluminum awning windows provide maximum possibility of attaining 100% ventilation. While not all awning windows can be opened to nearly 90 degrees (almost straight out) the degree of their opening can be predetermined by checking the manufacturer's specifications. In their wide-open position awning type windows can be cleaned from the inside. This very important maintenance factor cannot be underestimated. However, the basic design of the window must be checked. For, on certain of these types, where vents are pivoted on a fixed point, the top vent cannot be cleaned from the inside. The Ludman Auto-Lok window can be cleaned *completely*... all from the inside, top sash, too. This feature is accomplished by Ludman's uniquely designed operating hardware, in which the hinge points of the top sash float down with the mechanism when the window is opened to provide a convenient 6" opening between the top sash and the window frame.

### AIR INFILTRATION

Paradoxically, the use of aluminum awning windows has for many years been retarded because of their generally unsatisfactory performance on the score of tight closure and elimination of air infiltration. Yet, today, the tightest closing

## DO YOU KNOW THE THREE STEPS TO *Successful installation?*

The window the Architect specifies...for his reasons...must work out to advantage for the Contractor...in terms of *trouble-free, economical installation*. Finally, from the Owner's standpoint, the successful window is the window that proves *most practical*...not only in the planning and construction stages, but through a lifetime of *maintenance-free service and attractiveness!*

### PERFORMANCE COUNTS *first*

AUTO-LOK is the first and only window made that *successfully* meets all window requirements...in use as well as in every step of architectural planning and construction work. No other window so *completely* meets the "three-way" performance requisites that result in successful window installations.

IT WILL PAY YOU TO WRITE FOR THE "HOW" AND "WHY"!

**LUDMAN Corporation**

BOX 4541, DEPT. AR10, MIAMI, FLORIDA