

New Ozalid Streamliners Now Available For Immediate Delivery

Now, you can order—and promptly receive—a new, moderately priced print-making unit that gives you these 5 new advantages at no extra cost:

- 1. SPEED.** In 25 seconds an Ozalid Streamliner reproduces your engineering drawings . . . or anything typed, drawn, printed or photographed on *translucent* paper.
- 2. EFFICIENCY.** You always get an exact-size positive (not negative) copy direct from your original . . . produced in 2 quick steps—Exposure and Dry Development.
- 3. ECONOMY.** An 8½" x 11" print costs you less than one



and a half cents per copy.

- 4. VERSATILITY.** The lines and images on your original can be reproduced in black, blue, red, sepia, yellow . . . on paper, cloth, foil, film, or plastic.
- 5. SIMPLICITY.** Anyone can be the operator. Place your original on Ozalid paper and feed into the Streamliner; that's 95% of the job.

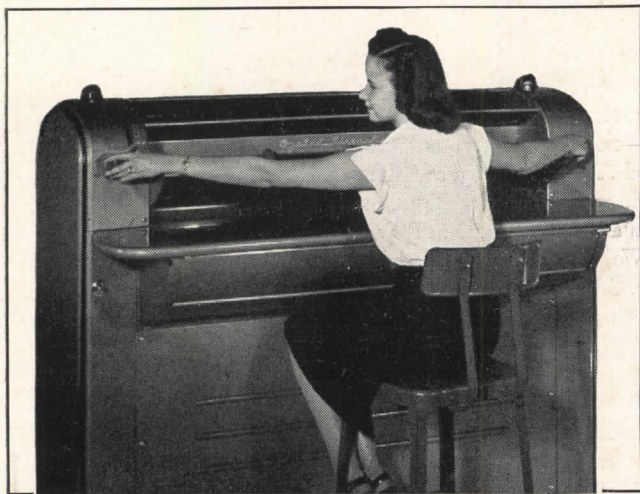

Now an easy desk job. You remain seated, relaxed. All controls within easy reach. Prints are delivered on top, completely dry. Another advantage: You can install your Streamliner in any drafting room or office. Only 6 square feet of floor space is required.

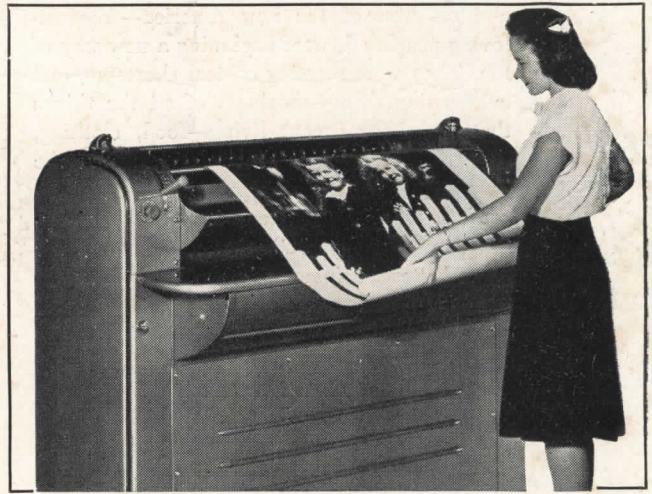

A minute ago—engineering drawings. Now she's producing beautiful Ozalid Dryphotos in seconds, in exactly the same manner. Note the size: Ozalid prints can be up to 42" wide, any length. You can reproduce advertising posters, accounting reports—the work of all departments.

Expanded Production Facilities Now Permit Immediate Delivery

Thousands of Streamliners already installed. The following list is a typical cross-section of users:

Armstrong Cork Company
Bethlehem Steel Corp.
Bloomingdale Brothers
Bulova Watch Company
Chris Craft Corporation
Chrysler Corp.
Columbia Broadcasting System
Dun & Bradstreet
E. I. DuPont
General Electric Co.
General Motors Corp.
International Harvester Co.
Lever Brothers

Montgomery Ward Co.
New York Central Railroad
Northern Pacific Railway Co.
Pan American Airways, Inc.
Paramount Pictures, Inc.
Parke, Davis & Co.
Pittsburgh Plate Glass Co.
Remington Rand
Scovill Manufacturing Co.
E. R. Squibb & Son
Standard Oil Co.
Swift & Co.
Westinghouse Electric Co.



MAIL COUPON TODAY FOR FREE BOOKLET

DEPT. NO. 7

OZALID Division of General Aniline & Film Corporation, Johnson City, New York

Gentlemen: Please send free, 24-page, illustrated booklet . . . showing all of Streamliner's uses and 10 types of Ozalid prints.

Name _____
Position _____
Company _____
Address _____

Ozalid in Canada—Hughes Owens Co., Ltd., Montreal

101 DISPLACED PERSONS

IN A STRANGE NEW LAND they stood—these displaced persons. Silent men with grim tasks ahead worked purposefully and with little thought of the fatigue that racked their weary bodies. They were building a new community—their community.

Women, hollow-eyed, their white drawn faces mirroring pain, went about setting their humble homes in order. On every side was hunger, privation—the plight of desperate people—“A picture of Europe, 1948?” . . . you ask.

No—a picture of America, 1620.

For here, 101 displaced Pilgrims—men, women and children of the new America—freedom-loving people all, were beginning a new way of life. They were meeting critical shortages, and overcoming them—shortages of all the things that make for decent living—food, clothing, shelter . . . shortages that relatively were the greatest our nation has *ever known*.

There was a 100% shortage of almost everything on that day, 328 years ago, when their storm-battered ship nosed into the quieter waters of rock-studded coastal bays. Yes, a shortage of everything except **COURAGE**—a belief in the dignity of man—a passionate desire on the part of each to live as he liked.

Perhaps it was the strong driving force of the urge to be free men that enabled them to solve the critical shortages of their day. For you see, no one could pass a law providing new homes or schools . . . nor were there any homes here ready for them to occupy.

So, with bare hands and primitive tools, they individually dug from the earth and cut from the forests their own homes and schools. Ceaselessly and endlessly they worked at their simple tasks, struggling for necessities . . . looking ahead, not behind . . . building a heritage for millions of Americans to come.

Are we less courageous than they?
Is war-scarred Europe more
destitute than they were?
Is there less hope in our time than theirs?
Are our shortages more acute than 100%?

There is a simple answer to those questions and to the problem they pose. It is a **WORD**. A short word, without glamour, but a virile word of dynamic force . . . a word, that in its simplicity, might be overlooked, but a word so powerful as to be virtually magic.

It isn't a new word to Ceco thinking, for in January 1947 we said this word was the key to better times—to security for all.

May we say it again?

It is **W-O-R-K**—a four-letter word for continuing prosperity, for preserving freedom in America and for providing hope throughout the world. As we said before, *everyone* must work more . . . produce more—*management* and *labor*.

Suppose we look at the simple mathematics of the problem. There just aren't enough homes, schools, hospitals, roads, to satisfy the needs of all—not enough steel, automobiles, freight cars, food . . . for America and the rest of the world. How can more of these scarce things be made available sooner, and at **LOWER PRICES**?

We, like you, have heard many so-called cure-alls. Some say too many have too much money . . . they bid against each other for scarce things and thus keep prices ever moving upward, so taxes must be raised, not lowered—must be kept high to draw off excess money. Credit must be curtailed so buying will be slowed down. Or prices must be regulated and goods rationed.

Others say don't buy unless your needs are desperate, quit eating certain foods certain days, don't build now . . . don't . . . don't . . . don't . . . verboten. It all has a familiar ring somehow. It's a creed of hopelessness—of negation.

Let's hear a new voice in America, raised high in a mighty crescendo, drowning out those voices of fear. Yes, a new voice of hope, which will say in clear unmistakable tones of triumph . . .

“Let's **DO** something . . . yes, let's trade **DO** for **DON'T**.”

We of Ceco believe the American way to solve the problem of shortages and high prices is one of action . . . one of *doing* . . . of *making more things*, not buying less of what we have, of increasing prosperity . . . not dividing misery. And prosperity comes from *making a lot* for all . . . not *dividing a little* with all.

vs. 60,000,000 EMPLOYED..

Look at it this way. There are some 60,000,000 adults—men and women—employed in the nation today, making things for the more than 140,000,000 Americans and the many, many millions in all the other countries of the world. Now we can't increase our 60,000,000 employed to any great degree very fast. They just about represent today's manpower capacity—but, if everyone of those 60,000,000 . . . executives . . . managers . . . labor . . . white collar people, *ALL* of America's working force, produced more *individually*, things would become more plentiful and prices would be reduced.

It's basically that simple.

Yes . . . we 60,000,000 Americans must work more, produce more, instead of less, and that goes for EUROPE and EVERY OTHER PART of the world. Everywhere we must increase man-hour output . . . bricklayers must lay *more* bricks, architects create *more* buildings, miners dig *more* coal, farmers raise *more* produce, stenographers write *more* letters, managers do *more* managing . . . and this must go clear back through the entire economy from raw materials to manufactured products.

Then, and only then, will scarce things be plentiful . . . will money stop bidding up prices . . . will inflation be halted and a sound basis be established for the security of all, both *labor* and *capital*.

Given a freer rein this past year, the building industry made real progress in cutting down building shortages. For example, twice as many homes were completed in 1947, as compared to 1946 . . . plant expansion is getting closer to demand. Ceco salutes construction men for the job they are doing.

We like to feel that in some measure we have been helpful in this progress. Here are some of the things we have done to help the building industry in 1947.

Our production in 1947 nearly absorbed manufacturing capacity, which was doubled in 1946 • New fabricating plants were erected in Hillside, New Jersey and Houston, Texas • Personnel in plants, offices and sales force increased more than 50% • More than 100 improvements were effected in our products • More than one-third of our new products developed since the war were put in production.

But what about the future?

Today, as was true a year ago, the building industry faces an imposing demand for all types of construction. People want more homes, schools, roads, and will get them if an *unhampered* building industry is permitted to provide them . . . could get them at lower prices, too, if *ALL* would *WORK* to produce *MORE*, not less.

We of Ceco believe in America's future, in its ability to meet the challenge of world leadership—for after all, a way of life that has given Americans more of the good things of earth than any other people anywhere doesn't have to be *proven* . . . it is proven . . . *it is working*.

As for the building industry, Ceco has confidence *we can* count on our architects, engineers, contractors, builders and industry labor, to provide the structural needs of our nation. To this end the industry—America—can count on Ceco.

**CECO
STEEL**

PARTIAL LIST OF CECO PRODUCTS • METAL WINDOWS AND DOORS • METAL FRAME SCREENS • STEEL JOISTS AND ROOF DECK • METAL LATH AND ACCESSORIES • MEYER STEELFORMS • CONCRETE REINFORCING BARS • WELDED STEEL FABRIC • HIGHWAY PRODUCTS • CORRUGATED ROOFING • LOUVRE VENTILATORS

CECO STEEL PRODUCTS CORPORATION

GENERAL OFFICES: 5701 West 26th Street, Chicago 50, Illinois

Offices, warehouses and fabricating plants in principal cities



**JOHN HANCOCK
MUTUAL LIFE INSURANCE COMPANY BUILDING**

*Cram and Ferguson, Architects and Engineers
Turner Construction Company, Builders
John F. McCarron, Plumbing Engineer
M. Ahern Company, Plumbing Contractors
Buerkel and Company, Heating Engineers & Contractors*

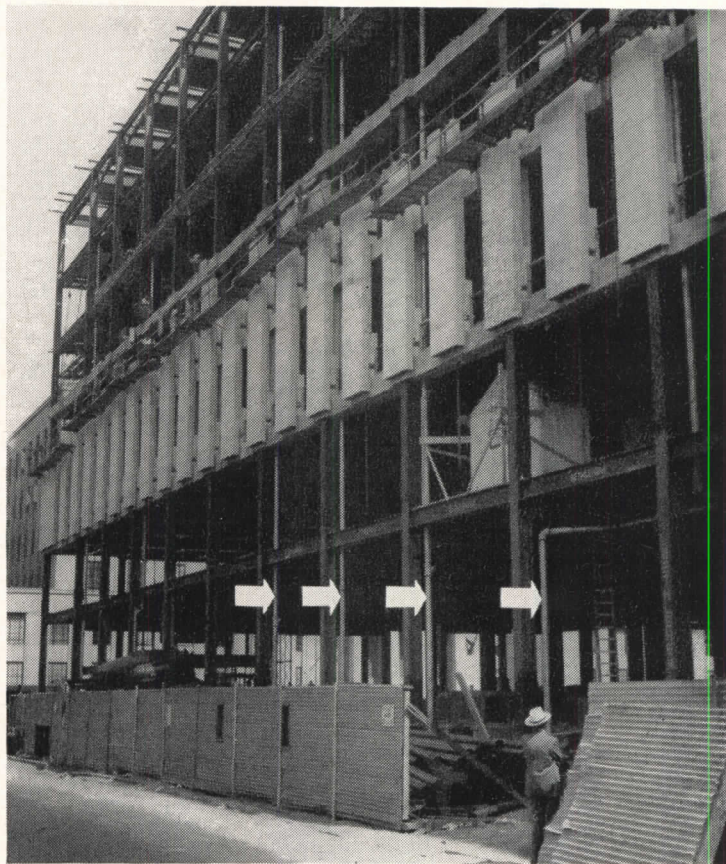

**8 Piping Services—
Radiant Heating—
Snow Melting—all
Byers Wrought
Iron Pipe**

Now rapidly nearing completion, the new home of the John Hancock Mutual Life Insurance Company incorporates a number of new ideas . . . and retains some proven old ones!

Radiant heating is installed in the main lobby, the theatre lobby, and the truck loading space. Snow melting systems are located in three sidewalks. In both cases, Byers Wrought Iron pipe is the coil material.

MAINTENANCE CONTROL

The plumbing and heating specifications for time-tried wrought iron reflect today's need for maximum durability in materials, in order that costly maintenance can be avoided. Drainage, waste, vent, down-spout, fire and soap lines in the plumbing system, and concealed supply lines and the entire return system in the heating installation, are all Byers Wrought Iron pipe. Some of these services

are indicated by arrows in the illustration.

HOME-GROUND EVIDENCE

Boston provides plenty of evidence of the superior durability of wrought iron. In one building, for instance, wrought iron steam return lines were still on the job after 60 years, and in another structure after 65 years. It is still serving in numerous buildings after 40 years and more.

WHY WROUGHT IRON LASTS

Wrought iron's endurance comes from the network of glass-like silicate slag fibers which are threaded through its high-purity iron body.

These fibers halt and "detour" corrosive attack. They also anchor the initial protective scale, which shields the underlying metal.

ASK FOR THIS BULLETIN

Our bulletin, "Wrought Iron for Piping Systems", will give you helpful data on applying wrought iron in building applications. Ask for a copy.

A. M. Byers Co., Pittsburgh, Pa. Established 1864. Boston, New York, Philadelphia, Washington, Atlanta, Chicago, St. Louis, Houston, Salt Lake City, Seattle, San Francisco. Export Division: New York, N.Y.

CORROSION COSTS YOU MORE THAN WROUGHT IRON

BYERS
GENUINE WROUGHT IRON
TUBULAR AND HOT ROLLED PRODUCTS
ELECTRIC FURNACE QUALITY ALLOY AND STAINLESS STEEL PRODUCTS

**ARCHITECTURAL
RECORD**

HOW MUCH FOR A SET OF HOUSE PLANS? 71
An Editorial . . . by Kenneth K. Stowell

BERNARD RALPH MAYBECK, ARCHITECT, COMES INTO HIS OWN 72
Notes from a Forthcoming Book by Jean Murray Bangs

A NEW SCHOOL CYCLE GRACEFULLY BEGUN 80
Laurel Elementary School, San Mateo, Calif. Franklin, Kump & Falk, Architect-Engineers

PROLOGUE TO PROGRESS 86
By Thomas S. Holden

BUILDING TYPES STUDY NO. 133 . . . HOSPITALS 92

TYPE PLANS FOR THE GENERAL HOSPITAL 93
Division of Hospital Facilities, U. S. Public Health Service

THE PRESENT OPPORTUNITY 94
By Thomas Parran, M.D.

THE ARCHITECT'S RESPONSIBILITY 94
By Henry H. Saylor, for Douglas William Orr, President, A.I.A.

THE HOSPITAL'S PLACE IN THE PROGRAM 95
By George Bugbee

8 BEDS—COMMUNITY CLINIC WITH NURSING UNIT 96

10 BEDS—IN COMMUNITY CLINIC 97

30 BEDS—HOSPITAL AND HEALTH CENTER 98

40 BEDS—GENERAL HOSPITAL 100

75 BEDS—GENERAL HOSPITAL 102

100 BEDS—GENERAL HOSPITAL 104

150 BEDS—GENERAL HOSPITAL FOR URBAN DISTRICTS 107

NURSING SCHOOL 112

THE COORDINATED HOSPITAL SYSTEM 114

ARCHITECTURAL ENGINEERING . . Technical News and Research . . . 115

POURED RESILIENT FLOORING FOR HOUSES 115

PRODUCTS . . . for Better Building 117

MANUFACTURERS' LITERATURE 119

TIME-SAVER STANDARDS 120
Insulation of Concrete Floors in Dwellings. Suggestions Based on Research by Housing and Home Finance Agency

THE RECORD REPORTS . . . News from the Field 7

CONSTRUCTION COST INDEXES 26

REQUIRED READING 28

EMPLOYMENT OPPORTUNITIES 172

INDEX TO ADVERTISEMENTS 190



Copyright 1948 with all rights reserved F. W. DODGE CORPORATION • Publishing Director, Magazine Division, H. Judd Payne • EDITORS: Editor-in-Chief, Kenneth Kingsley Stowell, A.I.A.; Managing Editor, Emerson Goble; Senior Associate Editor, Douglas Haskell; Associate Editors, John W. Ragsdale, Florence A. van Wyck, James S. Graham, Jr.; Western Editor Elisabeth Kendall Thompson; Associate in South America, Edmund J. Whiting, A.I.A. • ART DEPARTMENT: Myron S. Hall 3rd, Director; Frances Torbert, Assistant; Peter Piening, Consultant; Sigman-Ward, Drafting • CONSULTANTS: Industry Relations Consultant, Thomas S. Holden; Statistical Consultant, Clyde Shute; Building Economics Consultant, Norbert Brown; Field Research Consultant, Clifford Dannels, Jr.

Architectural Record (combined with American Architect and Architecture) is published monthly by F. W. Dodge Corporation, 10 Ferry St., Concord, N. H., with Editorial and Executive Offices at 119 West 40th St., New York 18, N. Y. Western Editorial Office, 2813 Channing Way, Berkeley, Calif. Thomas S. Holden, Pres.; Howard J. Barringer, Vice-Pres. and Treas.; Irving W. Hadsell, Vice-Pres.; Chauncey L. Williams, Vice-Pres.; Sanford D. Stockton, Jr., Secy.; Walter F. De Saix, Asst. Treas.; Edwin H. Freed, Asst. Treas. Member Audit Bureau of Circulation and Associated Business Papers, Inc. Architectural Record is indexed in Reader's Guide, Art Index and Industrial Arts Index. Subscription rates: United States and Possessions, Canada, Cuba, Mexico, Central and South America, and Spain, \$4.50 the year, \$7.50 for two years, \$9 for three years; elsewhere, \$6.50 the year, \$11.50 for two years, \$15 for three years. Single copy, \$1. Circulation Manager: Marshall T. Ginn. Every effort will be made to return material submitted for possible publication (if accompanied by stamped, addressed envelope), but the editors and the corporation will not be responsible for loss or damage. Other Dodge Services: Real Estate Record & Builders' Guide, Sweet's Files, Home Owners' Catalogs, Dodge Reports & Dodge Statistical Research Service

NEW development for hospitals

... Watrous Flush Valves with Integral Drip Receptor

In hospitals, the use of special fittings to clean bed pans presents the problem of drippings every time the fitting is used.

Here is a simple common-sense answer now offered by Watrous. It consists of a drip receptor mounted as an integral part of the flush valve. The cleaning nozzle is simply placed in this holder after use, and any accumulated drippings flow through a check valve into the flush connection and down into the bowl.

The use of this new Watrous combination eliminates the expense of specially constructed bowls or tanks, and keeps the fittings and hose up out of the way. It is thoroughly protected against any spilling and back-siphonage, and can be arranged for any height above the bowl.

The flush valve itself, of course, offers all those basic Watrous superiorities—self-cleansing by-pass, water-saver adjustment, self-tightening handle packing, single-step-servicing, and, at slight additional cost, screenless silent-action.

Keep this in mind for whatever flush valve needs you may have — Watrous means maximum convenience and economy.

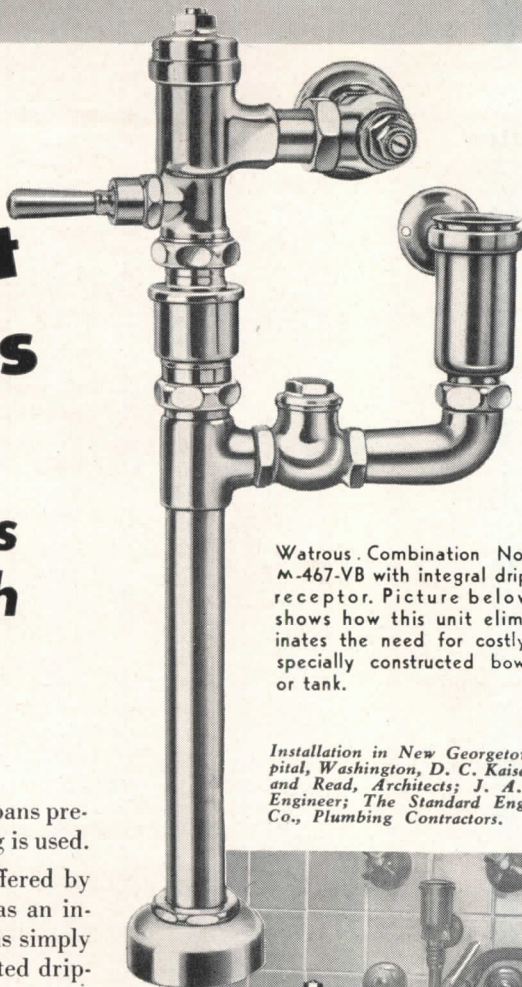

Watrous Combination No. M-467-VB with integral drip receptor. Picture below shows how this unit eliminates the need for costly, specially constructed bowl or tank.

Installation in New Georgetown Hospital, Washington, D. C. Kaiser, Neal, and Read, Architects; J. A. Murry, Engineer; The Standard Engineering Co., Plumbing Contractors.

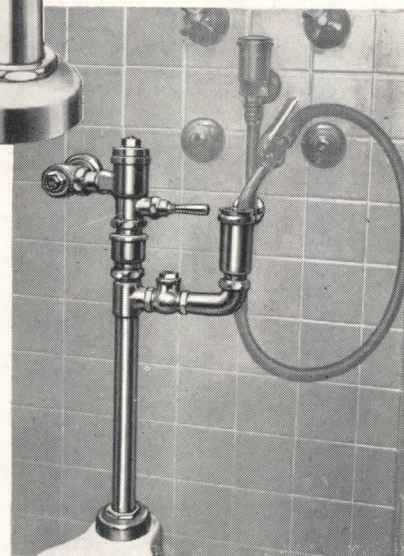

THE IMPERIAL BRASS MANUFACTURING COMPANY

1240 W. Harrison St., Chicago 7, Ill.

For complete information on Watrous Flush Valves see Sweets' Catalog or write for Catalog No. 448-A. Also ask for Bulletin No. 447 giving a summary of "Architects' Views on Flush Valve Applications."



... Survey shows
7 out of **8**
Architects Prefer
Adjustable
Flush Valves

Watrous

Adjustable Flush Valves

BOTH DIAPHRAGM AND PISTON TYPES

THE RECORD REPORTS

Housing Problems Claim Congressional Attention Funds Sought for New Building Industry Advisory Board • Materials Outlook for 1948 Encouraging

The current session of Congress plans a thorough airing of public housing policy. Chairman Jesse P. Wolcott, of the House Banking and Currency Committee, under whose jurisdiction housing legislation comes, wants to determine first of all whether slum clearance and public housing generally are primary responsibilities of the federal government or of the states.

Once the basic policy is established, he says, writing of legislation will be routine. If the obligation is federal, Congress has only to determine how much money to appropriate each year; if the obligation falls on the states, it needs simply to fix the amounts of grants-in-aid by the federal government and the standards for expenditure.

To use Chairman Wolcott's own words: "We will not make the mistake that has been made in years gone by in discussing this problem. We will not set up the machinery and then build a policy around it. We will establish the policy once and for all and then provide for the machinery by which to carry out that policy. This policy will be formulated and this bill written in the House Banking and Currency Committee after full and complete hearings."

Other housing issues also will be tackled during the current session. Among these is the extension of rent control, authority for which expires March 1. President Truman's request for strengthening the controls, as well as extending them, gives rise to possible modification of the present enactment, but whether or not this is done legislative leaders anticipate that extension for a definite period will get a Congressional O.K.

More Title VI Funds Sought

Because of accelerated use, Title VI mortgage insurance funds ran out in November and the Special Session of Congress was called on to move swiftly to provide an additional \$1,000,000,000, raising the total to \$5,200,000,000. However, it sought to qualify the basing of insurance upon estimates rather than actual cost since, in some instances, the insurance has represented more than 90 per cent of actual costs. Under the language used by the Senate Banking and Currency Committee, for instance, the Federal Housing Commissioner was instructed to "use every feasible means to assure that such estimates will ap-

proximate as closely as possible the actual costs of efficient building operations."

Congress found that about 30 per cent of new permanent private housing is being financed under Title VI insurance and that from January, 1947, through mid-November applications covered 150,700 units of rental housing to a total of more than \$1 billion.

Pointedly, the lawmakers, in view of the President's price control program, discussed the inflationary aspects of this credit but felt that to avoid an "unanticipated, abrupt termination of operations" with consequent dislocation to home building, a decision on this aspect should come later.

Joint Committee Findings Studied

On the housing schedule at the Capitol of course, also are the findings of the Joint Committee on Housing authorized last summer.

Chairman Gamble in a progress report to Committee members in December

touched on a wide range of topics as a result of field hearings. Citing the estimated 860,000 "starts" in 1947, he said this figure probably would have to be increased 50 per cent or more for a minimum of four or five years, particularly in the multiple-unit rental field. He stressed the need for increase in on-site labor productivity and pointed to cooperative efforts by labor groups to achieve this.

On prices and shortages of materials, Representative Gamble pointed out that in the case of soil pipe, the national export policy is involved. Continued pig iron exports cut down the supply available for pipe. As to nails, he said, the hearings revealed widespread black markets, drainage through exports, and confusion in War Assets Administration policies. Both nails and gypsum products production is expected to be upped further in 1948. Meanwhile Senator Flanders called a meeting of nail manufacturers to consider means for "getting nails into proper channels of distribution." As to heating, piping and plumbing fixture prices and supplies, Mr. Gamble suggested a thorough investigation.

Among his comments on lumber: "It may be necessary to examine our entire lumber export checking machinery. It may be desirable — in the public interest — to look further into the profits of lumber manufacturers and also to establish to the Committee's satisfaction that a retailer's service is necessary to mass

(Continued on page 10)

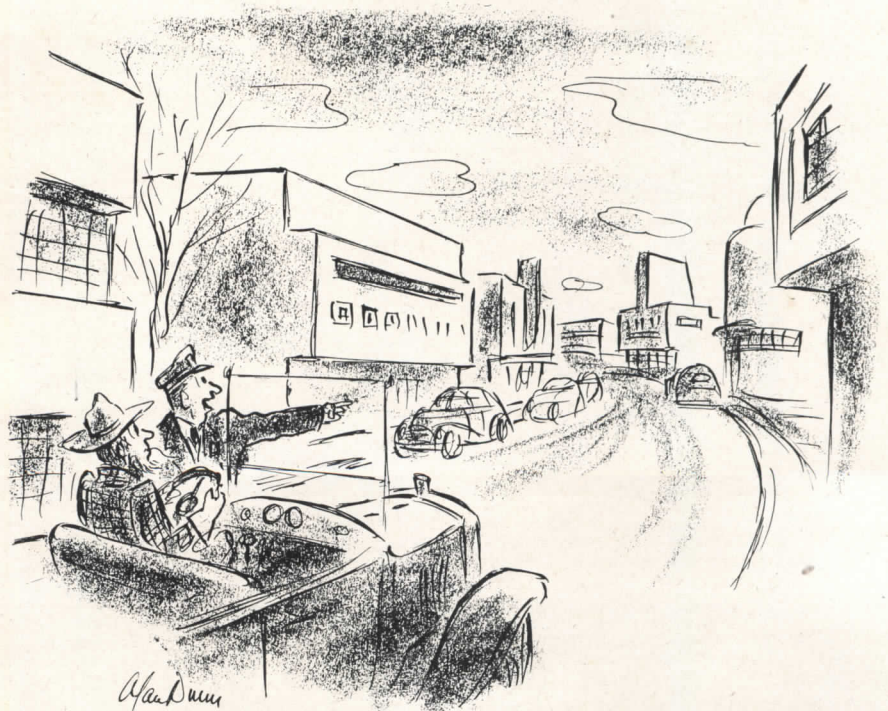

"No, no — there's the hospital; this is the school, that's the theater — then comes the shopping center — next to it the church — then comes the bus terminal —"

— Drawn for the RECORD by Alan Dunn



MONARCH PANIC EXIT DEVICES

**IMMEDIATE
DELIVERY!**

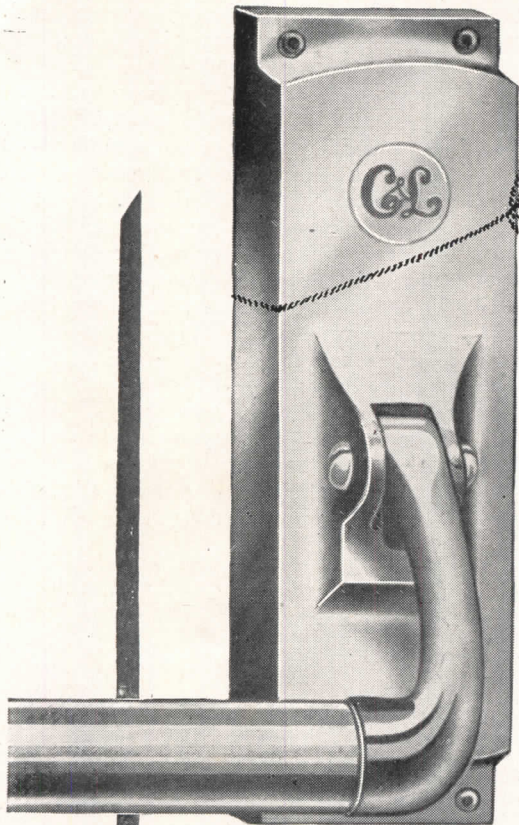

C & L-Monarch panic devices are now available in brass and cast iron.

Cast iron devices, while painted black, have working parts and outside trim of brass. They are immediately available to dimension, or shipped knocked down for stocking.

Brass devices — standard sizes, shipped at once. Special sizes require make up time.

The C&L-Monarch panic exit device operates with only a slight pressure, yet gives complete security from the outside. Available in mortise, rim and vertical rod types. Matched design allows uniform building installations.

Send for illustrated circular and ordering information.

CLAYTON & LAMBERT MFG. CO.
LOUISVILLE 10, KENTUCKY



Create confidence with the *recognized quality* of
KOHLER BATHROOM FIXTURES

CUSTOMERS are easy to satisfy and to sell when you show them they are getting genuine Kohler quality, and explain the sanitary protection and long serviceability that first quality fixtures mean.

The bathroom above shows a convenient, practical way to arrange Kohler fixtures, with pleasing effect and ample, though compact, storage space.

The Gramercy vitreous china lavatory, with its roomy shelf has a glass-hard, lustrous, easy-to-clean surface.

The Cosmopolitan Bench Bath is of non-flexing cast iron, time-tested base for the heavy coat of lustrous pure white Kohler enamel. It is equipped with the efficient Triton Shower Mixer. The quiet, smooth-working Wellworth closet completes the matched set. All fittings are of durable chromium plated brass, built to the Kohler high standards of quality, which is now a 75-year-old tradition.

Kohler Co., Dept. 12-B, Kohler, Wisconsin.

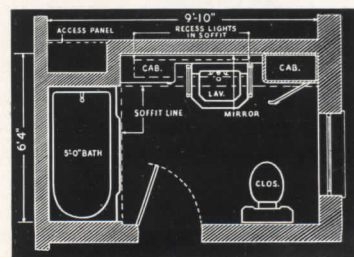

The Kohler fixtures in this floor plan are conveniently arranged, yet the compact space allows for a large mirror over the lavatory, and two attractively designed cabinets for storage of linens and bathroom supplies.

KOHLER OF KOHLER

PLUMBING FIXTURES • HEATING EQUIPMENT • ELECTRIC PLANTS

construction of housing, particularly where some manufacturers own or control their retail outlets. We are personally convinced that the price of lumber can be reduced."

On building codes: "Local building codes, municipal ordinances, and certain state laws, unquestionably constitute the 'impersonal culprits' in the housing shortage. Our investigations reveal that these archaic statutes or regulations, which should be everybody's business, too often have been only the 'business' of some materials manufacturers, and some local labor unions. It should be said to the great credit of some of the unions that they are moving far more quickly than some of the manufacturers to remove from themselves the possible stigma of obstruction. The Committee has made a fair start by encouraging the immediate substitution of performance codes for specification codes."

Representative Gamble noted the long-time "deadly effect" of competition by cheap federal loans, insured loans and federal grants on private capital and individual enterprise in the construction industry. He advised of abuses of public housing in some cities and cited "boisterous" Communist advocacy of public housing. He emphasized the need for

inducing private capital into housing and mentioned among possible inducements: accelerated rate of depreciation, abatement of corporate income taxes up to 2 or 3 per cent, yield insurance above tax abatement figures, and provision of land and utilities by municipalities.

Anti-Inflation vs. Housing?

Besides rent control, the Administration's anti-inflation program, officials are finding, ramifies broadly into the field of construction. Presumably, as little hobble as possible will be placed on housing. Nevertheless, some dislocation may be forced by allocation of transportation facilities, by allocation and inventory control of scarce commodities, and by possible price ceilings on scarce products.

There is no official concern, apparently, that the moves to curb inflation will pare down residential construction during 1948. The Commerce Department's Construction Division in estimates which followed the President's message to the Special Session, anticipates a 20 per cent gain in dollar volume of new construction over 1947 with private residential building up 25 per cent. Increases in commercial building, CD calculates, will be largely offset by an

industrial construction drop; public utility outlays are expected to rise. HHFA Chief Foley sees possibility of a new national record for housing this year.

On the other hand, F. W. Dodge Corp. estimates indicate quite moderate increases in 1948 construction volume. In discussing this before the Construction Industry Advisory Council at the U.S. Chamber of Commerce recently, Thomas S. Holden, president, pointed to the carry-over of unfinished projects and the consequent demand on numerous key materials and equipment items. The upward spurt in housing starts beginning last July brought shortages in some materials, and the lack of freight cars adds to the shortages in local markets, he advised. "It seems probable," Mr. Holden told the Council, "that the current upward movement in contract letting and housing starts will be checked sometime in 1948."

John L. Haynes, of the Commerce Department, it should be pointed out, makes clear that the Department's figures assume no serious economic recession and only a moderate rise in construction costs. If costs get out of hand, he adds, they could contribute to a sharp drop in volume of housing and other construction. A recession, he feels, would particularly affect private residential building.

(Continued on page 14)

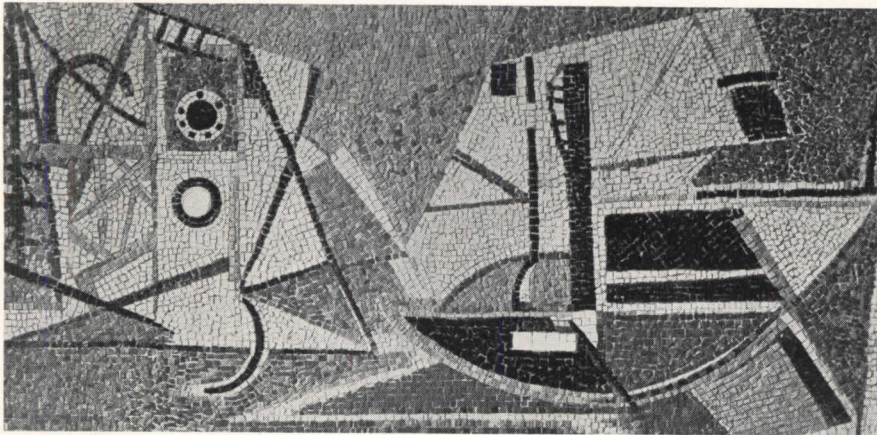

Brilliantly-hued mosaic panel by 16-year-old Renato Gregorini is one of approximately 150 examples of modern Italian art shown at the House of Italian Handicrafts, New York

EXHIBITS OF INTEREST

Late November and early December brought to New York and vicinity three exhibitions of unusual interest. Foremost among them was the showing of rare French tapestries on view at the Metropolitan Museum of Art through February. About half of the 200 pieces brought from France for the exhibition represent work done during the 14th to 16th Centuries, including 24 of the famous Apocalypse series owned by the Museum of Tapestries at Angers. Also

shown are examples of work from the looms of Gobelins and Beauvais of the 17th and 18th Centuries, and designs by present-day artists such as Matisse, Saint-Saens and others.

Forty of Italy's most prominent sculptors, painters, architects and designers are represented in the "Living Crafts by Forty Italian Artists" exhibition at the House of Italian Handicrafts, New York City. Comprising about 150 pieces in ceramics, glass, stained glass, mosaics, bronze, silver, wood and other media, the exhibition includes the work of two

architects: a large ebony mirror with brass inlay and a marble table by Fabrizio Clerici; and two straw bot-tomed chairs by Giovanni Michelucci.

Third of the group of new exhibitions is "Painting Towards Architecture," a collection of painting and sculpture assembled by the Miller Company of Meriden, Conn., to illustrate "the kind of abstract art which already has had a

(Continued on page 12)



Another exhibit at the House of Italian Handicrafts: highly glazed turquoise blue ceramic altar piece by Mirko Basadella

Miller troffer lighting
gives you good light
plus ceilings unlimited

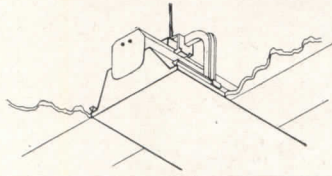

The Miller Ceiling Furring Hanger (patented) simplifies installation. Miller continuous wireway cuts wiring and fitting costs. All units are **Bonderized** for corrosion resistance.

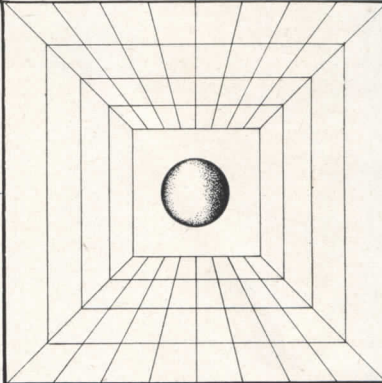

Miller Fluorescent Troffer Lighting Systems can be arranged to form any ceiling pattern desired—

Ceilings Unlimited. Stores, offices, schools, factories and public buildings thus not only get good-seeing light, but architectural harmony.

Miller Lighting Service is all-inclusive, covering the needs of planned lighting.

Miller **50 and 100 Foot Candles** (Continuous Wire-way Fluorescent Lighting Systems) have been established as standard for general factory lighting. And Miller incandescent and mercury vapor reflector equipment has broad factory and commercial application.

Miller field engineers and distributors, conveniently located, are at your call.

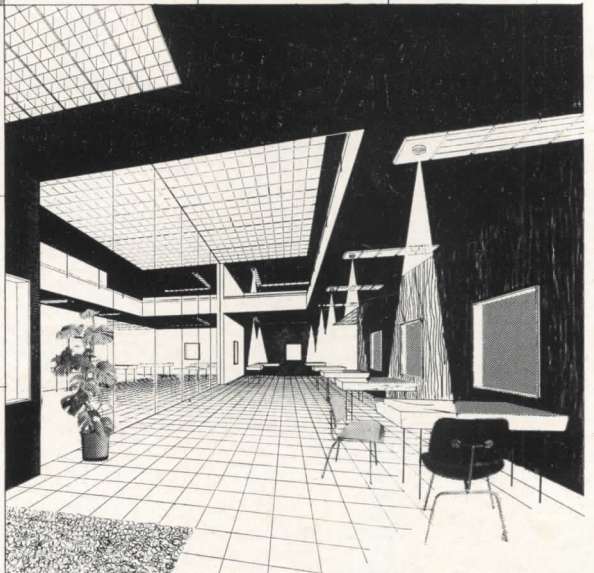

jewelry store—architect: serge chermayeff, chicago

Chermayeff.

THE miller COMPANY

SINCE 1844

ILLUMINATING DIVISION • MERIDEN, CONNECTICUT

ILLUMINATING DIVISION: Fluorescent, Incandescent, Mercury Lighting Equipment
HEATING PRODUCTS DIVISION: Domestic Oil Burners and Liquid Fuel Devices
ROLLING MILL DIVISION: Phosphor Bronze and Brass in Sheets, Strips and Rolls

NOW AVAILABLE!

THE RECORD REPORTS

(Continued from page 10)

If it's heavy-duty construction specify **ASBESTONE**

FIREPROOF
NONCORROSIVE
CLIMATE-PROOF
INSULATING
RATPROOF
NO UPKEEP
NEVER WEARS OUT

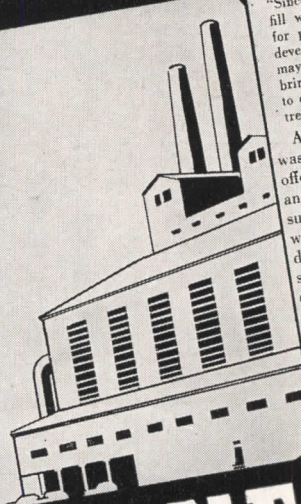

ASBESTONE
 ASBESTOS-CEMENT
 CORRUGATED ROOFING & SIDING

ASBESTONE CORPORATION

A few of the many industrial leaders who have built with ASBESTONE:

- LONE STAR CEMENT CORP.
- CALIFORNIA OIL CO.
- FREEPORT SULPHUR CO.
- NEW ORLEANS PUBLIC SERVICE
- MOBILE PAPER MILL CO.
- CROSBY CHEMICALS

ASBESTONE production has been concentrated on Corrugated to assure prompt delivery for industrial construction. Free Engineering Service, available on request: shows how Asbestone can be adapted to your needs.

ASBESTONE CORPORATION
 Specialists in Asbestos-Cement Building Products for Over 25 Years
 5300 TCHOUPITOULAS STREET NEW ORLEANS 15, LA.

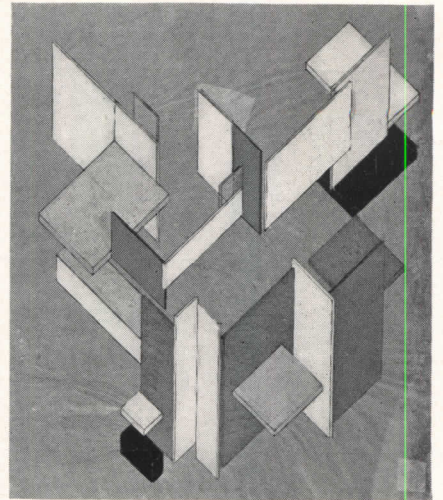

"Space-Time Construction No. 3," gouache by Theo van Doesburg; Miller Co. Collection

historical influence on modern architecture, and contemporary work which perhaps has something to offer to the contemporary architect." First showing of the exhibition was at the Wadsworth Atheneum, Hartford, Conn., in December; later showings are scheduled for Minneapolis, Akron, Baltimore, Milwaukee, and the West Coast.

Included in the Miller Co. Collection are paintings by Picasso, Braque and Gris, Kandinsky, van Doesburg, Stuart Davis, Paul Klee, Mondrian, Georgia O'Keefe, and others; and sculpture by Hans Arp, Jacques Lipchitz and Jose de Rivera among others. Of particular interest is the van Doesburg gouache (see photo above) which is said to have influenced the work of Bauhaus architects Gropius, Oud and Mies van der Rohe.

"Transfluent Lines," two-plane painting by I. Rice Pereira, in the Miller Collection

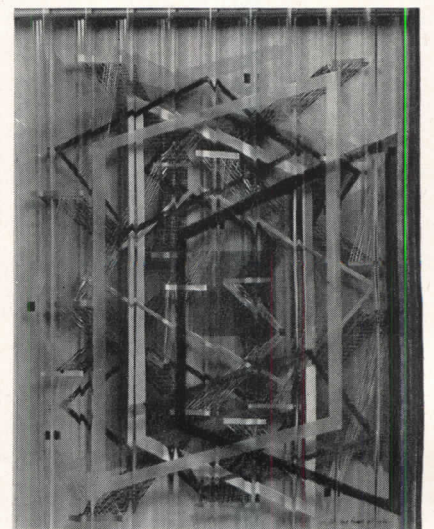

Announcing a Wide New LINE OF MODINE HEATING COILS

Many Important Advantages — 1236 Coils to Choose From

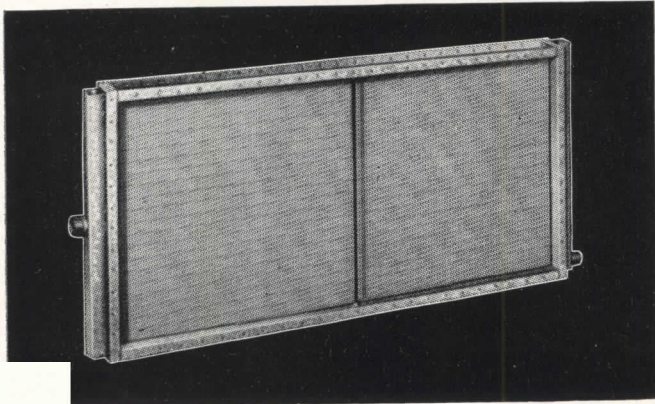

1 STANDARD COIL. For all normal heating, ventilating, air conditioning and drying applications where steam is the heating medium. These coils are now available in a complete range of sizes and models . . . 595 individual coils.

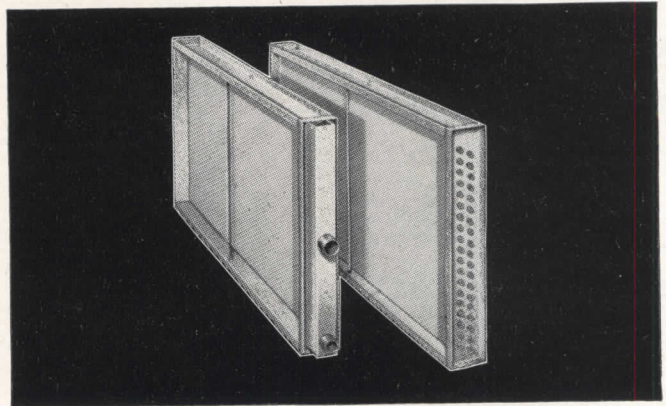

2 NON-FREEZE COIL. Incorporates steam distributing tubes for resistance to freezing and uniform face temperatures. Use where temperature is controlled by modulating steam supply . . . even with 32°F. entering air. Available in 510 sizes and models.

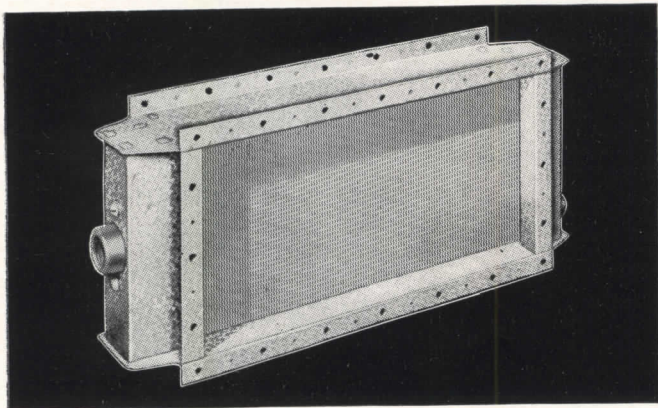

3 BOOSTER COIL. For use where small volumes of air are handled. Ideal for controlling temperatures in branch ducts. Face areas as small as ½ square foot in Standard and Non-Freeze types. Available in 46 sizes and models.

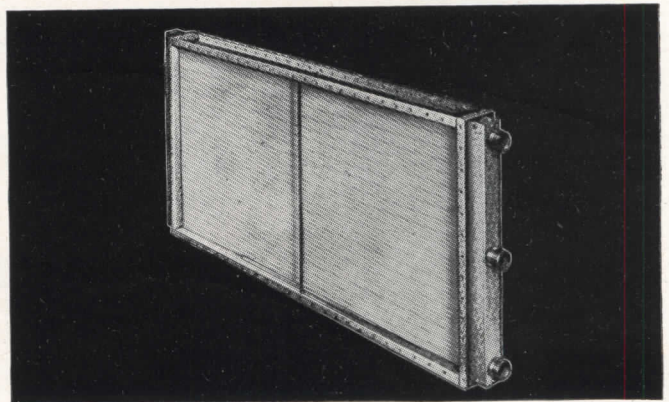

4 HOT WATER COIL. A serpentine coil for use on hot water. Exclusive Modine feature permits counterflow installation regardless of air flow direction with complete air venting and drainage provision. Available in 85 sizes and models.

Our Requirements Determined the Design of These Heating Coils!

YES, the new line of Modine Coils is designed to match your specific performance and size requirements for heat transfer surface. It's a COMPLETE line with important new features. For any given fin spacing, Modine Coils have more heating capacity per square foot of face area, because of new scientifically die-formed fin design which promotes maximum heat transfer. And you can use smaller duct sizes because of Modine design. In structural strength . . . dynamic and static . . . there's no comparison.

For complete information, send for new 48-page catalog No. 347, or call the Modine Representative listed in "Where-to-Buy-It" Section of your phone book.

Modine Manufacturing Co., 1510 Dekoven Ave., Racine, Wis.
YES! I want complete information about the new line of Modine Heating Coils. Please send me new 48 page catalog!

Name

Address

City

State

Modine HEATING COILS

WHAT ARE THE FACTS...



ABOUT SOUND SYSTEMS?

Is there a Sound System adapted to your particular needs?

How does one Sound System differ from another?

What should you consider in choosing a Sound System?

What are the advantages of a Natural Voice Sound System?

HERE ARE THE ANSWERS...

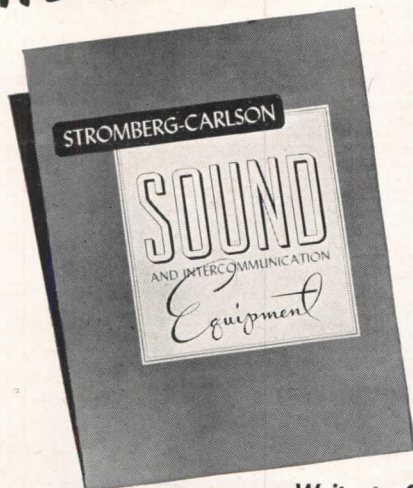

A Stromberg-Carlson NATURAL VOICE SOUND SYSTEM

for every type

of installation,

for every service.

Write to Stromberg-Carlson Rochester 3, N. Y. for catalog, stating your particular requirements.

STROMBERG-CARLSON

NATURAL VOICE SOUND SYSTEMS



THE RECORD REPORTS

(Continued from page 10)

The steep climb in building activity brought last September and October starts to nearly $2\frac{1}{3}$ times the number begun in January. These findings by the Bureau of Labor Statistics brought official assumption of 860,000 starts in 1947, making it the best home building year since 1925. The number of homes completed in the first 10 months came to 658,100 — 50 per cent more than during the entire previous year. FHA announced that more dwelling units were financed and built under its program in October than in any other month since its establishment in 1934. Total new construction in the first 11 months of 1947 was estimated by the Commerce Department at \$11.6 billion — 29 per cent above January-November, 1946.

The lumber market, for one, showed the effect of the summer and fall building "boom." Supplies fell below demand, and lumber prices, which had shown signs of stabilizing, again climbed. By the end of September, reported the Lumber Survey Committee, they were at a record high. Average wholesale prices of building materials reached an all-time high in August, despite declines in May and June, BLS advised. They stood at 179.7 per cent of the 1926 level. Increases ranged from 1 per cent for brick and tile to almost 10 per cent for structural steel.

Mortgage Financing High

Meanwhile, the Federal Home Loan Bank Board, summing up for the year ending September 30, relates that construction loans through federal savings and loan associations ran 41 per cent above the preceding year and stood at the highest point since the associations were first authorized in the early Thirties. At the same time the Board estimated that non-farm real estate financing in September reached almost \$1,023,000,000, the highest total of mortgage financing for any month since figures were first assembled by the Board in 1939. In the first nine months of 1947 such mortgages reached \$8.3 billion, an 8 per cent rise over January-September in 1946 and a record for any similar period.

The Board, incidentally, has now issued rules by which federally-chartered savings and loan associations may make loans up to \$1500 for repairs and alterations without first mortgage security.

Building Research Demanded

Necessity for building research continues in the limelight. The Construction Advisory Council of the U.S.

(Continued on page 16)

STUYVESANT TOWN, *Manhattan, N. Y.*

A development of the Metropolitan Life Insurance Co. to provide apartments for 8,755 families. *Architects:* Board of Design, Gilmore D. Clarke, Chairman; Irwin Clavan, Architect. *General Contractors:* Starrett Bros. & Eken; *Flooring Contractor:* John T. Swanson Co.

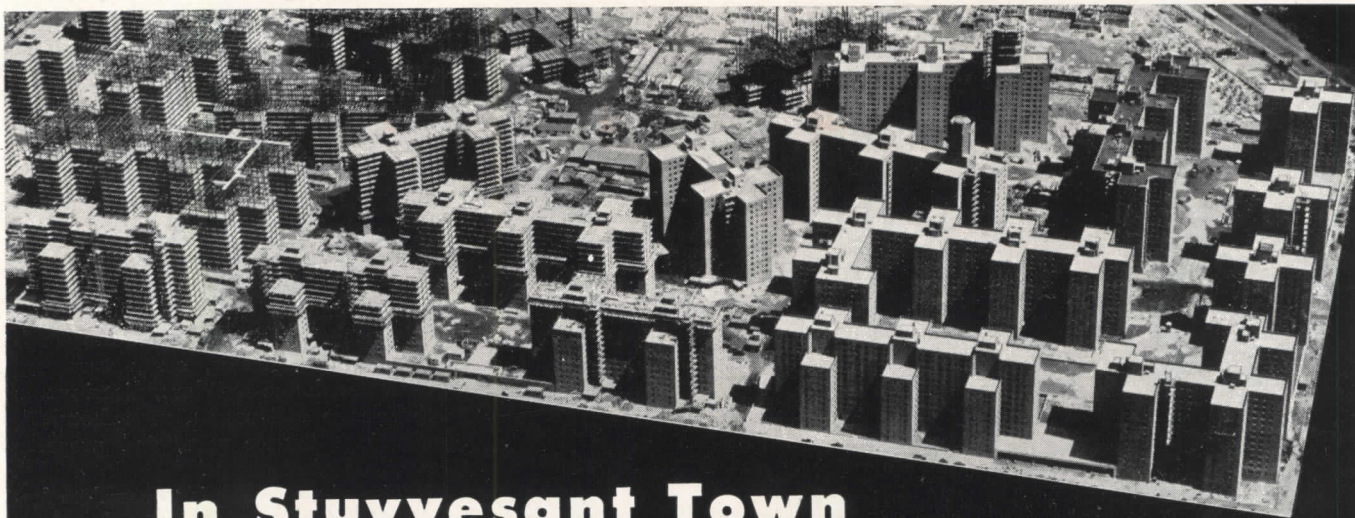

In Stuyvesant Town AND OTHER BIG APARTMENT PROJECTS

It's Bruce Block Floors!

■ Millions of feet of Bruce Blocks have been used in leading apartment developments such as Stuyvesant Town, Parkchester, Hancock Village, Peter Cooper Village, Fresh Meadows, River-ton. Architects and owners have found this the most satisfactory of all floors for modern apartments. Simple installation over concrete is one very important advantage. High resistance to wear is another . . . Bruce Block Floors are a permanent part of a building—not something to be replaced every few years. And, to make tenants happy, these floors give beautiful, distinctive appearance . . . easy, economical maintenance . . . comfort, resiliency, warmth and quiet.

Bruce Blocks are so popular that production cannot match present demand. Specify this flooring on projects being planned now for future construction. Consult our catalog in Sweet's.



The ideal floor over concrete—Bruce Blocks are quickly and easily installed directly over concrete by laying in mastic. No clips, screeds or wood subfloor used . . . a substantial saving in construction costs.



E. L. BRUCE CO., MEMPHIS, TENN.
World's Largest Maker of Hardwood Floors



BRUCE BLOCK

Hardwood Floors

We Want Protection

from air-borne bacteria



Silv-A-King's new
"GERMICIDAL UNIT"
gives that protection



HOSPITALS

 SAFELY



FACTORIES

 INSTANTLY



SCHOOLS

 ECONOMICALLY



HOMES

Over 1500 hospitals in the U. S. alone have proved that the use of Germicidal Radiation effectively reduces respiratory infection. In homes, schools, nurseries, factories, laboratories, offices — wherever there is need for protection against air-borne bacteria — germicidal radiation is a powerful factor for preserving good health.

Designed to keep pace with giant strides made in the science of air disinfection, this new Silva-A-King Germicidal unit gives positive protection against direct radiation while maintaining maximum concentration of germ-killing energy. Easy to install and completely adaptable to any room with regular electrical outlets.

Free Literature on request. Write Dept. G-48 for Germicidal Bulletin.

BRIGHT LIGHT REFLECTOR CO.

INCORPORATED

Subsidiary of BRIDGEPORT PRESSED STEEL CORPORATION

FAIRFIELD & STATE, BRIDGEPORT 5, CONN.

SALES OFFICES:

Atlanta, Ga.
Baltimore, Md.
Boston, Mass.
Chicago, Ill.
Cincinnati, Ohio
Cleveland, Ohio

Dallas, Texas
Denver, Colorado
Detroit, Mich.
Indianapolis, Ind.
Kansas City, Mo.
Los Angeles, Cal.
Minneapolis, Minn.

New York, N. Y.
Philadelphia, Pa.
Pittsburgh, Pa.
Portland, Ore.
San Francisco, Cal.
St. Louis, Mo.



THE RECORD REPORTS

(Continued from page 14)

Chamber at its November meeting dwelt on the subject and set up a Research Activities Committee to serve as a liaison with the newly established Building Research Advisory Board of the National Research Council. The Committee, headed by Raymond J. Ashton, former president of the American Institute of Architects, is now working with the industry to underwrite the BRAB with \$100,000 a year for a period of five years. To participate are architects and engineers, contractors and builders, home-builders, distributors (wholesale and retail), manufacturers, mortgage finance men, and property owners and managers.

Aim of the BRAB is to correlate factual material on planning and technological advance, to disseminate information on current research and prevent needless duplication, and to develop research in neglected areas. Heading the Board is Dr. Frank B. Jewett, recently president of the National Academy of Sciences. The 23 members under him have been chosen by the National Research Council for their interests or accomplishments in building research in fields associated with construction. There will be a research staff.

Cost Reduction Sought

In his recent message to the National Association of Housing Officials, President Truman emphasized not only the need for slum clearance and "decent housing" for low-income families but also the stimulation of "research toward better housing at lower cost."

One means of cost reduction, the industry engineered house, has been detailed in a book, *Here's a Better Way to Build*, in which 36 national organizations including the Producers' Council and the National Retail Lumber Dealers Association have collaborated. Over 5000 such homes are expected to be built this year.

The Federal Housing and Home Finance Agency, too, has issued an illustrated booklet, *Planning the Expansible House*, containing suggestions for veterans and families needing adequate low-cost housing in the current high-cost market. The booklet presents six schemes for "houses that grow." Each of the basic units contains a living room, bedroom, dining space, kitchen, adequate closets and storage space, together with heating equipment, hot water and laundry facilities. Each is planned for the addition of bedrooms and other rooms at minimum costs. Developed by HHFA, the plans can be adopted to government requirements on home mortgages.

(Continued on page 126)

Did you ever see a

water-logged
duck?

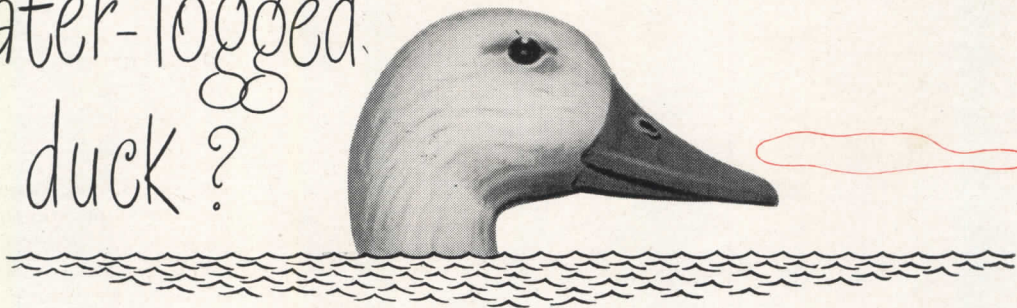

Ducks don't get water-logged because their feathery dress is naturally water-repellent. If this property were removed, they would sink like billiard balls.

Koppers roofs, too, are naturally water-repellent. Built up of Koppers Old Style Pitch and Tar-saturated Felt, they repel the moisture of pelting rains and of melting snow and ice. Coal tar pitch, the basic ingredient in Koppers built-up roofs, resists continual or intermittent exposure to water. This quality makes Koppers roofs a natural for modern

homes which utilize flat roofs for cooling purposes.

The natural water-repellancy is equaled, also, by the resistance of Koppers roofs to the sun's rays. Actually, by the process of "cold flow", cuts sustained by roofs heal themselves.

When you specify roofing, consider these advantages of Koppers Old Style Pitch and Tar-saturated Felt.

KOPPERS COMPANY, INC.
PITTSBURGH 19, PA.

Naturally, a Koppers roof for long life



**ROOFING
& WATERPROOFING**

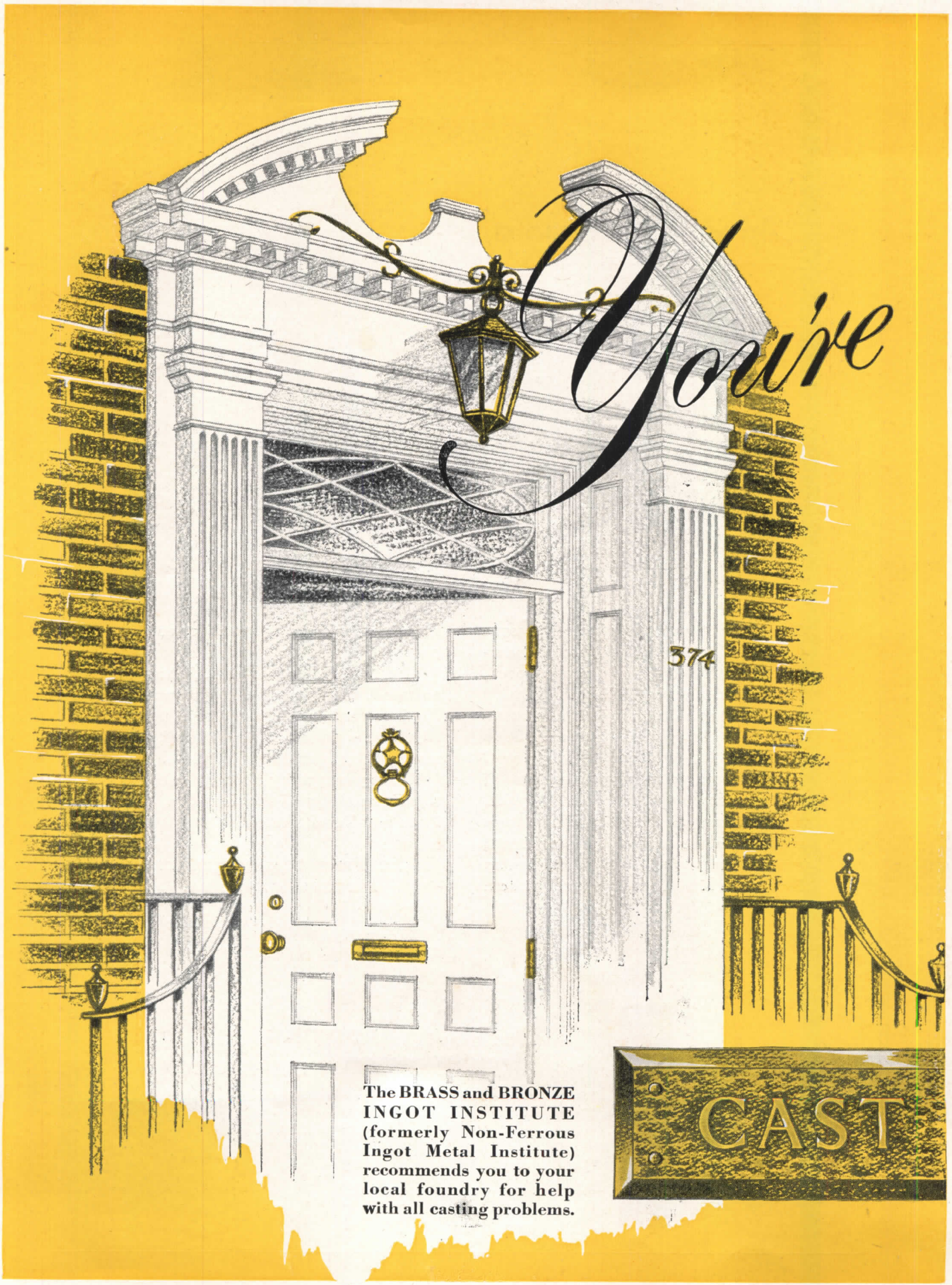

Source

374

The BRASS and BRONZE
INGOT INSTITUTE
(formerly Non-Ferrous
Ingot Metal Institute)
recommends you to your
local foundry for help
with all casting problems.

CAST

Welcome

to the **DEPENDABLE METALS**

Brass and Bronze

BEAUTIFUL . . . The elegance of Cast Brass and Bronze "belong" with architecture, in which utility and beauty are the architect's twin goals.

CASTABLE . . . In any shape or size — simple or intricate, large or small — they lend themselves to any architectural theme.

MACHINABLE . . . Basic castings that call for added working are easily machined, thus extending the wide field for Cast Brass and Bronze.

DURABLE . . . Cast Brass and Bronze have been the ornament of noble buildings and gracious homes through many centuries. They are as permanent as the structures they grace.

AVAILABLE . . . You can *get* brass and bronze for casting **NOW!**

BRASS AND BRONZE

CRANE

DURACLAY FIXTURES

for every hospital requirement

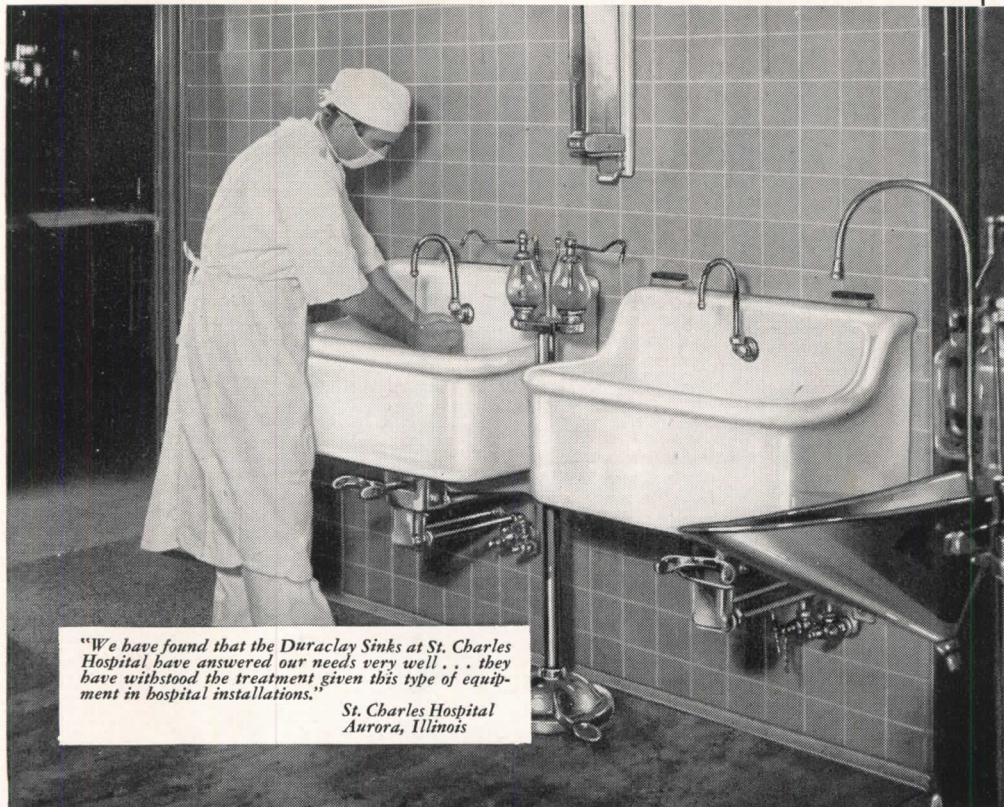

"We have found that the Duraclay Sinks at St. Charles Hospital have answered our needs very well . . . they have withstood the treatment given this type of equipment in hospital installations."

*St. Charles Hospital
Aurora, Illinois*

● Yes, for hospitals too, the broad Crane line covers all the many specialized plumbing needs. And here, as elsewhere, Crane is the best-known name in the field.

Crane Duraclay fixtures are specifically designed for the toughest service required of any plumbing equipment. Strong acids do not stain them . . . abrasion does not mar them . . . extreme changes in temperature do not crack or craze their gleaming surface. After years of round-the-clock usage, Crane Duraclay remains as bright and sparkling as the day it was installed.

Your Crane Branch will be glad to tell you anything you wish to know about the complete line of hospital fixtures.

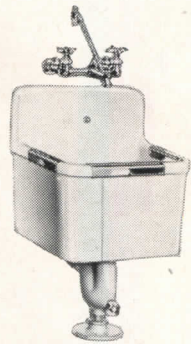

C 21-321 Duraclay*
Service Sink



C 7096 Cornell Duraclay*
Flushing Rim Service Sink

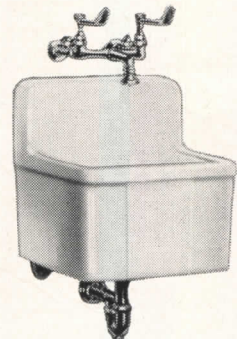

C 5676 Yale Duraclay*
Surgeons' Wash-up Sink

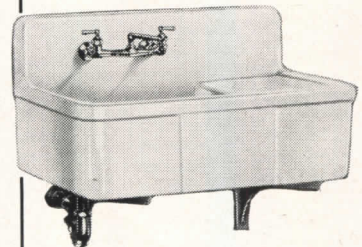

C 5622 Cornwall Duraclay*
Service Sink

**Crane Duraclay exceeds the rigid tests imposed on earthenware (vitreous glazed) established in Simplified Practice Recommendations R106-41 of The National Bureau of Standards.*

CRANE

CRANE CO., GENERAL OFFICES:
836 S. MICHIGAN AVE., CHICAGO 5
PLUMBING AND HEATING
VALVES • FITTINGS • PIPE

NATION-WIDE SERVICE THROUGH BRANCHES, WHOLESALERS, PLUMBING AND HEATING CONTRACTORS

It's the **Tops** *that take the wear*

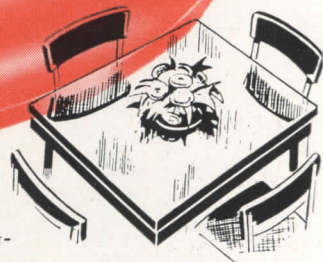

DECORATIVE MICARTA — made by WESTINGHOUSE — gives you a durable, economical, ever-beautiful surface for table tops, bars, booths, walls.

When you need a practical working surface that must combine beauty with durability and convenience, be sure to specify Decorative Micarta. Only then will you get *all 10* of these important advantages:

- 1 *Won't scratch or mar* under ordinary service conditions. Finished surface is hard and durable.
- 2 *Strong, dense material.* Guaranteed not to warp, chip or crack under ordinary service conditions.
- 3 *Genuine wood veneers available.* Truwood Micarta combines the beauty of such woods as primavera, mahogany and walnut with all the practical features of Decorative Micarta.
- 4 *Quickly and easily cleaned,* because of its permanently smooth surface.
- 5 Available in "cigarette-proof" grade at slight extra cost. Even when cigarettes burn out on it, "cigarette-proof" Decorative Micarta remains unmarred.
- 6 *Will not spot or stain* from spilled food, grease, alcohol, etc. Highly resistant to heat, moisture, mild acids and alkalis.
- 7 *Color-fast, permanent finish.* Unusually clear, lustrous colors and patterns won't fade or darken.
- 8 *Exclusive "Beauty Mask"* of tough Kraft paper protects surface during shipping, machining and installation. Strips off easily when ready for use.
- 9 *Optional finishes.* Brilliant high-gloss or lustrous satin.
- 10 *Large 4 ft. by 8 ft. sheets* of Decorative Micarta are available for covering large surfaces quickly, and with a minimum of joints. Smaller sizes also available for table tops and similar applications.

Get complete information on Decorative Micarta. It's the tops! Just the right color and pattern is available now for your interiors. Write:

UNITED STATES PLYWOOD CORPORATION
New York 18, N. Y.

Weldwood* Hardwood Plywood
Douglas Fir Weldwood
Mengel Flush Doors
Douglas Fir Doors
Overhead Garage Doors
Molded Plywood
Armorply* (metal-faced plywood)
Tekwood* (paper-faced plywood)

Flexmet
Weldwood Glue* and other adhesives
Weldtex* (striated plywood)
Decorative Micarta
Flexwood*
Flexglass*
Firzite*
*Reg. U. S. Pat. Off.

**DECORATIVE
MICARTA**

**PLAN-O-LITE . . . THE FRINK SERVICE
THAT GUARANTEES LIGHTING SATISFACTION**



A modern showroom, illuminated by L-I-N-O-L-I-T-E Series 15 Troffers with four 40W lamps and louver bottoms, and custom built circular cove lighting.

Frink's **PLAN-O-LITE** service is unique in the lighting industry. Backed by more than ninety years of experience, it insures the *right start* in determining the proper fixtures and arrangement to secure maximum lighting efficiency.

A Frink **PLAN-O-LITE** is a complete lighting layout, *custom-engineered* to meet your exact requirements. There's no extra charge for this service. Furthermore, many Frink customers have found that **PLAN-O-LITE** saved them a considerable sum through proper planning. And lighting satisfaction is *guaranteed*, if Frink specifications are followed.

Send for our sample packet of **PLAN-O-LITE** layouts and photos, showing a variety of modern fluorescent installations by Frink.

The coupon will bring them promptly by return mail.

CLIP THIS TO YOUR LETTERHEAD



THE FRINK CORPORATION
27-01 Bridge Plaza North, L. I. C., N. Y.
Without cost or obligation, send your sample packet of PLAN-O-LITE fluorescent layouts and photos to the

Attention of

() also please send catalogue of new Frink fluorescent fixtures.

1-AR

There's a Frink L-I-N-O-L-I-T-E fixture correctly engineered for every commercial fluorescent lighting need. Seventeen standard designs of highest quality workmanship and materials, each available with matching incandescent down-lights if desired. Check coupon at left for your copy of the Frink catalogue today



THE FRINK CORPORATION

27-01 BRIDGE PLAZA NORTH, LONG ISLAND CITY, N. Y.

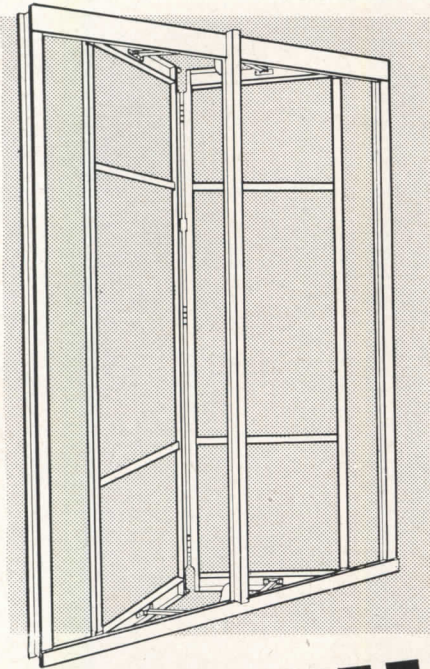

BROWNE

folding type

WINDOWS

— TYPES —

Monumental – Psychiatric
Underwriters' Label – Residential
Aluminum – Bronze

The BROWNE Folding Type Window is back in full production . . . with numerous betterments in the exclusive features that through 32 years have won for BROWNE Folding Type Windows the distinction of being installed in many of the nation's outstanding structures.

A few features of the BROWNE Folding Type Window that merit your careful consideration are: *100% Controllable draft-free ventilation — minimum maintenance cost — maximum light and vision — perfect air seal — permanent ease of operation — dust proof — both sides of glass can be cleaned from the inside.*

We have the materials, the facilities, the organization that will insure meeting all your requirements . . . and on schedule!

Our department of design is ready to work with you. Your request for special data, catalog and/or drafting room standards will receive immediate attention.

BROWNE Folding Type Windows are in better buildings throughout the nation — manufactured exclusively by UNIVERSAL CORPORATION in Dallas . . . manufacturers of building products under the trade-name SEALUXE: Browne Folding Type Windows, Double-hung Windows, Side Hinged Casements, Theatre Display Systems, Thermo Windows and Shades.

Refer to
SWEET'S ARCHITECTURAL FILE.

**“Miracles
 in
 Metals”**

Universal

J. P. TRAVIS, PRESIDENT

CORPORATION

6710 DENTON DRIVE

Qualified sales representatives in all architectural centers

DALLAS 9, TEXAS



Two Door Closers in a Winter Storm One is Safe . . . the Other Suffers

**Experience shows that, other things being equal, an
Overhead Door Closer is most efficient, least costly!**

A winter storm merely dramatizes and exaggerates what goes on every day in the damage to exposed equipment done by weather, water and dirt. Door closers especially get constant abuse which tends to keep maintenance high. But this can be avoided.

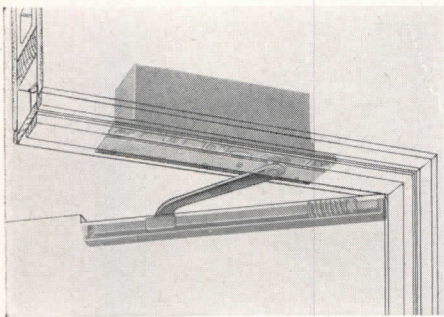

**The Overhead Concealed Closer
is up and away from possible harm**

In 21 years of manufacturing and of watching results in use of exposed closers, floor concealed closers and overhead concealed closers, we are convinced that only the last-named offer true concealment AND true

economy in use. Rain, snow, dirt and scrub water just can't reach the overhead closer box, snugly concealed in the head frame.

**The Closer in the Floor
is bound to get floor dirt and water**

No floor type door closer can escape entirely the moisture and dirt from the floor surface. Drop by drop, grain by grain, they get in and foul the mechanism, causing frequent service calls, shortening the closer's life, increasing its total or yearly cost.

We cite these comparisons without prejudice. We make three series of LCN floor

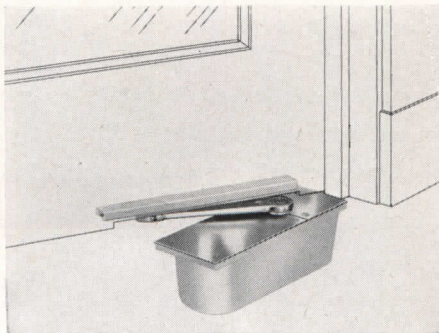

type door closers. Thousands have been in use for long periods. They are as efficient and durable as a floor closer can be made. But because of their natural handicaps we don't recommend them where overhead concealed closers can be used.

**The Overhead Concealed Closer
is simpler to install, to move
and to keep in working order**

The overhead concealed closer is easily secured in an opening prepared in the head frame (wood or metal). No chiseling of floors; no guesswork as to location; no interference with pipes or conduits. When a partition wall moves, the door and closer go with it. No boxed or cut thresholds needed. Job costs (and total cost) are kept down. Adjustments easily made without removing anything. Closer delivers long, efficient service.

Send for latest information

The LCN catalog 11-a is a handbook of good door control, showing applications of 10 types of concealed closers. May we send you a copy? No obligation. LCN, 466 W. Superior St., Chicago 10, Ill.

LCN

**Overhead and Floor Type
Concealed and Surface Type Door Closers**

I t's good electrical practice...

to provide ample capacity for present and future needs on distribution systems, service equipment, switches, circuit breakers and other plant electrical equipment



**It's good
Electrical
Practice...**



to protect general service light and industrial power circuits with Trumbull "AT" Enclosed Circuit Breakers. A completely enclosed, non-tamperable unit, designed to replace fuses, fused switches and other circuit protection, this device requires no element to renew after circuit interruption.

"AT" Circuit Breakers have adequate wiring space (plenty of room for pulling wires and making connections) . . . liberal number of knockouts, cleanly cut and readily removable . . . semi-dust type construction with felt gasket and a screw on front with provision for sealing . . . also available in cast enclosures for explosion proof and water and dust tight applications . . . locking shelf for 3 padlocks in either the "on" or "off" position. Flexible engaging mechanism eliminates possibility of handle breakage.

It's also good practice to specify Trumbull, the make that protects *your* safe practice, for any of the following equipment — safety switches, switchboards, panelboards, motor controls, control centers, circuit breakers, L.V.D. Busways and FLEX-A-POWER branch feeders. THE TRUMBULL ELECTRIC MANUFACTURING CO., Plainville, Conn. Other factories at Norwood, Ohio, San Francisco, Seattle, N. Hollywood. Sales offices and representatives in all important cities.

**MEN WHO OBSERVE THE
BEST PRACTICES MAKE
IT A PRACTICE TO USE
TRUMBULL**

TRUMBULL  ELECTRIC

CONSTRUCTION COST INDEXES — Labor and Materials

United States average 1926—1929=100

Presented by Clyde Shute, manager, Statistical and Research Division, F. W. Dodge Corporation, from data compiled by E. H. Boeckh & Associates, Inc.

NEW YORK

ATLANTA

Period	Residential		Apts., Hotels, Office Bldgs. Brick and Concr.	Commercial and Factory Buildings Brick and Concr.		Brick and Steel	Residential		Apts., Hotels, Office Bldgs. Brick and Concr.	Commercial and Factory Buildings Brick and Concr.		Brick and Steel
	Brick	Frame					Brick	Frame				
1920	136.1	136.9	123.3	123.6	122.6		122.8	122.9	108.6	109.8	105.7	
1925	121.5	122.8	111.4	113.3	110.3		86.4	85.0	88.6	92.5	83.4	
1930	127.0	126.7	124.1	128.0	123.6		82.1	80.9	84.5	86.1	83.6	
1935	93.8	91.3	104.7	108.5	105.5		72.3	67.9	84.0	87.1	85.1	
1939	123.5	122.4	130.7	133.4	130.1		86.3	83.1	95.1	97.4	94.7	
1940	126.3	125.1	132.2	135.1	131.4		91.0	89.0	96.9	98.5	97.5	
1941	134.5	135.1	135.1	137.2	134.5		97.5	96.1	99.9	101.4	100.8	
1942	139.1	140.7	137.9	139.3	137.1		102.8	102.5	104.4	104.9	105.1	
1943	142.5	144.5	140.2	141.7	139.0		109.2	109.8	108.5	108.1	108.7	
1944	153.1	154.3	149.6	152.6	149.6		123.2	124.5	117.3	117.2	118.2	
1945	160.5	161.7	156.3	158.0	155.4		132.1	133.9	123.2	122.8	123.3	
1946	181.8	182.4	177.2	179.0	174.8		148.1	149.2	136.8	136.4	135.1	
July 1947	223.4	225.0	211.2	212.5	206.6		184.0	187.9	160.3	159.6	158.8	
Aug. 1947	225.5	227.1	215.5	214.9	209.4		185.4	189.3	162.4	161.2	161.4	
Sept. 1947	225.9	227.5	216.4	216.0	210.4		185.6	189.5	164.1	162.3	165.0	
Oct. 1947	228.7	231.0	218.5	217.4	213.8		186.9	191.0	165.0	163.0	165.8	
			% increase over 1939						% increase over 1939			
Oct. 1947	85.1	88.7	67.1	62.9	64.3		116.5	129.8	73.5	67.3	75.1	

ST. LOUIS						SAN FRANCISCO						
Period	Residential		Apts., Hotels, Office Bldgs. Brick and Concr.	Commercial and Factory Buildings Brick and Concr.		Brick and Steel	Residential		Apts., Hotels, Office Bldgs. Brick and Concr.	Commercial and Factory Buildings Brick and Concr.		Brick and Steel
	Brick	Frame					Brick	Frame				
1920	118.1	121.1	112.1	110.7	113.1		108.8	107.5	115.2	115.1	122.1	
1925	118.6	118.4	116.3	118.1	114.4		91.0	86.5	99.5	102.1	98.0	
1930	108.9	108.3	112.4	115.3	111.3		90.8	86.8	100.4	104.9	100.4	
1935	95.1	90.1	104.1	108.3	105.4		89.5	84.5	96.4	103.7	99.7	
1939	110.2	107.0	118.7	119.8	119.0		105.6	99.3	117.4	121.9	116.5	
1940	112.6	110.1	119.3	120.3	119.4		106.4	101.2	116.3	120.1	115.5	
1941	118.8	118.0	121.2	121.7	122.2		116.3	112.9	120.5	123.4	124.3	
1942	124.5	123.3	126.9	128.6	126.9		123.6	120.1	127.5	129.3	130.8	
1943	128.2	126.4	131.2	133.3	130.3		131.3	127.7	133.2	136.6	136.3	
1944	138.4	138.4	135.7	136.7	136.6		139.4	137.1	139.4	142.0	142.4	
1945	152.8	152.3	146.2	148.5	145.6		146.2	144.3	144.5	146.8	147.9	
1946	167.1	167.4	159.1	161.1	158.1		159.7	157.5	157.9	159.3	160.0	
July 1947	205.6	207.2	187.8	187.8	187.5		195.1	194.0	186.6	190.6	188.0	
Aug. 1947	207.0	208.6	189.9	189.4	190.1		196.7	195.6	188.9	192.4	190.8	
Sept. 1947	207.5	209.0	191.2	190.8	192.3		198.4	196.3	192.5	197.4	195.7	
Oct. 1947	210.7	213.0	192.2	191.5	193.4		207.1	206.2	195.4	199.6	198.9	
			% increase over 1939						% increase over 1939			
Oct. 1947	91.1	99.1	61.9	59.8	62.5		96.1	107.6	66.4	63.7	70.7	

The index numbers shown are for combined material and labor costs. The indexes for each separate type of construction relate to the United States average for 1926-29 for that particular type — considered 100.

Cost comparisons, as percentage differences for any particular type of construction, are possible between localities, or periods of time within the same city, by dividing the difference between the two index numbers by one of them; i.e.:

index for city A = 110
index for city B = 95

(both indexes must be for the same type of construction).

Then: costs in A are approximately 16 per cent higher than in B.

$$\frac{110-95}{95} = 0.158$$

Conversely: costs in B are approximately 14 per cent lower than in A.

$$\frac{110-95}{110} = 0.136$$

Cost comparisons cannot be made between different types of construction because the index numbers for each type relate to a different U. S. average for 1926-29.

Material prices and wage rates used in the current indexes make no allowance for payments in excess of published list prices, thus indexes reflect minimum costs and not necessarily actual costs.

These index numbers will appear whenever changes are significant.

Bronze doors and grille work provide simplicity and elegance. Extruded shapes are employed for door trim and frames. Grilles are formed from special shapes, tubes and bars.

Cram and Ferguson, Architects
Turner Construction Co., General Contractor

Dignity, Performance, Utility



indicate *BRONZE*

IN THE strikingly handsome home office building of the New England Mutual Life Insurance Company of Boston, the architects and builders have made fullest use of bronze for its utilitarian advantages, its reduction in maintenance cost as well as its impressive

beauty that is enhanced as time goes on.

Main entrance doors and grille work, the auditorium marquee, ornamental work in general and window frames throughout the building were fabricated by the General Bronze Corporation from Anaconda Architectural Bronze.

Added to the obvious advantages of this rustless, traditionally beautiful metal, is long run economy over less durable metals. This is exemplified particularly in windows which require little maintenance, operate smoothly, will never bind or cause panes to fracture through rust accumulation in the channels.

4717

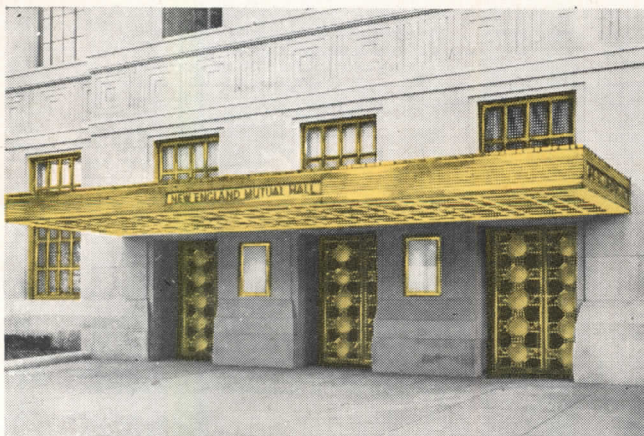

The face of the marquee is formed of sheet bronze, the glass lighting panels are supported in a frame of extruded shapes. Directory boards are also framed by extruded shapes.

from mine to consumer

ARCHITECTURAL BRONZE
THE AMERICAN BRASS COMPANY
 General Offices: Waterbury 88, Connecticut
 Subsidiary of Anaconda Copper Mining Company
 In Canada: ANACONDA AMERICAN BRASS, LTD.,
 New Toronto, Ont.

REQUIRED READING

HOSPITALS

Hospital Care in the United States. By the Commission on Hospital Care. New York 22 (41 E. 57th St.), The Commonwealth Fund, 1947. 6 by 9 in. xxiv+632 pp. illus. \$4.50.

Architects specializing in or even occasionally doing hospital work will find in this study much detailed background material not elsewhere available. For this is the report of two years of work by the Commission on Hospital Care, and in effect is a picture of the hospital situation throughout the country today.

Of chief interest to the architect are the chapters on the functions of the general hospital and the facilities required for successful operation. There is no discussion of the actual planning of the hospital, however, and only a brief chapter or two on the types of facility needed. The book is not intended primarily for the architect, but for the hospital administrator; its value to the architect, therefore, lies solely in its ability to increase his understanding and knowledge of the hospital's special problems. The Commission's recommendations are summarized, and much of the data is presented graphically, making the volume an excellent one for the reference shelf.

HOW TO BE AN ARCHITECT

Architectural Practice. By Clinton H. Cowgill, A.I.A., and Ben John Small, A.I.A. New York 18 (330 W. 42nd St.), Reinhold Publishing Corp., 1947. 9 by 12 in. 396 pp. \$12.00.

A practicing architect presumably knows all that this book contains, but the chances are more than good that he will read these pages with lively interest and considerable profit just the same. The student and the neophyte, of course, will find the volume made to order for their specific needs.

Messrs. Cowgill and Small have written a textbook which covers every phase of the architect's work from the development of a clientele to the keeping of books. Each chapter has a bibliography for further reading and a list of review questions, so that the book will be a good one for discussion groups and pre-examination review as well as for classroom use. The thoroughness of the coverage is indicated by the inclusion in the section on specification writing of a tabulation of punctuation and proofreaders' marks.

Contract forms and forms of agreement are included (even a typical negotiated agreement between architect and union); there is a detailed section on business principles, with separate chapters on architects' accounts and financing of building projects; another

section deals with the legal and professional aspects of architectural practice, others with contract conditions, bonds, mechanic's liens, contract letting and so on.

For the review student there is an excellent section on the certification of architects, with excerpts from the licensing requirements of each state with laws regulating the practice of architecture and a complete New York State examination. A final chapter in the Architectural Practice section describes the activities and membership qualification of the American Institute of Architects.

COMPANY HISTORY

The Metropolitan Life: A Study in Business Growth. By Marquis James. New York 17 (18 E. 48th St.), The Viking Press, 1947. 6 by 9 in. 480 pp. illus. \$5.00.

Quite apart from its interest as the biography of a company which has made good, this latest volume by Pulitzer Prize winner Marquis James should attract readers from many different fields and of widely variant opinions. For Mr. James has presented the story of Metropolitan's growth and activities in broad terms, against a background of the history of the country since the company's founding.

Of chief interest to the architect and city planner, of course, will be the chapters describing Metropolitan's ventures into the housing field. These started in 1911 with the erection of a group of seven-room, semi-detached brick and limestone houses in the Mapleton section of Brooklyn, the first mortgages on which were held by Metropolitan. It was not until 1922, when New York State passed a bill making it permissible for life insurance companies to invest a small percentage of their assets in housing, that the company branched out into apartment construction. The first project undertaken was a 2125-apartment development in Queens which was fully rented long before it was completed; the rent was \$9 a room. There followed, of course, gigantic Parkchester in the Bronx (12,272 units rented at about \$14 a room), and still later Parkfairfax near Washington, D. C., Parklabrea in Los Angeles, and Parkmerced in San Francisco. The most recent additions to the Metropolitan housing group are the now-almost-complete Stuyvesant Town and Peter Cooper Village in lower Manhattan, and the Riverton project in Harlem.

How these various developments came to be built, and how Metropolitan fared with its huge mortgages on the Empire State Building and Rockefeller Center, make absorbing chapters in a

book which in its entirety is of considerably more interest than its rather prosaic title might suggest.

MADE TO SELL

Design for Business. By J. Gordon Lippincott. Chicago 2, Ill. (5 N. Wabash Ave.), Paul Theobald, 1947. 8½ by 11 in. 226 pp. illus. \$8.00.

Here is industrial design in essence: an applied art, says Mr. Lippincott, "which not only should enhance the beauty of everyday living but should also increase the functional usefulness of the object to which it is applied." What the industrial designer does, and how he does it, is the subject of this book. The book itself, incidentally, has been subjected to Mr. Lippincott's double requirement — it is a handsome volume, and functionally useful in its format.

As one of the country's foremost industrial designers, Mr. Lippincott is well able to discuss such things as style and "combating the anonymity of mass production." Through these pages to illustrate his points are photographs of toasters, automobiles, furniture, radios — a hundred objects in daily use.

HOME FURBISHING

Painting Patterns for Home Decorators. By Ruth Wyeth Spears. New York 16 (114 E. 32nd St.), M. Barrows & Co., Inc., 1947. 8½ by 11 in. 128 pp. illus. \$3.50.

Even the unartistic reader should have no trouble following the instructions of Mrs. Spears in this book on brightening up the home with hand-painted furniture and decorations. She has supplied not only the ideas (and there are plenty of them), but traceable patterns and simple directions for mixing paints. The result is a volume which will give a lot of people a lot of fun and a brand new hobby.

TECHNICAL BOOKS

WITH HAMMER AND SAW

Carpentry for the Building Trades. By Elbert A. Lair. New York 18 (330 W. 42nd St.), McGraw-Hill Book Co., Inc., 1947. 6 by 9 in. viii+188 pp. illus. \$2.50.

"The aim of this book," explains the author in his preface, "is to provide in text form the essentials of practical carpentry for the building trades; to bring into organized form the fundamental objectives of the construction of the small and medium-sized frame house; and to provide a definite course for high school, technical school, vocational school, apprenticeship, and veterans' apprenticeship classes in carpentry."

This aim Mr. Lair has achieved with considerable success. The volume is nicely thought out from beginning to end, and illustrated liberally with draw-

(Continued on page 30)

DOUBLE DUTY
DOUBLE DUTY

INSULITE

(BILDRITE
SHEATHING)

BUILDS

INSULATES

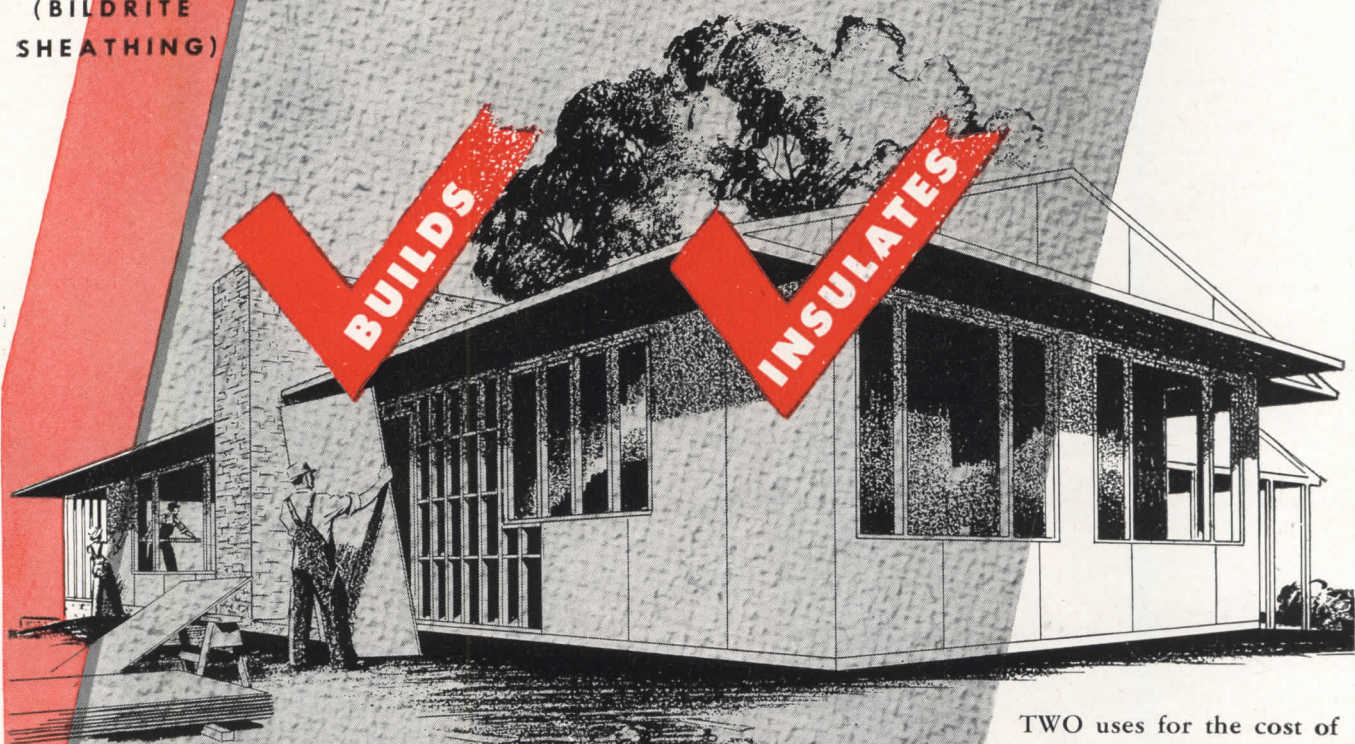

TWO uses for the cost of one. Sheathing PLUS insulation. This is the smart, progressive, economical way of planning better construction. Results in more satisfied clients. Specify double-duty INSULITE.

INSULATES AS IT
BUILDS AS IT

double-duty
INSULITE
The GENUINE

BUILDS
INSULATES

"Insulite" is a registered trade mark, U.S. Pat. Off.

INSULITE DIVISION
PAPER  MINNESOTA & ONTARIO
COMPANY
MINNEAPOLIS 2, MINNESOTA

MACOMBER STEEL FRAMING

For THE FAST ECONOMICAL ERECTION OF
MULTIPLE LIGHT OCCUPANCY Buildings

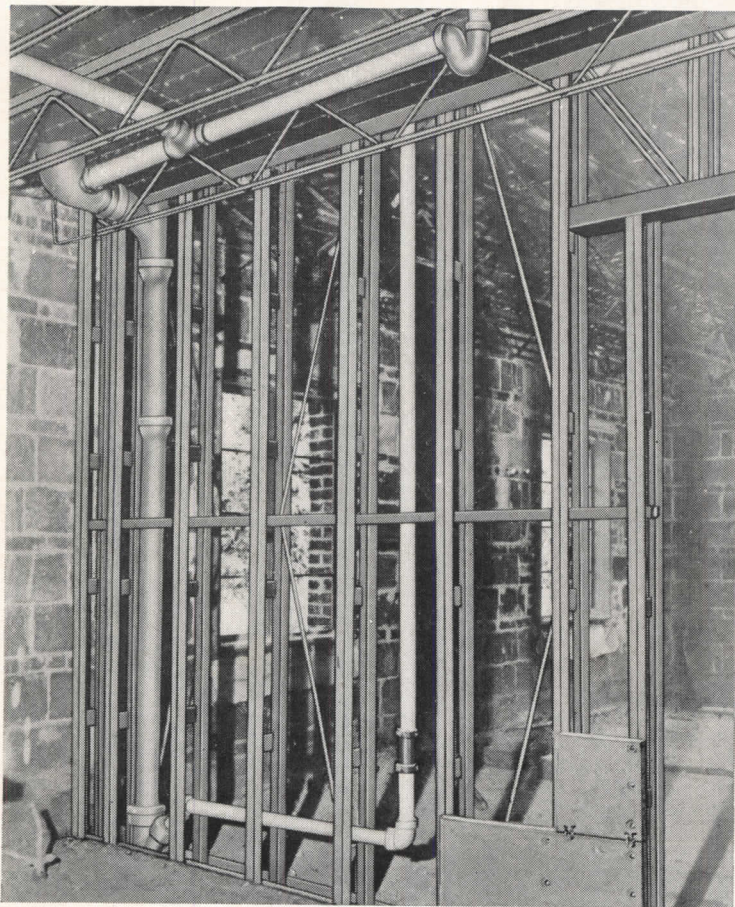

• Shown above is a Macomber Load Bearing Partition Panel as now being supplied for multi-story housing projects. The open design of these sturdy units provides ample space for plumbing and wiring. Openings are framed and wall materials are nailed to V Stud Sections. When used in conjunction with Macomber Bar Joists and light Roof Trusses, an entire building is steel framed in a minimum of time and cost. We offer prompt interpretation of these structural sections for your next project. Literature available. Write.

V-BAR JOISTS AND PURLINS • V-STUDS • TRUSSES • LONGSPANS • DECKING

SERVICE IN STEEL

STANDARDIZEDMCONSTRUCTION

MACOMBER

INCORPORATED

CANTON, OHIO

STANDARDIZED STEEL BUILDING PRODUCTS

REQUIRED READING

(Continued from page 28)

ings which are both large enough and simple enough for easy understanding by the student. It should appeal also to the amateur builder and to the hobbyist carpenter, as well as to anyone interested in the building field.

PLYWOOD EXPLAINED

Plywood: What It Is — What It Does. By Louis H. Meyer. New York 18 (330 W. 42nd St.), McGraw-Hill Book Co., Inc., 1947. 6 by 9 in. 250 pp. illus. \$3.50.

With plywood becoming more and more popular for all kinds of uses, this manual on the subject will be welcomed by the architect and engineer as well as by the industrial designer and craftsman. It covers, as the preface points out, "the physical properties and end uses of plywood and a number of kindred laminates and sets forth their composition, structural elements, and mechanical characteristics so that the user can specify these products for, and adapt them intelligently to, whatever project he has in hand."

The book starts out with a chapter which describes the general characteristics of plywood, including the methods of cutting, bonding and finishing. There follows a chapter on the unique characteristics of the material — high strength-weight ratio, resistance to splitting, insulating qualities, fire retardance, etc. With this as background, the rest of the book is devoted to the uses made of plywood and to a detailed discussion of the various kinds and grades of plywood available. Especially helpful are the tables of the veneers of fancy woods generally obtainable for custom jobs, and the many properties tables. There is also a glossary of terms in common use in the plywood industry.

NEW EDITION

ARC WELDING

Lessons in Arc Welding. 3rd edition. Cleveland, Ohio, The Lincoln Electric Co., 1947. 5½ by 8½ in. 158 pp. illus. 50 cents.

So complete has been the revision of this third edition of LESSONS IN ARC WELDING that a practically new book has resulted. Including 58 lessons and 228 photographs and illustrations, the volume features a "Questions and Answers" department covering 30 pages.

The text incorporates much new material such as welding with alternate current; new procedures covering large electrodes, with recommendations as to their use; pipe welding; and data on the qualification of welding operators. Also included is a discussion of distortion with recommendations as to its prevention and control.

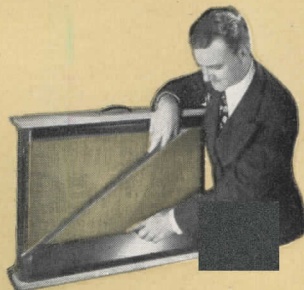

See this 10-minute demonstration. Learn how this modern method of paneling and partitioning fits your building, modernizing or partitioning plans. CALL YOUR NEAREST M/P DISTRIBUTOR TODAY.

YOUR M/P DISTRIBUTOR

- ALABAMA
- Birmingham... Acousti Engineering Co.
- Mobile... Acoustics & Specialties Co.
- ARIZONA
- Phoenix... J. B. Matz Co.
- ARKANSAS
- Little Rock... Acoustics & Specialties Co.
- CALIFORNIA
- Los Angeles... The Harold E. Shugart Co.
- Oakland
- Sacramento } ... F. K. Pinney, Inc.
- San Francisco
- COLORADO
- Denver... Lauren Burt, Inc.
- CONNECTICUT
- Hartford... The C. A. Bader Co.
- DELAWARE
- Wilmington... The W. M. Moyer Co.
- Wilmington (Eastern Shore)
- John H. Hampshire, Inc.
- DISTRICT OF COLUMBIA
- Washington... John H. Hampshire, Inc.
- FLORIDA
- Jacksonville } ... Acousti Engineering Co.
- Miami } of Fla.
- Tampa
- Pensacola... Acoustics & Specialties Co.
- GEORGIA
- Atlanta... Acousti Engineering Co.
- ILLINOIS
- Decatur... Hugh J. Baker & Co.
- INDIANA
- Evansville } ... Hugh J. Baker & Co.
- Ft. Wayne
- Indianapolis
- Wabash
- KENTUCKY
- Louisville... E. C. Decker & Co.
- LOUISIANA
- New Orleans... Acoustics & Specialties Co.
- MAINE
- Portland... Pitcher & Co.
- MARYLAND
- Baltimore... John H. Hampshire, Inc.
- MASSACHUSETTS
- Boston... Pitcher & Co.
- Springfield... The C. A. Bader Co., Inc.
- MICHIGAN
- Detroit... R. E. Leggette Co.
- Grand Rapids... Leggette-Michaels Co.
- MINNESOTA
- Minneapolis... Insulation Sales Co., Inc.
- MISSOURI
- Kansas City } ... Henges Co., Inc.
- St. Louis
- NEW JERSEY
- Elizabeth... Jacobson & Co.
- Trenton... The W. M. Moyer Co.
- NEW MEXICO
- Albuquerque... The Jay Gear Corp.
- NEW YORK
- Albany } ... Collum Acoustical Co.
- Buffalo } of Rochester
- Jamestown } of Rochester
- Rochester } of Rochester
- Syracuse } of Rochester
- New York City... Jacobson & Co.
- NORTH CAROLINA
- Charlotte... Acousti Engineering Co. of the Carolinas
- OHIO
- Akron } ... Mid-West Acoustical & Supply Co.
- Cleveland } of Toledo
- Columbus } of Toledo
- Toledo } of Toledo
- Cincinnati } of Toledo
- Dayton } of Toledo
- PENNSYLVANIA
- Altoona } ... Harry C. Leezer Co.
- Pittsburgh } of Philadelphia
- Sharon } of Philadelphia
- Harrisburg } of Philadelphia
- Philadelphia } of Philadelphia
- Seranton } of Philadelphia
- RHODE ISLAND
- Providence... Pitcher & Co.
- SOUTH CAROLINA
- Charleston... Acoustic Engineering Co. of the Carolinas
- SOUTH DAKOTA
- Sioux Falls... Insulation Sales Co., Inc.
- TENNESSEE
- Chattanooga } ... Len Herndon Co.
- Knoxville } of Memphis
- Nashville } of Memphis
- Memphis } of Memphis
- TEXAS
- Dallas } ... S. W. Nichols Co.
- Houston } of El Paso
- San Antonio } of El Paso
- El Paso } of El Paso
- UTAH
- Salt Lake City... Lauren Burt, Inc.
- VERMONT
- Rutland... The C. A. Bader Co.
- VIRGINIA
- Norfolk } ... John H. Hampshire, Inc.
- Richmond } of Roanoke
- Roanoke } of Roanoke
- WEST VIRGINIA
- Huntington... E. C. Decker & Co.
- Clarksburg } ... Harry C. Leezer Co.
- Wheeling } of Huntington
- WISCONSIN
- Milwaukee } ... Edw. T. VerHalen, Inc.
- Green Bay } of Milwaukee
- WYOMING
- Cheyenne... Lauren Burt Inc.

This startling transformation... of old building space into a modern executive office at the Okonite Company, Passaic, New Jersey, is characteristic of the new decorative effects which are easily achieved with M/P Metlwal Paneling and Partitioning.

Looking for a **FASTER, EASIER** way to get **Distinctive, Permanent Paneling?**

ORDINARY buildings and rooms are quickly transformed into smart, distinctive offices by Martin-Parry Metlwals. Using only a few standard parts from warehouse stock, M/P Metlwals permit fast, easy installation of permanent paneling... eliminate the need for any type of filler board, plaster, or other construction materials. And Metlwal is ideal for new construction, too.

Movable Partitions for Flexible Floor Plans

In outer offices, where efficient use of space may require floor plan changes, Metlwal movable partitions provide a durable, attractive means of dividing space... permanent, yet easily moved without waste of time or material.

Factory Finished in Crackproof, Chipproof Enamel

The face sheets of M/P Metlwals are fac-

tory finished in natural woodgrain reproductions or in a variety of baked enamel colors. These beautiful finishes will not crack, chip or craze... do not reflect harsh metallic light. Bonderized against rust and corrosion, Martin-Parry Metlwals meet every paneling and partitioning requirement and assure faster, cleaner, easier installation... combine long life, lasting beauty, soundproofing and fire resistance with low initial cost and easy maintenance.

Write today for FREE BOOKLET A-1 for your A.I.A. file... showing how Metlwals can help you plan and utilize office space more effectively... how Metlwals are made and installed... along with specifications and photos of actual installations. ADDRESS: Martin-Parry Corporation, Toledo 1, Ohio. PLANTS: Toledo, Ohio; York, Pennsylvania.



MARTIN PARRY
MP
PRODUCTS

METLWALS

ALL-FLUSH PANELING
MOVABLE PARTITIONS

67 Years of Service

ENGINEERING AND ERECTING SERVICE AND
WAREHOUSE STOCKS FROM COAST-TO-COAST

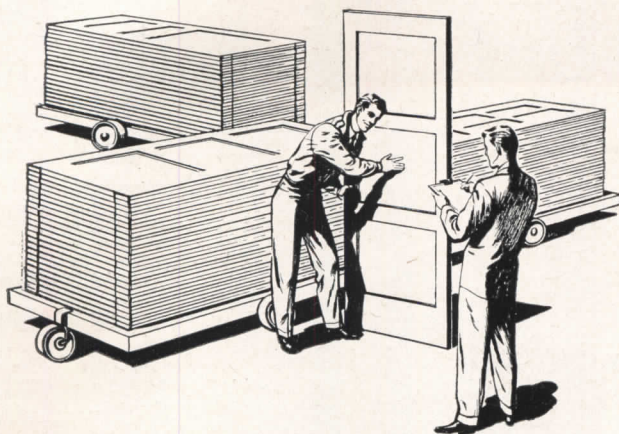

Fir Door Institute INSPECTION SERVICE

assures the quality and uniformity
of officially grade-marked

DOUGLAS FIR DOORS

EVERY Douglas fir door stamped with an official F.D.I. grade-mark comes under the new Fir Door Institute inspection service—to assure the highest possible product quality and uniformity.

Inspection covers workmanship, appearance, grade—and new dimension specifications adopted for stock interior doors. Stock doors are now pre-fit to 1/8-inch less than previous net catalog height, and 3/16-inch less than catalog width, permitting installation without sawing, trimming

or planing. On-the-job costs are reduced. A cleaner, more attractive product is assured.

Stock doors are also resin pre-sealed, which prepares them for better finish, protects against moisture, and improves dimensional stability. On order, Douglas fir doors are available Factri-fit—completely machined for locks and hinges.

All these features are covered by official inspection—assuring doors which meet every quality standard adopted by member factories of the Fir Door Institute.



One of these distinctive F.D.I. "grade trade-marks" appears on the bottom of every officially inspected Douglas fir door—and only on doors so inspected. Look for the F.D.I. seal. It is your symbol of fine craftsmanship, now backed by rigid manufacturing inspection.



FIR DOOR INSTITUTE

TACOMA BUILDING

TACOMA 2, WASHINGTON

THE NATIONAL ASSOCIATION OF

DOUGLAS FIR DOOR MANUFACTURERS

Rugged Strength



• This corner bar is one of several Pittco Metal members specially constructed to provide an insulated metal setting for Twindow, "Pittsburgh's" new window with built-in insulation. Its tubular construction gives sufficient strength and rigidity for most installations, but it may be strengthened with five different reinforcing members where extra support is required. And, like other Twindow settings, it can be used with Pittco De Luxe frame mouldings. This combination of strength and beauty makes Twindow available for a wide range of store front installations.

Pittco Store Front Metal settings for Twindow are produced by the extruded process to provide strength, sharp profiles and a rich, smooth finish. With Pittco Metal, setting operations proceed rapidly. No special tools are required, and setting procedures are so simple that a substantial saving in setting time is usually effected.

Twindow settings in Pittco Store Front Metal

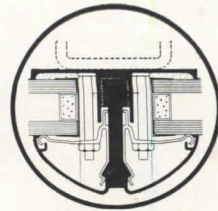
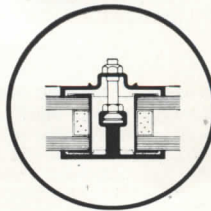
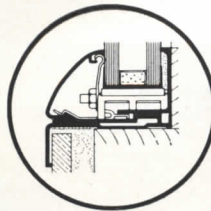
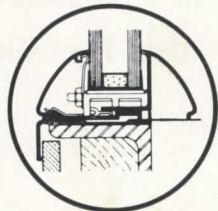
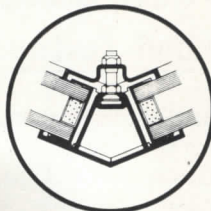
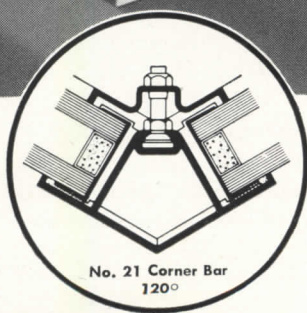

PITTCO

STORE FRONT METAL



PAINTS • GLASS • CHEMICALS • BRUSHES • PLASTICS

PITTSBURGH PLATE GLASS COMPANY

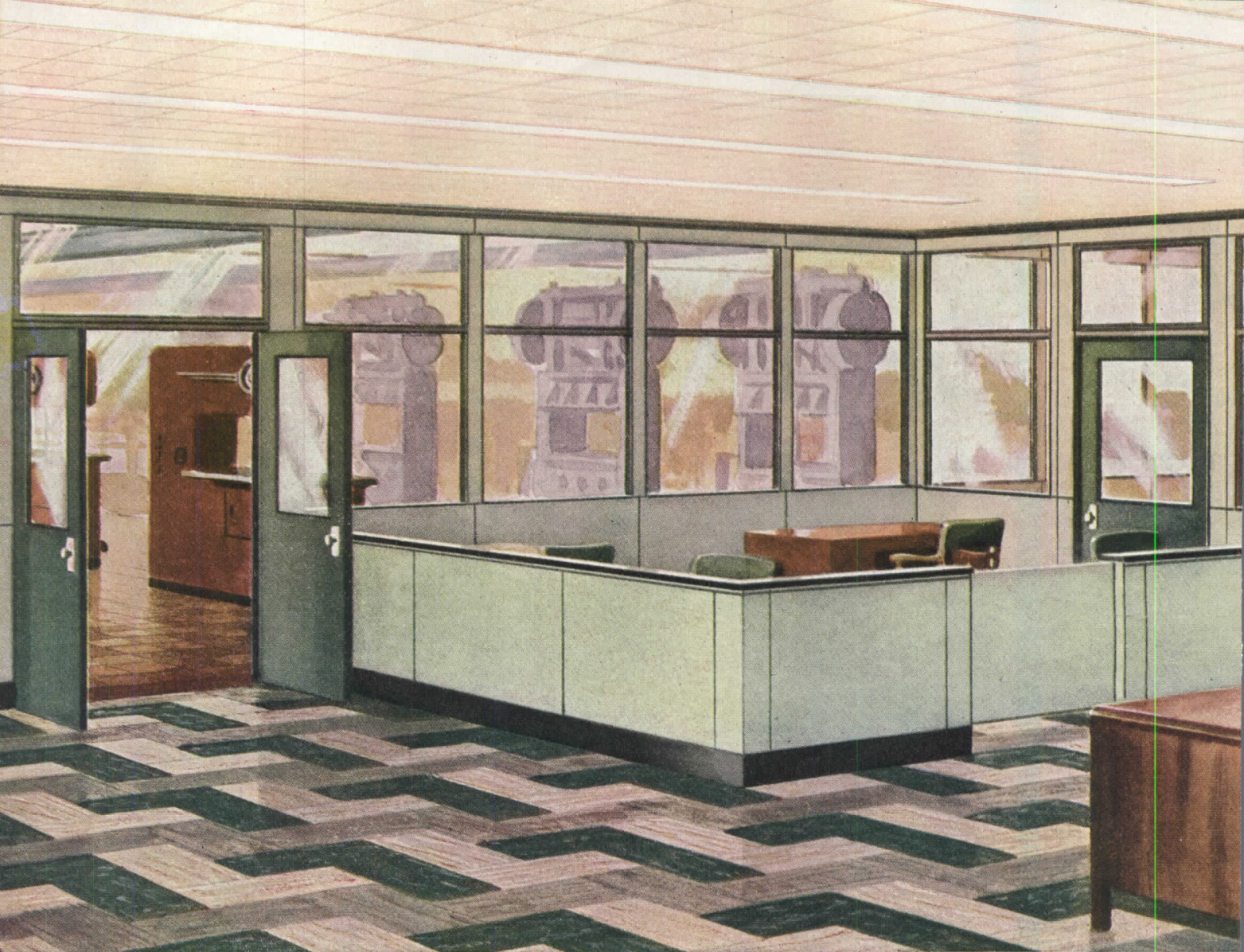

Use all 3 products—Walls, Ceilings, Floors— for Johns-Manville Unit Construction . . .

With this new method of interior construction, you can meet the problem of ever-changing space needs.

You can provide for endless revisions of space-use—at *low cost*. You can keep expanding, converting, or subdividing rooms as often as conditions require . . . with little or no interruption to routine activities!

Moreover, the J-M Unit Construction system now makes

the *complete interior* available under *one* specification, *one* manufacturer's responsibility.

Three Johns-Manville materials, described at right, are the basis of this revolutionary development. The asbestos Transite Walls are *movable*, 100% salvageable. The Acoustical Ceiling Units are *demountable* . . . can readily be taken down and re-located as desired. And the Asphalt Tile Floors consist of small units which permit easy extension of the floor to meet changing conditions.

Write for colorful brochure, giving full details on the remarkable *flexibility* of J-M Unit Construction.

Production of Johns-Manville Building Materials has now been greatly increased to meet unprecedented demands. So the chances are better than ever that you can get the materials you want when you want them. Write Johns-Manville, Box 290, New York 16, N. Y.



Johns-Manville
Walls - Ceilings - Floors

. . . for Reception Lobbies and Stores

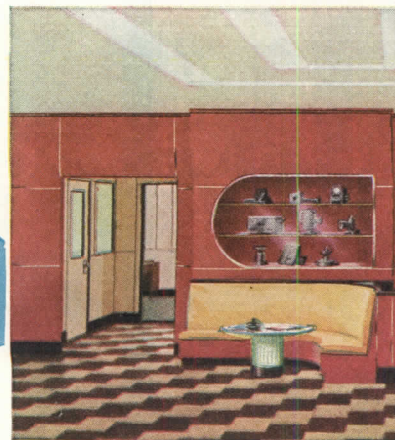

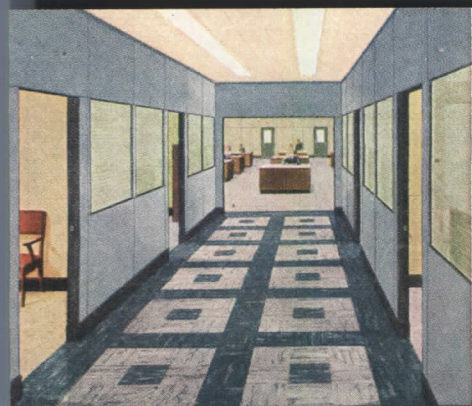

... for Institutions and Hospitals

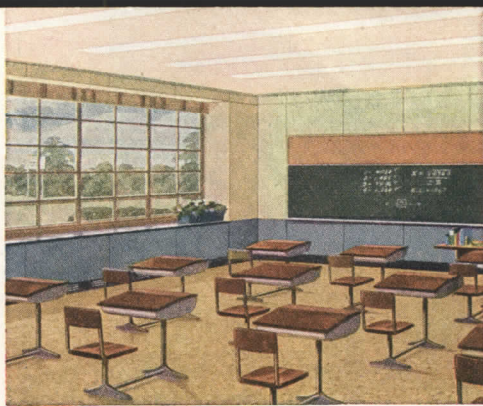

... for Schools



... for Factory Areas

Flexible Interiors that look to the future!

1. TRANSITE WALLS—*Movable!*

Rooms when and where you want them . . . that's the magic of Johns-Manville Transite Walls—the attractive and sturdy asbestos walls that are *movable*. Now you'll never again need to send partition walls to the dump every time space changes are required!

With the least inconvenience—almost *overnight*—you can enlarge, decrease, or rearrange areas as often

as your needs require. Transite movable panels are easy to handle, readily assembled, interchangeable, and can be used over and over again. Made of asbestos and cement, Transite Walls have all the qualities of solid and permanent construction. They provide rigid, double-faced partitions, and can also be used as the interior finish of outside walls.

To make sure your interiors will provide for *change*, write for booklet, "J-M Transite Movable Walls."

2. ACOUSTICAL CEILINGS—*Quieter!*

There's a Johns-Manville acoustical material to give you the best in sound control, no matter what the type of interior.

To assure you the maximum in noise-quieting, Johns-Manville not only provides the correct acoustical materials for each specific condition, but follows through by *installing* the materials *properly* with its own con-

struction crews. In other words, you get "J-M materials installed by Johns-Manville" for best results.

That's the all-inclusive service . . . the *undivided responsibility* Johns-Manville gives your projects.

For further details, send for brochure, "J-M Sound Control." Describes such J-M acoustical products as demountable Sanacoustic, Fibracoustic and Fibre-tone, Transite Acoustical Panels, and special materials for Broadcasting Studios.

3. ASPHALT TILE FLOORS—*Colorful!*

You spend no more to have *quality* floors like these—attractive and resilient . . . extra-long wearing . . . reinforced with indestructible asbestos!

That's the kind of flooring you get with Johns-Manville Asphalt Tile. It's easy on the eyes, easy on the feet, and easy on the budget, too.

Yes, you'll like *everything* about this modern floor-

ing, including the unlimited range of color combinations—from striking patterns with strong contrasts to solid fields of marbled colors.

J-M Asphalt Tile does not originate dust . . . stays fresh and unmarred with practically no maintenance. Individual units permit easy repairs.

For areas exposed to oil or grease, use J-M *Grease-proof* Asphalt Tile. Send for full-color brochure, "Ideas for Decorative Floors."

... for Offices



... for University Lecture Rooms

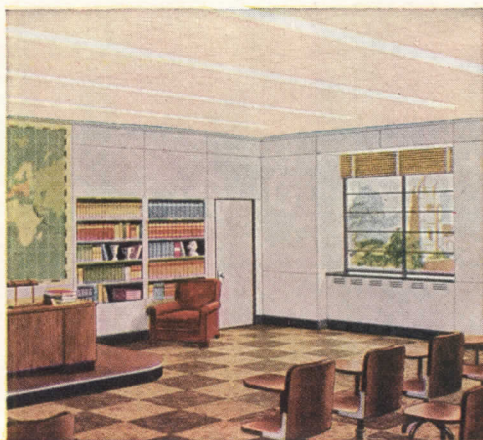

... for Laboratories

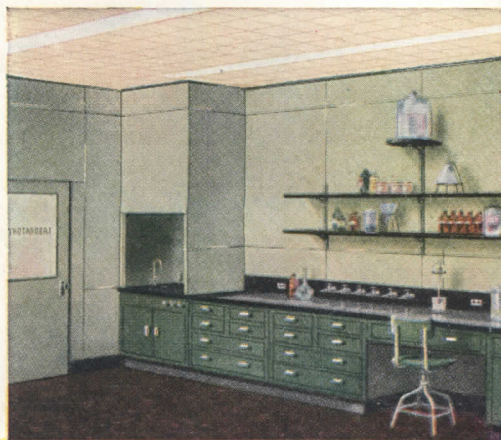

ENTERPRISE BURNERS . . . 3-time Choice!

IN CHURCH - AND SCHOOL

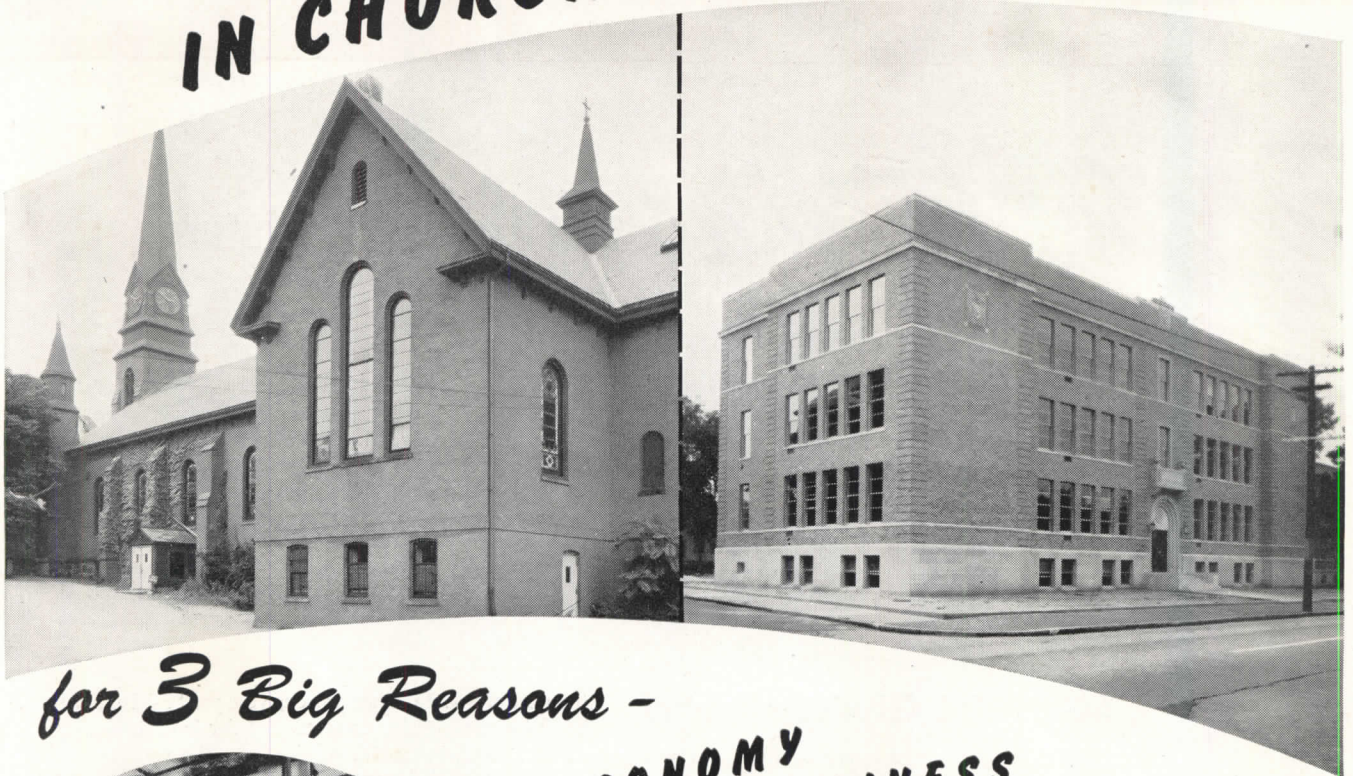

for 3 Big Reasons -

- ★ ECONOMY
- ★ CLEANLINESS
- ★ HEATING EFFICIENCY

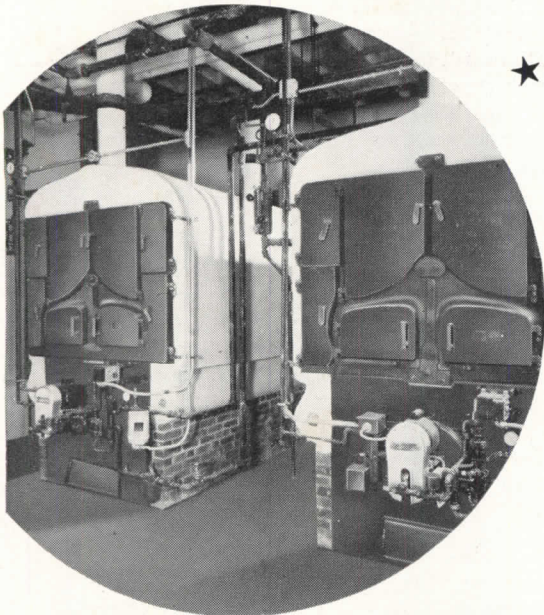

Pictured above are the two Enterprise model EP Oil Burners serving the Immaculate Conception School building. Developing 115 Boiler HP, these units are responsible for furnishing constant, uniform heat to 96,000 square feet of floor space. Installed by Enterprise Oil Burner Sales Co; Distributor, Enterprise Oil Burner Distributors, Boston, Mass.

One . . . two . . . three buildings at Immaculate Conception, Malden, Mass., have been equipped with modern Enterprise heavy-duty burners in the past two years! Highest satisfaction enjoyed in the first installation has made the choice Enterprise every time.

In churches and schools, colleges and universities throughout the land, Enterprise Burners have for years played an important role in providing clean, efficient heating at low cost. In Massachusetts alone, Enterprise counts among its many satisfied customers these outstanding institutions: Holy Cross College, Worcester; Notre Dame Academy, Tyngsboro; St. Anthony's, New Bedford; Boston College, Boston; St. Leo's, Leominster; Sacred Heart in Quincy.

For *your* next heating installation choose Enterprise Burners—choice of combustion experts everywhere. A wide range of sizes, in oil or combination gas-oil burning models.

ENTERPRISE Burners

COMBUSTION DIVISION OF
ENTERPRISE ENGINE & FOUNDRY CO.,
18TH AND FLORIDA STREETS
SAN FRANCISCO 10, CALIFORNIA

Distributors in Principal Cities

Plan to visit Booth Nos. 483-484
February 2-6, 1948



THIS
Frank Adam
 INSTALLATION

AFTER

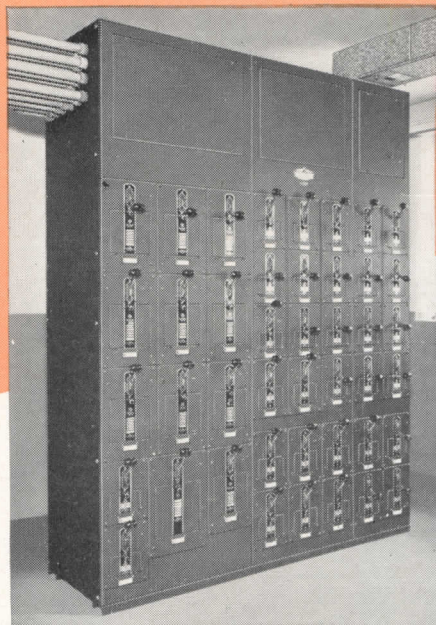

SOLVED MANY POWER PROBLEMS

Behind the attractive appearance of this new Ⓢ Shutbrak Switchboard is a host of features which added greatly to the safety, efficiency and operation of one company. It provided, for instance, a more compact unit with greater electrical capacity... greater operating efficiency with less maintenance... easier, faster and more positive switching with new heavy-duty Ⓢ Shutbrak Switches... safe operation with dead front, safety-type enclosure... safer

maintenance with fuses concealed behind doors that open only when switch is in "off" position... greater simplicity of maintenance due to accessibility and design... more efficient power transmission with High Efficiency Feeder Ⓢ Busduct carrying current from transformer station to switchboard with a minimum of voltage loss... and greater flexibility by providing for future additions when the need arises.

You'll solve these and many more power problems by including the Ⓢ Shutbrak Switchboard in your *new* electrical system. This heavy-duty, safety-type switchboard with quick make and break switches fitted with Ⓢ Kamklamp (pressure type) Fuseholders is available in a full range of capacities: 30 to 1200 amps., 250 volts, AC or DC; and 600 volts AC, 2, 3 and 4 poles. Consult your nearest Ⓢ Representative for details.

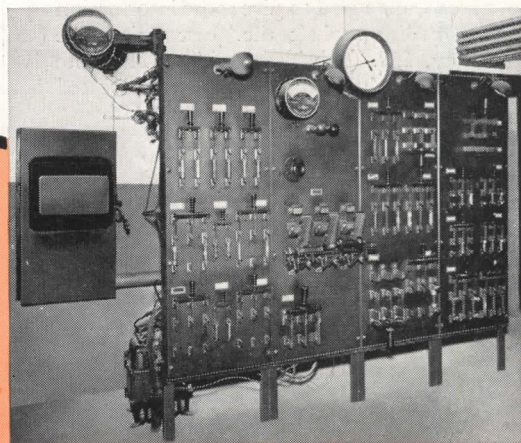

BEFORE



Frank Adam Electric Co.

ST. LOUIS 13, MISSOURI

Makers of BUSDUCT • PANELBOARDS • SWITCHBOARDS • SERVICE EQUIPMENT • SAFETY SWITCHES • LOAD CENTERS • QUIKHETER

*New Los Angeles Airport now ready
for heaviest air and foot traffic . . .*

**100,000 sq. ft. of
tough
TILE-TEX*
used in buildings
of modern air center**

Air traffic will be heavy at Los Angeles' bustling new airport! But patrons of six major airlines are assured of better, faster ticket and baggage service—more comfortable "between flight" facilities await them—in these carefully designed, modern air terminals.

Yes, and even the floors are ready—come what may—as more and more of today's travelers take to the air! For Architect N. M. Cirino specified tough, versatile, immensely practical Tile-*Tex* Asphalt Tile for the passenger terminals and the administration building!

That's easy to understand—because Tile-*Tex* easily fills the exacting requirements for a "public" floor. It's so tough it lasts for years under the hardest use imaginable! Is low in first cost—costs less and less as time goes on—doesn't require elaborate maintenance! Available now in a rich group of colors and design accessories to assure architects of providing the *right* floor for every installation.

The Tile-*Tex* field representative and flooring contractor in your area will be glad to give more information about this top quality asphalt tile. Just write The Tile-*Tex* Company, Inc. (Subsidiary of The Flintkote Company), Chicago Heights, Illinois. Sales Offices located in Chicago, New York, Los Angeles and New Orleans.



*One of three new passenger terminals at the Los Angeles Airport. All floor areas are surfaced with foot-easy Tile-*Tex* Asphalt Tile.*

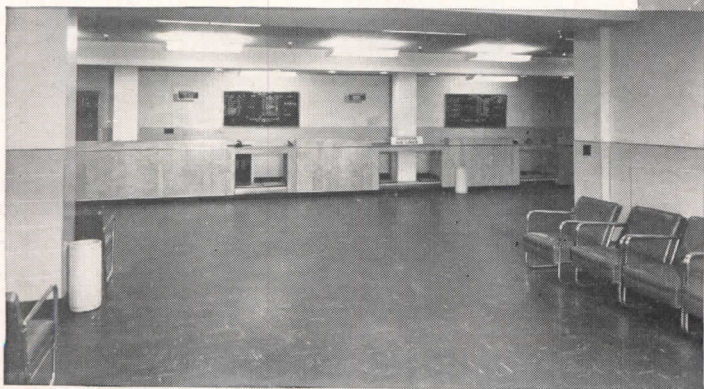

*The new Los Angeles Airport was designed by N. M. Cirino, Architect for the Bureau of Engineering, City of Los Angeles. Notice (above) how all the facilities for handling busy air travelers have been compactly arranged for maximum customer convenience. Notice, too, that the brown Tile-*Tex* floor is marbled so dust is less noticeable, maintenance is cut to a minimum.*

*Comfortably resilient Tile-*Tex* and the acoustical ceiling team up (left) to lessen noise and confusion in this busy terminal.*



Tile-*Tex* Asphalt Tile

*REGISTERED TRADEMARK OF THE TILE-*TEX* COMPANY, INC.

*Roll out
the Carpet
for an
Old Friend..*

CASTELL

the Drawing Pencil of the Masters

It's the most exciting news in eight years. CASTELL is back in all its incomparable quality. CASTELL, milled according to the secret micrometric process of Old World Craftsmen, whose cumulative experience goes back to 1761.

When you again get a CASTELL in your fingers you will instantly recognize its tangible superiorities . . . in smoothness, graphite adhesion, controlled tone, needlepoint sharpness without point breakage and 7B softness without flake or crumble.

You will say, "It's easy to see why CASTELL is the world's finest drawing pencil!"

Despite increased prices on almost everything else, CASTELL is still sold at the old pre-war price of

15c each . . less in quantities
18 superlative degrees . . .
... 7B to 9H



AW. FABER-CASTELL
PENCIL COMPANY INC. NEWARK 4, N.J.

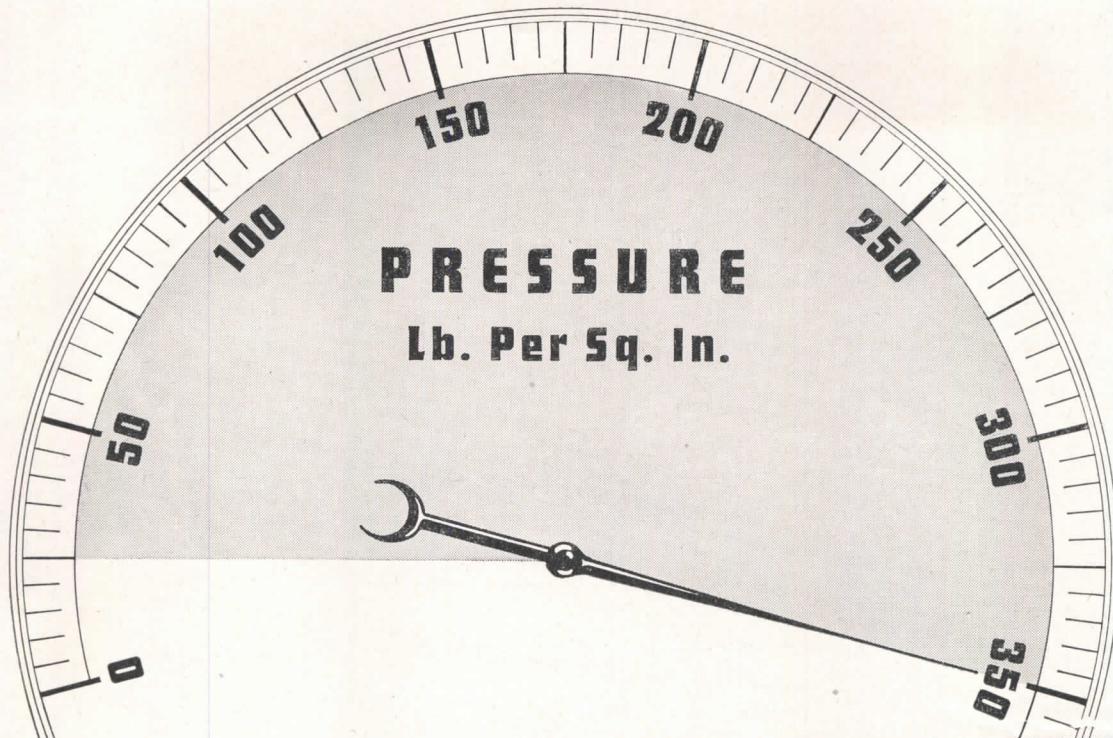

Aerofin is sold only by manufacturers of nationally advertised fan system apparatus. List on request.

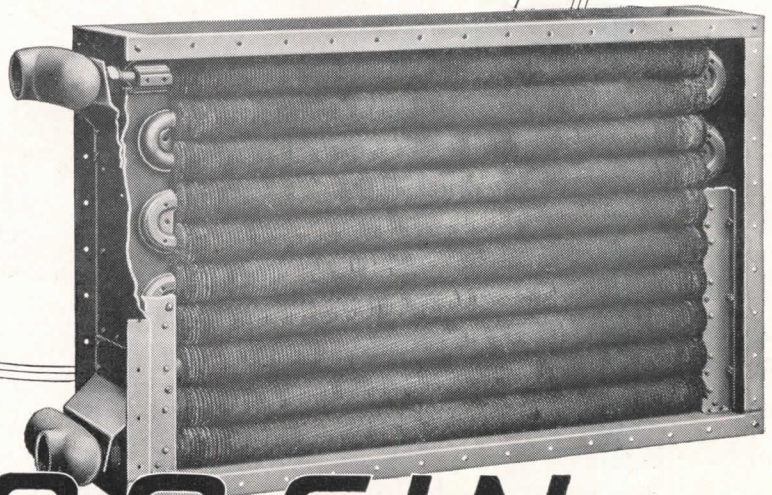

AEROFIN

HEAVY DUTY HEATING COILS

Types for all Applications

- NON-FREEZE for entering air. Non-freezing, non-stratifying.
- FLEXITUBE absorbs expansion and contraction strains.
- UNIVERSAL incorporates S-bends with steel headers.
- NARROW WIDTH, straight tube for water cooling or flooded Freon systems.
- CONTINUOUS TUBE for cooling air with cold water.
- CLEANABLE TUBE with easily removed headers.
- DIRECT EXPANSION, centrifugal header type, for Freon expanded directly into coil.

Specially designed for use where extra-rugged coil is needed for close control. Continuous tube type. Operating pressure 25 to 350 p.s.i., temperature up to 350° F. Pressed steel headers, heavy copper tubing and fins, galvanized-iron casings. Highly efficient. Fast heating. Compact. Write for complete ratings and specifications.

AEROFIN CORPORATION

410 South Geddes St., Syracuse 1, N. Y.

NEW YORK • CHICAGO • CLEVELAND • DETROIT • PHILADELPHIA • DALLAS • MONTREAL

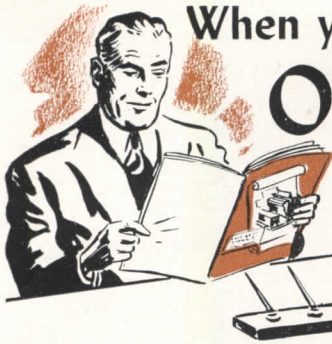

When your plans include an

ORGAN INSTALLATION...

You'll find this Reference Manual most helpful and informative. A copy is yours for the asking!

A 16-page brochure covering features you must look for in any organ you specify: organ nomenclature; American Guild of Organists' playing specifications; relationship of tone, space and cost; acoustics; pipe organ vs. electronic organ; essential and auxiliary equipment; installation requirements and techniques.



you benefit by providing MORE COMPLETE FACILITIES

because of space saved by a

WURLITZER ORGAN
Series 20 Two-Manual

● When you compare the 600 to 11,500 cubic feet that are generally necessary to house a pipe organ to the 98 cubic feet required for a Wurlitzer Organ, it immediately becomes apparent that here is a saving of space that can be utilized for many additional facilities. In churches, for instance...extra seating capacity, a Pastor's study, a Sunday school room, recreation center or kitchen are all desirable church features you can recommend, if you include the space-saving, money-saving Wurlitzer Organ in your plans. In other types of buildings, the important space-saving features of the Wurlitzer Organ make possible the inclusion of many other equally important features.

Remember, too, that the Wurlitzer provides true church tone and that it does so at a cost that is within the reach of all.

On every count . . . Tone, Space and Cost, specify with confidence the Wurlitzer Organ. Organ Division, The Rudolph Wurlitzer Co., North Tonawanda, New York.

In churches, for instance, the Wurlitzer Organ saves enough space for you to provide these extra facilities



THE RUDOLPH WURLITZER CO.
N. Tonawanda N. Y., Dept. AR 1

Gentlemen:

Please send me, without obligation, your 16-page Reference Manual..."Important Facts On Organs And Their Installation."

Name

Company

Address

City.....Zone.....State.....

H & H

Multicoupler Antenna System

Improved ALL-WAVE

• Frequency Modulation (FM)

• Standard Broadcast • Short Wave

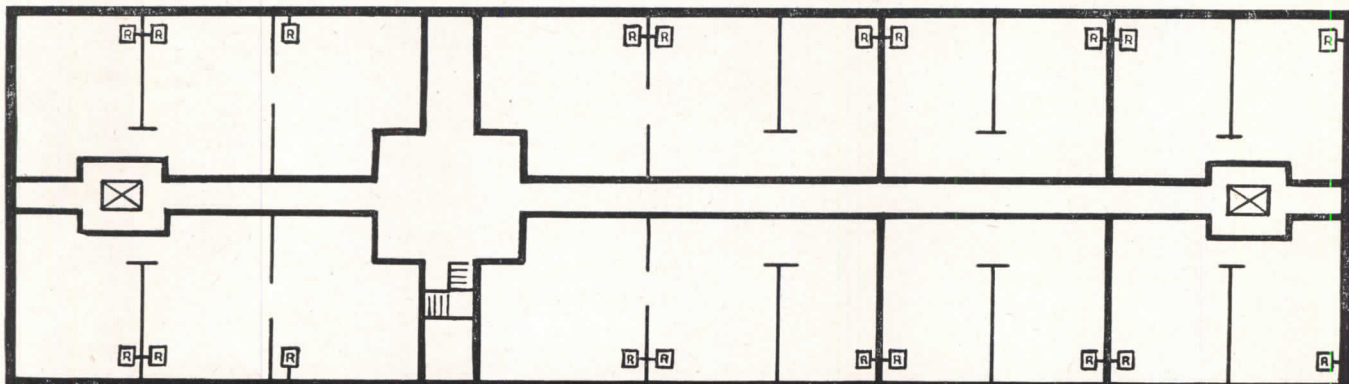

1 Aerial for Plurality of Radio Sets

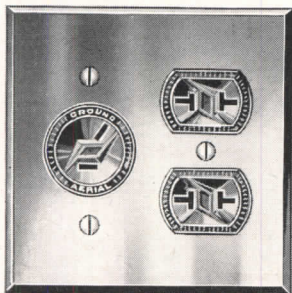

No. 3120

2 Gang Unit

1 Radio and 2 Power

Outlets Complete, — consisting of Two Gang Multicoupler Unit, 2 Gang Cover with Divider Plate, No. 1913 Duplex Convenience Outlet, No. 2149 Radio Outlet, GH Cap, Multicoupler, 2 Gang .040" Brass Plate . . . Use standard 4" square box (not included).



No. 3124

1 Gang Unit

Radio Outlet Only

Complete, — consisting of Single Radio Outlet Multicoupler, No. 2149 Radio Outlet, GH Cap, Multicoupler, 1 Gang .040" Brass Plate . . . Standard switch or outlet box can be used (box not included).

Up to 20 radio outlets may be serviced from *one* antenna where this multiple receiving system is installed. The system brings to each radio set complete "freedom of the air" in getting any desired broadcast, regardless of what programs other sets may be tuned to at the same time. It brings in FM, standard broadcast and short waves with maximum of volume and minimum interference.

Multicoupler-Antenna System is not only the *most adaptable* to the whole range of radio conditions; it's the least expensive and most easily installed of any multiple receiving system. For apartment houses, private homes or hotels, hospitals and dormitories, this system economically *completes* your up-to-date radio facilities.

DISTRIBUTED THROUGH ELECTRICAL WHOLESALERS

HART & HEGEMAN DIVISION

THE ARROW-HART & HEGEMAN ELECTRIC COMPANY, HARTFORD 1, CONN., U.S.A.



Now...

PRACTICAL, SOUND CONSTRUCTION
for **DRAMATIC OPEN DISPLAY**



CREATED BY BRASCO to enlarge the possibilities of full-visibility design, Safety-Set Construction permits new freedom of personal expression in store fronts of character and distinction. It provides improved structural and safety features for special architectural requirements such as height-ened areas and larger glass loads.

In addition to an unusually wide variety of attractive sash and sill combinations, Safety-Set's lowered sash height insures greatest visibility. For sound structural strength, heavier gauges in all sections plus stronger steel reinforcements. For improved safety, FINGERTIP SETTING, exclusive with Brasco, which entirely eliminates screws and other pressure devices and provides maximum glass protection.

Safety-Set installations require stock millwork only, effecting substantial savings in time and material. As with all Brasco Construction, it is available in both stainless steel and anodized aluminum. Our new illustrated catalog includes descriptive material and quarter-size details. Clip and mail the attached coupon for your copy.

★ A COMPLETE LINE FOR EVERY DESIGN ★

BRASCO MANUFACTURING CO.
HARVEY • (Chicago Suburb) • ILLINOIS



*For your free copy
pin coupon to letterhead
and mail promptly - - -*

BRASCO MANUFACTURING CO., HARVEY, ILL.

Please send CATALOG 48R
to the attention of —

Name _____

Insulux makes daylight go to work for you!



Ground to roof facade of Allen B. Wrisley Company, Chicago, has continuous panels of Insulux Prismatic Glass Block. Three face patterns and approximately 4500 glass blocks provide the ultimate in daylighting this modern and progressive plant. Architects: Fugard, Burt and Wilkinson, Chicago Ill.



Insulux Prismatic Glass Block turns light to ceiling for re-direction into this second-floor display room. Drapes over windows can be entirely drawn without loss of daylight in room. Same type panels give fine working light in factory areas.

Put light to work on all your jobs by specifying Insulux Glass Block—wherever functional daylighting is desired.

Prominent architects are finding more new and ingenious uses for Insulux every day. This functional building material has become the architects' right-hand man in helping to solve all kinds of daylighting problems. Perhaps it can help you, too!

For instance: Insulux daylight interiors and promotes privacy. It is fireproof and noncombustible, requires no painting and little maintenance. Its high insulating value helps cut heat loss in winter and heat gain in summer. Insulux adds light to usually dark corners . . . *is functional as well as distinctive!*

The Wrisley Company's new Chicago plant has used Insulux extensively for several reasons, all good: Insulux adds beauty, grace and simplicity to interiors and exteriors . . . improves working conditions with better lighting . . . costs little to maintain.

For complete technical data, specifications and installation details, see the "Glass" section of Sweet's Architectural Catalog, or write Dept. E-2, Owens-Illinois Glass Company, Insulux Products Division, Toledo 1, Ohio.

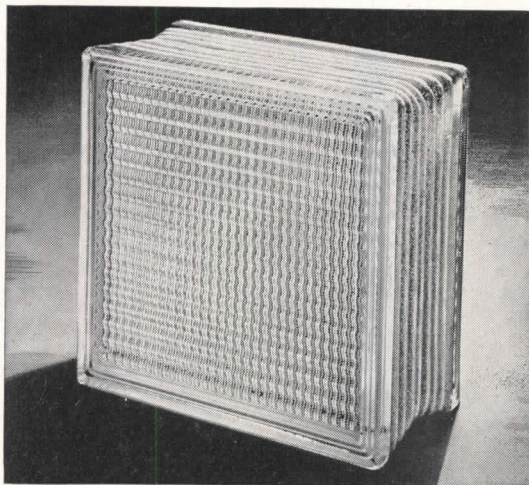

OWENS - ILLINOIS
INSULUX
GLASS BLOCK

Insulux is made in three sizes—many attractive and functional patterns. Investigate this modern material that has solved many complex daylighting problems.

Mark!^E



MAKE THE SEASONS
COME TO YOU

IT'S THE SIGN OF

The Real *McQuay*

McQUAY, INC., MINNEAPOLIS, MINNESOTA • HEATING, AIR CONDITIONING & REFRIGERATION

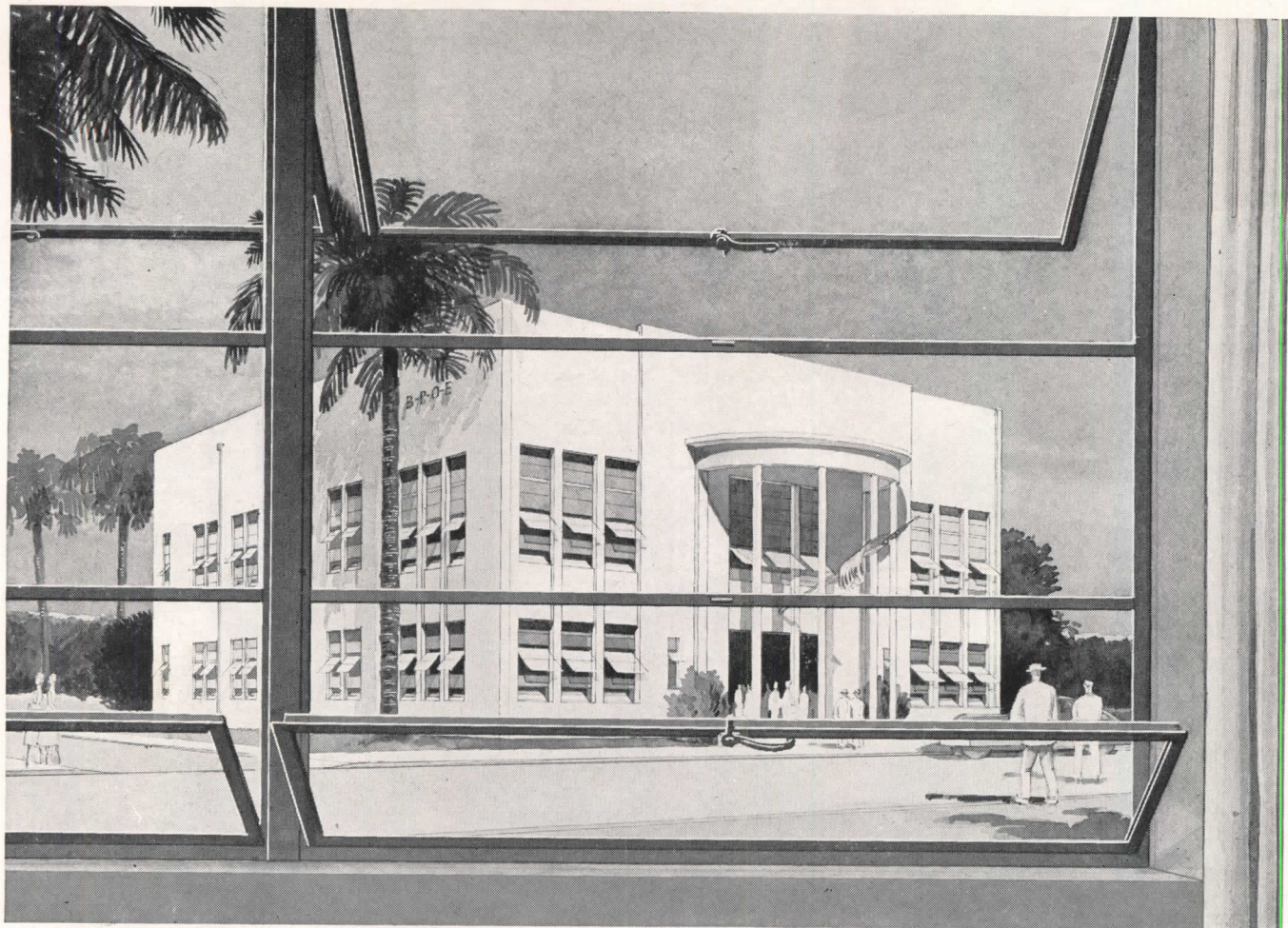

Coral Gables B.P.O.E. Club, Florida. Architect: Edward T. Rempe, Jr. General Contractor: The Mackle Company

See how Lupton Metal Windows say "welcome" to the great outdoors. Narrow frames lend themselves to contemporary design. Combination of outswinging and inswinging panels assures controlled, natural ventilation. Screens with neat, unobtrusive frames are easily attached from inside the building. Lupton Metal Windows are ideal for any climate. Admit maximum daylight. Provide permanent weathertightness. Made for every type of building—industrial, commercial, residential. Write for our Catalog or see it in Sweet's.

MICHAEL FLYNN MANUFACTURING CO.
700 East Godfrey Avenue, Philadelphia 24, Penna.
Member of the Metal Window Institute

LUPTON METAL WINDOWS



"Here's my plan—
for greater year-'round efficiency
and the protection of steel!"

WHEN you plan for Ferro-Therm Steel Insulation, you give a building insulation that has advantages over all other material.

Makes Heat "Bounce" Off

Ferro-Therm is a sheet of alloy-coated steel that *reflects 90-95% of all radiant heat*. During the winter, it reflects heat *into* the building — saving up to 25% in fuel. During the summer it reflects heat *away* from the structure — reducing inside temperatures 10° to 12°.

Steel — for Lasting Protection

Because Ferro-Therm is *steel*, (1) it cannot be penetrated by rodents, insects or termites; (2) it does not absorb moisture, thus reducing the danger of rot to framing members; (3) it is odorless and cannot hold odors; (4) it acts as a definite fire barrier.

Install Ferro-Therm — and get the advantages that only this *steel* insulation can give you . . . insulation that is so thin and light that it is easier to transport, handle and install . . . insulation that can be stapled securely in place for lasting insulation value. Mail the coupon now for details.

Men who know insulation say "Ferro-Therm"



American Flange & Manufacturing Co. Inc.
Ferro-Therm Division • Dept. AR 1 • 30 Rockefeller Plaza, New York 20,
New York

Please send me without obligation, complete information on Ferro-Therm
Steel Insulation — commercial; residential.

Name

Firm

Street

City State



In every room... in every season

A Choice of Weather with

Flexible  Air Conditioning System

THERE'S NO DISPUTING about comfort...when you put G-E Personal Weather Control in every room. A flick of a switch or thermostat gives the desired temperature.

This versatile equipment is designed—not for one arbitrary system—but for *many* systems, to meet the wide variety of conditions encountered in the air conditioning of multi-room buildings.

In addition to individual weather control for every room, consider these other important advantages of General Electric Systems. The amount of ventilation air can be adjusted to meet the need in each space—

the room units can provide positive control of ventilation air. *All* the air handled by the units, both ventilation air and room air, must pass through the filter. This means cleaner air, less cleaning of the units themselves and easier maintenance.

There's a General Electric system for *every* type of multi-room or single space installation. Your local G-E air conditioning specialist will be glad to work with you in planning the proper system for any job. *General Electric Company, Air Conditioning Department. Section 84401, Bloomfield, New Jersey.*

GENERAL  ELECTRIC
Better Air Conditioning

Everything

YOU NEED TO KNOW ABOUT
DRAINS AND PLUMBING DRAINAGE PRODUCTS

IS IN THE
NEW JOSAM CATALOG "J"

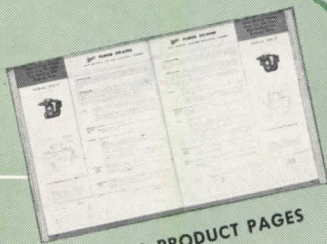

TYPICAL PRODUCT PAGES

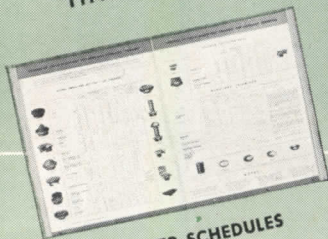

STRAINER SCHEDULES

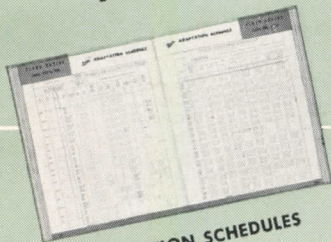

ADAPTATION SCHEDULES

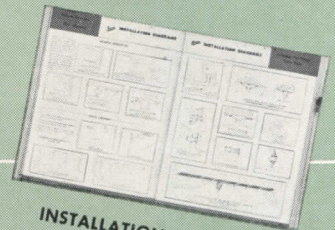
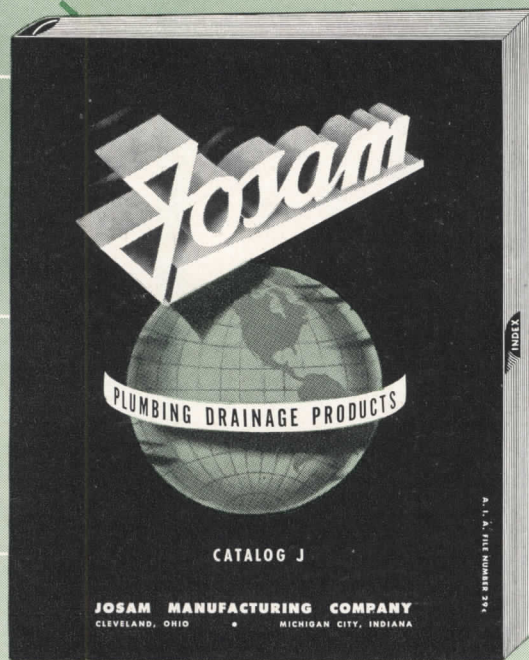

INSTALLATION DIAGRAMS

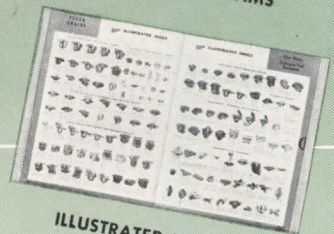

ILLUSTRATED INDEXES

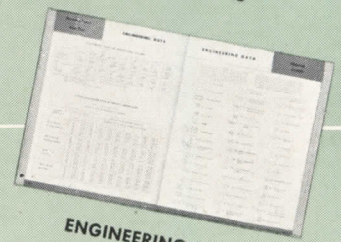

ENGINEERING DATA

The new Josam Catalog "J" is the greatest catalog of information on drains and plumbing drainage products ever issued. You would expect this catalog to go far beyond the data provided by the ordinary catalog...and it does! It's the new encyclopedia...the new source of authoritative information on plumbing drainage products. It contains everything you need to know about the proper selection, application and specification of drains and drainage products for all types of buildings.

252 pages, containing hundreds of different products, are coordinated and indexed to give you desired infor-

mation instantly. Illustrated, numerical and alphabetical indexes as well as adaptation schedules enable you to find the exact product and the exact style you need quickly and without question.

The Josam Catalog "J" not only covers all types of drains, interceptors, backwater valves, swimming pool equipment, shock absorbers, shower mixing valves but many other products. It will be a valuable reference book to anyone who specifies, orders or installs plumbing drainage products. It is free upon request to anyone in the industry. Send for your copy of the Josam Catalog "J" today! You'll be amazed at its contents!

JOSAM MANUFACTURING COMPANY

General Offices, Ferguson Bldg., Cleveland 14, Ohio • Plant, Michigan City, Ind.
Representatives in all Principal Cities



See our Catalog in Sweets'.

JOSAM-PACIFIC CO., San Francisco, California
West Coast Distributors

EMPIRE BRASS COMPANY, LTD., London, Ontario
Canadian Distributors

Member of the Producer's Council

JOSAM MFG. CO., 302 FERGUSON BUILDING, CLEVELAND 14, OHIO
PLEASE SEND ME NEW JOSAM CATALOG "J".

YOUR NAME
YOUR OCCUPATION
FIRM NAME
ADDRESS
CITY AND STATE

There's insulation and there's INSULATION!

Many new homeowners boast that their places are insulated... then get a terrific let-down when they learn that the insulation has been installed so thin that they will get only a fraction of the benefits that home insulation can provide.

That's why we have emphasized two important features about insulation in the ad shown below. In the name of good construction we believe that you will subscribe to these recommended specifications.

NATIONAL GYPSUM COMPANY, BUFFALO 2, N. Y.

(Appearing in full color in the February 21st issue of The Saturday Evening Post.)

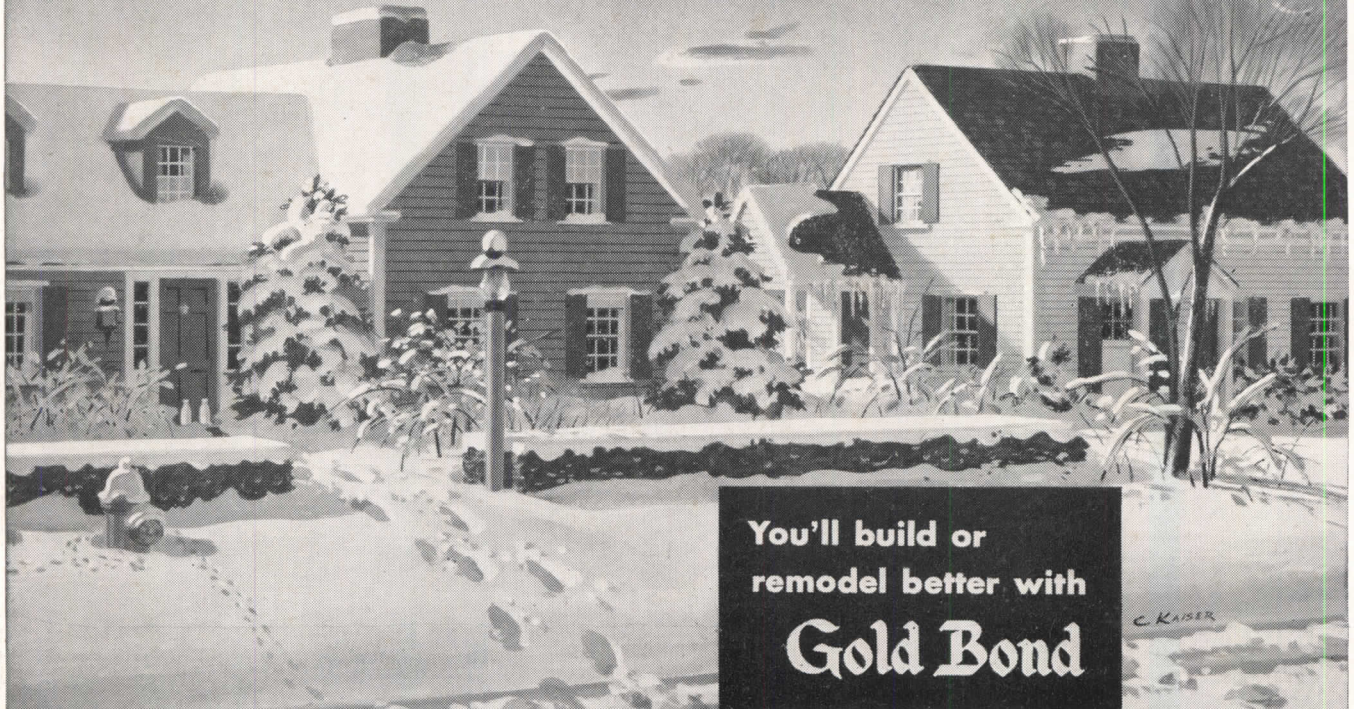

For the newest in building and remodeling products, see your local Gold Bond dealer first.

Puzzle: which house costs less to heat?

The house on the left costs a lot less to heat—the one with the snow on the roof. The snow is still there because this house is insulated with Fireproof Gold Bond Rock Wool. Furnace heat is kept inside instead of leaking through the roof to melt the snow. Heating costs are cut as much as 40%.

Naturally you'll want your new home insulated. But don't make the mistake of just saying you want "insulation". That's like going to the butcher and asking for a pound of meat—any meat. It will pay you to remember two points about insulation:

1. Specify Fireproof Gold Bond Rock Wool. This National Gypsum product is not just "fire-resistant", not just "fire-retarding" but as fire-proof as the rock from which it is made.

2. Specify that you want full thick insulation—not 1 inch or 2 inches thick but full thick. With full thick insulation you get the full benefit that home insulation can and should provide. And because it completely fills the wall, only full thick insulation provides an effective fire stop.

Insulation is the one modern home improvement that pays for itself by reducing heating costs as much as 40% every year. Then during the summer it keeps rooms 8° to 15° cooler. The resale value of the house is automatically increased.

Old homes, too, can be insulated the Gold Bond way. Call your local Gold Bond applicator for a free estimate. He is listed in the phone directory under "Insulation". The easy payments will be

amazingly small because your fuel bills go down immediately.

Gold Bond Rock Wool insulation is only one of over 150 Gold Bond Products—engineered to help you build or remodel better at no extra cost. Included are Gypsum Lath, Plaster, Lime, Sheathing, Metal Lath, Insulation, Wallboard, Acoustical Products and Sunflex, the one-hour wall paint.

Your local Gold Bond lumber and building material dealer is headquarters for all that's new in building products. See him first!

NATIONAL GYPSUM COMPANY
BUFFALO 2, NEW YORK

Gold Bond Building Products add greater fire protection, permanency, and beauty at no extra cost. These include fireproof wallboard, lath, plaster, lime, sheathing, wall paint, insulation, metal and sound control products.

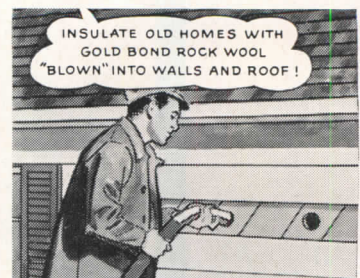

THE SIMPLEST and SOFTEST CLOSING VALVE KNOWN
 IS NOW FEATURED IN THE NEW *Salter* PRESTIGE
*Feather Touch** **FIXTURE LINE**

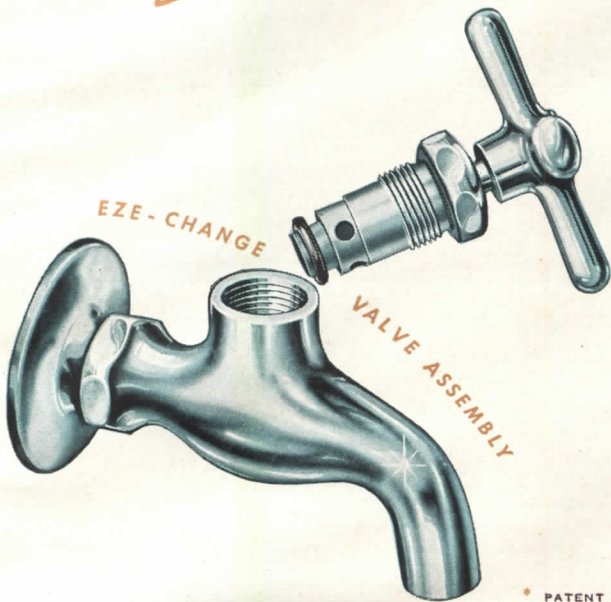

Salter advanced design and engineering is again "out-in-front" with today's simplest and most fool-proof plumbing fixture valve. Just remove the streamlined cap—and there's the works! Two patented "O" rings replace conventional metal seats, washers, and packing. These wear resisting rings slide on a precision machined, polished and chrome plated one piece stem. A minimum of friction makes possible fingertip, soft Feather Touch closing which cannot be found in any other valve. The stem wipes clean as it closes to provide unprecedented drip-proof service. Laboratory tests have opened and closed faucets equal to 20 years service and they're still operating perfectly. Start specifying Salter Masterpiece Fixtures today, and learn for yourself, how your clients appreciate the extra service and appearance obtained at costs comparable with most regular fixtures. Our new catalog is yours for the asking.

H. B. *Salter* MFG. CO., MARYSVILLE, OHIO
 and Division **THE GLAUBER BRASS MFG. CO., Kinsman, Ohio**

* PATENT PENDING, H. B. SALTER MFG. CO., MARYSVILLE, OHIO



Salter Feather Touch Fixtures are currently being introduced to architects, plumbers, builders and home owners as well, through advertising in **BETTER HOMES and GARDENS, AMERICAN HOME, HOUSE BEAUTIFUL, HOUSE and GARDEN** which is in addition to advertisements appearing in all leading plumbing, building and architectural trade papers.

A Great New Escalator

AT A NEW LOW PRICE!

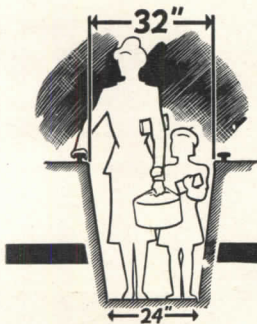

WIDE ENOUGH for adult and child—or traveler and luggage. The new Otis “32” carries 5000 people an hour comfortably. It is designed for any vertical rise up to 23 feet.

It's big in capacity
It's Otis throughout

HERE NOW — the new Otis “32”, designed especially for the medium-sized and smaller building. The result of many years' research, this modern Escalator has all the time-tested features of earlier models, plus a wealth of post-war design features . . . it is truly the last word in Escalator design.

SAFETY FEATURES include narrow-gage metal treads, semi-circular extended newels, continuous pinch-proof rubber hand rails . . . the world's safest transportation.

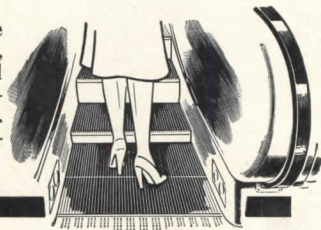

Capable of carrying 5000 people an hour, the Otis “32” handles more persons per dollar investment than any other moving stairway. Wide enough to comfortably carry an adult and child on one step, it is the ideal size for most stores, stations, plants, banks and other public buildings. Yet for all its spaciousness, the “32” requires less space and structural work than narrower moving stairways.

Best of all there has been no compromise with quality. In eye-appeal, in safety, in the inherent ruggedness that makes for long life and low upkeep, the new “32” is the equal of any Escalator we ever built. And remember, only Otis makes Escalators.

NEW FREE BULLETIN B-700F tells the whole story. Write for your copy to Otis Elevator Company, 260 Eleventh Avenue, New York 1, N. Y.

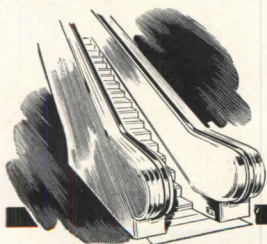

A LIFETIME OF BEAUTY. The modern Escalator's graceful lines and gleaming aluminum balustrade combine to give buildings the New Look in level-to-level travel.

“Escalator” is a U. S. Patent Office registered trademark of the Otis Elevator Company. Only Otis makes Escalators.



ELEVATOR COMPANY

Offices in All Principal Cities

X-ray planning

for every hospital situation

Now in preparation: a new series of Picker handbooks to meet *specific* x-ray department planning problems . . . smaller hospitals, community health centers, sanatoria, etc. to be constructed under the Hill-Burton Act Hospital Construction Program. Based on hospital planning material published by the Hospital Facilities Division of the U.S.P.H.S., they get right down to brass tacks, give approved layouts, pertinent facts and figures.

We offer any or all of them to you as a complimentary part of Picker service-to-architects. And feel free to call upon us for help when your next hospital project comes up: you'll enlist the co-operation of an organization with a half-century of experience in the *manufacture* of fine x-ray apparatus, and in the *planning* of efficient working layouts to complement it.

There are Picker offices in principal cities, with trained x-ray engineers ready to serve you.

Picker

PICKER X-RAY CORPORATION

300 Fourth Avenue, N. Y. 10, N. Y.

I'd like to have the following handbooks (please check):

- | | |
|--|---|
| <input type="checkbox"/> Master Handbook for Hospital X-ray Planning | <input type="checkbox"/> 100 bed T. B. Hospital |
| <input type="checkbox"/> 8-10 bed Community Clinic | <input type="checkbox"/> 150-200 bed General Hospital |
| <input type="checkbox"/> 25-40 bed General Hospital | <input type="checkbox"/> Type "A" Health Center |
| <input type="checkbox"/> 40-50 bed General Hospital | <input type="checkbox"/> Type "B" Health Center |
| <input type="checkbox"/> 50-75 bed General Hospital | <input type="checkbox"/> Type "C" Health Center |
| <input type="checkbox"/> 100 bed General Hospital | <input type="checkbox"/> 400 bed T. B. Hospital |

NAME _____

ADDRESS _____

CITY _____ STATE _____

The handbooks present typical approved x-ray layouts, space requirements, equipment descriptions, wiring specifications, costs, and similar technical data. The edition will be limited: use the coupon here to reserve your copies.

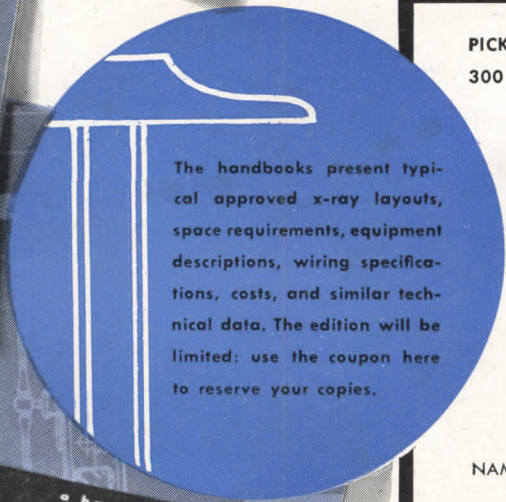

Schmidt, Garden & Erikson design a factory

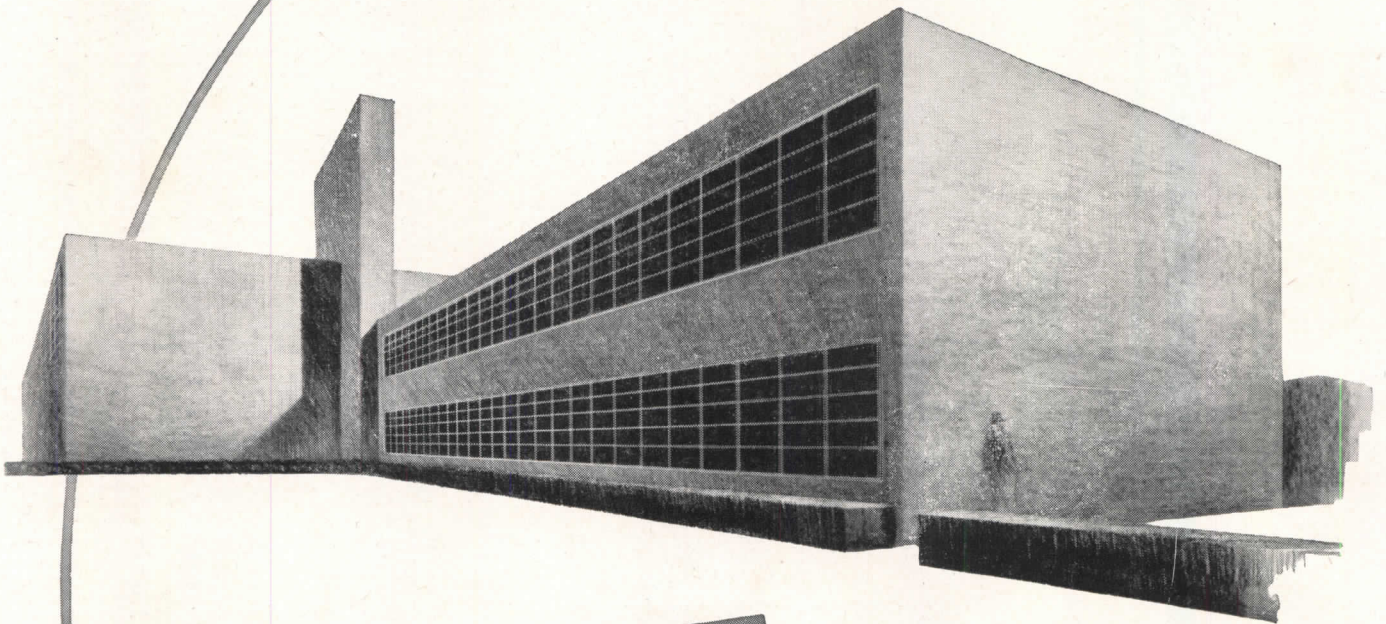

Mesker Steel Windows

“Fulfilling all demands for adequate daylighting and ventilation, steel windows additionally offer a satisfyingly simple decorative treatment for modern industrial plants.”

Designed and delineated by
R. Vale Faro
Schmidt, Garden & Erikson
Architects & Engineers
Chicago



For your copy of the Mesker Book of Industrial Windows, write to Mesker Brothers, 4338 Geraldine, Saint Louis 15, Missouri

STEEL DECK . . .



INSULATED STEEL WALLS

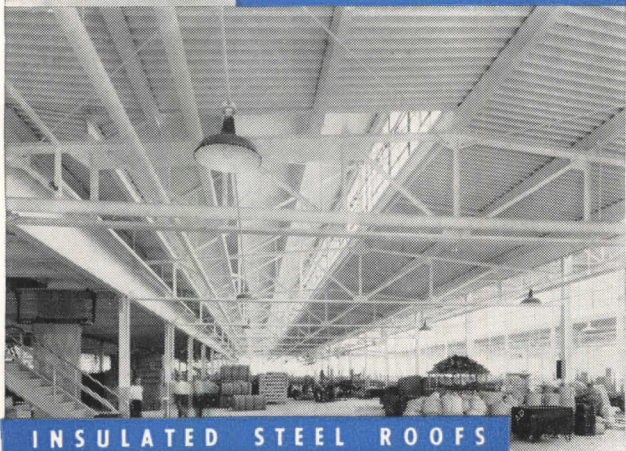

INSULATED STEEL ROOFS



REINFORCED CONCRETE FLOORS

for WALLS, ROOFS FLOORS and PARTITIONS

In modern construction today, Steel Deck continues to prove its versatility in all types of industrial and commercial building. It is extensively employed by many of the country's leading architects and construction companies for Walls, Roofs, Floors, Ceilings and Partitions . . . complete plants have been constructed with insulated exterior walls and roofs of this material. Concrete floors, in multiple story buildings, are also economically constructed with Steel Deck serving as permanent concrete floor forms. See Mahon Inserts in Sweet's File for complete information, or call in a Mahon representative.

You will find that Mahon Steel Deck, due to its basic design, lends itself to a broader range of uses in modern construction.

THE R. C. MAHON COMPANY

HOME OFFICE and PLANT, Detroit 11, Michigan • WESTERN SALES DIVISION, Chicago 4, Illinois

Representatives in all Principal Cities

Manufacturers of Steel Deck for Roofs, Sidewalls, Ceilings, Floors, Partitions and Doors. Also Roof Sumps and Recesses, Rolling Steel Doors, Grilles, and Underwriters' Labeled Rolling Steel Doors and Fire Shutters.

MAHON

THRUSH

FORCED CIRCULATING FLOW CONTROL SYSTEM

COMPLETELY
AUTOMATIC

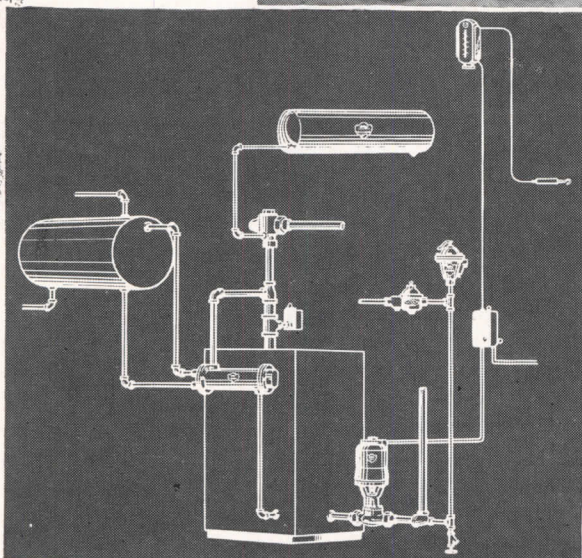

FOR REAL
HEATING
COMFORT

Thrush Flow Control System provides completely automatic home heating comfort plus year around domestic water supply for kitchen, laundry and bath from one boiler.

YOUR customers will thank you for recommending and installing Forced Circulating Thrush Flow Control System of Hot Water Heat. If panel heating is used, this system provides continuous radiant heat *without* continuous Circulator operation, assuring lowest possible fuel consumption. It also assures constant radiant heat with radiators, convectors, and radiant baseboards. Every Thrush job sells another one for you. If you are not using Thrush equipment, consult your wholesaler or write for literature. Address Department J-1

H. A. THRUSH & COMPANY

PERU INDIANA



THRUSH WATER CIRCULATOR

QUESTION BOX ON OKOLITE-OKOPRENE CABLE

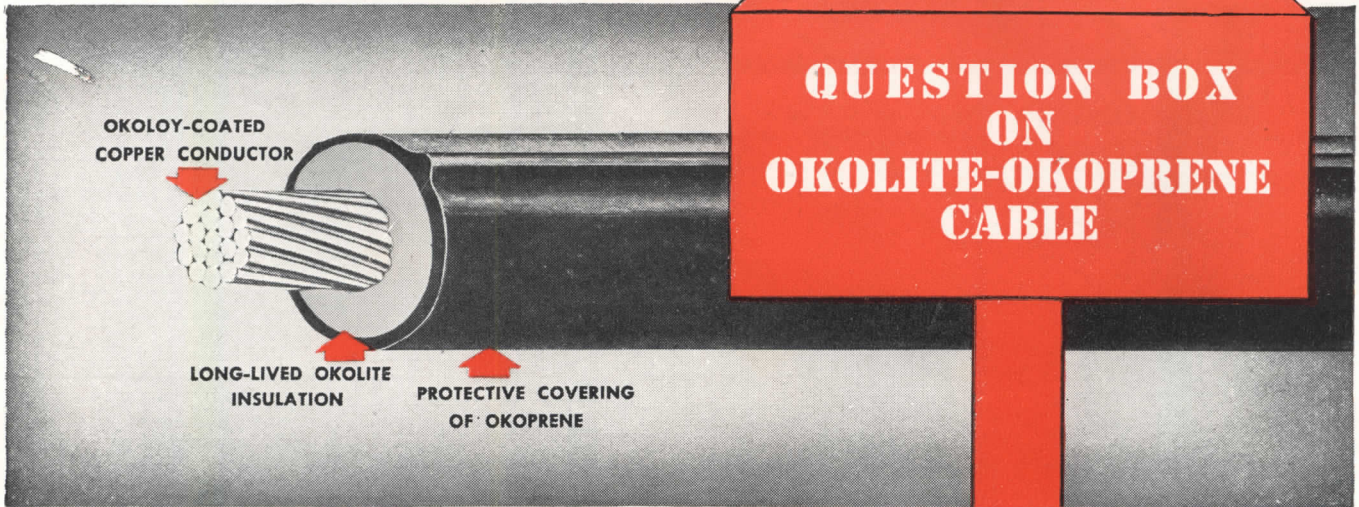

Question: What widely-used electrical cable for all-around service is being specified today for the most important industrial and commercial jobs?

Answer: *Okolite-Okoprene* cables, both single conductor and multi-conductor.*

Question: What kind of performance can be expected of Okolite-Okoprene cables?

Answer: *Millions of feet have been installed over the past 20 years and have proved long-lived.*

Question: Where may Okolite-Okoprene cables be installed?

Answer: *In ducts, or buried directly in the ground, or exposed to the elements.*

Question: Is additional protection needed?

Answer: *No.*

Question: What are some of the advantages contributed by the design of Okolite-Okoprene cables?

Answer: *Absence of tapes, braids or metallic coverings that rot or corrode. Perfectly-centered conductors. Uniform thickness of insulation and of covering. Uniform vulcanization throughout entire cable length.*

Question: What are some of the electrical operating advantages of Okolite insulation?

Answer: *High dielectric strength and moisture resistance. Stable characteristics. Low specific inductive capacity. High current carrying capacity. (75°C. copper temperature.)*

Question: What electrical characteristics are contributed by Okoprene, an Okonite-developed neoprene compound?

Answer: *Additional dielectric strength. Additional ozone resistance. High surface resistance which eliminates charging current drainage from cable surface.*

Question: What physical properties of Okoprene provide operating advantages?

Answer: *Lasting weather-resistance. Resistance to oil and solvents. Resistance to acids, alkalis and corrosive chemicals. Non-flammability.*

Question: How about installation?

Answer: *Okolite-Okoprene cables are simple to handle, splice and terminate. They require no potheads. They resist abrasion, are flexible at low temperatures.*

Question: Where can I find out more about Okolite-Okoprene cable and its relation to my problems of electrical distribution?

Answer: *By talking things over with a representative of The Okonite Company, Passaic, New Jersey or writing for Bulletin OK-2009.*

*U. S. Pat. No. 2,312,058

TOUGH AND DURABLE
OKOPRENE SHEATH

PROTECTIVE COVERING
OF OKOPRENE

OKOLOY-COATED
COPPER CONDUCTOR

LONG-LIVED OKOLITE
INSULATION

HEADQUARTERS FOR
ANSWERS:
OKONITE

OKONITE
SINCE 1878

insulated wires and cables

4977

COPPER AND COMMON SENSE

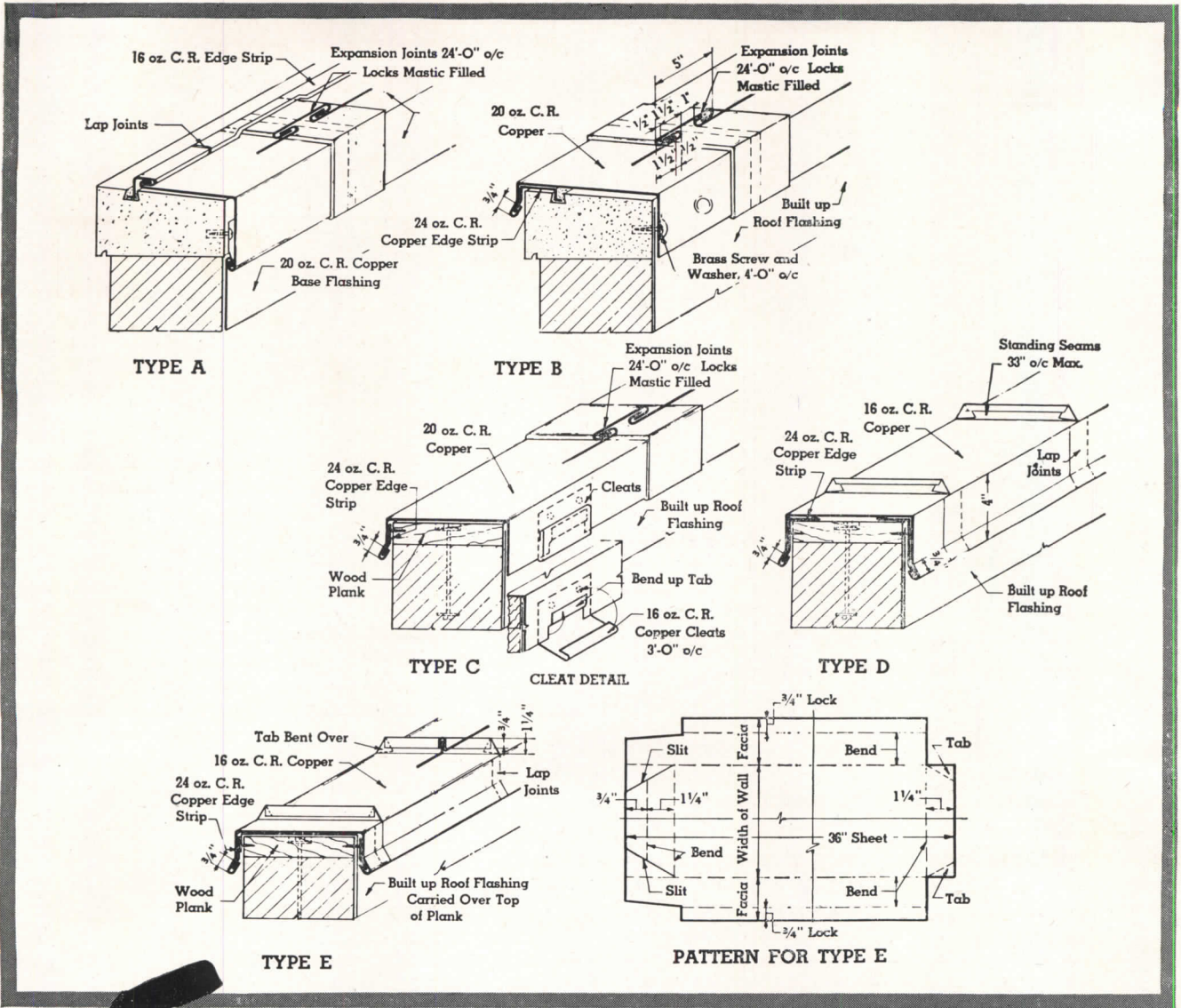

5

METHODS OF COVERING THE TOP OF PARAPET WALLS WITH REVERE COPPER

These five detail drawings were prepared by the Revere Research Laboratories to illustrate some of the approved methods of covering the top of parapet walls with copper coping covers. They are typical examples of the work Revere is doing to help you provide the finest sheet copper construction.

Revere's continuous research program, covering every phase of sheet copper construction, has developed important new facts that enable you to design or install copper flashing, roofs and gutter linings that give extra years of service. Much of these data have been compiled into a 96-page booklet* that has been widely distributed to architects and sheet metal contractors. In all probability, there is a copy in your office files.

Look first to this Revere manual whenever you are faced with a problem concerning the design or instal-

lation of copper. If you do not find the answer there, the Revere Technical Advisory Service will be glad to help you. The chances are that they have already had experience in solving a similar problem. In any case, they'll do their best to help solve yours.

Revere materials are available from leading distributors in all parts of the country.

**"Research Solves Problems of Stress Failures in Sheet Copper Construction."*

REVERE

COPPER AND BRASS INCORPORATED

Founded by Paul Revere in 1801

230 Park Avenue, New York 17, New York

Mills: Baltimore, Md.; Chicago, Ill.; Detroit, Mich.; New Bedford, Mass.; Rome, N. Y.—Sales Offices in Principal Cities. Distributors Everywhere.

THE FINEST BUILDINGS OF THE POSTWAR

HAVE **Q**-FLOORS



Mercantile National Bank, Dallas, Texas. Tallest office building in the South. Architect—Walter Ahlslagler, Dallas. Contractor—Henger Construction, Dallas.

John Hancock Mutual Life Insurance Co., Boston, Mass. Largest office building in New England. Architect—Cram and Ferguson, Boston. Contractor—Turner Construction Co., N. Y. C.

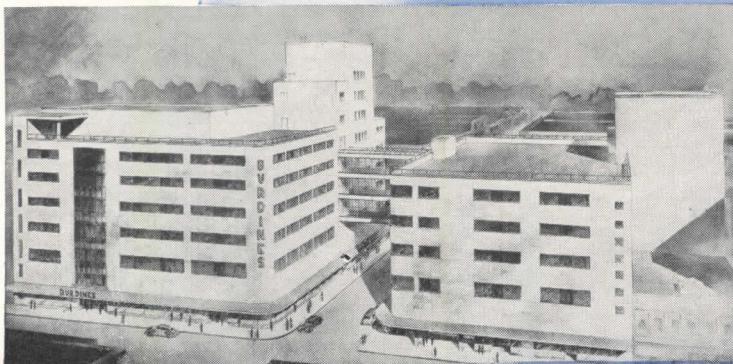

Burdine's Store, Miami, Florida. Largest department store in Dixie. Architects—E. L. Robertson, Miami; J. R. Weber, N. Y. C. Contractor—Rodney Miller, Miami.

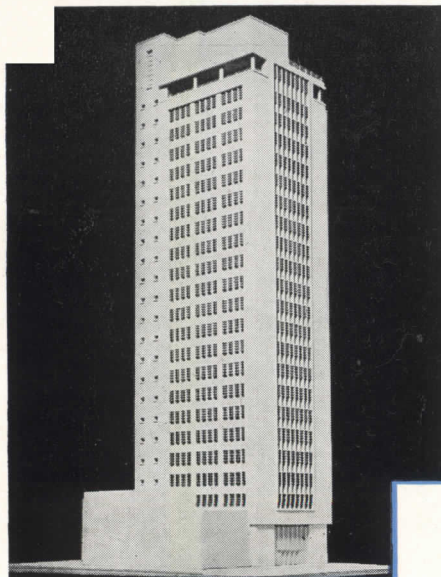

Waterman Steamship Building, Mobile, Ala. Most striking office building of the postwar. Architect—J. Platt Roberts, Mobile. Contractor—J. P. Ewin and Co., Mobile, Ala.

Federal Telecommunications Laboratories, Nutley, N. J. Largest all-metal commercial group in the world. Architects—Louis S. Weeks, N. Y. C. (groups 1 & 2); Giffels & Vallet, L. Rossetti, Detroit (groups 3 & 4).

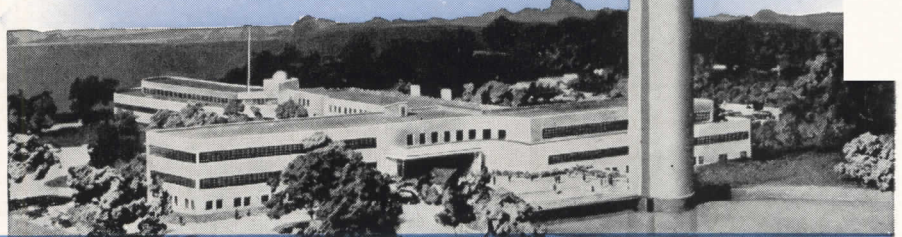

If you want to know why these architects specified Robertson Q-Floors, please write for literature.

H. H. ROBERTSON COMPANY

2404 Farmers Bank Building
Pittsburgh 22, Pennsylvania



Offices in 50 Principal Cities
World-Wide Building Service



THIS IS 1 SQ. FT. OF Q FLOOR

FACTORS GOVERNING THE CUSTOM DESIGNING OF RESILIENT FLOORS

One of the most outstanding features found in all types of resilient flooring is the wide freedom they offer for custom designing. The economy with which these materials can be worked into custom designs makes this feature especially practical.

At relatively little cost, resilient floors can be designed to accomplish different things for different rooms. They can be designed to make long, narrow rooms appear wider or to overcome other architectural limitations. Economical resilient floor designs also can be created to set off displays of merchandise and serve as traffic directors. Trade-marks, names, monograms, and insignia can be made into resilient flooring insets at moderate cost.

FACTORS TO CONSIDER

Costs. While custom-designed resilient floors are relatively less expensive than most other flooring materials, the full cost of the installed floor depends upon the elaborateness of the design. As a rule, the more intricate the design, the higher the labor and material costs. Since most custom designs involve hand cutting, the amount of labor required by the design should be considered. Some designs, such as those using wide sweeping curves, scrolls, and ribbon motifs often increase costs through waste of material.

Workmanship. Skilled workmanship is also important. To insure the effectiveness and long wear of a custom-designed floor, it must be installed by skilled flooring mechanics. Where intricate floor

designs are being planned, it is well to consult the flooring contractor first on whether his flooring mechanics have the proper skill or training to install the floor design being considered.

Limitations. Any floor design that can be drawn on paper can be duplicated in a resilient floor. While there is practically no limit to the size of the over-all design, there are several limitations on the size of the individual piece of resilient flooring material being used in the floor design or inset. The narrowest strip that can be cut from linoleum is $\frac{1}{8}$ " wide while $\frac{3}{16}$ " is the narrowest that can be cut from resilient tiles. In designs requiring strips or lines narrower than the limitations mentioned, the resilient flooring materials are scored to simulate the lines desired in the inset. However, inset pieces as small as $\frac{1}{8}$ " x $\frac{1}{8}$ " can be used successfully. Where lettering is to be incorporated in the floor design, characters less than 1" high should not be used. Characters smaller than one inch cannot be cut or spaced successfully.

Design Freedom. While floor designs can be easily worked out in any type resilient flooring, linoleum offers the unusual freedom of design, especially over large areas requiring a minimum of seams. Made in rolls six feet wide and up to one hundred feet long, it permits the use of one-piece feature insets over both large and small areas.

Resilient tiles, made in a variety of sizes, offer unlimited opportunities for the unusual in geometric designs. Hand set, one tile at a time, even the most





While geometric designs are the most commonly used in custom floors of resilient tiles, sweeping curves, scrolls, and similar designs can be executed equally well in asphalt tile, Linotile®, or rubber tile. The picture above illustrates how an attractive asphalt tile floor can be custom designed to follow the curved contours of the interior layout.



Resilient flooring material gives the architect many opportunities to carry out the theme of the interior in the floor design. Here the military motif of the room's decorative scheme is picked up in the stripe and chevron design of the floor. Two colors of jaspé linoleum form the stripes, while plain linoleum was used in the rambling chevron design.

intricate geometric designs are practical. Resilient tile floors also can be adapted to custom floor designs using curves.

Resilient tile custom designs can be simplified with the use of factory cut diagonal half tiles and feature strips. Resilient tiles are usually manufactured in a number of sizes ranging from 3" x 3" to 18" x 36". The 9" x 9" size is the most commonly used. Factory cut feature strips are available in widths ranging from 1" to 4" in graduated steps of 1/2". For both economy and ease of installation, it is best to plan the dimensions of insets in multiples of the tile size being used in the floor.

When planning special design insets in lobbies or near entrance ways or other areas subject to exceptionally heavy traffic, it is recommended that the traffic problem be considered in the planning of the design. Since the wear caused by heavy traffic may require replacement of portions of the floor area, it is often practical to plan a floor design that can be easily replaced.

When insets are cut in two colors, it is usually possible to obtain a second inset of the same design but in the "reverse" colors of the original design. In many instances, the "reverse" colors are considered waste. However, in floor areas where the same style inset is repeated several times, the architect can take advantage of the "reverse" inset when planning the floor design and thus lower the cost of the inset repeats.

SPECIAL ARMSTRONG DESIGN SERVICES

For many years the Armstrong Cork Company has furnished a special floor design service through its Bureau of Interior Decoration. The Bureau, staffed with experienced interior designers, will help architects solve resilient flooring design problems, suggest designs for floors, and will furnish complete color schemes for floors, walls, and accessories upon request.

Special flooring designs, originating either with the architect or Armstrong's Bureau of Interior Decoration, can be cut to specifications at the Armstrong factory. These services are available without obligation to architects and flooring contractors by furnishing to any Armstrong office the room dimensions, color preferences, and other information pertinent to the job. Or write directly to the Armstrong Cork Company, Floor Division, 2401 State Street, Lancaster, Pennsylvania.



This elaborate floor inset reproducing the Marine Air Insignia is a typical example of the unlimited decorative possibilities of resilient flooring materials. Eight colors and more than two hundred individual pieces of asphalt tile were used in the inset which was cut to designer's specification and shipped as a complete unit from the Armstrong factory.



Floor designs can be used to tell stories as well as create unusual effects. The clubroom floor above tells the story of a card player caught with extra aces in his hand, resulting in the breaking up of the game and the strewing of cards and chips over the floor. The floor design also helps to establish the room's carefree atmosphere.



ASBESTOS IN ACTION . . .

Looking for a
"DIFFERENT" material
that meets your
three requirements?

K & M "Century"
ASBESTOS CORRUGATED

Originally designed for industrial plant construction, K&M "Century" Asbestos Corrugated now finds increasing favor in such varied architectural usage as theatres, cocktail lounges, restaurants . . . and even women's specialty shops, as shown above! Seemingly, there's no limit to its application . . . it's a "natural" wherever these three factors are desired:

1. Appearance—Corrugations functionally provide structural strength . . . but also create a striking yet dignified decorative pattern that's pleasing to the eye . . . strikes either masculine or feminine motifs, as desired. Its neutral gray color blends well with any scheme . . . yet can be painted, if desired.

2. Versatility—Rugged asbestos-cement composition makes "Century" Corrugated equally well

suited for inside or outside construction, whether factory or fashion shop. Climate, local atmospheric conditions, other considerations are all the same to this versatile material. Comes in wide variety of sheet sizes.

3. Economy—It is moderately priced and keeps maintenance costs at an absolute minimum. Painting is unnecessary . . . it also resists fire, rot, rodents, termites, and corrosion. Time only toughens it.

Yes, "Century" Asbestos Corrugated is the material of the present . . . and even more so of the future. Write us for further information on the application of this time-defying material to your specific problems.

KEASBEY & MATTISON
COMPANY • AMBLER • PENNSYLVANIA



Reg. U.S. Pat. Off.



Uncle Stokemore will be there...

Will You . . . Hmm? You enter the massive portals on Lexington Avenue. You hand your ticket to the guardian of the gate. He bows, touches the visor of his gold encrusted cap, and waves you on up the regal marble staircase. And then, just at your right as you enter, you see THE exhibit of the 1948 Heating and Ventilating Exposition—the display of RICHMOND!

New? Mister, it's Top-Secret! Frankly, we can't tell you now about the NEW Richmond heating equipment you'll find there. Until the doors open on the show, the secret specifications will be locked in our safe. We *can* tell you this, however: everything you see at the Richmond Dis-

play you can recommend to your most exacting clients. It will be well worth your while to see this exhibit in person. If the pressure of business makes it impossible to attend, you can get a copy of our special announcement bulletin, ready next month.

Guaranteed—As always, all gas-fired Richmond heating equipment has both a one-year replacement guarantee and also A. G. A. approval. All Richmond plumbing fixtures have a full year's replacement guarantee, too, as recommended by the U. S. Bureau of Standards. For complete details on any Richmond plumbing or heating product, address Richmond Radiator Company, Dept. 1-A.R., 19 East 47th Street, New York 17, N. Y.

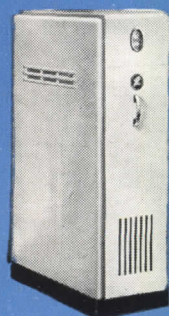
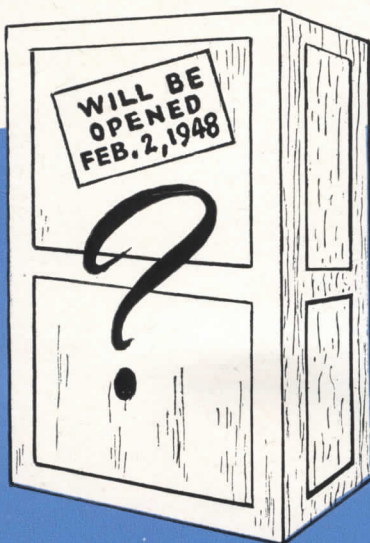

HEATOMAT GAS BOILER

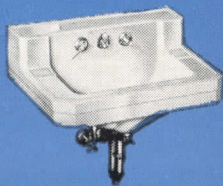

BROMLEY VITREOUS CHINA LAVATORY



BRESLIN RECESS BATH



SERVILLA ENAMELED CAST IRON SINK



RICHMOND RADIATOR COMPANY
 AFFILIATE OF REYNOLDS METALS COMPANY

Enameled Cast Iron Ware • Vitreous China • Perma-Gloss • Gas Boilers • Gas Winter Air Conditioning • Gas Gravity Furnaces • Radiators

PACIFIC DISTRICT

5051 Santa Fe Avenue, Los Angeles 11, Cal.



R. F. LAUER
District Manager

Assisted by

- | | |
|----------------|-----------------|
| J. N. Berger | M. R. Overbye |
| E. J. Berlet | G. F. Sainsbury |
| W. R. Eby | W. W. Sandholt |
| Maron Kennedy | C. A. Shapiro |
| T. A. Marshall | F. H. Stephens |
| H. T. Orebaugh | D. D. Stone |
| G. H. Walker | |

SOUTHWEST DISTRICT

2201 Texas Avenue, Houston 1, Texa



A. C. EDWARDS
District Manager

Assisted by

- | | |
|--------------------------------|----------------|
| H. W. Broadwell, Sales Manager | |
| Calvin Gore | W. R. McGinnis |
| F. D. Graham | C. H. McLeod |
| R. P. James | J. F. Moss |
| W. K. Laster | R. S. Sandifer |
| H. Z. Thomas | |

MIDWEST DISTRICT

117 South 11th Street, St. Louis 2, Mo.



E. F. EDWARDS
District Manager

Assisted by

- | | |
|-------------------------------|------------------|
| C. S. McDorman, Sales Manager | |
| Fred Downs | O. A. Rohner |
| E. A. Froese | C. G. Skinner |
| J. C. McDonald | H. W. Walling |
| H. W. Meinholtz | E. F. Weber, Jr. |
| P. O'Daniel | W. Wilder |

CENTRAL DISTRICT

185 N. Wabash Avenue, Chicago 1, Ill.



J. J. FLORETH
District Manager

Assisted by

- | | |
|-----------------|-------------------|
| G. W. Ashlock | S. M. Miner |
| W. E. Barnum | C. G. Quermann |
| H. G. Chapin | J. F. Raether |
| L. J. DuBois | K. A. Roffman |
| T. M. Hughey | G. A. Schuster |
| E. N. Kerrigan | B. O. Schwendener |
| I. F. Lounsbury | D. C. Warfield |
| R. E. Miller | F. E. Wilkes |

York Products... York Leadership...

Backed by These York-Trained

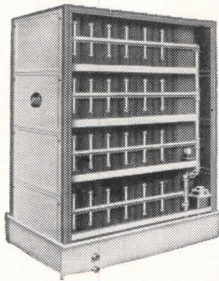

AIR CONDITIONERS

Sprayed finned surface dehumidifier single units up to 60,000 C.F.M.

Finned sections for central station coil banks.

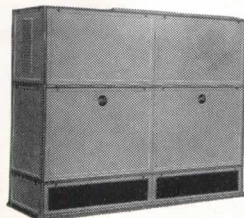
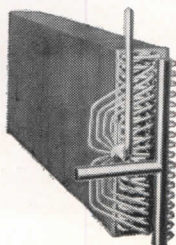

Horizontal or vertical air conditioners from 1500 to 10,000 C.F.M.



ECONOMIZERS
(evaporative condensers)

Sizes to match compressor capacities

EAST CENTRAL DISTRICT

2700 Washington Ave., N.W., Cleveland 13, O.

**H. S. YODER**
District Manager

Assisted by

C. J. Schurman, Sales Manager	
L. W. Cordrey	L. Lewis
L. R. Craig	L. P. Quinlivan
J. O. Currie	J. A. Schurman
C. G. Gillespie	G. O. Weddell
F. J. Goff	A. P. Wolff
W. P. Kohn	D. J. Wood

SOUTHERN DISTRICT

412 Houston Street, Atlanta 1, Ga.

**M. M. CROUT**
District Manager

Assisted by

R. C. Barnes	J. C. Malone, Jr.
R. A. Chandler	Walter May
M. P. Echols	D. P. Schiwetz
E. C. Harper	Ned C. Scott
O. W. Hogan, Jr.	R. A. Warnock

MIDDLE ATLANTIC DISTRICT

1616 Walnut Street, Philadelphia 3, Pa.

**M. S. LEBAIR**
District Manager

Assisted by

R. G. Werden, Sales Manager	
J. W. Chandler	J. J. Seelaus
J. Ralph Custer	W. E. Shuff
C. W. Hemphill	R. J. Sigel
W. R. Hollinger	R. L. Smith
J. S. McCollam	J. M. Stipp
W. F. Otis	C. M. Taylor

NORTH ATLANTIC DISTRICT

100 East 42nd Street, New York 17, N.Y.

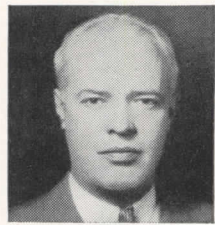
**A. CHRISTENSEN**
District Manager

Assisted by

R. K. Serfass, Sales Manager	
W. Allen	J. W. Floreth
A. N. Barnes, Jr.	C. P. Foley
H. W. Coon	L. J. Jacobson
A. J. Cordrey	J. Krsnak
L. S. Davis,	E. Lilygren
(Mgr. Boston)	R. C. Niess
W. G. Davis	Thorfin Olsen
J. G. Doebrich	P. L. Sackett
C. W. Egbert	E. Spencer
J. E. Fitzsimmons	H. E. Taylor
	C. Weigand

WHATEVER the refrigeration or air conditioning specification, there's a complete range of York equipment to meet it . . . And *wherever* the location of the job, there's a York-trained engineer within easy reach for practical assistance in planning and layout.

This experienced, technically trained manpower — backed by facts and figures from thousands of successful York installations — is at the service of architects, consultants and contractors, from the planning stage right through to final installation.

And installation is not the end of York responsibility. Through a special maintenance service contract, you are assured uninterrupted, efficient operation of York equipment by your nearest York-trained maintenance staff. York Corporation, York, Penna.

Engineering Staffs

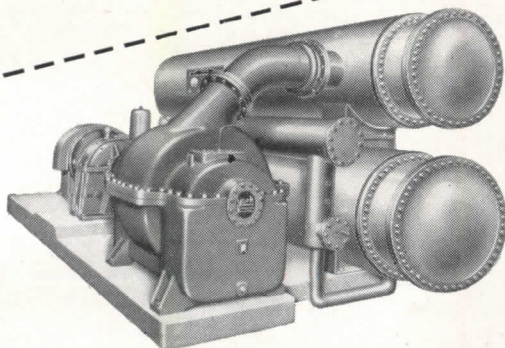
**TURBO SYSTEMS**

9 compressor sizes . . . air conditioning capacities to 1600 tons.

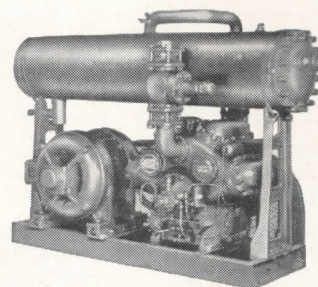
**VIW FREON COMPRESSORS**

15 to 350 tons.

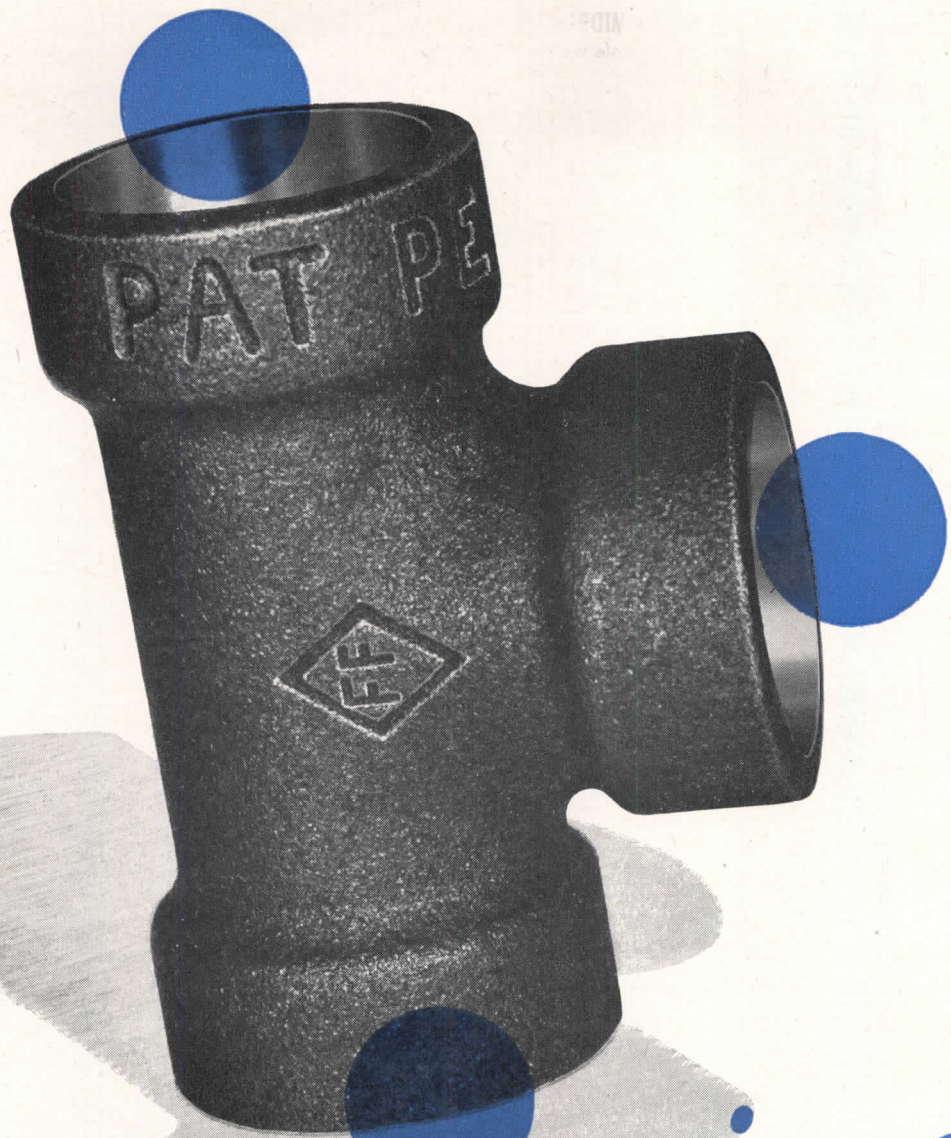

announcing

the first
threadless
malleable iron
fitting

MALLEABLE IRON FITTINGS, STD., EX. HVY. AND AAR • CAST IRON FITTINGS • DRAINAGE FITTINGS • FLANGE UNIONS • FLANGES

A giant step forward
of major importance
to every architect, engineer
and piping contractor. . . .

Now, for the first time, you can join iron pipe without threads or welding—and have a “one-piece” system as strong as the pipe itself — by using FLAGG-FLOW Threadless Malleable Fittings.

These basically new and better fittings are precision-machined for brazing to standard black steel or wrought iron pipe. Simply CLEAN-FLUX-HEAT and the silver brazing alloy flows by capillary action to form a seamless, permanently bonded joint.

QUALITY FEATURES AT MINIMUM COST

But beyond this simplicity of fabrication you gain important advantages never before available. FLAGG-FLOW means *free-flow* through smooth, unbroken, pocketless channels that are, in effect, continuations of the pipe itself. Thus FLAGG-FLOW gives to iron pipe the streamlined, low-friction loss advantages of copper tubing or welding — at *substantially lower cost*.

In fact, you get qualities previously found only in the costliest piping installations at a cost no higher than for threaded jobs.

MAKES TOUGH PIPING JOBS EASY

Moreover, FLAGG-FLOW gives you *complete* freedom in layout. No longer need you worry about tight, inaccessible spaces — or making rights and lefts come together — or forcing fittings to face properly by wrenching them into position. FLAGG-FLOW will fit wherever pipe will go, giving you tubing flexibility with piping strength — easily, permanently, cheaply.

EVERY FITTING AIR-TESTED

This is THE FIRST AIR-TESTED, 150-POUND MALLEABLE FITTING EVER TO BE SOLD FROM STOCK. Every FLAGG-FLOW Threadless Malleable Fitting is air-tested under water. Truly, FLAGG-FLOW

introduces a new era in piping. And it is not surprising that the *originator* of the threaded malleable fitting in America should be the first to produce the *threadless* malleable fitting — for the name Stanley G. Flagg has been associated with leadership in the quality fitting field for nearly 100 years.

The whole story, with engineering and installation data of value, is yours for the asking. Write today for your copy of the new descriptive catalog.

FLAGG  FLOW

Ends these piping bugaboos

No pockets to create turbulence . . . No threads to weaken pipe wall . . . No distortion strains from strong-arm wrenching . . .
No loose joints from vibration or water-hammer . . . No special skill required for installation . . .

and remember—

No increased cost over screwed pipe installations.



STANLEY G. FLAGG & CO., INC.

1421 Chestnut Street, Philadelphia 2, Pa.

GROUND JOINT UNIONS • BRONZE THREADED FITTINGS • BRONZE SOLDER FITTINGS • UNDERGROUND TANK FITTINGS



PHOTO BY FAIRCHILD AERIAL SURVEYS

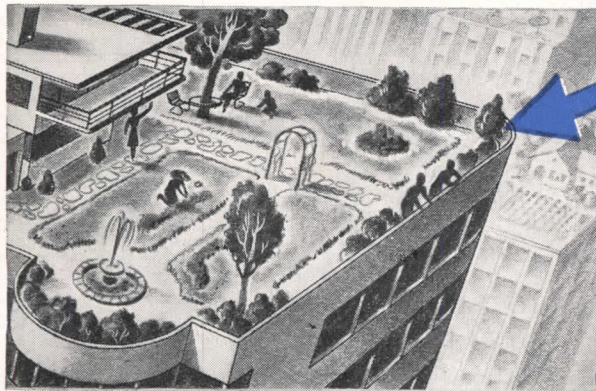

GARDEN ROOFS LIKE THIS ARE SIMPLE AND PRACTICAL

Flowers, grass, shrubs and even trees now grow where formerly the city dweller could only expect to see bare roof areas. Ruberoid's new specifications make installations like this not only simple but practical and efficient.

• More efficient use of roof areas is the order of the day. Garden roofs, outdoor decks for convalescents, recreational space for office workers, heavy traffic and storage roofs for factories—these are typical examples of this trend in modern architecture.

Ruberoid engineers have analyzed all these new roof developments, divided them into three basic types, and worked out sound practical specifications for each. No unfounded theorizing or guesswork here—they've been tested and proved in actual performance! Copies of these specifica-

tions and full details are available from your local Ruberoid Approved Roofer.

Your Ruberoid Approved Roofer stands ready to help you in the solution of any roof problem. His "know-how" is backed by Ruberoid's years of experience and complete line of all types of built-up roofing materials.

The RUBEROID Co.

Executive Offices: 500 Fifth Ave., N.Y. 18, N.Y.
Asphalt and Asbestos Building Materials

The RIGHT roof for any job—from one source!



Remember that Ruberoid makes every type of built-up roof—Smooth Surfaced Asbestos, Coal Tar Pitch with gravel or slag surfacing, or smooth or gravel-and-slag surfaced Asphalt—in specifications to meet any need. Hence a Ruberoid Approved Roofer is not prejudiced in favor of any one type. His services assure you of one source for all materials, centralized responsibility, smoother operation, uniform quality!

HOW MUCH FOR A SET OF HOUSE PLANS?

THE current investigations into the high cost of housing and into the iniquities of the so-called "construction industry" are not likely to involve any implied indictments of architects. The architectural fee involved in most suburban low-cost housing developments is usually found to be a negligible item in the overall costs. The smaller developer can usually buy stock plans which he would consider satisfactory at a nominal cost, and these can be used over and over with such variations as the carpenter foreman's ingenuity or imagination may deem advisable.

Even in larger developments of low-cost houses, the fact that a few standard plans and standard details are developed and that merely variations, permutations and combinations of these stock designs are used for 100 or more houses, means that the cost per house again is an almost negligible item. This standardization of plan and design, when intelligently used, makes for a certain harmony of homogeneous design character. That may be a virtue rather than a drawback. This is especially true when the site plan is intelligently and ingeniously designed to eliminate the monotony of gridiron rectangles. This standardization and repetitive use of plans makes the design cost per dwelling unit a practically negligible quantity.

On the other hand, the cost of the design for a custom-built house for an individual owner becomes a real factor in the total cost of the house. It is sometimes hard for the prospective client to understand why a competent architect should charge 8 or 10 per cent of the cost of the house for his services when the owner or his contractor can "buy a set of plans" for \$25, \$5, or a "house pattern" from certain magazines for a dollar or two. The profession still has the tremendous task of educating the public to a knowledge of what is involved in complete architectural service for the custom-designed house and how much more is involved than the mere "making a set of blueprints." The amount of the architect's time taken by client conferences, determining actual requirements, studying and restudying plan and design, supervising and administering the construction of a house, is rarely appreciated by the prospective owner, nor does he realize that to the architect, his time is money.

The possible reduction in the design cost of the individual house is therefore largely a matter of the reduction of the time involved. Time can be saved and fee reduced only by increased efficiency in the architect's office or reducing the extent or quality of the service rendered. Increased efficiency might include such items as comprehensive questionnaires to determine clients' requirements; improved drafting techniques; greater standardization of the architect's own details; the use of stock materials, sizes, and equipment; simplified specifications; modular design and coordination; and perhaps last but not least, the designer's ability to grasp the requirements and reach the desired design solution without constant restudy or laborious evolution. Let us strive for more efficient service rather than for limited service or "the selling of blueprints."

Kenneth K. Stowell

EDITOR

BERNARD RALPH

*Notes from a forthcoming book
on Maybeck*

by Jean Murray Bangs

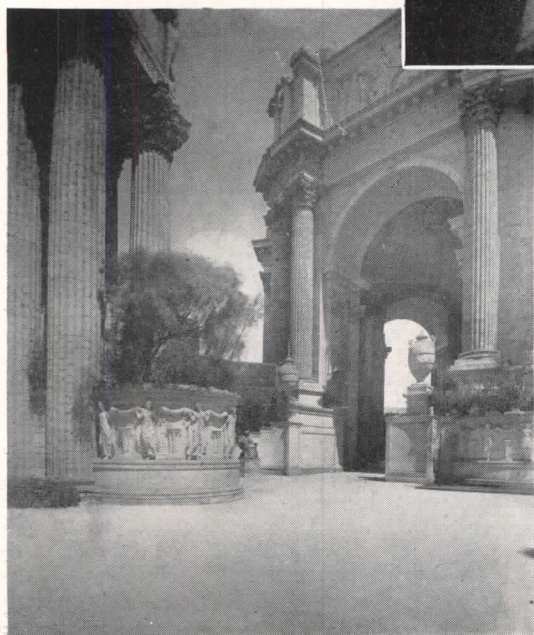
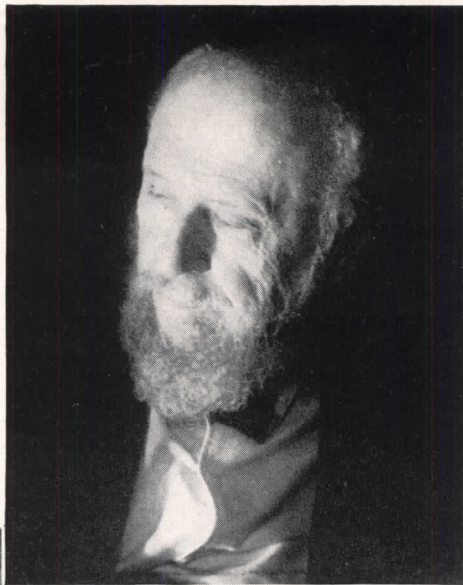

Worden Collection Photo



Worden Collection Photo



Weston Photo

MAYBECK, ARCHITECT, COMES INTO HIS OWN

With every passing year, awareness deepens that the best contemporary architecture is in a special sense traditional. Whoever considers independently and imagines truly for his own day joins that everlasting tradition of "well building" whose basic values never die. The central tradition is handed from one such independent spirit to another, transcending the accidents of circumstance and time. Never a seeker after quick publicity, Bernard

WHERE American life has most truly developed along its peculiar and most characteristic lines — let us say roughly along the Pacific Coast — where in general American mores, as distinguished from those of Europe, are most freely accepted, there is evolving a kind of domestic architecture that is perhaps the most advanced domestic architecture in the world today."

Talbot Hamlin wrote these lines in 1942. They might have been written any time after 1900 for from that time on very significant and beautiful work was done in California. Something of this early work is known, but not all. The gaps in the documentation of American architecture are amazing.

One of the distinguished American architects whose work is still relatively unknown is Bernard Ralph Maybeck. Of course he is not actually unknown. Anyone can read of his achievements in *Who's Who*. He received official recognition in many ways, had a government position, held civic office and founded the department of architecture in one of the state universities. The architectural profession gave him official recognition through the American Institute of Architects. Architects who saw his work gave unofficial recognition in the form of imitation, the sincerest form of flattery.

Most telling of all he received important commissions, of all forms of recognition the most important one. But until his contribution to architecture is generally realized, until he finds a place in architectural history, until the students in architectural schools know his work, until it is available to them as part of their cultural

R. Maybeck is today, in his retirement, the liveliest single topic of conversation among architects in his own native region of San Francisco and the Bay. Miss Bangs has been patiently prodding Mr. Maybeck and digging among the obscure records of much of his work. Aided by the University of California and private individuals, she has assembled the first comprehensive record of his contribution

heritage, until his work becomes part of the great tradition of American architecture, it is, in an important sense, unknown.

Maybeck was born in New York in 1862. After attending public and private schools in this country he was sent to Paris to finish his education at the *École des Beaux Arts*, in the atelier of M. André.

After his return to the United States he worked for Carrère & Hastings in New York and H. Page Brown in San Francisco. In 1894 he was appointed Instructor in Drawing at the University of California. Between 1896 and 1898 he was on leave of absence from the university, traveling in Europe, attending the *École* and acting as Professional Advisor for the International Competition for the Phoebe Apperson Hearst Architectural Plan for the University of California. On his return from Europe in 1898 he was appointed the first Instructor in Architecture at the University of California. This marked the founding of the architectural department there.

His private practice dates from 1903 when he left the University. The First Church of Christ Scientist in Berkeley, which has drawn a steady stream of architectural visitors since its completion, was finished in 1910. In 1913 he designed the town of Brookings, Oregon, for the Brookings Timber & Lumber Company. In 1915 his Palace of Fine Arts at the Panama-Pacific International Exposition in San Francisco became one of the most admired buildings in the country and the only one of the Exposition buildings to be preserved. In 1918 Maybeck was appointed District Housing Representative of the United States Shipping Board Emergency Fleet Corporation and was put to work as supervising architect of the town of Clyde. His later work included the design of the campus of The Principia at Elmhurst, Illinois. After that came important commissions for Earl C. Anthony; the Packard buildings in Oakland and San Francisco, and the Packard show room and a house for Mr. Anthony, both in Los Angeles.

In 1900 the American Institute of Architects gave Mr. Maybeck a memorial for his work in connection with the Hearst Plan for the University of California. In 1926 he was given an honorary M.A. from Mills

The best known vein in Maybeck's work is perhaps the richly romantic handling of classical themes found in the Palace of Fine Arts (middle pictures, across-page) initially built for the Panama-Pacific International Exposition, 1915. It was seen by ten million people during the Fair, "is undoubtedly the most admired building in California." Less well known are modest groups such as the Forest Hill School at Carmel, whose interior (left, across-page) is still strictly contemporary



California School of Fine Arts Photo

RANDOLPH SCHOOL, BERKELEY, CAL., 1911

Now used as a residence, this group is still full of instruction for the school architect. The interior seen above makes use of that "clerestory" daylighting whose virtues are still being explored, and displays a sensitive, direct, and highly intelligent use of wood. Exterior trellis work makes beautiful organic use of vines for shade. The treatment of each square room as a separate "little house" confers that intimate child scale which most school plans miss conspicuously and entirely. The plan, with its square classrooms, its brilliant open use of space, its avoidance of waste areas, is still full of useful suggestion



California School of Fine Arts Photo

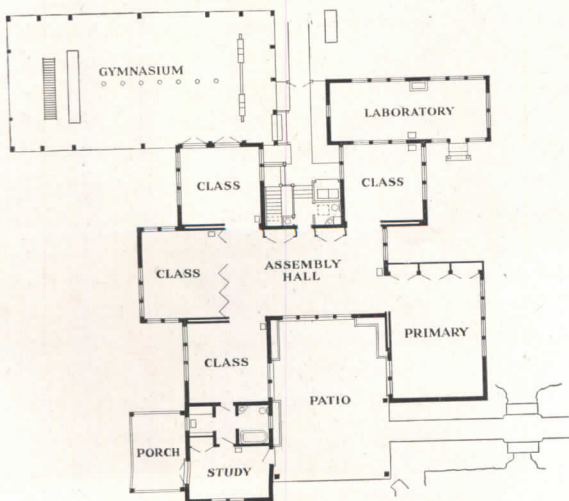

California Schoo of Fine Arts Photo



College and in 1930 the University of California gave him an LL.D. He served as member of the Berkeley City Planning Commission.

Maybeck was one of "those gifted ones whose souls are finely attuned to the touching beauty of nature and humanity" in whose work Sullivan tells us to look for the beginnings of a characteristically American style. His great reverence for and knowledge of the past never resulted in a copy of anything which had gone before. No matter what the building was, whether the client thought he had a little German house from Nuremburg, a Swiss chalet, or a Gothic hall, the building always bore a strongly individual stamp; it was Maybeck before it was anything else. He had too vivid an imagination, too great an interest in new materials, was too eager to provide for contemporary life and too experimental in his approach to allow for anything else.

His best work was always done when he was most free to keep his design broad, work in his own way, to ex-

periment and change. Nothing daunted him. He considered a mistake a creative opportunity. All his work shows his freedom, his escape from formulae, his imaginative use of materials. The very qualities of imagination and originality which were his greatest endowment sometimes became obstacles to achievement when boards of trustees and business, responsible for spending large sums of money, were afraid to venture off the beaten track.

In his houses, however, his poetic imagination had free play. He liked natural materials, left natural. He keeps wood looking as much a part of the tree as is possible and lets it age the natural way. He uses the trellis and pergola to tie his houses to the landscape with vines. He says, "Houses simply built, depending on natural projections and their shadows for ornamental effect, show a variety of light and shade when seen from the distance and need no paint or artificial covering to call attention to their details. The artificially finished house must be denuded often or look shabby, and unless a work of art its brilliancy only advertises its weaknesses. A house of natural materials repeats the color of the rocks; made of plaster or concrete, stone, brick, terra cotta, rough wood, shingles or shake, stained or natural, it absorbs the light and with the help of trellises and vines hides among the greens and browns of the background and is finished for all time."

In his houses we find many things of interest. His large windows, with their extensive use of glass, his devices to save steps and make things easy for the housewife, which are only now coming into common use, make him one of the forerunners of the modern work day. It is largely because of this aspect of his work that his place in history will be secure.

CHICK HOUSE, BERKELEY

Maybeck's house work is a volume in itself. Our one glimpse into the living room of the Chick house (now owned by Mrs. John Mattias) shows a stately grace, a bold use of component forms (fireplace in glass wall) that makes one think of Mr. Gardner Dailey. The exterior projections of this house, such as the gabled roof, the entrance canopy, small porch roofs, dissolve remarkably into rich trellis work



Stone and Steccati Photo

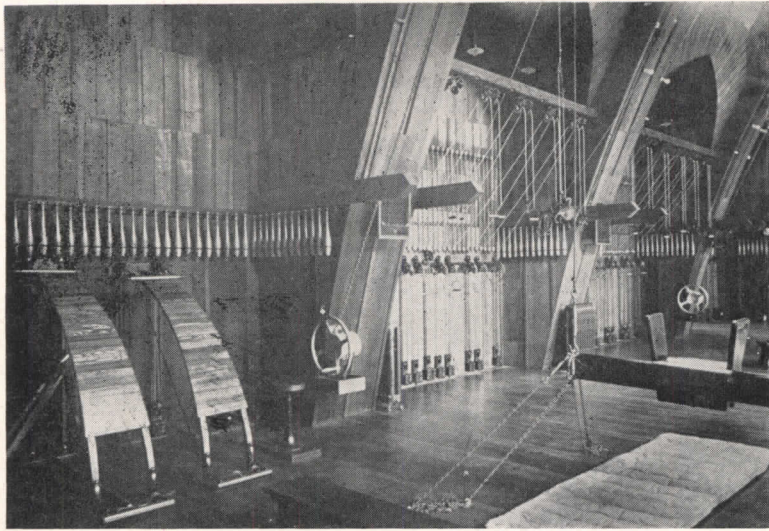

HEARST HALL, UNIVERSITY OF

BUILT 1900,

LOST BY FIRE, 1922

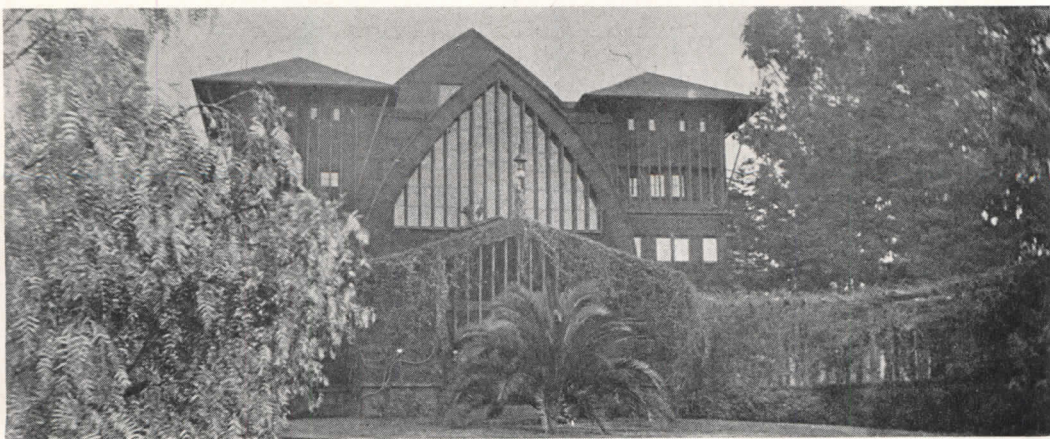
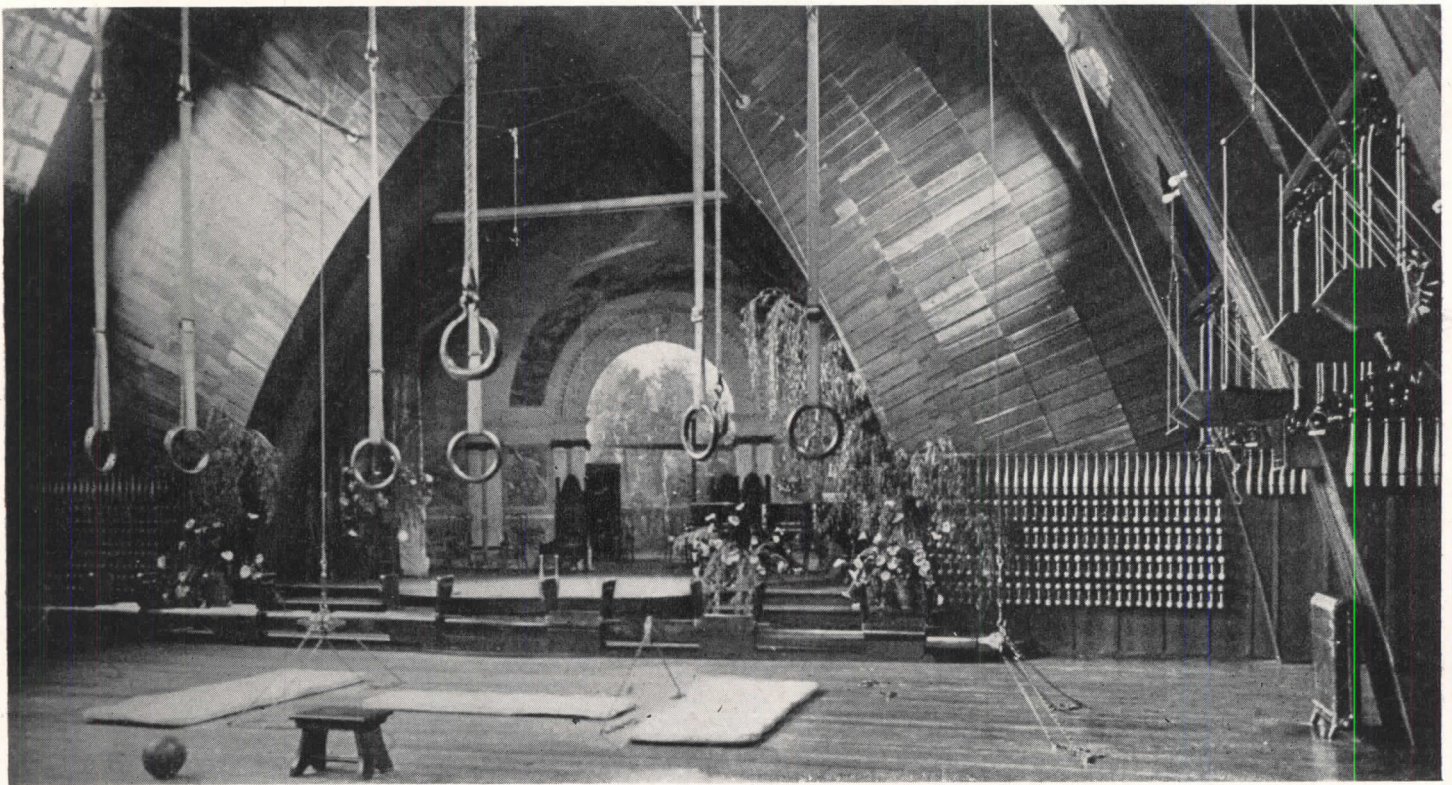

CALIFORNIA, BERKELEY

This woman's gymnasium for the University of California burnt down in 1922. Originally built at some distance from its ultimate site of the campus, the building had a fully laminated wooden arch construction that permitted it to be cut apart into sections and moved as seen below. The unconventional exterior not only expresses very directly the plan and the construction, but also portrays that knowing use of screening wooden verticals that has been treated as "news" when it has come to us from Finland or Sweden. The low curved structure to the right (bottom picture, opposite page) is a pergola'd passage

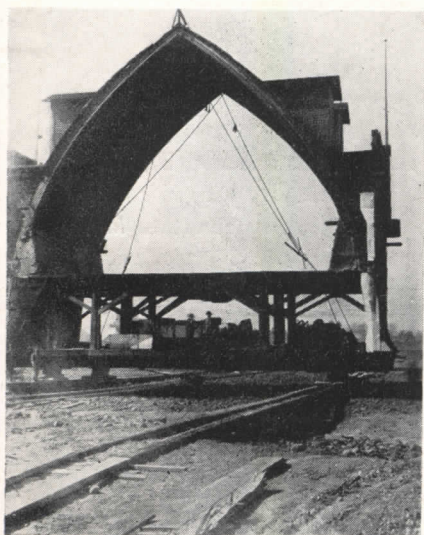

On the interior we find not only a very happy repetition of the pointed-arch construction in the longitudinal plane, but Maybeck's pioneering use of natural wood, at once functional (for rough usage) and highly decorative. One notes that the cedar shakes used as a lining are lapped to show the upper rather than the lower edges, in a manner that not only makes for an appearance of outward radiation in the arches, but also catches the sunlight like a beaded necklace. Even the projecting brackets (top view), apart from performing their functional duty, help to declare and enrich the sense of space. The very equipment, so familiar in gymnasiums, is used, with no forcing, to enhance both space and surface pattern

GLEN ALPINE RESORT, LAKE TAHOE, 1921

Fire again played a role when it destroyed the buildings of the Glen Alpine Mountain Resort on Lake Tahoe, and Maybeck was commissioned to design a new group that should be more nearly fireproof. Released from those irksome requirements of year-round insulation and heating that burden urban building problems, Maybeck produced this delightful fantasy. Massive stones, found on the site in abundance, were used for the great buttresses. Great poles, also from nearby, were used as roof purlins. These massive elements were then contrasted with the transparent weightlessness of glass walls in standard sash, and the whole sheltered under "tin" roofs. To use such corrugated sheeting was more daring than it would be today. Rarely, even today, is its intrinsic nature so capitalized, including the possibility of the graceful curve at the ridge. The chimney is Maybeck's invention, sucking air through the slits, aiding draft on the principle of a Venturi valve





MEN'S FACULTY CLUB, 1902

Superficially, this well known interior at the University of California, Berkeley, owes more to "Gothic" derivations than other examples here included. Yet on closer examination every element is found to contribute to a magnificent interior which has had its effect on countless students and teachers



FIRST CHURCH OF CHRIST, SCIENTIST, BERKELEY, 1910

The interior of this American masterpiece has so far defied the efforts of photographers to convey its magnificent grandeur. The square central hall is spanned by two colossal diagonal arched timber beams which, in other hands, could scarcely have failed to be oppressive. Instead, played against the glass screen walls, scaled with absolute surety against complex minor structural elements, seen against the mysterious extensions of the central space, they speak of serenity and power. The exterior here seen may be allowed to speak for itself, in terms of the fullest architectural vocabulary, handled by a master

An exterior view of the Faculty Club serves to illustrate the straightforward use of wood, with the sawmarks on it. The lightness of framing is remarkable for 1902, and the surface texture is subtle

California School of Fine Arts Photos

DETAILS IN WOOD

To study Maybeck, says Miss Bangs, is to gain an entirely new appreciation of the architectural possibilities in wood. Few are likely today to copy these quatrefoils; all the better; yet how many can equal this sure-handed conviction of this architectural passage? From the Chick house (see also interior, p. 75)

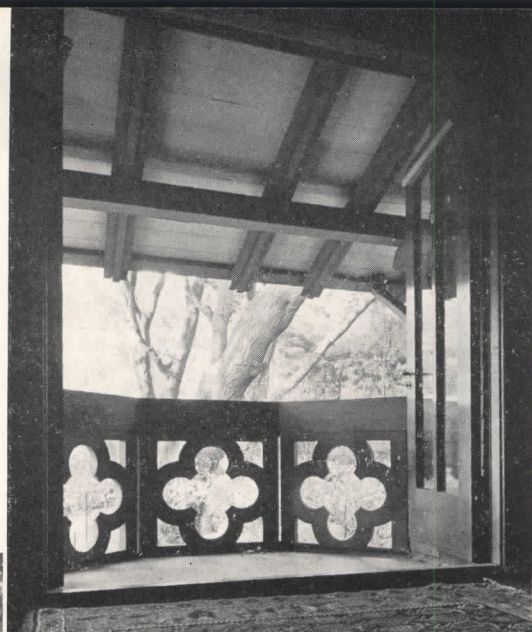

Maybeck's infinite variety awaits a more complete documentation. At least, Maybeck's "book" has now been cracked open, helping to provide a "usable American past" for living designers

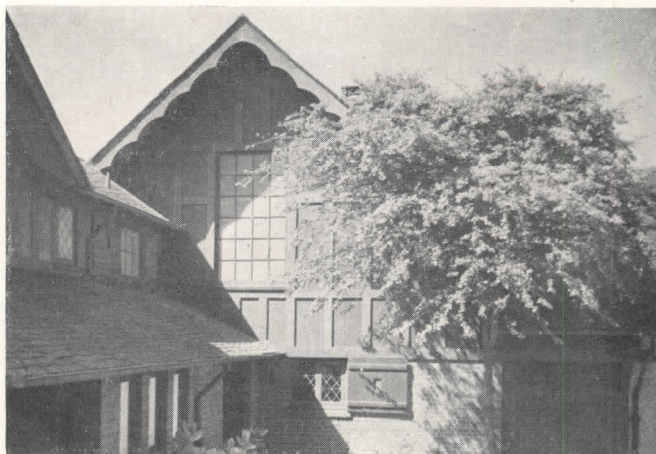

LAUREL ELEMENTARY SCHOOL

San Mateo, California

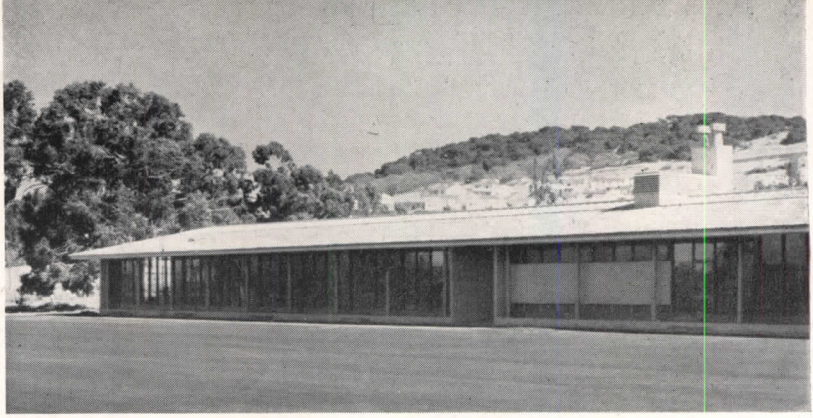

Franklin, Kump & Falk, Architect-Engineers

A NEW SCHOOL CYCLE GRACEFULLY BEGUN

BY a happy conjunction, this new school can be presented with the opening of the new year. It begins a new technical cycle on the West Coast, the cycle of top lighting, or, as Mr. Kump calls it, "trilateral" lighting of classrooms. Few of these new schools have the finished character, the accomplished architecture, of this initial essay by the Kump firm. The combined drawing and photograph (right) shows the essential structural system. (Working details, including the skylight, appeared in the RECORD just a year ago.) But the deeper meaning of the school lies in the fine child scale, the happier environment for children.

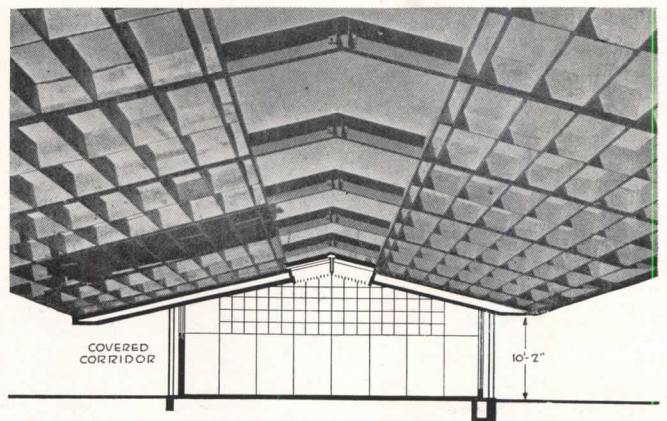

Plan provides for an eight-grade program, using duplicate rooms. Through-passage does not interrupt roofs (see section, page 85)

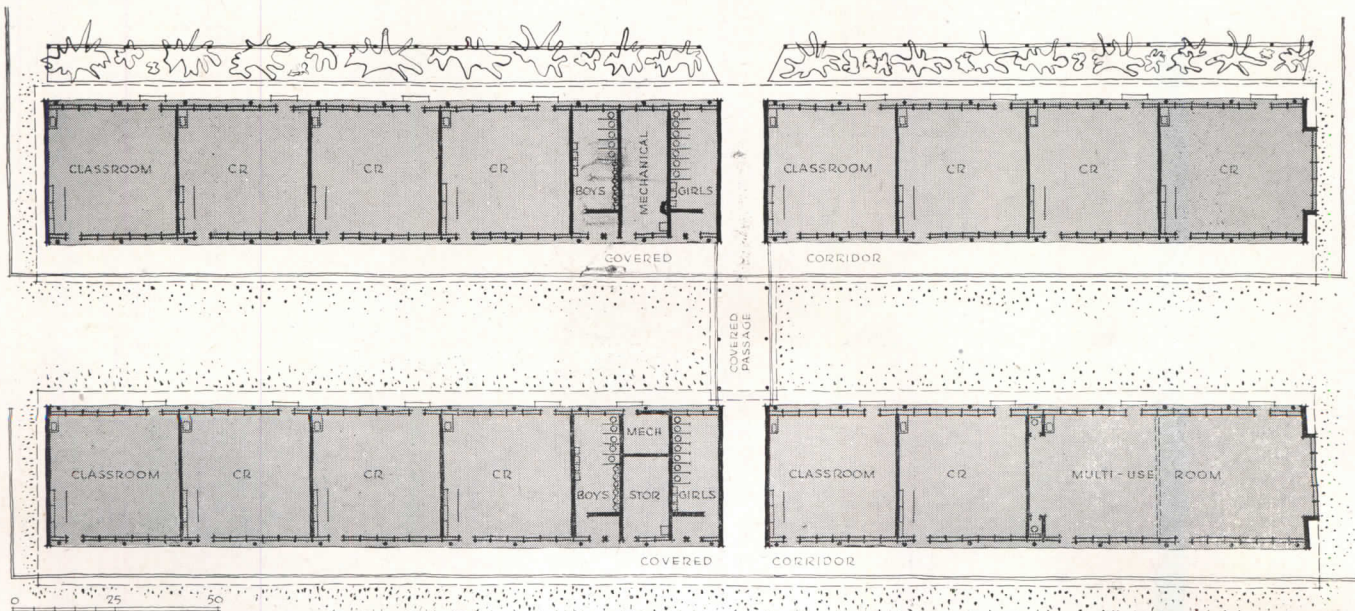

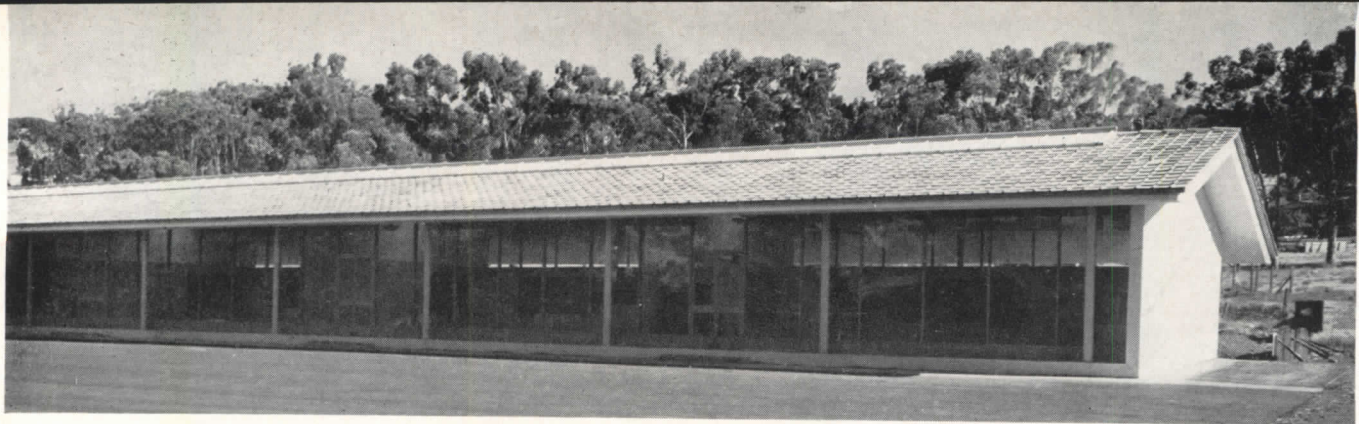

Roger Sturtevant Photos

Above, the first school wing as seen from the north; directly below, its east end; bottom of page, interior of the kindergarten room in this east end. The full-length skylight along the ridge is almost unnoticed against the red terra cotta roof tile. The stucco walls and soffits are stone gray, exterior trim is dark orange, pipe columns are gray — a warm quiet harmony

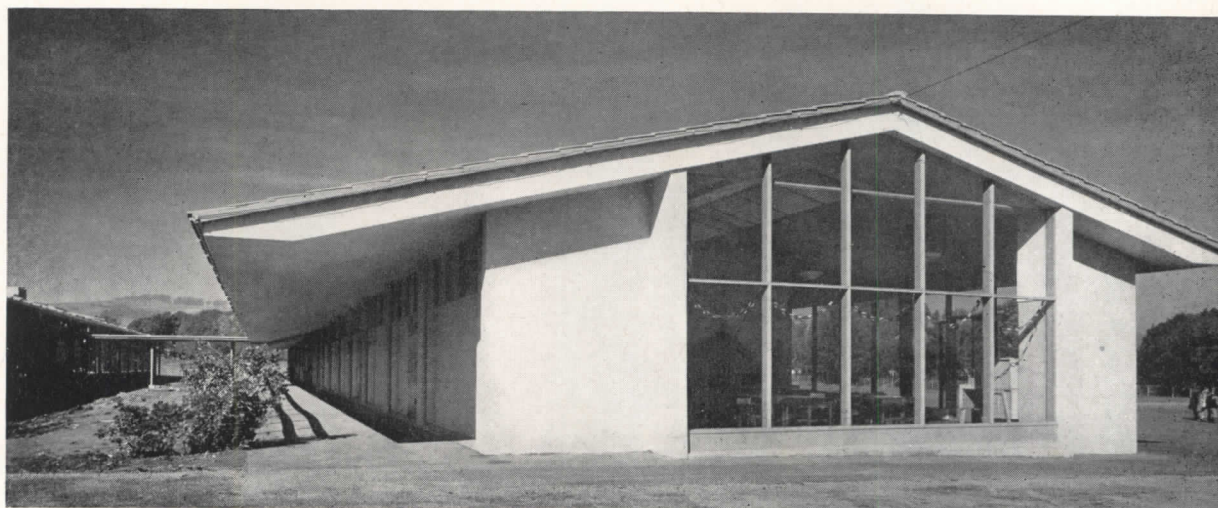

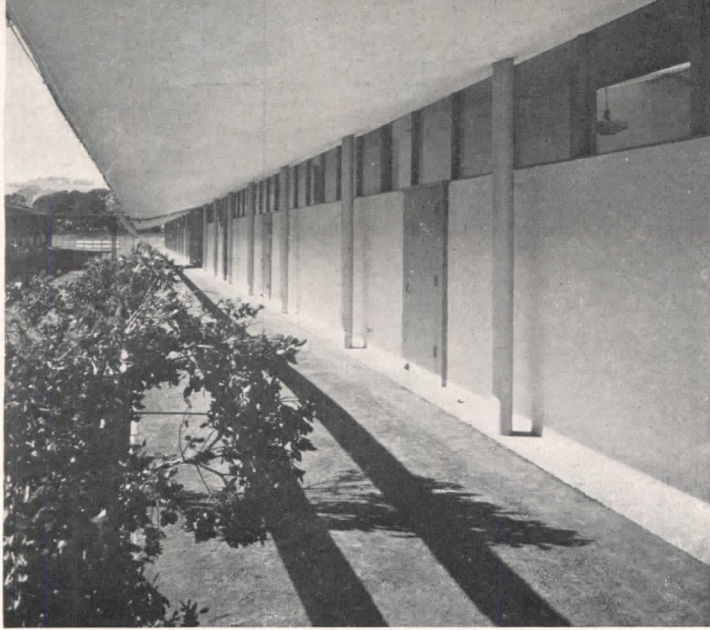

The wide south overhangs (left) with their sensuous plastic character, are cut off at exactly the point that will eliminate sky view and sky glare from anywhere within the room, including the extreme opposite corner where the photographer stood in the classroom below. Roof beams are steel, welded to pipe columns; purlins are of wood

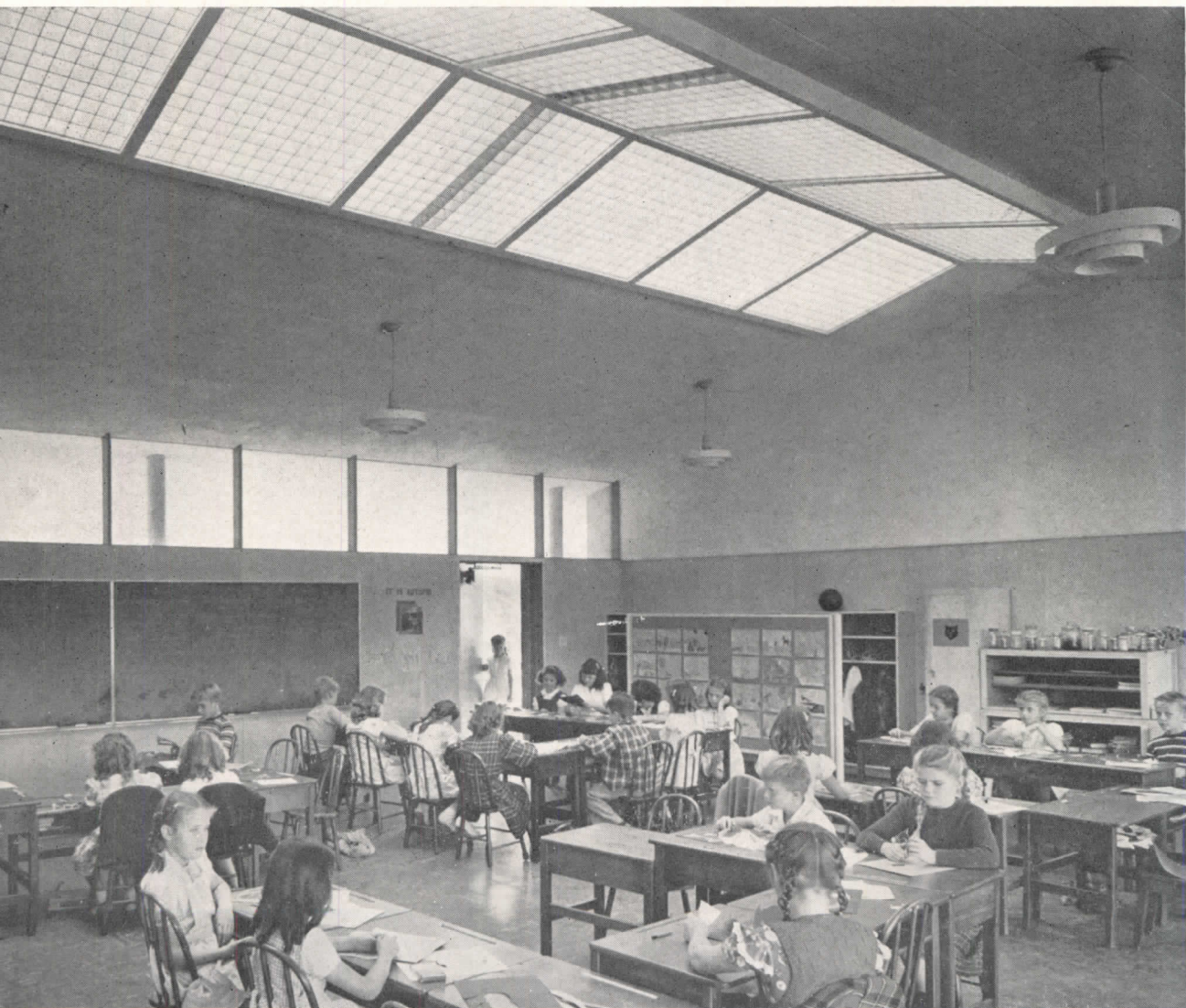

Interior view above shows egg-crate baffled skylight and transom lights of south wall. Across-page are seen the north windows of the same interior. Up to 7-ft. height (height of doors) interiors are faced with plywood having a white lead stain and wax finish; white acoustic tile covers all surfaces above

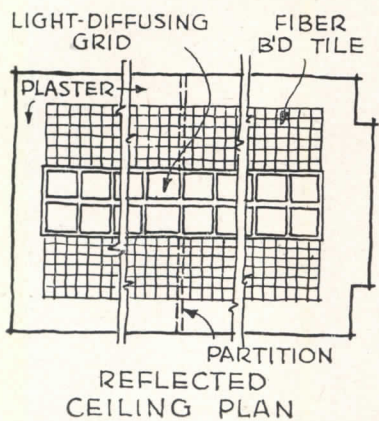

The narrower overhang looking north (as seen at right) merely gives protection against weather; it has the same subtle shape. Concentric ring type lighting fixtures, used with reflector bulbs, seen in room below, are very generally adopted in California for indirect lighting because easy to clean, rebulb, and maintain. Floors are asphalt tile

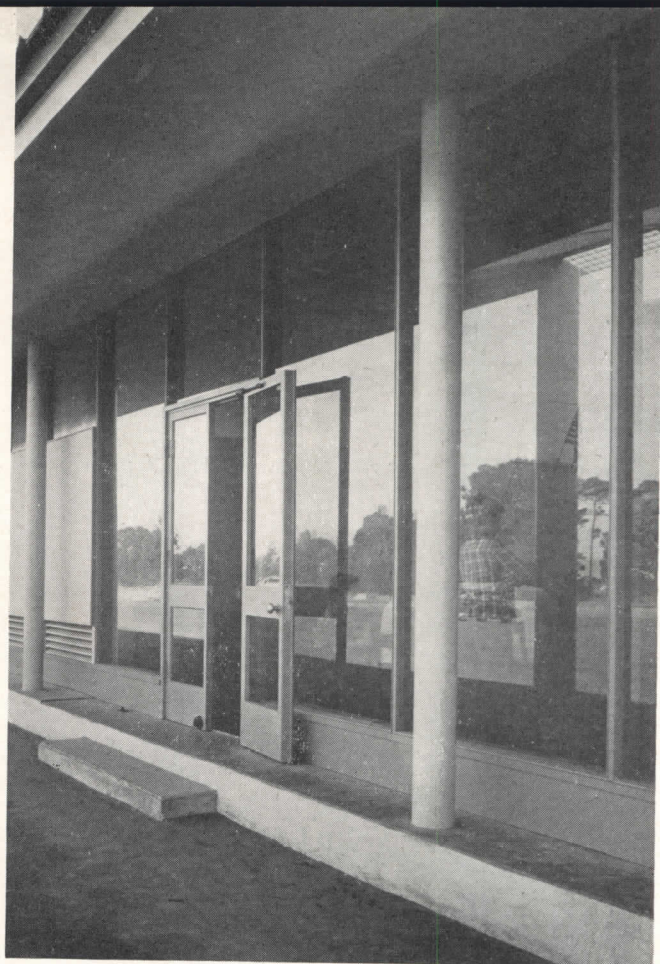

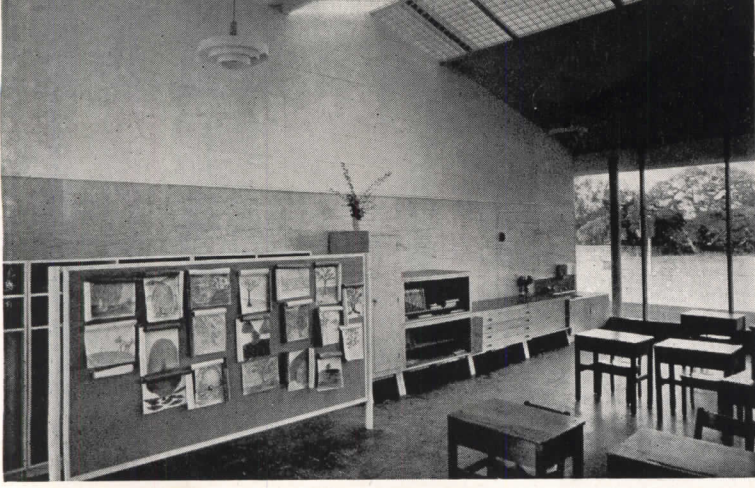

Rear of room (seen at left) contains the architects' standard school furniture. Below, school seen from the northeast; opposite page, from the southeast, with the second wing under construction in the foreground

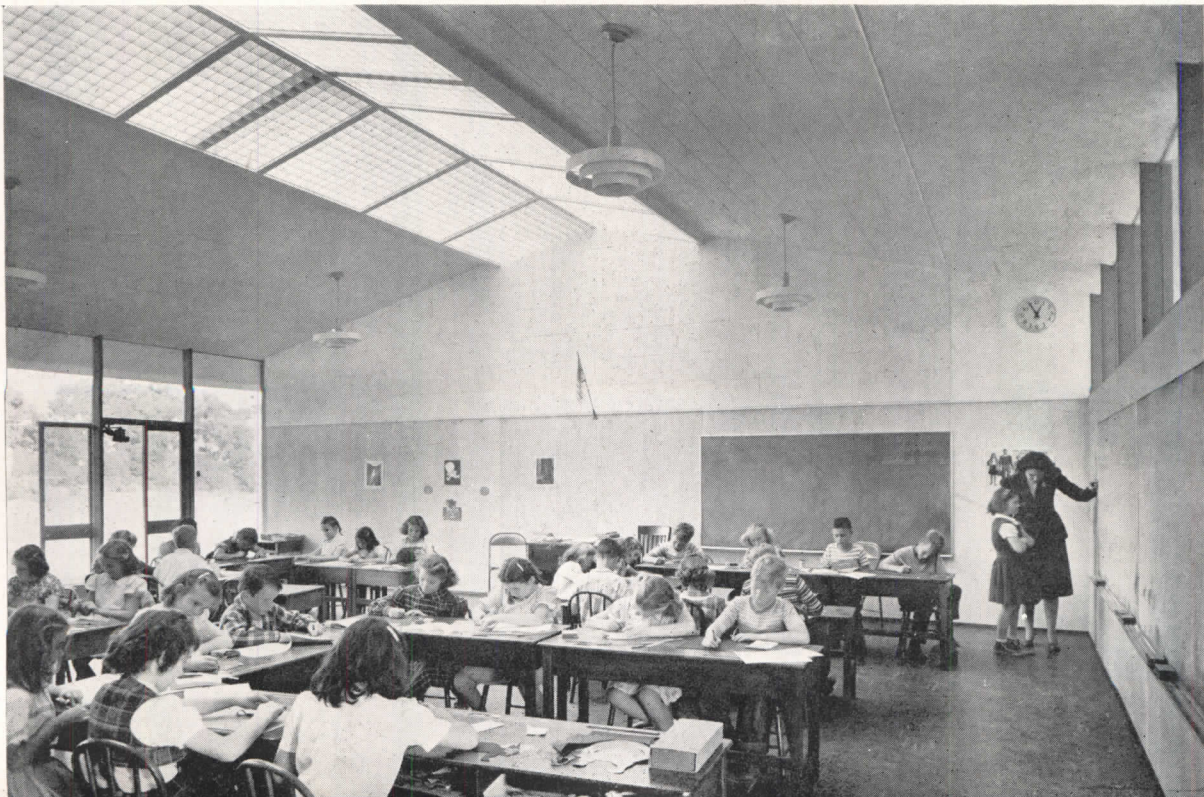
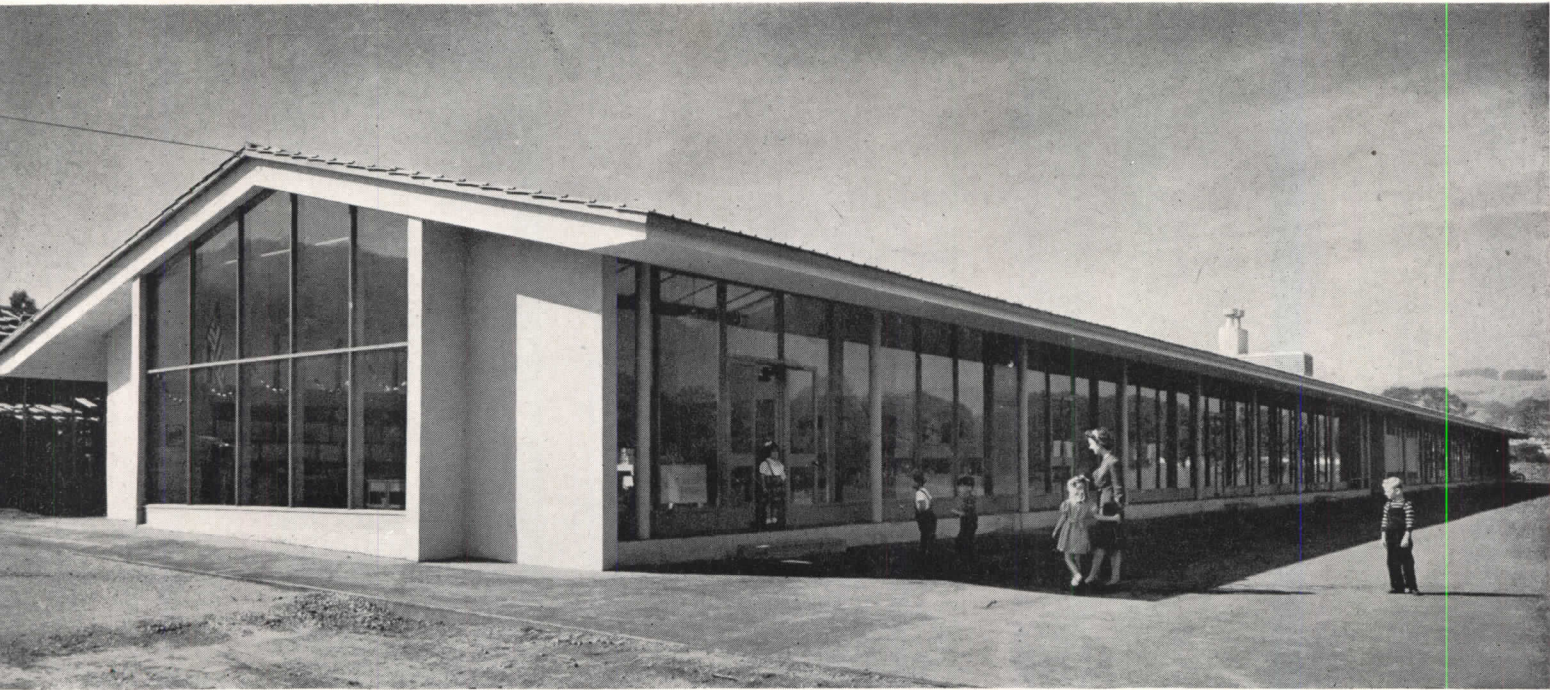

Progress photo at right, from another school, suggests the possibility of using the steel-beam and wood-purlin roof construction (page 80) for a coffered ceiling and pierced overhang admitting slightly more light

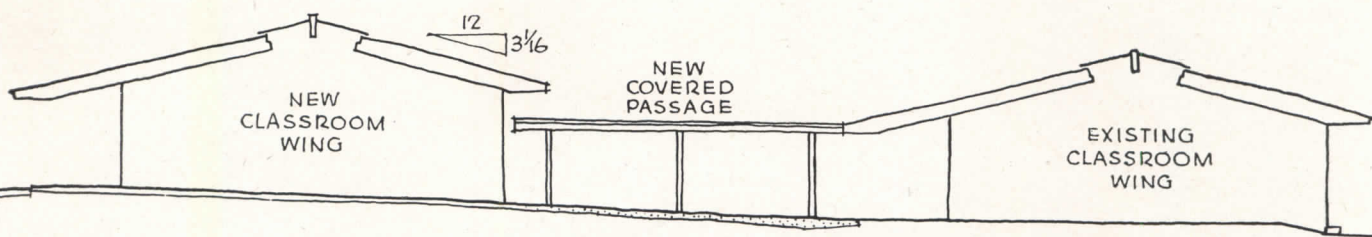
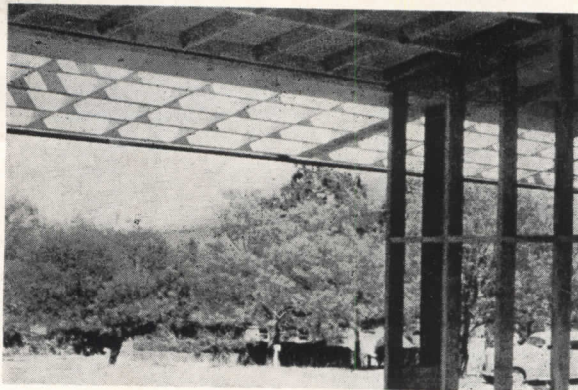

SECTION THROUGH COVERED PASSAGE

Excerpt from a letter from Photographer Roger Sturtevant:

"The teacher turned around and I noticed she was wearing a great pair of dark glasses. 'Oh no,' says I, 'we can't photograph that room. After all this talk about even light if we show a teacher wearing dark glasses it would be silly.' We chose the next room with teacher sans glasses. Hal timidly asked her how the light was to work in. She rhapsodized about the joy of even light and subsequent lack of strain, and she damned every other schoolroom she had ever worked in. Thus encouraged, and curiosity at boiling point, Hal snared the goggled teacher. Most apprehensively he asked her if she suffered from glare in her room. 'Why, not at all,' said she. 'Then why,' asked Hal, 'do you wear dark glasses?' In an amazed tone she answered, 'Dark glasses, dark glasses, oh I do have on my dark glasses. I forgot to take them off after we were out in the yard for recess'"

PROLOGUE TO PROGRESS

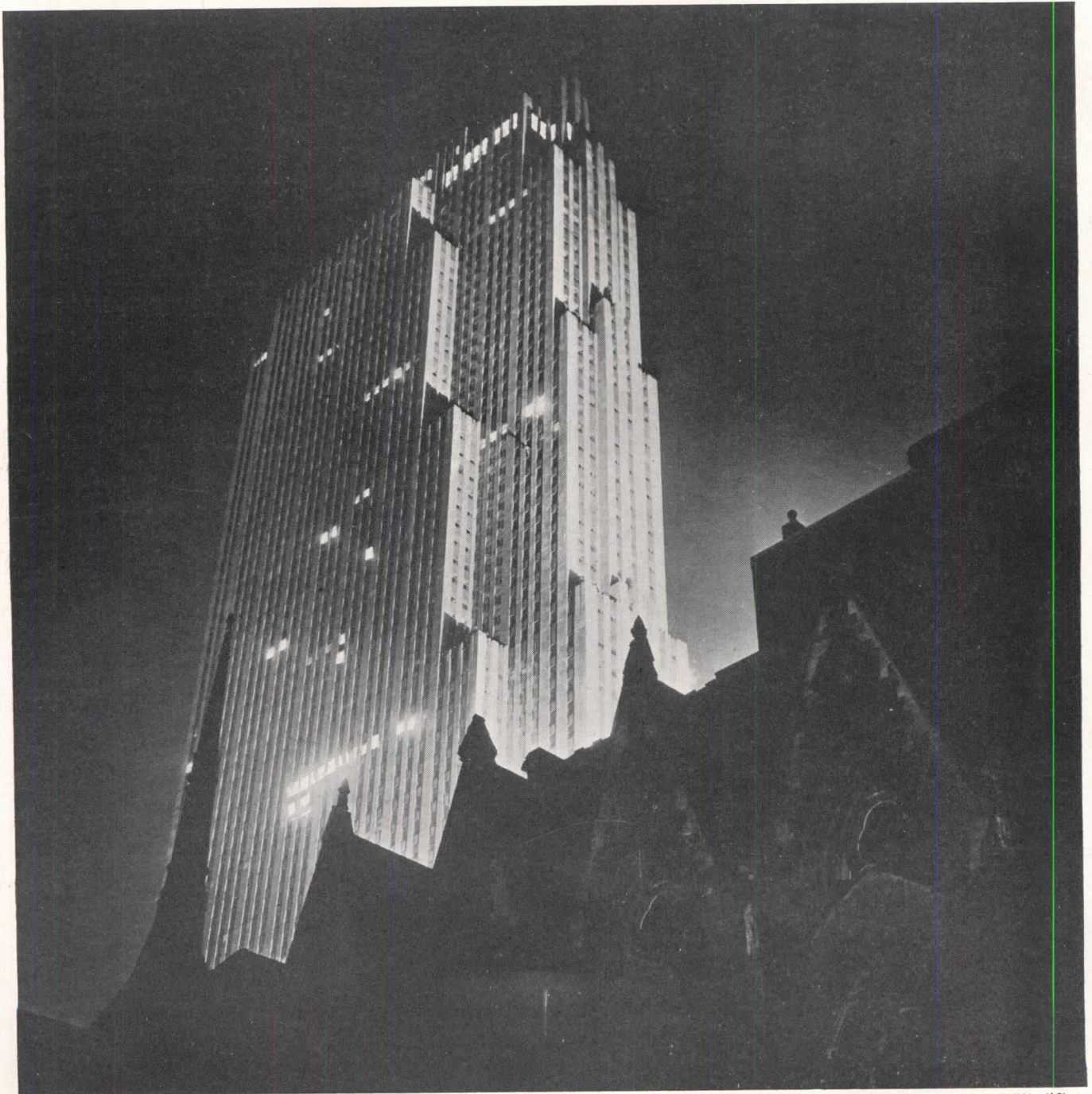

Paul J. Woolf Photo

AN ADDRESS GIVEN BEFORE THE TENTH ANNIVERSARY MEETING OF

BY THOMAS S. HOLDEN

President, F. W. Dodge Corporation

THE ten years which have elapsed since this Washington Building Congress was founded have been years of confusion, years of conflict, years of decision.

In 1937 our economy, barely convalescent from a serious illness, suffered a relapse. It was a year of industrial recession, a year of costly pump-priming experiments, a year of court-packing and other attempts to change our political, economic and social structure into something new and different from that which it had always been. In the midst of perplexity and confusion the American people seemed to have lost faith in their destiny.

The defeatism of those years had not been overcome when the greatest war of history caught us in its toils. Our people entered into this gruesome enterprise with a spirit of grim determination to win, but with, at first, little enthusiasm for the future that might lie beyond a military victory.

In a talk I gave before the Michigan Society of Architects in April, 1942, I listed four sets of fears that so clouded the thinking of the American people at that time that many of them who never doubted that we could win the war were almost certain we could not win the peace. Those fears were: fear of a depression when all-out war production stopped, fear of an unmanageable national debt, fear of Russia and fear of socialism. Even then there were people, of whom I was one, who believed that those fears were exaggerated and that those problems would be successfully met.

Let us look at the record.

Reconversion of our economy to the uses of peace has been accomplished, not with a depression, but with the greatest volume of production and of employment in our peacetime history. A beginning has been made toward reduction of the federal debt; it is still a major problem, but everyone knows that prudence and good management can handle it.

Russia's postwar behavior has been a shock to those who believed it would be comparatively easy to find a satisfactory live-and-let-live basis for getting along with our one-time ally. I do not consider myself competent to appraise the menace of Russia's postwar behavior. But, in this connection, I would like to quote a state-

ment by Walter Lippmann, one of our most intelligent observers of international affairs, who recently returned from Europe. On November 4, he said:

"My strongest impression after a tour in eastern and in western Europe and in Germany, is that the Russians have lost the cold war, and that they know it. We, on the other hand, do not know this, and are afraid to believe it, have mistaken the violence of Mr. Vishinsky's language for Russian power, and are, therefore, unprepared to use constructively the opportunity for a European settlement which is closer at hand than we think it is. . . . Our problem is not how to contain the Soviets. They are contained. It is to push toward a settlement which permits the recovery of Europe and of the world, and to relax the tension, to subdue the anxiety, and to end the panic."

With the fourth menace to their postwar peacetime progress, socialism, the American people have dealt effectively. To be sure, they were never asked outright to vote for socialism, and thus have had no direct opportunity to vote it down. But under the guise of national economic planning various socialistic programs have been offered and tried out; most of them have been rejected. The planners who tried to perpetuate OPA, the ones who tried in 1946 a vast government housing program and conspicuously failed with it, and the ones who have recently concocted a new synthetic crisis out of the Marshall plan and the current price inflation are, I believe, in full retreat. Our people have not only poured many billions of dollars into socialistic experiments at home; they invested another three and three quarter billions in the British national planning experiment. Perhaps that final object lesson in futility was worth the price.

The idea of national planning seems to thrive best in an atmosphere of fear and defeatism. In the mighty effort of war the American people rediscovered their own strength and their own capacity. They conquered fear. They recalled in time that their own freedom was more precious than the supposed security offered by the planners. They recovered their ancient faith in American ideas and in themselves. Again quoting Walter Lippmann (and this is something he wrote five years ago): "There has come out of the nation itself, out of this people who have not been very pleased with themselves for twenty years because they were not using their faculties for great ends, a veritable explosion of national energy which will shake and shape and alter the world." Another writer, John Gunther, concludes his recent book, *Inside USA*, with this statement: "This country is, I once heard it put, absolutely 'lousy with greatness' — with not only the greatest responsibilities but with the greatest opportunities ever known to man."

This energy of which Mr. Lippmann spoke, this energy which shakes and shapes and alters the world, is the stuff of which a great civilization and a great society are made. It is the ingredient which cannot be measured, weighed or enumerated in statistical tables. It is, therefore, the factor that the planners cannot

THE WASHINGTON BUILDING CONGRESS

"Should not the construction industry be vital and dynamic, characterized by maximum diversity and flexibility . . . Should it not progress without becoming standardized . . . Should it not live by rules that guide but do not regiment?"

Wide World Photo

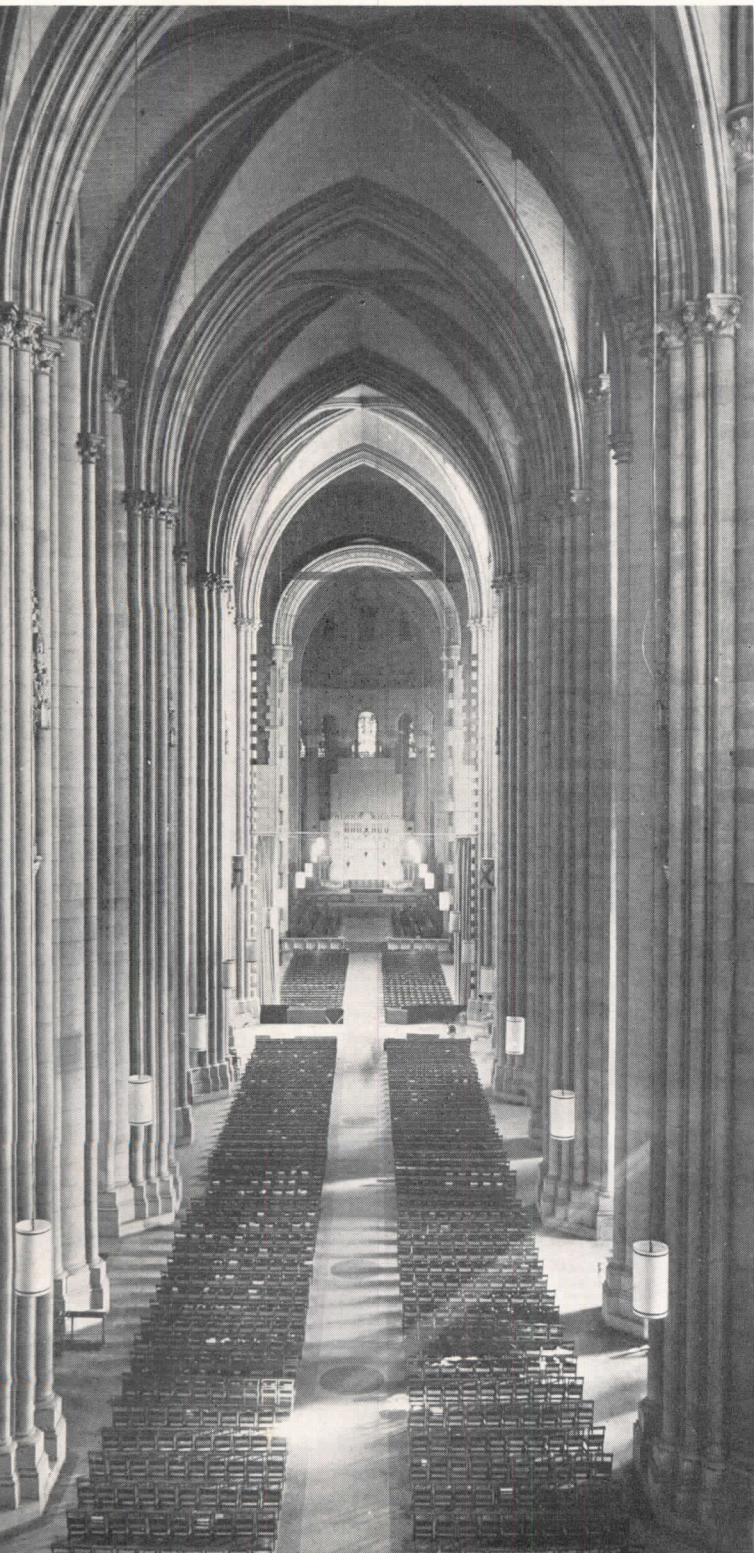

control; sometimes I wonder if it isn't something they do not understand.

In spite of our censuses of population, our maps of natural resources, our inventories of factories, schools, churches, automobiles and telephones, our American society is not easy to understand. Here is what an outstanding American, David Lilienthal, said a short while ago: "What we have, actually, is not a system at all, but almost its opposite, that is, a society of the greatest imaginable diversity, and flexibility, taking things as they come, deciding how to handle situations by the facts of each situation itself—'doing what comes naturally.' The only way in which it can be said to be a 'system' is to say our 'system' is to have no system." I might sum up by saying that a system is that which defines limitations, whereas our American society is one which defies limitations. The American economy includes three and a half million independent business enterprises and six and a half million farms, a total of ten million centers of economic initiative. It is impossible to conceive any system originated by planners with finite minds which would not measurably curtail the energy, resourcefulness and invention of such a society.

A friend of mine once described to me the difficulty of understanding our society and our free enterprise by asking me to think of the bewilderment of an observer from Mars who might find himself in New York's Grand Central Terminal at the rush hour. Viewing the milling crowds moving in all directions at once, he would likely say: "This is chaos." But it isn't chaos. Every man and woman and child knows exactly where he is going. His destination is his own business, whether it be Chicago, Montreal, Mamaroneck, or the Lexington Avenue exit. He expects the terminal officials to supply him with an information booth, ticket windows, time tables, gates with the trains plainly marked, and a few other essential services and conveniences. He decides his destination and finds the way to get there. An excellent way to produce chaos would be to try for detailed regulation of the traffic. The chaos which the Martian seems to see rests in the limitations of his own comprehension. Put an economic planner in there and he will soon turn out to be a policeman.

To this society without a system history has passed the torch of western civilization, the responsibilities and opportunities of leadership in the western world. A nation which, in bewilderment, ran away from its destiny twenty-five years ago, is now facing its destiny in sober, quiet confidence. Can there be any doubt that this country will meet its peacetime responsibilities? Can there be any doubt that, in meeting them, it takes advantage of the greatest opportunity for expanding prosperity that this or any country ever had?

An expanding civilization must build. Every new industrial enterprise, every new social organization, every new means of transportation, every new family, every new program in the fields of religion, education and public health, requires appropriate facilities of the most advanced type. The opportunities for advance-

ment of the American construction industry coincide with the opportunities for advancement of American civilization and prosperity.

What kind of construction industry can best serve this vital and dynamic American society?

Should not the American construction industry be itself vital and dynamic, characterized by maximum diversity and flexibility? Should it not progress through development of sound and ever-improving standards, without ever becoming standardized? Should it not live by rules that guide but do not regiment? Should it not be capable of producing, with a minimum of time and

of construction of any year in the country's history. Many of its projects were completed ahead of schedule. Even while work proceeded at breakneck speed, there were adopted startling innovations in design and construction methods. In the midst of war a modern efficient home-building industry was created. Builders applied their assembly line techniques to building ships, their management know-how to operating industrial towns and wholesale forwarding and shipping of millions of tons of war material abroad for account of the armed services. Within the armed services themselves the army engineers and the Seabees displayed

"Should it not be capable of producing, with a minimum of time and effort, any kind of structure, any time, anywhere?"

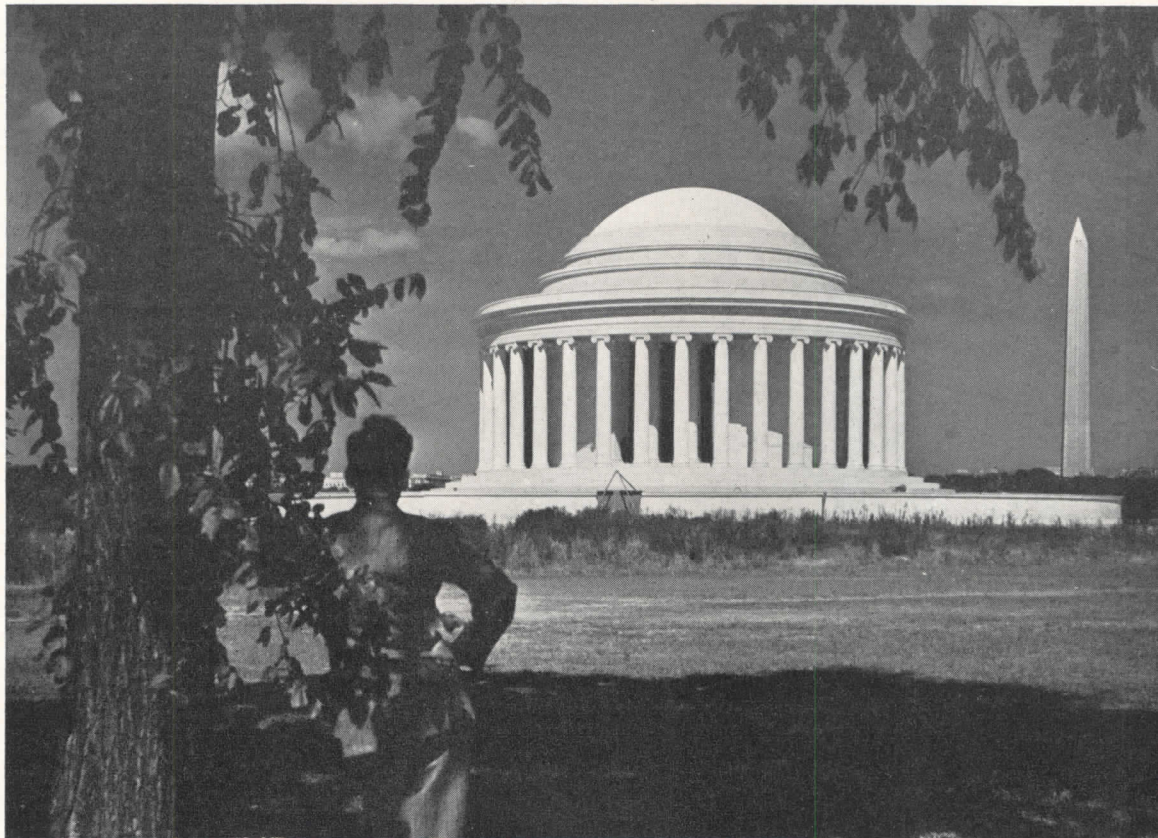

Wide World Photo

effort any kind of structure, at any time, anywhere?

I am convinced that, of all our great American industries, construction is the one which combines greatest diversity and flexibility with high technical and managerial competence. If proof is needed, the vast and manifold performance in war construction can be cited. This industry didn't need to convert to war, or reconvert to peace; it simply did what came naturally.

To meet the urgencies of war mobilization and war production it switched overnight from office buildings, schools, churches and other civilian facilities to naval bases, cantonments, flying fields, shipyards, war plants and war housing. In a brief time it doubled its prewar capacity, completing in 1942 the largest total volume

energy and resourcefulness not surpassed by any other branch.

Unfortunately, the great performance of the American construction industry, in war and peace, is not half appreciated by the American people. This people, with its love of short-cuts, has grown into easy acceptance of slogans in lieu of truth; and one of the most frequently repeated slogans is the one about the supposed backwardness of the construction industry. So often has this silly statement been reiterated by so-called housing experts, facile journalists and radio commentators, that the idea of backwardness has become fixed in the public mind; even some people in the industry have begun to believe it.

I would like to ask this question: To what other country shall this backward industry look in order to get its methods up to date, to improve its know-how and to win the commendation of its critics? The fact is that during the war such countries as Great Britain, Russia and France sent official commissions of architects, engineers and builders over here to find out how our construction industry functions. They don't seem to think we're backward.

Show me any other country which, during the war, developed revolutionary new techniques of factory design and layout. Show me another country that can match the parkway systems of Westchester County and Connecticut. Show me another country where the family of average income is better housed, in better neighborhoods and with more comforts and conveniences, than in the United States. Show me another country where an Empire State Building can be completed in eighteen months. And, finally, will you please show me any other country which wastes so many millions of words belittling the capacity and accomplishments of its builders?



"... it switched overnight from office buildings, schools, churches to naval bases, flying fields, shipyards, war plants"

"But," say the critics, "that isn't what we meant. Just look at the automobile industry." Well, let's look at it.

The American automotive industry is a marvelous industry, one of America's modern industrial miracles. It makes motor vehicles, and makes them better and cheaper, than any other motor vehicle manufacturers can make them. It makes a reasonable variety of passenger cars, trucks and trailers. It has made them so well that its product has wrought vast changes in the economic and social life of America.

But what does the construction industry make? It makes the parts factories, and the assembling plants where the automobiles are made. It builds the sales rooms, the service stations, the public and the private garages. It builds the hard-surfaced highways and the scenic parkways, and the bridges over which the automobiles travel. It makes these and many other things.

It builds passenger and freight terminals and airports. It builds schools and hospitals and churches. It builds hotels and apartment buildings and houses. It lays down water mains and sewers. In each of these many categories it builds to many different designs, to meet the varying needs of ten million enterprises and a hundred and forty million people.

For such an industry the criterion of competence is its diversity and flexibility, its ability to do its own job well, and its capacity to progress, not its similarity to or dissimilarity from another industry whose functions are totally different. I maintain that there is no common yardstick by which these two great industries can be compared in order to evaluate their relative efficiency. Seen in true perspective, the job of producing motor vehicles is a very simple thing compared with the job of designing and producing all the apparatus for a diverse and complicated civilization. The construction industry is called upon to create facilities for production, transportation, commerce, education, religion, recreation and the 24-hour a day living requirements of 140,000,000 people.

Both industries are currently facing a common problem, the problem of catching up with a backlog of accumulated demand in a period of shortages and price inflation. This year, second full year after cessation of hostilities, housing completions will reach an estimated 85 to 90 per cent of previous peak production; passenger automobile production will be 75 to 80 per cent of its previous peak. The would-be car purchaser is currently promised delivery in 12 to 14 months if he is ordering a Ford, eight to 10 months if it is a Buick. He can get immediate delivery of a new car by paying a stiff premium price to a so-called used car dealer. Many prospective purchasers of houses are also having to wait. Purchasers of used houses have been paying scarcity prices, just as purchasers of used cars have been doing. Purchasers of new houses have had to pay premium prices, not charged in any dealer's mark-up but in the scores of excess cost items that the builder has had to pay in the shortage market.

Here are two major industries, both operating under the difficult conditions of transition from war to peacetime production, both as yet unable to meet current demands. Yet I have heard no one charge the automotive industry with inefficiency or backwardness, or suggest that the government could do a better job. The automotive industry has a better press.

If the American people can be persuaded to appraise the construction industry by the best of its accomplishments, and by the high competence of its average accomplishment, they will learn to be proud of it. They must somehow be brought to realize that you cannot have diversity and flexibility without a large measure of freedom, and that you cannot have freedom without tolerating a fair degree of variation in competence and in business practices. As I see it, the way to improve the industry's efficiency is to liberate it from the little monopolies and the petty restrictive systems that impede its forward progress.

Those abuses which are most frequently criticised are only partly of the industry's making. They consist principally of monopolistic or uneconomic practices at the local level. Certain of them are deeply embedded in federal, state and local laws. I am thinking of the immunities of labor unions from anti-trust prosecution, of licensing laws and laws restricting or regulating bidding practices, and local building codes. Beyond these outmoded laws are restrictive trade practices that limit competition and block progress. It is to be hoped that current Congressional investigations will point out sound ways in which some, if not all, of these abuses can be corrected.

Federal legislation may liberate the industry or it may impose new shackles on it. The Federal Home Loan Bank System and the FHA liberated home building from the handicaps of horse-and-buggy home finance. The standards they established contributed greatly to the progress that has been made in house design and in home-building methods during the past ten years. Use of these home-financing facilities has been voluntary, not compulsory. Therefore these institutions have served to widen opportunities for building progress. How different was the philosophy of the veterans' emergency housing program, which sought to accomplish its purposes by means of controls and restrictions; it failed as it deserved to fail.

In his recent speech which I have already quoted earlier in this talk, Mr. Lilienthal mentioned a third characteristic of our society which is just as important as its diversity and its flexibility. He said: "I am asserting that the vitality of our distinctive institutions of production and distribution of goods depends not upon rigid and fixed economic principles, but upon ethical and moral assumptions and purposes; that our unparalleled productivity and standard of living are not the consequence of an economic system, but rather the other way around; that our economic success and our flourishing economic institutions are the consequence of our ethical and moral standards and precepts, of our democratic faith in man. We have ethical guide lines in this country. We have developed rather highly a sense of what is right and what is wrong, of what is fair and decent, and what is just crude use of arbitrary power."

This Washington Building Congress was founded ten years ago, a free association of construction industry men, dedicated to promotion of ethical standards in the construction industry, to promotion of technical competence and improved relationships among the diverse groups that form the industry. Your progress and the progress of your industry throughout the nation has paralleled the progress of our great country. It has been a progress from doubt and defeatism to renewed faith, a progress from struggle to accomplishment. I congratulate you on the successes of the past ten years. I congratulate you on the great future that lies ahead, for our country, for our industry, for those organizations and associations that work unceasingly for better understanding, better service, and better accomplishment. The past is only prologue.



Wide World Photo

"Show me another country that can match the parkway systems . . . Show me another country where the family of average income is better housed, in better neighborhoods and with more comforts and conveniences . . ."

McLaughlin Air Service Photo



HOSPITALS

FOR THE COORDINATED HOSPITAL SYSTEM

Division of Hospital Facilities

U. S. Public Health Service

Federal Security Agency

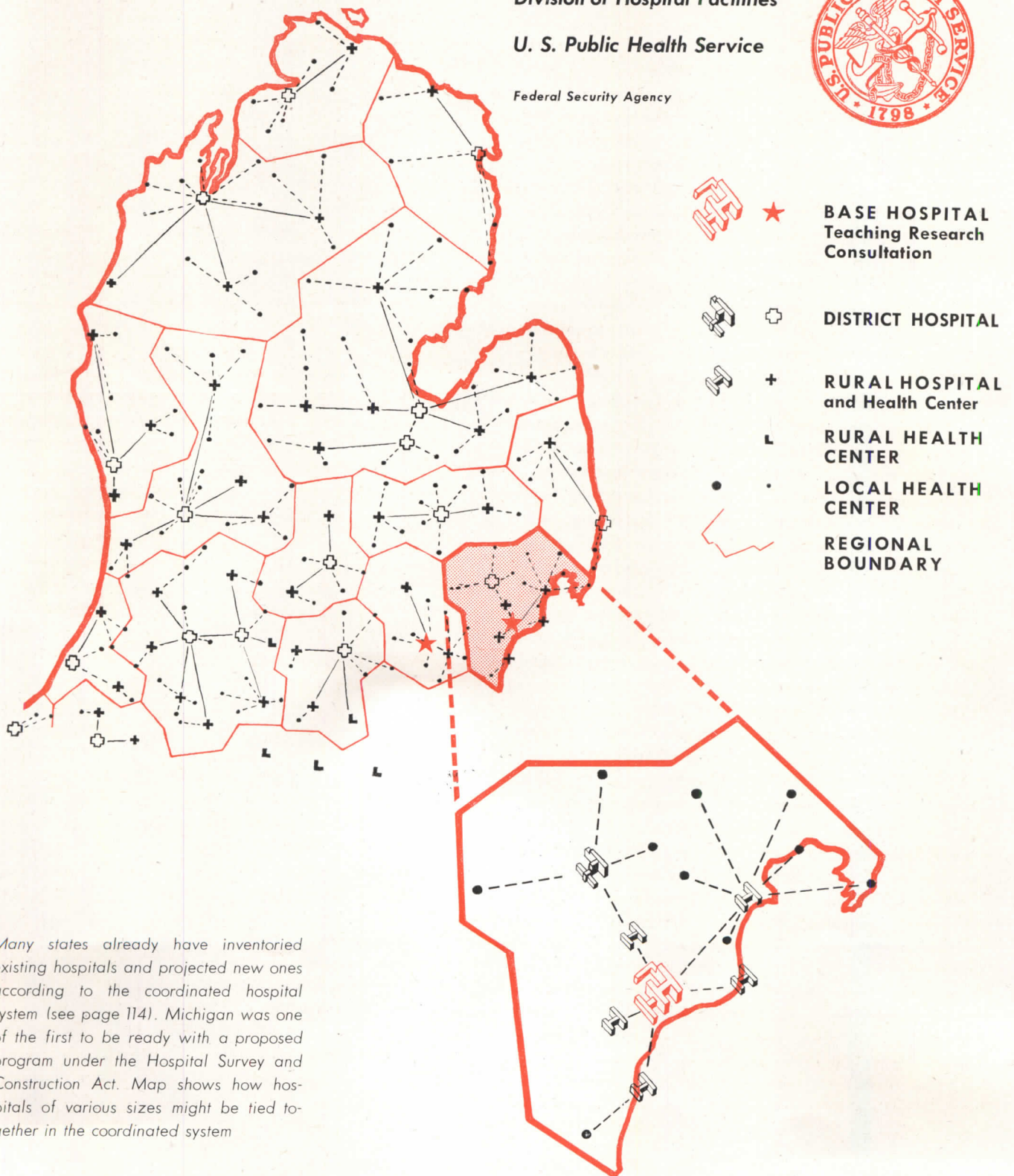

Many states already have inventoried existing hospitals and projected new ones according to the coordinated hospital system (see page 114). Michigan was one of the first to be ready with a proposed program under the Hospital Survey and Construction Act. Map shows how hospitals of various sizes might be tied together in the coordinated system

TYPE PLANS FOR THE GENERAL HOSPITAL

SOME two score years of research come to fruition in the hospital type plans presented in this Building Types Study. As far as architects are concerned, the U. S. Public Health Service has, in recent years, developed a kind of planning research which architects have long been asking for. Here is a group of architects and engineers doing field research, consultation with medical and public health authorities, sociologists, with equipment specialists and material manufacturers, and working all their findings down into specific planning suggestions for architects.

While all of this study is aimed at the objective of better hospitals for the nation, for the architect it has had a by-product — the selling of the services of the individual architect. Hospital boards and medical personnel have gained a new appreciation of the importance of sound planning, and of higher standards of plan and construction. Marshall Shaffer, chief architect, and his staff have always insisted that their suggestions should never be taken too literally in any given project; there must always be a private architect to be the final arbiter; anything of the order of a "plan service" would be unthinkable in hospital design.

In a sense the "hospital type plans" here presented complete the first package on the design of general hospitals. For some time ARCHITECTURAL RECORD has been publishing interim reports: 1. Public Health Centers, July, 1942; 2. "Hospitals" (the coordinated hospital service plan illustrated with some type plans), August, 1945; 3. "Elements of the General Hospital" (detailed room layouts for all departments of the general hospital) June, July, August, 1946. This present study completes the type plans, which put the departments together in integrated plans for the types and sizes of general hospitals which would have a place in the overall plan for hospital construction.

Included here are: two small community clinics, one with an 8-bed nursing unit, the other with a 10-bed unit (these are "outposts" of the coordinated plan, are not considered true hospitals); and general hospitals of 30, 40, 75, 100, 150 beds. Two others — general hospitals of 50 and 200 beds — are included in the list of suggestions; these remain as published in the August, 1945, study in ARCHITECTURAL RECORD.

Release of the type plans is timed for the beginning of the construction phase of the vast hospital program made possible by the Hospital Survey and Construction

Act (Public Law 725), passed by Congress in August 1946. This Act authorizes federal aid to states totaling \$3,000,000 for surveys of hospital needs, and \$375,000,000 for construction over a five-year period. Since the direct aid to states amounts to one-third of the cost, these funds will make the hospital program total \$1,125,000,000.

Already most of the states have set up the required organizations to survey their needs, plan a state-wide program of new construction and handle contracts for hospital projects. Many of the programs are started. Text on the following pages deals with state programs and architects' functions in state and local communities.

The hospital plans conform with the coordinated hospital system developed by the U. S. Public Health Service (chart, opposite page; for detail see page 114). In brief this plan calls for constant exchange between hospitals of information, training, personnel, and for the referral of patients from one unit to another as their needs demand. Large and small hospitals would be knit together into an integrated operating system. New buildings would be planned and equipped according to their place in the scheme, not as isolated competitors.

Rarely has so comprehensive a program been favored with such complete cooperation as this one has engendered. The whole vision, including such coordination as mentioned above, far from being a sudden bureaucratic concoction, has developed over a period of several years. Since before the legislation was formulated, every interested group has had its say, from health authorities to nurses, from hospital trustees to farm organizations, from architects to labor unions, from doctors to kitchen help. In administering the construction program, the Health Service is guided by a federal advisory council; it has eight members, four "experts" and four representatives of "consumer" groups. Various sub-committees serve the Council and the Surgeon General, including a technical one headed by James R. Edmunds, A.I.A., and three other architects.

It is important to remember, however, that while the law requires that federal funds be handled under federal supervision, the programming and planning and construction of hospitals is handled by the communities themselves. It is at this level that the architect must exercise his initiative, to the end that the whole plan will realize its objectives of better hospital and health facilities, particularly for the rural areas.



U. S. Public Health Service Photo

THE PRESENT OPPORTUNITY

By Thomas Parran, M.D.

Surgeon General, U. S. Public Health Service

TWO years ago, when the first plans in this series appeared, I remarked on the great opportunity which lies ahead in the field of public health. More than ever before, the American people are well-informed in health matters and vocal in their demand for better health services. At the same time, our scientific and technological achievements in wartime have given us new confidence in our ability to meet these demands.

On the other hand, I noted with concern that the increasing complexity of medical practice is having unfortunate consequences for our rural population. The old-fashioned country doctor is vanishing; the young physician, trained to depend on modern medical facilities, is not replacing him in areas where those facilities are lacking.

The situation remains the same today. But in the meantime, the nation has taken a great step toward the fulfillment of its health needs. The Hill-Burton Bill — now the Hospital Survey and Construction Act — has become law, and has set in motion a nation-wide program to provide health facilities for all citizens, according to their need.

Under this program, the states, with federal assistance, are surveying their needs and developing long-range plans for construction of hospitals and health centers. If the program is fully realized, the next four years will see the expenditure of \$1,125,000,000 for construction, one-third of it from federal funds. Priority is

to be given to areas having the greatest need — especially rural areas and those with low per capita income.

Nevertheless, this program will provide only a partial answer to our problems. It will be many years before our basic needs for health facilities can be fully met. We are further hampered by a shortage of physicians, of nurses, and other personnel who cannot be trained overnight. We cannot, in these circumstances, afford any duplication of facilities, any inefficiency in the organization of medical services. We must plan soundly for the maximum use of both personnel and facilities.

The concept of the coordinated system, which is illustrated herein, is thus doubly important at the present time. This concept, while new to most areas of the country, has been successfully applied in varying forms in a number of instances. It will doubtless be some time before the interrelationships can be fully worked out in many areas. It is nevertheless important that our future hospital construction should lay down a pattern within which these relationships can develop logically and efficiently.

Such patterns are being laid down in the State Plans now being formulated under the Hospital Survey and Construction Act. It is hoped that all concerned with planning and construction of hospitals will work with their State planning agencies, so that every institution will be designed to fit the pattern being established for the area it will serve.

THE ARCHITECT'S RESPONSIBILITY

By Henry H. Saylor, for Douglas William Orr, President, American Institute of Architects

ONE of the most ambitious programs this country has ever tackled, leading to a rational distribution of our facilities for hospitalization and public health, is now well under way. Architects in private practice will do all the work. Advising the Surgeon General from the inception of the Hospital Survey and Construction Act is James R. Edmunds, Jr., A.I.A. as Chairman of the

Technical Committee of the Federal Hospital Council.

It is not going to be easy to turn this vision into achievement. Already there are formidable obstacles rising to challenge our progress. One of them is the fact that we can design and build hospitals faster than we can staff them — walls of brick and the equipment that goes within them are put in place more quickly

than we can educate and train the doctors and nurses to make these plants function. Another obstacle, of course, has been mounting building and operating costs.

On the bright side is the record of accomplishments. Most states have architectural representation on the State Hospital Advisory Council. Many states have arranged for state-wide meetings with their registered architects in order to present to the profession the State Hospital Plan. Still others have taken advantage of their opportunity to secure professional guidance from the State A.I.A. Chapters and Associations in formulating the technical and construction phases of the State Plan. The Surgeon General has accomplished this at the federal level by the Technical Committee of the Federal Hospital Council referred to above. It has been said again and again, but it seems necessary to repeat it here, that this is a program for the individual states. Theirs is the responsibility. The federal assistance is available for those states which are awake to their needs and to this opportunity. The first requisite is a State Hospital Agency with an adequate technical staff empowered to handle the job — and the architects of the state must realize that it is incumbent upon them to become familiar with the State Hospital Plan in order to be in a position to properly serve the people of their state.

The resolution adopted by the Grand Rapids Convention of The American Institute of Architects is still fresh in our minds. It asked (1) that the profession be kept fully advised of the progress of this program; (2) that an architect be placed on each State Advisory Council;

(3) that technical assistance be extended by Chapters and State Associations to the State Agencies administering this program; and (4) that all Chapters encourage an active educational program for their members on the various phases of hospital design, seeking also the cooperation of colleges of architecture in this endeavor.

Meanwhile, since Grand Rapids, the seminars of hospital design have become a widespread activity — with the A.I.A. State Chapters and Associations of Michigan, Mississippi, Pennsylvania, California, and Texas pointing the way. And it is well that the profession is conscious of its need for the most advanced thinking in the hospital field. Someone has said that we of today are setting the pattern for the hospitals of the next quarter century here in the United States. And they must be good!

At this stage of the Hospital Program, every architect should know that there is a national clearing house for technical information on hospital and health center design; whether or not the project in which he is interested is in the present national program, he would do well to make a note of its name and address: Division of Hospital Facilities, United States Public Health Service, Washington, D.C. Its Medical Director is Dr. V. M. Hoge. It does *not* design hospitals; what it does is to pass on to the architect, at his request, the fruits of the latest thinking by its personnel of specialists in hospital design, hospital administration, nursing, medicine, and equipment. And at the head of the Office of Technical Services of the Division is an A.I.A. architect, Marshall Shaffer.

THE HOSPITALS' PLACE IN THE PROGRAM

By George Bugbee, Executive Director, American Hospital Association

A HOSPITAL'S capacity to serve its community depends in no small degree upon careful functional planning and sound construction. Funds contributed in good faith by the community too frequently are wasted in poorly planned and poorly constructed hospital plants. The losses incurred through poor hospital construction, great as they may be, cannot be calculated in dollars and cents alone. *The most important loss, which continues over the years, is in quantity and quality of service that cannot be delivered although paid for.*

For these reasons the American Hospital Association long has had a major interest in hospital architecture. This is why it has urged and encouraged architects to specialize in hospital work. While hospital construction in the past has been but a small part of the total building industry, the backlog of need is now tremendous. The Hospital Survey and Construction Act will help to provide \$1,125,000,000 worth of hospitals and other health facilities in the next five years. Even this

large sum, however, will meet barely 13 per cent of the need as disclosed by state surveys.

A program of this magnitude — of such social and economic significance — must employ the best in scientific hospital planning and design. The accompanying section by the Division of Hospital Facilities, U. S. Public Health Service, is an important contribution to the science of hospital planning. This division also administers the Hospital Survey and Construction Act.

While the described units are built around the theme of a coordinated hospital system, each facility is physically complete in itself. It is hoped, however, that the designs suggested will not be followed blindly by the architect of the community hospital. While basic principles are fairly constant, details are highly variable. Requirements of the medical staff, the comparative resources of the community, the climate, the site conditions, in fact a broad category of variables demand that each hospital be designed with its own individuality.

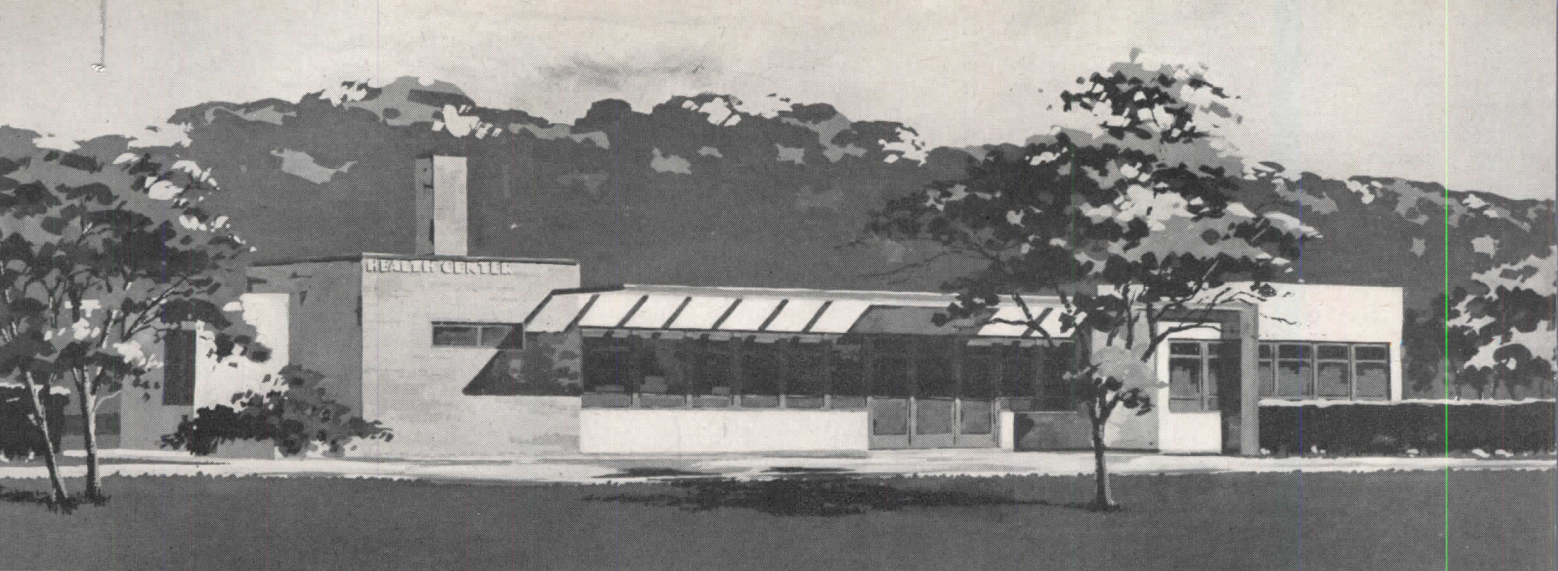

Stanley Reese, De

8 BEDS

COMMUNITY CLINIC WITH NURSING UNIT

An Outpost for the Coordinated Hospital System, for Rural Areas

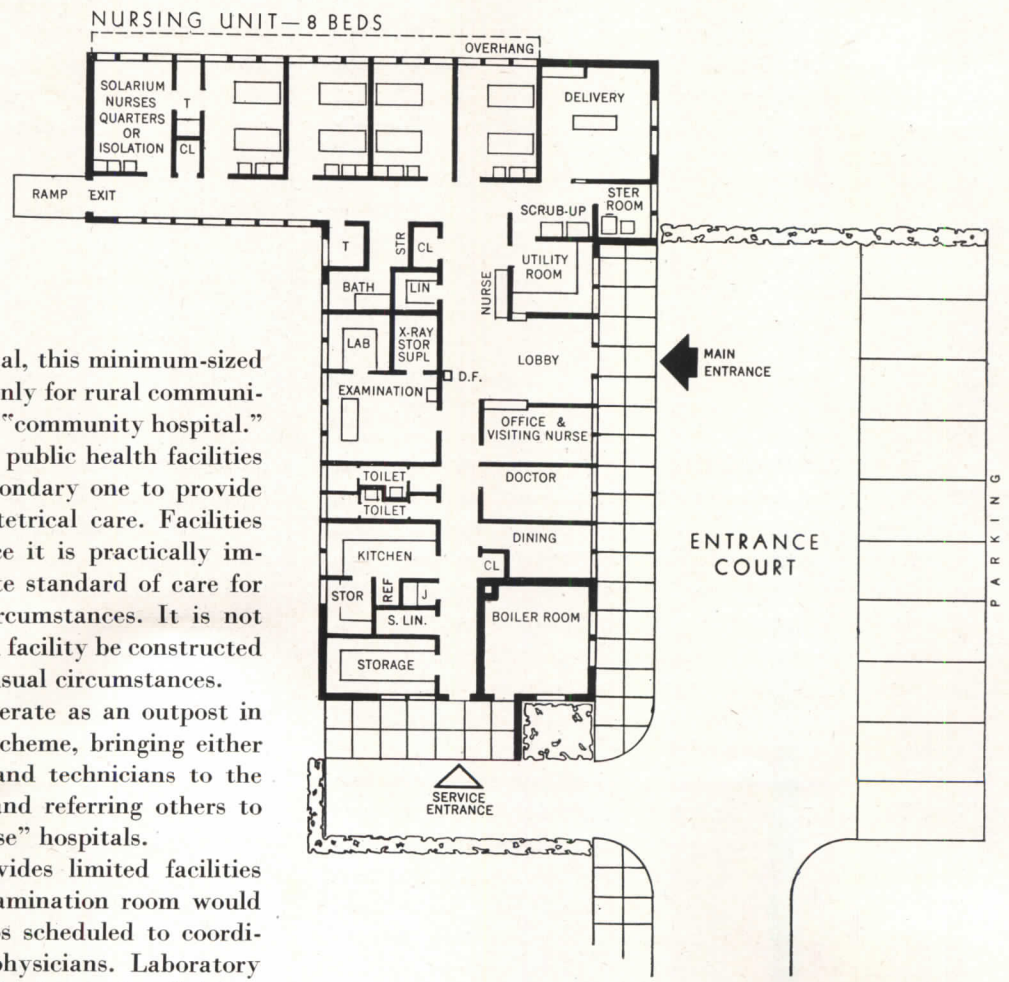

TOO small to qualify as a hospital, this minimum-sized community clinic is intended only for rural communities which cannot support even a "community hospital." Its primary function is to bring public health facilities to the small community; its secondary one to provide nursing service, mainly for obstetrical care. Facilities for surgery are not shown, since it is practically impossible to maintain an adequate standard of care for surgical patients under such circumstances. It is not recommended that such a limited facility be constructed in any community except in unusual circumstances.

Such a unit as this would operate as an outpost in the coordinated health service scheme, bringing either resident or visiting physicians and technicians to the locality, handling minor cases and referring others to "community," "district," or "base" hospitals.

The health center wing provides limited facilities for public health work. The examination room would serve for various clinics, perhaps scheduled to coordinate with its use by private physicians. Laboratory facilities also would serve for multiple use, by clinician, epidemiologist, nurse, and sanitary engineer.

TOTAL GROSS AREA 4,391 SQ. FT.

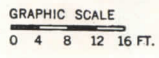

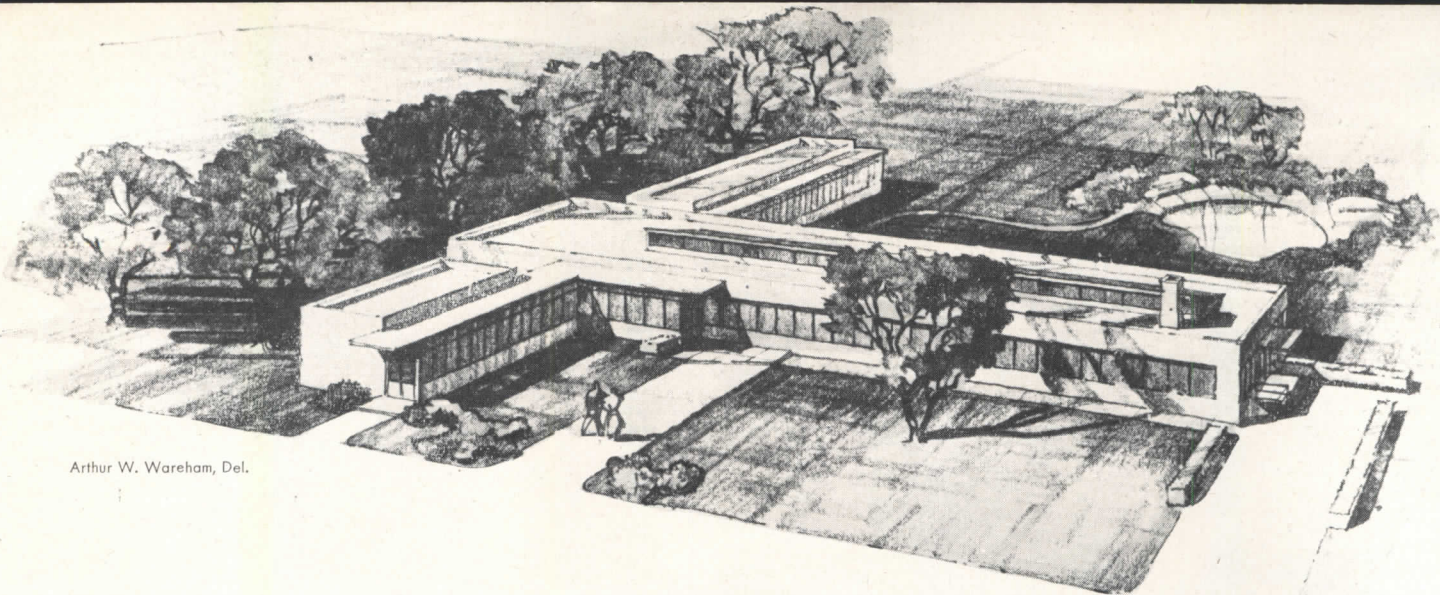

Arthur W. Wareham, Del.

10 BEDS IN COMMUNITY CLINIC

An Expansible Design for Basic Rural Needs

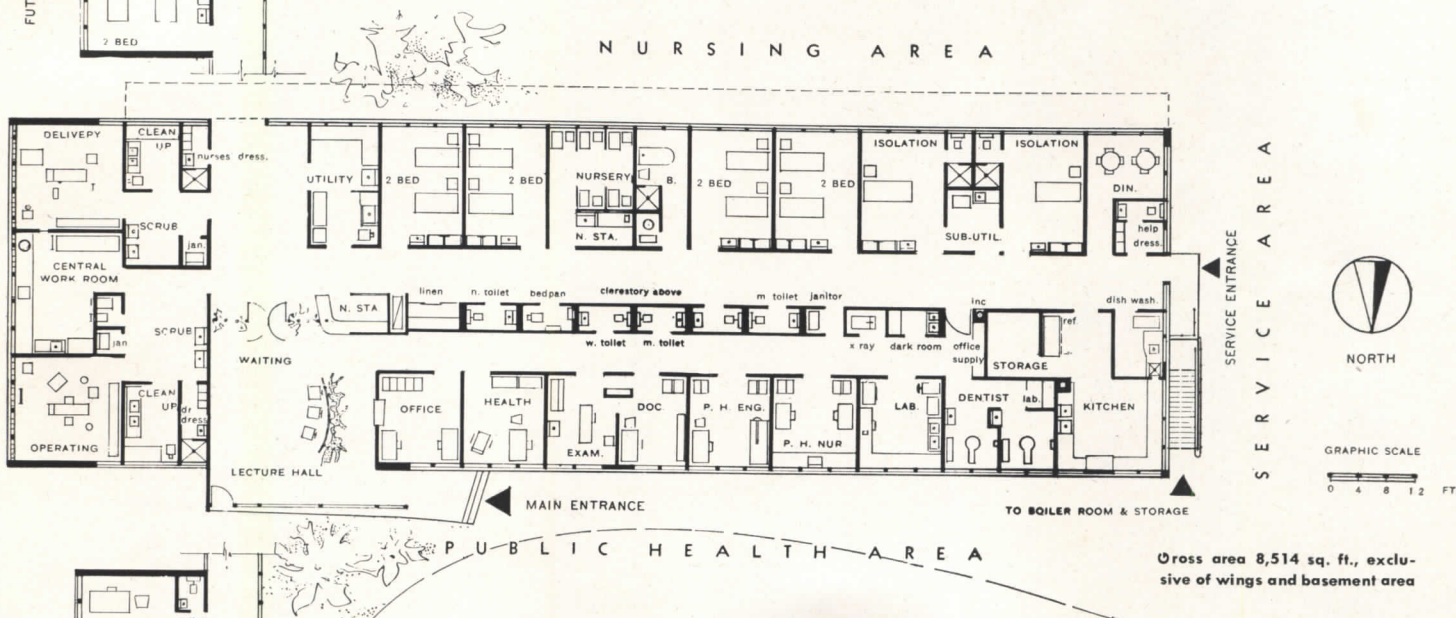
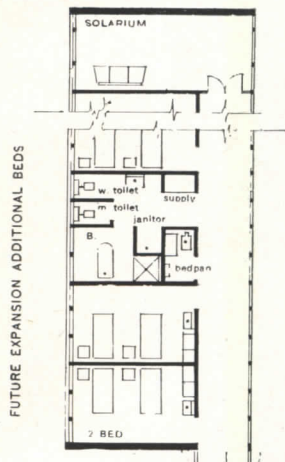

Gross area 8,514 sq. ft., exclusive of wings and basement area

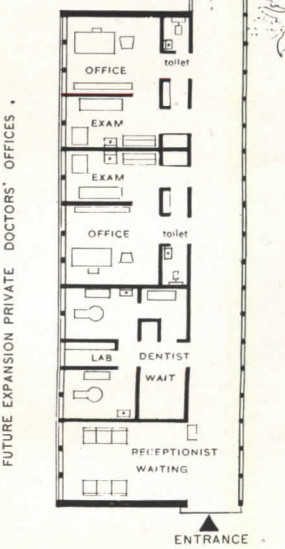

THE community clinic with a 10-bed nursing unit as illustrated here embodies most of the basic needs of the small but fairly complete public health center-community clinic, and yet is flexible enough to permit the local architect to adapt it to specific community requirements. If initial construction is minimum, future expansion is possible on any axis of circulation. It will be noted that even in a community clinic of only 10 beds a complete separation has been made between delivery and minor surgery rooms. Office space for private physicians, of course, may not be necessary or desirable in some instances. For this reason that area is not shown in complete detail and may be omitted. The combining of all these facilities does, however, promote continuity of services, convenience, and economy.

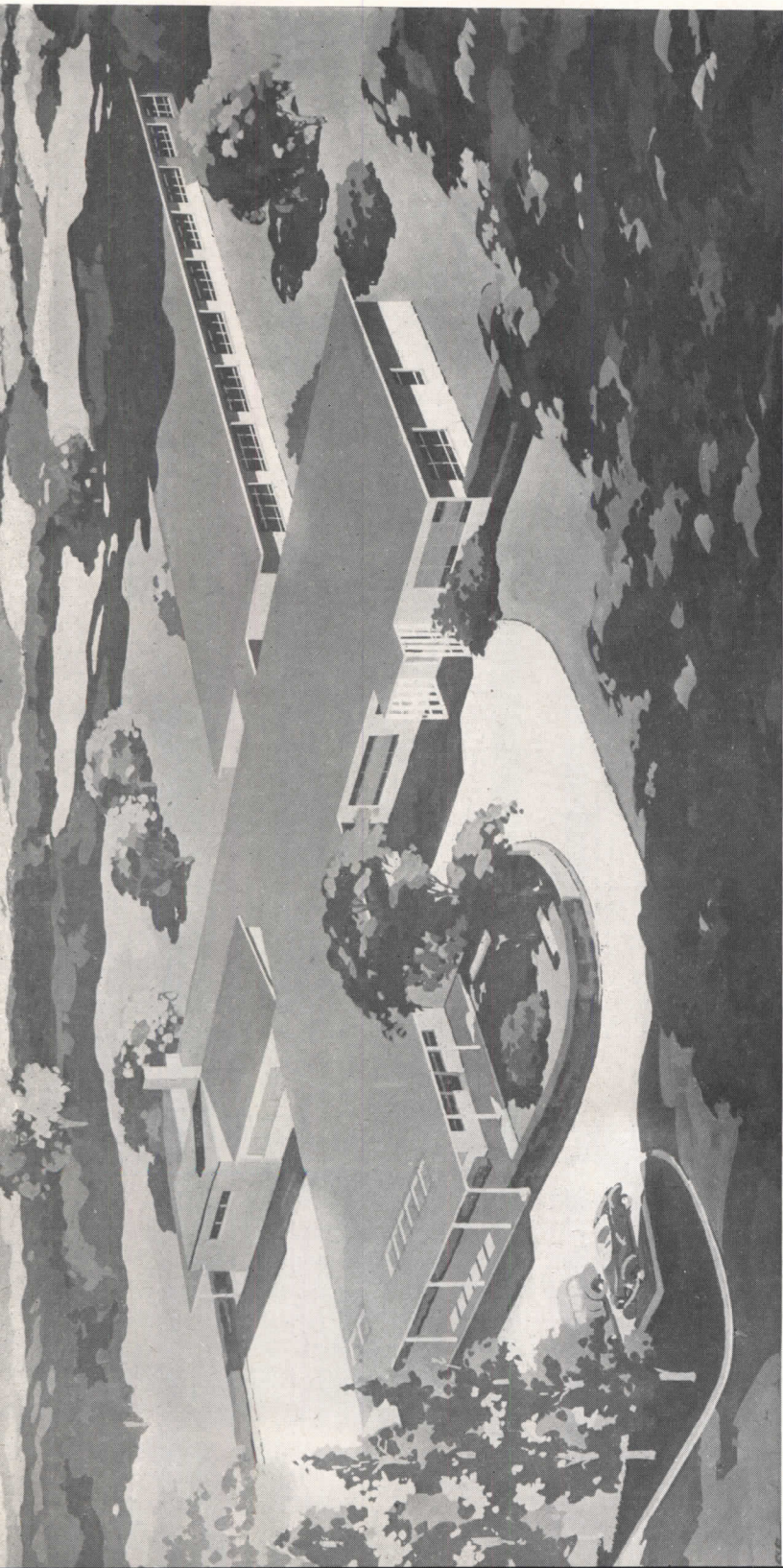

30 BEDS

THIS plan has been developed as an example of the smallest practicable general hospital. Normally, a community which cannot support a hospital of 40 to 50 beds should build a community clinic, and depend on neighboring areas for in-patient care. However, a 30-bed institution may be desirable if the area is far removed from other general hospitals. With reduced staff, equipment, and bed capacity, this hospital is nevertheless designed to provide all of the services expected of the 50-bed or larger community hospital in the coordinated hospital system. General medical, uncomplicated obstetrical, and minor and emergency surgical cases can be adequately cared for; specialized diagnostic services are obtained from the district hospital, to which patients are referred when specialized care is required.

Out-patient and public health facilities are also included in the plan, providing a well-rounded community service. Since the X-ray, laboratory, pharmacy, and den-

HOSPITAL AND HEALTH CENTER

Too Small for Economical Operation, This One Is

Justifiable Only in Small Remote Communities

tal facilities are shared with the in-patient service, the costs of equipment and operation are kept to a minimum.

Careful analysis of the services to be furnished is especially important in planning a hospital of this size, where economy is paramount. For example, if adequate laundry service is available in the community, it may be more economical to omit this department in a hospital of this size.

All of the 30 beds are included in one convenient nursing unit, with standard isolation facilities which can be used for general patients when not required for communicable disease. Ten additional beds can be accommodated in emergencies. The one-floor plan permits more efficient staffing and management of such a small institution.

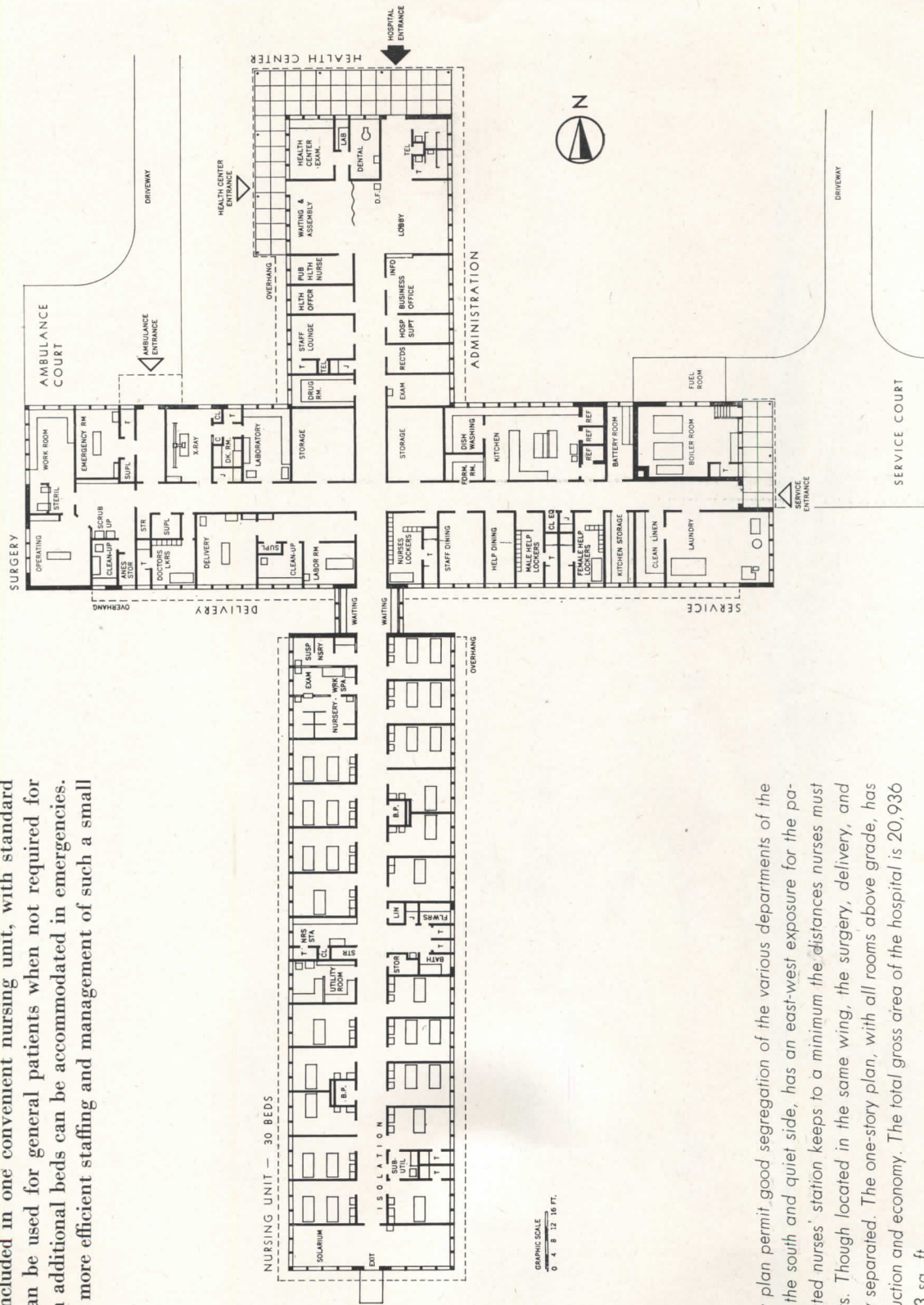

The four wings of this one-story plan permit good segregation of the various departments of the hospital. The nursing wing, on the south and quiet side, has an east-west exposure for the patients' rooms. The centrally located nurses' station keeps to a minimum the distances nurses must travel in attending their patients. Though located in the same wing, the surgery, delivery, and emergency suites are completely separated. The one-story plan, with all rooms above grade, has the advantages of simple construction and economy. The total gross area of the hospital is 20,936 sq. ft.; gross area per bed, 523 sq. ft.

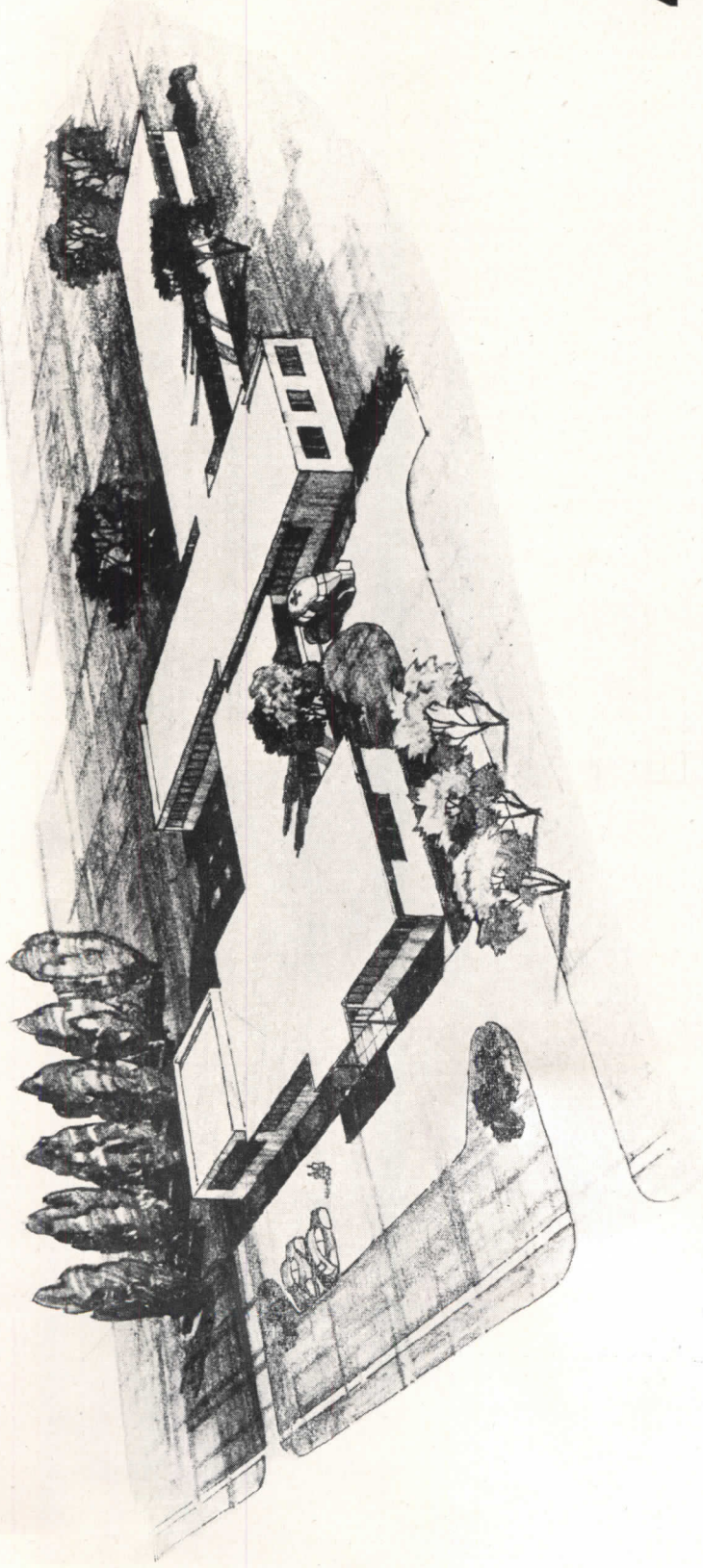

40 BEDS

THE history of most hospitals reveals that eventually some expansion becomes necessary. Hospitals of the 40-60 bed size constitute the largest group of such facilities in the United States. The plan illustrated was designed primarily to incorporate the basic features of the good hospital in this general group and yet hold to a minimum the design for construction and services. Such design will permit future expansion in all directions without the necessity of complete remodeling in order to provide full central services.

Some modification of this type of plan will probably be most frequently constructed in the initial phase of the National Hospital Program. It is this size institution upon which, in large measure, will depend the success of the program in bringing adequate hos-

GENERAL HOSPITAL OF MOST TYPICAL SIZE

Though Hospitals of This Size Are the Most Frequent,

Expansibility to 50 or 60 Beds is Essential

pital services to the small community. It provides facilities for the local physician to render the highest type of patient care consistent with the general economic level of the region.

Some of the facilities shown as optional, such as the laundry and autopsy, may be included or eliminated, depending upon local services. Since no hospital should be constructed without a thorough study of community needs, careful consideration should be given to every phase of services contemplated for present and future use before deleting any of the other elements shown on the accompanying plan. It is practically certain that the future of the successful hospital will entail the addition of such services as might be omitted. Such later addition usually proves less satisfactory and more costly than incorporation in the initial design.

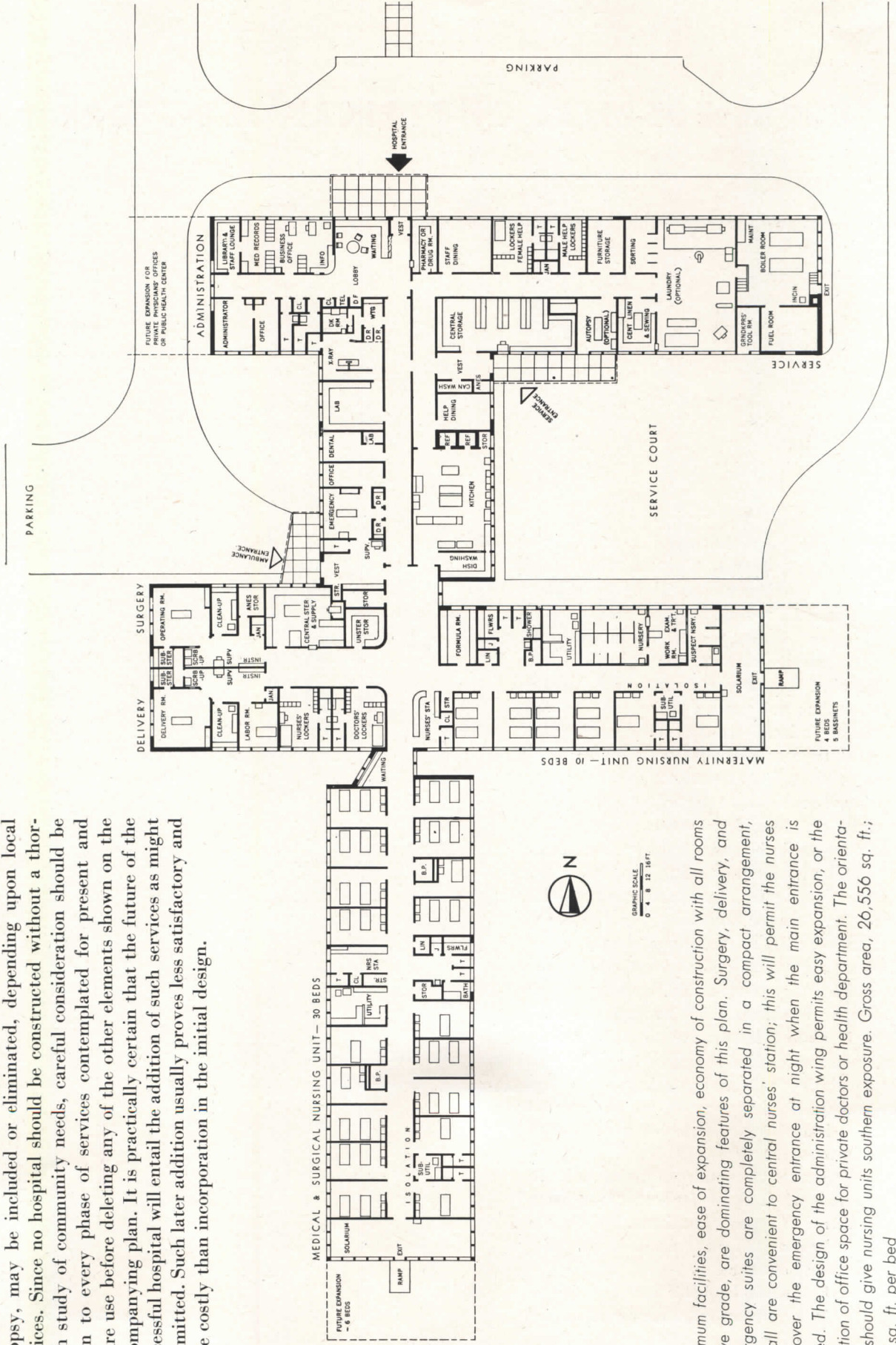

Minimum facilities, ease of expansion, economy of construction with all rooms above grade, are dominating features of this plan. Surgery, delivery, and emergency suites are completely separated in a compact arrangement, yet all are convenient to central nurses station; this will permit the nurses to cover the emergency entrance at night when the main entrance is closed. The design of the administration wing permits easy expansion, or the addition of office space for private doctors or health department. The orientation should give nursing units southern exposure. Gross area, 26,556 sq. ft.; 664 sq. ft. per bed

75 BEDS

GENERAL HOSPITAL OF TYPICAL ONE-STORY DESIGN

Recommended for Mild Climates and Open Sites

THIS 75-bed general hospital exemplifies the typical one-story institution. The design permits a maximum capacity of 99 beds by use of additional beds in single rooms and in the solaria. Some question has arisen as to the economy in planning for all services in a hospital of this size on one floor level. However, it has not proved to be too difficult from an administrative standpoint. This general type of plan has been found to be quite well suited to climates where heating and total area are not particular problems. It permits simple and economical construction and may easily be expanded by the addition of a fourth nursing unit. Experience has shown that there is much to recommend a one-story plan for hospitals up to 100 beds.

The inclusion of rather complete facilities for out-patient services is an optional feature to which every community should give serious consideration. The average hospital finds it almost imperative to provide out-patient services if it is to discharge fully its responsibility to the community. The arrangement of laboratory, X-ray and related services is such as to facilitate attention to both in-patients and out-patients.

Arrangement of complete nursing units in the various wings allows for better separation and control of types of patients, although a slightly larger staff may be necessary for adequate patient care.

It is the hospital of this size and larger which is in a position more nearly to render complete services to patients in most of the categories.

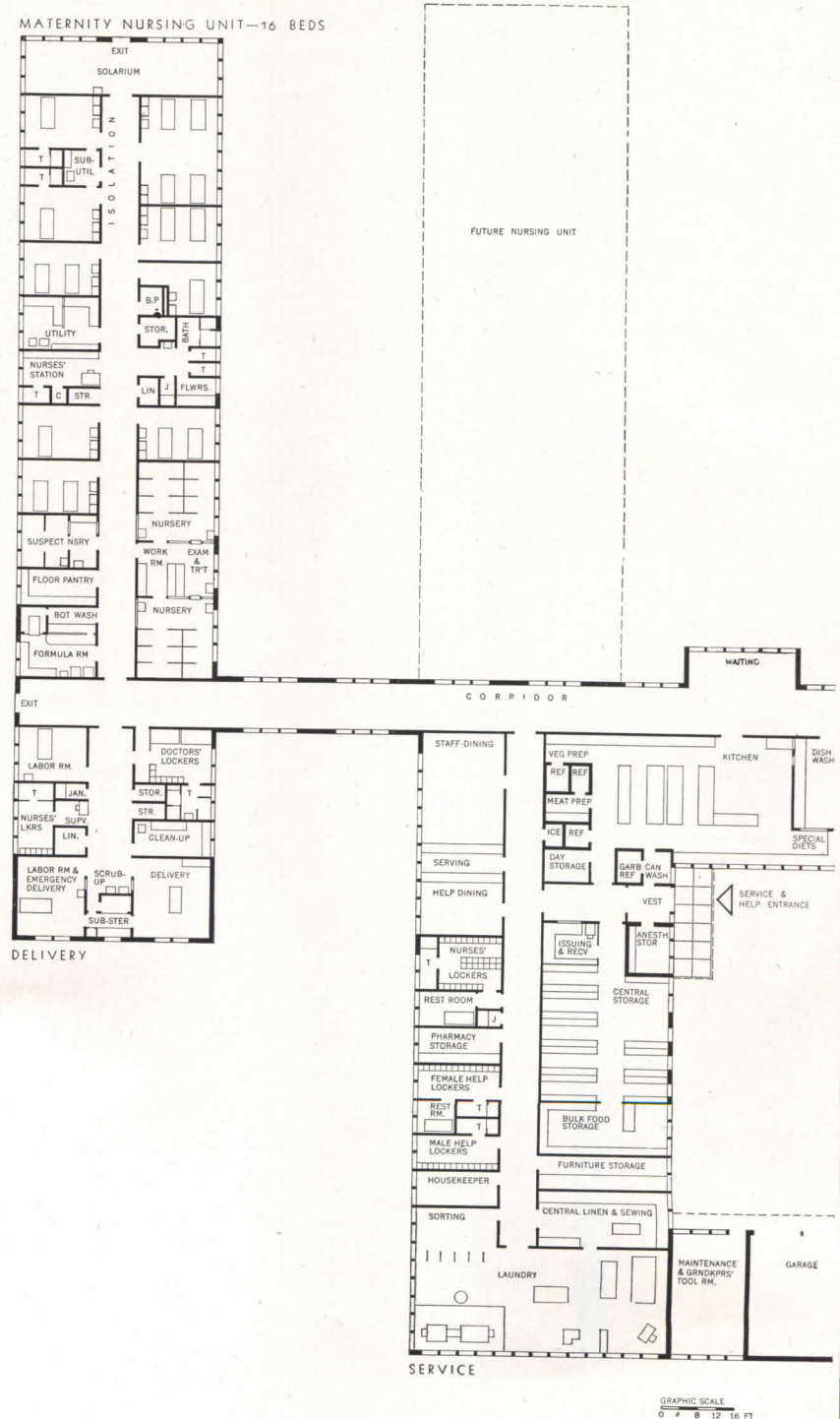

GRAPHIC SCALE
0 4 8 12 16 FT

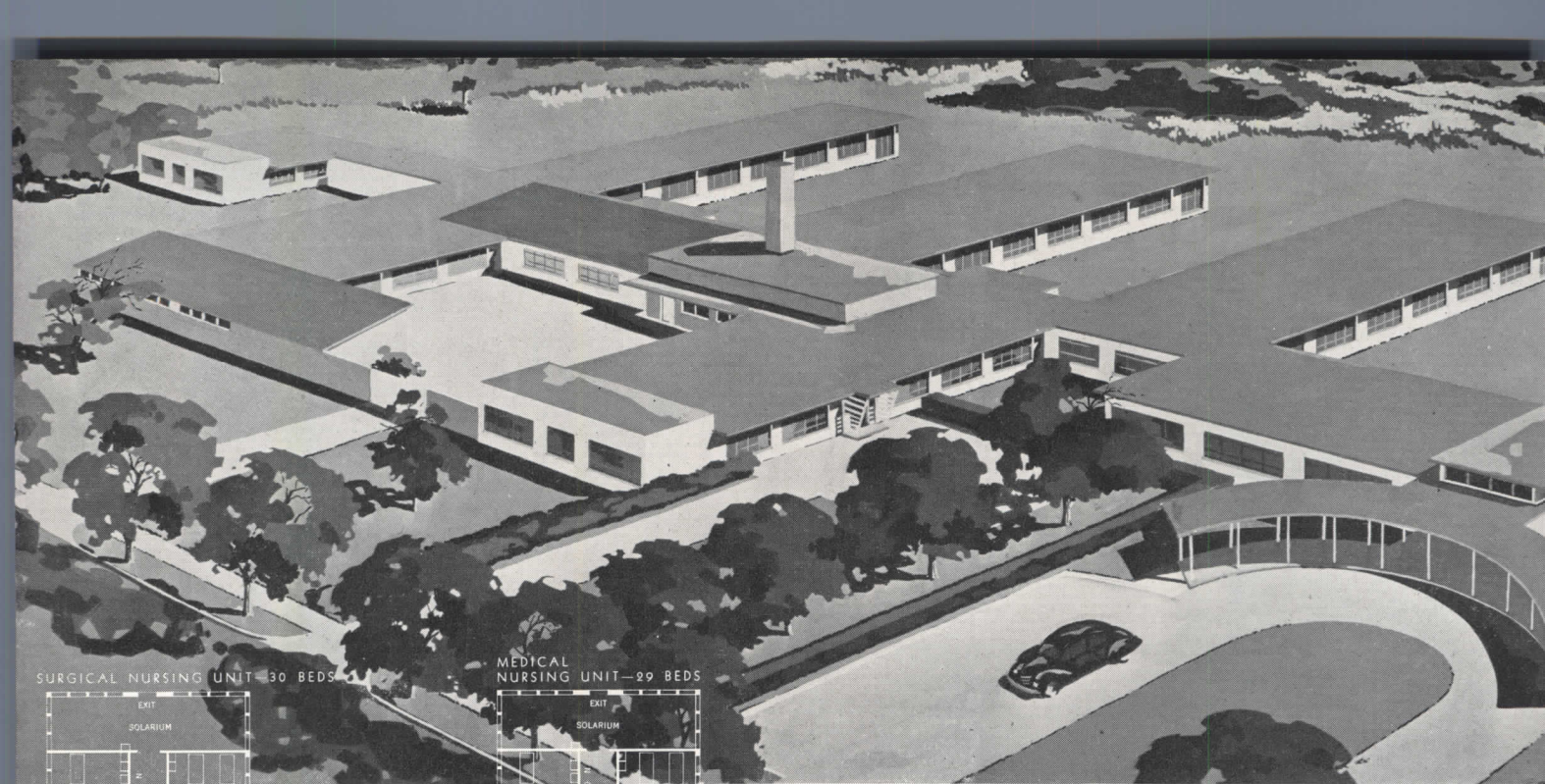

SURGICAL NURSING UNIT—30 BEDS

MEDICAL NURSING UNIT—29 BEDS

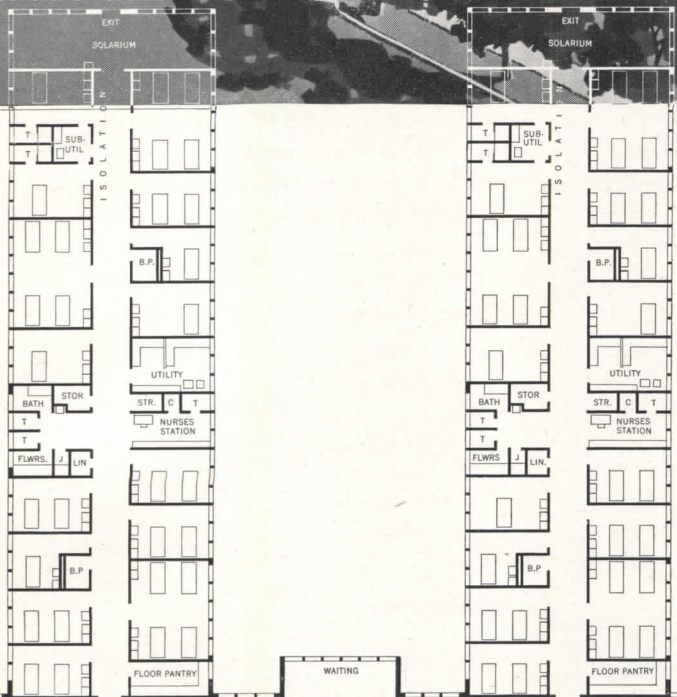

Total gross area of hospital 49,432 sq. ft.
Gross area per bed 659 sq. ft.

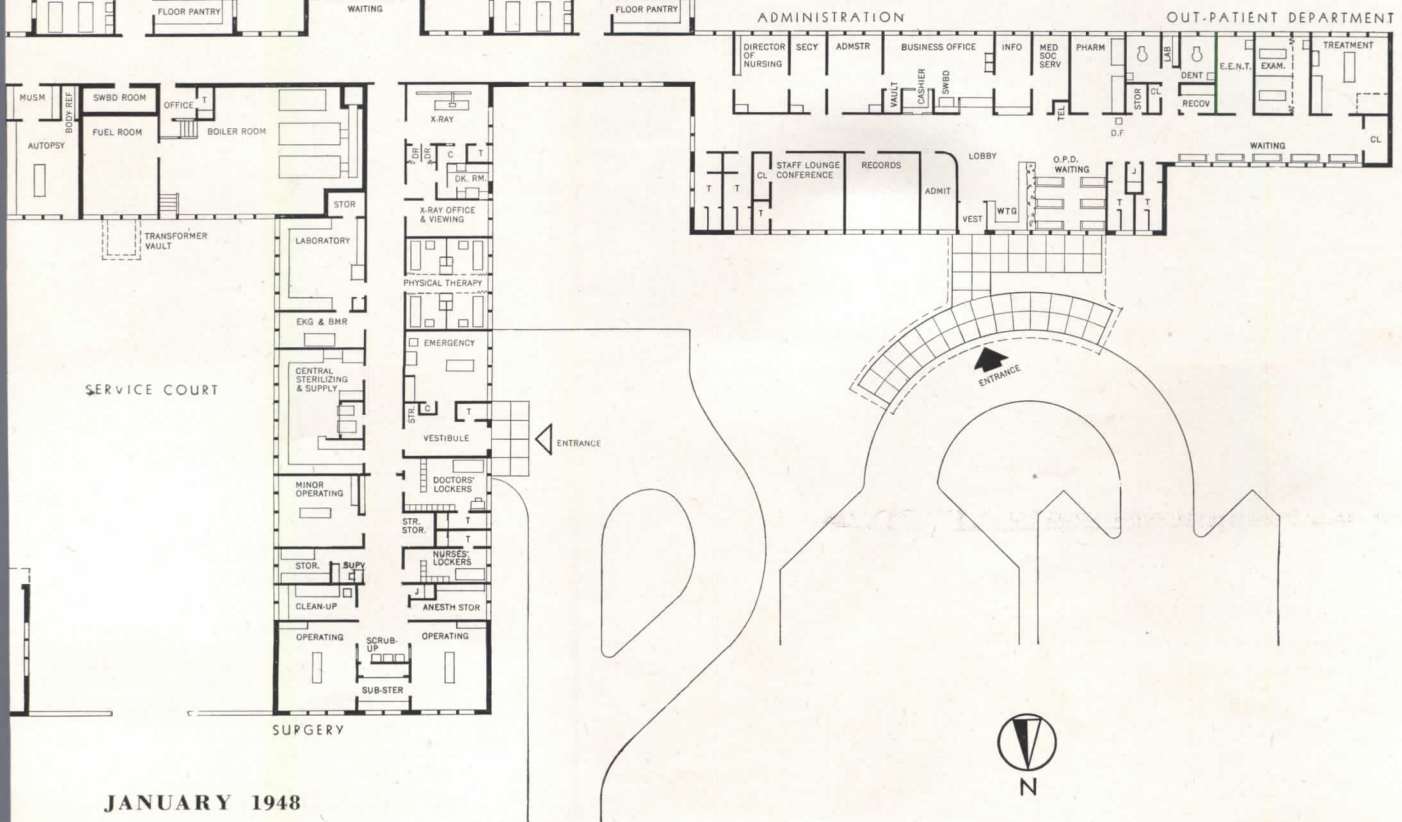

100-BED

GENERAL HOSPITAL

A Typical Hospital of Average Size, for a "District" Hospital

THIS multi-story 100-bed institution typifies the modern concept of the average size hospital in the United States. It is designed to provide practically all services which are expected of the good general hospital. It is this type of hospital in the typical smaller urban community which can set the pattern for standards of patient care necessary to improve the health of the nation insofar as hospital facilities can contribute to that movement.

Here too are provided facilities for an out-patient department without which the average community hos-

pital falls short of the full extent of possible services.

Services available in an institution of this size place it in a dominant role in the concept of an adequate coordinated hospital system. It is just such an institution to which the smaller rural hospital and practitioners on one hand and the large urban medical center on the other look as a common meeting ground for the promotion of a program to enhance the welfare of patients through continuity and for the correlation and practical application of consultation, medical education, and research.

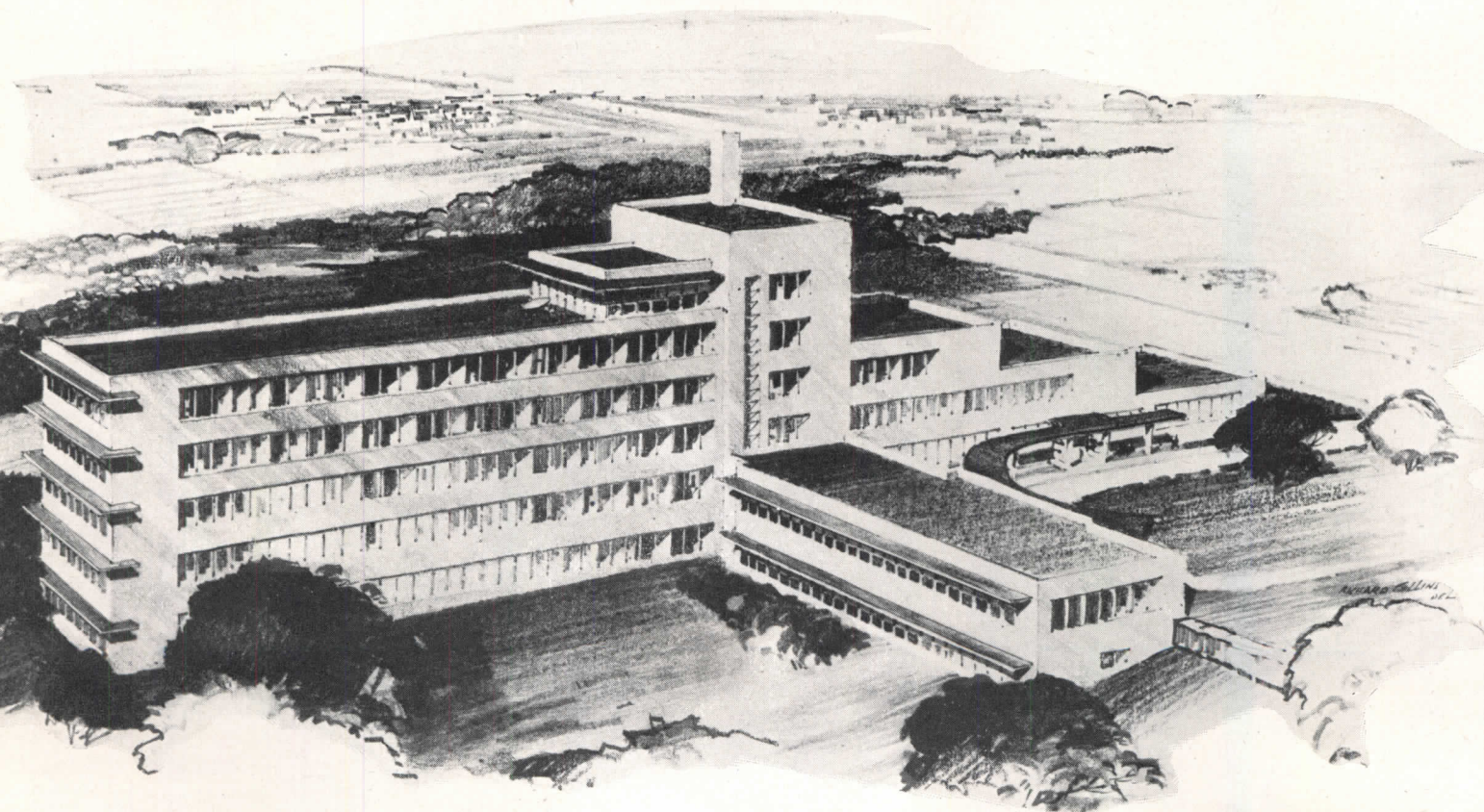

Arthur W. Wareham, Del.

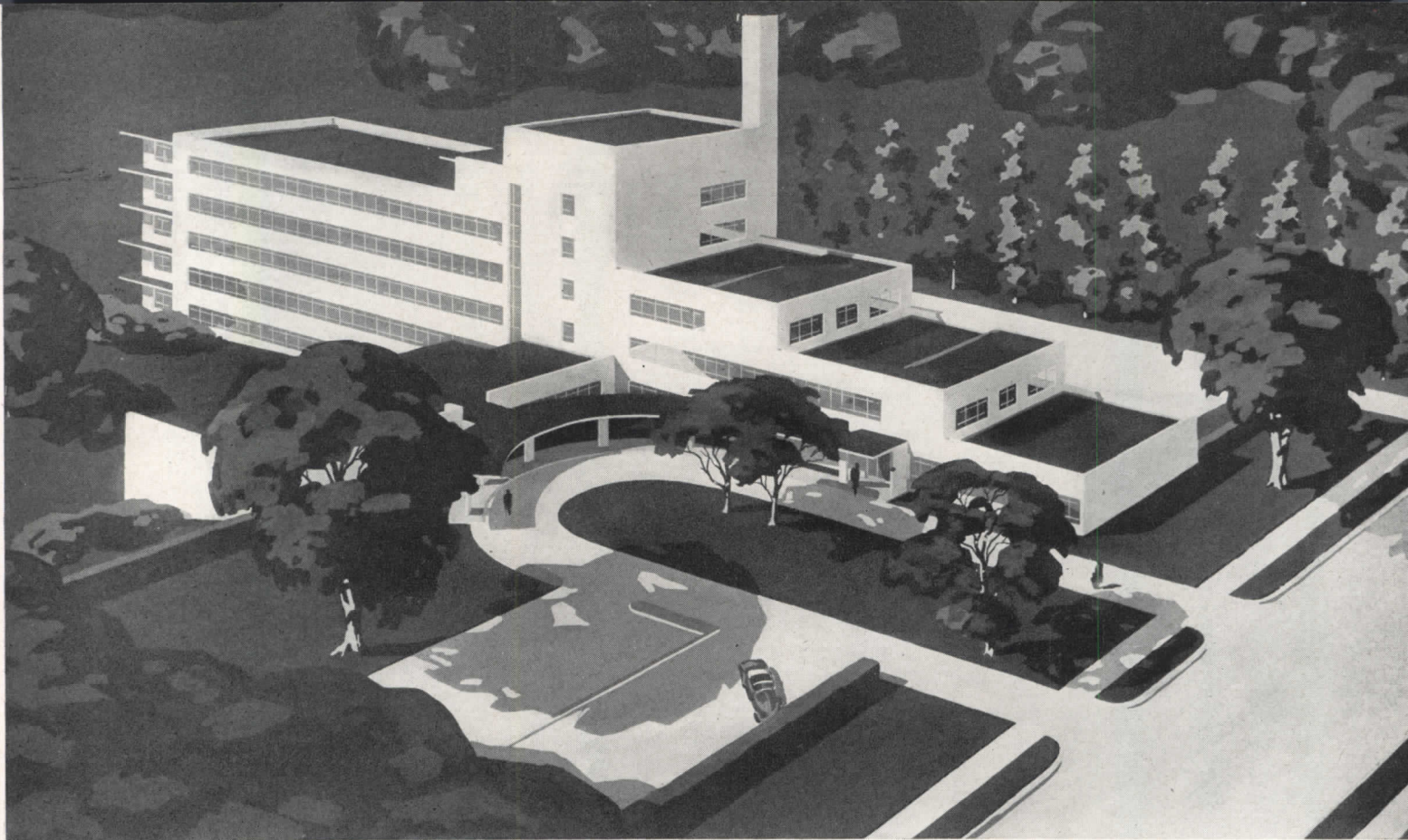

Stanley Reese, Del.

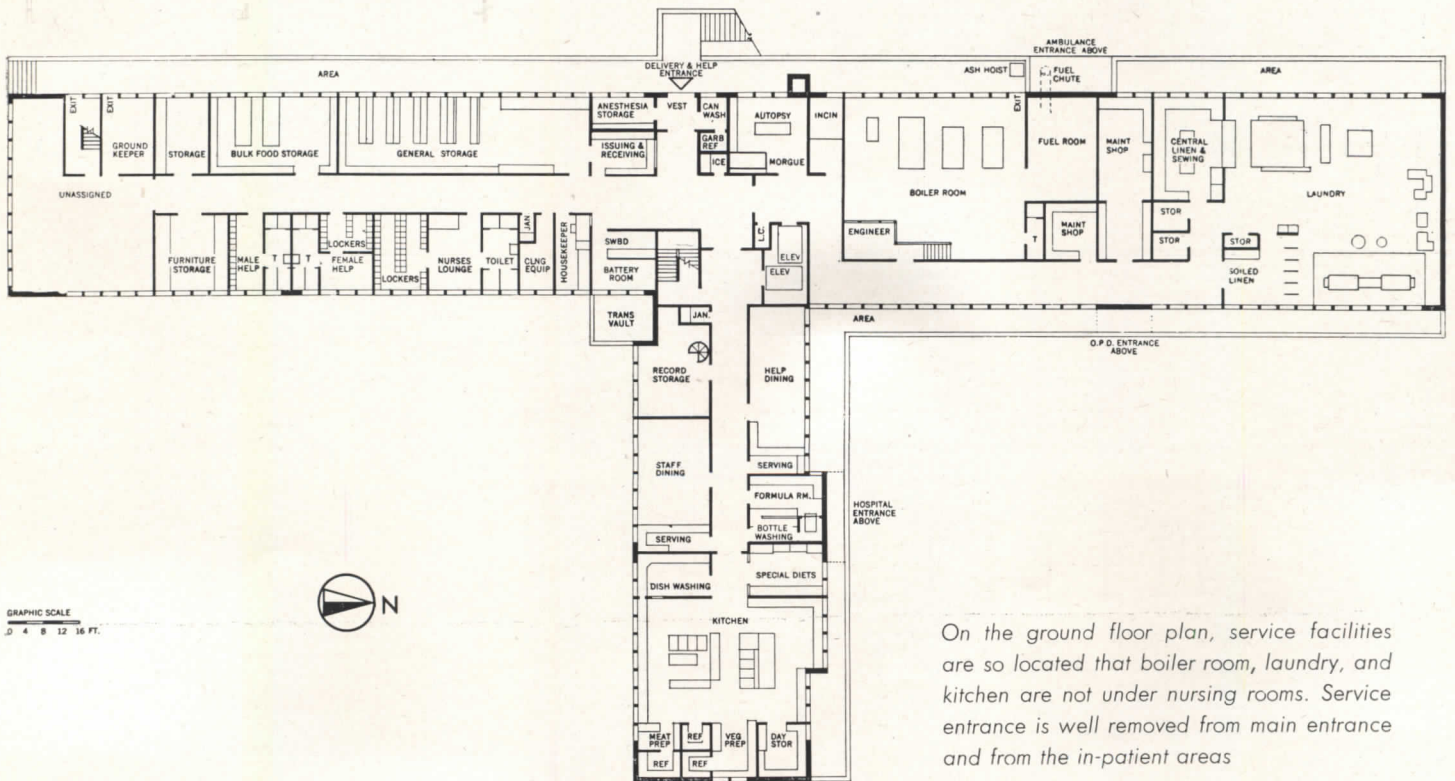

On the ground floor plan, service facilities are so located that boiler room, laundry, and kitchen are not under nursing rooms. Service entrance is well removed from main entrance and from the in-patient areas

GROUND FLOOR PLAN

JANUARY 1948

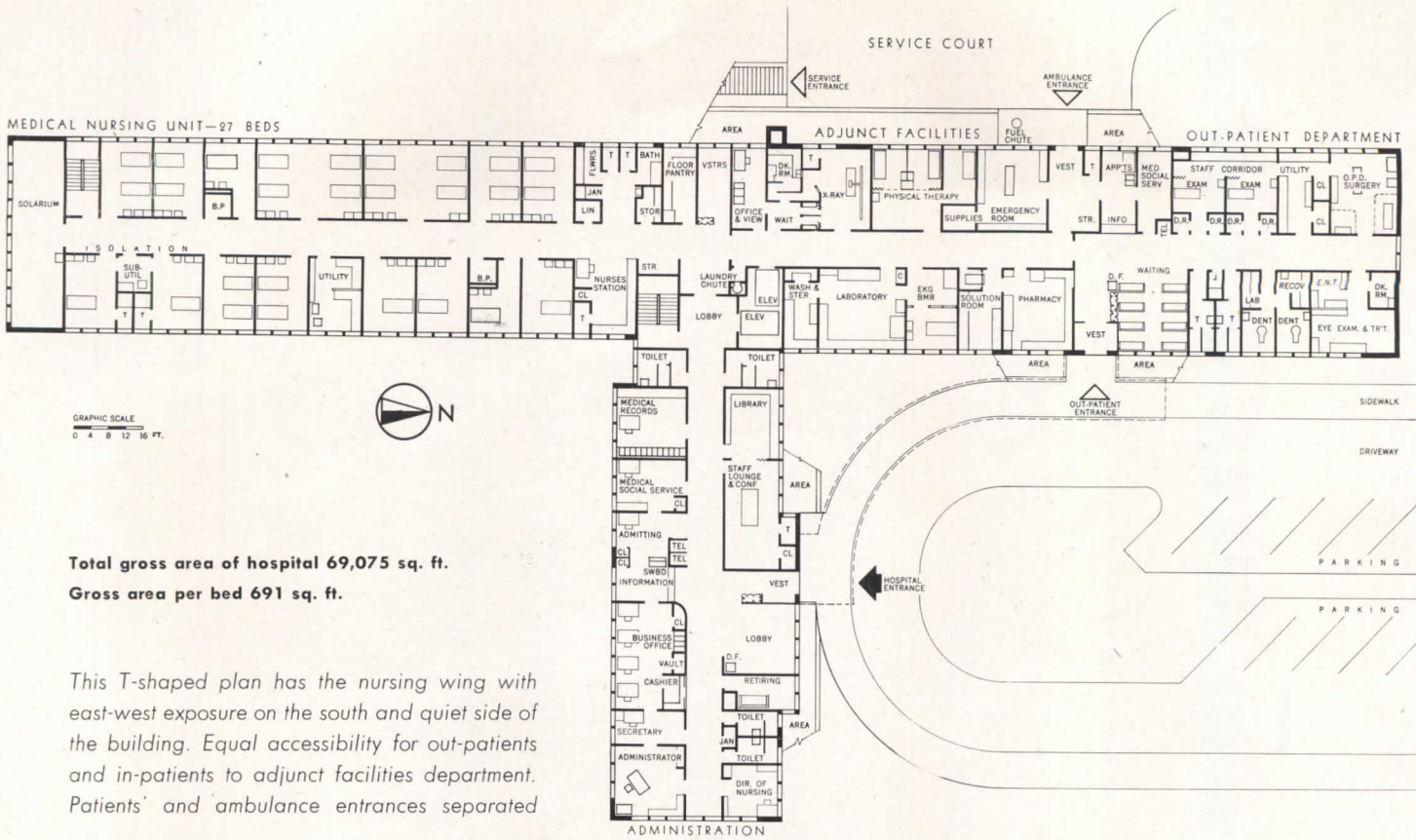

Total gross area of hospital 69,075 sq. ft.
 Gross area per bed 691 sq. ft.

This T-shaped plan has the nursing wing with east-west exposure on the south and quiet side of the building. Equal accessibility for out-patients and in-patients to adjunct facilities department. Patients' and ambulance entrances separated

FIRST FLOOR PLAN

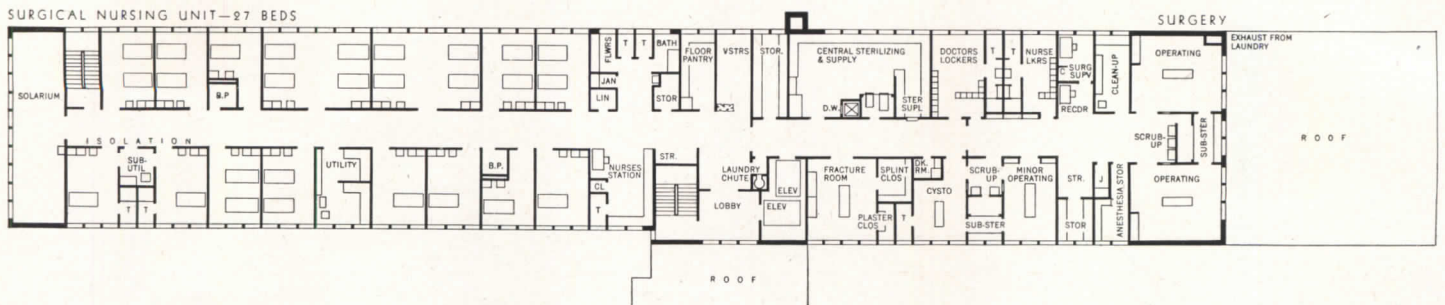

SECOND FLOOR PLAN

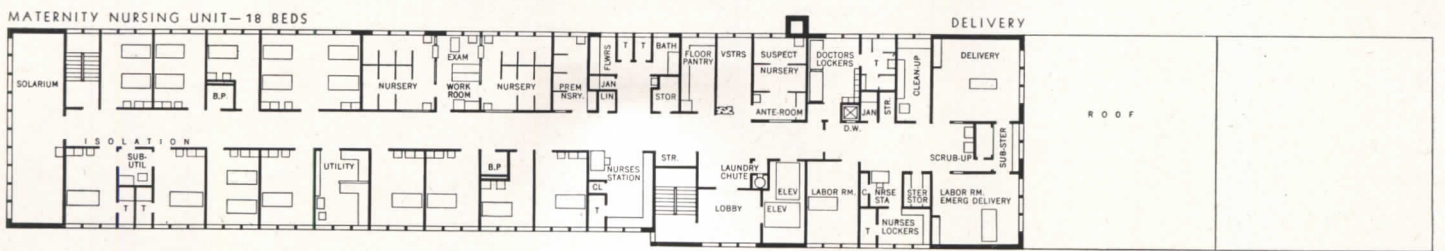

THIRD FLOOR PLAN

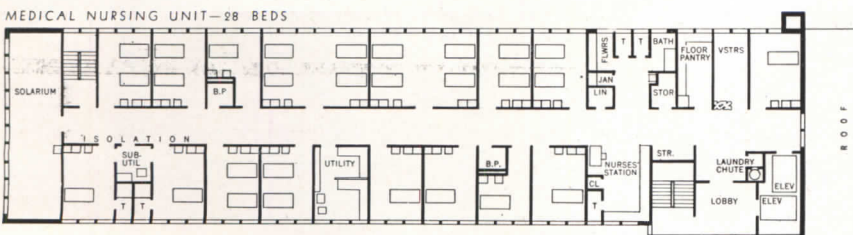

FOURTH FLOOR PLAN

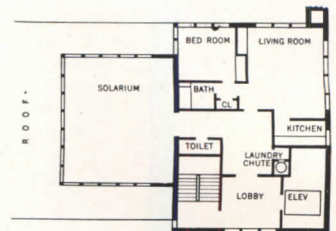

FIFTH FLOOR PLAN

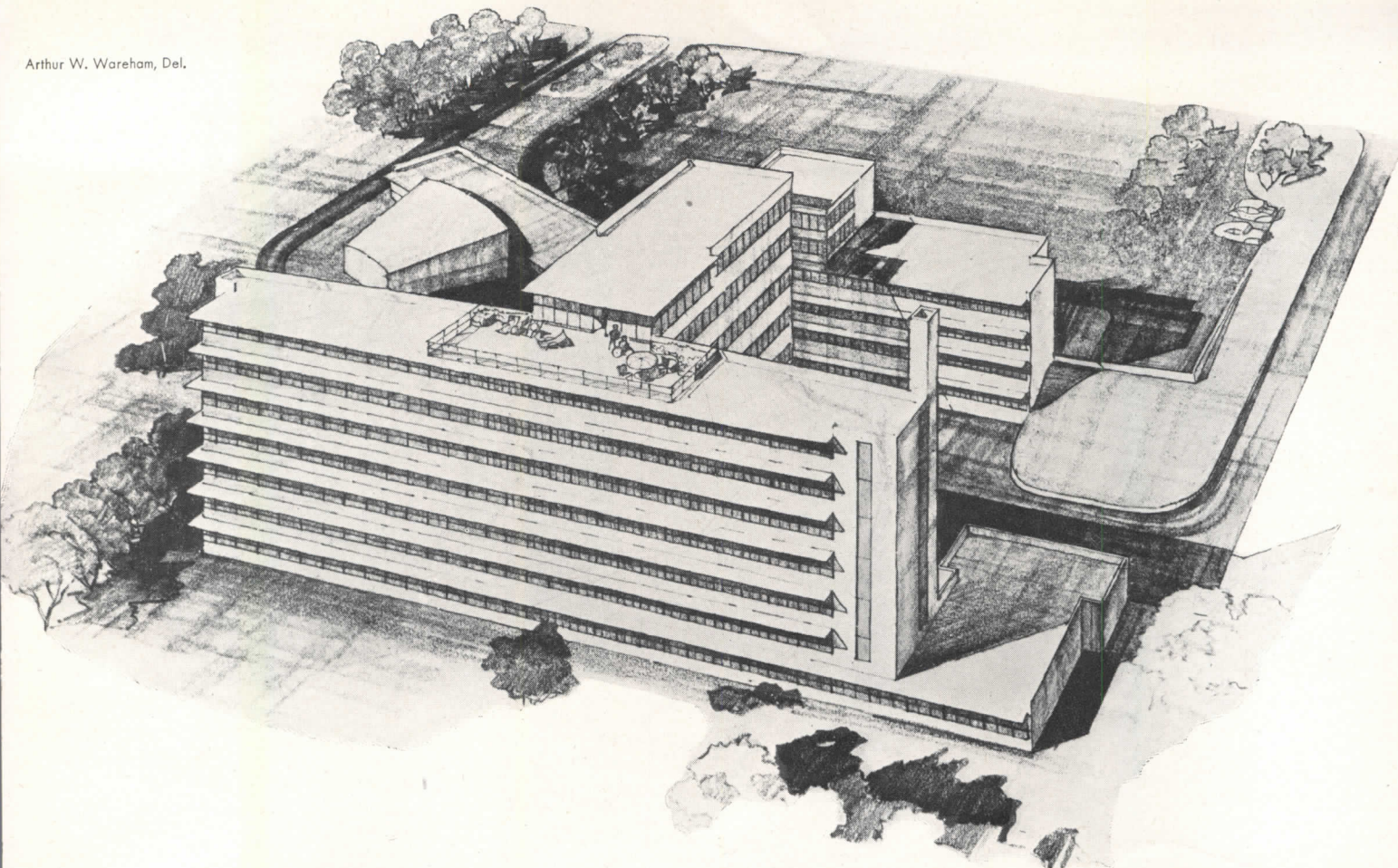

150 BEDS

GENERAL HOSPITAL FOR URBAN DISTRICTS

In Conjunction with Complete Public Health Center

THE 150-bed general hospital plan illustrated is an elaboration of the preceding 100-bed institution showing variations in the area of service facilities, particularly in the ground floor area.

The general administrative area, out-patient and public health services, sufficient to serve almost any community, are concentrated on the first floor. Included in these facilities is an auditorium for health education and for large clinical conferences and similar health meetings necessary to the promotion of a well-rounded community hospital and health program. The public health area is so situated as to permit coordination of its activities with the hospital program but to allow separate administrative control.

A feature of the nursing floors is the concentration of service facilities in the central corridor, and the placement of rooms on one side of the corridor only, to make patient rooms as quiet as possible.

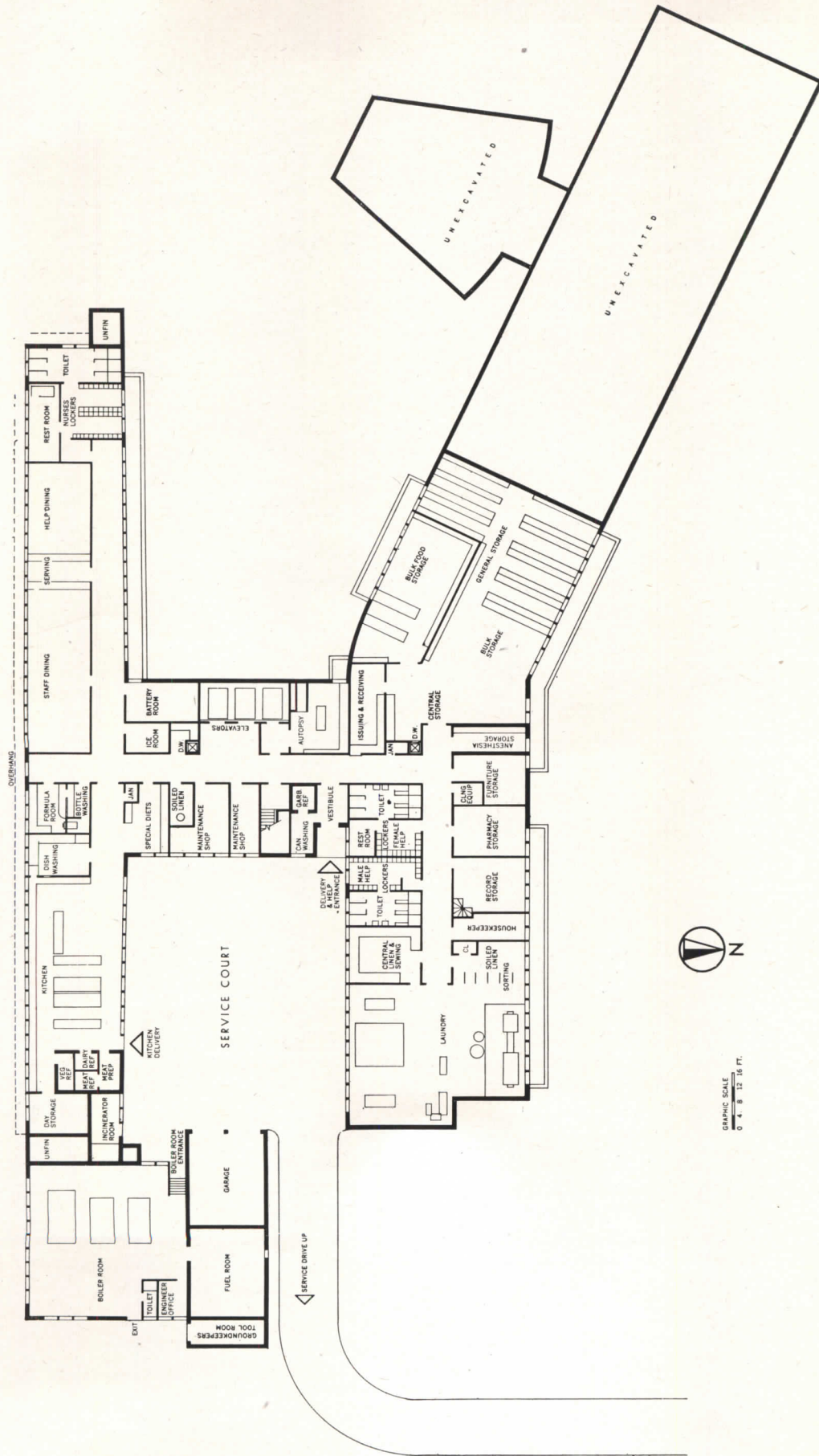

GROUND FLOOR PLAN

Service facilities are concentrated on the ground floor, but are connected with all other departments by centrally located elevators and dumbwaiters. The excavation of the service court provides adequately for ventilation and lighting. This design provides complete separation of entrances. Service and ambulance entrances are off their respective courts, while entrances for staff, out-patients, and the main entrance are on the north or street side of the building, ranged along the main entrance driveway

SURGICAL NURSING UNIT—87 BEDS

OVERHANG

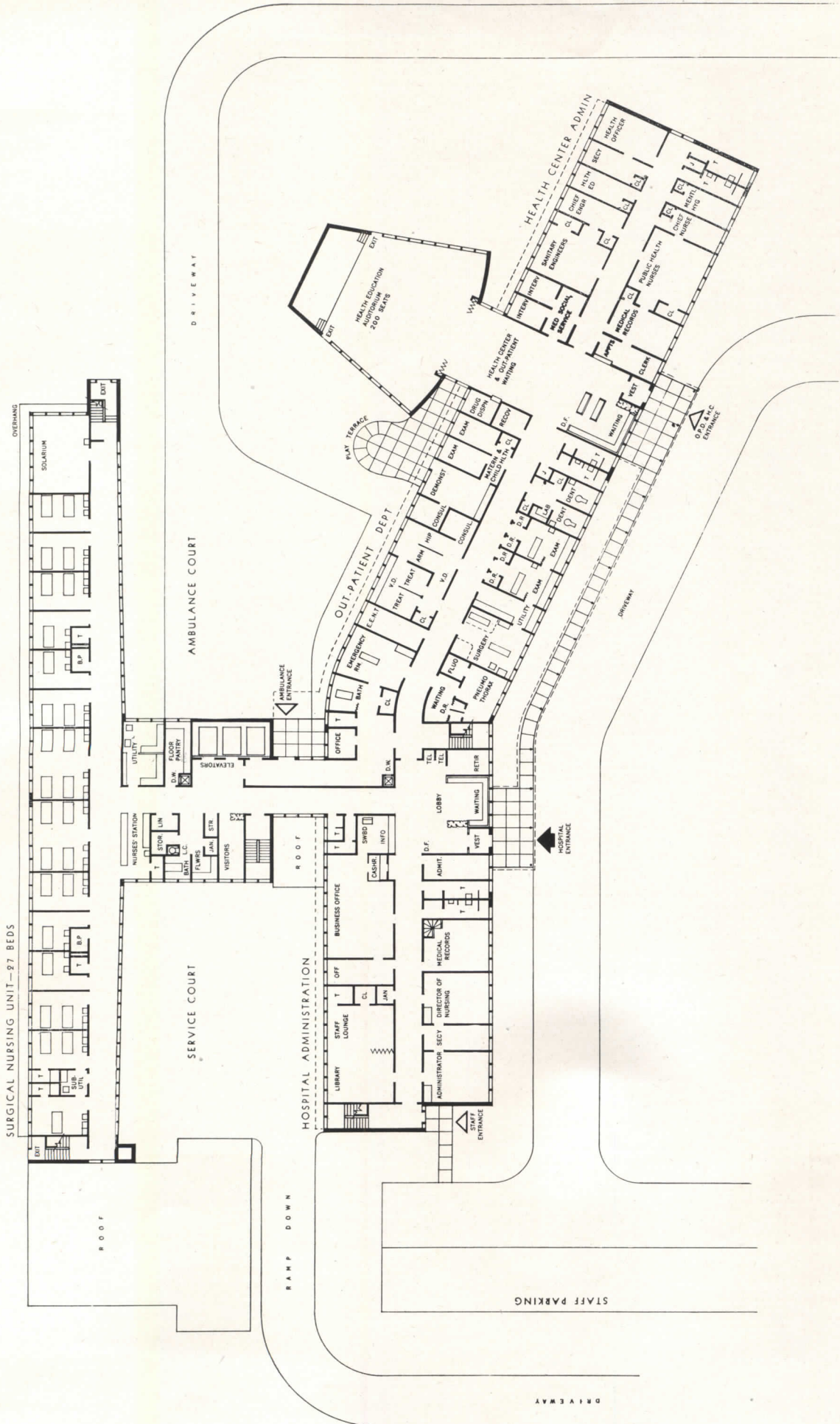

FIRST FLOOR PLAN

Total gross area of hospital 112,902 sq. ft.; gross area per bed 752 sq. ft.

In addition to the usual departments for administration, nursing, and out-patients, this hospital provides space for a health center, including an auditorium for health education. All rooms are to have a southern exposure, with only a quiet, well lighted and ventilated corridor on their north side. Nurses' station and the usual noisy service facilities are grouped centrally in adjacent wing

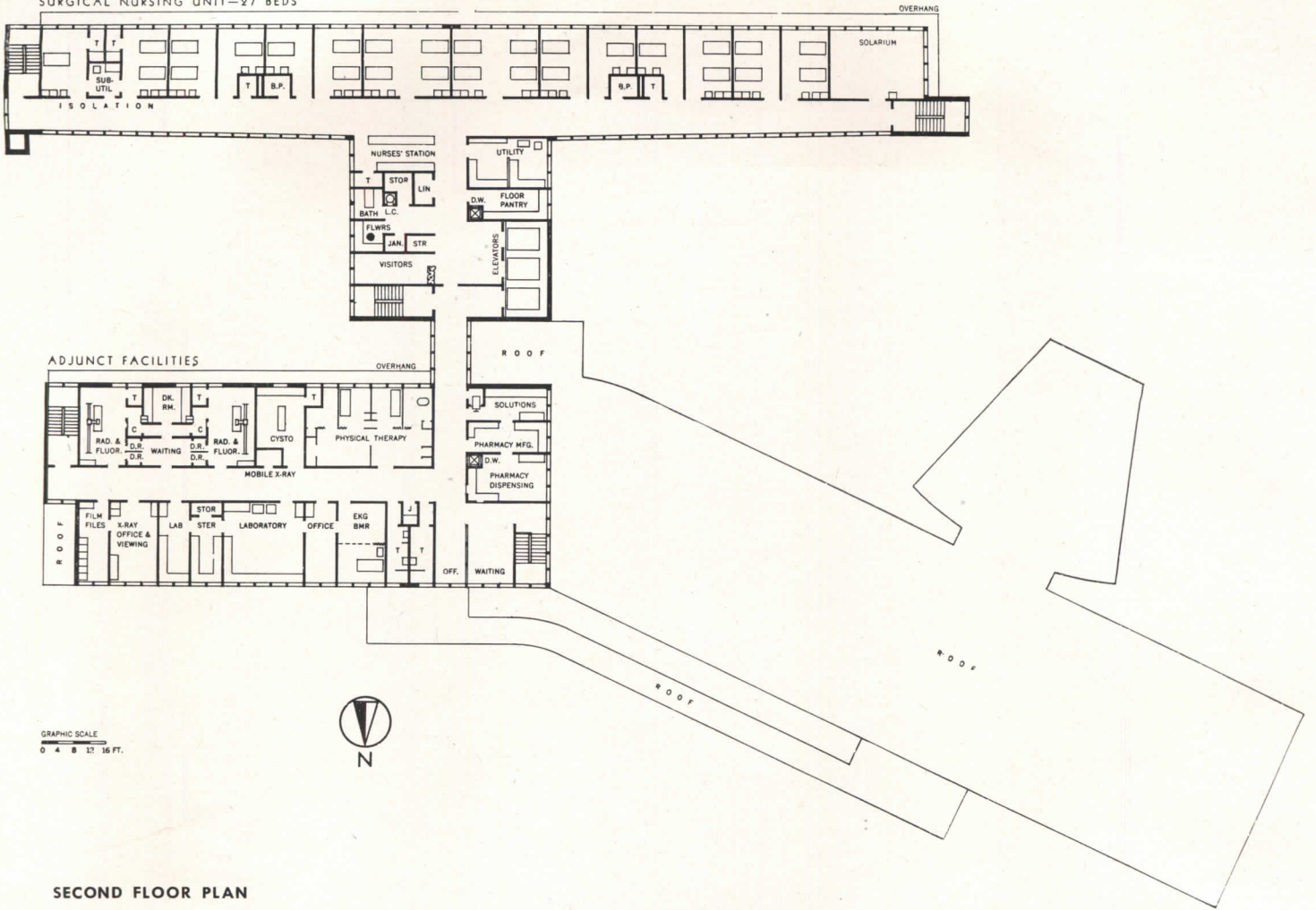

SECOND FLOOR PLAN

GRAPHIC SCALE
0 4 8 12 16 FT.

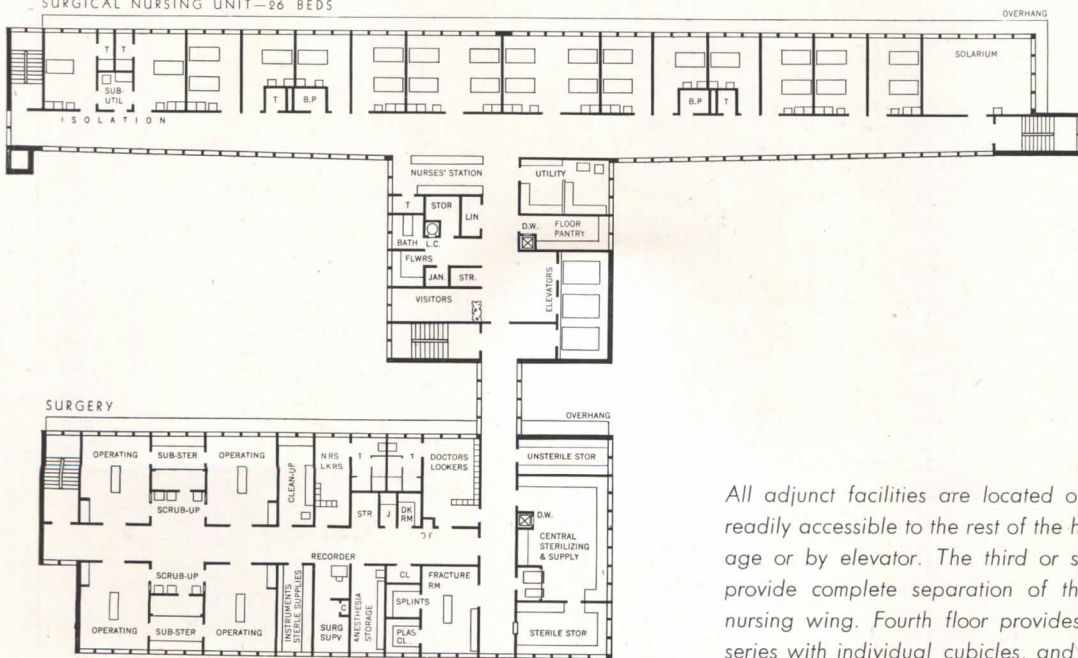

THIRD FLOOR PLAN

All adjunct facilities are located on the second floor, but are readily accessible to the rest of the hospital either by direct passage or by elevator. The third or surgical floor is designed to provide complete separation of the operating suite from the nursing wing. Fourth floor provides maternity beds, small nurseries with individual cubicles, and delivery facilities. Nurseries are concentrated at the end of the nursing wing, out of the flow of traffic. Delivery suite is isolated from the nursing wing

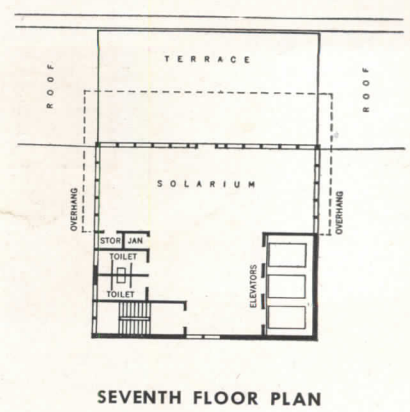
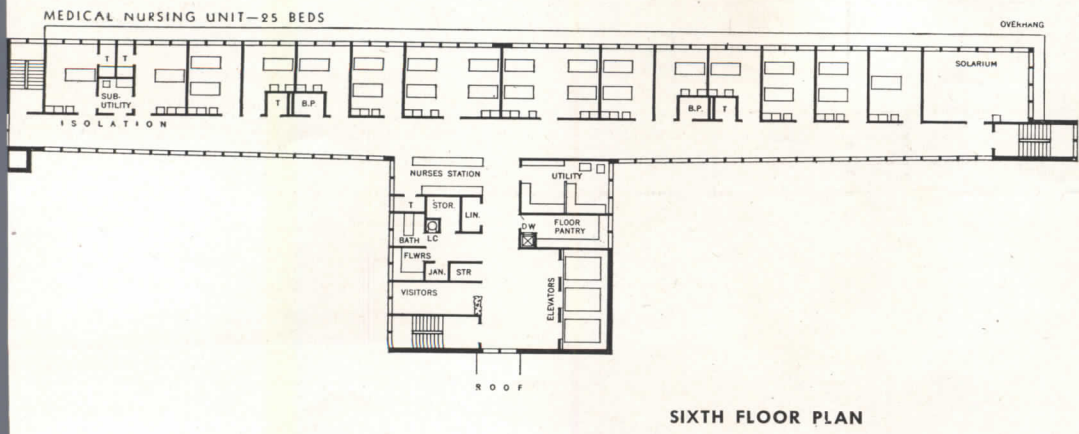
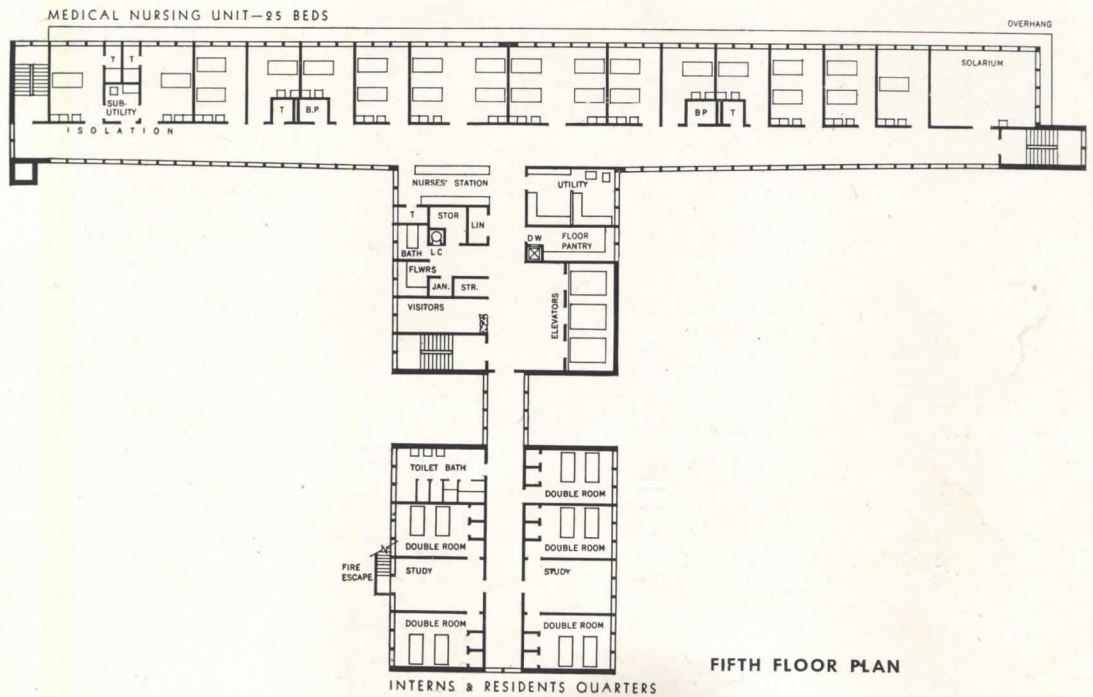
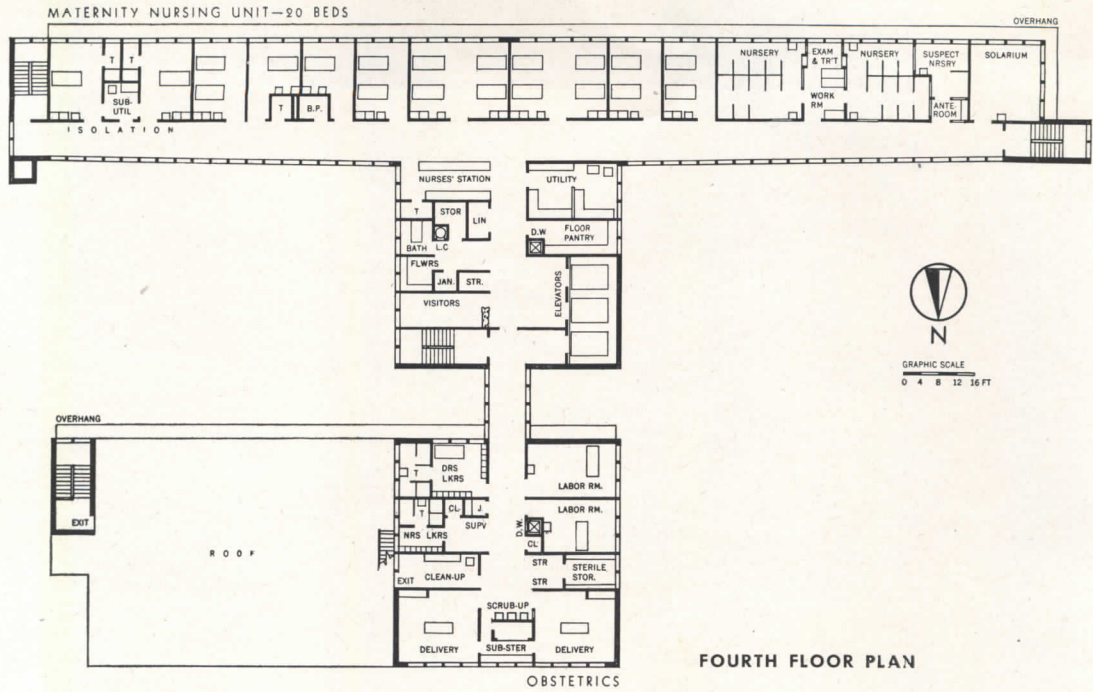

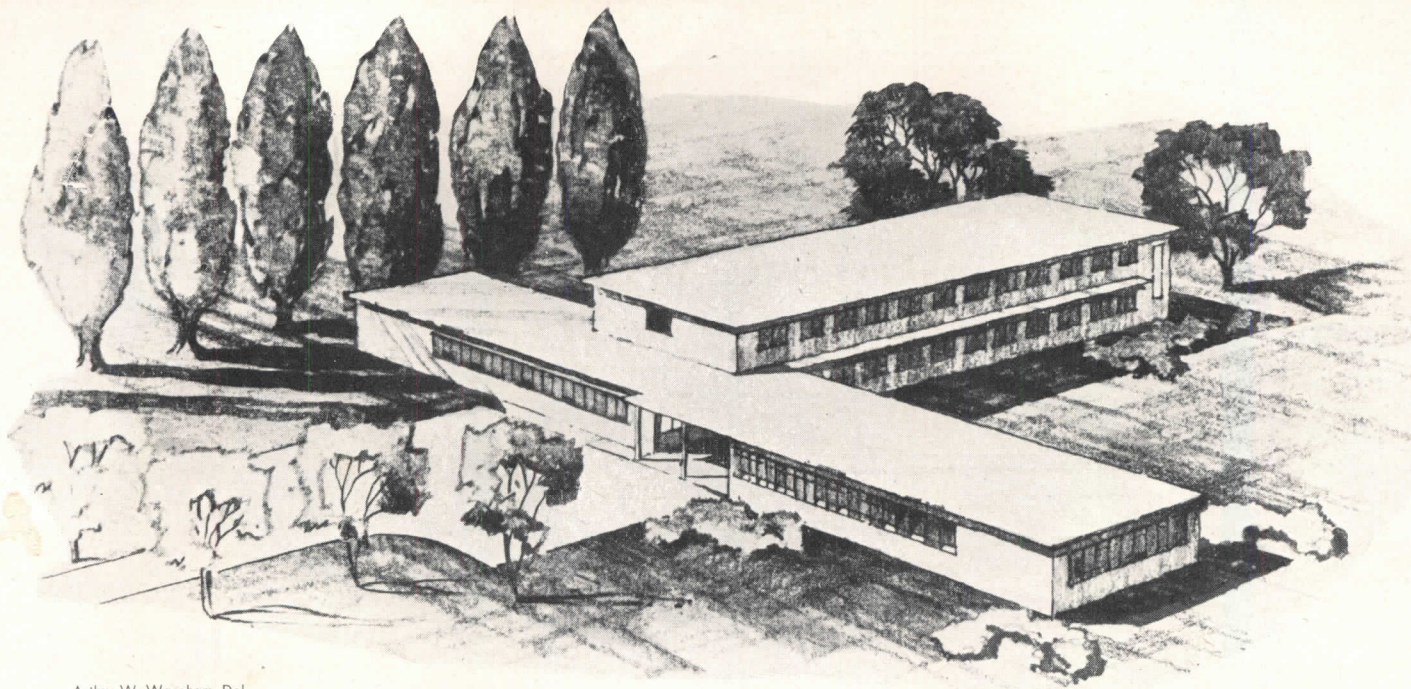

Arthur W. Wareham, Del.

NURSING SCHOOL

COMBINED CLASSROOM AND DORMITORY FACILITIES

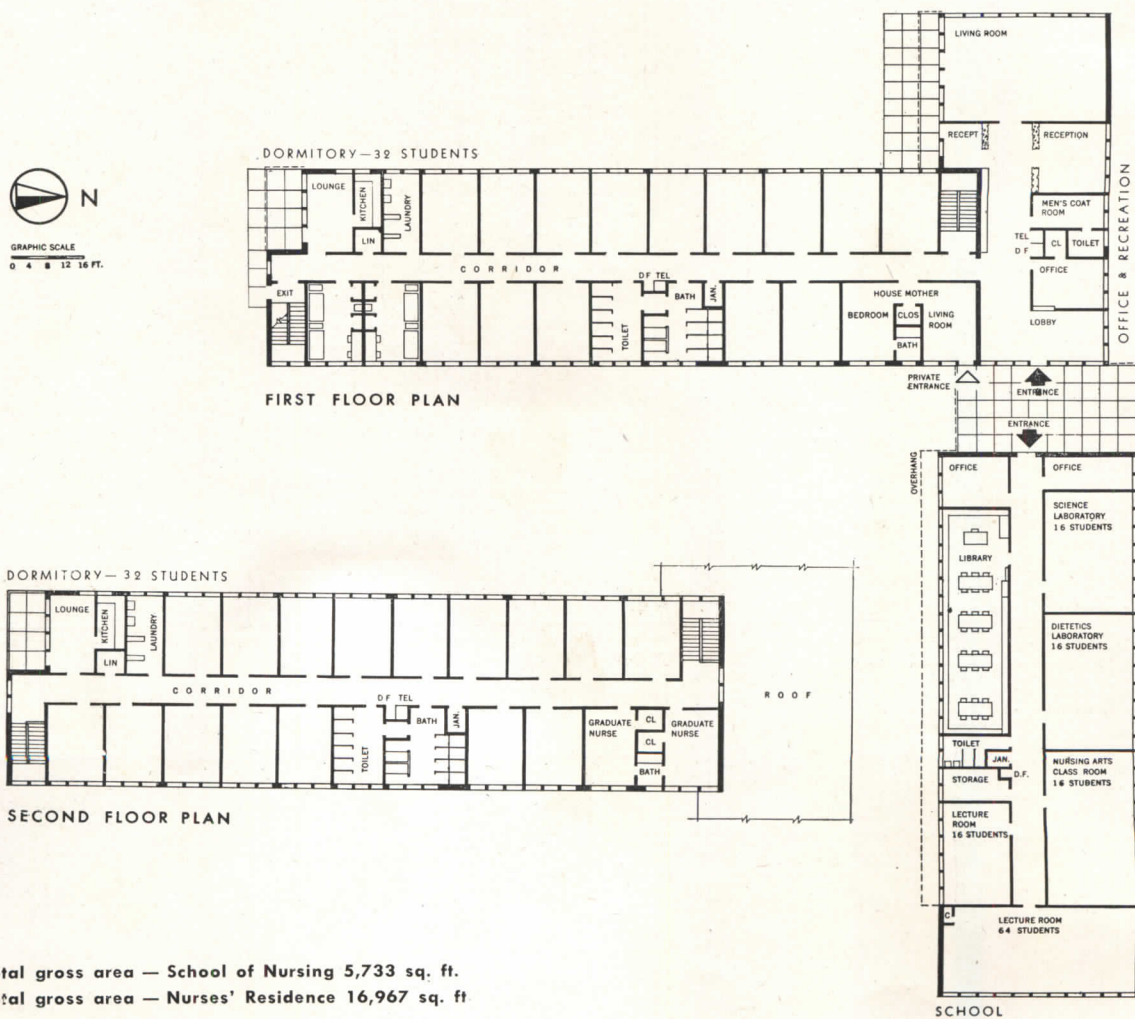

TEACHING facilities and dormitories of schools of nursing should be separate units, and should be separated from the hospital building. Dormitories or nurses' homes are today recommended only for student nurses. Graduate nurses now prefer not to be housed in the institution or on its grounds.

This particular plan has been designed to accommodate 64 students and would probably be in association with a hospital having a daily average number of patients in excess of 100 (exclusive of bassinets). Most authorities consider it both economically and educationally unsound for a smaller hospital to assume primary responsibility for conducting a nursing education program. Such hospitals do not have a daily average number of patients sufficient to give every enrolled student adequate and well-rounded experience in all essential clinical spheres, nor can they usually obtain and maintain a qualified instructional staff.

The plans presented provide for classrooms and laboratories to accommodate sections of 16 students

each; the large lecture hall will hold the entire student body of 64. Reference to the detailed classroom drawings will show how the plan can be readily modified for larger or smaller classes by increasing or decreasing the number of students' units. Whenever possible the educational facilities for instruction in sciences available in educational institutions (such as colleges and universities) in the community should be used by the school of nursing. This would include well trained instructors and laboratory facilities and preclude the necessity of the duplication of costly equipment and certain highly trained personnel.

The students' quarters are shown with double rooms for economy, although single rooms are preferred for the sake of morale, maintaining good standards of health, and better conditions for study. An important distinction between housing for student nurses and that provided in the average college dormitory is that in the case of nurses, hours for study, duty, sleeping, and recreation vary widely.

LEGEND

- 1 Autoclave 8 X 16 in.
- 2 Blackboard
- 3 Bulletin Board
- 4 Clinical Sink
- 5 Sink & Drain Board
- 6 Fume Hood
- 7 Drain Pegs
- 8 Graduate Rack
- 9 Sliding Blackboard
- 10 Sink
- 11 Laboratory Table, 4 Students Each
- 12 Instructor's Table
- 13 Storage Cabinet
- 14 Gas
- 15 Electricity

- 16 Wall Outlet
- 17 Counter with Pull Shelves, Drawers & Cabinets Below
- 18 Counters with Drawers & Cabinets Below
- 19 Range With Oven
- 20 Moveable Table
- 21 Wall Cabinets
- 22 Refrigerator
- 23 Partition 4' 0" High
- 24 Stool
- 25 Pull Shelves
- 26 Portable Utensil Rack
- 27 Bed Pan Sterilizer
- 28 Utensil Sterilizer

- 29 Shelf with Wood Rod under
- 30 Locked Narcotics Cabinet
- 31 Sanitary Waste Receptacle
- 32 Medical Sink
- 33 Hot Plate
- 34 Instrument Sterilizer
- 35 Dressing Carriage
- 36 Linen Hamper
- 37 Overhead Curtain Rod
- 38 Chair
- 39 Bed
- 40 Bedside Cabinet
- 41 Sink with Elbow Control
- 42 Waste Receptacle
- 43 Door 3 ft. 10 in.

GRAPHIC SCALE
0 4 8 12 16 FT

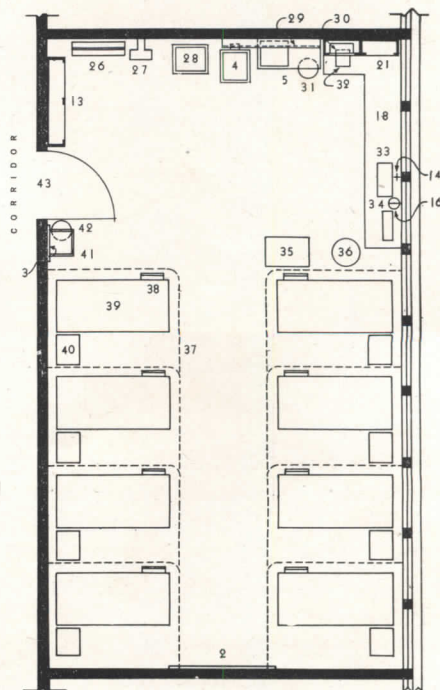
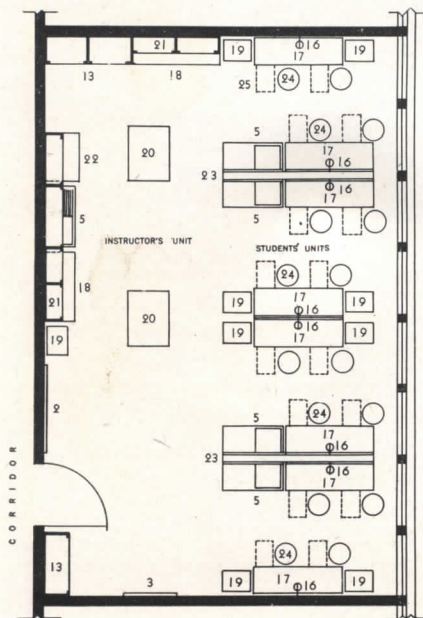
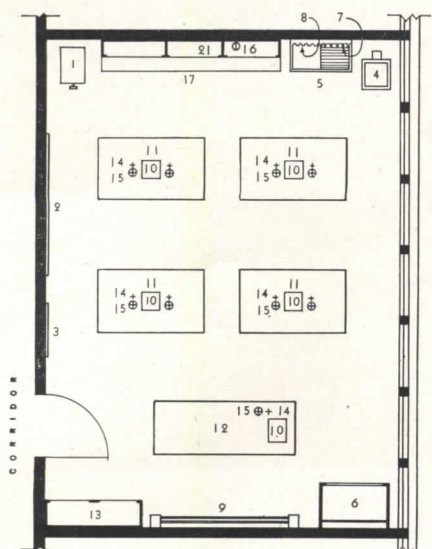

THE COORDINATED HOSPITAL SYSTEM

The plan provides for constant exchange between hospitals of information, training, and consultation service and personnel, and for referral of patients when indicated

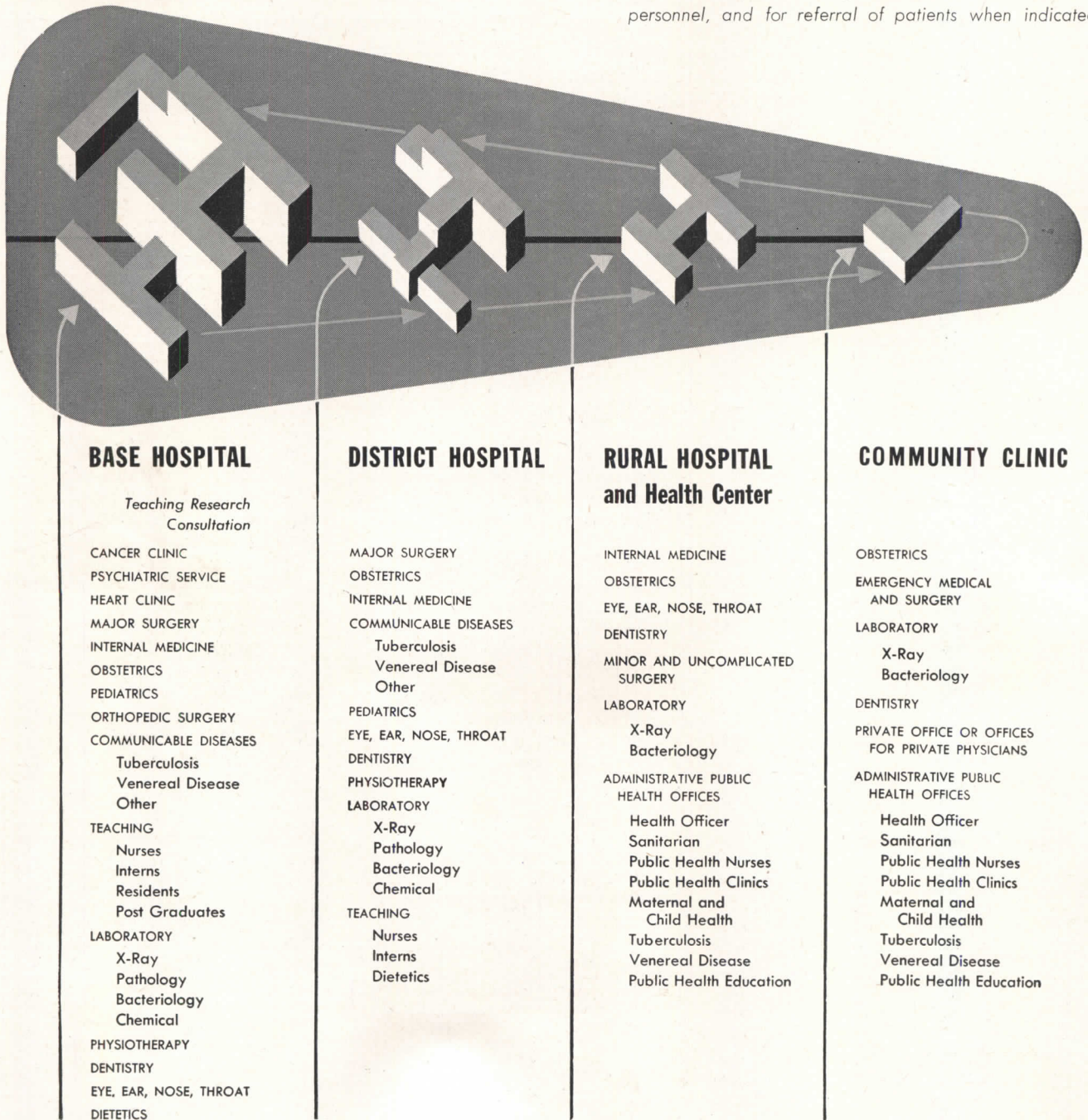

To improve hospital service along its three major fronts — preventive, diagnostic, therapeutic — the Surgeon General has suggested the "coordinated hospital system." It proposes tying all hospitals into a cooperative hook-up, in which there would be a constant exchange of information, training, consultation service and personnel, and in which patients would be referred from one hospital to another.

With the large "base" or "teaching" hospital as the center, next in line would be a large general hospital, called here the "district" hospital. Then a smaller one, the "rural" hospital, of minimum size for genuine hospital service. For the isolated community there would be a community clinic with a small nursing unit for obstetrical or emergency cases, not really a hospital at all, but an outpost at the far end of the line.

ARCHITECTURAL ENGINEERING

TECHNICAL NEWS AND RESEARCH

POURED RESILIENT FLOORING FOR HOUSES

WHEN hardwood flooring was in extremely short supply following the war, housing authorities sought a composition plastic flooring that would be attractive and durable and that could be poured-in-place over concrete, wood, or steel subfloors.

One type of such flooring, approved by Federal Housing Authority, was composed of kiln-dried oak flour, asbestos fibers, and chemical binding agents. Chemically it belonged to the magnesite family of composition flooring. Another type of composition poured flooring, now on the market, has a base of liquid rubber latex, to which is added either cork or marble chips. Installation and finishing methods vary, but all types are said to answer the need for a flooring that is resilient and non-slip, not too expensive, fire-resistant, wear-resistant, and readily cleaned. All the flooring types are considered permanent. Once

set, they form a one-piece monolithic flooring bonded to the subflooring.

Their finished appearance varies according to the aggregate. The wood-aggregate types resemble light and dark oak floors in color, although they are of course seamless; the terrazzo types combine different colored marble chips and base materials; while the cork-aggregate floors present a natural dark cork color against a darker background.

Magnesite Composition: This type of flooring, made from magnesium oxychloride cement, is new only in its adaptation to houses as a finished floor, and in the development of wood aggregates. For many years oxychloride cement floors with a mineral aggregate have been used for industrial flooring, in stores, over ship decking, etc., where a hard wear-resistant surface is required, and in houses as an underlayment for

Below, pulverized wood bark, *Silvacon*, mixed with magnesium oxychloride cement, forms this one-piece resilient flooring, poured-in-place and finished with a sander. Right, other types of flooring, shown about actual size: (1) *Oaktred*, wood chips in oxychloride cement; (2) *Dex-O-Tex* rubber flooring with a cork chip filler, and (3) same with marble chips for terrazzo effect. The rubber latex base sets hard yet resilient

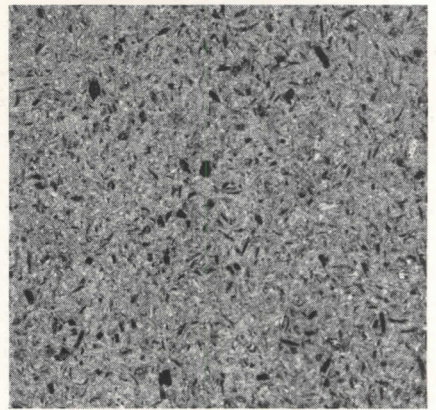

1

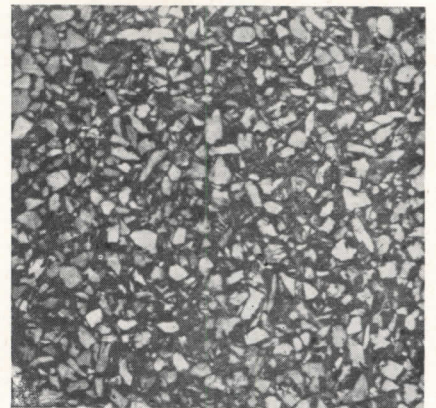

2



3

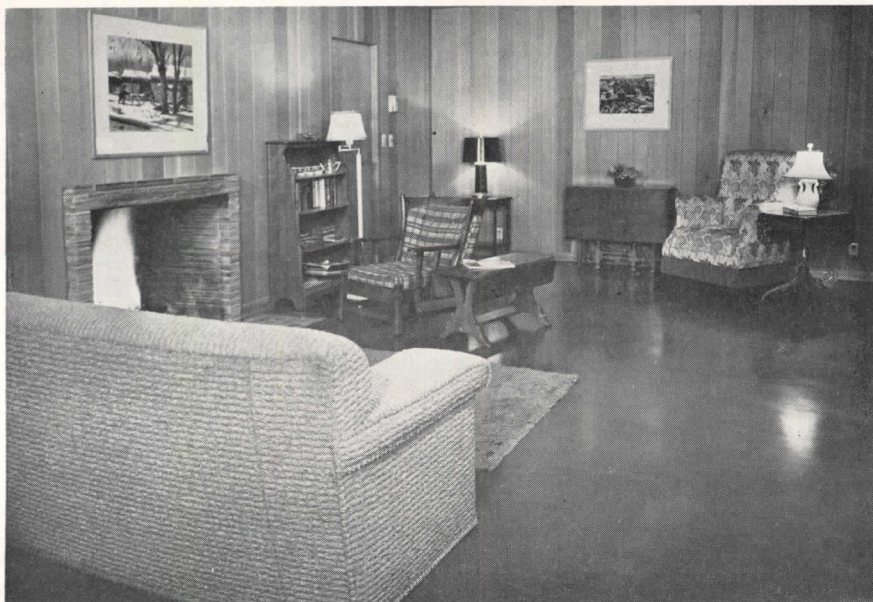

Loren Smith Photo



Steps in installing oxychloride cement floor over wood subflooring. Left, metal lath is nailed down over waterproof paper (neither is required on concrete subflooring which is broom finished). Center, the plastic mix is leveled off about $\frac{1}{2}$ in. thick. Right, after the cement has been troweled and allowed to set, the finished floor is sanded

linoleum and other floor coverings.

The oxychloride cements are formed by a reaction between magnesium oxide and a solution of magnesium chloride, which, in uniting, produce a dense, hard material, crystalline in structure, but horn-like in texture. To the cement can be added a wide variety of aggregates and fillers producing a finished floor with a wide range of physical characteristics.

Fillers have included asbestos, wood chips and wood flour, silix, marble flour, and sawdust. Aggregates may include sand, fine crushed stone or other chemically inert, low-absorbent, physically strong materials. Formulations for terrazzo floors include marble chips of selected colors. The wood types of magnesite floors are particularly suited to houses, since they are comfortable under foot, yet do not dent under the pressure of heavy furniture, and are insulating and sanitary.

This flooring can be laid over any subfloor such as wood, concrete, tile, steel, or stone. New concrete subfloors should be broom finished to assure a satisfactory bond, and allowed to cure for about 30 days before direct application of the oxychloride coating or about seven days if a bonding medium of rubber latex or plastic resin is used.

Over wood subfloors, a layer of asphalt-saturated felt is usually first applied, and an anchoring medium of expanded metal lath nailed over the felt. Steel subfloors must be free from rust and oil, and the anchoring medium (mesh, fabric, clips) securely fastened and protected with a base coating.

The ingredients of the flooring composition are mixed with water at the site, then spread over the floor to the specified thickness, leveled by darbying, and finished usually by sanding after a setting period of about 48 hours. Customary thickness for house floors is about

one-half inch. After finishing, the floors are waxed and maintained in the same way as hardwood flooring.

Rubber-Base Flooring: The resilience and toughness of rubber make it a particularly desirable floor surfacing material. By a new process, an aggregate of either marble chips or cork chips can be mixed with a liquid mastic of synthetic rubber latex, and spread over a subflooring to form a permanent finished floor in houses. The mix also contains a dehydrating powder to control the setting, and pigments for base coloring.

Installation is similar to that of magnesite composition flooring. No primer membrane is required except over wood subfloors or on concrete that is cast on grade, to prevent moisture seepage.

After spreading the flooring material

to the desired depth, usually $\frac{1}{4}$ to $\frac{3}{8}$ in. for the cork type and $\frac{3}{8}$ in. for the terrazzo, the mix is trowelled to a level surface, allowed to dry for from 48 to 72 hours, and then sanded or polished to a smooth finish. Maintenance requires only cleaning with soap and hot water.

While the cork flooring is more generally suitable for houses, the terrazzo type is sometimes used for dramatic effect. One particular installation features a black Carrara marble chip within a dark green rubber base.

The cork type floor is particularly quiet underfoot, and even the terrazzo type is resilient due to its cushioning rubber base. Weight per sq. ft., $\frac{3}{8}$ in. thick, is about 3 lb. for the cork flooring and $4\frac{1}{2}$ lb. for the terrazzo.

Photos courtesy of Crossfield Products Corp.; Kompolite Building Materials, Inc.; Oxychloride Cement Association, Inc.; and Raecolith Flooring Co.

Composition floors can be panel heated. In this Seattle house, electric heating coils are laid directly in the oxychloride cement flooring. Panel heating with hot water is possible when pipes are laid near the surface of concrete subflooring



Loren Smith Photo

PRODUCTS for Better Building

PLASTIC WALL TILE

Levitt & Sons, Inc., is using a new type of plastic wall tile in kitchens and bathrooms of houses being built in a development on Long Island, N. Y., where last year it produced and sold 1000 houses. After the rough plastered walls are coated with a special mastic cement, the tile, called *Pittsburgh Interlocking Wall Tile*, is pressed into place quickly and accurately due to its self-aligning design. Two edges of each $4\frac{1}{4}$ -in. square have an alternately concave and convex overlap which serves to align them with preceding tiles. There is also a small locking "dot" in the center of one edge that fits into a notch in the edge of the opposing tile. These features lock the tile in horizontal and vertical alignment, and also form a seal between the tiles, eliminating the need for grouting the joints. The tiles can be cut to fit where necessary. They are now being made in six field colors (plain white and ivory, and marbled blue, green, yellow, and peach) and three trim colors (black, dubonnet, and blue), in half-tile, feature strips, cove base, and outside corners. Pittsburgh Tile Co., Pittsburgh, Pa.

PRECAST SYSTEM

A number of industrial buildings, employing the *Cemenstone System* of precast reinforced concrete construction, have gone up recently in the Pittsburgh area. In this system, the architect is offered a variety of simplified and standardized framing members, floor slabs, and wall panels, that are factory cast to specifications within certain limits. The building units consist of interior columns, wall columns, girders or beams, joists, flat slabs, long-span channel slabs, wall panels, and brackets. Tables similar to structural steel load tables

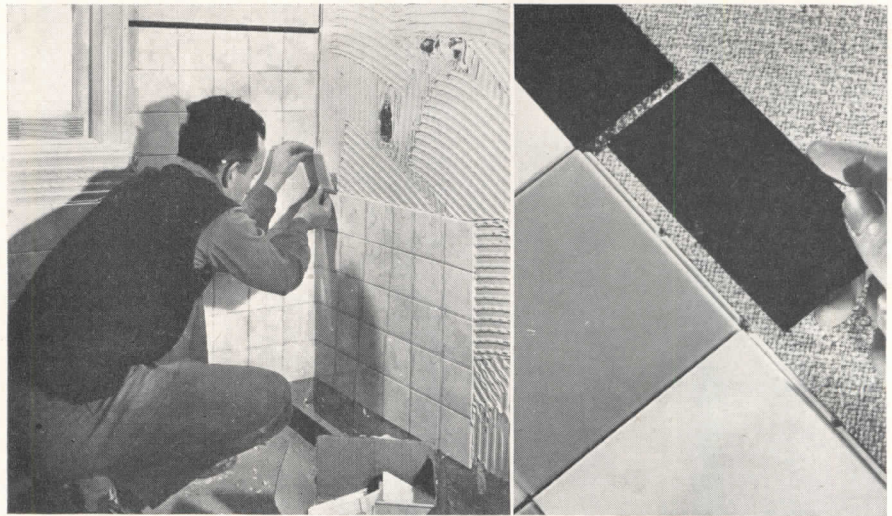

Plastic tile has interlocking feature for easy alignment, is cemented to wall with a mastic

are used to select the right size framing members.

Concrete framing has suffered in the past from poor connecting methods. Here, welding is used to join embedded pipe sections to the reinforcing in other members, and roof slabs and wall panels are tongued and grooved. A crawler crane is used to transport the large precast units on the job; and can pick up and place a 5-ft. by 20-ft. wall panel in 10 minutes.

Standardized casting procedures and simplification in structural design are said to make possible great savings in construction time. For example, the structural framing units of a one-story building, covering 8500 sq. ft., were erected in about six weeks after receipt of the initial order; actual erection time was four days, using a crew of six men and a mobile crane. Cemenstone Corp., Neville Island, Pittsburgh 25, Pa.

THERMOPANE

Following a two year period in which deliveries of *Thermopane insulating glass* were very slow, the manufacturer now announces that the back-order file has been brought down to a 45-day basis, and stocks of standard size Thermopane have been shipped to distributors all over the United States. As a result, orders for standard sizes can in most cases be filled immediately and orders for any size can be filled in 45 days. Libbey-Owens-Ford Glass Co., Toledo 3, Ohio.

DUMBWAITER-CONVEYOR

Designed for mechanized food handling in hospitals or institutions, the *Olson Subveyor* is a combination horizontal conveyor and vertical dumbwaiter. In the kitchen, trays are placed on the conveyor belt and food items added to them while in motion. As each tray reaches the dumbwaiter, it is automatically picked up and carried to the desired floor above. Control is effected through a pushbutton selector located in the kitchen and tied up with signal buttons on the floors above. Trays of soiled dishes are placed in the descending machine, and automatically transferred to a belt conveyor in the dishwashing room and carried to the scrapping table. Samuel Olson Mfg. Co., Inc., 2418 Bloomingdale Rd., Chicago 47, Ill.

STAIR PLANNING

A multiple scale on transparent plastic contains 10 important scales for spacing stair risers, treads, rafters, studs, joists, etc.; and a calculator for computing factors in stair planning. All scales are calibrated $\frac{1}{8}$, $\frac{1}{4}$, and $\frac{1}{2}$ in. to the foot. Rapidesign, Inc., Dept. AR, 111-B South Orange Ave., Glendale 4, Calif.

Standardized system of precast structural members speeds industrial building construction

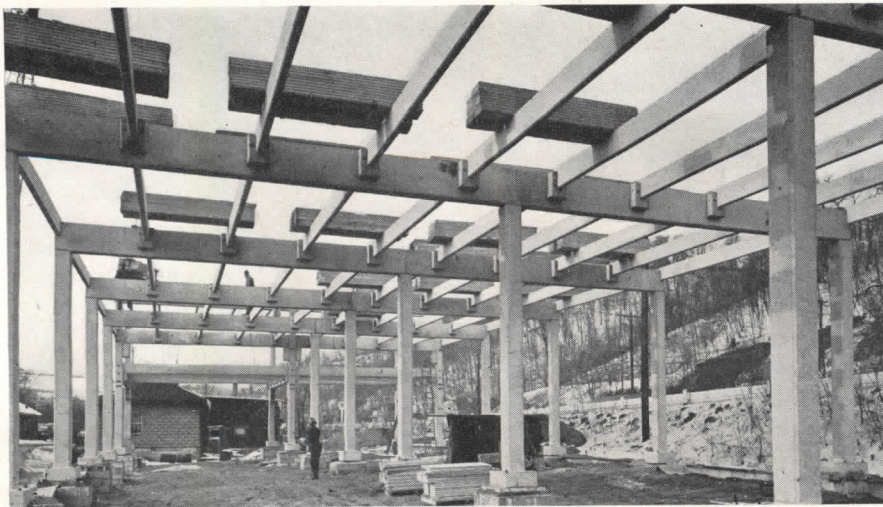

(Continued from page 117)

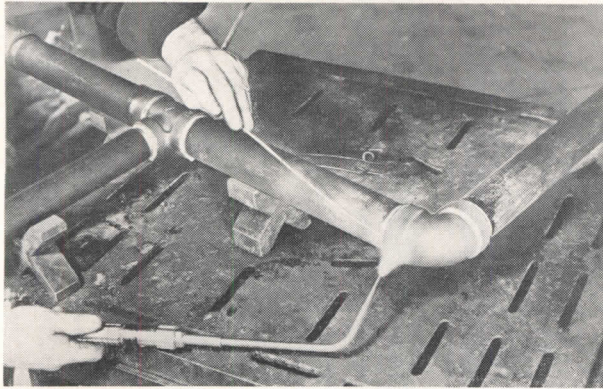

Left, malleable pipe fittings, designed for brazing, eliminate need for threading and make possible reduced wall sections in pipe

THREADLESS FITTINGS

A new type of malleable fitting now makes possible brazed connections with small-diameter steel and wrought iron pipe. Described as a development that opens the way to reducing the wall thickness and weight of such pipe, *Flagg-Flow malleable iron fittings* are threadless and enable the use of plain end pipe. Since none of the pipe wall is cut away by threading, lighter piping can be used without loss of strength. Designed for brazing to standard black steel or wrought iron pipe, the new fittings are currently made in sizes up to and including 2 in., which comprise a large portion of the piping now installed.

Engineers of the Flagg Company point out that in piping the ideal has always been to obtain the strength and tightness of a "one-piece" system. Welding has solved this problem to a large extent on high-pressure and high-temperature lines, but has been less practical for non-critical piping in the bulk of moderate pressure and temperature systems.

Complete freedom in piping layout is claimed, since Flagg-Flow fittings can be placed in exactly the position desired and brazed in that position. The silver brazing alloy flows by capillary action to form a seamless joint. If desired, joints can be made flush against a wall or each other.

The fittings are applicable for 150-lb. working steam pressure at 450° F., or 300-lb., non-shock, oil, water, or gas lines at 150° F. Stanley G. Flagg & Co., Inc., Philadelphia, Pa.

SHADING MEDIUM

For draftsmen and renderers, there is a new type of mechanical shading medium, a tissue-thin adhesive-backed transparent sheet known as *V-Film*. The sheet contains an invisible shading pattern which appears only when it is brushed with a special developer; permitting a natural brushing technique and eliminating the need for cutting out printed patterns. According to the manufacturer, rubbing or erasing will not

injure the shading since it is processed into the sheet; and the film can be quickly stripped off the drawing when desired. Craftint Mfg. Co., 1615 Colamer Ave., Cleveland 10, Ohio.

ACOUSTICAL ROOM

An almost completely echo-free room has been built by Bell Telephone Laboratories as a place for acoustical research. Here sounds are studied in their pure unaltered state, unaffected by their reflection or echo. Walls, ceiling, and floor are lined to a depth of 5 ft. with "wedges" of glass fiber acoustical material, bonded with Bakelite phenolic resins. The work floor, suspended in space, is formed from a mesh of thin steel cables, capable of supporting several tons of equipment. The room's unique design is reported to eliminate 99.98 per cent of incident sound.

HOSPITAL FOOD CART

A new hospital meal service cart has been announced which "moves the serving pantry to the patient's door." Known as *Mealpack Tray Cart Model 20*, it provides service for 20 complete meals assembled in the kitchen. The tray cart is not heated; food and beverages are kept hot or chilled in insulated stainless steel containers. Mealpack Corp. of America, 152 W. 42nd St., New York 18, N. Y.

AIR DIFFUSER

Ease of adjustment is featured in the *C-1 Anemostat Air Diffuser* which projects the desired air flow pattern at the turn of a knob, from draftless diffusion to downward projection. Room air is drawn into the device and mixed with supply air, at various ratios, so that the Anemostat can be used for heating, ventilating, or cooling in combination. Adjustment can also be made by remote automatic or manual control; and pneumatically operated control equipment can be installed to adjust any number of Anemostats simultaneously. Anemostat Corp. of America, 10 E. 39th St., New York, N. Y.

(Continued on page 140)



Special acoustical room is designed for complete sound absorption. Work floor is steel net suspended in space



Mobile hospital canteen has individual insulated containers of stainless steel

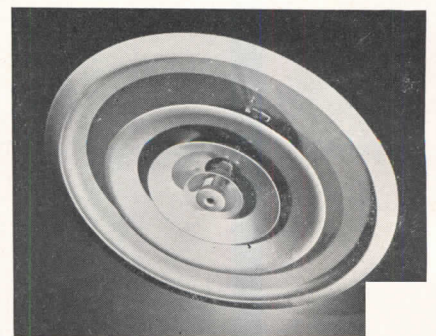

Air diffuser features easy adjustment

MANUFACTURERS' LITERATURE

DIFFUSING GLASS

Magnalite Diffusing Glass (Catalog M-48). Describes a type of textured glass with cylindrically shaped "lenses" covering the surface for even light distribution; examples of its use for screens and partitions, skylights, and as a fluorescent lighting shield. 4 pp., illus. J. Merrill Richards, 25 Huntington Ave., Boston 16, Mass.*

KITCHEN PLANNING

The Key to Convenient Kitchens Styled in Steel. Catalog of kitchen sink, counter, and storage units, and plans of suggested kitchen arrangements in various sizes and shapes. 16 pp., illus. American Central Division, Avco Mfg. Co., Connersville, Ind.

SOUND CONTROL

Johns-Manville Sound Control. Materials and procedures for quieting noise, correcting acoustics, and isolating vibration. Particular attention is paid to the design of acoustical ceilings combined with fluorescent troffers; also Transite acoustical panels, and acoustical treatment of broadcasting studios. Provides construction details and a data chart giving basic information about the various sound-control products. 16 pp., illus. Johns-Manville, 22 E. 40th St., New York 16, N. Y.*

GRANITE

Color in Granite. A description of the various kinds of architectural granite, accompanied by photographs in color. Available types include not only domestic granite but also the products of quarries in Canada, South America, Europe, and Africa. While not a design manual, the booklet contains certain essential data on slab sizes, tolerances, thicknesses, and finishes. 16 pp., illus. H. E. Fletcher Co., West Chelmsford, Mass.*

STORE FRONTS

Brasco Safety-Set Store Fronts (Catalog 48). Details of sash and sill standard stock members, in stainless steel or anodized aluminum, to support and protect today's enlarged glass areas; quarter-size details of safety-set construction for holding plate glass without pressure, springs, or set screws. Brasco Mfg. Co., Harvey, Ill.

PHOTOGRAPHIC PAPER

Kodagraph Autopositive Paper. Booklet describing a silver-sensitized paper for reproducing engineering draw-

* Other product information in Sweet's File, 1947.

ings in normal room lighting using standard blueprint or direct process printers; especially designed for "plus" reproduction of poor tracings. 8 pp., illus. Industrial Photographic Division, Eastman Kodak Co., 343 State St., Rochester 4, N. Y.

LIGHTING

Fluorescent Fixture Selector. A slide-rule device, offered as a time-saver for estimating the number of lighting fixtures needed for desired maintained footcandles of light in a given area. While the Selector features basic fixtures of the Mitchell line, it reportedly also can be used in connection with practically any type of fluorescent fixture. Mitchell Mfg. Co., 2525 Clybourn Ave., Chicago 14, Ill.*

(1) **Indirect Lighting at Its Best;** (2) **Versa-Unit.** Describes suspension type luminaires for shielded incandescent lighting; also a new type of parabolic fixture with a flexible arm or swivel mounting. 8 and 2 pp., illus. Kurt Versen Co., Englewood, N. J.

Interior Lighting (B-3539). A booklet for architects, electrical contractors, and lighting engineers, describing the new recessed troffer luminaires, with photographs, sketches, schematic diagrams, illumination design data, and suggested layouts for various conditions. 12 pp., illus. Westinghouse Electric Corp., P.O. Box 868, Pittsburgh 30.*

Powerstat Theater Dimmers (Bulletin 347). Equipment for the control of lighting intensities, with stepless variations from black-out to full brilliancy; also description of a custom-built unit for multiple color blending in store display windows. 4 pp., illus. The Superior Electric Co., Church St., Bristol, Conn.

Thompson Disconnecting and Lowering Hangers. A complete catalog of lamp suspension equipment and accessories, chiefly for industrial installations. Includes a section devoted to application and dimension diagrams. 82 pp., illus., in looseleaf binder. The Thompson Electric Co., 1101-11 Power Ave., Cleveland 14, Ohio.

HEATING

Airtherm Modern Convectur Radiation (Bulletin 701). Introduces a new line of convectur radiators for hot water and steam systems; dimensional drawings of the three types: free standing or partially recessed, regular wall cabinet, or sloping top wall cabinet; tables for

selecting proper convectur size. 8 pp., illus. Airtherm Mfg. Co., 702-F S. Spring Ave., St. Louis 10, Mo.

Hoffman Controlled Heat Furnace.

Brochure describing an automatic oil-fired furnace for warm-air heating; designed especially for small houses and available in two models, for basement or utility room installation. 4 pp., illus. Hoffman Specialty Co., Indianapolis, Ind.*

I-B-R Ratings for Cast Iron Boilers.

Includes ratings for boilers being offered for sale by 18 manufacturers: gross and net ratings, burner capacities, and chimney sizes. Ratings are based on actual output under test, regardless of design, heating surface, or grate area. Burner capacity is the hourly input rate required to develop the gross output, expressed in gallons of oil or pounds of coal. Institute of Boiler and Radiator Manufacturers, 60 E. 42nd St., New York 17, N. Y. 50 cents.

Trane Presents 8 Pages of Heating Products. Brief description of available heating and air-conditioning units: heating coils, convectur-radiators, unit heaters, valves and traps, hot-water circulators, fans, and ventilators. 8 pp., illus. The Trane Co., LaCrosse, Wis.*

BUILDING MAINTENANCE

Over the Rough Spots. Handbook of floor repair and resurfacing materials for industrial plants; also maintenance procedures for walls, roofs, and sidings; and special problems in railroads, mines, public utilities, and water works. 48 pp., illus. Stonhard Co., 401 N. Broad St., Philadelphia 8, Pa.*

ELECTRICAL FUSES

Pierce Balanced Lag. A description of the significance of balanced lag in electrical fuses, which reportedly avoids unnecessary blows, among other advantages. 4 pp., illus. Pierce Renewable Fuses, Inc., 211-219 Hertle Ave., Buffalo, N. Y.

BLOWERS

Blowers and Exhausters (B-5 Bulletin). Describes basic line of centrifugal-type blowers and exhausters for a variety of industrial uses: capacity tables, design features, and general specifications. 20 pp., illus. Lamson Corp., Allen Billmyre Division, Syracuse 1, N. Y.*

ELECTRIC PLANTS

Electric Plants (Form A-138). Catalog of models ranging from 350 to 35,000 watts, alternating current, in all standard voltages, frequencies, and phases. If direct current of the "direct service" type is required, selection ranges
(Continued on page 150)

INSULATION OF CONCRETE FLOORS IN DWELLINGS

*Suggestions Based on Research by Housing and Home Finance Agency**

THE extensive use in house construction of concrete slab floors, cast on the ground or over unheated crawl spaces, calls for special structural insulation to avoid cold floors. The most effective way is by insulating the concrete floor at its edge and insulating all crawl space walls.

Suggested insulation details grew out of a series of tests** conducted by the National Bureau of Standards to determine the thermal characteristics of concrete floors. The findings again gave proof of the high conductivity of concrete floors which makes them feel colder to the touch than other floor materials at the same temperature.

The actual (surface) temperature of a concrete floor, however, can be just as satisfactory as other floors if resistance is placed in the paths of greatest heat flow.

The heat loss of slab floors laid on the ground is primarily through the edge. Heat loss through the center is relatively small due to the insulating value of the thick layer

of earth beneath it through which heat must flow to reach the outside air.

Over enclosed crawl spaces, heat loss also is principally through the edge, though the loss through the center is relatively higher than with floors laid on the ground.

For comfort, the floor temperature should not fall below 60° F. at approximately 1 ft. from the exterior wall when room temperature is maintained at 70° F. Farther from the wall, the floor will of course be warmer.

When properly insulated, a concrete floor presents a more uniform temperature over the entire surface than do most other floors. Cool air drops down along the inside of all exterior walls, cooling the floor at that point. Since concrete is a better conductor than most materials, heat is conducted more readily from the warmer central portion of the floor to the cooler edges.

In general, conditions of comfort can be obtained by:

1. Insulating the edges of the concrete slab laid on the ground and extending the insulation for a distance under its perimeter.
2. Insulating the slab edges of

concrete floors laid over crawl spaces and insulating the exposed wall of the crawl space.

These methods are generally more effective than insulation placed under the entire slab and are easier to install satisfactorily.

Insulating Materials: The selection of insulating materials depends upon several factors: durability; strength to withstand pressure of the earth and imposed loads; relative insulation value; and cost.

Insulating materials placed in or near the ground must resist moisture, mildew, termites, etc. Where a material depends upon a coating of asphalt or coal tar pitch for protection, it is necessary to select the coating carefully, bearing in mind that the solvents in pitch will affect asphalt. This is important where such coated materials are to be used in contact with roofing felt.

The accompanying table contains some information about several insulating materials which might be used; suggested details of construction will be found on the following Time-Saver pages.

(Continued on page 123)

INSULATING MATERIALS FOR CONCRETE FLOORS

Material:	Cellular Glass Enclosing Sealed-in Gas, such as Foamglas	Glass Fibers with Plastic Binder, such as Fiberglas, Coated or Uncoated
Thickness:	2, 3, 4, and 5 in.	¾, 1, 1½, and 2 in.
R (Resistance Value; per 1 in. thick)	1.82 to 2.22	3.33 to 3.85
Characteristics:	Crushing strength approximately 150 lb. per sq. in. Water absorption negligible. Easily cut, indented, etc. Will not adhere to masonry.	Supports about 12 lb. per sq. in. Water penetration into uncoated board is slow and disintegrates the binder; penetration into coated board is inconsequential unless exposed to constant head of water.
Suggestions:	Surface may gradually spall away if subjected to moisture and freezing. Dip in roofing pitch or asphalt for protection. Use tie wires for attaching to masonry.	Use coated board or apply coal tar pitch or asphalt. Where moisture is expected, coat all cut edges. Follow manufacturer's instructions for cutting.
Material:	Cane or Wood Fiber Boards, such as Celotex	Hard Cellular Rubber Enclosing Sealed-in Gas, such as Hard Rubber Board or Rubatex
Thickness:	½, 25/32, 1 in., etc.	½, ¾, 1, 1¼, 1½, and 2 in.
R (Resistance Value; per 1 in. thick)	2.50 to 2.86	4.00 to 5.00
Characteristics:	Crushing strength is adequate. Boards are subject to moisture penetration. Deteriorate under damp conditions.	Crushing strength is approximately 70 lb. per sq. in. Water absorption negligible. Easily cut, indented, etc. Does not adhere adequately to masonry.
Suggestions:	Coat boards and all cut edges heavily with coal tar pitch. Do not use in locations subject to considerable moisture.	Split board with leather splitting machine to reduce costs. Coat with asphalt or pitch, or use metal ties or cement keys where necessary to bond to masonry.



three mistaken ideas about Sound Conditioning...

- mistake #1** **THAT SOUND CONDITIONING IS EXPENSIVE...**
The fact is: The cost of Acousti-Celotex* treatment in many installations hardly exceeds the budget for the finish coats of plaster and paint that it can replace. And where a suspended ceiling may be specified, Acousti-Celotex sound conditioning can often be added for only a few cents more a square foot.
- mistake #2** **THAT SOUND CONDITIONING IS A LUXURY...**
The fact is: Letters and figures from thousands of different applications show that, far from being a luxury, Acousti-Celotex sound conditioning is a sound investment... because it increases output, cuts down errors, and reduces employee turnover.
- mistake #3** **THAT THE USE OF SOUND CONDITIONING IS LIMITED TO SPECIFIC AREAS...**
The fact is: More and more architects are specifying overall use of Acousti-Celotex sound conditioning for truly modern buildings offices, hospitals, schools, banks, and other structures. Incidentally, *more sound conditioning has been done with Acousti-Celotex products than with any other material.*

YOU ARE INVITED to submit your acoustical problems to a trained sound technician—your nearest distributor of Acousti-Celotex products. He brings you a judgment enriched by the accumulated experience of a quarter century in sound conditioning . . . and the proved performance of Acousti-Celotex in more than 200,000 installations. Look for him in your classified phone directory, or drop us a line saying when you would like to see him. In the meantime, you'll find Acousti-Celotex products listed in Sweet's File, Section 11-A3.

*REG. U. S. PAT. OFF.

THE CELOTEX CORPORATION, CHICAGO 3, ILLINOIS



ACOUSTI-CELOTEX
TRADE MARK REG. U. S. PAT. OFF.
Sound Conditioning

PRODUCTS FOR EVERY SOUND CONDITIONING PROBLEM



**ANY PROBLEMS?
OUR LAYOUT SERVICE
MAY HAVE THE ANSWERS**

How to get the effects you want?

Day-Brite's lighting layout service can save you lots of time and work by suggesting fixtures and layouts best suited to deliver the desired maintained intensity and harmonize with your architectural treatment. For many years our experienced illumination engineers and designers have been assisting many foremost architects with their planning. May we help you, too?

Send for your nearby Day-Brite representative and tell him your needs. We'll do the rest!

Day-Brite Lighting, Inc., 5465 Bulwer Avenue, St. Louis 7, Mo.

Nationally distributed through leading electrical supply houses.

In Canada: address all inquiries to Amalgamated Electric Corp., Ltd., Toronto 6, Ont.



365

IT'S EASY TO SEE WHEN IT'S

DAY-BRITE

Lighting

INSULATION OF CONCRETE FLOORS IN DWELLINGS

(Continued from page 120)

Suggestions Based on Research by Housing and Home Finance Agency

Suggested Details show how heat loss through slab edges can be reduced satisfactorily by placing resistance in the paths of greatest heat flow. The drawings show some unconventional types of construction, the intention being to show insulating principles in graphic form while leaving the construction type to the choice of the designer.

The insulation shown is based on minimum desirable results for a heating design temperature of -20°F . Resistance values "R" are given rather than a specific thickness of

insulation. (See Table of Materials on page 120 for resistance values of various materials.)

Variations in requirements for other design temperatures and for floor heating are given below.

Design Temperature	Relative Percentage for Values of R*	
	(No Floor Heating)	(Floor Heating)
-20°F .	100%	150%
0°F .	75%	113%
20°F .	50%	75%

* For any homogeneous material, the resistance value (R) varies in proportion to the thickness of the material.

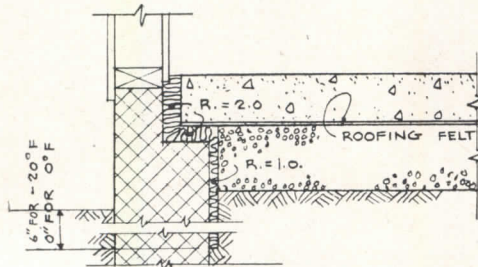

INSULATION AT INSIDE OF FOUNDATION WALL

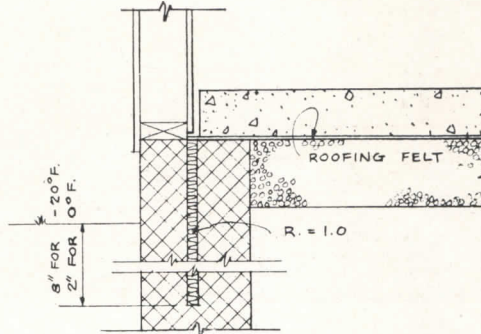
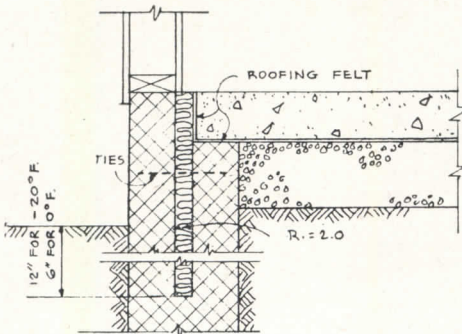

INSULATION AT CENTER OF FOUNDATION WALL

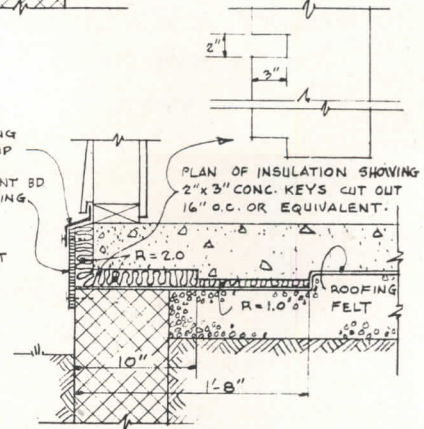
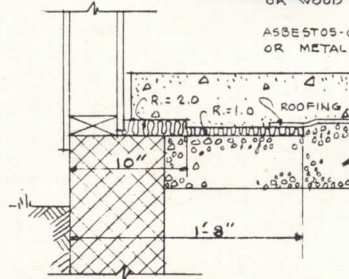
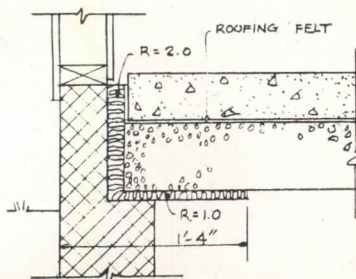
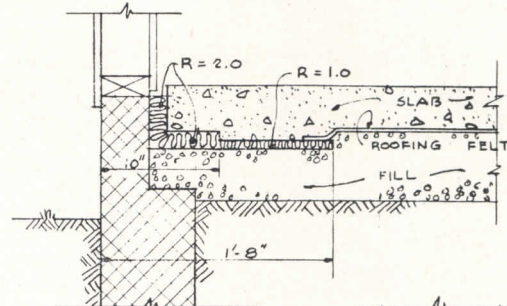
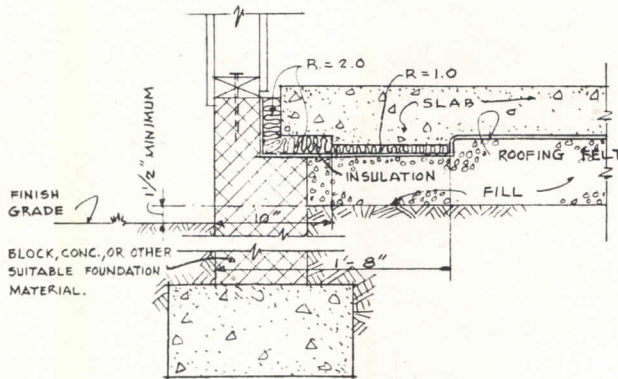

CONCRETE SLAB ON GROUND

(Continued on page 125)

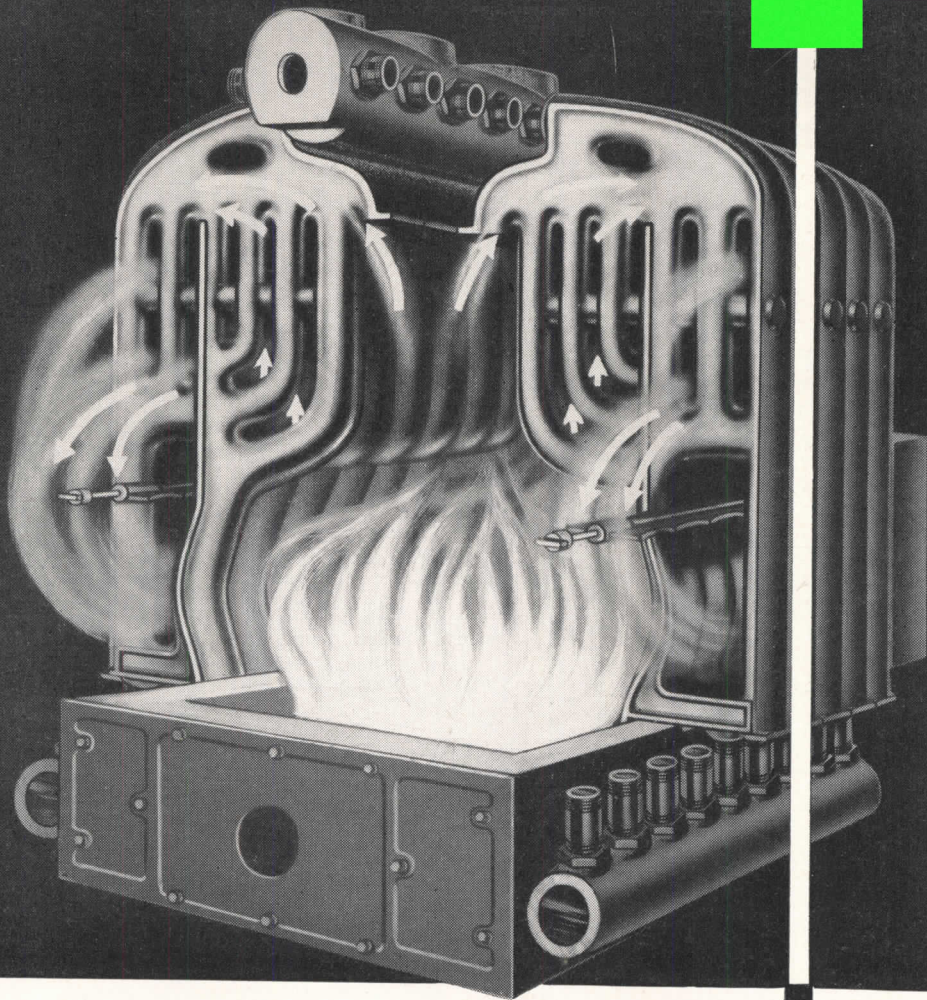

How many boilers do you see?

The nine-section Mills 44 boiler illustrated above is actually 18 boilers, guaranteeing you 18 times as much security as any other type boiler. If, for any reason, a section becomes disabled, 17 other boilers continue to function, without interruption!

Why so? Header type construction makes each section a separate boiler — *each* receives returns uniformly from return drums and *each* discharges to a steam drum. A

cracked section can be temporarily blocked off by simply cutting its supply and return nipples and plugging the drums. The replacing section can then be installed when convenient.

There's a place for Smith-Mills boilers wherever *continual, uninterrupted, economical* heating is necessary. Other unique and exclusive advantages of Smith-Mills boilers are described thoroughly in the H. B. Smith Catalog . . . write for it.

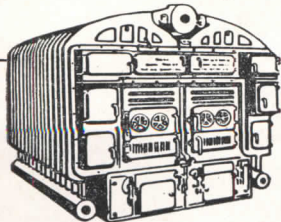

H.B. *Smith*

CAST-IRON BOILERS

THE H. B. SMITH CO., INC., 62 Main Street, Westfield, Mass. Offices and Representatives in Principal Cities

INSULATION OF CONCRETE FLOORS IN DWELLINGS

(Continued from page 123)

Suggestions Based on Research by Housing and Home Finance Agency

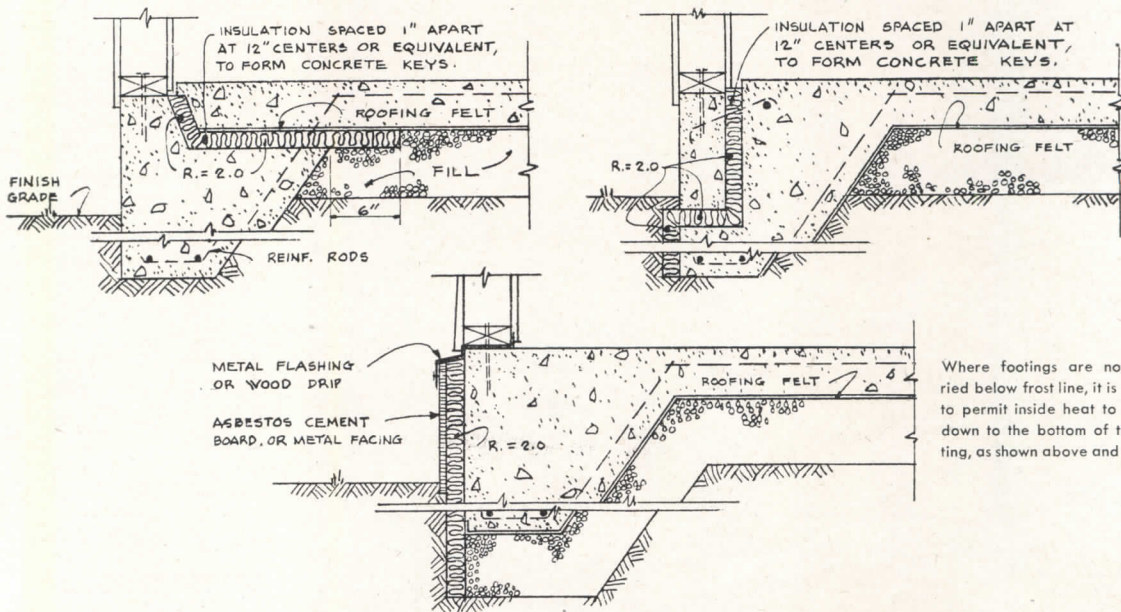

FLOATING SLAB FOUNDATIONS

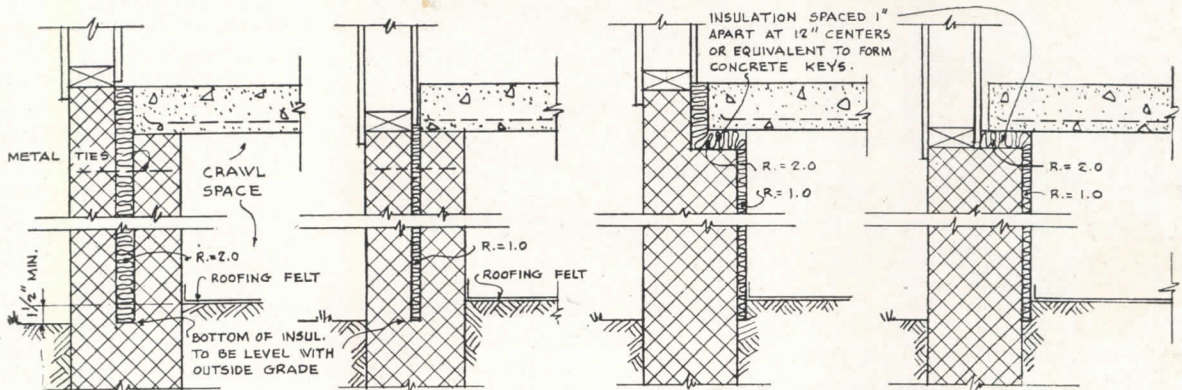

CONCRETE SLAB OVER CRAWL SPACE

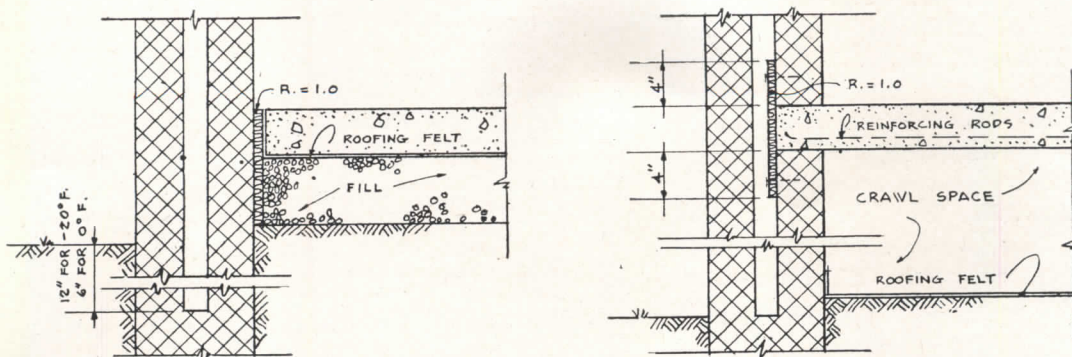

CAVITY WALLS

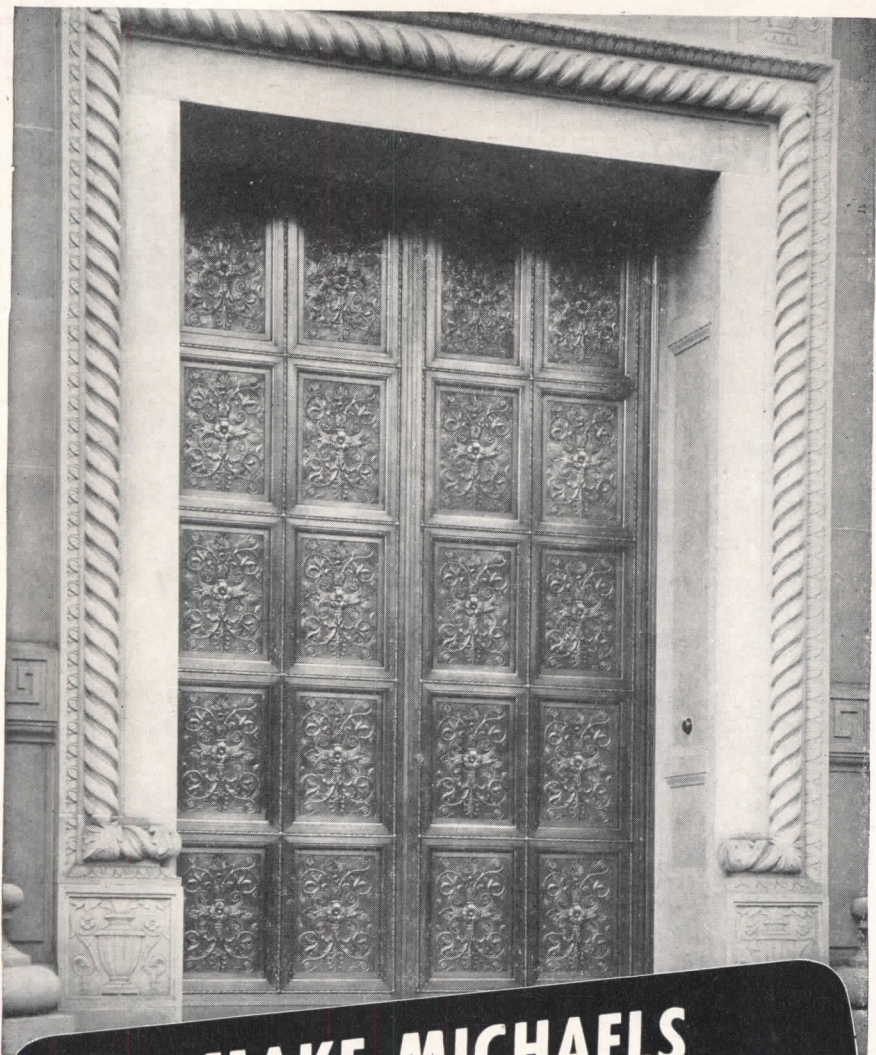

**★ MAKE MICHAELS
YOUR SOURCE OF SUPPLY
FOR METAL BUILDING PRODUCTS**

Since 1870 this organization has manufactured bronze, aluminum and nonferrous metal products to meet virtually every building requirement. During this time a large part of our work has been the faithful reproduction, in metal, of architects' creations and plans. Today we are in an even better position to handle this class of business. So, whether it be new construction or a remodeling job, don't overlook the products and service offered by Michaels. Write for more details. The bronze door illustrated above is only one of many Michaels products. A partial list is given in the next column.

The Michaels Art Bronze Company, 234 Scott St., Covington, Ky.

**Member of the National Association of Ornamental
Nonferrous Metals Manufacturers**

MICHAELS PRODUCTS

- Fixtures for Banks and Offices
- Welded Bronze Doors
- Elevator Doors
- Elevator Enclosures
- Check Desks (standing and wall)
- Lamp Standards
- Marquise
- Tablets and Signs
- Name Plates
- Astragals (adjustable)
- Railings (cast and wrought)
- Building Directories
- Bulletin Boards
- Cast Radiator Grilles
- Grilles and Wickets
- Kick and Push Plates
- Push Bars
- Cast Thresholds
- Extruded Thresholds
- MI-CO Parking meters
- Museum Trophy Cases

THE RECORD REPORTS

(Continued from page 16)

Other Developments

Here's a quick glance at other construction developments:

1. The Veterans Administration has inaugurated a new plan of inspection of houses while they are under construction. Optionally available to builders, lenders, etc., the plan provides a definite commitment as to "reasonable value" in advance of construction for sale to veterans under the G.I. Bill.

2. The Commerce Department has extended its export controls to include additional iron and steel products. It is continuing its controls on lumber.

3. The Civil Aeronautics Administration has set maximums on length and strength of airport runways for which federal money will be supplied.

4. HHFA has announced a new publication to be issued at frequent intervals called "HHFA Technical Bulletin." The first issue deals with lower costs through codes, housing research, insulation of concrete floors, and earth constructions.



ON THE CALENDAR

Dec. 1-Feb. 29: Exhibition of French tapestries of the 14th to 20th Centuries, lent by the government of France. Metropolitan Museum of Art, New York City. (See page 10.)

Jan. 10-29: "Arts of Early People," exhibition from the anthropology collection of the University, School of Architecture and Allied Arts, University of Oregon, Eugene, Ore.

Jan. 12-16: 2nd National Materials Handling Exposition, Public Auditorium, Cleveland, Ohio.

Jan. 21-24: Annual Meeting, American Society of Civil Engineers, Hotel Commodore, New York City.

Jan. 26-29: 5th All-Industry Refrigeration and Air Conditioning Exposition, Public Auditorium, Cleveland, Ohio.

Jan. 26-30: Winter General Meeting, American Institute of Electrical Engineers, Pittsburgh, Pa.

Feb. 2-6: Air Conditioning Exposition (8th International Heating and Ventilating Exposition), Grand Central Palace, New York City.

Feb. 7-26: "French Prints from Corot to Picasso," exhibition of drawing, etching and lithography, School of Architecture and Allied Arts, University of Oregon, Eugene, Ore.

Feb. 11-12: Building Forum and Clinic, Pennsylvania State College, State College, Pa. (Registration limited; see page 136 for details.)

March 2, 4, 8, 10, 11: Series of public
(Continued on page 128)

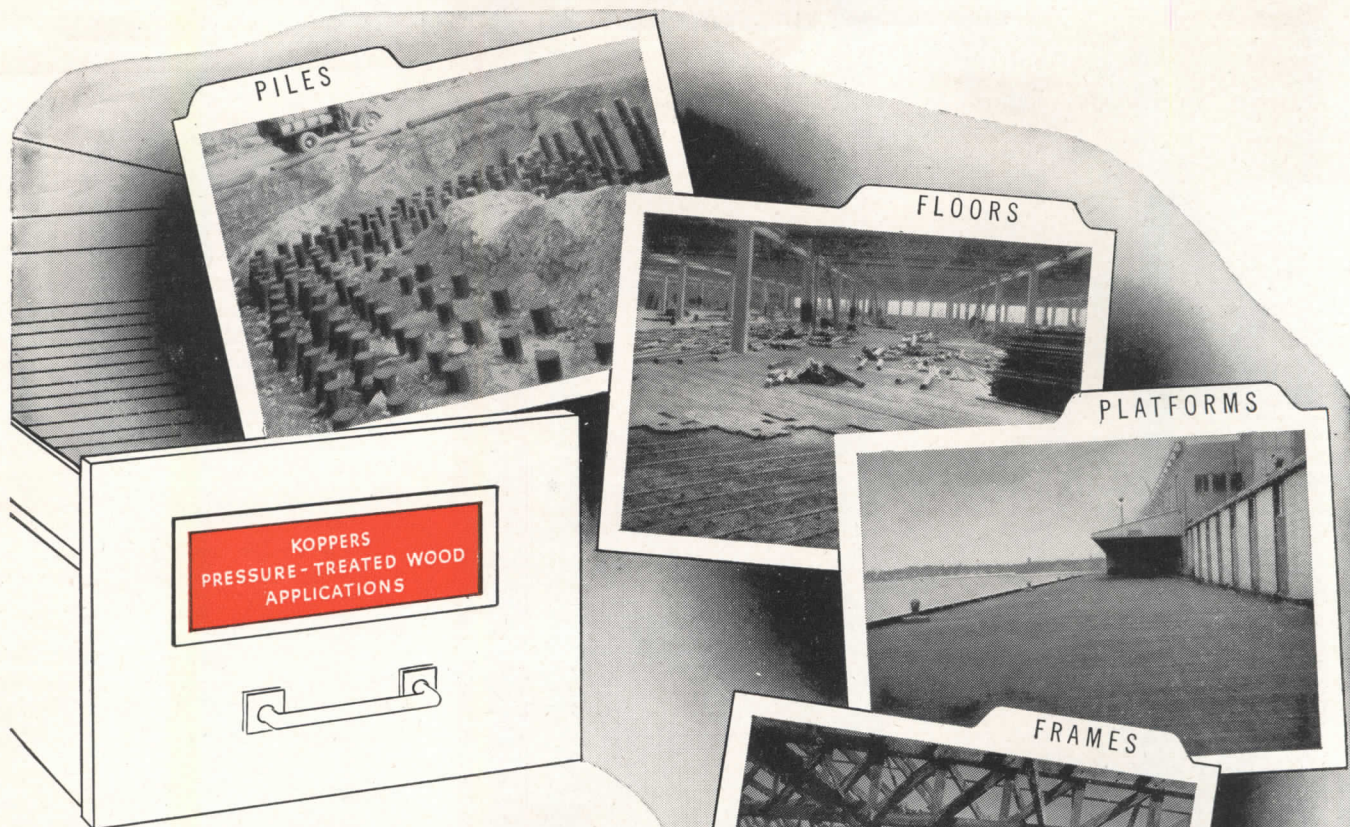

IF YOU'RE SEEKING SAVINGS
 in **CONSTRUCTION** and **MAINTENANCE**
here's the place to look!

If rocketing construction costs have brought you budget problems, let Koppers pressure-treated wood solve them. In applications from foundations to roof decks, it brings *present savings* in building costs—*future savings* through long, trouble-free life and low maintenance.

PERMANENT FOUNDATION WORK. Koppers pressure-creosoted piles provide high load-bearing capacity at low cost. Preservative treatment permits cut-offs to be safely made above water table.

ROT-RESISTING FLOORS. A wood floor or sub-structure on or near the ground faces a decay threat. Koppers pressure-treated wood gives dependable protection against this hazard.

ENDURING PLATFORMS, WALKS, STEPS, and OVERPASSES. Koppers pressure-creosoted wood protects against decay, which is the primary cause of much wear and mechanical failure. It makes outside structures serve longer.

FIRE-RETARDANT FRAMING. Koppers fire-retardant treatment, applied to vulnerable building members, gives a high degree of protection against fire, dependable resistance to decay and insect attack as well.

DECAY-DEFYING ROOFS. Wherever humid atmospheres create a decay hazard, Koppers pressure-treated wood provides essential protection for long dependable service.



PRESSURE-TREATED WOOD
 KOPPERS COMPANY, INC:
 PITTSBURGH 19, PENNSYLVANIA

THE RECORD REPORTS

(Continued from page 126)

lectures, "Cities in Transition — The Causes and Consequences of Metropolitan Decentralization," Frick Chemical Laboratory, Princeton University, Princeton, N. J. (See p. 134.)

March 6: Symposium on Educational Buildings, sponsored by the Pennsylvania Society of Architects, Houston Hall, University of Pennsylvania, Philadelphia.

March 6-20: "Eckbo, Royston and Williams," exhibition of landscape architecture, School of Architecture and Allied Arts, University of Oregon, Eugene, Ore.

March 15-19: 6th Annual A.S.T.E. Industrial Exposition, and 16th Annual Meeting, American Society of Tool Engineers, Cleveland, Ohio.

March 22-24: 1948 Chicago Production Show and Technical Conference, Chicago Technical Societies Council, Stevens Hotel, Chicago, Ill.

CONSTRUCTION REPORT

Investments in construction amounting to \$793,286,000 in October in the 37 states east of the Rocky Mountains, reports F. W. Dodge Corporation, pushed the chart lines upward to a level 22 per cent higher than the volume shown for the previous month and 38 per cent higher than in October of last year, to bring the cumulative total for the first 10 months of 1947 to \$6,419,397,000, almost even with that reported for the corresponding period of 1946.

The greatest October gains compared with September were shown for Texas, up 85 per cent; southern Ohio and Kentucky, up 67 per cent; western Missouri, Kansas, Nebraska and Oklahoma, up 54 per cent; upstate New York, 51 per cent; and New England, 41 per cent.

Gains in October construction contract volume over September were reported for all other areas east of the Rocky Mountains except western Pennsylvania and West Virginia, down 12 per cent; the northern and eastern areas of Ohio, down 4 per cent; Minnesota and the Dakotas, down 1 per cent.

The strongest advances were in residential building contracts, October gains of 30 per cent over September and 49 per cent over October of last year being reported, with the cumulative volume of the first 10 months of the year being 3 per cent below that for 1946.

Nonresidential contracts in October totaled 16 per cent more than in September and 23 per cent more than in October, 1946, the cumulative 10-month total being 7 per cent less than that shown for the comparable period of last

(Continued on page 130)

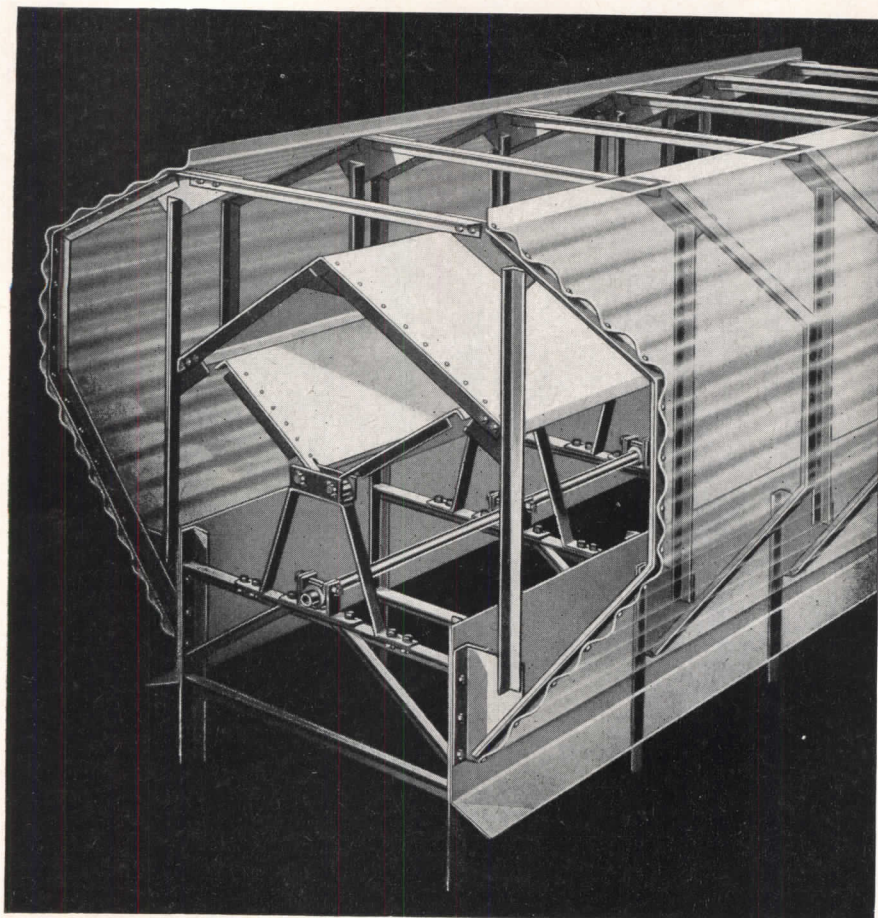

SPEED PRODUCTION WITH THE ECONOMICAL BURT MONOVENT

This highly efficient ventilator may be installed on any type roof to exhaust heat, smoke and fumes the entire length of the building. Its simplicity and heavy construction assure extremely long, trouble-free life with practically no maintenance expense. The Burt Monovent may be the solution to your ventilating problems. Write Burt—now—for further details.

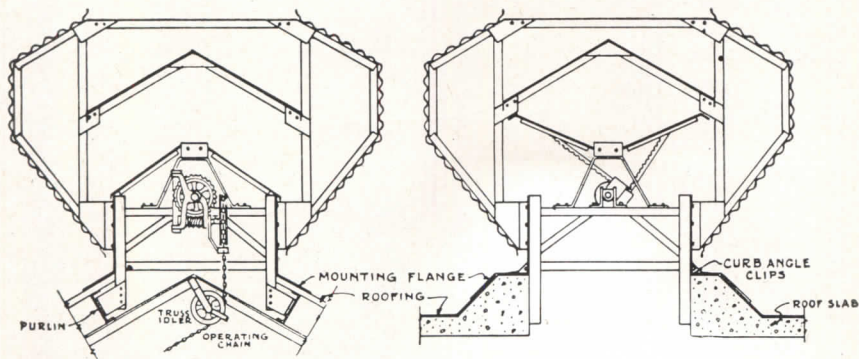

TYPICAL MOUNTING FOR PITCH ROOF. Showing Damper closed and Operator Control.

MOUNTING FOR CURB ROOF. Showing Damper open with Rack and Pinion Operators.

WRITE FOR CATALOGS AND DATA SHEETS

The **BURT MFG. Co.**

48 E. South Street

Akron 11, Ohio, U. S. A.

VENTILATORS • LOUVERS • OIL FILTERS AND SHEET METAL SPECIALTIES

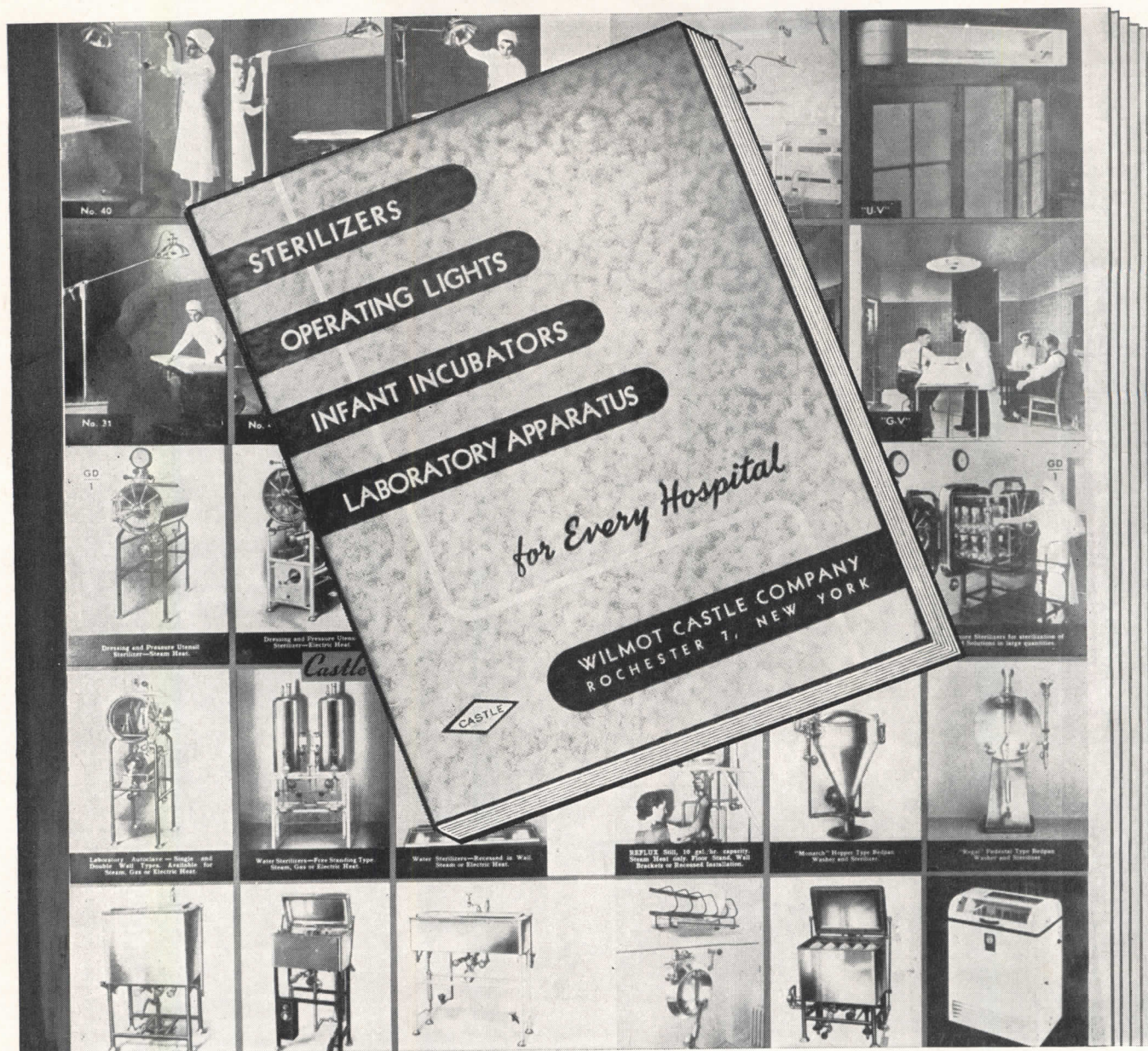

Hospital Architects . . . Send For This Sterilizer and Operating Light Catalog

This easy-to-use catalog gives you all the information you need when specifying hospital sterilizers, operating lights, infant incubators and laboratory apparatus.

Castle engineers are also ready to assist you on any specific problems. Their research and experience is yours for the asking . . . without any obligation, of course.

Since 1883 Castle has pioneered the important developments in hospital sterilization and surgical

lighting. Today the Castle trademark on any hospital unit is your guarantee of long-lived, satisfactory service.

Use the attached coupon for your free copy of the complete Castle Catalog. Wilmot Castle Co., 1258 University Ave., Rochester 7, N. Y.

Castle LIGHTS AND STERILIZERS

WILMOT CASTLE CO.
1258 University Ave.
Rochester 7, N. Y.

Please send me Hospital Architect's Catalog of Sterilizers and Operating Lights.

NAME _____
FIRM _____
ADDRESS _____
CITY _____ STATE _____

year, while heavy engineering volume was 17 per cent greater than in September and 47 per cent higher than in October, 1946, with the 10-month total up 12 per cent.

Various governmental agencies awarded contracts amounting to \$208,947,000 in the eastern states in October, to bring the cumulative total of contracts let for projects classified as publicly owned this year to \$1,865,363,000, which is 29 per cent of all construction contracts awarded.

WHAT THEY SAY . . .

About Housing

"In attempting to speed up construction of homes it should be understood that it is not possible to successfully divorce housing from the rest of the construction industry. Any attempt to make the building of houses a healthy, vigorous enterprise and, at the same time, neglect or cripple the rest of the industry by artificial restrictions cannot succeed.

— MAX H. FOLEY
Architect

"The government will have to make a choice as to whether it is going to encourage construction of the maximum number of homes for veterans or cut back the volume of home building by curtailing mortgage credit as part of an overall campaign to combat inflationary forces. . . . Home building reached an all-time peak several months ago and has continued at a rate approaching one million homes a year for several months. The spurt came almost immediately after the cumbersome emergency controls on residential construction were removed.

"In just four months after June 30, 1947, the number of new housing units started rose from 75,000 to 92,000 a month, a gain of 23 per cent. Obviously no action should be taken to reduce this high level of home building until alternative possibilities have been weighed carefully.

"Should the volume of private building be reduced, there is sure to be a renewed insistence on a large program of public housing to be financed by the government, and the building of additional homes at public expense would be just as inflationary as an equal amount of privately built housing."

— DOUGLAS WHITLOCK
Chairman, Building Products Institute

About Materials

"The coming year will see a further improvement in the supply of the vast majority of materials, and a continued building up of dealers' inventories. This forecast must be qualified, however, in view of the announcement that the Administration is seeking authority for allocation and control over the use of basic products. Even though housing or construction as a whole might receive favorable treatment in such a control system, the imposition of controls could seriously interfere with the progressive reestablishment of orderly markets.

"The degree of materials shortages next year also will partly depend upon ultimate decisions in respect to foreign aid. So far as building materials are concerned, the indirect impact of a foreign-aid program, accompanied by steel and freight car shortages, is likely to be more important than direct demands for building products . . .

"For 1948 we anticipate a smaller list of short products. Structural steel, reinforcing bars, sheet steel for warm
(Continued on page 132)

KITCHEN PLAN NO. 44:

Forty-fourth of a series of successful mass-feeding installations.

Smooth, easy traffic flow to general restaurants and banquet service characterizes this modernized kitchen in the Hotel Roanoke, Roanoke, Virginia.

KEEP FOR
HANDY
REFERENCE

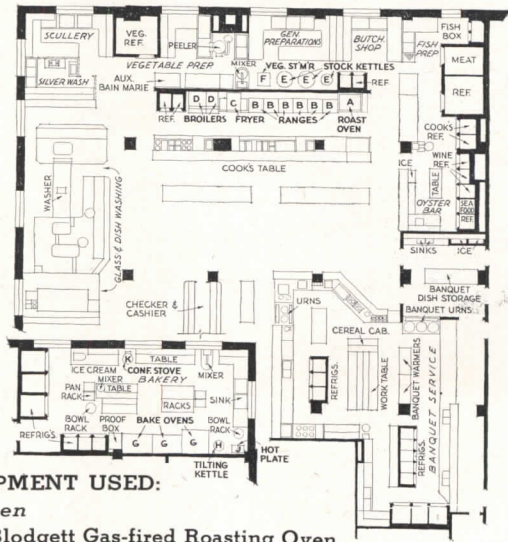

COOKING EQUIPMENT USED:

Main Kitchen

- (a) 1 No. 952 Blodgett Gas-fired Roasting Oven
- (b) 6 Gas-fired Ranges with 1 Salamander
- (c) 1 Gas-fired Deep Fat Fryer
- (d) 2 Broilers
- (e) 3 Stock Kettles
- (f) 1 Vegetable Steamer

Bakeshop

- (g) 2 No. 963 Blodgett Gas-fired Baking Ovens (and 1 existing oven)
- (h) 1 Trunnion Kettle
- (j) 2 Burner Gas-fired Hot Plate
- (k) 1 Gas-fired Bakers' Stove

Designed by John G. Kolbe, John G. Kolbe, Inc., Richmond, Virginia
Fabricated by The John Van Range Company, Cincinnati, Ohio

The Hotel Roanoke service ranges from typical coffee shop and counter feeding through a la carte and banquet service. One notably clever arrangement is that which eliminates entry of banquet waiters into the kitchen area. The 952 Blodgett Gas-fired Oven used in the roasting section has two separately controlled sections loading as much as 360 pounds. In the bakeshop (plan of which is superimposed on elevator and passageway area) two 3 section No. 963 Blodgett Gas-fired Baking Ovens totalling 12 pans capacity furnish the bakers extreme flexibility and ease of operation.



The G. S. BLODGETT CO., Inc.

50 Lakeside Avenue

Burlington, Vermont

Send for your copy of the new, deluxe "Case Histories of Successful Mass Feeding Operations" now!

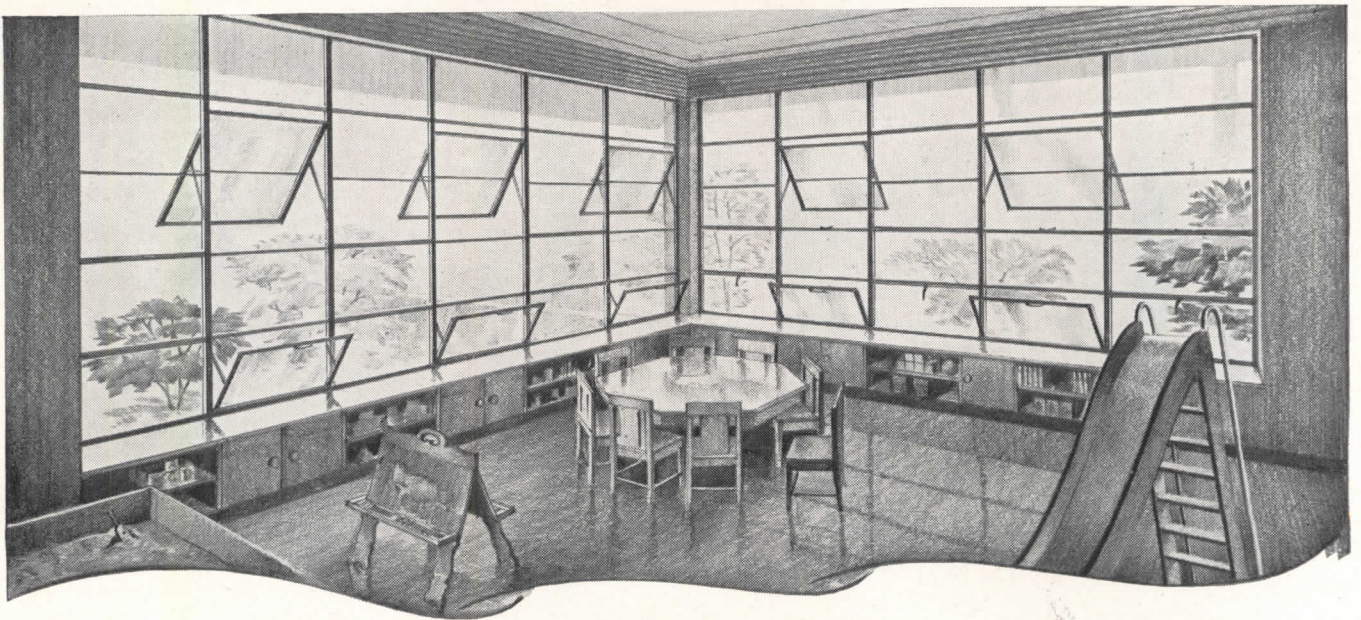

More Daylight— WITH BETTER VENTILATION AS A BONUS!

When you plan larger daylighting areas, why not take advantage of the opportunity the larger wall opening affords for better ventilation?

With Fencraft Projected Windows, large steel-strengthened areas of glass flood the room with daylight. All-weather ventilation is provided by two vents in each window unit. One opens out to form a canopy over the opening—to shed rain and snow. A sill vent opens in—deflecting incoming air upwards to prevent direct drafts. This vent likewise sheds rain and snow to the outside.

They're economical windows, too. Lower cost—in both manufacturing and installation—has been accomplished by standardization. Fencraft Window units conform with modular dimensions of modern construction practice. Yet the variety that is achieved in making these windows of standard sections enables you to have all the design flexibility you wish, without the cost of "specials". There's a great range of types and sizes—in Projected, Combination and Casement Windows. That means a *right* window for every use—designed right . . . made right. See your Sweet's Architectural File for full information. Or mail the coupon.

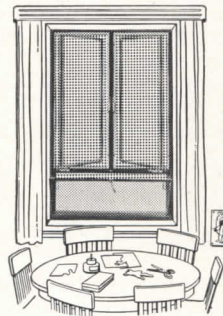

FENCRAFT COMBINATION WINDOW

Generous fresh-air ventilation. Swing leaves deflect breezes into the room. In-tilting sill vent protects against drafts. Both sides easily and safely washed from inside.

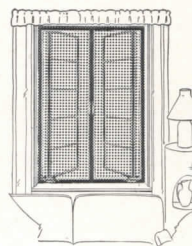

FENCRAFT CASEMENT WINDOW

Safe washing on outside, from inside. Easy to operate. Interchangeable inside screens, protected from outside dirt.

Fenestra

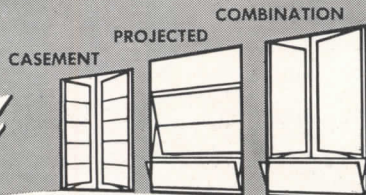

FENCRAFT INTERMEDIATE STEEL WINDOWS

Detroit Steel Products Company,
Dept. AR-1,
2252 East Grand Blvd.,
Detroit 11, Michigan

Please send me data on types and sizes of the new Fencraft family of Fenestra Windows:

Name _____

Company _____

Address _____

air furnaces, duct work, downspouts and gutters and nails will remain hard to get. Cast iron soil pipe may still be tight during the first few months of the year. The freight-car shortage will not be fully overcome during 1948, which means continuation of distribution problems even where output is adequate.

"Lumber including millwork and hardwood flooring promises to be in sufficient supply. . . . Inventories will improve though they will probably not

be up to normal standards."

— DAVID S. MILLER
President, The Producers' Council

"In 1947 the industrial economy of the United States was strengthened by the production of more than 84,000,000 tons of steel, a tonnage greater than ever made before in a peacetime year. . . .

"The supply of certain types of steel is still less than current abnormal demand despite the industry's prodigious

feat in 1947. The principal reason for continued inability to meet every demand for steel has been the loss of more than 18,000,000 tons since the end of the war as the result of strikes and work stoppages.

"Steel production in 1948 should equal or exceed the output of 1947. . . ."

— WALTER S. TOWER
President, American Iron and Steel Institute

NEW WELL-DRILLING LAWS IN NEW JERSEY

The attention of all contractors doing work in New Jersey has been called to new laws regulating the drilling of wells for water supply in that state. The laws were enacted because the water supplies of a number of communities was seriously threatened by encroaching salt water as the result of over-pumpage.

Chapter 375, Laws of 1947, is an Act which gives the Division of Water Policy and Supply, State Department of Conservation, the right "to delineate . . . areas . . . where diversion of sub-surface waters exceeds or threatens to exceed . . . the natural replenishment of such waters." Within such areas no one shall hereafter pump in excess of 100,000 gal. of water a day without first obtaining a permit from the Division.

The second act, Chapter 377, Laws of 1947, was designed to control the drilling of new wells through the licensing of well drillers, and it also makes it obligatory for the owner to secure a permit from the Division of Water Policy and Supply before commencing any new well. Copies of the new laws may be obtained from the Division of Water Policy and Supply, 28 W. State St., Trenton, N. J.

NEW A.S.A. SECRETARY

Vice-Admiral George Frederick Hussey, Jr., USN (Ret.), has been appointed secretary of the American Standards Assn. to succeed Dr. P. G. Agnew, secretary and head of the A.S.A. staff for the past 28 years. Dr. Agnew is remaining with the Association as consultant.

Admiral Hussey, a graduate of the Naval Academy, was Chief of the Bureau of Ordnance of the Navy Department from December, 1943, until his retirement on December 1. Admiral Hussey will be assisted in his A.S.A. duties by Cyril Ainsworth, for many years in charge of the technical activities of the Association, who has been appointed director of operations of the A.S.A. staff.

TOWN PLANNERS UNITE

Thirty-five consultants, architects and engineers engaged in one phase or another
(Continued on page 134)



FOR THE HOSPITALS
YOU DESIGN

1. STREAMLINED EFFICIENCY

Kewaunee's beautifully streamlined Casework, Cabinets and Laboratory Furniture give you increased convenience, resulting in time and money saved.

2. GRACEFUL EXPANSION

Each Kewaunee Unit is built to standard size, allowing the hospital laboratory to "grow gracefully." Kewaunee's "Cut-Cost" Plan of Unit Assembly gives, at no extra cost, full flexibility in the choice and combination of pieces.

3. KEWAUNEE QUALITY

42 years of experienced leadership, plus high-grade materials and workmanship, assure you finest quality in every unit. All working surfaces are of Kewaunee's patented KemROCK for defiant resistance to acids, alkalis, solvents, abrasion and shock.

Our Hospital Engineering Staff is available to Architects without cost or obligation. WRITE —

HOSPITAL DIVISION

Kewaunee Mfg. Co.

C. G. CAMPBELL, PRESIDENT

5046 S. Center St., Adrian, Michigan
Representatives in Principal Cities

ARCHITECTS

—will find Kewaunee Literature helpful in planning Hospital Laboratories. Write for Free copies.



ST. MARY'S HOSPITAL, KNOXVILLE, TENN.
 From the sketch by Barber & McMurry, architects,
 showing how the hospital appears with the new wing added.

PROFESSIONALLY PREFERRED . . .

Fabron

REG. U. S. PAT. OFF.

THE multiple function wall finish

Here is another case where architects and hospital authorities, discriminating in their tastes and opinions, selected FABRON for the finish of interior walls and ceilings of the new building they had planned. FABRON was thus included in the architect's original specifications.

To the architect, FABRON offers a finish that completes the structure and decorates the wall . . . that reinforces sub-surface materials . . . that serves as a wall-protective agent.

To hospital authorities, FABRON appeals because it can be easily cleaned . . . because it prevents plaster cracks . . .

because it affords years of uninterrupted service, eliminating periodic redecorations,—all of which result in operating economies.

Furthermore, FABRON colors are sunfast and are based on advanced ideas of color therapy. And FABRON prevents fire spread, thereby increasing fire safety.

FABRON fits well within the average appropriation. Its initial cost need not be higher than that of conventional good-quality decorative treatments on new walls. Its cost-to-use makes FABRON the most economical finish for walls and ceilings of all types of buildings.

Our Advisory Department will gladly cooperate with architects and their decorators in estimating costs, establishing color schemes, submitting samples etc. Cost free, of course.

FREDERIC BLANK & CO., INC.

Established 1913

230 PARK AVENUE, NEW YORK 17, N. Y.



Hospitals FREDERIC BLANK & Co., Inc. AR-1/48
 230 Park Ave., New York 17, N. Y.
 Hotels In reference to type of building checked please send further information about Fabron.
 Schools Name _____
 Theatres Address _____
 City _____ Zone _____ State _____

Offices
 Apartments
 Restaurants
 Residences



other of town planning in Canada already have joined the newly formed Institute of Professional Town Planners in Ontario. The Institute was formed "for the purpose of promoting the science and art of town and community planning and the knowledge of the members in the practice of the profession of town and community planning." Officers are: *president*, Tracy D. LeMay; *vice-president*, John Kitchen; *secretary-treasurer*, E. G. Faludi; *directors*, John

Layng, John van Nostrand and Gordon Culham. Headquarters of the Institute has been established at 24 Bloor St. E., Toronto 5, Canada.

INSTRUCTORS NEEDED

Additional instructors in Architectural Design and related courses are needed at the schools of architecture for the spring and fall semesters, reports Paul Weigel, chairman, Committee on Employment for the Association of

Collegiate Schools of Architecture. Requests for further information and applications for the teaching positions should be sent to Mr. Weigel at Kansas State College, Manhattan, Kansas.

COURSES PLANNED FOR GRADUATE ENGINEERS

Designed to aid the engineer just out of college and starting his professional career, a series of "universities" in key cities throughout the nation, staffed by practicing members of the profession, has been announced by The American Society of Mechanical Engineers.

The Engineers' Council for Professional Development is sponsor of the plan. Under its chairman, James W. Parker of Detroit, the pilot operation of the plan is already under way in Detroit, where the Council will work with the local engineering society and its affiliates to give courses, lectures and consultations to engineer graduates. Several other cities are initiating similar programs.

AT THE COLLEGES Fellowship Revived

For the first time since 1942 the James Harrison Steedman Memorial Fellowship Competition sponsored by the School of Architecture of Washington University is to be held in the spring of 1948.

Carrying an award of \$3000 for a year of travel and study abroad, the Steedman Fellowship is open to all graduates in architecture of accredited architectural schools of the United States. Candidates must be American citizens, between 21 and 31 years old, and must have had at least one year of practical work in the office of an architect, including one year's residence in St. Louis, Mo.

Requests for further information and for application blanks should be sent to the Chairman of the Department of Architecture of Washington University, St. Louis 5, Mo. Applications must be returned not later than January 31, 1948.

Public Lectures at Princeton

The Princeton University Bureau of Urban Research is sponsoring a series of public lectures called "Cities in Transition — The Causes and Consequences of Metropolitan Decentralization." Five in number, the lectures will be held in the auditorium of the Frick Chemical Laboratory at Princeton. The schedule is as follows:

March 2, 7:45 p.m. — "The Changing Pattern of the Modern City." Speaker, Philip M. Hauser, Assistant Director, Bureau of the Census (on leave), and Professor of Sociology, University of Chicago.

March 4, 4 p.m. — "Time, Space, and the City's Physical Readjustment." Speaker, Henry S. Churchill, Architect, City Planner, and member of firm of

(Continued on page 136)

THE ANSWERS TO ARCHITECTS' QUESTIONS ABOUT TILE

- Is it chip-proof? A big YES, also won't crack or peel.
- Is it waterproof and fireproof? Absolutely, also impervious to alkali and resists stain.
- Is it light in weight compared with other kinds of tile? Yes, light as a feather.
- Is there a low cost advantage over other tiles? Metal Tile costs about one-half that of other tile.

You won't go wrong investigating Hastings Aluminum Wall Tile, the amazing ceramic-like tile, so easy to apply—goes over dry smooth surface with mastic cement as base.

Available in 12 beautiful colors: Gleaming White, Cream, Peach, Dubonnet, Apple Green, Dark Green, Canary Yellow, Black, Light Blue, Dark Blue, Ivory and Flame Red—from which virtually unlimited color combinations are obtainable.

SIZES: Field Tiles, 5" x 5"; Trim Tile, Cap., 2½" x 5"; Stripe, ⅝" x 5"; Base 5" x 5". Also outside corners and wall plates for electrical outlets, available in matching colors.

For your closest distributor write our factory

METAL TILE PRODUCTS, INC.
HASTINGS, MICH.

HASTINGS ALUMINUM WALL TILE

Performance COUNTS



Here's a drawing combination that's hard to beat—GENERAL'S Kimberly (graphite) and Multichrome (colored) Drawing Pencils.

Try a few details or sketches with Kimberly—feel the smoothness of every stroke . . . notice the clarity of line and mass.

Then try Multichrome's 50 vibrant shades. Let the color flow. Make your rendering a symphony of blending tones . . . enjoy an unusual freedom of expression.

Draw with pencils correctly suited to every drawing purpose — buy Kimberly and Multichrome from your dealer today.

If not available, write to us — Dept. R.

Makers of Fine Pencils since 1889

GENERAL PENCIL COMPANY 67-73 FLEET STREET, JERSEY CITY 6, N. J.

KIMBERLY DRAWING PENCILS

22 degrees, 6B-9H, Tracing 1-2-3-4
and Extra B layout pencil

MULTICHROME COLORED DRAWING PENCILS

50 brilliant colors. Also in sets of
12-24-36-48 assorted colors to the box



Churchill-Fulmer Associates.

March 8, 4 p.m. — "The Economic Theory of Urban Expansion." Speaker, Homer Hoyt, Urban Real Estate Consultant, Economist, Lecturer, and member of firm of Homer Hoyt Associates.

March 10, 7:45 p.m. — "Governmental Problems of Urban Decentralization." Speaker, Austin J. Tobin, Executive Director, The Port of New York Authority.

March 11, 7:45 p.m. — "The Defense

of Cities in Aerial Warfare." Speaker, Ansley J. Coale, Assistant Professor of Economics, Princeton University.

A discussion period will follow each of the five lectures.

Building Forum and Clinic

The Department of Architecture of Pennsylvania State College has announced a Building Forum and Clinic to be held on the College's campus at State College, Pa., February 11-12. Speakers

and their subjects will include: W. H. Scheick, Coordinator, Small Homes Council, University of Illinois, "Housing Design Trends"; Prof. W. Coutu, Pennsylvania State College, "Sociological Aspects of Housing"; Tyler S. Rogers, past president, Producers' Council, and now with the Owens-Corning Fiber Glass Co., "Materials Development"; G. J. Lauter, Director, Associated General Contractors of America, "Architect-Contractor Relations." Because of limited accommodations, registration is open only to residents of Pennsylvania.

Appointment

Western Reserve University has announced the appointment of Hermann H. Field, A.I.A., as Director of Building Plans for Cleveland College. Mr. Field, formerly with Antonin Raymond and L. L. Rado, New York architects, will develop the requirements and overall plan for a new downtown college center in Cleveland, and will also participate in the work of the architectural faculty of Western Reserve School of Architecture.

OFFICE NOTES

Offices Opened, Reopened

Richard R. Hansen, Architect, has opened offices for the practice of architecture and community planning at 1201 E. 63rd St., Kansas City 5, Mo.

F. Albert Hunt, Architect, has opened an office for the practice of architecture at 4 Purdy Ave., Rye, N. Y.

Leon Hyzen, Architect, associated with Raymond Loewy Associates for the past five years as head of the Chicago office architectural and store planning division, has opened his own offices at 53 W. Burton Pl., Chicago 11, Ill., for consultation in architecture, store planning and industrial design. He plans to cooperate with outside firms in these various fields. During the war Mr. Hyzen served as site planner on the Bermuda Army Post, chief site planner of the Bainbridge Naval Training Station, and as assistant construction manager of the Dodge Chicago Plant.

George Nelson has opened an office for the practice of architecture and industrial design at 343 Lexington Ave., New York 16, N. Y.

Seichi Washizuka, Architect, formerly with the John B. Pierce Foundation, has reopened his office for the general practice of architecture at 16 1-chome, Shimbashi, Minato-ku, Tokyo, Japan.

New Addresses

The following new addresses have been announced:

Van Evera Bailey, A.I.A., 826 Brent Ave., S. Pasadena, Calif.

Carl W. Clark, A.I.A., 625 James St., Syracuse 3, N. Y.

(Continued on page 138)

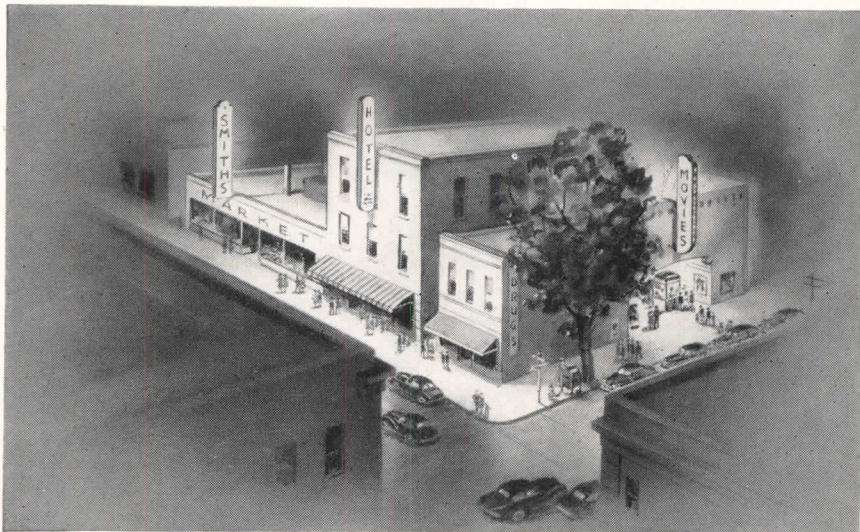

How much air at 4th and Main?

You can't afford gold-braided doormen for that store at 4th and Main. No luxurious "extras" of any kind.

And yet you know, from costly experience, that air conditioning for this store is a *must*. You know that next summer will be hot and sticky . . . that shopping is wearying work . . . and that women will give their patronage to stores and shops that are comfortably cooled.

So it isn't a question of *whether* you need comfort cooling at 4th and Main. The question is: How much can your store afford?

USAIRCO has the profitable, business building answer in its 3 great comfort cooling systems . . . each a pre-engineered

package unit . . . each available in a variety of sizes to meet any requirement.

Refrigerated Kooler-air delivers the ultimate in air conditioning . . . *Cold Water Kooler-air* is designed for those locations where 55° water is available . . . *Evaporative Kooler-air* gives washed and filtered air cooling at "pennies-a-day" costs. USAIRCO co-operating engineering counsel is available for correct installation.

Would you like to see exactly what these systems are and what each one can do for you? Write and we'll send you all the facts.

UNITED STATES AIR CONDITIONING CORP.
Como Ave. S. E. at 33rd, Minneapolis 14, Minn.

usAIRco

3 COMFORT COOLING SYSTEMS . . . AT 3 BUDGET LEVELS

Why leading architects repeatedly specify **Carrara Glass**

• Primarily, American architects prefer Carrara Structural Glass because it is a *quality* product. It is the only structural glass that is mechanically ground and polished in *all* colors and thicknesses. Its rich, perfect brilliance of surface adds charm and appeal to any installation.

Precision-made, Carrara Glass can be depended upon to be entirely free from warpage. And it assures joints that are true and even—without lippage.

Moreover, Carrara has exceptional sanitary properties. It is easy to clean. It is permanent. Offering a wide choice of thicknesses and decorative treatments, it is obtainable in ten attractive colors to complement or harmonize with any architectural scheme.

When you specify Carrara Glass—whether for toilet room walls and partitions, bathroom or kitchen walls, in lobbies, corridors, hospital operating rooms, laboratories—you are sure of getting structural glass at its best. We have a very interesting and informative booklet for you, entitled "Carrara, the Modern Structural Glass of Infinite Possibilities." It is fully illustrated. Why not fill in and return the coupon below for your free copy, now?

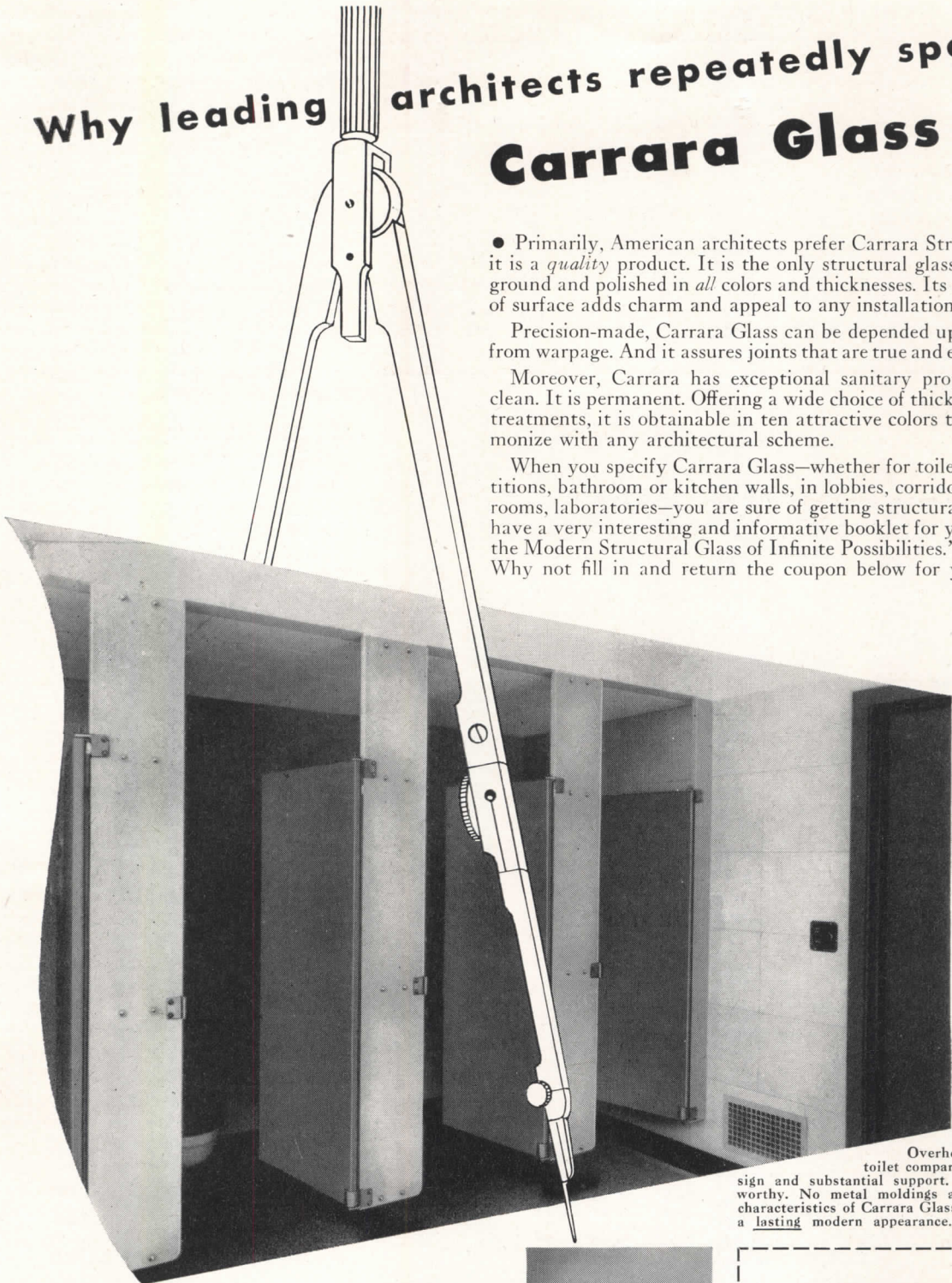

Overhead supported Carrara Glass toilet compartments offer a clean-cut design and substantial support. Ease of cleaning is noteworthy. No metal moldings are required. The inherent characteristics of Carrara Glass, plus good design, produce a lasting modern appearance. Architect: R. A. Spahn.

carrara
THE *Quality* STRUCTURAL GLASS

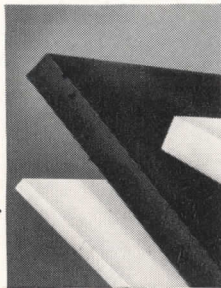

Pittsburgh Plate Glass Company
2071-8 Grant Building, Pittsburgh 19, Pa.

Please send me a FREE copy of your brochure, "Carrara, the Modern Structural Glass of Infinite Possibilities."

Name.....

Address.....

City..... State.....



PAINTS • GLASS • CHEMICALS • BRUSHES • PLASTICS

PITTSBURGH PLATE GLASS COMPANY

Clay Sewer Pipe Assn., Michigan Office, 610 Eddy Bldg., Saginaw, Mich.

Wilfred L. Keel, A.I.A., 843 Peachtree St., N.E., Atlanta, Ga.

George E. McDonald, A.I.A., 1715 Madison Rd., Cincinnati 6, Ohio.

Ralph P. Minich, A.I.A., 106 Pennsylvania Bldg., Wilmington 50, Del.

Clarence L. Peterson, Wendell R. Spackman, Architects, 45 Second St., San Francisco 5, Calif.

Russell & Axon, Consulting Engineers,

Merchants-Laclede Bldg., 408 Olive St., St. Louis 2, Mo.

Roy M. Schoenbrod and Associates, Architects and Engineers, 1253 N. LaSalle St., Chicago, Ill.

Firm Changes

Announcement has been made by G. J. Maguolo and G. E. Quick, partners in the firm of P. M. O'Meara Associates, that the name of their firm has been changed to Maguolo & Quick, Archi-

itects-Engineers. Specializing in ecclesiastical and institutional architecture and engineering, the firm maintains offices at: 4908 Delmar Bldg., St. Louis; 1004 Marquette Ave., Minneapolis; 1304 Macabee Bldg., Detroit; and 936 Temple Bar Bldg., Cincinnati. Associates are Samuel J. Farlow, A.E.; Ralph P. Ranft, Joseph I. Christie, Leon Zaitzevsky, Alfred Widman, Edwin F. Noth, and Laurens P. Cotter, all A.I.A.

Eliel Saarinen, F.A.I.A., and Eero Saarinen, A.I.A., have announced the formation of a new partnership for the practice of architecture under the name of Saarinen Saarinen and Associates, with offices at West Long Lake Rd., Bloomfield Hills, Mich.

ELECTIONS, APPOINTMENTS

James D. Edmunds, Jr., A.I.A., of Baltimore, has been elected chairman of the Construction Industry Advisory Council of the U.S. Chamber of Commerce. Mr. Edmunds is past president of the American Institute of Architects.

Clair W. Ditchy, of Detroit, has been elected secretary of The American Institute of Architects, by action of the Institute's Board of Directors. He succeeds Alexander C. Robinson, III, of Cleveland, who resigned because of the pressure of business. Mr. Ditchy, a practicing architect, formerly had been a member of the Board.

Henry Dreyfuss has been elected president of the Society of Industrial Designers for the 1947-48 year. Elected to serve with him were: Harold Van Doren, vice president; Egmont Arens, secretary; and Ray Patten, treasurer.

James William Gaynor, formerly associated with H. A. Hopf & Co., Consulting Management Engineers of New York, has been appointed Director of Management for the New York City Housing Authority.

CORRECTIONS

An inadvertent omission occurred in the article in the November issue (pp. 86-88) describing the duplex apartment scheme developed by Harvey Wiley Corbett and Charles H. Sacks, Architects, for multi-story maximum-economy housing. No mention was made of the fact that the scheme is patented (Patent No. 2,390,179, Dec. 4, 1945).

Letters received from Graham, Anderson, Probst & White, Architects, of Chicago, and Small, Smith & Reeb, Architects, of Cleveland, call attention to an erroneous credit in the advertisement of Frederic Blank & Co., Inc., on p. 169 of the November ARCHITECTURAL RECORD. Architects for the Cleveland Terminal group of buildings shown in the advertisement were Graham, Anderson, Probst & White. Small, Smith & Reeb were architects for various remodelings in the Hotel Cleveland, which is a part of the Terminal group.

CONTRAST OR BLEND

With the many smart colors available in Amtico Rubber Tile any decorative mood can be created. Whether a soft toned background or a sharply patterned feature, these marbled rubber tiles are a distinctive answer to your flooring problems. To the eye appeal of fine marble can be added carpet-like comfort underfoot. Footsteps are hushed by the resilient surface. Pleasant to stand or walk on, body-fatigue is reduced to a minimum. The plus values of easy maintenance and long life make the "Aristocrat of Floors" your first consideration for premium flooring. Send for your samples today!



Amtico
RUBBER
TILE

SEND FOR COLOR LITERATURE AND SAMPLES TO-DAY!

AMERICAN TILE & RUBBER CO.
TRENTON, N. J.



... the new Benjamin
LUMINOUS LOUVER CEILING SYSTEM

SKY-GLO is the answer to the Lighting Plan that calls for *Inconspicuous Lighting* with low brightness... *More Beauty* with greater seeing comfort! Designed expressly for offices, stores, show windows and other commercial locations, the new Benjamin development features...

NEW LUMINOUS VINYLITE LOUVERS

This new system of translucent louvers does more than reflect light... it actually glows with light to form a luminous ceiling of unique beauty and atmosphere. This new

Benjamin Sky-Glo System is the latest development in "louverall" lighting. With this system it becomes practical to provide...

100 TO 125 FOOTCANDLES
of uniform, diffused and comfortable lighting. Crosswise and lengthwise shielding of 45° eliminates glare and uncomfortable

brightness. The Sky-Glo System conceals pipes, ducts and fixtures and substitutes at reasonable cost a...

MODERN STREAMLINED CEILING
of low brightness with pleasing architectural and decorative patterns.

Write now for complete Data Bulletin on this new Benjamin development.

BENJAMIN ELECTRIC MFG. CO.
DEPT. Q-1, DES PLAINES 12, ILLINOIS

STANDARDIZED STOCK SECTIONS OF LOUVERS, CHANNELS and FITTINGS simplify the layout and installation of the new Benjamin Sky-Glo System. The four sizes of louver sections and the various channel lengths make possible geometric arrangements which provide wide flexibility of design for various ceilings. Louvers are made of Vinylite, a product of The Bakelite Corporation, which has a light transmission factor of approximately 71%. These sections are easily removed for lamp and fixture maintenance and for easy cleaning.

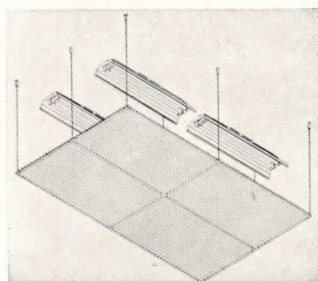

BENJAMIN
TRADE MARK
Lighting Equipment
Distributed Exclusively through Electrical Wholesalers

(Continued from page 118)

Site-assembled and pre-fabricated steel wall panels have 2-in. fill of Fiberglas; erection is by welding and interlocking panel edges

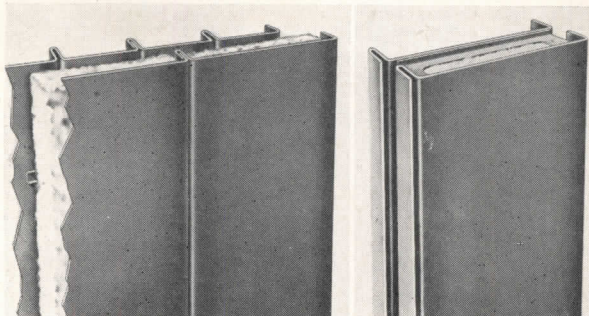

STEEL WALL PANELS

A new system of steel exterior wall panels is designed for rapid assembly and derives good insulating qualities from a 2-in. fill of Fiberglas. There are two types of walls: the sidewall type which is field fabricated from inside and outside wall plates, rolled from 18- and 20-gauge galvanized steel, stainless steel, or aluminum; and a prefab wall panel which is factory assembled from galvanized steel or stainless steel, with Fiberglas insulation already in place. The heat transmission of the former is quoted as the equivalent of a 28-in. solid masonry wall, and of the latter, an 18-in. wall. Erection at the site is by welding to main structural members, and by interlocking panel edges. The R. C. Mahon Co., Detroit 11, Mich.

ASSOCIATIONS

Certification Program

The American Gas Association has announced a certification program in the interests of scientific kitchen planning, automatic gas cooking, automatic gas refrigeration, and automatic gas water heating. Certificates will be issued to architects and builders by the Association upon recommendation of authorized persons in local gas utility companies, attesting that the specific installation is a *Certified Gas Kitchen*. American Gas Association, 420 Lexington Ave., New York 17, N. Y.

Maple Flooring

Now celebrating its 50th year of Association activities, the Maple Flooring Manufacturers Association has seen northern hard maple, beech, and birch timber progress from a "give-away" item to a standard flooring material, of which four billion feet were produced in five decades. The Association was formed to improve manufacturing procedures, and has instituted advancements in kiln drying on a scientific basis, added blocks and patterns to original strip flooring, intensified research in floor finish fields, and now supplies technical data on floor construction. Maple Flooring Manufacturers Assn., 332 S. Michigan Ave., Chicago 4, Ill.

Shingles and Shakes

The advantages of red cedar shingles and shakes will be publicized by a newly formed Stained Shingle and Shake Manufacturers Assn. While these products have long enjoyed popularity on the West Coast, particularly in the Northwest, their use is only now coming into prominence east of the Rockies. Such shingles and shakes are pre-stained and require no painting upon application. Permanent headquarters of the Association will be established in Seattle, Wash. President is Philip W. Bailey of West Coast Standard Shingle Co., Seattle.

(Continued on page 142)

IMPLEMENT OF ARCHITECTURE

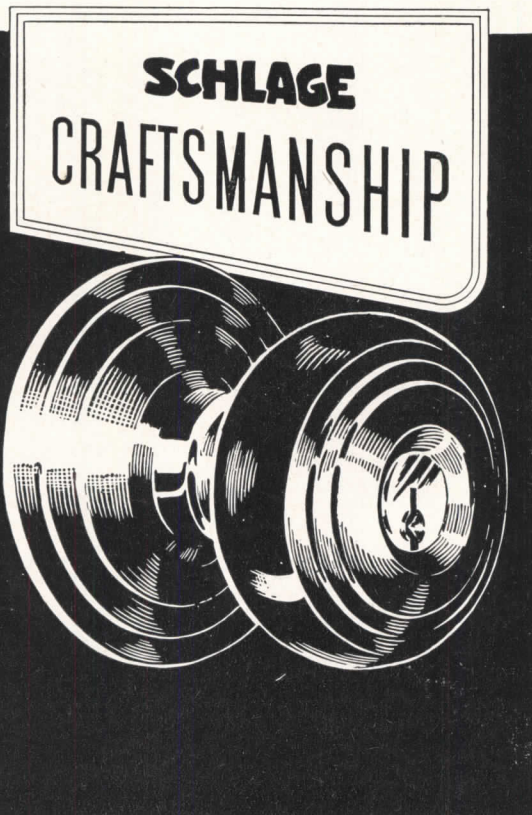

The skill of Schlage craftsmen is evident in every Schlage lock. Their experienced hands expertly guide precision machinery through exacting Schlage manufacturing processes. This ideal combination of modern machines and skilled craftsmen provides locks that give a long life of dependable operation.

SCHLAGE

LOCK COMPANY

SAN FRANCISCO • NEW YORK

ORIGINATORS OF THE CYLINDRICAL LOCK

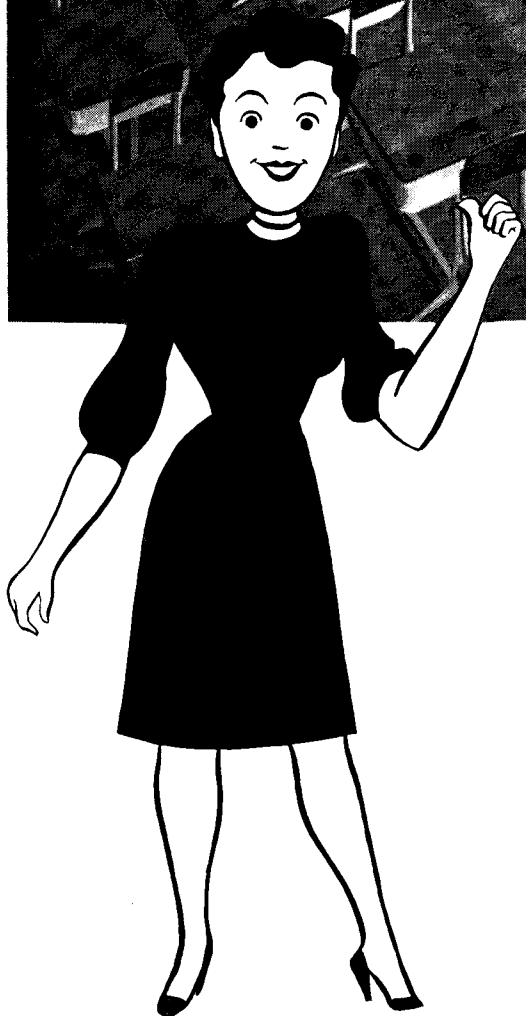

"GET THE IDEA, MR. ARCHITECT? . . .

"PLEASE, sir, when you design your next schoolhouse, will you keep this picture of The Nesbitt Classroom before you? The well known Nesbitt Syncretizer unit ventilator is available in a special square casing to match up with steel shelving and storage cabinets made by Nesbitt. This arrangement makes perfect use of the space along the windows. It provides not only for the comfort and health of the pupils, but for their convenience also: 'A place for everything, and everything in its place.' You have designed wonderful streamlined kitchens for homemakers and efficient work areas for office folk. Please remember that we teachers also do our best work under ideal working conditions. Most superintendents and school board members know Nesbitt equipment by experience or reputation, and they'll be glad for the inclusion of The Nesbitt Package in your plans.—Thank you, sir."

THE NESBITT

PACKAGE

THE NESBITT PACKAGE IS MADE BY JOHN J. NESBITT, INC., PHILADELPHIA 36, PA., AND SOLD BY NESBITTS AND AMERICAN BLOWER CORPORATION

(Continued from page 140)

FLUORESCENT FIXTURES

There is a 97-in. Slimline fixture in the *Linolite* line of fluorescent units; available with either two or four lamps. The fixture is $5\frac{1}{8}$ in. deep, and has glass side panels and an interchangeable hinged louver or glass door bottom. Also announced is a 49-in. waffle type fixture, with two, three, or four lamps, for ceiling or hanger mounting, single or in continuous runs. The Frink Corp., Long Island City, N. Y.

MINIMUM BATHROOM

For that extra bathroom in extremely limited space, a minimum size corner lavatory, small low bathtub, and toilet can be installed in a space as small as 5 ft. by 6 ft. Overall dimensions of the bathtub, with corner seat, are 42 in. by 31 in. In really cramped quarters, a bathroom with the same fixtures can be achieved in a space $3\frac{1}{2}$ ft. by $6\frac{1}{2}$ ft., by fitting the 42-in. bathtub between two walls and placing the corner lavatory in



Minimum size bathtub and corner lavatory

the corner diagonally opposite that shown in the photograph, or by using a small shower stall in place of the tub. Crane Co., 836 S. Michigan Ave., Chicago 5, Ill.

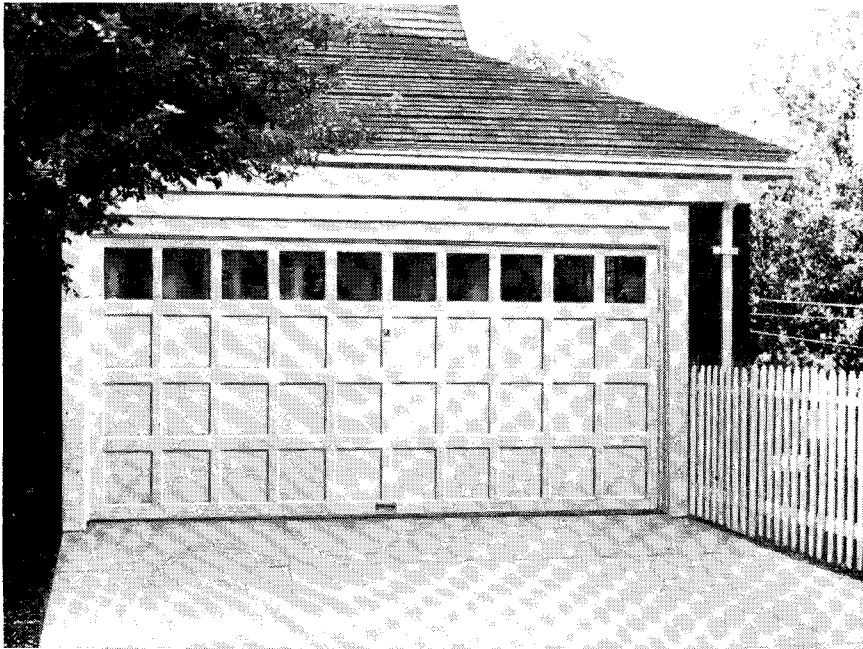

IT'S A GOOD IDEA TO USE D-O-U-B-L-E W-I-D-T-H Barcol OVERdoors FOR TWO-CAR GARAGES...

NO CENTER POST. When planning the doors for a two-car garage (either new construction or remodeling), a double-width Barcol OVERdoor offers several worthwhile advantages. The center post is eliminated, amount of door mechanism is reduced, and appearance is better, especially for long and low structures.

EASIER, SAFER DRIVING. With the center post gone, it is a lot more convenient to get cars in and out, particularly if a turn near the door is involved. Clearances are greater, and the chances of colliding with the door frame are reduced. With the present trend in auto design, this is a considerable help.

ELECTRIC OPERATOR. More and more, electric door operators are being used in residence garages. A double-width door offers a saving here, because only *one* operator is needed. It is not mandatory to use an electric operator with a double-width Barcol OVERdoor since tailored counterbalancing makes it easy to handle. For installations with electric operators, the Barcol Radio Control gives the final touch of convenience — control of the door *by radio* from the car! Write for information on all Barcol products, or ask your Barber-Colman representative for details.

SEE OUR
CATALOG
IN SWEET'S



FACTORY-TRAINED SALES and SERVICE REPRESENTATIVES in PRINCIPAL CITIES



BARBER-COLMAN COMPANY
102 MILL ST. • ROCKFORD, ILLINOIS

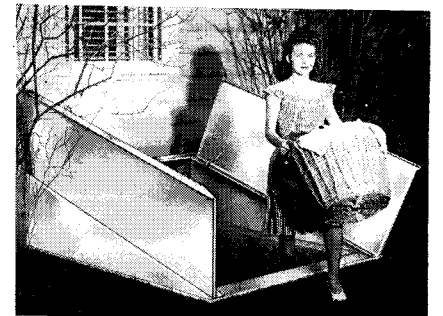

Packaged cellar bulkhead is aluminum

CELLAR DOORS

With basements becoming more and more a part of the living quarters of the house, cellar bulkheads provide easier and safer access to the outdoors. Now available as a packaged unit are *Bilco Celladoors*, constructed of copper-steel or aluminum bulkheads and doors. The aluminum models are designed for light weight and easy opening. Units are shipped knocked down in five parts with the necessary assembly bolts and can be constructed in less than an hour when provision is made to receive them, in either frame or masonry construction. There are six different design types, with three sizes in each type. The Bilco Co., 164 Hallock Ave., New Haven, Conn.

HEATING

Steel Boiler

The newly announced *Fitzgibbons 400 Series* of jacketed steel boilers operate on either gas, oil, or hand-fired or stoker-fed coal, for house heating. The boiler is said to be designed on the same principle as steamship and locomotive boilers; and features good combustion and powerful water circulation. No storage tank is required for year-round domestic hot water, which in winter is

(Continued on page 144)



This switch says plenty by keeping silent

Shhh! Here's silence that's really golden—for you. Quieter than the drop of a pin (you can hear *that*), yet the G-E Silent Switch's very lack of noise is one of the loudest-talking salesmen you can have on the job.

Think a minute. What builds your customers' confidence in you? It's your reputation and the quality of work you do, of course. But did you ever stop to consider how important, too, is the reputation and performance of the wiring you specify?

That's where G-E Silent Switches come in, and all the other products in the full line of G-E wiring devices. They are the *visible evidence of quality* on every job. Their name signifies long life and reliable service to every user. Why not specify General Electric throughout, and let that big name go to work for you?

WIRING DEVICES by
GENERAL  ELECTRIC
 say "G.E." and he'll agree

Wiring Briefs from your G-E Distributors

Are you familiar with the great variety of products in General Electric's full line of wiring devices? Do you know the interesting features that help to make them easy to use and safe to specify? Keep an eye on this column, and you may discover a lot of useful facts and information. We'll keep dishing them out for you.

Now, the entire Watch Dog* line of starters meets a new, high-temperature rating. Maximum recommended operating temperature has been increased from 140 F to 160 F. This is important in installations that are enclosed, or that are subject to high ambient temperatures.



Whether you already include fluorescent lighting in your plans, or just want more information for your files, you need this new folder on "G-E Fluorescent Accessories." It shows you—and your clients—what products G.E. is making, and how they can be used to advantage. Tells about Watch Dog* and standard starters; Slimline, Circline, and Twin Turret lampholders; and fluorescent starters and switches. Ask us for a supply today.

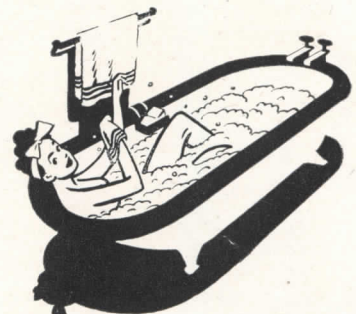

A certain well-known soap has nothing on those boys in G.E.'s "fuse factory." Do you know that the zinc used in General Electric fuse links has to be 99.98 per cent pure by laboratory test? Good point to remember when you specify fuses for that next job.

If you want additional information on these or other G-E Wiring Devices, ask us—your G.E. Merchandise Distributor—or write to Section D52-15, Appliance and Merchandise Dept., General Electric Co., Bridgeport 2, Conn.

*Trade-mark Reg. U.S. Pat. Off.

heated simultaneously with the house heating system and in summer by a reduced burner setting. Fitzgibbons Boiler Co., Inc., 101 Park Ave., New York 17, N. Y.

Warm Air

Coroaire forced warm air units feature a venturi tube heat exchanger which reportedly results in more efficient, larger heating capacity. Inside, the hot flue gases take a retarded course around

staggered tubes, thus preventing an excessive heat or stack loss. Units are available for gas or oil firing. The Coroaire Heater Corp., Cleveland 15, Ohio.

Oil-Burner

Designed for the small house, the Hoffman Controlled Heat furnace comes in two models, for basement or utility room. Both operate with a two-stage oil burner, thermostatically controlled; and have a stainless steel flame baffle

(Continued from page 142)

for increased heat transfer, and a tubular radiator for the recovery of extra heat from the hot flue gases. The warm air circulated from it is filtered. The basement model has a 75,000 Btu capacity; the utility room model, a 70,000 Btu capacity. Hoffman Specialty Co., Indianapolis, Ind.

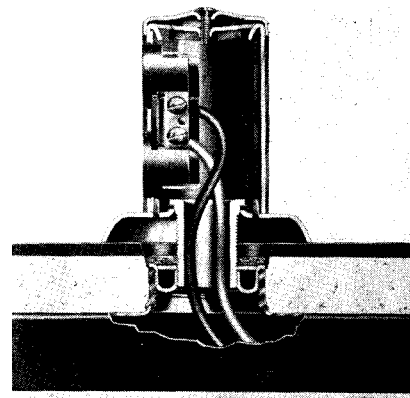

Improved outlet has standard threading

UNDERFLOOR DUCTS

The *Nepcoduct System* of simplified electrical floor outlets now has a 1½-in. standard pipe threaded outlet. This outlet has sufficient wall thickness to permit a standard pipe thread of sufficient length for good mechanical and grounded connection. The coarse threads permit desired tolerance with assurance against thread stripping. These features are particularly important for industrial installations of underfloor ducts where conduit nipples are used in a run to disconnect switches, or to machinery splice boxes. For telephone work or other specific applications, a 2¾-in. "T" type outlet can be supplied. National Electric Products Corp., Chamber of Commerce Bldg., Pittsburgh 19, Pa.

WIRED MOLDING

For increased convenience in locating electrical outlets, the *Wired Plugmold*, with outlets on 6-in. or 18-in. centers, can be installed around the room, above the baseboard or at any desired wall height. The molding is under 1 in. in width; lengths are 3 ft. and 6 ft. The Wiremold Co., Hartford 10, Conn.

DRAWING PERSPECTIVES

The *Perspectigraf* was designed by Lewellyn Price, Architect, as a mechanical means of drawing perspectives. The drawing kit consists of the following units: a Perspectiscale with four different scales, each with subdivisions in regularly diminishing perspective values; two templates or guides, with a total of four arcuate edges (Vanishing Arcs) which complement the four scales; a Perspectivedge or straightedge with an

(Continued on page 146)

WHY CORROSION CAN'T DESTROY this laboratory waste disposal system

DURIRON EXHAUST FAN

OVAL OR HEMISPHERICAL SINKS IN FUME HOODS OR LABORATORY TABLES

THE DURIRON CO., INC., DAYTON 1, OHIO
Branch Offices in Principal Cities

SINK STRAINERS IN LAB. SINKS

DURIRON CENTRIFUGAL DRUM TRAPS

DURIRON PIPE AND FITTINGS SIZES 1½" to 15"

The sinks, strainers, traps, pipe, fittings and fume exhaust fan in this chemical laboratory corrosive-waste disposal system are made of Duriron. The high silicon iron composition of Duriron gives it a wider range of corrosion-resistance than any other commercially available alloy. Duriron can be expected to outlast the building.

Some other cost-reducing advantages of this high silicon iron are: Uniform corrosion-resistance through entire wall thickness; no lining to chip, spall or crack . . . abrasion resistance . . . will not warp or sag from heat.

For complete details of Durco products for the chemical laboratory, write for new bulletins 703 and 1102.

DURIRON ACID PROOF DRAIN PIPE

What's this . .



. . delivering Roddiscraft doors from an Architect's office?

YES — delivery of Roddiscraft Flush Veneer Doors actually begins at your door. The pattern for delivery is laid down on the architect's board, because delivery largely depends on the specification of stock sizes by the architect.

Concentration on stock sizes permits us to get maximum production from men

and materials. It means more doors for everyone — On the other hand, odd sizes and special details are a serious brake on door output.

Plan for stock sizes when you draw your plans. Then we can plan to meet your needs with warehouse stocks ready for delivery when and where you want them.

NATIONWIDE Roddiscraft WAREHOUSE SERVICE

Cambridge 39, Mass. . . 229 Vassar St.
 Chicago 8, Ill. . . 1440 W. Cermak Rd.
 Cincinnati 2, Ohio. . . 457 E. Sixth St.
 Dallas 10, Texas. . . 2800 Medill St.
 Detroit, Mich. . . 11855 E. Jefferson Ave.
 Kansas City 8, Mo. . . 2729 Southwest Blvd.
 Louisville 10, Ky. . . 1201-5 S. 15th St.

Long Island City, N. Y.,
 Review & Greenpoint Ave.
 Los Angeles 11, Calif., . . . 2860 E. 54th St.
 Marshfield, Wis. . . 115 S. Palmetto St.
 Milwaukee 8, Wis. . . 4601 W. State St.
 New York City, N. Y., . . . 920 E. 149th St.
 San Antonio, Texas. . . 727 N. Cherry St.

DEALERS IN ALL PRINCIPAL CITIES

Roddiscraft

Roddis Lumber & Veneer Co.

MARSHFIELD, WISCONSIN

**Hospital Saves on
Cost of Heating**



Delaware Hospital, Wilmington, Delaware. Heated by 6-zone Webster Moderator System of Steam Heating. Completed in 1942. Unit No. 1, center, occupied in 1940. Architects: Massena & duPont, Wilmington. Consulting Engineers Jaros, Baum & Bolles, New York. General Contractor: Turner Construction Co., Philadelphia. Heating Contractor: Benjamin F. Shaw Co., Wilmington.

When a hospital spends in the neighborhood of \$30,000 annually for fuel oil, that's big business. It calls for a "controllable" steam heating system and careful heating plant operation to effect maximum economies.

The outstanding heating record of the new Delaware Hospital is based on a "Controlled-by-the-Weather" Webster Moderator System of Steam Heating, designed by Jaros, Baum & Bolles, New York Consulting Engineers.

At the time fuel-rationing went into effect it was estimated that 620,000 gallons of fuel oil would be required . . . a fuel rationing board allotted 500,000 gallons for all purposes — heating, sterilizers, laundry, kitchen equipment.

Records show that the Hospital did not require a supplementary ration. This splendid performance was obtained by a combination of a soundly designed Webster Moderator System, a craftsmanlike installation by Heating Contractor Benjamin F. Shaw and skilled operation under Chief Engineer Carl A. Baehr.

Let Webster experience help you in your heating system management problems.

WARREN WEBSTER & CO., Camden, N. J. Representatives in principal U. S. Cities : : Est. 1888
In Canada: Darling Brothers, Limited, Montreal

**WEBSTER
MODERATOR
SYSTEM
OF STEAM HEATING**

"Controlled by the weather"

(Continued from page 144)

especially patterned head that guides upon the Vanishing Arc; and the Bas-edge which acts as a guide for drawing vertical lines. Letterite Company, Fort Washington, Pa.

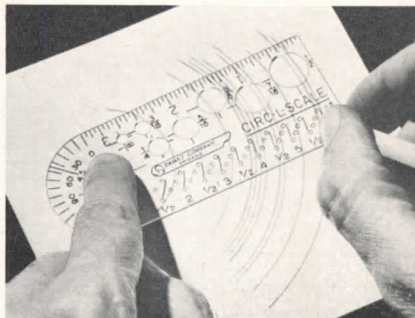

Vest-pocket guide for drawing curves

DRAWING AID

A small vest-pocket template of Vinylite plastic, known as the *Circ-L-Scale*, serves as a mechanical drawing tool. On one side is a rule, graduated into $\frac{1}{16}$ -in. calibrations. A pivot button and a series of holes for the pencil point permit the drawing of circles from $\frac{3}{8}$ to 6 in. diam.; and cut-outs serve as a guide for circles of smaller diameter. Danat Co., 315 West Van Buren St., Chicago 7, Ill.

WALL PAINT

Rubber-base paint, originally developed as an alkali-proof and chemical-resistant coating for concrete, is now being produced in a special form for painting interior walls. Known as *Paratex Wall Coating*, this self-sealing paint reportedly can be applied equally well to painted or unpainted walls of wallboard, brick, concrete, rough or smooth plaster, over oil-resin-emulsion paints, and even over wallpaper. No priming coat is required. It gives a soft non-gloss finish. Truscon Laboratories, Detroit, Mich.

STAIR NOSING

A non-slip abrasive is incorporated in *Tuff-Tred Safety Stair Nosings*, which contain no ridges to cause possible tripping. They can be installed with all types of resilient floor coverings, rabbeted into wood floors, or placed in concrete or terrazzo stairs. There is a choice of square edge and round edge designs, with treads in different colors. Goodloe E. Moore Co., Danville, Ill.

STAGING BRACKETS

Two new types of steel staging brackets for roofs have been introduced: one is flat, pierced with three holes for holding to the roof and also pierced for attaching

(Continued on page 148)

**HOSPITALS NEED
MODERN STEAM HEAT**



CENTRAL MICHIGAN COMMUNITY HOSPITAL Mt. Pleasant, Michigan. J. Walter Leonard, Chairman, Hospital Board. Built 1942. Architect: James Gamble Rogers, Inc., New York. Consulting Engineer: Jaros, Baum & Bolles, New York. Heating Contractor: A. W. Eurich, Bay City, Michigan.

Modern Steam Heating is almost a synonym for the Webster Moderator System of Steam Heating. In the Central Michigan Community Hospital, illustrated, the Webster Moderator System is proving its worth in a *small* hospital building. In the Delaware Hospital, Wilmington, Del., and in the U. S. Navy's tremendous Bethesda, Md., installation, Moderator Systems are proving their desirability in larger hospitals.

The Moderator System gives the Central Michigan Community Hospital:

- (1) Quick heat everywhere in proportion to need.
- (2) No override. When sun streams in, a turn of the wrist shuts off steam. No stored heat to run the temperature up, to tempt excessive window openings.
- (3) Automatic control-by-the-weather through an outdoor thermostat.
- (4) Low radiator temperatures in mild weather due to the jet orifice mixture of steam and air in each radiator or convector.
- (5) A simple system whose mechanical and electrical elements are easy to maintain.

When discussing heating of a new hospital or revamping of an old heating plant, the nearest Webster representative is ready to work with you. He is experienced and interested in helping owner, architect, engineer and installing contractor.

WARREN WEBSTER & CO., Camden, N. J. Representatives in principal U. S. Cities : : Est. 1888
In Canada, Darling Brothers, Limited, Montreal

**WEBSTER
MODERATOR
SYSTEM
OF STEAM HEATING**

"Controlled by the weather"

WHEN PLANNING HOSPITAL MATERNITY DEPARTMENTS

**...Get SCANLAN-MORRIS
Technical Information
and Layout Assistance**

• Competent planning for the practice of strict techniques of asepsis in maternity departments (as well as surgeries) calls for comprehensive knowledge of hospital requirements and equipment.

As designers and manufacturers, for more than 40 years, of major hospital equipment including sterilizers, surgical lights and tables, and recessed custom-built metal cabinets, Scanlan-Morris is qualified to give valuable assistance and authentic guidance in hospital planning installation of suitable equipment.

Our Technical Sales Service Department will be glad to supply specific information, suggested layouts, and recommendations for efficient, economical installations. This service is available to hospital architects, without obligation. Mail the coupon for detailed information.

- EQUIPMENT SCHEDULE
- RECESSED PRESSURE STERILIZERS
 - RECESSED WATER STERILIZERS
 - RECESSED BEDPAN STERILIZERS
 - RECESSED CABINETS
 - NURSING BOTTLE STERILIZERS

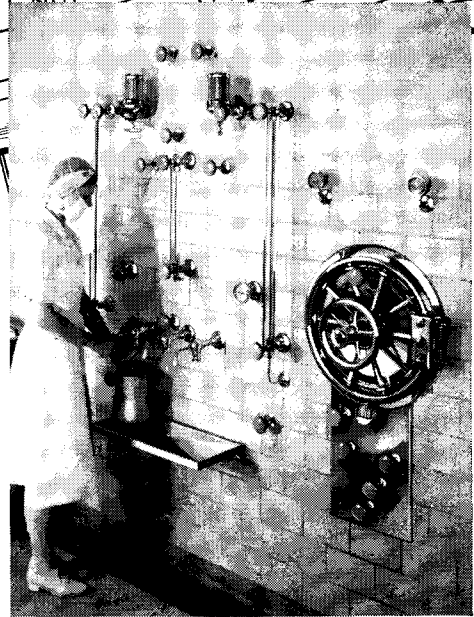

SCANLAN-MORRIS
Recessed Water Sterilizers and Autoclave

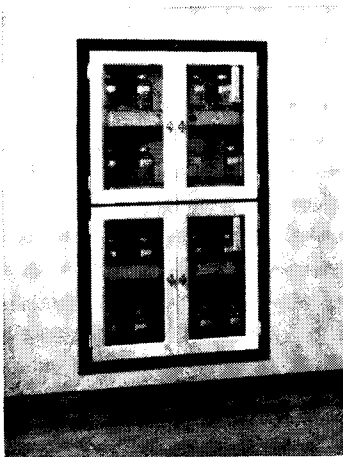

SCANLAN-MORRIS
Recessed Solution Warming Cabinet

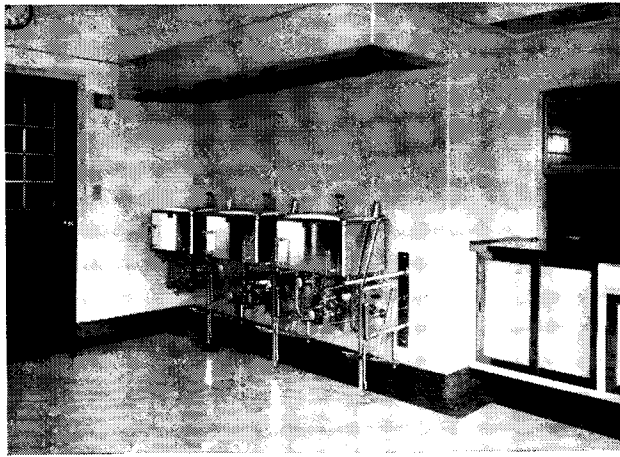

SCANLAN-MORRIS
Nursing Bottle Sterilizers

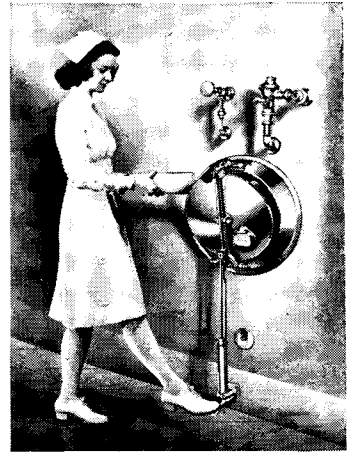

SCANLAN-ORBIT
Bedpan Washer-Sterilizer

Ohio Chemical

MANUFACTURERS OF MEDICAL APPARATUS,
GASES AND SUPPLIES FOR THE PROFESSION,
HOSPITALS AND RESEARCH LABORATORIES



THE OHIO CHEMICAL & MFG. CO.

1400 East Washington Ave., Madison 3, Wisconsin

Represented in Canada by Oxygen Company of Canada, Limited, Toronto and Montreal and
Internationally by Airco Export Corporation, 33 West 42nd Street, New York

BRANCH OFFICES IN PRINCIPAL CITIES

THE OHIO CHEMICAL & MFG. CO.

1400 E. Washington Ave., Madison 3, Wis.

Send information on Scanlan-Morris Sterilizers

Scanlan-Orbit Bedpan Apparatus.

(Please attach professional card or letterhead)

Name

Address

City State AR

(Continued from page 146)

a triangular piece of 2-by-4 lumber to form a platform rest; the other is pierced for holding to the roof, but bent to hold a 2-by-4 stringer. Special Devices, Inc., Berlin, Conn.

PLYWOOD PANELING

Weldwood is a new type of plywood paneling, consisting of 16 in. wide panels of birch wood with grooved edges that give an overlapping effect. The plywood face is prefinished in the factory. U. S. Plywood Corp., 55 W. 44th St., New York 18, N. Y.

PLUMBING FIXTURES

The *Feather-Touch* line of plumbing fixtures features streamlined appearance through the elimination of metal valve seats, washers, and ordinary packing, which are replaced with "O" rings. This construction is said to give "easy touch" opening and closing, long operating life, and simplified replacement. H. B. Salter Manufacturing Co., 10 Main St., Marysville, Ohio.

STANDARDS

Prefabricated Houses

A new commercial standard, CS125-47, "Prefabricated Homes (Second Edition)," has been adopted, effective for new production from Nov. 25, 1947. The standard sets forth minimum requirements for such houses, covering light and ventilation, space access and privacy, structural strength, insulation, condensation control, heating, plumbing, and wiring; also, materials and workmanship, site erection, and assembly of prefabricated units. National Bureau of Standards, U. S. Dept. of Commerce, Washington 25, D. C.

STANDARDS

Asphalt Tile

A new standard, "Simplified Practice Recommendation, R225-47, Asphalt Tile," has been published by the Department of Commerce, and represents a voluntary recommendation of the trade. It covers color groups and dimensions for both asphalt tile and asphalt cove base. Superintendent of Documents, Washington 25, D. C. 5 cents.

Pipe Fittings

Printed copies of "Simplified Practice Recommendation, R185-47, Pipe Fittings," are now available. The recommendation applies to gray cast iron, malleable iron, and brass or bronze fittings. A comprehensive group of fittings for sprinkler fittings is included, in addition to the regular line for other purposes. Superintendent of Documents, Washington 25, D. C. 10 cents.



of Door Costs

Quick, easy, push-button control featured by Kinnear Motor Operated Rolling Doors gives you a tighter grip on *all* door costs. It helps cut heating and air-conditioning costs through prompt, rapid closing of doors. It saves time and steps (you can have any needed number of additional controls at remote points). It avoids traffic bottlenecks at doorways, and along with these operating advantages, you get the extra durability, protection and space-saving efficiency of these rugged, all-steel doors with their world-famous coiling upward action.

with MOTOR OPERATED

KINNEAR DOORS

Built any size, for installation in old or new buildings. Write today for complete information.

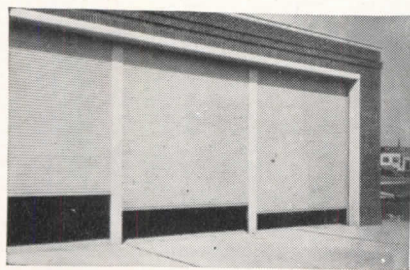

The **KINNEAR MFG. COMPANY**
FACTORIES

1860-80 Fields Ave. • Columbus 16, Ohio
1742 Yosemite Ave. • San Francisco 24, Calif.
Offices and Agents in Principal Cities



**Costly wall sweating
this inexpensive way**

• Bird Neponset Black Vapor Barrier applied on the warm side of insulation prevents "in-wall" moisture damage—it repels vapor, keeps insulation at peak efficiency and stops other condensation evils.

Bird Neponset Black Vapor Barrier costs only about \$20.00 to protect a \$10,000 house. Consult Sweet's Architectural File, 9b-2. For sample write Bird & Son, inc., 180 Washington Street, East Walpole, Mass.



Specifications — Roll width: 36"; square feet: 500; approximate weight: 50 lbs. Asphalt saturated. Coated both sides with glossy asphalt surface. Meets Federal Specifications UU-P-536 Grade B.

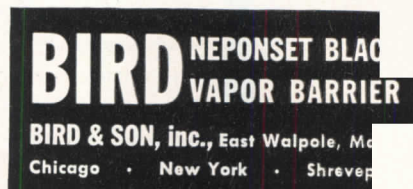

New... Improvements in PRECISE SURGICAL

LIGHTING...PRODUCED BY HOLOPHANE RESEARCH

In the field of surgery, precision lighting is of crucial importance. Holophane engineering has provided outstanding improvements in this specialized illumination. Consider the features that distinguish new Holophane surgical lighting systems from all others:

EFFICIENT . . . Scientific grouping of enclosed multi-lens optics assures maintenance of intense illumination—without sacrifice of correct brightness throughout the entire field of view.

SAFE . . . Location of lighting systems remote from anaesthetization zone eliminates hazards of explosion; multiple lamping avoids danger of interruption from lamp burnouts.

ASEPTIC . . . Permanently flushed into tight ceiling enclosures. No moving parts to dislodge dust.

MODERN . . . Direction and pattern of light are pre-set—can be changed, without distracting surgeon, by remote wall switches.

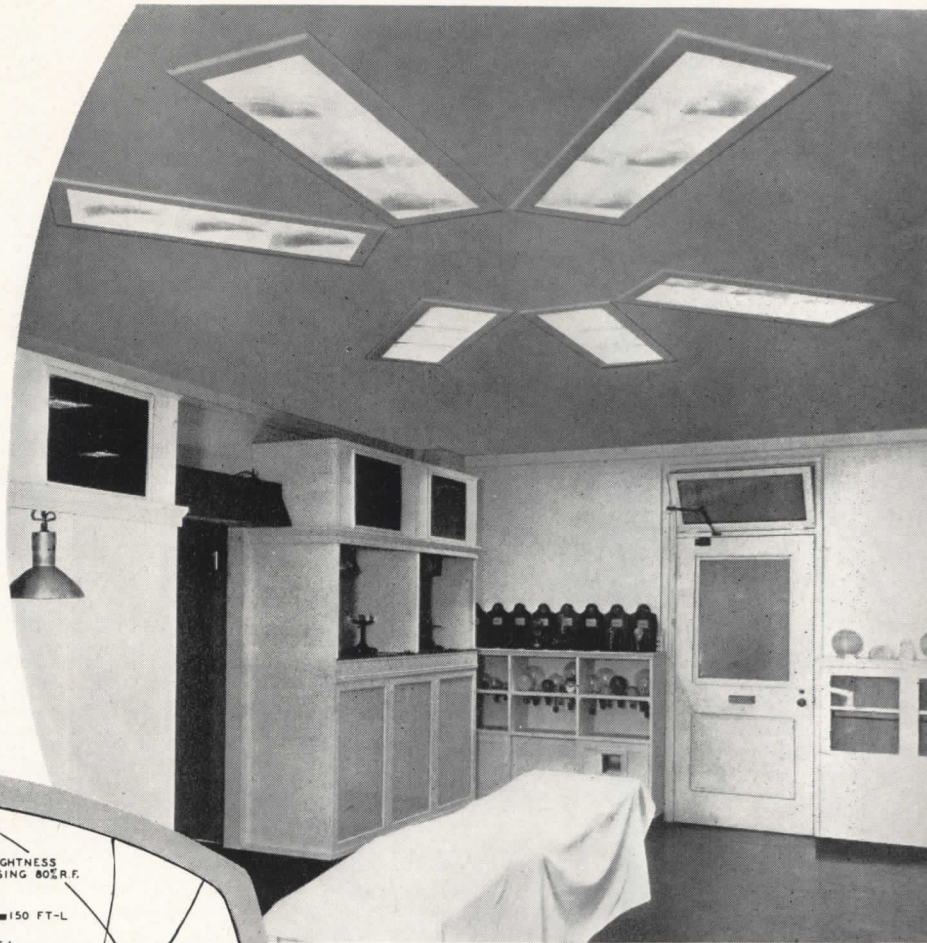

Demonstration Installation in the Holophane Light and Vision Institute

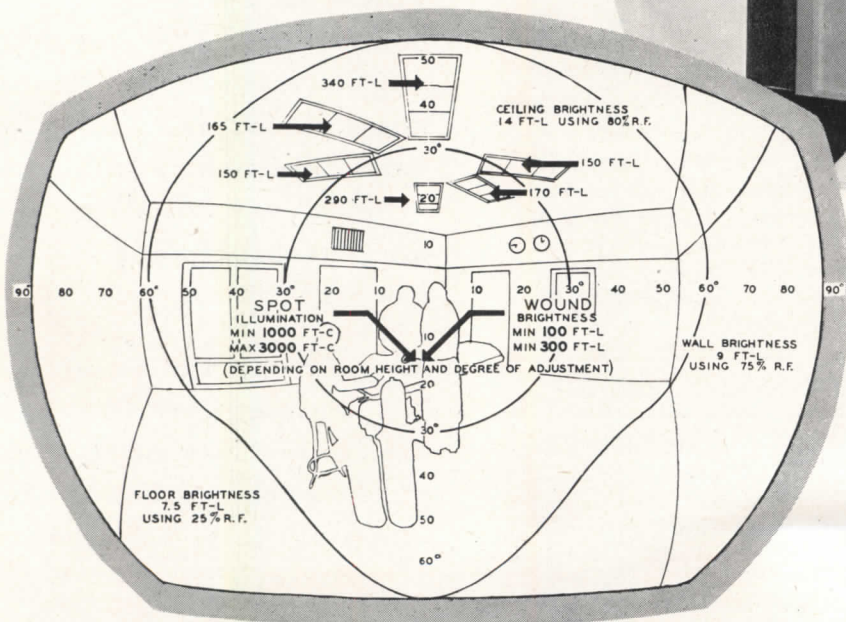

ILLUMINEERING PERSPECTIVE OF A SURGERY
LIGHTED BY 6 HOLOPHANE F-1715-3

VISUAL COMFORT—Diagram at left shows that brightness contrasts throughout the operating room are extremely low. The lenses that could conceivably cross the surgeon's glance are only $1\frac{1}{2}$ times brighter than the minimum wound brightness; are less bright than the maximum wound brightness.

THERMAL COMFORT—No matter what the surgeon's position, lights that his body blocks can be switched off to reduce temperature rise on surgeon's back—important in lengthy operations. In addition, the use of heat-absorbing lenses accomplishes two purposes: reduces the direct infra-red transmission (heat waves) and corrects the light color toward true white.

Write for engineering data on Holophane's "New Surgical Lighting Systems" including special installations.

HOLOPHANE COMPANY, Inc.

Lighting Authorities Since 1898 • 342 MADISON AVENUE, NEW YORK 17, N. Y.
THE HOLOPHANE COMPANY, LTD., THE QUEENSWAY, TORONTO 14, ONTARIO



(Continued from page 119)

in 115-volt models run from 600 to 10,000 watts and in 230-volt models, from 3500 to 10,000 watts. Battery charging plants are also described. 16 pp., illus. Advertising Dept., D. W. Onan & Sons, Inc., Minneapolis 5, Minn.

VOLTAGE CONTROL

Superior Voltage Control. Engineering data book on Powerstat variable transformers and Stabiline automatic voltage regulators; complete with ratings, detail drawings, photographs, and performance and engineering data. 12 pp., illus. The Superior Electric Co., 266 Church St., Bristol, Conn.

PAGING SERVICE

The Great Time Saver: Autocall Paging Service. Brief presentation in words and pictures of advantages of industrial paging systems that operate chimes and gongs located strategically throughout the plant, store, or office. 12 pp., illus. The Autocall Co., 4713 Tucker Ave., Shelby, Ohio.

VALVES AND FITTINGS

(1) "Electroflo" Valve; (2) "Measurflo" Control; (3) "Straifflo" Strainer. Three new fittings for installation on service lines. The valve operates electrically. The strainer and control offer a means of maintaining a clean uninterrupted flow, at a predetermined rate. Each 4 pp., illus. Hays Mfg. Co., Erie, Pa.

Jenkins Bronze Gate Valves. Folder introducing a bronze gate valve with Monel seat rings, designed for 200-lb. service where conditions are chemically severe; also a description of other available types. 2 pp., illus. Jenkins Bros., 80 White St., New York 12, N. Y.

LITERATURE REQUESTED

The following individuals and firms request manufacturers' literature:

E. A. Hamilton, Hamilton-Daugherty, Inc., Builders (Medical Construction), 410 S. Beverly Dr., Beverly Hills, Calif.

Home Owners Cooperative, Inc., R. D. No. 1, Camillus, N. Y.

John C. Kerr, Architect, 513½ Broadway, Room 218, Plainview, Texas.

C. H. MacMahon, Jr., A.I.A., 18330 Kelly Rd., Detroit 24, Mich.

George E. McDonald, Architect, 1715 Madison Rd., Cincinnati 6, Ohio.

Roy M. Schoenbrod & Assoc., Architects & Engineers, 1253 N. LaSalle St., Chicago, Ill.

Louis A. Warner, Student, Yale University, Graduate School, New Haven, Conn.

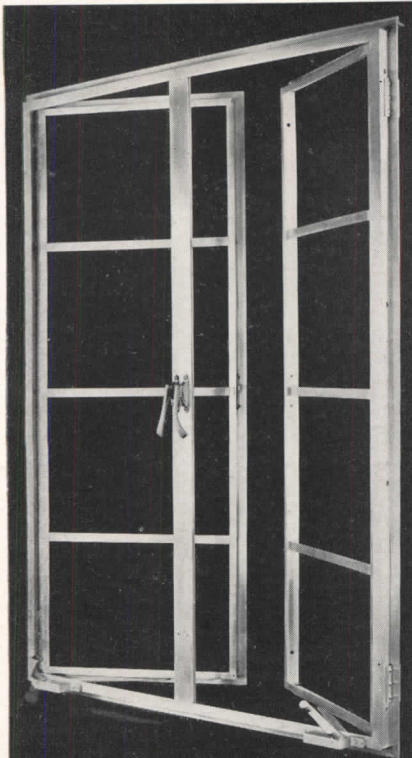

casement type

**ware
aluminum
windows.**

heavier sections • light weight
yet rigid • storm tight • easily
operated • need no painting.

write for catalog and prices

ware laboratories, inc.

3700 n. w. 25th St., miami 35, fla.

general sales office

21 west street, new york 6, n. y.

telephone: whitehall 3-6860



awning type

The
RESTORATION
of
**COLONIAL
WILLIAMSBURG**

*A Reprint
of the December, 1935*

Issue of

ARCHITECTURAL RECORD

104 pages, bound in cloth

\$2.00 per copy



The Colonial Williamsburg Number of ARCHITECTURAL RECORD—issue of December 1935—was sold out soon after publication but the entire editorial contents have been reprinted and bound in permanent book form with blue cloth covers.

Many thousands of these Williamsburg reprints have been sold but the demand continues unabated.

.....

ARCHITECTURAL RECORD
119 W. 40th Street, New York, N. Y.

Enclosed is \$..... for which send..... copies of your reprint, *The Restoration of Colonial Williamsburg*, bound in cloth, at \$2.00 per copy. (Add 2% Sales Tax for New York City deliveries.)

Name

Address

City and State.....A.R. 1-48

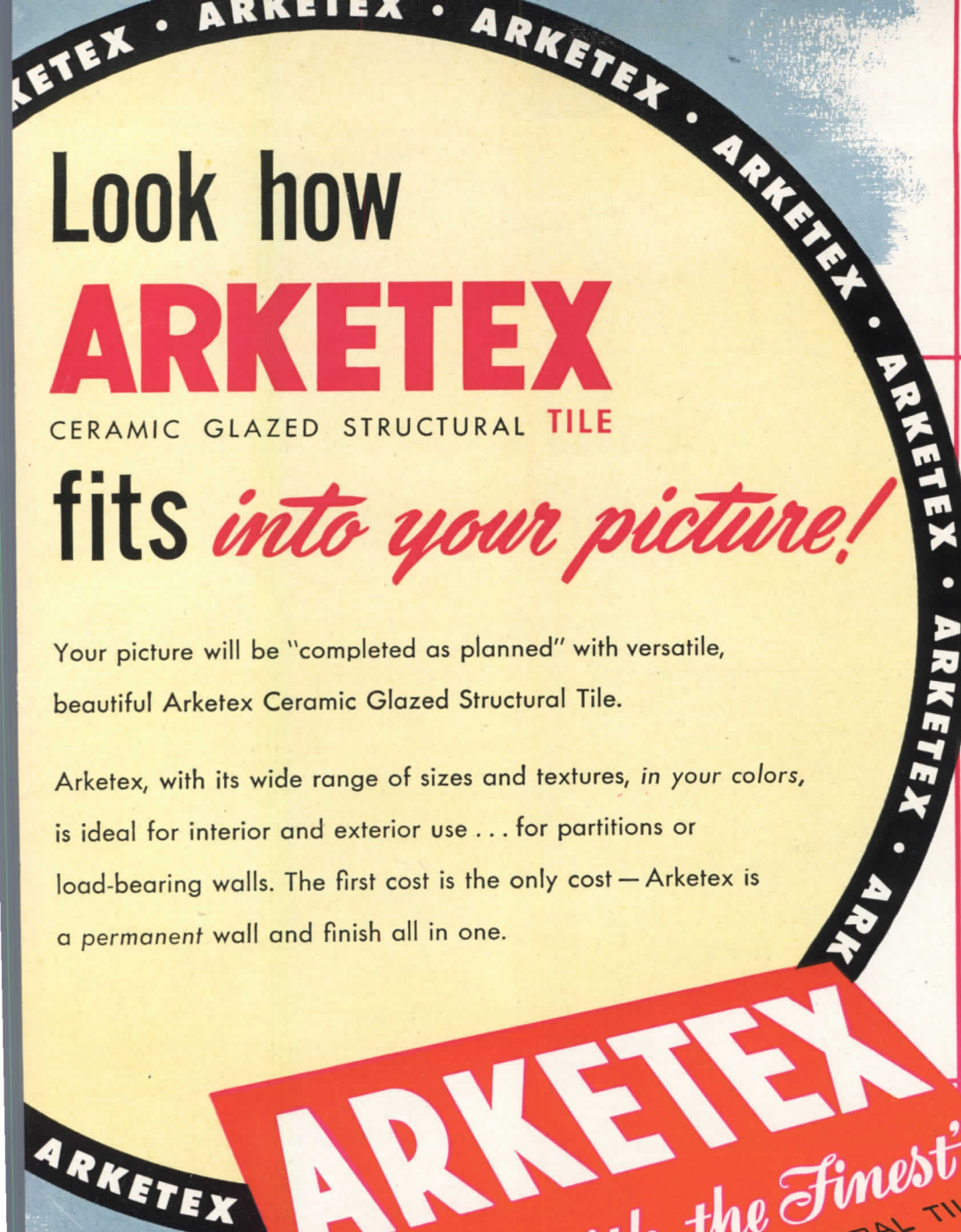

Look how

ARKETEX

CERAMIC GLAZED STRUCTURAL TILE

fits *into your picture!*

Your picture will be "completed as planned" with versatile, beautiful Arketex Ceramic Glazed Structural Tile.

Arketex, with its wide range of sizes and textures, in your colors, is ideal for interior and exterior use . . . for partitions or load-bearing walls. The first cost is the only cost — Arketex is a permanent wall and finish all in one.

ARKETEX
"First with the Finest"
CERAMIC GLAZED STRUCTURAL TILE

ARKETEX CERAMIC CORPORATION • Brazil, Indiana

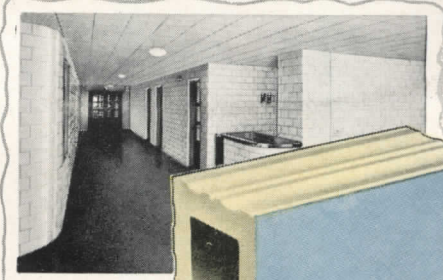

For Immaculate Locker Plants

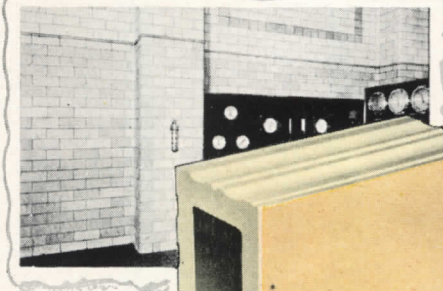
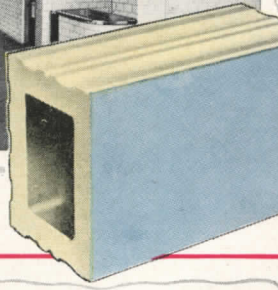

For Modern Power Plants

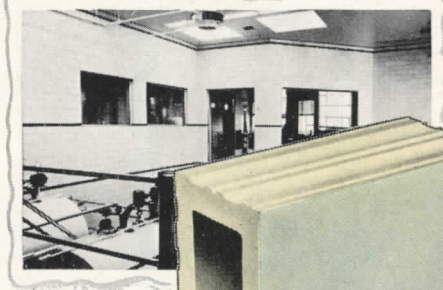
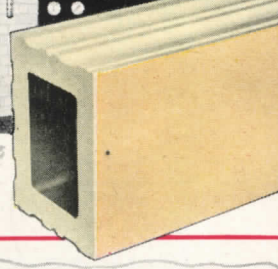

For Soil-free Industrial Interiors

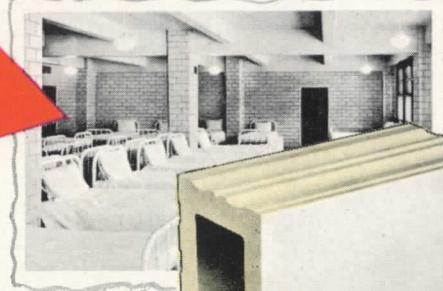
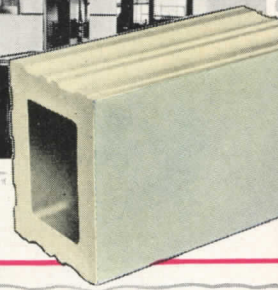

For Sanitary Hospital Interiors

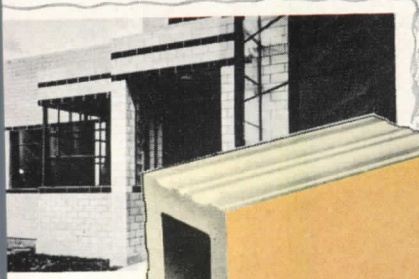
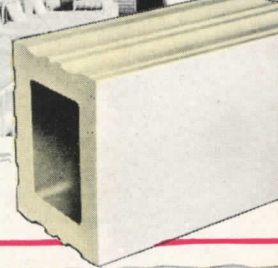

For Modern Homes Rooms

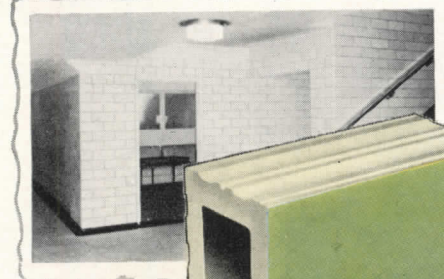
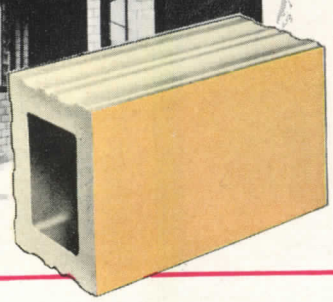

For Durable School Interiors

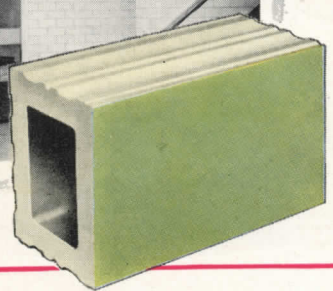

For Dramatic Theater Construction

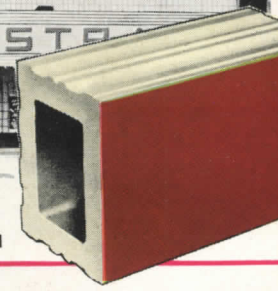

VISIT OUR DISPLAY-BOOTH 48

NATIONAL ASSOCIATION OF HOME BUILDERS' CONVENTION

ELECTRO-CELL



shows surprise saving for jewelry store



MOST users of AAF filters obtain some unforeseen benefits from super-clean air that represent worthwhile savings. The Bromberg Company, Birmingham, Ala., is no exception. One of the South's leading retailers of fine jewelry, silver and home furnishings, this company occupies a new store built shortly after the close of the war. The air conditioning system includes AAF Electro-Cell Electronic Precipitators.

The obvious advantages of filtered air are many for a store of this type. Freedom from dust, dirt and smoke means less cleaning and maintenance of store fixtures and interiors—merchandise is protected against soilage and there is less danger of damage resulting from frequent cleaning.

But here is the surprise saving. Formerly, polishing silver was a full time operation. Now the silver retains its sparkle and lustre much longer and polishing has been reduced to a part time job. This jewelry store is but one example of the many small businesses which are experiencing the benefits of electronic air filtration. Every business, regardless of size, can benefit from clean air.

Architects and Consulting Engineers are assured of satisfied clients when they specify AAF Electronic Precipitators. American Air Filter offers a complete line of products to meet every air cleaning need. For complete catalog data contact your local AAF Representative or write direct to:

VISIT AAF EXHIBIT

Booths 18-19
International Heating & Ventilating Exposition
New York City, February 2-6.

AMERICAN AIR FILTER CO., INC.

389 Central Ave., Louisville 8, Ky.

In Canada: Darling Bros. Ltd., Montreal, P. Q.



**AIR FILTERS
AND DUST CONTROL EQUIPMENT**

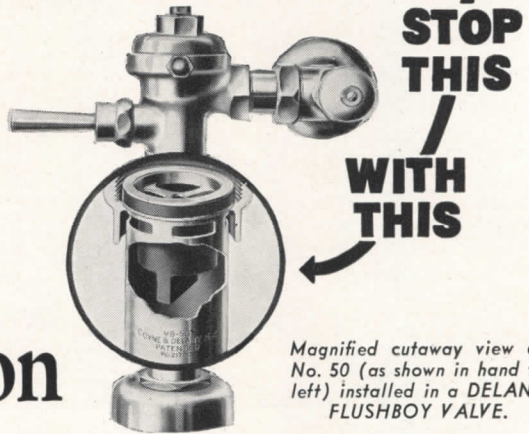
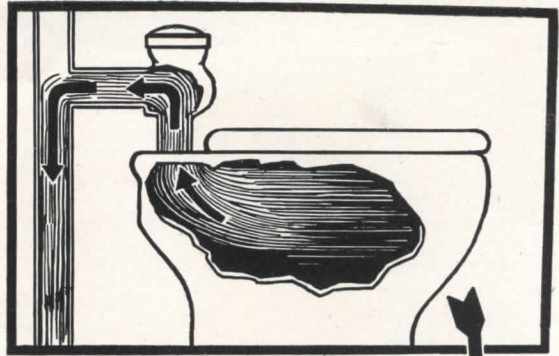
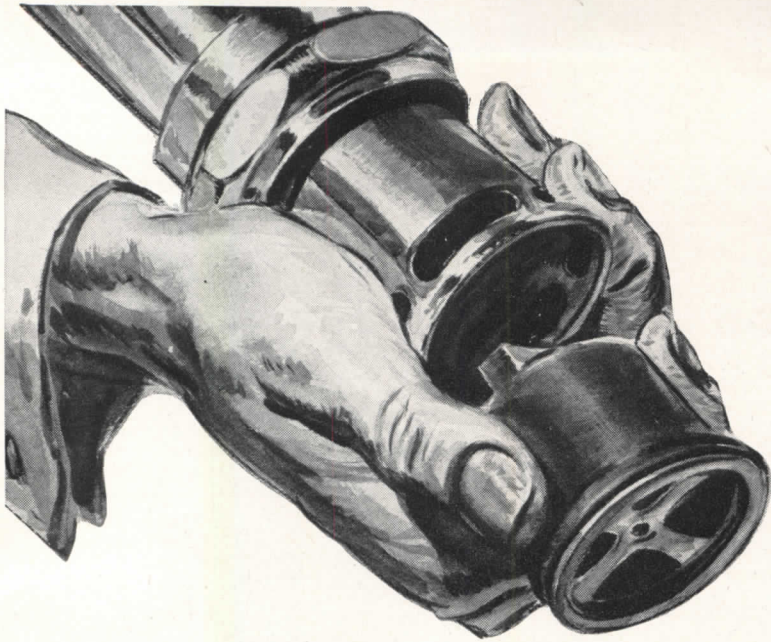

Magnified cutaway view of No. 50 (as shown in hand to left) installed in a DELANY FLUSHBOY VALVE.

Ounces of Prevention Prevent Rounds of Epidemic

—thru the use of No. 50
DELANY VACUUM BREAKER with
ANY flushometer installation.

By preventing back-siphonage from entering the fresh water supply lines you **STOP COMPLETELY** one of the commonest sources of possible contamination with probably transmission of water borne diseases.

SIMPLICITY IS TRUTH

Everyone accepts the fact that the maximum of top performance derives from simplicity. The long life and iron clad protection provided in our No. 50 Vacuum Breaker has been proved in many laboratories of national repute. (Send for copies).

Also, its simplicity of design, free of numerous parts, emphasizes its low cost maintenance. When necessary, the accessibility and the replacement of one part (rubber sleeve) regains instantly the initial efficiency and is accomplished in less than three minutes. The No. 50 is always self-policing.

The No. 50 Delany Vacuum Breaker meets the requirements of the U. S. Bureau of Standards and is fully approved by most States and municipalities.

Write for Folder

Bacillus Dysenterial Shiga:
Causes human dysentery

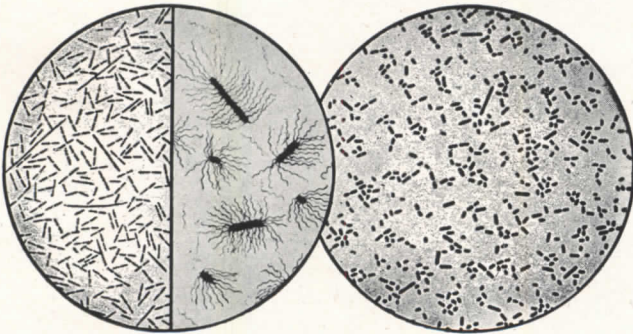

Bacillus Typhosus, the causative organism of Typhoid

SINCE 1879
Coune & Delany Co.
BROOKLYN N.Y.
FLUSH VALVES · VACUUM BREAKERS · PLUMBING SPECIALTIES

Now . . . SMALLER STORES CAN AFFORD A HIGH QUALITY Electric

**puts first floor traffic
on every floor**

● Small and medium size stores all over the country have long asked for a high quality electric stairway at a price they could afford to pay. Now . . . Westinghouse engineering and research have supplied the answer to their demand.

Priced at a level to make the use of moving stairways profitable in smaller stores, the new Westinghouse "Limited Budget" Electric Stairway is high quality. It has deluxe features proved in years of large stairway operation. Two-step leveling at top and bottom, trip-proof combplates, extended handrails at top and bottom, two brakes . . . all these and many other features assure maximum safety and convenience.

This new electric stairway also has an unmistakably "deluxe" appearance. Its beautiful etched and anodized aluminum balustrades will harmonize with and enhance the eye appeal of any store interior. Roomy in width, generous in capacity, it speeds customers to upper floors effortlessly, swiftly and dependably.

For complete information, write to the Westinghouse Electric Corporation, Elevator Division, 150 Pacific Avenue, Jersey City 4, N. J., on your letterhead please.

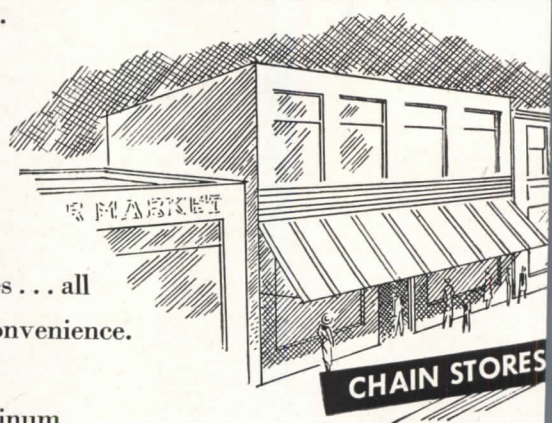
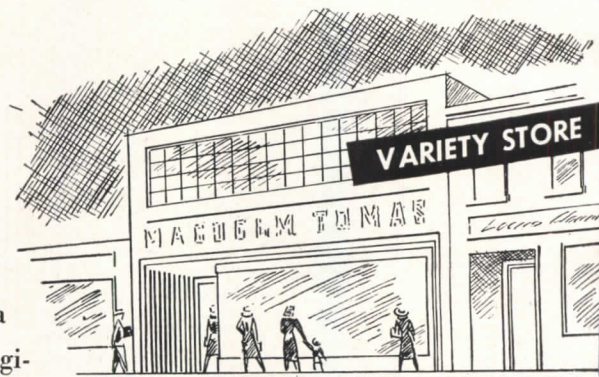

Write to Westinghouse for your copy of "The New Limited Budget Electric Stairway Brings First Floor Traffic to Every Floor." Address the Westinghouse Electric Corporation, Elevator Division, 150 Pacific Avenue, Jersey City, N. J., on your letterhead please.

Westinghouse

ELEVATOR DIVISION



Stairway

**WITH DELUXE FEATURES AT
LIMITED BUDGET PRICE**

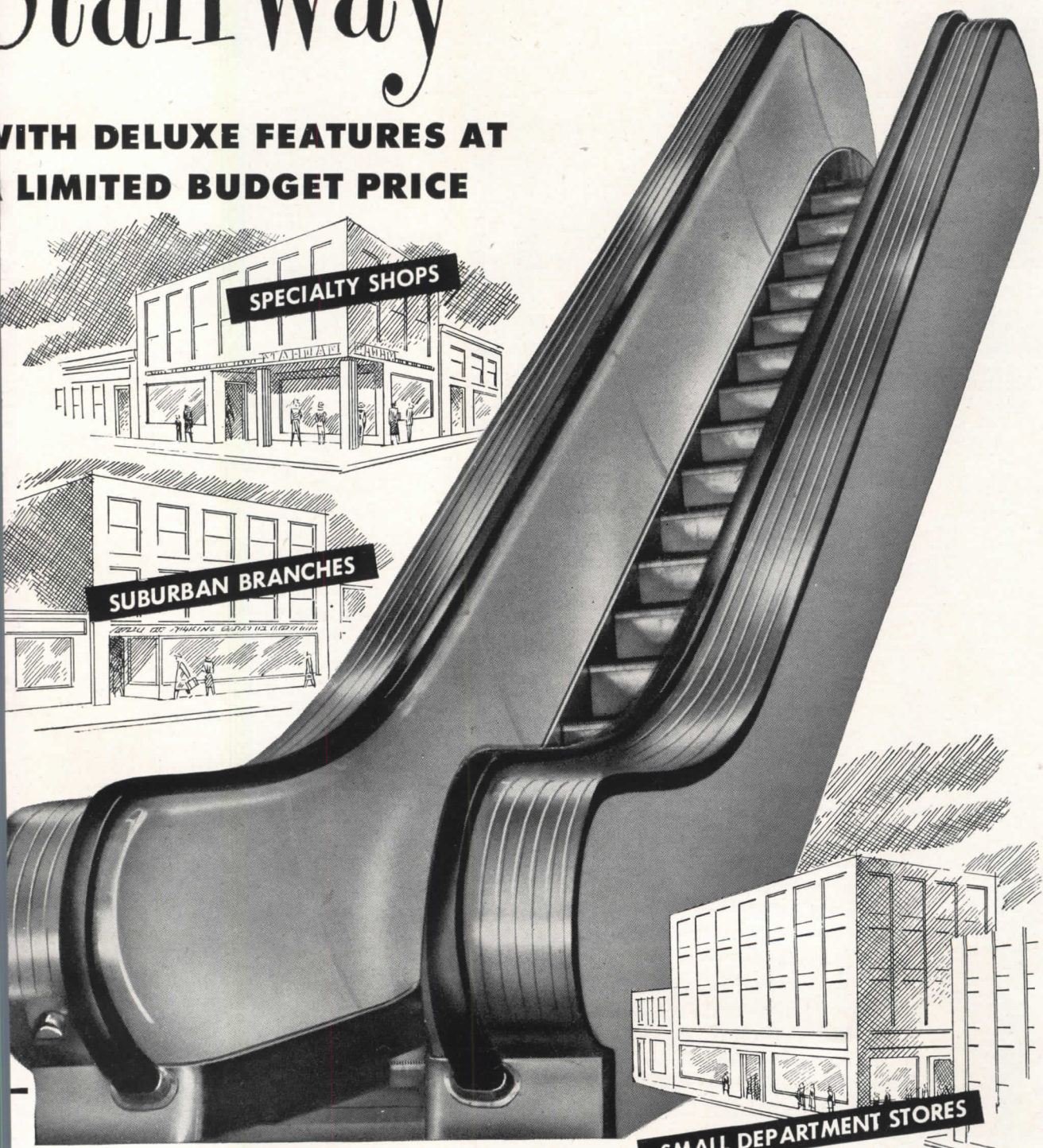
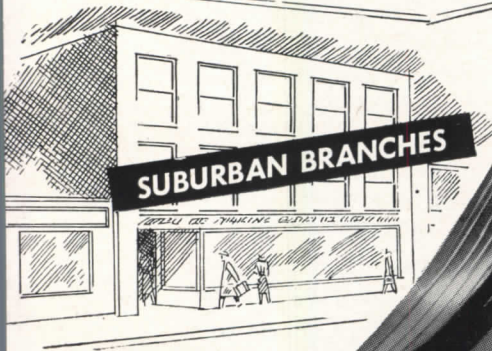

3509

What type of work does your firm handle?

Sweet's File architectural	Sweet's File architectural	Sweet's File architectural	Sweet's File architectural	Sweet's File architectural	Sweet's File for builders	Sweet's File engineering	Sweet's File engineering
<ul style="list-style-type: none"> contractors and special services 1 foundations 2 structural systems 3 masonry 4 wood 5 metals 6 glass 7 roofing and siding 8 	<ul style="list-style-type: none"> waterproofing 9 heat insulation 10 sound control 11 wallboard, lath and plaster 12 flooring and wall covering 13 paints and finishes 14 	<ul style="list-style-type: none"> doors 15 windows 16 hardware 17 door and window equipment 18 	<ul style="list-style-type: none"> partitions, wirework and fences 19 store fronts 20 skylights and ventilators 21 sanitary equipment 22 kitchen and food service equipment 23 furnishings and special equipment 24 elevators 25 	<ul style="list-style-type: none"> pipe and fittings 26 water supply and drainage 27 electrical distribution 28 air conditioning and heating 29 lighting 30 communication 31 	<ul style="list-style-type: none"> builders' equipment and tools 1 building materials 2 structural equipment 3 mechanical and electrical equipment 4 household appliances 5 special services 6 	<ul style="list-style-type: none"> construction equipment and services 1 structural systems 2 building materials 3 structural equipment 4 	<ul style="list-style-type: none"> mechanical equipment 5 electrical equipment 6 plant utilities 7 service equipment 8

SWEET'S FILE, ARCHITECTURAL

SWEET'S FILE for BUILDERS

SWEET'S FILE, ENGINEERING

You need information on certain kinds of building materials and equipment, according to the type of work handled by your firm. Other firms, active in other types of projects, need information on products, some of which are of little or no interest to you.

To give each firm of architects, engineers, contractors or builders the product information it requires, and to do so without wasting the money of the manufacturers who pay for this catalog service, Sweet's issues three separate files of catalogs. These three catalog files — *Architectural*, *Builders* and *Engineering* — are distributed in accordance with the type of work done, and the volume of such work.

Thus, a firm of architects designing commercial, educational, institutional, public, religious, recreational or residential buildings (other than small houses) receives Sweet's File, Architectural. Another architectural firm, active almost exclusively in the small house field, receives Sweet's File for Builders, which is compiled especially for designers and builders of light structures.

Architects predominantly active in designing industrial type buildings receive Sweet's File, Engineering. Firms of engineers, contractors or builders are similarly qualified in directing the distribution of the files.

We ask all recipients of Sweet's Files to consider that this service can be effectively rendered only with the cooperation of hundreds of manufacturers. Although some of them have products for all types of buildings, many have more restricted markets. For these, the economies of employing Sweet's service would be lost in excessive distribution of their catalogs. Specialized catalog distribution in three major divisions of the building market serves the interests of all concerned—building designers and constructors on one hand, and manufacturers of building materials and equipment on the other.

Sweet's is working constantly to get more catalogs and better catalogs in each of the files. One of the first things manufacturers want to be sure of is that their catalogs in Sweet's will be placed, without waste, in the right hands.



Sweet's Catalog Service

division of F. W. Dodge Corporation

119 West Fortieth Street, New York 18, New York

JUST PUBLISHED

New handbook on Air Diffusion



How to select, install and adjust diffusers for greater control of air conditioning performance

The new handbook contains the latest engineering data on air diffusion in general and the use of adjustable air diffusers as a positive means of eliminating drafts, hot spots, cold spots, poor humidity control, stratification, air noise, ceiling smudge and other complaints. It is profusely illustrated with photographs, sketches, charts and dimension prints for quick, accurate Selection—Application—Location—Assembly—Erection—Testing—Adjustment of Air Diffusers and of Accessory Equipment such as air equalizing grids, mounting rings and air sectorizing baffles.

FREE to those who design, install and maintain air conditioning equipment



Illustration from handbook showing industrial application of Kno-Draft Diffusers.



Illustration from handbook showing how Kno-Draft Adjustable Diffusers blend with interior.

BEAUTY for an air diffuser lies in its simplicity and ability to blend with an interior. Kno-Draft Diffusers in their original aluminum furnish an interesting and unobtrusive decorative accent. Painted to match the ceiling, they become self-effacing. Because of this simplicity of design, Kno-Draft Diffusers blend easily with modern or period interiors.

UTILITY: The air direction and volume on each Kno-Draft Diffuser can be altered *after* installation. This eliminates the tough job of deciding everything about the air movement in advance. Also, you can change the air pattern with the seasons or when processes, people or partitions are relocated.

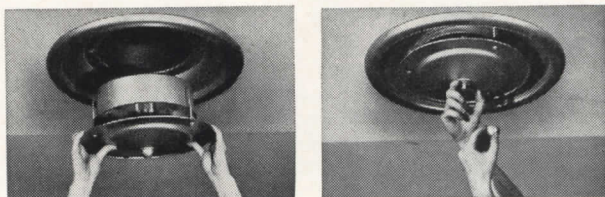

ECONOMY: Kno-Draft Adjustable Diffusers save time and money three ways. **1. Installation**—Special self-contained inner unit construction saves installation time—some contractors report up to fifty per cent. **2. Balancing**—Capacities of diffusers may be read directly and simply on a velometer and the air volume change can be made by simply turning a screw. **3. Adjustment**—No "after-installation" worry. Complaints are adjusted simply and quickly.

W. B. CONNOR ENGINEERING CORP.

Air Diffusion • Air Purification • Air Recovery

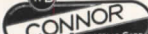
112 East 32nd Street  New York 16, New York

IN CANADA: Douglas Engineering Co., Ltd., 190 Murray St., Montreal 3, P. Q.

W. B. Connor Engineering Corp.
Dept. S-18, 112 East 32nd Street
New York 16, New York

Please send me a copy of the new Kno-Draft Handbook on Adjustable Air Diffusers.

NAME _____

POSITION _____

COMPANY _____

STREET _____

CITY _____ ZONE _____ STATE _____

COMPLETE WEATHER PROTECTION FOR MASONRY

Above Grade

Cabot's Clear Brick Waterproofing

For red brick and dark colored masonry.

Cabot's Clear Cement Waterproofing

For cement, stucco, cast stone and light colored masonry.

Cabot's Clear Waterproofings penetrate deep into voids and pores of masonry walls . . . provide a complete and long lasting moisture-proof seal . . . prevent unsightly efflorescence . . . protect walls from damage caused by freezing and thawing. Walls treated more than twenty years ago with Cabot's Clear Waterproofings are as moisture-proof today as when built.

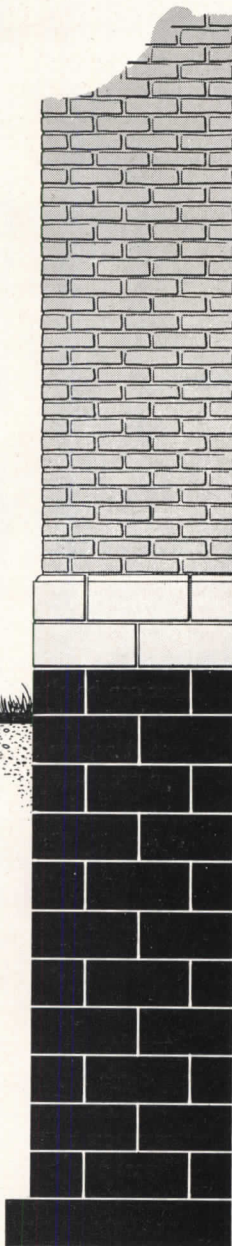

Below Grade

Cabot's Foundation Coating

A black, bituminous, elastic coating which makes foundation walls completely watertight . . . assures dry basements . . . protects masonry from the weakening effects of water seepage. Cabot's Foundation Coating is an efficient termite and insect repellent. Inexpensive and easy to apply.

Write Today

for free samples of these efficient waterproofings and complete information.

Samuel Cabot, Inc.

2180 Oliver Building, Boston 9, Mass.

Please send me a free sample of

- Cabot's Clear Brick Waterproofing
- Cabot's Clear Cement Waterproofing
- Cabot's Foundation Coating

NAME _____

ADDRESS _____

CITY _____

STATE _____

Quality is here in **TILETONE'S**
MODERN DESIGN
SHOWER CABINETS
Model 75

Here is quality in shower cabinets that's never been known before. Tiletone has designed new modern machinery to manufacture shower cabinets of MODERN DESIGN! Tiletone's Model 75 is the result of better manufacturing methods. It's unexcelled in quality with improved receptor base—longer lasting finish.



MODEL 75
 Sizes: 32" x 32" x 80",
 36" x 36" x 80" and
 40" x 40" x 80" Corner cabinet.

Terrazzo receptor. White Dura-Bond enameled aluminum cabinet. Interior lights. Anodized aluminum glass doors. Adjustable shower head. Dial type mixing valve.

TILETONE
Shower Cabinets

TILETONE COMPANY

2323 WAYNE AVENUE • CHICAGO 14, ILLINOIS

"THE ANSWER TO VAULT-UPKEEP IN A DAMP COASTAL CLIMATE"

THE SEABOARD CITIZENS NATIONAL BANK
OF NORFOLK
ARTHUR S. POPE, PRESIDENT
NORFOLK, VIRGINIA

August 7, 1947

ROBERT C. DE ROSSET
VICE PRESIDENT

Herring-Hall-Marvin Safe Company
1701 H Street, N. W.
Washington 6, D. C.

Attention: Mr. John L. Rowland,
District Manager

Gentlemen:

We wish to express to you our appreciation for the very fine manner in which you handled the installation of stainless steel vault equipment at our "Center Branch" on 21st Street, Norfolk.

After using this equipment for several months we are convinced that it provides the answer to vault upkeep in our damp coastal climate. The use of oil and grease in maintaining this equipment has been reduced to a bare minimum, and our lock box customers seem to appreciate the fact that contact can be made with the surface of the boxes without soiling their hands or their clothes.

The door is very attractive and we have received many compliments on its appearance. To your entire organization we are grateful.

Very sincerely yours,
R. C. de Rosset
R. C. de Rosset
Vice President

de R/ba

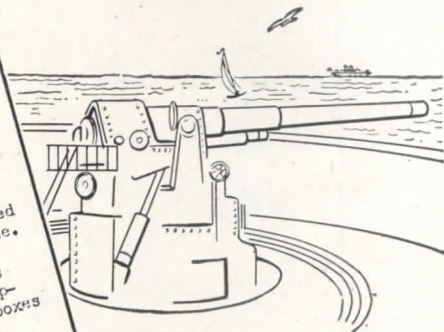

The enthusiastic, unsolicited testimonial by The Seaboard Citizens National Bank of Norfolk, reproduced (with permission) here, points out one of the important advantages of H.H.M. Stainless Steel Vault Equipment.

Whether you are located in a coastal city or in an inland town, there are other great advantages of this modern equipment which deserve careful consideration. Stainless steel finish for bank vault entrances . . . interlocking channel frame vestibule . . . stainless steel safe deposit boxes . . . instantly changeable keys for safety deposit box locks . . . these are just a few of the many improvements pioneered by Herring-Hall-Marvin engineers. If you are considering new construction or remodeling, write, wire or telephone us today. Your inquiry will be referred promptly to a competent, technically trained representative in your own section of the country.

This 7-inch Laminated Stainless Steel Vault Entrance is helping to cut maintenance costs for the Seaboard Citizens National Bank of Norfolk.

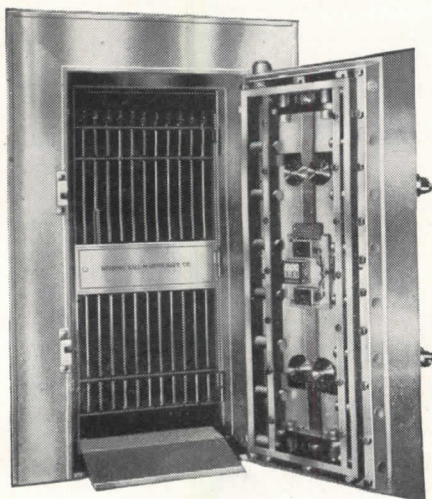

HERRING · HALL · MARVIN SAFE CO.

Manufacturers of Bank Vault Equipment—Bank Counters
—Tellers' Buses and Lockers—Safe Deposit Boxes—
Night Depositories—Bank and Office Safes

BUILDERS OF THE UNITED STATES SILVER STORAGE
VAULTS AT WEST POINT

General Offices

HAMILTON, OHIO

BRANCH OFFICES

In New York, Chicago, Boston, Washington, St. Louis, Atlanta, Houston, Philadelphia, San Francisco, Los Angeles, Detroit, Pittsburgh, Omaha, Indianapolis, Minneapolis, Charlotte

OTHER AGENCIES ALL OVER THE WORLD

SERVEL IS THE CHOICE YEAR AFTER YEAR BECAUSE

stays silent

“WAY BACK IN 1933 . . .

we chose Servel for our 56-room apartment house. Thanks to that wise choice, my tenants have enjoyed 15 years of silent, dependable service . . . at very low cost.”

Jacob Bromberg

JACOB BROMBERG

President of the 6930-62nd Street Corp.
Ridgewood, Long Island, New York



TODAY, with families moving into apartments and housing developments as fast as they're made available, there's a greater appreciation for *silent* refrigeration than ever before. Tenants associate silence with modernity. They reason that every step away from mechanical noise is a step toward happier home life. And the owners and architects want refrigerators that give *dependable, year-after-year service . . . at low cost*. That's why more and more tenants prefer—and more and more owners are ordering—Servel.

Unlike other type refrigerators, Servel operates with no moving parts. A tiny, silent gas flame does the complete job of circulating the refrigerant through the Gas Refrigerator's simpler, basically

different freezing system. There's nothing to make the slightest sound . . . no machinery to wear or break. That's why it costs so little to operate and maintain a Servel . . . why repair and replacement bills remain low.

Besides the famous “no noise, no wear” freezing system, Servel has all the worthwhile, up-to-date cabinet features tenants and owners are looking for, including a big frozen food compartment . . . plenty of ice cubes . . . moist-cold, dry-cold for fresh foods . . . large, flexible interior with adjustable shelves . . . and a host of other modern conveniences.

For installation data and complete information, see Sweet's catalog . . . or write to Servel, Inc., Evansville 20, Indiana.

STAYS SILENT
LASTS LONGER

Servel The GAS

IT'S THE ONLY REFRIGERATOR THAT—

...lasts longer!

"JUST 12 MONTHS AGO...

we installed 89 new Servels. What sold me on the Gas Refrigerator? Why, no noise, no wear, low operating cost, and longer life, of course."

Morris Lainoff

MORRIS LAINOFF

Agent for Kings Tower Realty Co.
1525 E. 26th St., Brooklyn, N. Y.

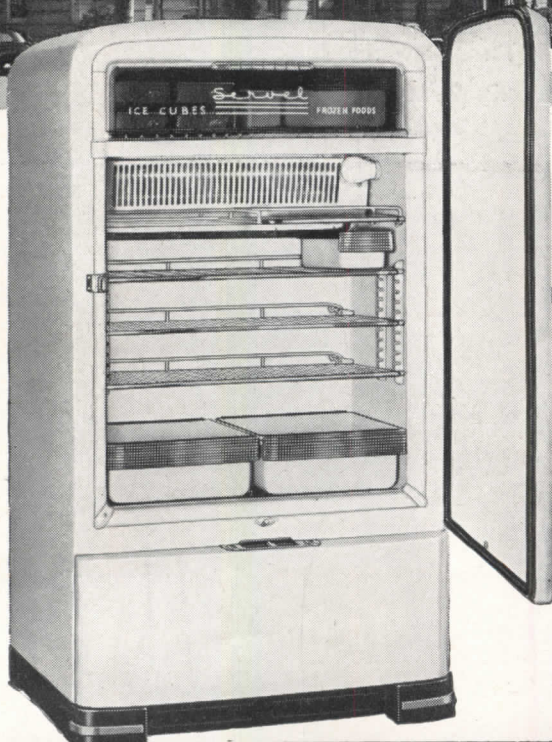
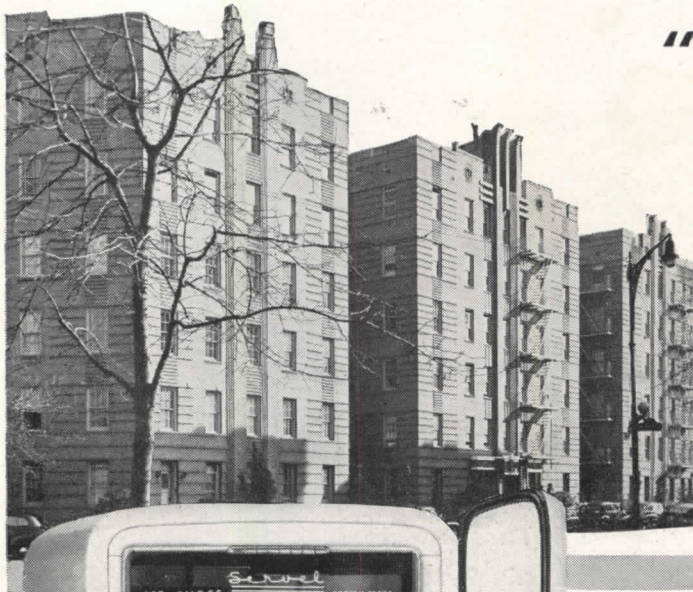

Here's *WHY* Servel freezes with ...

**NO NOISE
NO WEAR**

The refrigerant is hermetically sealed in a set of vessels connected by pipes. A tiny gas flame is applied to the lowest vessel (A). Owing to the evaporation properties of the refrigerant and the law of gravity, ice forms in an upper vessel (B). No machinery—not a single moving part—is needed. Thus, Servel stays silent, lasts longer.

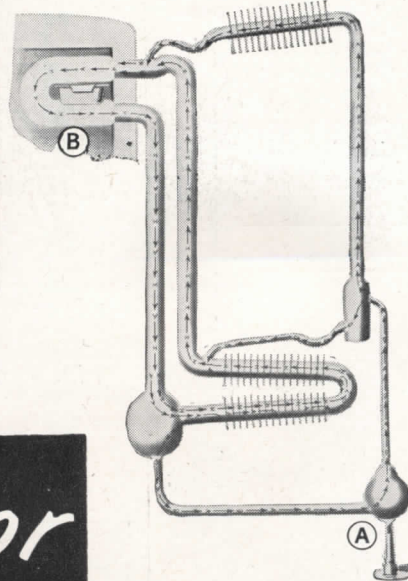

Refrigerator

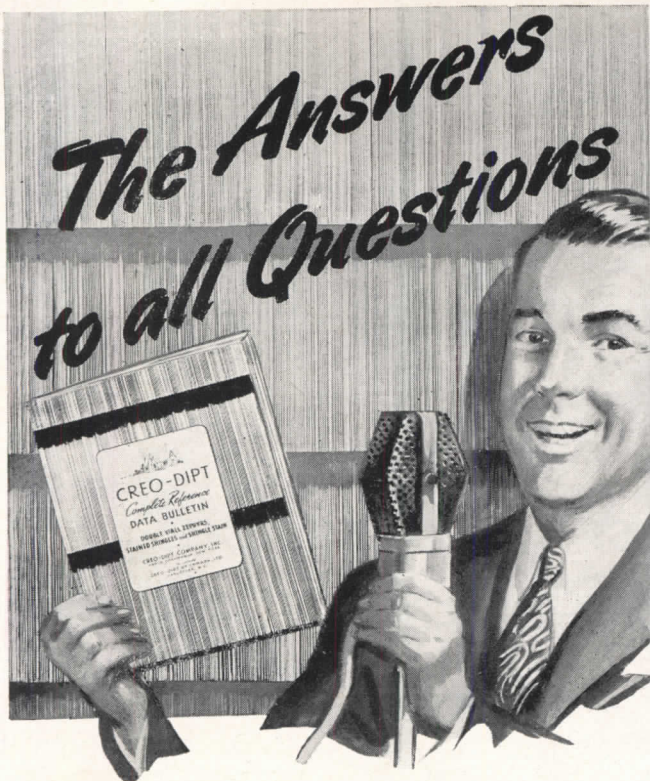

including the \$64 one!

Creo-Dipt has just published its new Complete Reference Data Bulletin, written expressly to answer all questions pertaining to the use of Double Wall Zephyrs and Stained Shingles for roofs or sidewalls.

All data concerning recommended exposures, coverage charts, method of laying, insulating qualities, and data concerning the preparation of estimates for Double Wall Zephyrs and stained shingles for roofs and sidewalls is conveniently and concisely set forth for easy reference.



The coupon below will bring you your copy. Send for it now!



CREO-DIPT COMPANY, INC.
North Tonawanda, N. Y.

Please send me my copy of your Complete Data and Reference Bulletin.

Name _____

Address _____

CD-E-202

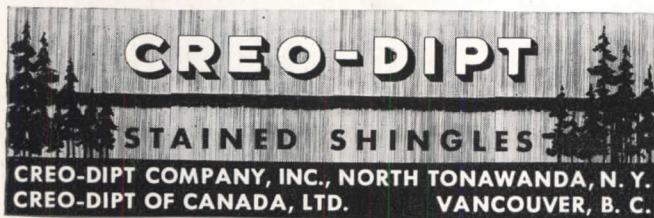

THE ORIGINAL STAINED SHINGLE—FIRST AND BEST!

The easy, practical way to cover insulated surfaces

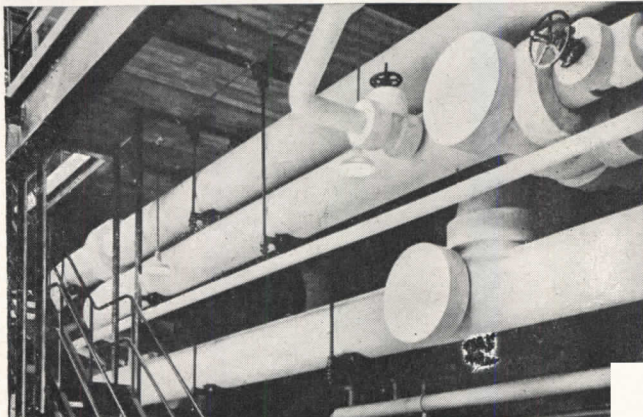

Sewing the canvas—or applying metal strapping—these time-consuming operations are no longer necessary. The canvas, asbestos, fiberglas or other non-conductor can be securely bonded with Arabol Lagging Adhesive.

This adhesive dries in 4 to 6 hours; leaves a sized finish on the lagging material . . . the job is completed. No paint need be used on this sized finish, unless you prefer to add one coat for appearance. Maintenance is simplified—grease, oil, soot and dirt wash off easily. And the adhesive is vermin-proof . . . fire-retardant, too.

Arabol Lagging Adhesive has successfully passed rigorous tests by independent laboratories. The results show that it retains its adhesive powers despite exposure to extreme temperatures, to immersion in water and to live steam.

Write us today for detailed facts and figures. Don't place open specifications on lagging work — ask for Arabol Lagging Adhesive. You can depend on it to fill your most exacting requirements for both utility and appearance. Also, ask about our cork cement for adhering cork to cork on refrigerator lines.

THE ARABOL MANUFACTURING CO.

Executive Offices: 110 East 42nd St., New York 17, N. Y.

CHICAGO—54th Ave. & 18th St. SAN FRANCISCO—1950 16th St.

ST. LOUIS—2500 Texas Ave.

Branches in Principal Cities

Factories in Brooklyn, Cicero, San Francisco, St. Louis



Adhesives?... **ARABOL!**



Hospitals with a modern air

Many leading hospitals are enhancing their prestige with a complete Carrier air conditioning system. Close control of temperature and humidity in bedrooms increases patient comfort, speeds recovery. . . . Modern Carrier systems can be as readily installed in old structures as in new. Compact Carrier design keeps space requirements at a minimum. . . . For operating rooms, nurseries and other special rooms, Carrier self-contained air conditioning units are available. And for refrigeration in laboratory and kitchen there's a Carrier refrigerating unit to meet any need. . . . Carrier leadership in air conditioning and refrigeration engineering assures dependable, low-cost service. Carrier engineers for years have teamed up with architects and their consulting engineers to create the finest possible air conditioning and refrigeration for each individual installation. Carrier Corporation, Syracuse, New York.

Carrier

AIR CONDITIONING • REFRIGERATION • INDUSTRIAL HEATING



Without exception, masonry surfaces deteriorate because of excessive moisture. Rain water, vapor, air-borne acids, salts, ice and dust—capillarity, efflorescence, condensation, oxidation and expansion . . . settlement and local over-stressing—all cause the disintegration of porous masonry surfaces.

This natural and wasteful destruction can be prevented and structures protected through remedial restoration and weatherproofing. Properly handled, these treatments will add many years of use to any type building and reduce interior and exterior maintenance costs. Western's materials—Resto-Crete and Ironite—and Western service—a combination of technical knowledge, proper methods, adequate equipment and 35 years of experience—can be safely specified for the protection and maintenance of your client's structures.

Let us assume **complete responsibility** for weatherproofing your buildings.

See our catalog in Sweets file for Architects

For Below-Grade
WATERPROOFING
"Ironite"
(TRADEMARK)

Specifications for these exclusive Western materials are available at all Western offices. No materials for sale; contract work only.

For Above-Grade
WATERPROOFING
"Resto-Crete"
(TRADEMARK)

WESTERN

WATERPROOFING COMPANIES
Engineers and Contractors

- ★ BOSTON
- ★ CINCINNATI
Dayton, Ohio
Indianapolis, Ind.
- ★ DETROIT
Cleveland, Ohio
Toronto, Ont.
Montreal, Que.
- ★ NEW YORK
- ★ PHILADELPHIA
Scranton, Pa.
Baltimore, Md.
Washington, D. C.

- ★ ST. LOUIS
Kansas City, Mo.
Springfield, Ill.
Charlotte, N. C.
Atlanta, Ga.

★ CHICAGO

Waterproofing Company



Gives new charm to walls overnight!

washable *Prestile*

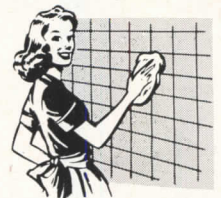

Cleans easily as china with a damp cloth.

When clients want lustrous . . . colorful . . . lasting beauty for bathroom, powder room and kitchen walls, tell them about *Prestile*. This modern quality tileboard can be applied in one day—right over present walls, making it ideal for remodeling as well as for new construction. *Prestile* is perfect, too, for commercial and institutional walls and counters wherever eye appeal, economy, durability and maximum sanitation are required. Write for literature and free sample of *Prestile* today.

PRESTILE MANUFACTURING COMPANY
2860 Lincoln Avenue . . . Chicago 13, Illinois

economical *Prestile*



Goes on in large, labor-saving panels.

Advertised in *American Home*, *Better Homes and Gardens*, *House and Garden*, *Small Homes Guide* and other leading magazines.

PRESTILE

"Its Plastic Beauty is Baked In"

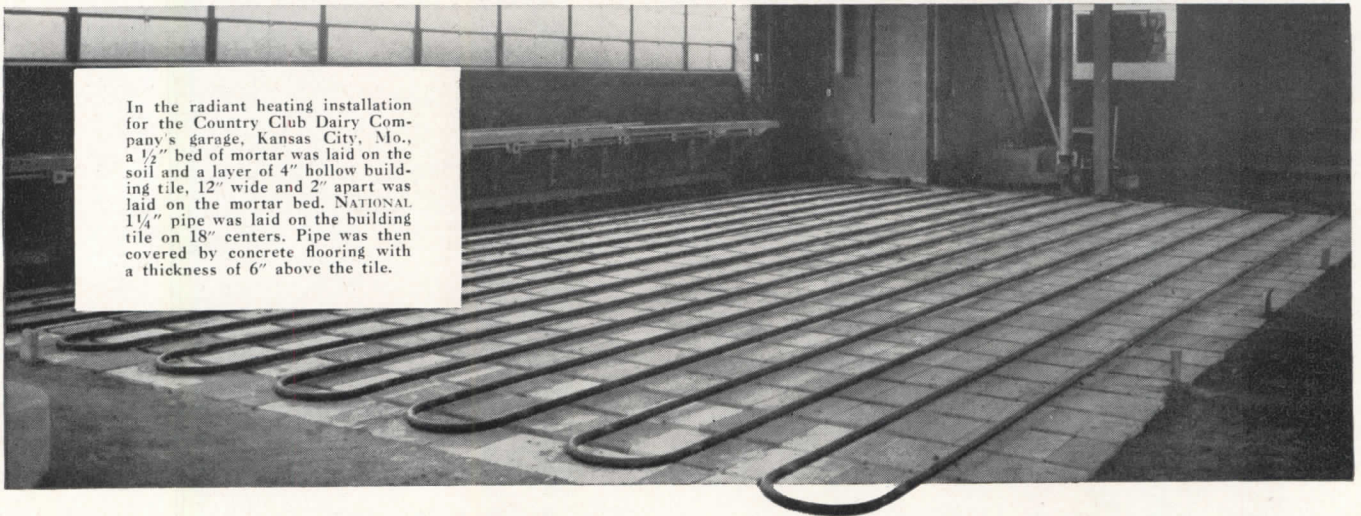
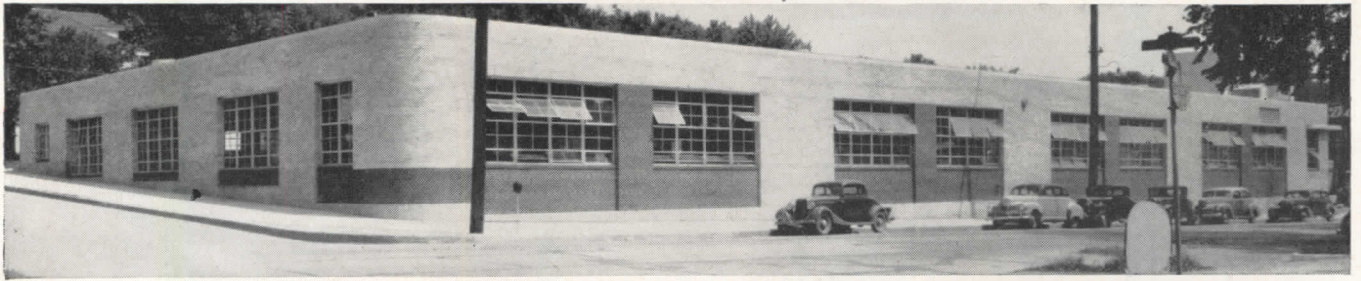

In the radiant heating installation for the Country Club Dairy Company's garage, Kansas City, Mo., a 1/2" bed of mortar was laid on the soil and a layer of 4" hollow building tile, 12" wide and 2" apart was laid on the mortar bed. NATIONAL 1 1/4" pipe was laid on the building tile on 18" centers. Pipe was then covered by concrete flooring with a thickness of 6" above the tile.

Planning a radiant heating installation?

... make sure the pipe is **NATIONAL**

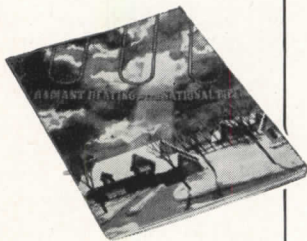

This 48-page book brings you an easy to understand story on radiant heating and gives you practical information as a basis for planning and installing an efficient pipe system. It will answer many questions about radiant heating that you may have. For your free copy address: National Tube Company, Frick Building, Pittsburgh, Pa.

COLD floors, so detrimental to garage personnel, have been successfully eliminated in this Missouri dairy garage by radiant heating. It has also eliminated hot and cold temperature zones . . . minimized the chilling caused by door openings . . . provided a larger working area.

Steel pipe is ideal for radiant heating installations just as it is ideal for other hot water or steam heating systems. It expands at the same rate as concrete and plaster; it is easy to weld, easy to bend, and, with its maximum of advantages, costs less.

NATIONAL, the leader in steel pipe

for many years, offers the additional advantages of the Scale Free and Spellerizing Processes. These processes mean that the pipe interior is clean, smooth, free from mill scale, with minimum frictional resistance. They also mean superior corrosion resistance, and increased weld strength through extra rolling.

For detailed information on the use of NATIONAL Pipe in radiant heating installations, write for Bulletin — "Radiant Heating with NATIONAL Pipe." Address National Tube Company, Frick Building, Pittsburgh, Pennsylvania.



NATIONAL TUBE COMPANY

PITTSBURGH, PA.

Columbia Steel Company, San Francisco, *Pacific Coast Distributors*
United States Steel Export Company, New York

UNITED STATES STEEL



They're the fountains
to specify... for 48

YEAR after year Halsey Taylor Drinking Fountains are the preferred specification of architects and school authorities who know and appreciate their unique advantages.

Modern in design, their distinctive features spell convenience and sanitation, and they are available in a wide variety of types. Write for latest literature.

The Halsey W. Taylor Co., Warren, O.

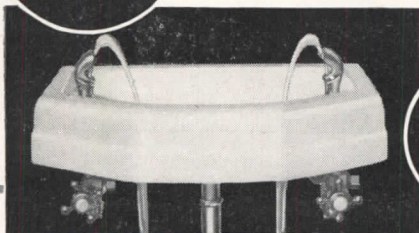

HALSEY TAYLOR
Drinking Fountains

5-1

A NATION-WIDE SERVICE OF FLOOR TREATMENT ENGINEERS

HILLYARD'S
OFFICE AND PLANT
ST. JOSEPH, MO.

Write or wire us today for the Hillyard Floor Treatment Specialist nearest you, his advice is entirely FREE.

HILLYARD'S... THE MAIN THING IN MAINTENANCE

There is no floor problem too large or too small for Hillyard Floor Treatment Engineers. Hillyard's have products for every type surface in every type of institution, from the basement floor to the roof top and Hillyard trained men to give you the utmost in economical Floor Treatment, Safety and Sanitation Maintenance.

HILLYARD SALES COMPANIES

470 A LABAMA ST. SAN FRANCISCO 2, CALIF. DISTRIBUTORS HILLYARD CHEMICAL CO. ST. JOSEPH, MO. BRANCHES IN PRINCIPAL CITIES 1947 BROADWAY, NEW YORK 23, N. Y.

ZONOLITE* INSULATING CONCRETE IDEAL FOR GRADE LEVEL AND RADIANT-HEAT FLOORS

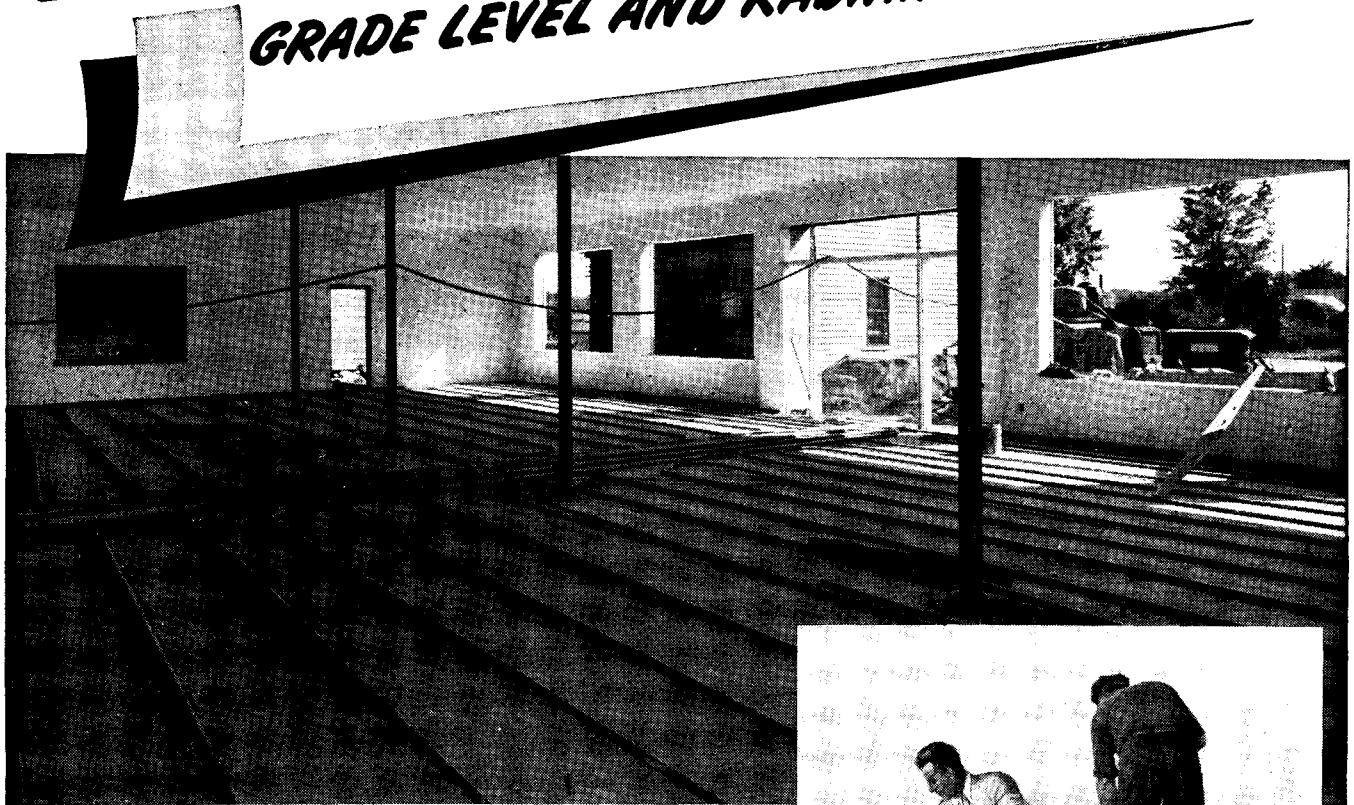

Radiant Heating Coils resting on Zonolite Insulating Concrete

Another new development for builders—FLOORS THAT INSULATE! By using Zonolite Insulating Concrete for grade level floors in commercial structures or homes, cold and dampness can be eliminated. Heat loss into ground will be avoided.

Zonolite Insulating Concrete floors are made by mixing a specially graded Zonolite brand of vermiculite with Portland cement. This insulating concrete can be placed directly on the ground (vapor seal often placed on ground first) forming a fireproof, rot proof, termite proof, vermin proof floor base.

When radiant heating is specified, these floors are particularly desirable as a base for the coils or ducts. After laying the coils on this highly efficient and permanent base, they should then be covered with ordinary concrete. Heat waste into the ground is greatly reduced and enables the room to heat faster.

Whenever a floor is constructed on grade level, regardless of whether or not it has radiant heat, Zonolite Insulating Concrete should be specified. Because of the low heat capacity of Zonolite Insulating Concrete, condensation on the floor surface on warm, humid summer days is avoided.



Covering coils with a topping of ordinary concrete

ZONOLITE CONCRETE FLOORS REDUCE DEAD LOAD IN HIGH BUILDINGS

Zonolite Insulating Concrete, when used as a fill over steel pan floors, reduces dead load. When used in this way, the fireproofness of the building is greatly increased as Zonolite is one of the most fireproof materials known. Zonolite Concrete aggregate weighs as little as six pounds per cubic foot.

Send now for complete information about Zonolite Concrete Floors.



UNIVERSAL ZONOLITE
INSULATION CO.
Dept. AR18, 135 S. La Salle St.
Chicago 3, Ill.

MAIL COUPON
FOR DETAILS

SEE YOUR LOCAL LUMBER AND BUILDING MATERIAL DEALER

Universal Zonolite Insulation Co.
Dept. AR18, 135 S. La Salle St., Chicago 3, Ill.
Please send complete details on Zonolite Insulating Concrete Floors.

Name.....

Address.....

City..... Zone..... State.....

Please check: Architect Engineer Draftsman Contractor

*Zonolite is the registered trade mark of Universal Zonolite Insulation Co.



Stirring Progress in **JOHN VAN'S FIRST CENTURY**

Twenty years before Pasteur demonstrated the theory of bacterial pathology, the founder of this Company was applying the basic principles of sanitation to the construction of kitchen equipment for hospitals, **in 1847!**

Every advance of the metallurgist, the engineer, the fabricator, Van has applied to the design and manufacture of the ideal hospital kitchen.

While the expansion program of your hospital clients may be delayed, use the time meanwhile to insure that all recent refinements are incorporated into the new John Van kitchen plan.

The John Van Range Co.

EQUIPMENT FOR THE PREPARATION AND SERVING OF FOOD

DIVISION OF THE EDWARDS MANUFACTURING CO.

Branches in Principal Cities

429 CULVERT STREET, CINCINNATI 2, OHIO

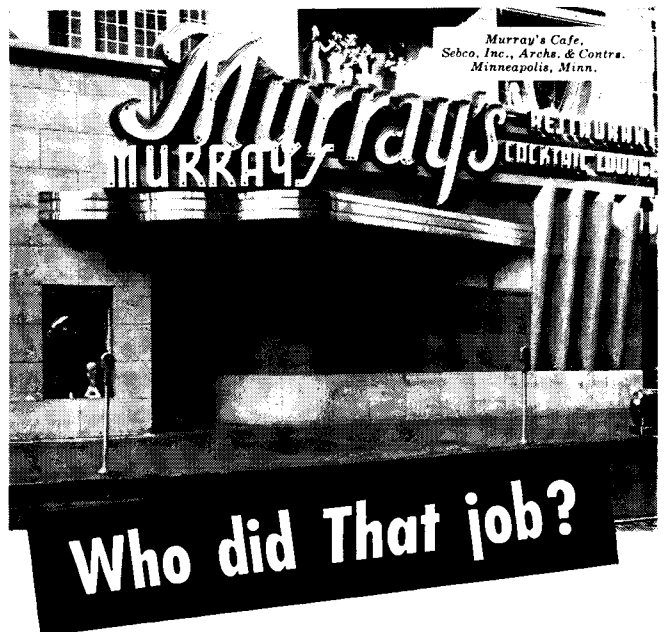

SEAPORCEL—the-beautifier is also Seaporcel—the-sales-maker. Not only for your clientele, but for you.

What more natural prospect-question than "Who did that job?" And what more natural self-promise than "That's for me, too!"?

See how Seaporcel* becomes the background of perfection for letters of distinction in the front portrayed here. See how Seaporcel, in turquoise terra cotta, blends daringly, dramatically, adroitly, with white metal, Kasota stone—yes, even wood, utilized in the upright fins as shown in the above photo.

With unlimited color range, from delicate pastels to jet black . . . with numerous finishes, including gloss, semi-matte, terra cotta, granite and limestone . . . Seaporcel offers you a material at once versatile, economical, and enduring. For Seaporcel is porcelain enamel de luxe—not painted, but fused to steel for lasting newness.

**Get The Facts—And You'll Get
SEAPORCEL**

WRITE TODAY for bulletins, showing applications and current jobs.

Inquiries from interested agents invited; there are a few areas in which Seaporcel Porcelain Metals, Inc., desires representation.

SEAPORCEL PORCELAIN METALS, INC.

Formerly Porcelain Metals, Inc.

28-02 Borden Ave., Long Island City 1, N. Y.

*Seaporcel (Reg. U.S. Pat. Off.) is a ceramic fused into its metal base at 1550 degrees F.



Seaporcel

Member: Porcelain Enamel Institute, Inc.



Here's a quick way to find a doctor

• Page doctors, nurses, supervisors and other staff personnel by name when you want quick action.

Voice paging, via an RCA Hospital Sound System, in selected areas or in many hospital zones, at once contacts your party . . . directs him to where he is needed . . . in a matter of split seconds. It is a matter of record that voice paging with an RCA Sound System handles four times the number of calls and locates the person twenty-five times faster than conventional coded signal systems.

ADDED BENEFITS OF RCA SOUND SYSTEM

In addition to their paging and announcement facilities, RCA Sound Systems provide the finest music and

entertainment . . . from recordings, radio and your recreational programs. They provide relaxation for patients and off-duty staff members. Hospitals find an RCA Sound System ideal for the use of musical therapy in the treatment of psychiatric and other cases.

PRACTICAL HELP FOR ARCHITECTS

No matter what size hospital you have on your drawing board there is an RCA Sound System that will fit your architectural plan. Call upon RCA sound engineers to assist you with sound system planning and specifications. No obligation of course. Write: *Sound Products Section, Dept. 3-A, RCA, Camden, N. J.*

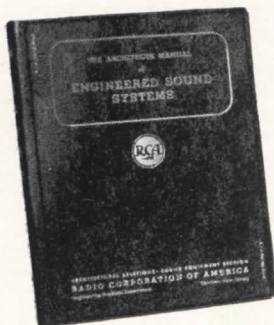

**ORDER
YOUR
COPY
NOW!**

The Architects Manual of Engineered Sound Systems

The most authoritative work book and reference manual published on sound systems. Typical plans and specifications for all types of buildings. 288 pages. Price \$5.00 (\$5.50 foreign).



SOUND SYSTEMS
RADIO CORPORATION of AMERICA
ENGINEERING PRODUCTS DEPARTMENT, CAMDEN, N. J.

In Canada: RCA VICTOR Company Limited, Montreal



Pratt & Whitney Keep This Room at 68 deg. F., the Year 'Round.

Hold Any Temperature You Want with

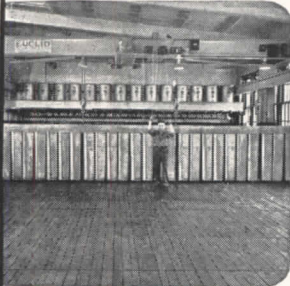

One-man One-shift Semi-Automatic Plant Makes 42 Tons of Ice Daily.

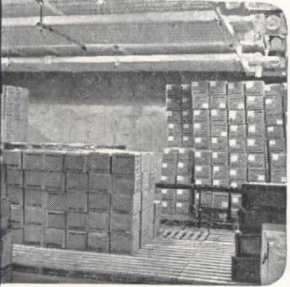

Frozen Foods Stored at -10° F. by Birds Eye-Snider.

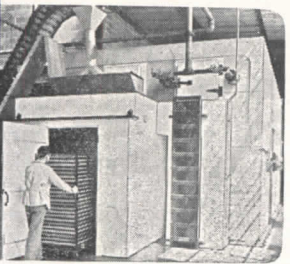

Frick-Freezer Tunnel operated at -35° F. at Lancaster, Pennsylvania.

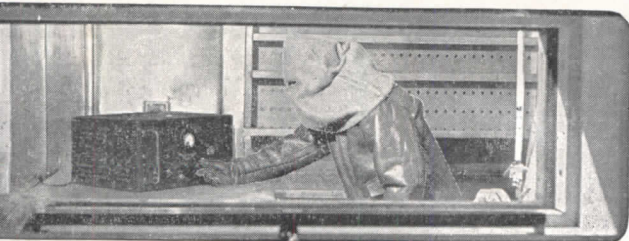

Test at -76° F. in a Refrigerated Laboratory of Bendix Radio.



Refrigeration

"Cold" down to 130 degrees below zero F. is now common in research and test work. Penicillin is dried at minus 75. Foods are quick-frozen at minus 30 to minus 60: are stored at zero to minus 20. Ice is frozen commercially in brine at 16. Fresh foods are held at 34 to 36. Drinking water is cooled to 45. Air conditioning, at 70 to 85, tops the scale of refrigerating loads. • Whatever the temperature wanted, you can hold it most dependably with Frick Refrigeration. Sixty-five years' experience says so!

DEPENDABLE REFRIGERATION SINCE 1882

FRICK Co.

WAYNESBORO, PENNA. U.S.A.



Here's Beauty with Safe, Lasting Service in Step Treads—

Now— Heavy Duty Molded SAFETY

Step Treads in marbled blue-gray and tan patterns give appealing beauty with long-lasting service. . . . MELFLEX SAFETY Treads are molded $\frac{3}{8}$ inch thick of special "frictioned" rubber compound to cover both the tread and step-edge. Approved by Underwriters Laboratories, Inc. (No. SA 833) as a SAFETY feature, this molded tread applies without requiring metal strips or screws. It stays "put", won't buckle or blister when applied simply with MELASTIC Water-Proof Cement to wood, stone, metal or composition steps. . . .

Molded in One-Piece To Cover Approach Edge . . .

It cushions step edge as well as provides sure-gripping tread safety, wet or dry. These Treads, also available in black compound, may be applied on inside or outside steps with equal safety and service.

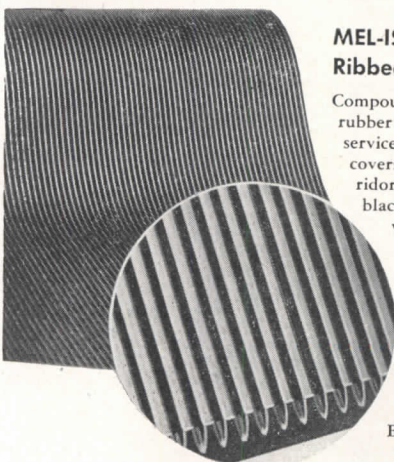

MEL-ISLE Heavy Duty Ribbed Rubber Runner . . .

Compounded of special "frictioned" rubber for hard wear and slip-proof service, MEL-ISLE makes the ideal covering for aisles, runways, corridors, locker rooms. Available in black only $\frac{1}{8}$ " and $\frac{3}{8}$ " thick, 36" wide and cut to any specified lengths. High ribbed pattern facilitates cleaning and keeps tread surface slip-proof. MEL-ISLE Molded Mats, for entrances, $\frac{3}{8}$ " thick and in 5 stock sizes have beveled edges to prevent tripping. Slip-Proof wet or dry. . . . Durable. Economical.

Trade Mark Registered

MELFLEX

MELFLEX PRODUCTS CO., Inc.

L. E. Warford, Pres.

410 S. BROADWAY . . . AKRON 8, O.

In Canada: P. O. Box 411, Ft. William, Ont.

Modernizing with Vermont Marble

Provides Color, Character, Permanence, Low Maintenance



MARBLE AT YOUR ENTRANCE

Suggestions:

Vermont Verde Antique
Red Antique of Italy
White Vermont
Verte Issorie

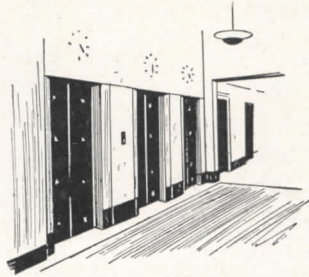

MARBLE IN YOUR LOBBY

Suggestions:

Aurisina Fiorito
Botticino
Rosso Verona Alberato
Loreda Chiaro

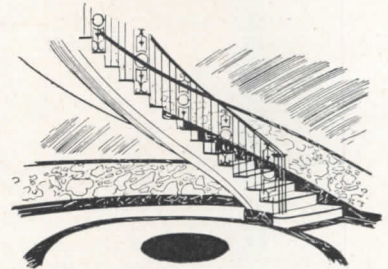

MARBLE IN YOUR STAIRWAY AND FLOOR

Suggestions:

Travertine
Belgian Black
Breche Oriental
Peruvian Rose

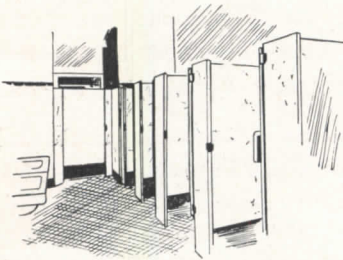

MARBLE IN YOUR TOILET ROOMS

Suggestions:

Vermont Metawee
Vermont Standard White
White Italian
Neshobe Gray

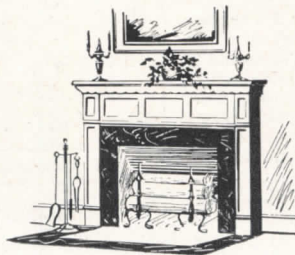

MARBLE IN YOUR HOME

Suggestions:

Vermont Oriental
Italian Black and Gold
Blue Belge
Statuary Vein Italian

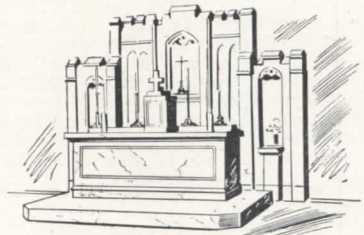

MARBLE IN YOUR CHURCH

Suggestions:

Italian Blanco P
Italian Crema
Rouge de Neuville Griotte
Verte Imperial

Since the end of the war we have imported more than twenty-five of the most popular selections of marble. As facilities in foreign lands are rebuilt, our choice of material will become much wider. When free scope is again allowed the construction industry, our reliable American quarries, mills, finishing plants and contracting organization—teamed with foreign production—will give you a complete service.

VERMONT
Enduring Beauty
MARBLE

VERMONT MARBLE COMPANY, PROCTOR, VT.

Boston • Chicago • Cleveland • Dallas • Los Angeles • New York • Philadelphia • San Francisco • Houston • Ontario Marble Co., Peterborough, Ont.



HOMASOTE gets a letter

President
Homasote Company
Fernwood Road
Trenton, New Jersey
Dear Sir: —

Long Branch, New Jersey
October 22, 1947.

I am one of 56 men who constructed and then lived in the Byrd Expedition buildings (at Little America, Antarctica for over a year in 1934-35) which were assembled from Homasote lined sections left over from the establishment of the first Little America in 1929. These sections were already the veterans of five years' storage in damp New Zealand warehouses, but were still so strong and easy to saw, fit, and assemble that we were considerably surprised. But when we had dug down to the old camp and found also that the Homasote in the original buildings was in perfect condition after one year of soaking in melted snow (1929-30) and five years under the terrific pressure of 20 feet of ice, we were completely sold. When other wallboards would have pulped, cracked or dissolved, Homasote remained firm and trustworthy insulation against blizzards and temperatures to minus 75!

I am not in the habit of using my few leisure hours to throw bouquets, I have too much to do, but I feel that merit deserves reward, so here goes — believe it or not, the above remarks are pale into obscurity by my present opinion of your fine product. When, as a technical observer, on the recently concluded Navy "Operation Highjump", I was one of the few who were privileged to dig down 12 feet to our old home 10 miles from the newest camp-site. I found the 18 year old Homasote in the walls and ceilings of the "Messhall" and "Science Lab" (the only buildings we could reach) absolutely unharmed by time, water, or cold. Hundreds of tons of ice had forced up the wood floors and pushed down the ceilings until they met in the center of the rooms, and puddles of ice everywhere evidenced the repeated freezing and thawing of the many seasons, but the walls were straight, unbuckled and scarcely stained.

Later, when our Expedition was leaving for its return to the States (February, 1947) and I had occasion to make one last run to the old camp to mark the entrances against the future, I hacked out a piece of the messhall wall to send to you for analysis. I am mailing it to you for whatever purpose you may wish to use it, and if you ever want me to convince some doubting customer of yours, just lead me to him. At least I can assure you that when at last I build the home I've been planning throughout several years of roaming the world, the insulation will emphatically be Homasote.

Yours sincerely,
Amory H. Waite, Jr.

Amory H. Waite, Jr.
Radio Engineer
BAE II 1934-35 and 1946-47

P.S. I forgot one item. When I was carrying your specimen up the rope ladder from the whaleboat to the ship, it fell out of my pack and drifted away to sea. To my amazement its generation-old water-proofing qualities were still intact for it kept floating! Another boat speared it with a boat hook an hour later and returned it to me, punctured, but still definitely useable wallboard. The hole, therefore, is a badge of honor rather than a defect.

AHW

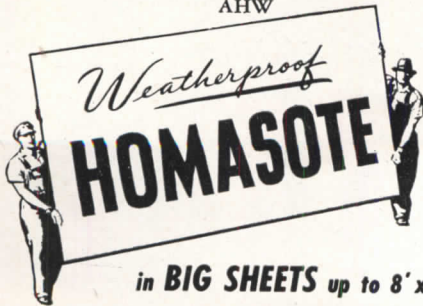

HOMASOTE COMPANY, Trenton 3, N. J.

EMPLOYMENT OPPORTUNITIES AVAILABLE

Advertising rates on request

HELP WANTED: Bldg. Specif. writers for arch. work — perm. Civil Service \$395 & \$440 mo. Annual increases, Sick Leave, Retirement, L.A. County Civil Service, Rm. 102, Hall of Records, Los Angeles 12, Calif.

WANTED: Architectural Draftsman with structural design and outside supervision experience by booming practice commanding wide variety work over vast construction-conscious area. Give places and length of experience, education, age, marital status, salary desired, etc. in brief. Submit sample of work if convenient. Charles A. Pearson, Jr., A.I.A., Architect, Associated Architects and Engineers, Radford, Virginia.

ARCHITECTURAL DESIGNER-DRAFTSMAN: Must be registered. Experienced in public buildings, schools, hospitals and functional design of industrial buildings. Excellent opportunity for hard working and sober man. All replies confidential. P. O. Box 2192, Atlanta 1, Ga.

YOUNG ARCHITECT, licensed by State and N.C.A.R.B., desires partnership or promise of future partnership with progressive Los Angeles firm. Highly competent designer with structural background. Experienced in rendering, drafting, specification writing, and supervision. Would make excellent office manager for principal who desires free time to enlarge his clientel. Box 292, ARCHITECTURAL RECORD, 119 W. 40th St., New York 18.

ARCHITECTURAL DESIGNERS: Draftsmen with experience and initiative. Good long range opportunities. Box 294, ARCHITECTURAL RECORD, 119 W. 40th St., New York 18.

ARCHITECTURAL DRAFTSMEN, SPEC. WRITER, SUPT. Good all around men able to handle entire project. Large variety of work, Com'l, Ind. & Inst. Good salary ranging from \$100-150 per week. Several years' work in sight. Location South. The Engineering Agency, Inc., Est. 1893, 53 W. Jackson Blvd., Chicago 4, Illinois.

WANTED: Architect experienced in commercial and industrial work. Eligible for New York registration. Opportunity for membership in metropolitan New York firm. Describe experience in detail and salary desired. Box 296, ARCHITECTURAL RECORD, 119 W. 40th St., New York 18.

ARCHITECTURAL DRAFTSMAN: Capable of designing and executing complete working drawings and details. One experienced in store layouts and fixture preferred. State qualifications in detail and salary requirements. Woodward & Lothrop, Washington 13, D. C.

WANTED: Architectural draftsman, preferably one with experience in design of industrial and commercial structures. Excellent opportunity to affiliate with growing organization. Write giving full particulars. Victor W. Buhr Associates, Engineers, Salisbury, Maryland.

What's the long-term story on insulation costs?

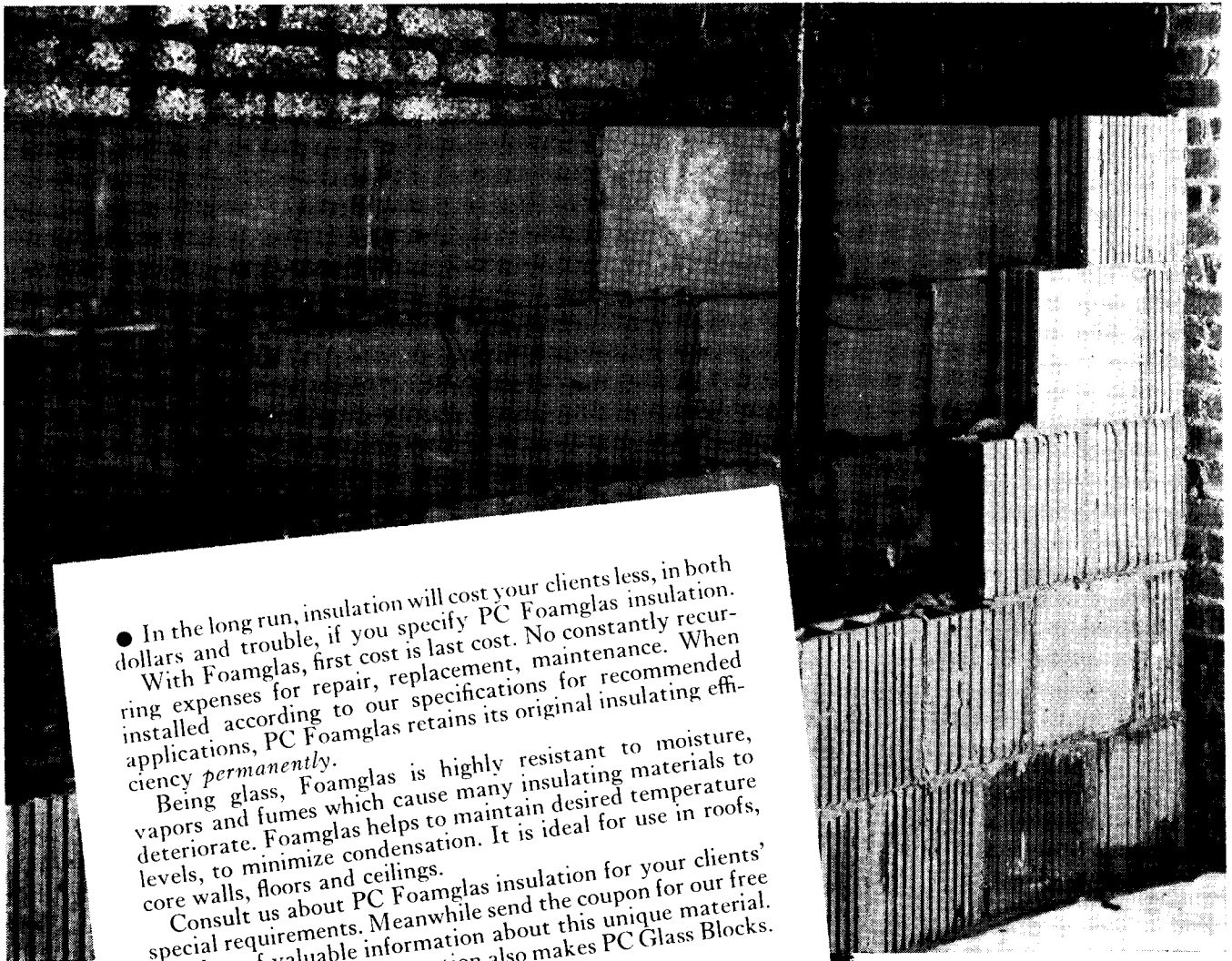

● In the long run, insulation will cost your clients less, in both dollars and trouble, if you specify PC Foamglas insulation. With Foamglas, first cost is last cost. No constantly recurring expenses for repair, replacement, maintenance. When installed according to our specifications for recommended applications, PC Foamglas retains its original insulating efficiency *permanently*.

Being glass, Foamglas is highly resistant to moisture, vapors and fumes which cause many insulating materials to deteriorate. Foamglas helps to maintain desired temperature levels, to minimize condensation. It is ideal for use in roofs, core walls, floors and ceilings.

Consult us about PC Foamglas insulation for your clients' special requirements. Meanwhile send the coupon for our free booklets of valuable information about this unique material. Pittsburgh Corning Corporation also makes PC Glass Blocks.

When you insulate with **FOAMGLAS**
you insulate **FOR GOOD.**

WHEN WALLS ARE INSULATED with PC Foamglas, the material can be easily cut to fit around pipes, conduits and other obstructions. In core walls of all sorts of buildings, PC Foamglas minimizes condensation, reduces heat loss, eases the load on heating and air-conditioning equipment.



THE MAGNIFIED CROSS SECTION of PC Foamglas shows its cellular construction. It is literally a foam of glass, solidified into big, strong, rigid blocks. In the millions of minute cells of glass-enclosed air, lies the secret of its permanent insulating value.

Pittsburgh Corning Corporation
Room 409-8, 632 Duquesne Way
Pittsburgh 22, Pa.

Please send me without obligation, your free booklets on the use of PC Foamglas insulation for:

Roofs..... Walls..... Floors.....

Name.....

Address.....

City..... State.....



FOAMGLAS INSULATION

FOR ADDITIONAL INFORMATION SEE OUR INSERTS IN SWEET'S CATALOGS.

INDESTRUCTIBLE!

Here's proof of the fact that LALLY COLUMNS are virtually indestructible. The intense heat from an oil fire at the Standard Oil Company Plant in Brooklyn buckled the steel beams while LALLY COLUMNS remained rigid. Underwriters' Laboratories tests show that GENUINE LALLY COLUMNS withstand heat 2½ times greater than Structural "H" Columns can stand.

In planning for strength and durability be sure to specify GENUINE LALLY COLUMNS in your current and future projects.

CATALOG UPON REQUEST

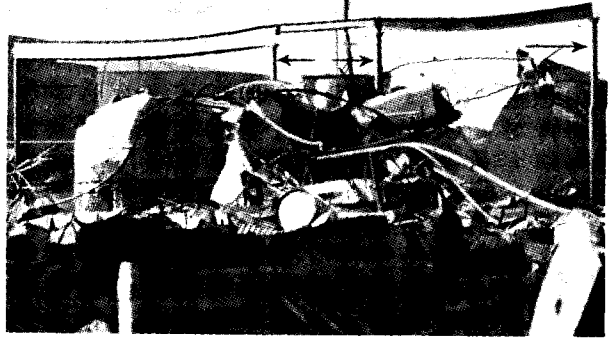

When fire razed the Standard Oil Company Plant in Brooklyn, all that remained standing were the GENUINE LALLY COLUMNS.



LALLY COLUMN COMPANY

Originators, Sole Manufacturers, Genuine Lally Columns

Erie and Albany Sts.
Cambridge 39, Mass.

211 Lombardy St.
Brooklyn 22, N. Y.

733 West 64 St.
Chicago 21, Ill.

Eye-light

YOUR MERCHANDISE

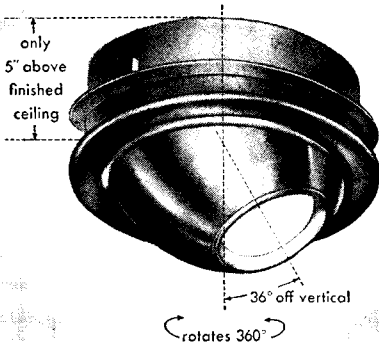

Cat. No. 351, semi-recessed eyeball. \$36
(150 watt reflector bulb)

CENTURY Lighting Equipment is ENGINEERED Lighting Equipment

CENTURY LIGHTING INC.

419 West 55th Street, New York - 626 N. Robertson Blvd, Los Angeles

This ADDING MACHINE Adds and Subtracts FEET and INCHES!



No other
ADDING MACHINE
matches ALL of Addometer's Advantages

Handiest helper on construction jobs you ever saw! Adds, subtracts FEET AND INCHES and 1/8 fractions quickly, accurately — right on the job. Only 11½ x 2½ in. size, weighs 14 oz.; 8-column capacity; single stroke dial clearance. Also adds dollars and cents up to \$10,000.00.

"Can't Do Without It," Users Say—Contractors, architects, engineers highly praise Addometer's advantages — thousands in daily use.

Money-Back GUARANTEE—The Addometer is yours for only \$12.95, postage prepaid — 10-day money-back guarantee if not fully satisfied. Descriptive folder on request — or, send check or money order NOW.



Reliable Typewriter & Adding Machine Co.

Dept. L-1, 303 W. Monroe St., Chicago 6, Ill.

Inside ...

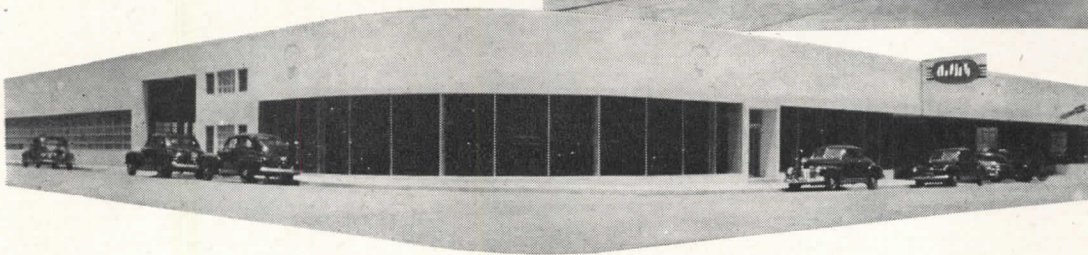

Bird-Kultgen Ford Sales & Service Building, Waco, Texas. Engineer and Architect, H. L. Spicer; Contractor, C. C. Ramsey; Concrete furnished by Waco Ready Mix Concrete Co. and Clark Transit Mix Concrete Co., all of Waco, Texas.

... and out

"... well pleased with Duraplastic in every respect," reports contractor

And he goes on to say that he particularly liked the ease with which Duraplastic concrete was placed and finished.

Characteristically, Atlas Duraplastic air-entraining portland cement required less water. It provided better workability and placeability. It made a more plastic, more uniform and more cohesive mix. Bleeding and segregation were reduced. There were no "honeycomb" spots or streaks.

These advantages are typical of Duraplastic's performance—whether for paving, structural or

mass concrete. Its use requires no unusual changes in methods—just the same good workmanship and careful supervision regularly employed.

Duraplastic complies with ASTM and Federal specifications... sells at the same price as regular cement... makes better concrete at no extra cost.

Send for further information. Write to Universal Atlas Cement Company (United States Steel Corporation Subsidiary), Chrysler Building, New York 17, N. Y.

OFFICES: Albany, Birmingham, Boston, Chicago, Cleveland, Dayton, Des Moines, Duluth, Kansas City, Minneapolis, New York, Philadelphia, Pittsburgh, St. Louis, Waco.

AR-D-56

ATLAS DURAPLASTIC

AIR-ENTRAINING PORTLAND CEMENT

MAKES BETTER CONCRETE AT NO EXTRA COST

TRADE MARK REG.
U. A. C. CO.



"THE THEATRE GUILD ON THE AIR"—Sponsored by U. S. Steel Subsidiaries—Sunday Evenings—ABC Network

At your Service!

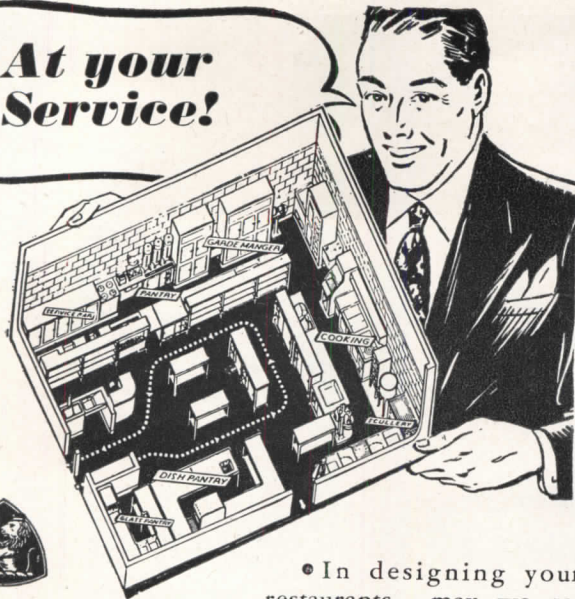

• In designing your restaurants — may we remind you that Nathan Straus-Duparquet's food service engineers are at your service — to assist you in your kitchen and cafeteria problems.

Ninety years of experience has proven Duparquet's superior design and equipment.

CHINAWARE • SILVERWARE • GLASSWARE • DUPARQUET KITCHEN EQUIPMENT • REFRIGERATION • FURNITURE & FURNISHINGS • UTENSILS

NATHAN STRAUS-DUPARQUET, INC.

33 East 17th Street, New York 3, N. Y.

BOSTON • NEW HAVEN • CHICAGO • MIAMI

DependABLE

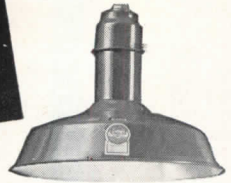

RLM STANDARD DOME



DEEP BOWL

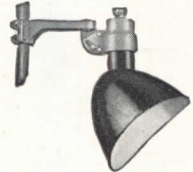

OPEN TYPE FLOODLIGHT



SIGN REFLECTOR

Abolite Reflectors and floodlights are recognized throughout the lighting field for flawless construction, durability, ease of installation and maintenance. With designs and shapes to conform to RLM standards and every lighting requirement, these reflectors have thousands of applications in industry for factory, yard, playground, protective and sign lighting.

Made of finest quality porcelain on steel, Abolite reflectors are easy to clean and provide efficient and economical lighting. Complete line includes all types of popular reflector shapes designed for every kind of installation. Sold only through wholesalers.



THE JONES METAL PRODUCTS CO.
WEST LAFAYETTE, OHIO

STOP that **WATER** with **FORMULA # 640**

A Clear Liquid Waterproofing for Old or New Construction

PENETRATES deeply—one inch or more—is not a surface treatment. Brush, spray, or float on stone, cast stone, concrete, mortar, stucco, tile, brick, plaster, wood, wall board — any absorbent material.

WATERPROOFS, preserves, prevents dusting of floors, surface dirt washes away in rain.

FORMULA No. 640 is a balanced formula of seven different waxes and resins in a hydrocarbon solvent.

ACID-ALKALI proof — does not oxidize, unchanged by temperature.

PERFORMANCE — It is our opinion it will last as long as the concrete, mortar, stucco, etc., lasts.

OIL PAINT saponifies on cement unless sealed first with Formula No. 640.

APPLY to either side: **The pressure side, or opposite side** — it is equally effective.

HYDROSTATIC PRESSURE — A 20 foot head has been held by Formula No. 640.

CUTS WATERPROOFING COSTS because it applies three times as fast as paint, requires no special technique. No preparation — comes ready to apply. Eliminates necessity of furring. Concrete floors and walls need no membraning.

KEEPS IN ALL CLIMATES • **HARMLESS TO USE**
GOOD COVERAGE • **MODERATE PRICE**

WRITE OUR ENGINEERING DEPARTMENT for office test kit, technical data, or regarding any special problem.
J. Wilbur Haynes, Engineer

OTHER PRODUCTS: Formula No. 640 Toxic, combines waterproofing with termite and fungus protection; cement hardener; cement paint; floor mastic; roof coatings, etc.

HAYNES PRODUCTS CO.
4007 FARNAM STREET • OMAHA 3, NEBRASKA



What's funny about building?

THE LAST LATH!

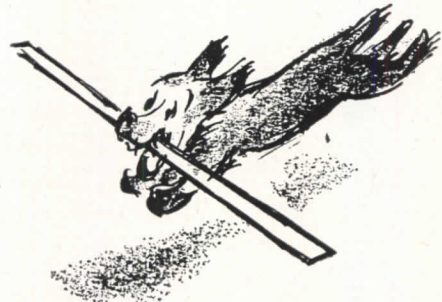

Now in book form:

All of Alan Dunn's cartoons from Architectural Record

... and a bonus of new ones besides — 96 pages of architectural comedy to skyrocket morale all along the line from the drafting room to the clients in the outer office. Don't miss the fun; mail the coupon today!

ARCHITECTURAL RECORD BOOK DEPT.
119 West 40th Street, New York 18, N. Y.

I want THE LAST LATH! My check for \$2.50 is enclosed. (\$2.55, with 2% sales tax, for New York City deliveries.)

Name.....

Address.....

City..... Zone..... State.....

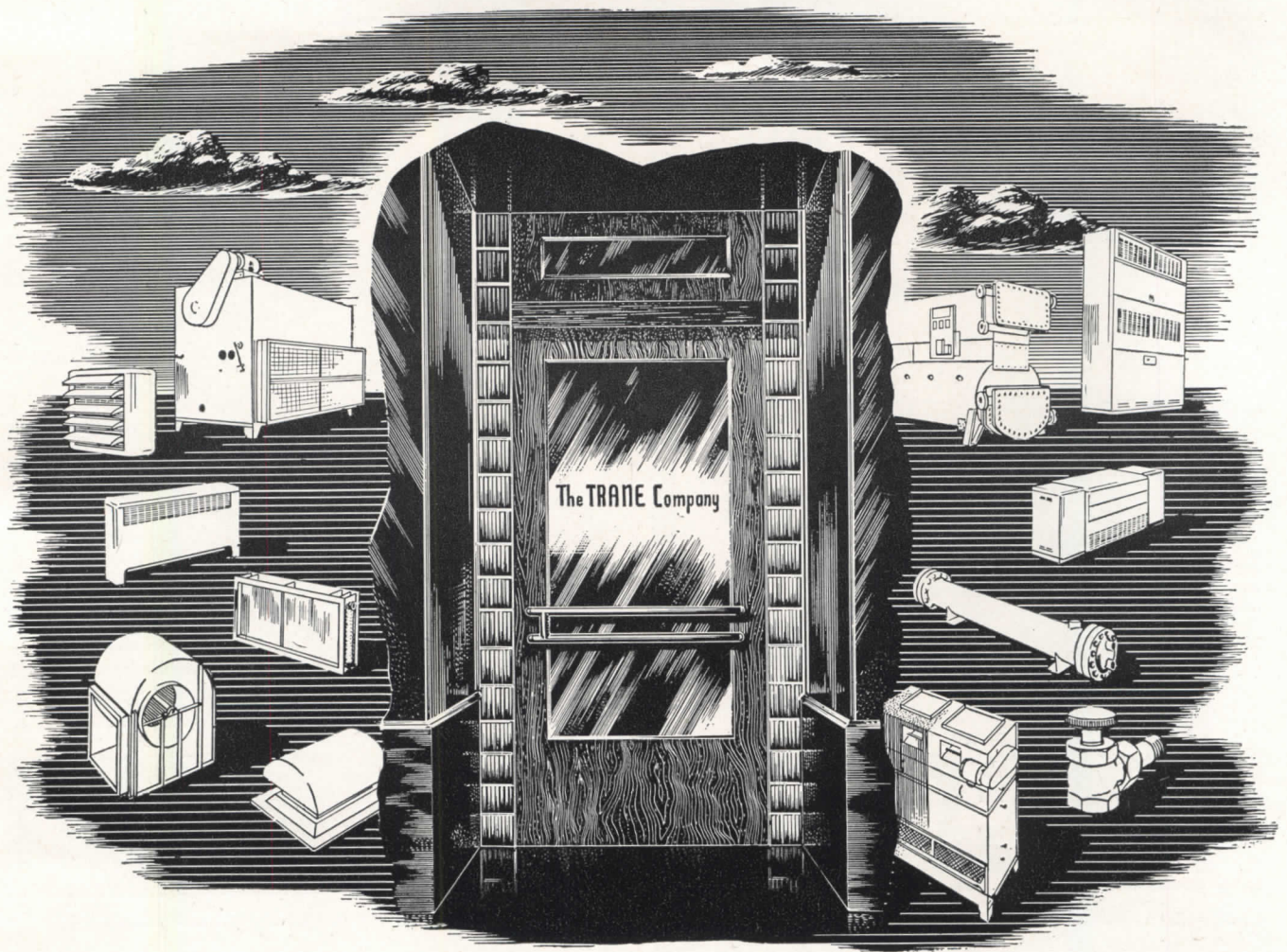

Trane Heating and Air Conditioning Is as Near as Your Telephone

Trane Engineered Air Conditioning—which refers to heating as well as cooling—stands for a complete line of engineered products. Each unit is developed and built by manufacturing engineers. Each is designed to work together with every other, for systems that function with the balance of matched components.

In addition, Trane product engineering extends to the drafting boards of architects, engineers, and contractors, where Trane Field Engineers cooperate in the application of Trane products and systems. Many of these field engineers are alumni of the Trane Student Class—an organization which each year trains outstanding

engineering graduates in the problems of heating and air conditioning.

Because Trane manufactures a *complete* line of products, entire Trane heating and air conditioning systems are possible. There is a Trane Field Engineer within a few hours of any part of the country to work together with architect, engineer, and contractor in designing Trane systems.

The Convector-radiator—modern successor to the old-fashioned cast iron radiator—has been engineered by Trane for universal application to steam and hot water heating systems, and is being produced in quantity so you can now secure it from local distributors' stocks.

TRANE

Manufacturing Engineers of Equipment for
HEATING AND AIR CONDITIONING

THE TRANE COMPANY, LA CROSSE, WISCONSIN • Also TRANE COMPANY OF CANADA, LTD., TORONTO, ONTARIO



natcor
METAL FOR STORE FRONTS
FULLY EXTRUDED
ALUMILITED ALUMINUM

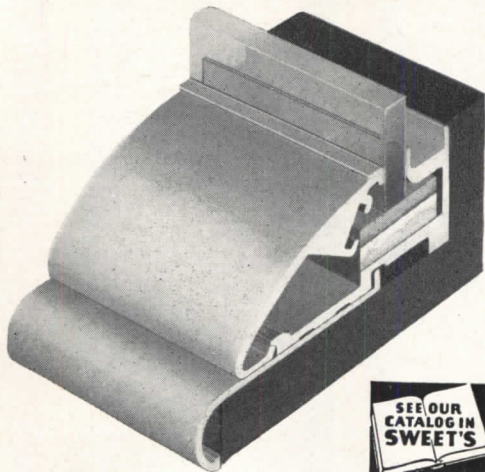

FOR DETAILS WRITE

natcor **STORE FRONTS**
 PROVIDENCE 9
 RHODE ISLAND

LONE STAR CEMENTS

COVER EVERY CONSTRUCTION NEED



LONE STAR PORTLAND CEMENT

for concrete of outstanding quality in all types of construction

'INCOR' 24-HOUR CEMENT

America's FIRST high early strength Portland Cement—saves time, cuts costs

LONE STAR MASONRY CEMENT

The modern masonry cement, for really great job performance

*Reg. U. S. Pat. Off.

LONE STAR CEMENT CORPORATION

Offices: Albany • Birmingham • Boston • Chicago • Dallas • Houston
 Indianapolis • Jackson, Miss. • Kansas City, Mo. • New Orleans • New York
 Norfolk • Philadelphia • St. Louis • Washington, D. C.

FITZGIBBONS

The right steel boiler in any size

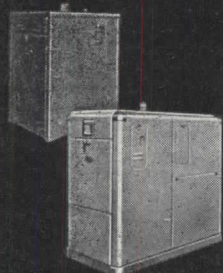

Make it a Fitzgibbons and be sure, whether to heat a modest cottage or a towering sky-scraper. Be sure of full heating comfort, of vital savings in fuel cost, of a boiler that works in harmony with any good oil burner, gas burner, stoker, or gives full hand-fired satisfaction. Be sure, with a boiler that is A.S.M.E. constructed, Hartford inspected, S.B.I. rated, and with sixty continuous years of successful boiler building behind it. Check with your local Fitzgibbons engineer—or write us direct.

- 400 SERIES for modest homes
- OIL-EIGHTY for medium size homes
- R-Z-U JUNIOR for large residences and apartment buildings
- D-TYPE for institutional and office buildings, hospitals, theatres, etc.



Fitzgibbons Boiler Company, Inc. 101 PARK AVE. NEW YORK 17, N. Y.

Every Architect should have these STEWART CATALOGS

- Catalog 82, Standard Iron Fences (with Channel Rails, Gates and Arches)
- Catalog 80, Standard Iron Fences (with Angle Rails)
- Catalog 83, Standard Chain Link Wire Fences and Gates
- Catalog R-38, Railings, Pier Lanterns, Interior Gates, Veranda Work, etc.
- Catalog W-40, Window Guards, Wire Mesh Partitions, Folding Gates, etc.
- Catalog I-42, Industrial Fence Specifications Manual

These catalogs contain complete information on Stewart Iron and Wire Products. Check your file of Stewart literature. If you do not have all the catalogs listed above, we shall be glad to send them to you. Stewart also manufactures the following jail and prison equipment: Steel Cells, Bunks, Hinge and Sliding Type Doors, Locks and Locking Devices, Iron Stairways, Gratings, etc. Complete information on request.

Stewart IRON and WIRE THE STEWART IRON WORKS CO., Inc.
 1565 Stewart Block CINCINNATI 1, O.

.....

Experience that covers 27,000 buildings

leads this architect to endorse Petro

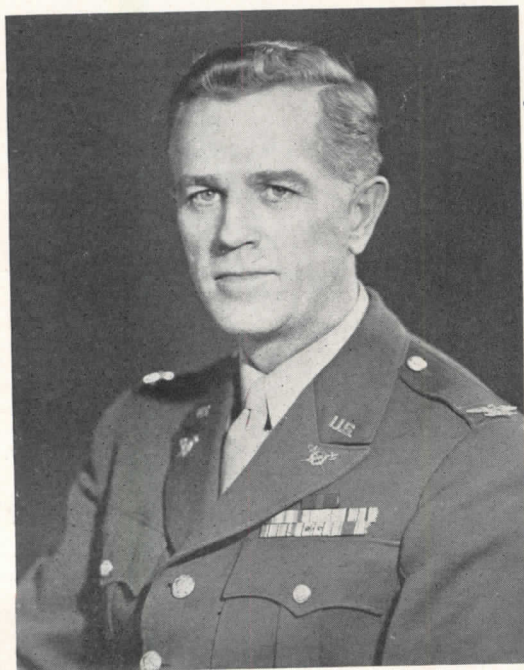

More than 27,000 private homes, as well as many theatres and industrial structures, have been based on plans drawn up by Colonel Arthur E. Allen, nationally known architect of Jamaica, Long Island. His experience also includes five and a half years of designing and inspecting army cantonments, hospitals and industrial installations.

"The advancements under pressure in war building," says Colonel Allen, "necessitated the sturdiest equipment possible, requiring the least amount of attention. In oil heating systems for peace-time building, these requirements are still essential for continuous, efficient operation with minimum maintenance.

"From my experience, I heartily endorse Petro Oil Burning Systems for most satisfactory results, for low upkeep cost, and for high efficiency."

.....

Why are so many experienced architects and engineers enthusiastic in endorsing Petro Oil Burning Systems? It's because these men — of whom Colonel Allen is typical — have for a long time known Petro's reliable, minimum-maintenance performance. And their judgement has over the years been repeatedly confirmed by their clients' complete satisfaction.

This leadership in the field of fine oil burning equipment stems from more than 40 years' specialization in oil heating. Today Petro's soundly-engineered, service-tested design provides the maximum heat from every drop of fuel oil. And its sturdy construction, too, assures the day-to-day dependability that lowers heating upkeep costs.

When *you* specify Petro oil-fired equipment, your confidence is never misplaced. You can be certain every time that your client will echo Colonel Allen's endorsement of Petro "for most satisfactory results, for low upkeep cost, and for high efficiency."

INDUSTRIAL MODELS: No. 5 or No. 6 fuel oil; manual, semi-automatic or automatic operation; 8 sizes to 450 bhp. Thermal Viscosity preheating.

DOMESTIC MODELS: No. 3 or lighter oils; "conversion" and combination-unit types, 7 sizes. Patented "Tubular Atomization."

FULL DATA on Petro Industrial Burners are in catalog files of Sweet's, and Domestic Engineering. Details on Petro Domestic Burners available in separate catalog. Copy of either sent gladly on request.

PETRO
REG. U.S. PAT. OFF.
cuts steam costs

PETROLEUM HEAT AND POWER CO. • Makers of Good Oil Burning Equipment Since 1903 • Stamford, Connecticut

TRUE DIFFUSION

with the New **HONEYWELL**
AIR
CONDITIONING **REGISTER**

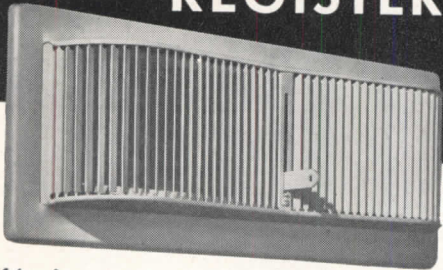

SIX Important New Features!

1. Smart new functional design
2. No streaks on walls and ceilings
3. Installation costs drastically cut
4. Balancing becomes quick one man job
5. Branch quadrants eliminated
6. Manual shut-off aids fuel saving

MINNEAPOLIS-HONEYWELL REGULATOR CO.

2600 FOURTH AVENUE SOUTH • MINNEAPOLIS 8, MINN.

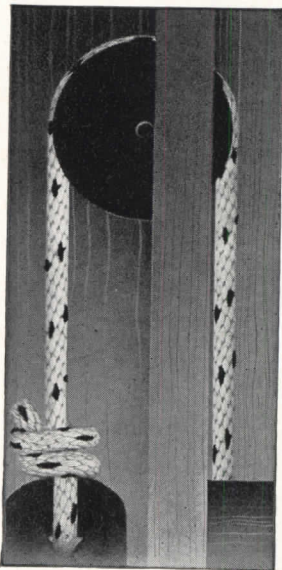

BALANCE

perfect and permanent

The counter weight method of mechanical balance is fundamental in principle—it is permanent because the law of gravity is unchanging. Double hung windows with cord, pulley and counter weight are permanently satisfactory—require no adjustments and with Spot Sash Cord give years of trouble-proof, expense-free service. Architects specify and builders prefer Spot Sash Cord—identified by Colored Spots (Reg. U. S. Pat. Off.)

SAMSON CORDAGE WORKS — BOSTON, MASS.

Available Now!

CHENEY
FLASHING

3-Way Bond

16 OZ. COPPER

CHENEY
FLASHING
REGLET

16 OZ. COPPER

WRITE FOR
DESCRIPTIVE FOLDER Dept. R

CHENEY INDUSTRIES, Trenton, N. J.

*SO WE MADE 3 GYMS
in ONE!*

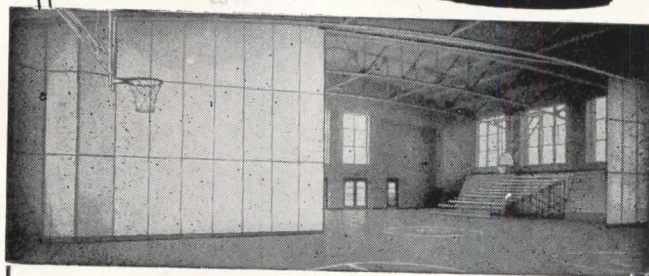

**HORN FOLDING
PARTITIONS
HORN FOLDING
BLEACHERS**

FOR COMPLETE INFORMATION WRITE

HORN BROTHERS CO.

FORT DODGE, IOWA

ESTABLISHED 1909



Architect : Slifer & Cone, St. Paul.
 General Contractors : Anderson & Sweitzer Co., St. Paul.

NEW DORMITORY AT HAMLIN UNIVERSITY HAS *OPEN-WEB JOISTS*

This is the Charles M. Drew Residence for Men—a new addition to the tree-studded campus of 98-year-old Hamline University at St. Paul. It is a three-story structure containing sixty-five double and ten single rooms. Used in its floor and roof construction were 84 tons of Bethlehem Open-Web Joists.

All types of light-occupancy structures—whether dormitories, apartments, hospitals or schools—become better, safer buildings when Bethlehem Open-Web Joists are used. Combined with concrete floor slab and plaster ceiling, these joists provide an eco-

nomical floor construction which prevents the spread of fire for at least two hours. In addition they eliminate shrinking and sagging floors and open baseboards; they minimize the passage of sound from floor to floor; they are immune to damage by termites.

Bethlehem Open-Web Joists help speed construction, too, as they permit pipes and conduits to be run through the open webs. They arrive at the job completely fabricated, ready for use without falsework. Two men can easily handle the standard-type joist, and a light gin pole is all that's

required to swing the Longspan type of joist into place.

Our illustrated 36-page joist catalog contains information which will be of help to you in designing with open-web joists. Ask for a copy. Either contact the nearest Bethlehem district office, or write to us at Bethlehem, Pa.

BETHLEHEM STEEL COMPANY
 BETHLEHEM, PA.

On the Pacific Coast Bethlehem products are sold by
 Bethlehem Pacific Coast Steel Corporation
 Export Distributor: Bethlehem Steel Export Corporation

BETHLEHEM OPEN-WEB JOISTS

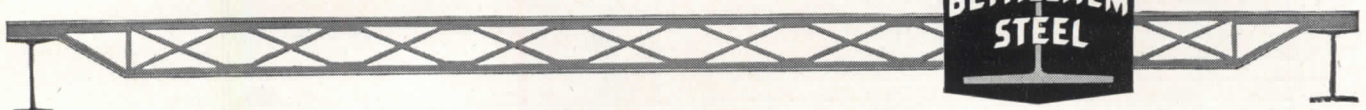

This is Your Copy of

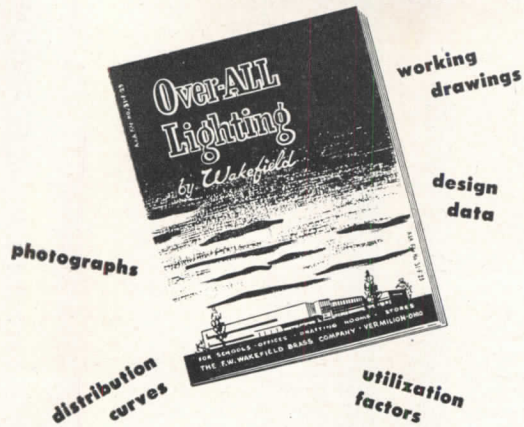

Ready for your file—a modern fully illustrated factually written catalog devoted to the achievement of efficient visual environments for offices, drafting rooms, schools and stores through the use of finely engineered lighting equipment. Write today and your copy will be on its way.

THE F. W. *Wakefield* BRASS COMPANY
VERMILION, OHIO

Lockwood

IDENTIFIES QUALITY
IN BUILDERS' HARDWARE

LOCKWOOD identifies its Builders' Hardware with this famous Trade Mark. You will find it on cylinder locks and keys, on mortise locks, on door closers . . . a symbol of enduring quality since 1882.

To the Architect the name LOCKWOOD also signifies a line of Builders' Hardware embracing all requirements, characterized by steady advancement in feature and design . . . and a company that never hesitates to give full and prompt co-operation.

We aim to keep it that way.

R-1

LOCKWOOD HARDWARE MFG. COMPANY

Division of Independent Lock Company

Fitchburg • Massachusetts

An Organ Builder Testifies: "... there are no finer Chimes available today, regardless of price or manufacturer"

"It is my honest opinion, both as an organist and organ technician, that there are no finer Chimes available today, regardless of price or manufacturer. Their tone is pure and flawless; devoid of 'stray' harmonics and unwanted overtones, their action is quick and reliable year in and year out.

"Six years ago I decided to donate a set of Chimes to the Church in which I play, as a memorial to my Mother. I carefully investigated, tried and compared practically every well-known make of Chimes and finally settled my choice on Maas. I have never regretted the choice."

JOHN M. MARKOE
Bloomfield, N. J.

Maas dealers everywhere are eager to show you how the Maas Chimes can be installed to best advantage and most economically in your church. . . . Let us send you descriptive information and the name of our dealer in your vicinity. (Specify type of organ you have)

MAAS CATHEDRAL CHIMES

Dept. 21, 3015 Casitas Ave.

Los Angeles 26, Calif.

WING *Revolving* **UNIT HEATERS**

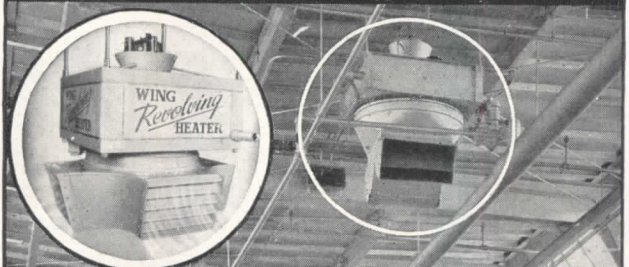

Only Revolving Discharge Gives the Ultimate in Uniform, Healthful Plant Heating

The Wing Revolving Unit Heater differs from every other unit heater on the market in its unique method of distributing the heated air. Instead of projecting the air in one or more streams in fixed directions, the slowly revolving discharge outlets of the Wing Revolving Heater distribute the heated air in constantly changing directions, covering the working area completely, uniformly and with a healthful, refreshing effect.

Write for a copy of Bulletin HR-5

L. J. WING MFG. CO.
151 West 14th Street
New York 11, N. Y.

WING PIONEERED AND DEVELOPED THE OVERHEAD VERTICAL DOWNWARD DISCHARGE UNIT HEATER

STAINLESS STEEL

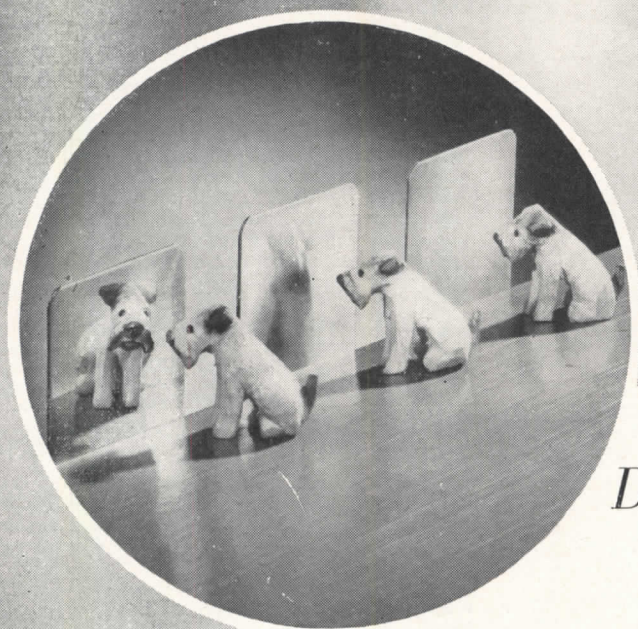

*Doggone,
It's a Mirror!*

You're right, Sport! It's a piece of mirror-finish stainless steel—the kind that makes permanently brilliant decorative work and trim. Your friend, next in line, is looking at a Number 4 polished sample—a good, all-around lustrous finish. And your other canine pal is checking the Number 1 finish—commonly used for technical applications. These are just three of stainless steel's six standard mill finishes—attractive, durable finishes to spruce up any product, or workable finishes for any fabrication job. For up-to-date news of the uses of stainless steel, write to Department A-1 for our monthly publication ELECTROMET REVIEW.

ELECTRO METALLURGICAL COMPANY

Unit of Union Carbide and Carbon Corporation
30 East 42nd Street  New York 17, N. Y.

PRODUCERS OF ALLOYS THAT MAKE STEEL STAINLESS

Beautiful Enduring Strong Tough



NEW BOOKLET SHOWS HOW TO ELIMINATE LOADING DOCKS

Write now for new Rotary Catalog RE-202. It shows how to cross loading docks and ramps off your plans by specifying Levelator Lifts for modern buildings. Floors can be poured on grade instead of at railway car or truck bed height. You can streamline building designs. Levelators lift loads by dependable oil hydraulic power. Installation simple and inexpensive.

ROTARY LIFT CO., 1101 Kentucky, Memphis 2, Tenn.

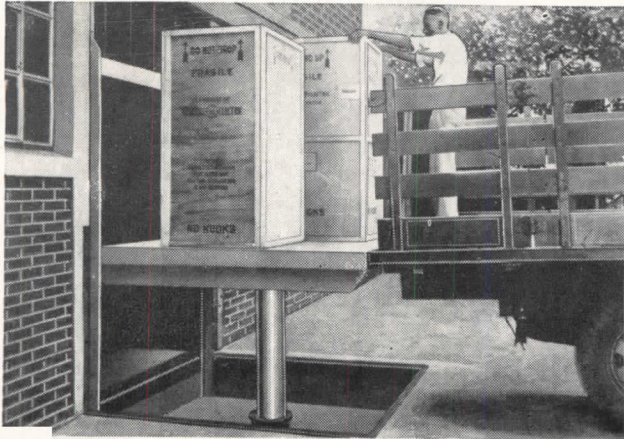

Rotary LEVELATOR LIFTS

*Reg. U. S. Pat. Ofc.

The **COLOR** is here!

No more "fumbling" with colors! Time is saved, controversies are averted when you have the Moleta COLOR GUIDE. This handsome book is winning round-the-world honors . . . serving users in Europe, Arabia, Africa, China, all over the globe!

The Moleta COLOR GUIDE gives a page-by-page display of 150 beautiful colors . . . each tint from the palest to the darkest shown on a large page (9" x 15"). The correct mixing formula is given on the reverse of each page.

Write for your copy of the Moleta COLOR GUIDE
—\$5.00, delivered anywhere in the U. S. A.

MONROE, LEDERER & TAUSSIG, Inc.
606 N. American St., Phila. 23, Pa.

Moleta
ARCHITECTURAL

The Truly Washable
FLAT OIL PAINT



Now Available! COPPER ARMORED SISALKRAFT

Strong, flexible, easy to apply! For door and window flashing, as shown, 6-10-or 12 in. Copper Armored Sisalkraft in 1 oz. weight is recommended.

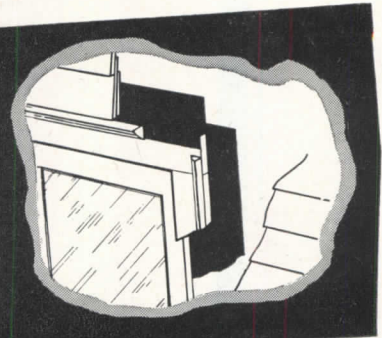

PURE COPPER PROTECTION at 1/5 the NORMAL COST!

Copper Armored Sisalkraft is pure electro deposit copper reinforced with thousands of crossed sisal fibres and bonded with two layers of special asphalt to heavy kraft paper. Uniform, lightweight, will not kink, break or tear. 100% impervious to moisture. For all concealed flashing and foundation damp-coursing. Available in 6" to 60" widths, copper weights of 1, 2 or 3 oz. per square foot.

Write for complete information.



The **SISALKRAFT Co.**

205 W. WACKER DRIVE DEPT. AR CHICAGO 6, ILLINOIS

For Distinctive Design in
ELECTRIC WATER COOLERS
... Specify *Haws*

HAWS Electric Water Coolers are styled to enhance the interiors of today's and tomorrow's buildings.

For office or lobby, for store or public building, **HAWS** Electric Water Coolers serve refreshing drinking water with complete sanitation...efficiently, dependably and economically. For the finest in Electric Water Coolers always specify...

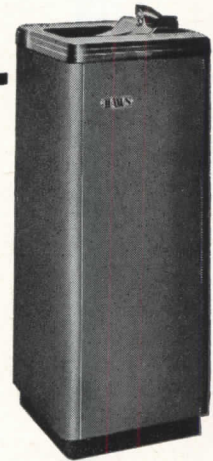

Model HT-10
Beautifully Styled Electric
Water Coolers

HAWS ELECTRIC WATER COOLERS
SANITARY DRINKING FOUNTAINS

HAWS DRINKING FAUCET CO.
1808 HARMON STREET (SINCE 1909) BERKELEY 3, CALIFORNIA
Agents and Sales Representatives in All Principal Cities

3-Way Protection for the buildings you design

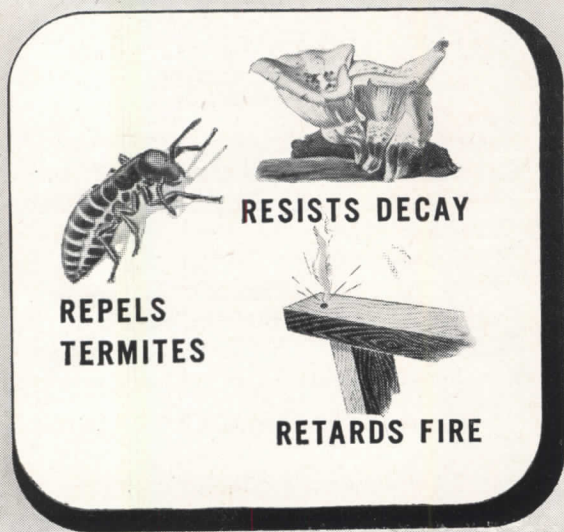

...with "CZC"-treated wood

You can give the buildings you design additional long life by including "CZC"-treated wood in your plans. Wood that has been pressure-impregnated with "CZC" resists decay, repels termites, and is resistant to fire.

"CZC"-treated wood is paintable, odorless, clean and safe to handle. It has all the advantages of untreated wood, plus these other life-extending features.

Wherever "CZC"-treated wood is used, maintenance costs are lower, safety is greater. Your clients will find that Du Pont Chromated Zinc Chloride pays for itself many times.

For additional information on this wood preservative that makes wood last longer, write E. I. du Pont de Nemours & Co. (Inc.), Grasselli Chemicals Department, Wilmington 98, Delaware.

DU PONT CZC

Chromated Zinc Chloride

MAKES WOOD RESIST DECAY • REPEL TERMITES • RETARD FIRE



BETTER THINGS FOR BETTER LIVING
... THROUGH CHEMISTRY

JANUARY 1948

Most Dependable Self-Operating Regulator Made

One of Our Many Types of Water Temperature Control

NO. 11 TEMPERATURE REGULATOR

POWERS

ENGINEERING SERVICE FOR WATER TEMPERATURE CONTROL

HOT WATER OUTLET
POWERS DIAL THERMOMETER
HOT WATER STORAGE HEATER
POWERS No. 11 REGULATOR
STEAM SUPPLY
STRAINER

When you have a problem requiring dependable regulation of water temperatures, consider the following advantages when you call Powers:

Over 55 Years of Experience gained in supplying temperature controls for almost every purpose in all types of buildings and industrial plants.

Most Complete Line of Controls Made—If you want control for closed or open tanks and vats . . . or if you want to thermostatically regulate the mixing of hot and cold water to deliver a mixture at a predetermined temperature . . . Powers can help you whether the flow of water is 1 gal. or 10,000 gals. per minute.

Service on Installed Equipment. With competent engineers in 47 cities, we are able to give prompt and efficient service whenever required . . .

CHICAGO 14, ILL. 2752 Greenview Avenue
NEW YORK 17, N. Y. 231 East 46th Street
LOS ANGELES 5, CAL. 1808 West Eighth Street

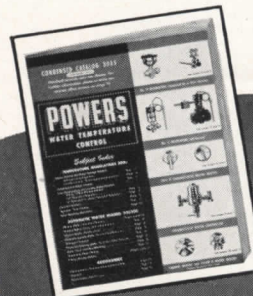

Phone or write for Catalog 3035

447A

THE **POWERS** REGULATOR COMPANY

Offices in 47 cities • See your phone book

Suntile offers you both

- BETTER TILE
- BETTER INSTALLATION

For better tile—better installation, let us send you the name of an Authorized Suntile Dealer. He can show you real clay Suntile in 16 wall colors. Also impervious unglazed ceramic mosaic Suntile in 15 colors—and Suntile Camargos in 10 colors—in modular sizes. See Sweet's Catalog for complete details.

COLOR BALANCED

Suntile

... Bright with color
 Right for life

The
 Cambridge Tile
 Manufacturing Co.
 CINCINNATI 15
 OHIO



U. S. MAIL CHUTES AND BOXES

are manufactured in a factory built by us for this exclusive purpose and equipped with special machinery, insuring uniformity and quality of product.

Every department of our business—from drafting room to the final installation—is in charge of men with years of experience in meeting Architects' wishes in the planning and execution of our work.

Catalog in Sweet's

ESTABLISHED 1893

Cutler Mail Chute Co

ROCHESTER 7, N. Y.

T-23 OIL HEATING PACKAGE SET

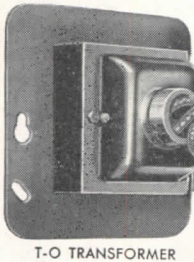

T-O TRANSFORMER

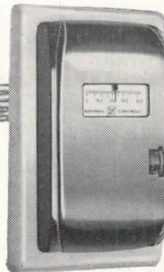

T-770 THERMOSTAT

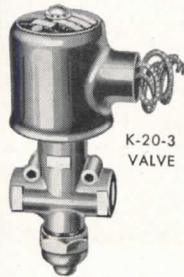

K-20-3 VALVE

THERMO
 CABLE

*Automatically Yours For
 Better Temperature Control*



GENERAL CONTROLS
 801 ALLEN AVENUE GLENDALE 1, CALIF.

FACTORY BRANCHES: BIRMINGHAM (3) BOSTON (16) CHICAGO (5) CLEVELAND (15) DALLAS (2)
 DENVER (10) DETROIT (8) HOUSTON (2) KANSAS CITY (2) NEW YORK (17) PHILADELPHIA (40)
 PITTSBURGH (22) SAN FRANCISCO (7) SEATTLE (1) • DISTRIBUTORS IN PRINCIPAL CITIES

MANUFACTURERS
 OF AUTOMATIC
 PRESSURE,
 TEMPERATURE
 & FLOW CONTROLS

WRITE FOR FREE DESCRIPTIVE LITERATURE

Now You Can Get FINE FINISHES on FIR PLYWOOD!



How? By specifying Firzite!

This remarkable new sealer... available in either Clear or White... does *three* jobs at once, to dress up Fir Plywood so that it's right at home in the best company:

1. **TAMES THE WILD GRAIN** so that a vivid, clashing grain figure becomes tasteful and subdued.
2. **LAYS THE WILD GRAIN** so that painted surfaces are satin-smooth. No "hills and valleys," due to grain-raise.
3. **SEALS THE SURFACE** so that face-checking is virtually eliminated.

AND FOR BLONDE, MODERN FINISHES, use White or Tinted Firzite, wiped off! For tints, merely add colors in oil to White Firzite. Also excellent for undercoats, because it *seals as it coats*.

WRITE FOR LITERATURE ON FIRZITE!

UNITED STATES PLYWOOD CORPORATION

Exclusive Distributors of Firzite

55 West 44th Street, New York 18, N. Y.

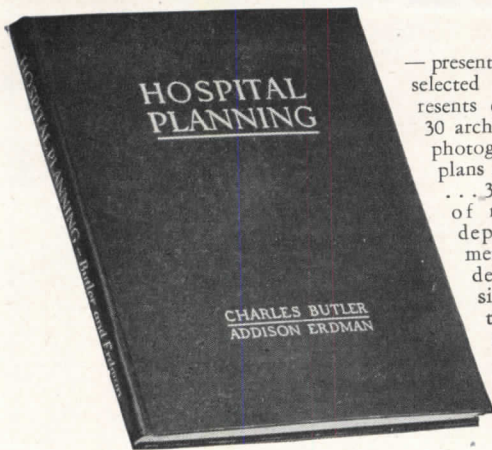

— presents the plans of 51 selected hospitals . . . represents creative efforts of 30 architects. Includes 32 photographs . . . 11 site plans . . . 187 floor plans . . . 38 special unit plans of rooms, wards, departments . . . numerous construction details. 236 pages, size 8½ x 11, illustrated and indexed, stiff cloth binding. Price \$15.

AGAIN AVAILABLE

HOSPITAL PLANNING

by **CHARLES BUTLER, F.A.I.A.**
and **ADDISON ERDMAN, A.I.A.**

“HOSPITAL PLANNING,” the first important textbook on the subject in a generation, offers a complete treatise on hospital architecture . . . gives a cross-section of the best in hospitals produced in this country within recent years . . . and provides exhaustive study and examination of new trends.

Messrs. Butler and Erdman, working as a team of specialists, have directed a nationwide, on-premise survey of hospital planning — in theory, in everyday practice and under the stress of unprecedented demands and emergencies. The most significant examples of hospital planning have been studied, assembled, abstracted and dramatized.

This 236-page volume is for architects and hospital groups alike. It will help architects and engineers to learn of the great advances made in hospital architecture . . . to acquire a working knowledge of hospital procedure . . . to avoid the many pitfalls which beset the hospital planner. It will help hospital administrators to visualize their problems in terms of community needs . . . show them how others are meeting similar problems. Price \$15, postage prepaid.

BOOK DEPARTMENT ARCHITECTURAL RECORD
119 West 40th Street, New York 18, New York

Enter my order for copies of the new, 1946 edition of “Hospital Planning” by Charles Butler and Addison Erdman, at the price of \$15. I enclose payment of \$
For New York City Delivery add 30 cents for Sales Tax — \$15.30 in all.

Name
Address
City Zone State

ALL COLORS
now available



We are now shipping all Kentile colors in quantities unlimited except by the dealers' individual allotments . . . including the previously scarce colors that use white pigment.

- Toledo Red (C-109)
- Veined Carnelian (C-206)
- Cippolino (C-214)
- Greek Skyros (C-221)
- Napoleon Gray (C-222)
- Genoa Green (C-244)
- Languedoc (C-257)
- Comblanchien (C-258)
- Grammont (C-260)
- Dog Tooth (C-268)
- Fleecy Cerulean (D-225)
- Travertine (D-247)
- Istrian (D-253)

DAVID E. KENNEDY, INC.

Brooklyn 15, N. Y. Chicago 54, Ill. Atlanta 3, Ga.
Boston 14, Mass. Kansas City 8, Mo. Cleveland 16, Ohio
San Francisco 3, Cal. Washington 6, D. C.

Presbyterian Church of Roseland
GEO. W. REPP, ARCHT.

AMERICAN SCISSORS TRUSSES 50 Ft. Span

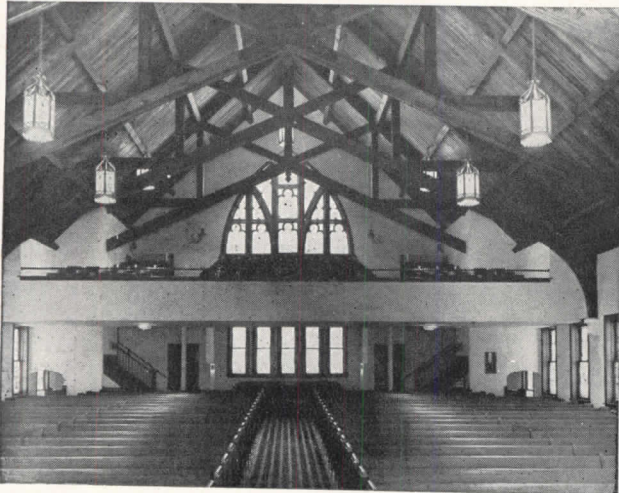

Church Trusses—any design

25th Anniversary  1922-1947

AMERICAN ROOF TRUSS CO.

Phone PLaza 1772
6846 STONY ISLAND AVE.
CHICAGO, 49

Phone ADams 1-4379
242 W. SANTA BARBARA AVE.
LOS ANGELES, 37



Getting 10 months
educational gains in
6 months by the
**Harmon
Technique**

The schools you design can do it, too!

Ask for a copy of Dr. Harmon's "LIGHT ON GROWING CHILDREN," reprinted from Architectural Record. On receipt of sketches showing dimensions and details of schoolroom, specifications will be furnished according to the Harmon Technique without cost or obligation.

NATIONAL CHEMICAL & MFG. CO.
3617 S. May Street, Chicago 9



LUMINALL the light-reflective
paint for interiors

FIRST INTRODUCED IN JUNE, '45
THIS

*New Development
in Radiant Heating*

HAS CREATED TREMENDOUS
PUBLIC INTEREST

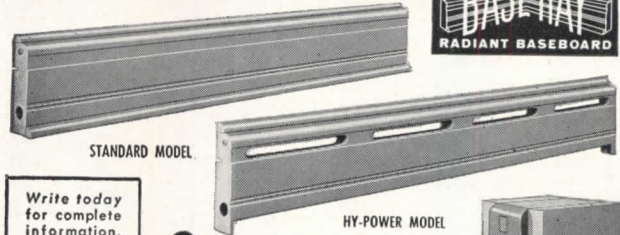

Write today
for complete
information.
You may be
asked about
BASE-RAY*
tomorrow.
*Reg. U. S. Pat. Off.

**Burnham
Corporation**
BOILERS and RADIATORS

IRVINGTON, N. Y.



MAKERS OF THE FAMOUS
YELLO-JACKET BOILER

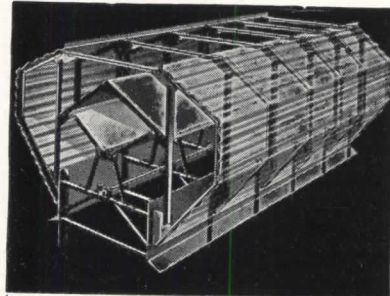
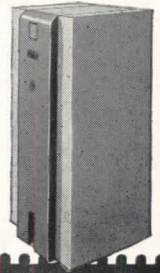

**BURT
MONOVENT
SUPPLIES**

**ARCHITECTURALLY CORRECT
EFFICIENT VENTILATION**

Unlike unit ventilators, Burt's Monovent Continuous Ridge Ventilator blends with roof and building lines. Installed in a continuous run along the roof ridge, the Monovent is inconspicuous, yet opens the roof like a gigantic valve to exhaust heat, fumes or smoke. Burt Monovent is weather-proof, simple and economical to operate and maintain. Proven in industry in installations from a foot to a thousand feet in length — from 4" to 96" throat sizes. See Sweet's or write for data and catalog sheets on the Monovent and other Burt Ventilators.

THE BURT MFG. CO.
ROOF VENTILATORS • OIL FILTERS
EXHAUST HEADS

48 E. SOUTH STREET, AKRON 11, OHIO

SEND
FOR CATALOGS
Burt Engineers
are glad to
help on plans

Available

Again

TIME-SAVER STANDARDS

Architectural Record's ten-year collection . . . all in one volume



Second Printing

277 Time-Saver Standards — 656 Pages; 12-Page Master Index; Size 8 1/2 x 11. More than 1,000 illustrations, charts, diagrams

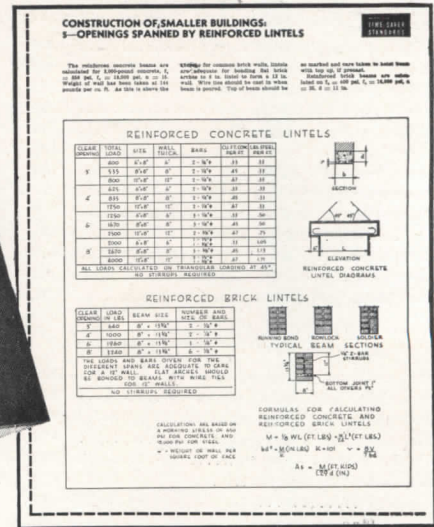

IN RESPONSE to insistent demand for more copies, here, reprinted again in one volume of encyclopedic size, are virtually all the Time-Saver Standards ever published — 277 of them — exactly as they appeared originally in *Architectural Record* and *American Architect* during the past ten years — with one 12-page master index!

Just off the press, for immediate delivery to you, is this work of 656 pages, with a mailing weight of 4 1/2 lbs., containing a complete collection of these now famous authoritative monographs on technical aspects of construction dealing with

- Architectural Design
- Materials Technology
- Engineering Data
- Building Practice

Designed for the practical guidance and every-day use of architects, engineers, specification writers and building technicians, TIME-SAVER STANDARDS will bring you a wealth of detailed information on design and building practice . . . carefully selected from the works of the nation's leading building designers and engineers.

Well-Organized 12-page Index

This wealth of data is carefully organized and painstakingly presented. It is so thoroughly indexed that there are 1,856 references and cross-references . . . occupying twelve pages of closely set print.

Experience shows that a single item in TIME-SAVER STANDARDS can well save hundreds of dollars in economy construction . . . save many hours of your valuable time. Yet you can now place this concise and well-organized planning data at your command for the nominal sum of \$12.00 — provided you act now.

Order Your Copy Now

The first printing of TIME-SAVER STANDARDS last November was sold out almost before publication. Now an unanticipated flood of re-orders — for extra copies and multiple copies — on top of new orders indicates the second printing will soon be snapped up.

So get your copy now. Don't get caught on a long waiting list. Simply fill out the coupon at right, attach your check or money order for \$12.00, and mail today. Your copy will be rushed to you without delay.

These telescopic outlines of only a very few of the 277 Standards give a quick idea of the detailed treatment accorded each subject.

Dry-wall Construction. Materials applicable. Fiber board. Fiber insulation board. Planks and tileboards. Hardboard, Gypsum wallboard. Plywood. Cement asbestos. Plastics. Composite and self-supporting walls and partitions . . . Advantages. Handicaps. Costs. Terminology. Classifications and sizes. Framing and furring. Joints. Nailing and cementing. Flexible fasteners. Finishing. Simplified practices. Uses. Applications. References.

Heating—Unit Heaters. Typical Heat sources. Boiler capacity. Characteristics. Location. Selection data. Capacities. Controls. Fresh Air connections. Pipe connections. Louvers. Grilles. Deflectors.

Basement Waterproofing. Impermeability of concrete cracks and joints in masonry. Hydrostatic pressure. Recommended concrete mixtures. Effect of curing time on permeability. Integral and membrane methods. Plastic and iron coating. Cement-base coatings.

Folding Partitions. Center hung doors. Pair-operated doors. Pockets. Passage through closed partitions. Door construction and soundproofing. Rolling partitions. Folding fabric partition.

Lighting. Recommended levels of illumination. Fixtures for filament and mercury lamps. Luminaire spacing. Room index. Coefficients of illumination. Layout suggestions. Conformity with structural design. Computed values of illumination. Lumen output of lamps.

Noise Reduction Acoustical Materials. A rule-of-thumb answer to what noise coefficient to use. Special applications. Materials for plastic application. Costs. Appearance. Design. Fire resistance. Light reflection. Heat transmission. Lighting. Pre-cast materials. Effect of paint. Acoustical Units: Wood framing; metal suspension systems.

ARCHITECTURAL RECORD BOOK DEPARTMENT
119 West 40th Street, New York 18, N. Y.

Enter my order for _____ copies of the second printing of the 656-page TIME-SAVER STANDARDS at \$12.00* a copy. I enclose \$_____

* Add 24 cents for New York City delivery — \$12.24 in all.

Name _____

Address _____

City _____ Zone _____

State _____

What's Missing?

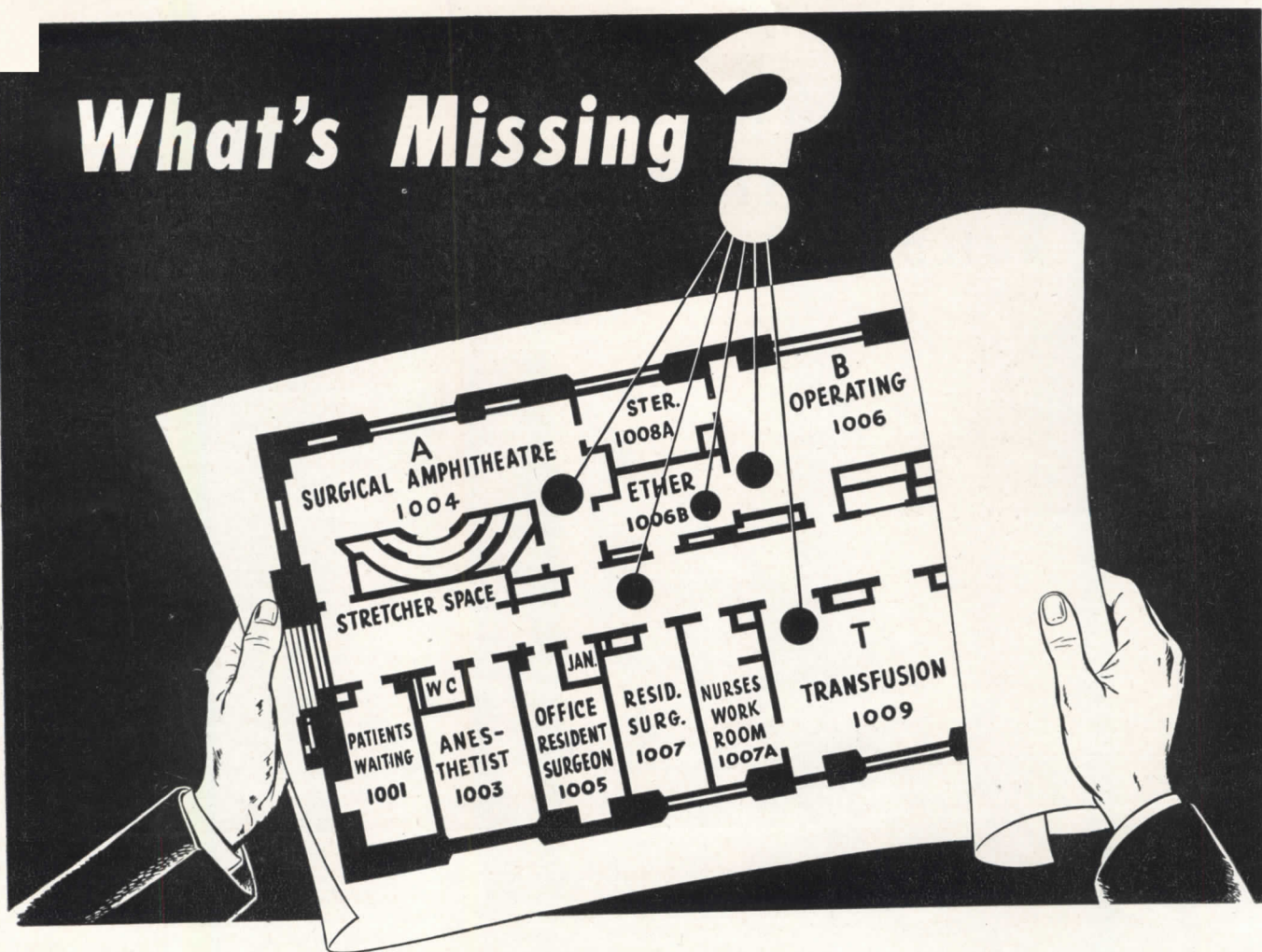

SAFEGUARD EACH OF THOSE VITAL POINTS AGAINST FAILURE OF ELECTRIC LIGHTS

It is easy to eliminate danger of lighting failure in the buildings you design. Especially in hospitals, schools, auditoriums... wherever large numbers of people gather... it is vital that adequate lighting protection be provided.

Despite all precautions of utility companies, accidents beyond their control can cause interruptions of normal electric current. Storms, floods, fires and collisions may occur with little or no warning, and may prove to be a serious menace to electric power lines.

Many architects safeguard the buildings they design by indicating emergency lighting at strategic points. They specify the use of Exide Emergency Lighting, which provides safe, sure, modern protection... operating instantly and automatically when regular sources fail.

IN A MODERN HOSPITAL EACH OF THESE POINTS SHOULD BE SAFEGUARDED

- Operating rooms
- Delivery rooms
- Anesthesia rooms
- Accident Dispensary
- Boiler Room
- Corridors
- Stairways
- Exits

Exide

EMERGENCY LIGHTING

THE ELECTRIC STORAGE BATTERY COMPANY, Philadelphia 32 • Exide Batteries of Canada, Limited, Toronto

Window Insulation

FOR AIR CONDITIONED BUILDINGS

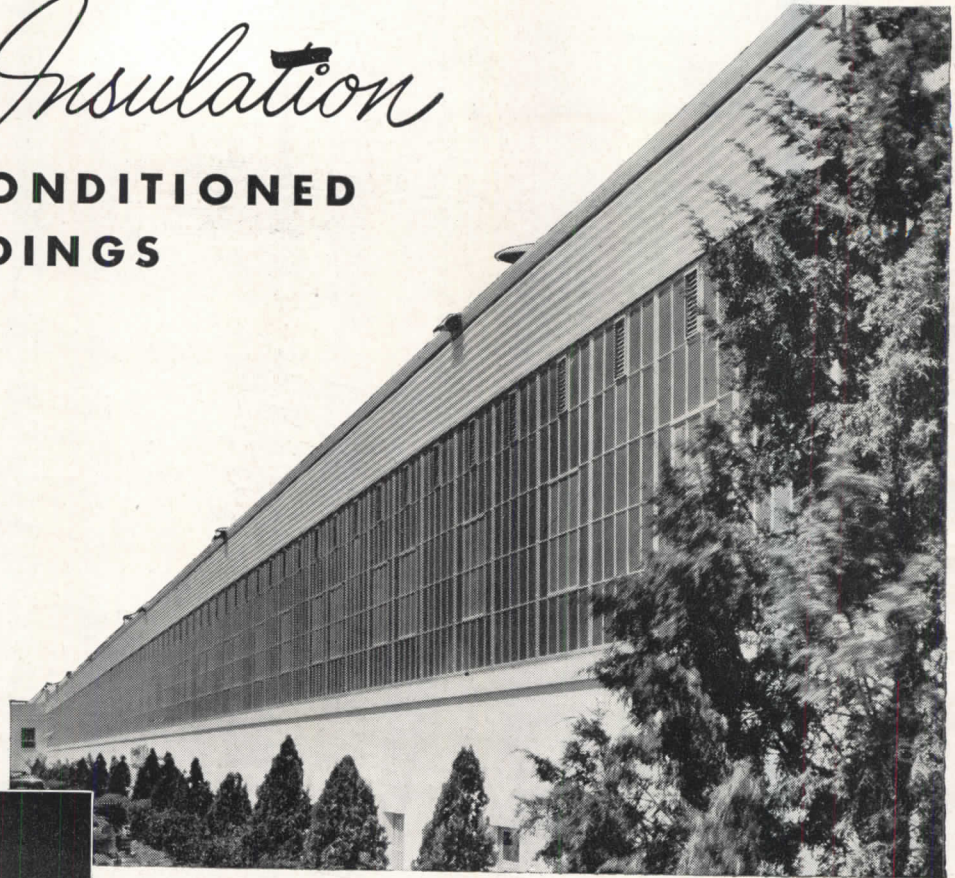

420 *Thermopane* units of Aklo heat absorbing glass were used in glazing this plant. The manager reports: "These units were installed in our steel sash wherever it was necessary to maintain a uniform year-round temperature to permit satisfactory baking conditions and processing. It has resulted in a saving in reduced operation cost of our air conditioning system and elimination of condensation on the room side." Architects: M. C. Haley and C. W. Watkins,

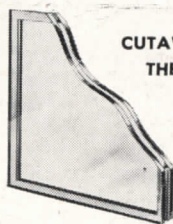

CUTAWAY VIEW OF THE THERMOPANE UNIT

● When manufacturing processes or employee operating efficiency depend on air conditioning, there's no need to restrict the use of larger window areas.

Thermopane, consisting of two panes of one-eighth inch glass separated by one-half inch air space, has a coefficient of heat transfer of .58 as compared with 1.16 for a single one-eighth inch pane. Thus, you can double glass area without increasing heat loss... without throwing excessive load on air conditioning equipment. Likewise, *Thermopane* permits greater use

of glass in any building where heat loss, sound transmission and comfort are factors.

To make *Thermopane* more readily available and to effect important economies, *Thermopane* is made in more than 60 standard sizes—providing sizes for any building need. For insulation data, sizes and other pertinent information, see Sweet's Architectural File. Or write us for complete information, including Data Sheets by Don Graf. Libbey-Owens-Ford Glass Company, 2218 Nicholas Building, Toledo 3, Ohio.

*®

ONLY LIBBEY · OWENS · FORD
MAKES *Thermopane*



LIBBEY · OWENS · FORD
a Great Name in **GLASS**