

Why Ozalid clicks with engineers and draftsmen

STUDY THE cross-sectional drawing of an Ozalid Whiteprint Machine . . . It tells much of the story.

Printmaking is reduced to two operations—Exposure and Dry Development . . . the liquid baths, the plumbing connections, the driers which for fifty years have been a part of blueprinting *are eliminated*. SIMPLIFIED PRINTMAKING allows simplified design—and an Ozalid Machine is so compact that it may be installed right in the drafting room where it can be operated by anyone.

What's most important now, though, is the fact that the Ozalid Process saves thousands of man-hours . . . and that means a big "head start" in war production. When you want to change part of a drawing, it's

never necessary to redraw any line which remains the same in the new design. You merely make a transparent print of the original tracing . . . delete the obsolete lines with a corrector fluid . . . and draw in the new design. It's that easy—no Van Dyke tieups, no photographic equipment required.

Ozalid Whiteprint Machines are designed for large scale, medium, and occasional print production. Adopt Ozalid . . . and make positive reproductions *direct* from *your* engineering drawings, charts, and letters.

WRITE FOR "SIMPLIFIED PRINTMAKING."

It shows how leading manufacturers save time, labor, and materials with the Ozalid Process; also contains samples of whiteprints having blue, black, and maroon lines on white backgrounds.

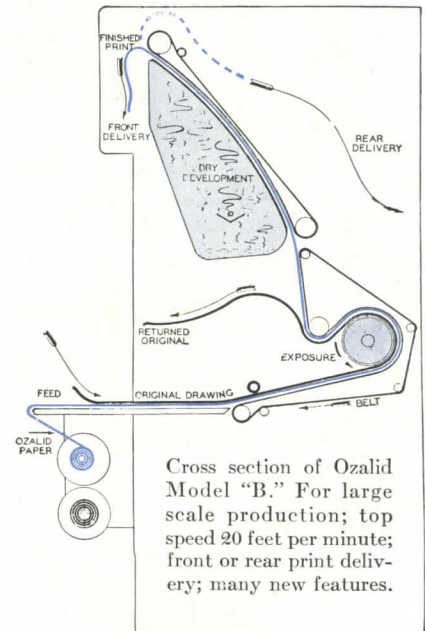

Cross section of Ozalid Model "B." For large scale production; top speed 20 feet per minute; front or rear print delivery; many new features.

OZALID PRODUCTS DIVISION

GENERAL ANILINE AND FILM CORPORATION

Johnson City, N. Y.

EVERYTHING WE ARE DOING TODAY...

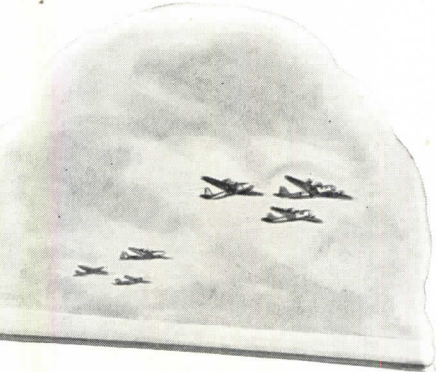
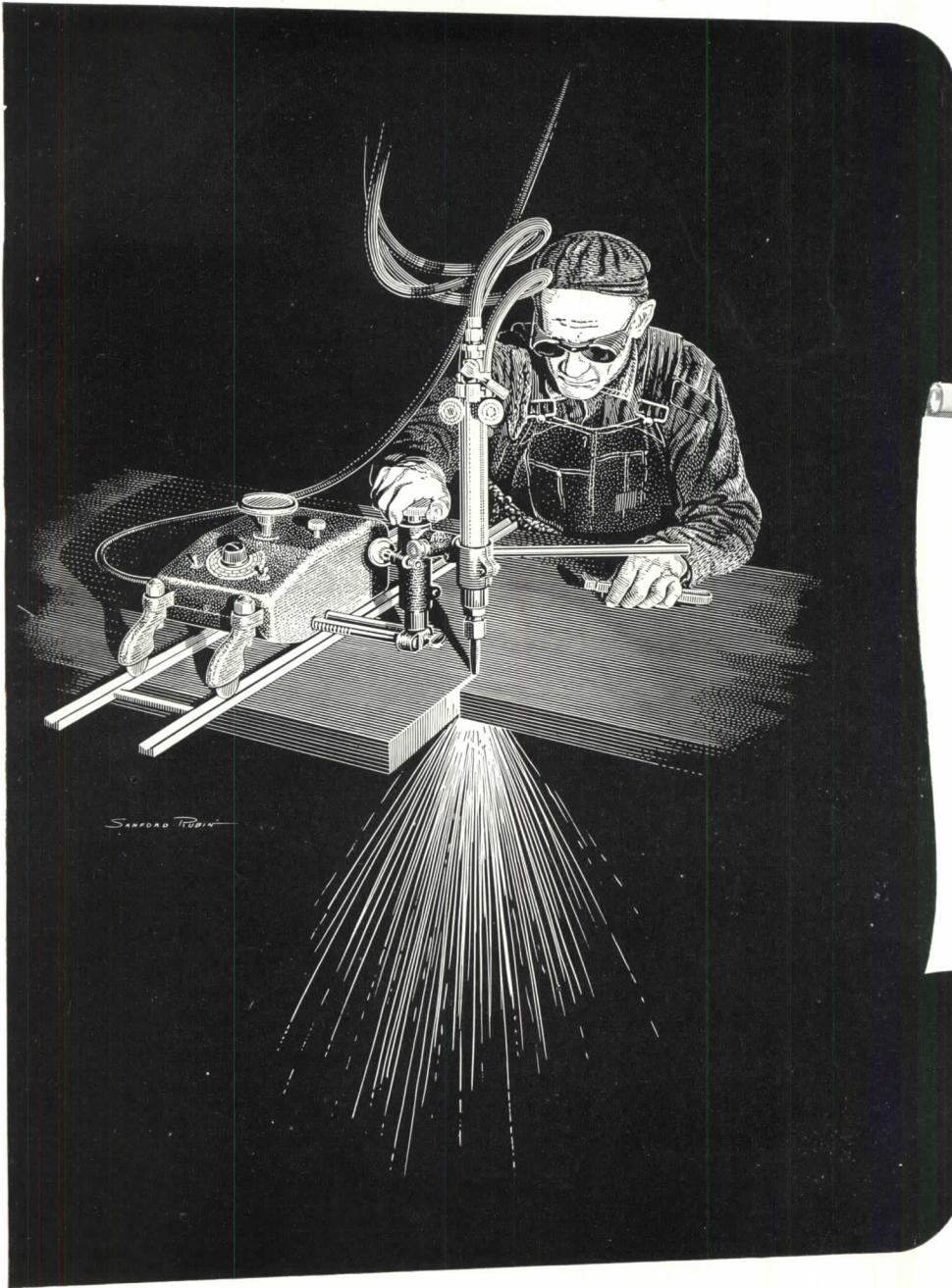

**Some Facts We'd Like
You To Know About
Mesker Brothers**

New Flame Cutters, acquired to facilitate our delivering the goods to Uncle Sam's Navy, cut through metal like hot knives through cheese. Better than anything else, they symbolize Mesker's constant reduction of production costs... important to you as a taxpayer today, a window buyer tomorrow



Mesker Engineers..the country over..

Mesker

424 SOUTH SEVENTH STREET •

YESTERDAY AND TOMORROW

CASEMENT WINDOWS • MONUMENTAL WINDOWS • INDUSTRIAL WINDOWS • SCREENS • INDUSTRIAL DOORS • DETENTION WINDOWS • REINFORCING MESH GRATING...plus
... tomorrow... some other interesting new products!

S D E S I G N E D T O H E L P Y O U T O M O R R O W

MEMO:

The Most Leasable
Offices Tomorrow
Will Feature...

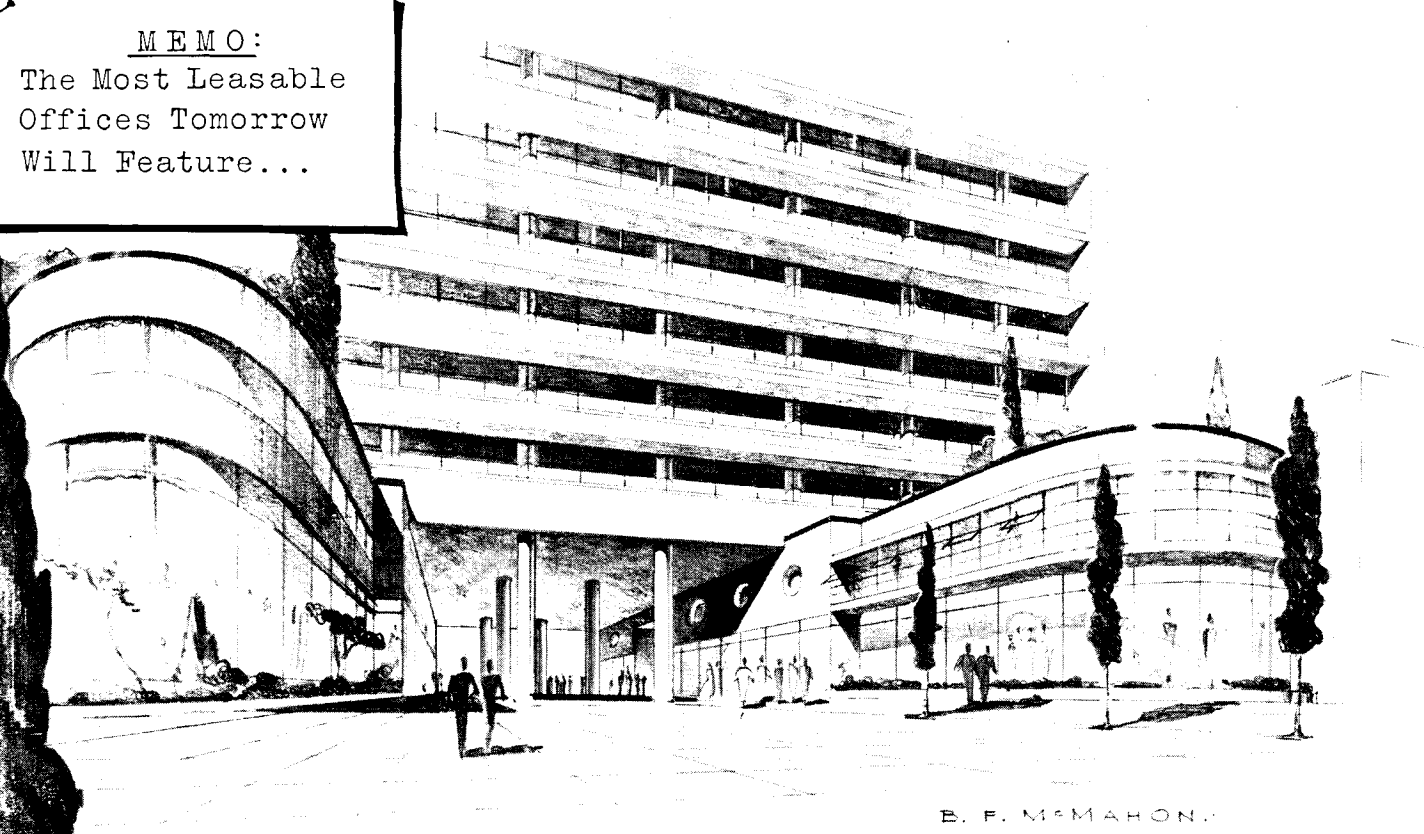

B. F. McMAHON

MESKER METAL WINDOWS

Weather-Conditioned

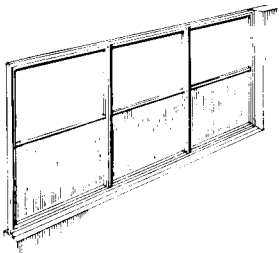

Building owners and occupants are becoming increasingly conscious of windows. Ample natural light, draftless ventilation, excellent insulation, stimulate employee effort, increase efficiency... without burdening anyone with artificial lighting and air conditioning maintenance costs. Architect McMahon, in designing for us his Office Building of Tomorrow, indicates window areas from floor to ceiling. Can you imagine a more desirable treatment? Offices like these never lack good tenants. In our Engineering Department now are designs for windows that will most appropriately cope with such conditions. We call them Mesker *Weather-Conditioned* Windows. Watch for them.

Do You Have Your "Red Book of Steel Sash?"

If not, write for this comprehensive volume, personalized with your name. Covers metal windows from A to Z... ideal to have at your elbow when working up specifications, details, etc., on post-war projects. No obligation.

IMPORTANT!
Our warehouse stock of steel windows are now available to anyone without priority, as long as they last. Consult your Mesker Engineer.

In War and Peace... at your service!

Brothers

ST. LOUIS, MISSOURI, U. S. A.

TODAY

STEEL AMMUNITION CASES · PRE-FABRICATED STEEL AIRPLANE RUNWAYS · OIL AND WATER STORAGE TANKS FOR THE NAVY'S FIGHTING SHIPS... other products which necessarily must remain military secrets.

The completion of this Sperry Gyroscope Company building adds another to the long list of important "war jobs" where Radiant Heating—and Byers Wrought Iron—are serving.

The system was engineered by Stone and Webster, and Alvord and Swift were the heating contractors. It was the first Radiant Heating installation for each concern. All coils were formed with a bending machine on the job, and field-welded into four unit assemblies, each individually controlled by Johnson Service Company thermostats. In situations where additional heating effect was needed in a given area, vertical panels (as shown in small illustration) were installed. The completed piping system was tested

at 100-lbs. pressure for four hours, and in 19,000 feet of pipe only three minor leaks were revealed.

The coils were topped with 6-inches of concrete, poured while the coils were filled with water at 100°F. Finished floor will be bare, or linoleum covered. The heating medium is hot water at 110°F., provided by a heat exchanger and zone circulated by four Ingersoll-Rand fractional horsepower pumps.

The influence of proper heating upon production gives extra reason for checking Radiant Heating's advantages against the heating needs of any structure built today. It generally saves considerable metal, leaves all floor-space clear, and introduces no explosion hazards in dangerous operations.

Byers Wrought Iron for the coils "permanizes" these advantages; its superior corrosion resistance has been demonstrated in hundreds of applications where service conditions were similar. Its thermal properties are excellent; and it can be readily formed and welded.

Our Engineering Service Department will be glad to discuss any specific design problems with you. We will also be glad to send you a very complete discussion of the entire subject: our technical bulletin, "Byers Wrought Iron for Radiant Heating Installations." Just write.

A. M. Byers Company. Established 1864. Offices in Pittsburgh, Boston, New York, Philadelphia, Washington, Chicago, St. Louis, Houston, Seattle, San Francisco.

19,000 Dependable Feet of RADIANT HEATING Coils **BYERS WROUGHT IRON**

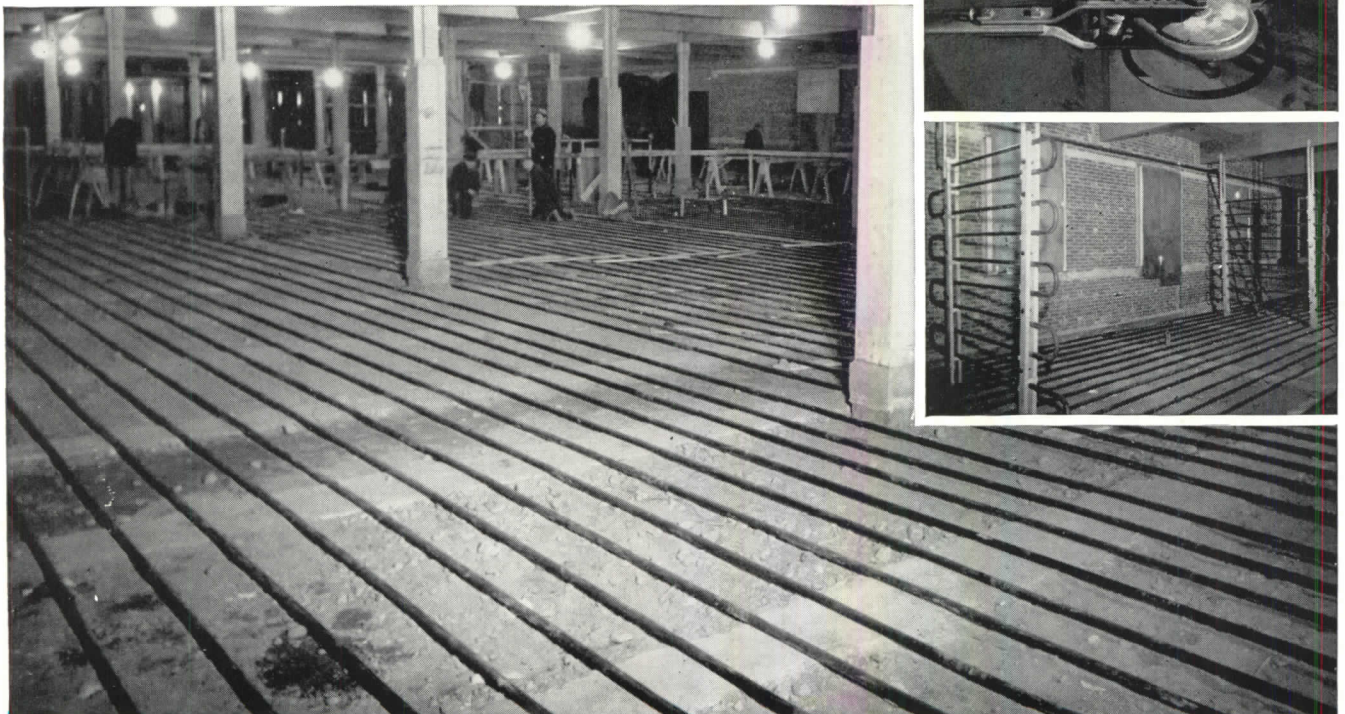

Sperry Gyroscope Co., Inc.
Personnel Building
Stone & Webster Engineering Corp.
Architects and Engineers
Alvord & Swift
Heating Contractors

CORROSION COSTS YOU MORE THAN WROUGHT IRON

BYERS
GENUINE WROUGHT IRON
TUBULAR AND HOT ROLLED PRODUCTS
ELECTRIC FURNACE ALLOY STEELS • OPEN HEARTH ALLOY STEELS
CARBON STEEL TUBULAR PRODUCTS

ARCHITECTURAL

RECORD

COMBINED WITH AMERICAN ARCHITECT AND ARCHITECTURE

VOL. 93

JUNE 1943

NO. 6

CONTENTS

COVER: G. D. Searle and Co. Laboratory, described pp 49-60.
(Hedrich-Blessing Photo)

THE SHELL, THE PEA AND THE FAIR	41
An Editorial on Prefabrication... by Kenneth K. Stowell	
HOUSING AND THE DEMOCRATIC PROCESS	42
By Joseph Hudnut. An examination of the social and political consequences of present and postwar housing philosophy and procedure which may reorient the thinking of architects and housers.	
AIA CONVENES AT CINCINNATI	47
LABORATORY FOR MODERN MEDICINE	49
Manufacturing plant for G. D. Searle and Company, Skokie, Illinois. Herbert C. Banse, Architect; George A. Fuller Co., General Contractors.	
PREFABRICATION	61
. . . BUILDING TYPES STUDY NO. 78	
1. Assembly Lines Reach Out for Markets. By Douglas Haskell. Case studies in the production methods and merchandising techniques pointing up different approaches to prefabrication's problems.	
2. Technical Advances: Present and Potential. By Howard Vermilya, Director, Technical Division, Federal Housing Authority. A bird's-eye view of the latest developments in structure, heating, lighting and equipment for prefabricated houses.	
3. List of Prefabricators.	
FPHA TO USE PLASTIC TUBING	80
Saran tubing adopted for hot and cold water lines.	
PAINTS: PRESENT AND POSTWAR	81
By Burr Price, Managing Editor, National Paint Magazine. Current research and war needs indicate many new developments and improvements in architectural finishes.	
TIME-SAVER STANDARDS . . . Store Front Awning Hoods and Boxes	85
THE RECORD REPORTS . . . News from the field	7
PROPOSED POSTWAR HOUSING PROJECT	16
REQUIRED READING . . . Reviewed by Elisabeth Coit, AIA	26
FOR BETTER BUILDING . . . News of materials, equipment and methods . . .	88
INDEX TO ADVERTISEMENTS	124

N E X T M O N T H

THE OWI announces that production of airplanes accounts for one-fourth of our annual war budget, and almost one-seventh of our national income. Aviation is the present giant of industry and it may well continue to be in the postwar era. By January first there will be some 865 major airports in the U. S. The number and kind of airports which will be required is not yet known. That airports and airport buildings will be necessary in unprecedented amount, is certain. Our Building Types Study for July is devoted to airports and hangars. This study is not only a report of what may be expected, but gives practical details regarding one of the airport's essential buildings—the hangar. . . . Industrial buildings have just been completed which have unique structural and design features worthy of study for both war and postwar application. The lessons we can learn from them are pointed up in photographic detail in a special section of the July number. . . . Other types of buildings, however, are not neglected—nor is housing. A study of the housing market will present a realistic approach, and draws some interesting conclusions. . . . And the article which tells what the prefabricators themselves think of the architect and the part he can play in that growing industry will be of interest both to those who fear and to those who welcome this trend in house construction.



Copyright 1943 with all rights reserved

F. W. DODGE CORPORATION

H. JUDD PAYNE, Vice President in charge of MAGAZINE DIVISION

EDITORS: *Editor-in-Chief*, Kenneth Kingsley Stowell, AIA; *Managing Editor*, Emerson Goble; *Associate Editor*, Seth Talcott, AIA; *Associate in South America*, Edmund J. Whiting, AIA; *Art Director*, William K. Allen; *Desk Editor*, Florence A. van Wyck. CONSULTANTS: *Industry relations consultant*: Thomas S. Holden. *Statistical consultant*: Clyde Shute. *Building economics consultant*: Norbert Brown. *Field research consultant*: Clifford Dunnells, Jr.

ARCHITECTURAL RECORD (combined with American Architect and Architecture) is published monthly by F. W. DODGE CORPORATION, 34 No. Crystal St., East Stroudsburg, Pa., with Editorial and Executive Offices at 119 West 40th Street, New York, N. Y.; Thomas S. Holden, Pres.; Howard L. Barringer, Vice-Pres. and Treas.; Irving W. Hadsell, Vice-Pres.; Chauncey L. Williams, Vice-Pres.; Sanford D. Stockton, Jr., Secy.; Walter F. De Saix, Asst. Treas.; Edwin H. Freed, Asst. Treas. Member Audit Bureau of Circulations and Associated Business Papers, Inc. ARCHITECTURAL RECORD is indexed in Reader's Guide, Art Index and Industrial Arts Index. Subscription rates: United States and Possessions, Canada, Cuba, Mexico, Central and South America, \$3 the year, \$5 for two years, \$9 for three years; elsewhere, \$5 the year; single copy, \$1. (Circulation Manager: A. L. Erickson. Every effort will be made to return material submitted for possible publication (if accompanied by stamped, addressed envelopes); but the editors and the corporation will not be responsible for loss or damage. Other Dodge Services: REAL ESTATE RECORD AND BUILDERS' GUIDE, SWEET'S CATALOG FILES, HOME OWNER'S CATALOGS, DODGE REPORTS, and DODGE STATISTICAL RESEARCH SERVICE.

Still **STURDY
AND
DEPENDABLE-**

**THE "V" MODEL
Watrous
FLUSH VALVE**

- THIS wartime Watrous "V" Flush Valve conserves critical materials . . . complies with limitation orders . . .
- *BUT* . . . no lightweight, *this* flush valve. It is built of the strongest, most durable alternate materials (metals) American industry can provide. And its vital operating unit—the piston—is still of time-proven *brass construction*.
- This "V" Model brings to wartime buildings the dependable, trouble-free Watrous service which is so essential in these times.

THE IMPERIAL BRASS MFG. CO., 1240 West Harrison St., Chicago, Ill.

Sweet's Catalog File, Section 27 Catalog No. 39 covers both "V" Model Watrous Flush Valves for wartime projects and the regular Watrous line for postwar applications.

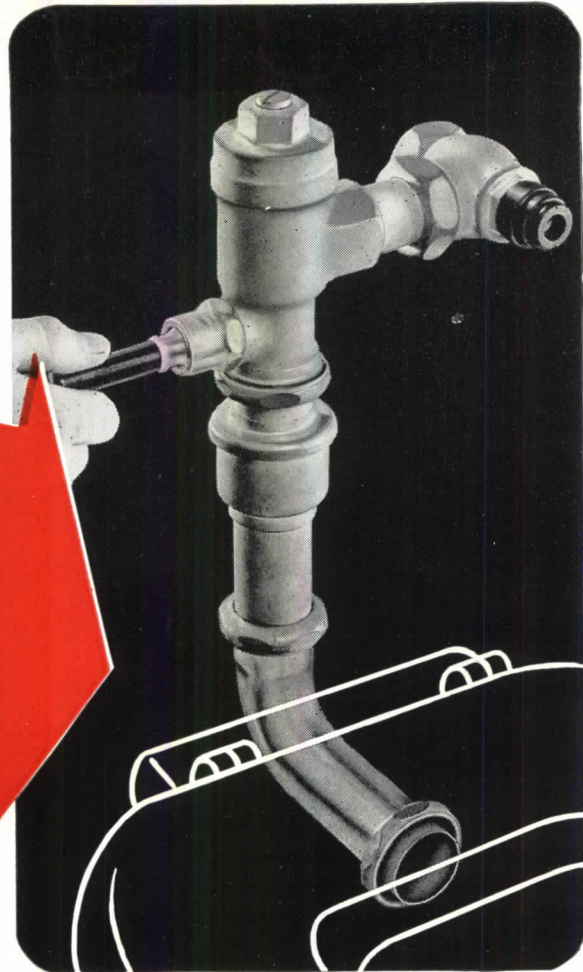

- ★ The "V" Model retains Watrous proved design and excellence of workmanship.
- ★ Strength and durability have been a primary consideration in the selection of the alternate metals used.

For Simplified Specification Data on Watrous "V" Flush Valves ask for Bulletin 858-W.



Watrous Flush Valves

WASHINGTON NEWS

Further Expansion of War Producing Facilities Halted • Future War Housing Program • Growing Unrest Within Government Corporations • Small Construction Restrictions Removed

INDICATIONS are that the War Production Board has called a halt to further expansion of war producing facilities. A decided curtailment of construction plans for industrial production of materials used for war or military purposes has been ordered. President Roosevelt has announced that we are now out-producing the combined output of the rest of the world in airplanes and other military equipment. WPB has issued an official report that we now have enough machine tools and capital equipment to defeat the Axis. All this means that WPB has completed the plant construction program so vitally important up to the present time. It is admitted, however, that further construction may be necessary in order to expand facilities used in the production of certain critical raw materials such as synthetic rubber.

Army officials voice the opinion that present production is so great that the armed forces cannot transport and distribute the finished goods as rapidly as they are produced. This will call for additional warehousing for storage until these goods can be sent where they are needed. A preliminary survey has been made as to present warehouse capacities and a definite shortage has been found to exist in the New England states as well as in the Middle West. Plans are being made for the construction of necessary warehouses, and a program is being worked out with WPB.

With the termination of much industrial construction, USHA has hopes that the critical war-housing shortage may be subject to some relief. Thousands of construction workers and vast quantities of construction machinery is being released by the industrial construction curtailment. The National Resources Planning Board is trying to provide for the transference of almost 3,000,000 men, formerly engaged in construction work, into other necessary occupations. Many of these are being shifted to agricultural work in some of the southern states.

Future War Housing Program

Hearings are now under way before the House Public Buildings and Grounds Committee for an additional \$400,000,000 to be expended on construction of war housing. Officials within NHA admit that even with the additional funds the over-all housing program will have to be at a level somewhat lower than that of last year.

The War Manpower Commission has definitely entered into the housing problem because of the influx of immigrant workers into industrial areas. A study has been made by that agency showing where the greatest need for war housing exists. With the stepping up of aircraft and shipbuilding production, there has been an increasing shift of war workers into areas engaged in such production. Consequently, West Coast shipyard and aircraft construction centers probably will be focal points in the expansion of new war housing. Other areas which will draw the attention of NHA will be the Newport News, Virginia, sec-

tion and the Gulf Coast shipyard centers. Officials confess that the Detroit housing situation is one of the most critical in the country and war production heads state that this housing shortage is causing a slowdown in the turning out of vital war supplies.

Absenteeism runs much higher in the Detroit area than elsewhere and the inadequate housing facilities have been directly traced as the chief cause for this bottleneck. The new war housing program is designed to house over a million workers who will move to war industry areas during the next twelve months. It has been estimated that it will be necessary to construct 940,000 dwelling units to accommodate these migrant workers. The requested increase in the Lanham Act funds will finance only 200,000 of such units. This must necessarily include conversion of existing buildings and the construction of 90,000 temporary family units and 70,000 temporary units for single persons.

The additional accommodations required will have to be handled through privately-financed channels. The overall policy of NHA will be to seek maximum use of existing buildings with a view toward conversion wherever possible.

(continued on page 10)

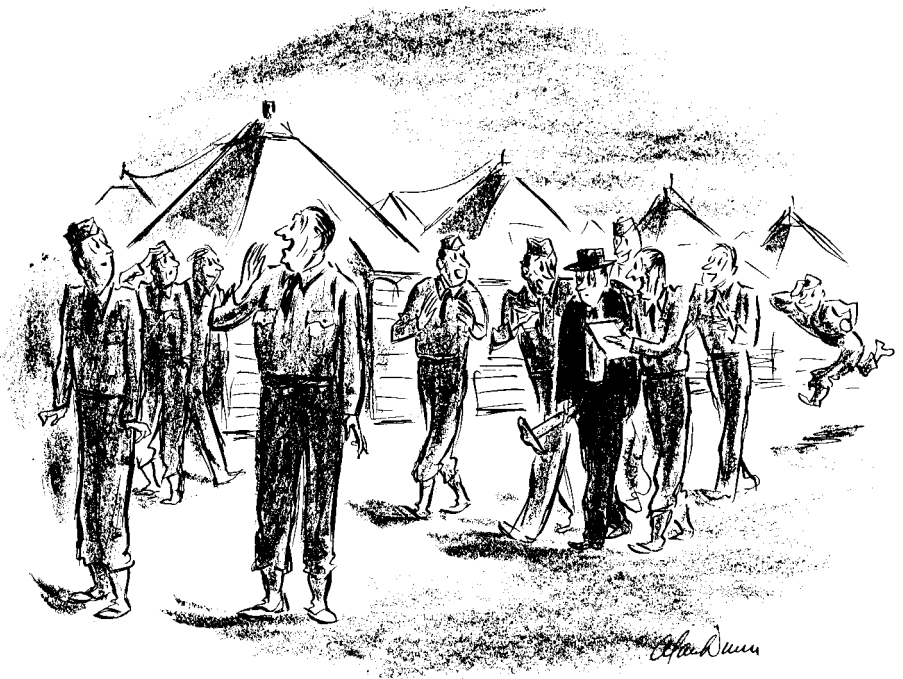

"The cantonment architect is here to analyze our needs, boys!"

—Drawn for the RECORD by Alan Dunn

*Copper and Brass can make
a lot of difference in*

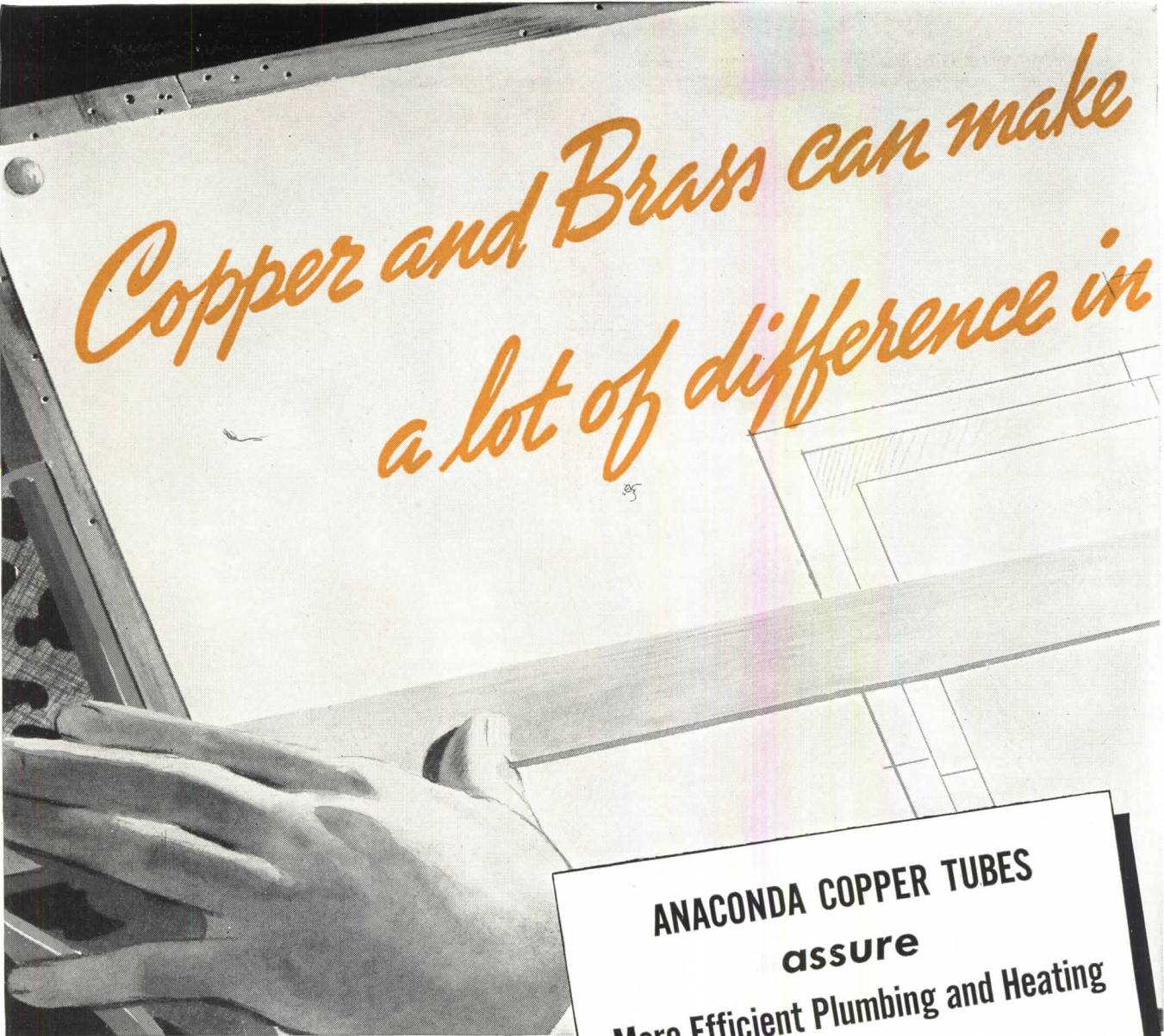

America's desire for comfortable, gracious living—so ably satisfied by you in the past—is not a casualty of war. Rather, present day inconveniences resulting from the use of less durable substitute materials are actually stimulating a desire for the economical maintenance and security provided by long-lasting copper and brass.

Fortunate indeed, during this war period, are the owners of homes rustproofed with these durable metals. The convenience and economy they now enjoy are a reflection of what the future holds for peacetime builders.



4322

ANACONDA COPPER TUBES
assure
More Efficient Plumbing and Heating

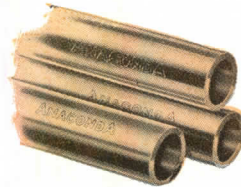

Copper tubes for plumbing and heating lines give years of rust-free service. Installation cost is low because of "solder" fittings.
Copper tubes stubbornly resist corrosion... are smooth inside and out... provide ample strength to withstand normal pressures and temperatures. They save space, are clean and attractive in appearance and in the long run, are outstandingly economical.

The *American Brass Company*

General Offices: Waterbury, Connecticut, Subsidiary of Anaconda Copper Mining Co.



ANACONDA SHEET COPPER
assures
Long-Lasting, Rustless
Gutters, Rainpipes, Flashing

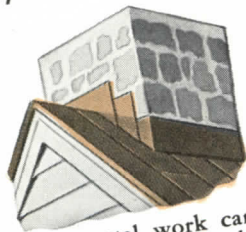

Rusted, leaking metal work can necessitate costly repairs—it's one of those things that can make a man regret the responsibilities of home ownership.

That's why valleys, gutters, rainpipes and flashing on the home of the future should be made of sheet copper. With copper, there's none of the water damage which so often results from the use of less durable flashing materials . . . rain disposal systems give better, less expensive service.

EVERDUR^{*} STORAGE TANKS
assure
Plenty of Clean, Hot Water



Rusty hot water and an occasional tank replacement due to rust, are common annoyances that need not concern future homeowners. For long-lasting hot water storage tanks of Everdur Metal will again be available. These strong, welded, rustproof tanks are establishing trouble-free service records in thousands of homes.

*Reg. U. S. Pat. Off.

ANACONDA
"ELECTRO-SHEET"
assures
Concealed flashing that's
low in cost, durable

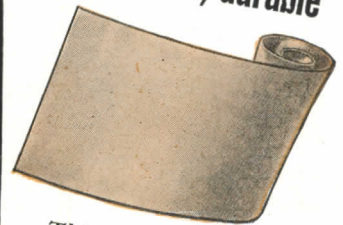

Thin copper for low cost, easy application, yet strong and rustproof for lasting protection against infiltration of air and moisture around windows, doors and other points requiring concealed flashing.

makers of **Anaconda Copper & Brass**

In Canada: Anaconda American Brass, Ltd., New Toronto, Ontario

(continued from page 7)

sible, rather than authorization of new construction. This is necessary because of both the economies involved and the shortage of critical construction materials.

The future program of NHA will also take into account the postwar need for housing. Following this policy there will be allotments made to privately financed construction of new family units to be built by private builders under present wartime restrictions. The bill now pending before the Public Buildings and Grounds Committee would increase the war housing authorizations under Title I of the Lanham Act from \$1,200,000,000 to \$1,600,000,000.

NHA Administrator John B. Blandford, Jr., has reported that more than 85 per cent of all private war housing is now being financed through mortgages insured under Title 6 of the National Housing Act. To continue adequate financing, NHA recently obtained a \$400,000,000 increase in the Title 6 insurance authorization. A similar request will be made to Congress by NHA to carry out the new housing program so far as privately financed construction is concerned for the fiscal year 1944.

As a result of close cooperation and agreements with WPB, complete responsibility for the over-all program of war housing has been given to NHA. In this connection NHA authorizes new construction only in those localities where the War Manpower Commission has determined that the in-migration of workers is essential to the successful prosecution of the war effort. NHA frankly states that even in those cases the conversion of existing structures for housing facilities of such workers will be undertaken before new construction is begun.

Government Corporations

There is a growing unrest within some of the government corporations in the Reconstruction Finance Corporation. Many of the financing plans of these RFC companies are based on critical shortages of essential raw materials, access to which this country has lost by virtue of enemy conquest. In some cases industrial plants have

been constructed for the manufacture of synthetic products to replace materials whose original sources may now again be available as the Allies retake conquered territories.

Officials inside of RFC foresee the possibility of tremendous losses to the government through this reopening of former trade channels. The Defense Plant Corporation finances the construction and the operation of many industries in which such a reopening is sure to mean considerable under-selling of government-subsidized products. Because of this probability, government corporations are scrutinizing more carefully than before all projects which come before them for the creation or expansion of existing facilities in war industries. Construction under the DPC program is being materially curtailed. At the same time, some thought is being devoted to the possibility of converting some of the government-financed industrial plants for postwar production of peacetime goods. Plants engaged in the manufacture of substitute or synthetic rubber are less apt to be affected than are those producing any of the other ersatz materials.

Small Construction Restrictions Revised

WPB has revised its former tight restrictions on certain types of maintenance and repair construction. Minor capital additions now will be allowed if the cost of such job will not exceed \$500 excluding labor costs. WPB has ruled that capital adjustments cannot be divided in order to bring each part of the job within the \$500 limit. Authority to construct must still be obtained from WPB in accordance with the requirements of L-41. Priority assistance should be obtained by using the general form, PD-1A.

—J. Maxwell Dickey
Washington Correspondent

★ ★ ★

URBAN REDEVELOPMENT LEGISLATION

A Federal Urban Redevelopment Act has been introduced in the Senate by Senator Thomas of Utah. Under the provisions of the bill a new Urban Redevelopment Agency would be

established to administer Federal loans for land acquisition. This is contrary to the proposals of the Urban Land Institute, which point out various advantages in using an existing Federal agency for this purpose rather than creating an entirely new department.

Also contrary to the proposals advocated by the Urban Land Institute is the Thomas bill provision that Federal loans for land assembly may include no funds for any additional purposes.

The Maryland Legislature has adopted a bill authorizing the creation of a Land Development Commission by the City of Baltimore. This Commission is authorized to acquire land in blighted areas by purchase, lease, and condemnation, provided the area selected for redevelopment is at least eight acres in size. The power of condemnation may be used only after 60 per cent of the area has been acquired by purchase or option. All procedures must be in accordance with the official plans of the Baltimore Commission on City Plan.

Anticipating an extension of Federal credit to implement large scale rebuilding of deteriorated urban areas, the Maryland Act specifically authorizes the Land Development Commission to petition an "appropriate Federal department" for loans to be used in the acquisition of land in slums and blighted areas for redevelopment. The local commission is also authorized to seek Federal assistance in the preparation of redevelopment plans.

In Kansas the Legislature has recently approved a bill authorizing the creation of urban redevelopment corporations having the power to condemn, under supervision of the State Corporation Commission, land in slums and blighted areas for private redevelopment.

Similar bills are also under consideration in Missouri and Wisconsin.

WPB NOTES

COPPER RESTRICTIONS

Further savings in such critical materials as copper, copper base alloy and zinc used in the manufacture of plumbing fixture fittings and trim have been ordered by the War Production

(continued on page 12)

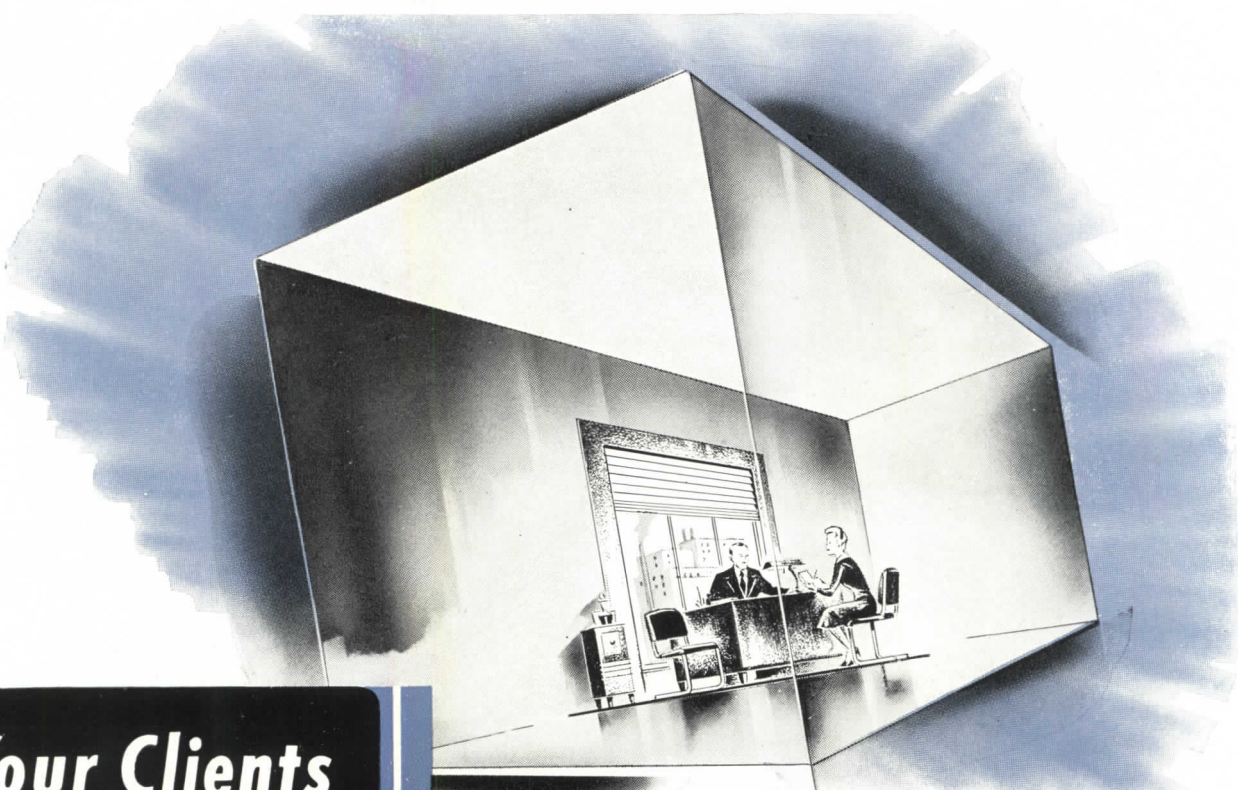

**Your Clients
will take it
for granted**

Your plans and specifications for buildings for post-war America will undoubtedly include air conditioning. Because your clients are now accepting air conditioning as a basic requirement on a par with heating and ventilating . . . In stores, air conditioning draws customers, increases sales. In office buildings, it attracts tenants. In factories, it increases employee efficiency.

As your own planning progresses, you will be counting on incorporating the most modern air conditioning equipment. You can turn to Worthington with confidence. In consultation with you, Worthington will bring 50 odd years of refrigeration machinery specialization plus industrial and commercial air conditioning and refrigeration installations that would have staggered the imagination a few years ago.

This experience is back of the Worthington Air Conditioning equipment being designed today for your post-war clients. Worthington Pump and Machinery Corporation, Harrison, New Jersey.

CA3-28

Air
WORTHINGTON
Conditioning

A N D W O R T H I N G T O N R E F R I G E R A T I O N

3

Notes on the design, use and installation of thin, precast Architectural Concrete Slabs—prefabricated concrete building units made in varied shapes, colors and textures

ARCHITECTURAL CONCRETE SLABS

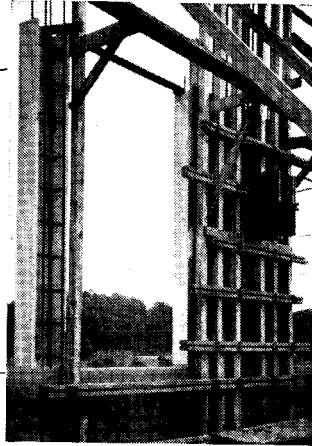

On the David W. Taylor Model (Ship-Testing) Basin for the U. S. Navy, the facing slabs were used as exterior forms for the structural concrete, reducing job forming.

Erection costs reduced by use of thin, prefabricated units

Two of the many advantages of using Architectural Concrete Slabs are:

- 1 quick, easy facing of large areas with a small number of large units;
- 2 use of slabs as outer forms for the structural concrete.

Architectural Concrete Slabs, made with Atlas White cement, are only 2" to 2½" thick. They are strongly reinforced and precast in sizes up to 100 square feet and larger. They are thin and comparatively light, and so may be handled with ordinary stone-setting derricks. Because returns, cornices, sills, lintels, and lugs for anchoring may be cast integrally with the slabs and because the slabs are large in area, there are fewer joints—thus minimizing the danger of leakage and reducing the cost.

As shown in the illustrations, slabs also may be used as forms, thus pour-

ing a building into its own skin. On jobs where a satisfactory bond was obtained between slab and concrete, half the slab thickness was considered effective structurally.

Almost unlimited design possibilities and a wide selection of shapes, colors, and textures are yours with thin, precast Architectural Concrete Slabs, made with Atlas White cement. The new 28-page book, "Architectural Concrete Slabs," has detailed drawings, full-color illustrations, installation pictures, and complete descriptions. For your copy, write to Universal Atlas Cement Company (United States Steel Corporation Subsidiary), Chrysler Building, New York City.

OFFICES: New York, Chicago, Albany, Boston, Philadelphia, Pittsburgh, Minneapolis, Duluth, Cleveland, St. Louis, Kansas City, Des Moines, Birmingham, Waco.

AR-ACS-39

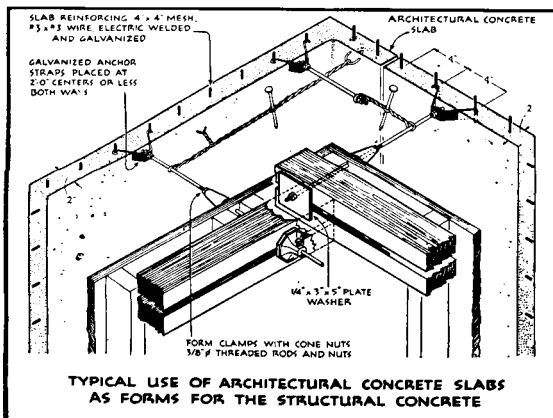

Prefabricated ARCHITECTURAL CONCRETE SLABS



made with
ATLAS WHITE CEMENT

THE RECORD REPORTS

(continued from page 10)

Board through issuance of Schedule V, as amended, of Limitation Order L-42.

Under the amended schedule, no copper or copper base alloy shall be used in the manufacture of any fittings or trim except for limited amounts in 24 specified items. The copper content of several of these items is reduced from that permitted in the original schedule, with the result that a saving of more than 600,000 pounds of copper a quarter is expected.

Other than for coating, no zinc is to be used except for the manufacture of items specified. No metal shall be used in the manufacture of items specified in a third list.

A general exception from the restrictions of the schedule is made for products manufactured for laboratories, food packing establishments, hospitals, aircraft and ships where conditions require the use of the restricted materials. The schedule becomes effective July 5, 1943.

MATERIAL REDISTRIBUTION

Where construction projects are halted through the issuance by WPB of revocation or stop orders, contractors will be advised in the future to contact redistribution officials of the appropriate regional office in regard to disposal of material purchased for projects which have been halted. The Redistribution Division of WPB will assist contractors in disposing of material and equipment made available in this way. A paragraph embodying this suggestion to contractors will be added to revocation orders issued in the future.

ASBESTOS RESTRICTIONS CHANGED

The restrictions of Conservation Order L-41, which control wartime civilian construction, no longer will apply to certain re-roofing and re-siding jobs where asbestos roofing and siding materials are used, WPB has announced. This action is authorized by Supplementary Conservation Order L-41-D, which eliminates the restrictions on the re-siding or re-roofing of a structure with asbestos materials where any part of the existing siding or roofing, as the case may be, is in need of maintenance or repair. It is provided, however, that no rubber, metal other

(continued on page 14)



4 breakers

TAKE THE PLACE OF 14

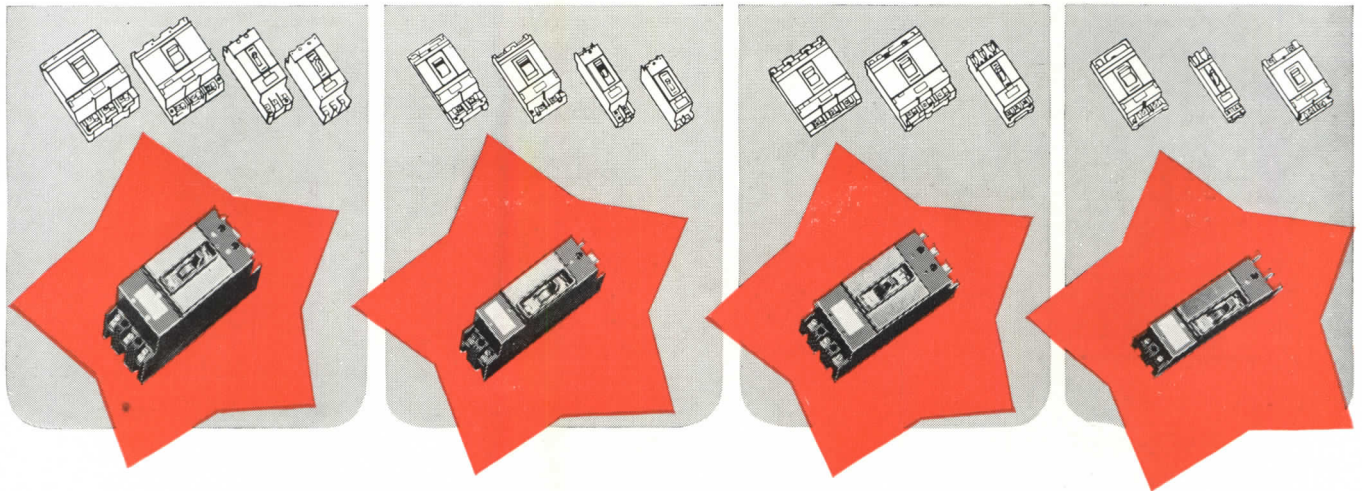

- TO SAVE 18% COPPER
- TO SAVE 38% STEEL
- TO CONSERVE SPACE
- TO IMPROVE CIRCUIT PROTECTION

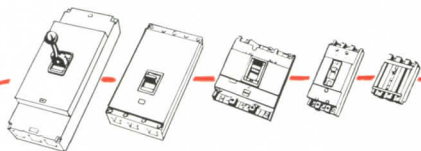

Nofuze "De-ion" Breakers



—prevent *harmless* overloads from interrupting war production.

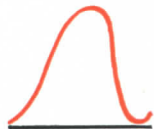

—protect circuits from *dangerous* overloads and "shorts."

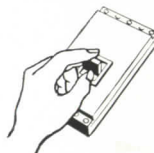

—restore service *instantly* with just a flip of the switch.

As a voluntary war measure, Westinghouse has "mobilized" the Nofuze line of "De-ion" Breakers. For example, all ratings from 15 to 100 amperes have been made available in one compact frame size. Instead of 14 models, 4 now serve the same purpose. Pole spacing and terminal arrangements have been made standard for interchangeability. Space is saved—vital materials are conserved.

Today, the production of Nofuze Breakers is concentrated on war requirements. Our engineering facilities are serving all branches of the war effort on a broad consulting basis.

Result: many far-reaching developments are being made ... overload protection of low-voltage circuits has been greatly improved. If you have a war circuit problem, ask your Westinghouse representative for engineering help. Westinghouse Elec. & Mfg. Co., East Pittsburgh, Pa., Dept. 7-N. J-60523



Westinghouse

PLANTS IN 25 CITIES... OFFICES EVERYWHERE

NOFUZE CIRCUIT PROTECTION

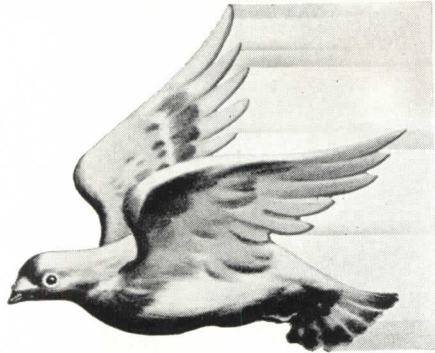

WITH BLUEPRINTS AND WITHOUT

The bird of nature is a creation without blueprints. The bird of man springs from his mind and hand as he works at the drawing board with pencils. The best drawing pencil is none too good for this work. We believe we furnish that indispensable part in Dixon's *Typhonite ELDORADO drawing pencils.

**The new booklet describing the Typhonite process is offered to draftsmen. Write for your copy mentioning this publication.*

Pencil Sales Dept. 225-J6
Joseph Dixon Crucible Co.
Jersey City, N. J.

**TYPHONITE
ELDORADO**

THE RECORD REPORTS

(continued from page 12)

than fastenings, nor lumber shall be used in the re-siding or re-roofing.

This action does not remove any of the safeguards against excessive construction, but was designed primarily to relieve a situation which had developed in asbestos, and which was threatening to have a harmful effect on the war program. In mining one ton of long fiber asbestos suitable for textile and other war product uses, many tons of shorter fiber must be produced. In the past this shorter fiber has always found its major outlet in the manufacture of asbestos-cement shingles and sidings. Because of the previous restrictions imposed by L-41 on such shingles and sidings the utilization of short fiber asbestos was greatly reduced and a critical shortage of long fiber was threatened. It is to re-establish the outlet for the shorter asbestos fiber that the sale of asbestos-cement shingles and sidings for re-roofing and re-siding is now permitted without restriction if a building is in need of re-painting or other maintenance and repair.

DEMobilIZATION OF ARMED FORCES

Measures which the Canadian government already has put into effect to reestablish members of its armed forces after their demobilization were described by Brigadier General H. F. McDonald, Chairman of the Canadian Committee on Demobilization and Rehabilitation, in a recent address in Washington before members of the Conference on Postwar Adjustment of Civilian and Military Personnel and others interested in U. S. manpower and demobilization problems. The address has now been published in pamphlet form by NRPB, under whose auspices the conference was held.

Among the measures already in effect in Canada, General McDonald said, are provision of free hospital and medical treatment for a period of 12 months after discharge; provision of vocational training and guidance facilities with maintenance allowances during that period; assisted Land Settlement and Rural Holdings; completion of interrupted academic or professional education; special training and vocational facilities for the

(continued on page 98)

STEAM Heats
America—

at war!



RECRUIT for the tanker fleet . . .

Giving oil the right of way . . .

Completing the bridge of ships.

The shipyards of America and the allied marine industries are meeting production schedules on the great new tanker fleet.

In the flow of materials to the shipyards—pumps, gauges, propulsion machinery, motors—steam heating is playing a vital role by properly heating supplying plants to insure maximum production.

Steam, harnessed and brought under control with Webster Steam Heating Equipment, is doing an outstanding heating job in thousands of war plants, providing economy and trouble-free operation, keeping workers efficient.

Today, Webster is engaged in direct war work and in supplying Steam Heating Equipment for buildings serving the war effort and essential civilian needs.

Repairs and replacements for Webster Systems are available under W. P. B. Order P-84.

Warren Webster & Company, Camden, N. J.
Representatives in principal U. S. Cities



Webster
Steam Heating

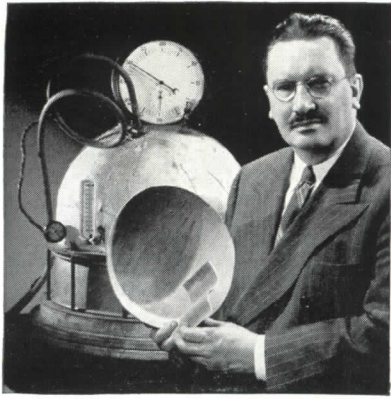

Egmont Arens, top-flight New York industrial designer, knows whereof he speaks. An expert on plastics, he has set up a small autoclave (above) in his studio for research on plywoods, laminated fibres, cloth and pulp. He has applied for several patents on these constructions.

FROM THE HULL OF A PT BOAT... "ENGINEERED" LUMBER BY THE MILE?

TYPICAL of many wartime advances in plastics materials and techniques are the Navy's deadly PT boats—precisely formed today from large sections of lightweight, plastics-bonded plywoods.

Equally typical of much of today's creative thinking about how plastics can contribute to a better postwar world tomorrow is this suggestion from Industrial Designer Egmont Arens.

The PLYFOLD structural lumber he visualizes would be produced almost literally by the mile...in continuous line production...

from plys of wood veneer and plastics-impregnated bonding film...wound transversely over an oval-shaped mandrel.

"Free from knots and flaws, PLYFOLD lumber could be built to exact engineering specifications with more uniform performance under load than dimension lumber," Mr. Arens points out. "It would have greatly increased strength for its weight, actually approaching steel or aluminum in strength per pound. Being permeated with plastics resins, it would be more permanent and much more resistant to warpage, rot or insect attack than lumber as Nature provides it."

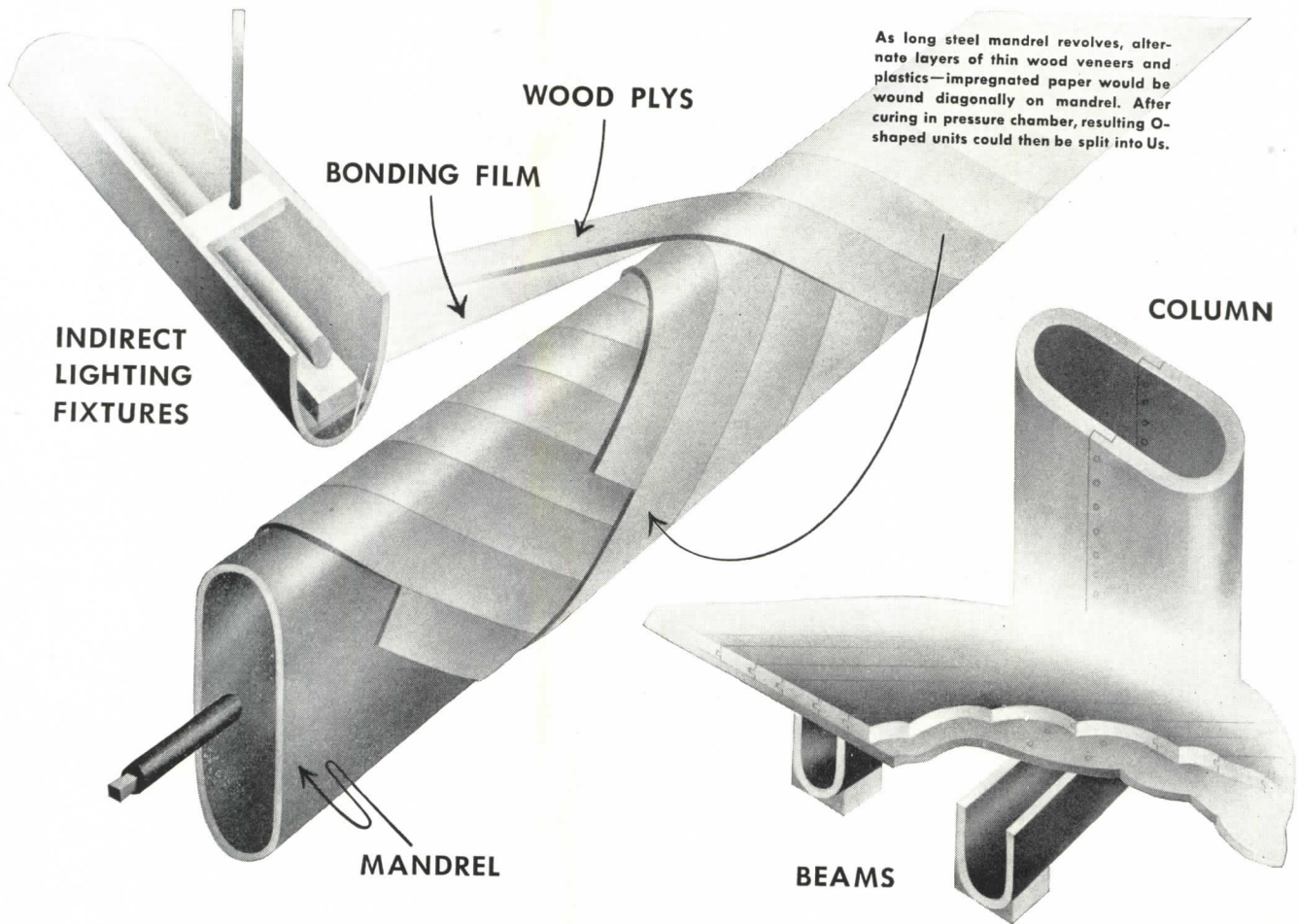

The Broad and Versatile Family of Monsanto Plastics

(Trade names designate Monsanto's exclusive formulations of these basic plastic materials)

LUSTRON (polystyrene) • SAFLEX (vinyl acetal) • NITRON (cellulose nitrate) • FIBESTOS (cellulose acetate) • OPALON (cast phenolicresin) RESINOX (phenolic compounds)

Sheets • Rods • Tubes • Molding Compounds • Castings • Vuepak Rigid Transparent Packaging Materials



Postwar Plastics and YOUR Future

Perhaps you see no immediate tie-up between Mr. Arens' PLYFOLD and the products you hope to offer postwar markets. His suggestion is offered, however, as an indication of the vast new peacetime horizons which wartime advances in plastics materials and techniques will open up for scores of industries. Particularly, it illustrates the stimulating possibilities of new plastics in combination with older, traditional materials.

When the time comes to talk "future" in your shop you will find Monsanto, as one of the nation's largest producers of plastics, an excellent source of reliable information. MONSANTO CHEMICAL COMPANY, Plastics Division, Springfield, Massachusetts.

PROPOSED POSTWAR HOUSING PROJECT

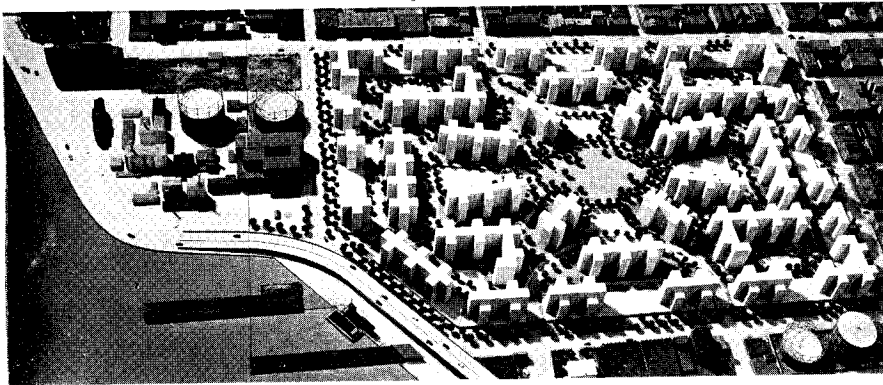

Model of proposed Stuyvesant Town Housing Project shows well-planned landscaping

THE City Planning Commission of New York has approved the \$50,000,000 Stuyvesant Town housing development which the Metropolitan Life Insurance Company proposes to erect on Manhattan's lower east side at the end of the war, and has designated as substandard and suitable for low-cost housing the 18-block, 67-acre tract selected for the project. The plan will come before the Board of Estimate at a public hearing on June 3. If approved, this will be the first large housing project to be built under the Redevelopment Companies Law.

Soundly planned, and basically in harmony with the urban redevelopment plans being drawn up throughout this country, in England, and elsewhere, the project has nonetheless been widely criticized, particularly for its high population density and for its failure to include a public school within its bounds. The only dissenting vote cast by the City Planning Commission—that of Planning Commissioner Lawrence M. Orton—was on the latter score. Commissioner Orton said frankly that he would have voted with the majority had provision been made for adequate school facilities within the area—this in spite of his further objection that the project does not conform with the building bulk and density standards of the city's master plan.

A group of 23 New York architects and planners sent the City Planning Commission a resolution protesting "most energetically at the proposal to define the area of the land under discussion as a Housing Area of Type I (allowing 416 persons to the net

acre), because they feel that such a density is inhuman, anti-social and uneconomic." Proponents of the plan, however, point out that with a total estimated population of about 24,315, the population density per net residential acre would be 397. This is still well above the average for Manhattan. The present population of the area in question is about 11,000, having declined steadily from the 1920 high of 27,000.

The proposed development would consist of 35 buildings, each 13 stories in height, with 10-story wings

forming setbacks along the border streets. Over half of the 8,842 apartments would be 3-room suites, the majority of the rest 4-room, and 400 of them 5-room. All buildings would be fireproof, equipped with push-button elevators, incinerators and ventilating ducts. Each apartment would have an entry hall closet, a linen closet, two closets for bed room No. 1, and a single closet for any other bed room. Basement and perambulator storage space would be provided. One-story garages around the periphery of the area would house 3,000 cars in addition to the outdoor parking facilities for about 400 cars.

The buildings would cover only 25 per cent of the total area, the remainder being given over to parks, shaded walks, drives, and heavy duty paths, with eight conveniently located playgrounds. Vehicular traffic would enter or leave the area through eight roadways, two on each side, in the form of separate loops.

Members of the Board of Design for the project were: R. H. Shreve, Chairman; Andrew J. Eken, George Gove, Gilmore D. Clarke, Russell H. Hunter, Robert W. Dowling, Irwin Claven, and H. F. Richardson.

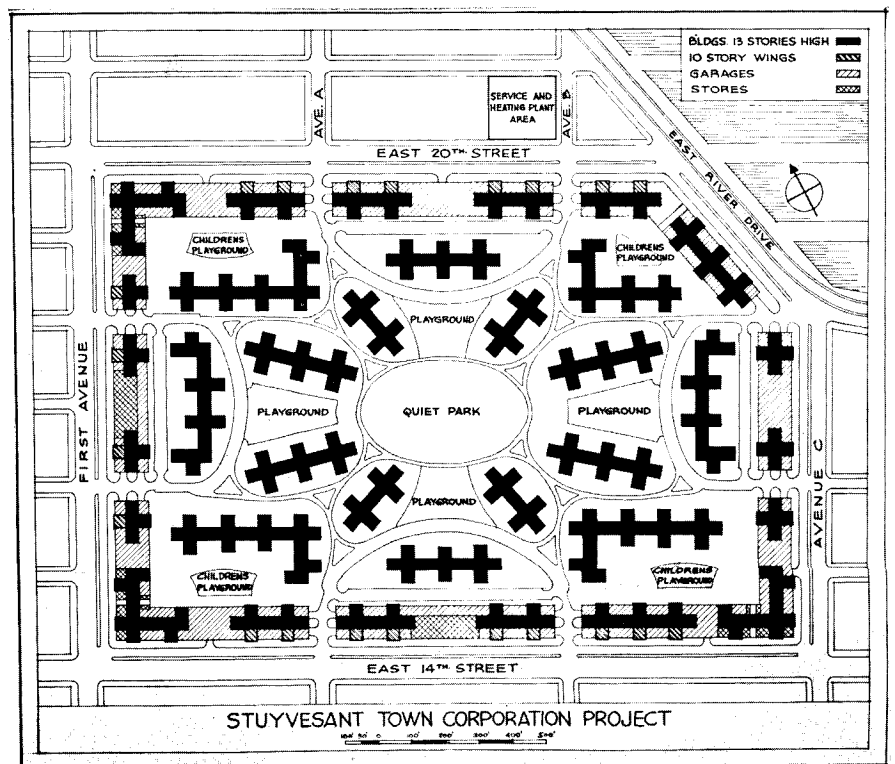



precision . . . from furnace to mould

★ Men of many years experience and "KNOW HOW" plus laboratory control through every phase of our foundry work—correct metal mixtures and strict regulation of pouring temperatures, are some of the reasons for the consistently high quality and uniformity of STREAMLINE Fittings. PRECISION STARTS WITH THE CORE AND ON FROM FURNACE TO MOLD AND MACHINE SHOP.

STREAMLINE Fittings and Copper Pipe are now in the service of our country for many purposes. They are installed in naval vessels of practically all types,

including victory ships, subchasers, submarines, mine sweepers, etc. A tremendous amount of Copper Tubing, which in peace years provided peak performance in many of the best plumbing and heating systems in America, is now installed in the great majority of Tanks built in the United States and Canada.

When peace returns to the world, the plumbers and steamfitters of America will again install STREAMLINE Fittings and Copper Pipe to protect the health of the nation as they are now helping to protect the lives of our men in our armed forces.

1. Pouring the Metal.
2. Pyrometer reading for measuring temperature.
3. Pouring the moulds.

STREAMLINE
 PIPE AND FITTINGS DIVISION
MUELLER BRASS CO.
 PORT HURON, MICHIGAN



IT'S THE FIRST 60 SECONDS THAT COUNT

Sentinel...

against the unforeseen

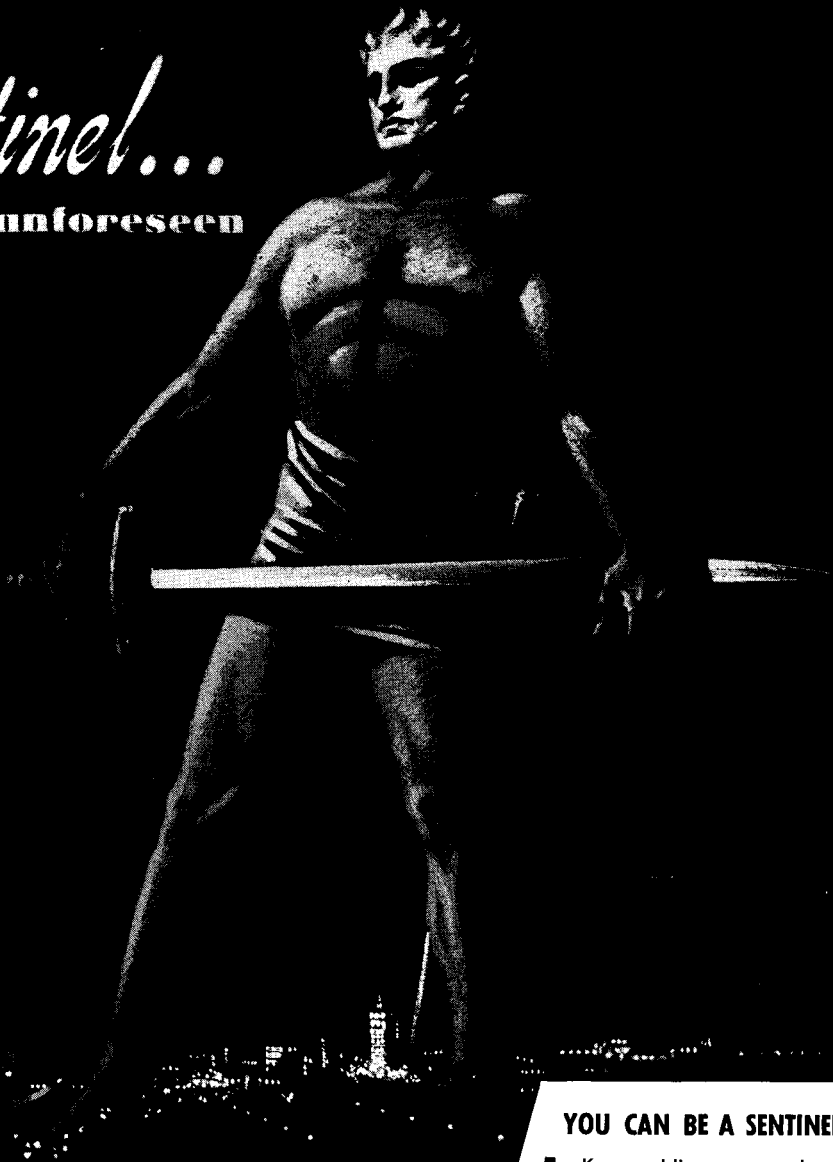

DESPITE all precautions of utility companies, circumstances beyond their control may cut out electric power and light at unforeseen moments. Storms, floods, fires, and street accidents are just a few examples of this... but Exide Emergency Batteries stand as sentinels to protect American Industries.

Naturally, in war-time it's important to protect the sentinel who is protecting you. Exide Batteries are easily guarded by a few simple steps... which help to save metals for war industry. Follow these rules to protect your batteries, and remember, Buy to Last and Save to Win!

THE ELECTRIC STORAGE BATTERY CO., Philadelphia
Exide Batteries of Canada, Limited, Toronto

YOU CAN BE A SENTINEL, TOO

1 Keep adding approved water at regular intervals. Most local water is safe. Ask us if yours is safe.

2 Keep the top of the battery and battery container clean and dry at all times. This will assure maximum protection of the inner parts.

3 Keep the battery fully charged—but avoid excessive over-charge. A storage battery will last longer when charged at its proper voltage.

4 Record water additions, voltage, and gravity readings. Don't trust your memory. Write down a complete record of your battery's life history. Compare readings.

If you wish more detailed information, or have a special battery problem, don't hesitate to write to Exide. We want you to get the long-life built into every Exide Battery. Ask for booklet Form 3225.

Exide
EMERGENCY
BATTERIES

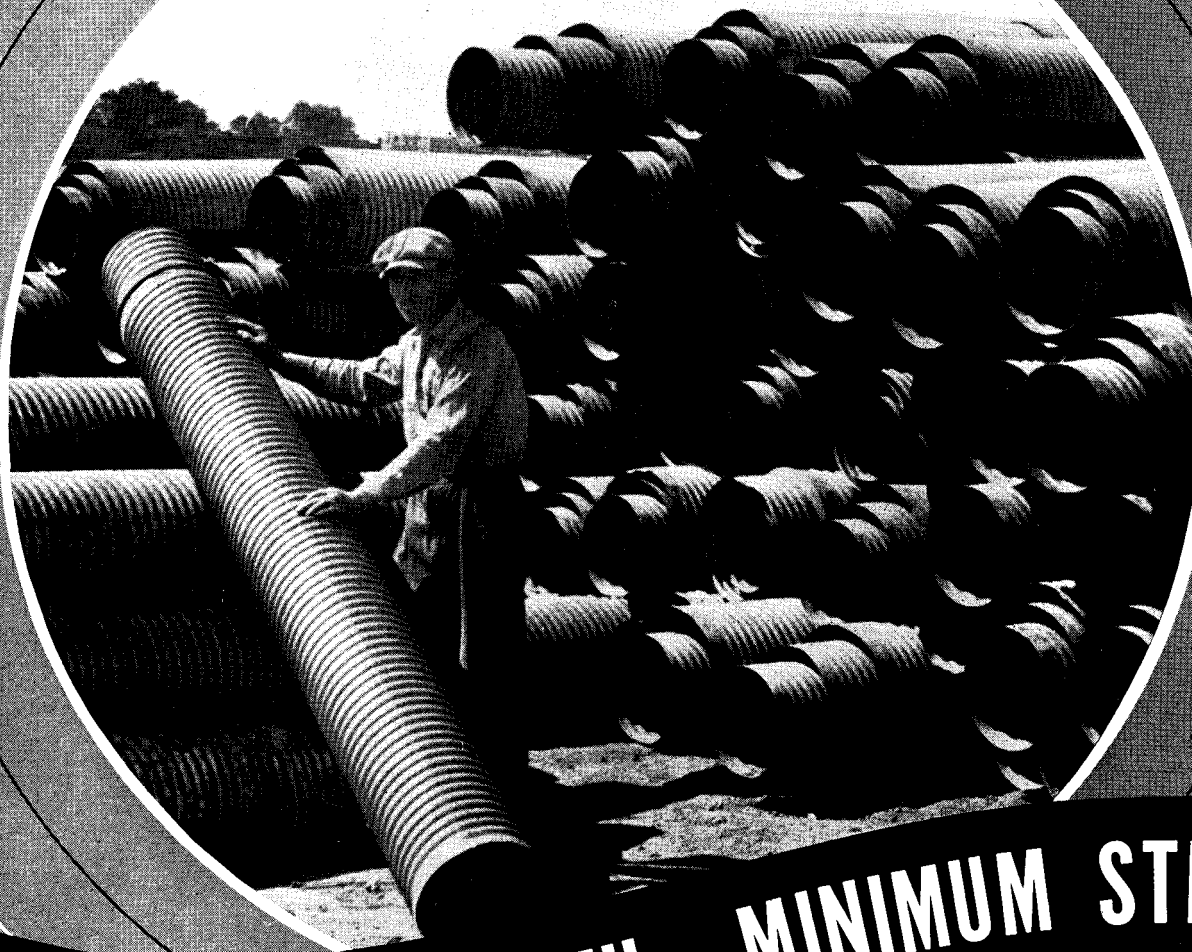

MAXIMUM STRENGTH... MINIMUM STEEL

Engineers know that a circular enclosure produces the maximum of strength per pound of material used. Likewise a Raymond pile not only produces the maximum strength but requires the minimum amount of steel. Steel is essential for carrying on war. How to conserve the use of this vital war material without sacrificing good engineering principles and structural strength is an important problem. Raymond's 46 years of technical experience, plus its practical knowledge in the design and construction of pile foundations enable us to suggest methods of using the minimum amount of steel to accomplish the desired results. On your next foundation project, consult Raymond and help to conserve WAR ESSENTIAL STEEL.

THE SCOPE OF RAYMOND'S ACTIVITIES

includes every recognized type of pile foundation - concrete, composite, precast, steel, pipe and wood. Also caissons, construction involving shore protection, ship building facilities, harbor and river improvements, borings and soil investigation.

RAYMOND CONCRETE PILE
COMPANY •

140 CEDAR STREET • NEW YORK, N. Y. Branch Offices in Principal Cities.

LOCKWOOD HARDWARE

says
"Welcome"
at
Washington's
Hotel Statler

BESPEAKING the rich simplicity and dignity of this modern hotel, the hardware is finished in natural dull bronze, wet scoured and "permanized."

Shown at right are the main entrance and shop door set with Lockwood Cylinder Lock and thumb latch; the plain handle set; and the substantial large knob used on first and second floors. Note the absence of screws in the escutcheons. Holabird & Root, the architects, created the simple dignified hardware designs, which Lockwood Engineers produced with many ingenious hidden holding devices.

Lockwood Builders' Hardware is engineered to fulfill every requirement—from design to durable security. Available now only for direct war work, you will still find us ready to plan with you for the day when Victory is assured.



JOHN W. HARRIS, INC.
NEW YORK CITY
General Contractors

HOLABIRD & ROOT
CHICAGO AND NEW YORK
Architects

Lockwood Hardware Mfg. Co.

Division of Independent Lock Co.

Fitchburg, Massachusetts

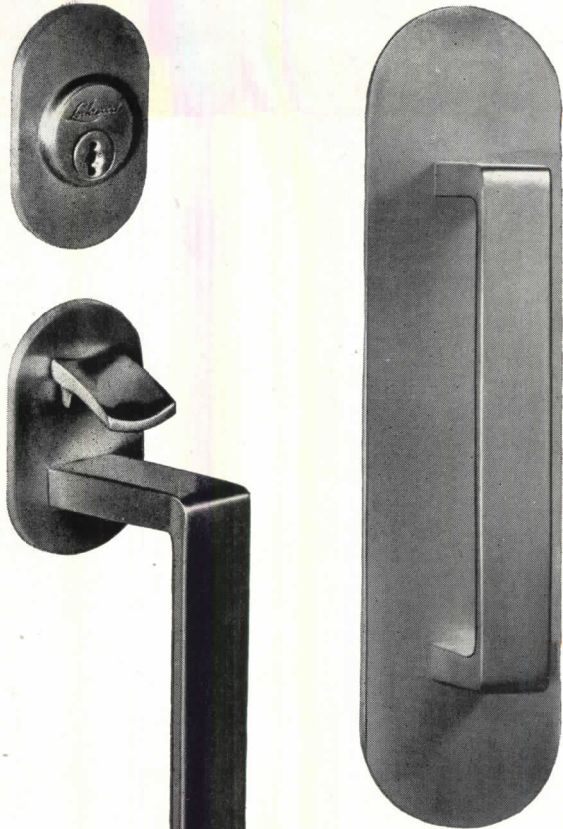

Plain door pull with simple escutcheon with rounded ends. Note absence of plate holding screws.

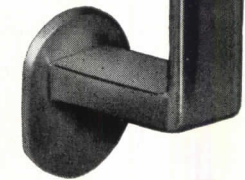

Entrance Thumb Latch Set with Lockwood Cylinder Lock and off-set hand pull, used on main entrance and shop doors.

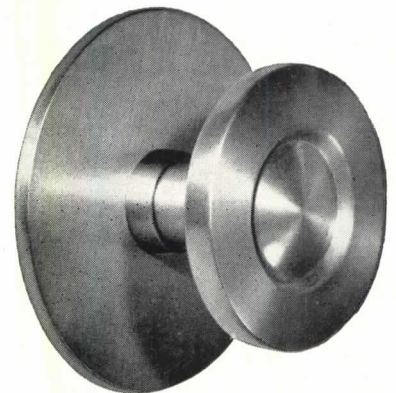

Rich, over-size round knob and round escutcheon, used on heavy doors on first and second floors. Note the absence of plate holding screws.



BREIDERT Air-X-Hausters

Look like
a million dollars, *but will they work?*

ASKED THE VENTILATING EXPERTS

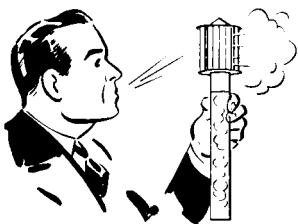

USES ONE OF NATURE'S LAWS... The design utilizes the principle that air always rushes in to fill a vacuum. Wind currents striking the ventilator create a vacuum which causes stale air to be sucked out.

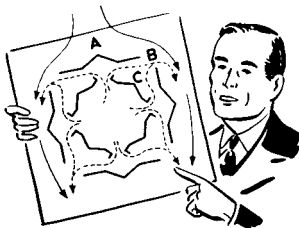

SIMPLE, BUT EFFECTIVE... Plan of Breidert Air-X-Hauster. Wind strikes V-shaped faces (A) and is deflected away and across outlet openings (B), creating suction action. Inner baffles (C) repeat this action regardless of which direction wind comes from.

NO MATTER WHICH WAY THE WIND BLOWS... Unlike conventional ventilators, the Breidert Air-X-Hauster provides positive ventilation regardless of wind direction. With other ventilators, wind striking at various angles other than horizontal causes back-drafts and prevents positive ventilation.

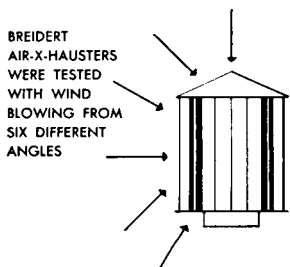

WHEREVER THERE IS A VENTILATING JOB TO DO... Breidert Air-X-Hausters are used on all types of buildings: residential, industrial and commercial. Many Army barracks and cantonments, defense housing projects and other government buildings are equipped with them.

Breidert Marine Air-X-Hausters for both deck and porthole use on all types of ships are also available. They are used on many Navy vessels, providing positive ventilation in all weather.

FOR COMPLETE INFORMATION about this revolutionary ventilator, see Sweet's 1943 Catalog File, Architectural. Write us for literature and Engineering Data Book containing all specifications and certified capacity ratings. Amazing demonstration, using actual models, given upon request. Address Dept. T.



...and then... this revolutionary ventilator proved conclusively that with no fans and no moving parts, *it provides positive ventilation and eliminates back-drafts no matter which way the wind blows!* It succeeds where conventional gravity ventilators fail!

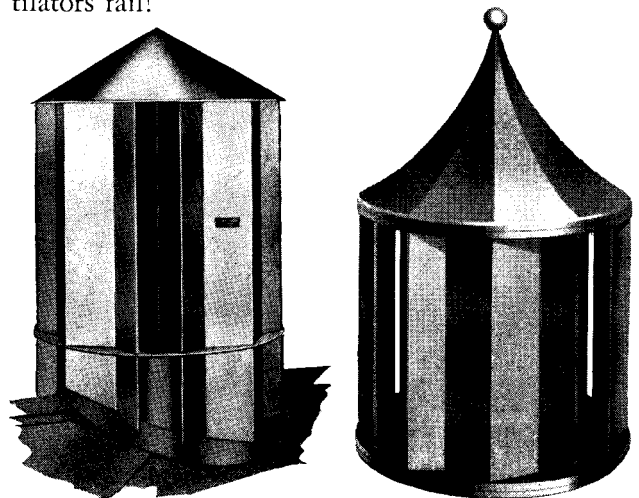

TYPE "A"

TYPE "B-W"

Several types of metal and wood Breidert Air-X-Hausters are available. Shown are the Type A, left, especially recommended for homes or buildings where the most attractive appearance is desirable; and the Type B-W, right, made of high-grade wood (not veneer) kiln-dried and treated with wood preservative. Using no critical materials, the Type B-W has longer lasting qualities when properly painted than ordinary sheet metal ventilators under severe weather or chemical conditions. Its cap or steeple may be changed to harmonize with any type of architecture.

Manufactured by **G. C. BREIDERT CO.**

Offices: 634 South Spring St., Los Angeles, Calif.

42 REPRESENTATIVES IN PRINCIPAL CITIES

Twenty million dollars'

ALREADY COMPLETED

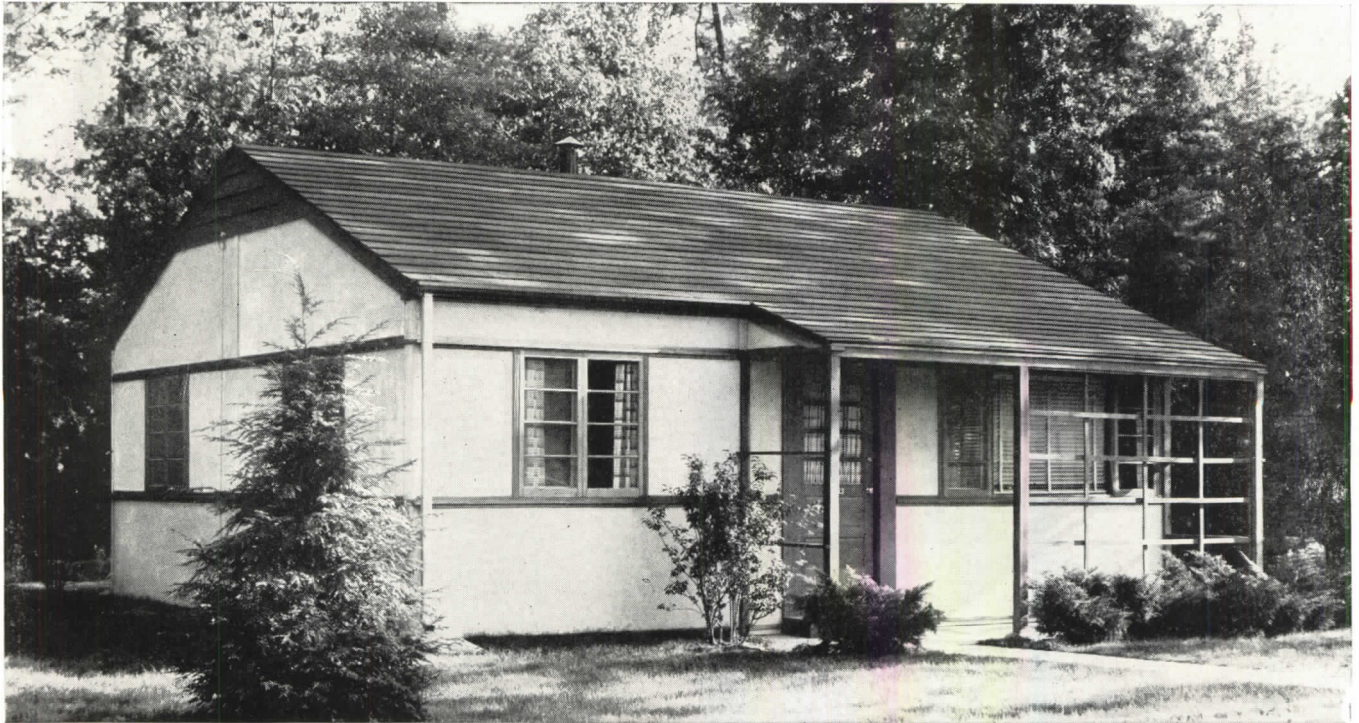

Meet All Government Requirements as to Critical Materials, Structural Stability and Heat Loss Factors

**Ideally Suited
for Operative Builder
Developments or Group
Housing by Industries**

—
**SHOP FABRICATION OR
SITE ASSEMBLY METHODS
WILL BE EXPLAINED
BY CELOTEX ENGINEERS**

CEMESTO combines exterior and interior finish, plus insulation, in a complete fire-resistant wall unit of remarkable structural strength. Celotex Roof combines sheathing, insulation, and roofing. These two new multiple-function products and the Cemesto house they have made possible are the results of twelve years' research.

Up to now more than twenty million dollars' worth of Cemesto homes have been completed and occupied. More are under construction. And these

are all *sturdy* homes, speedily and economically built because they are pre-engineered for mass production.

The Cemesto house makes use of ideas used in prefabrication to cut construction costs to a minimum. It meets rigid government requirements as to critical materials, heat loss factors, and structural stability. It is ideally suited to any project involving group housing. A Celotex engineer will gladly call to present full particulars if you will write us describing the project you have in mind.

CELOTEX
REG. U. S. PAT. OFF.
CEMESTO
REG. U. S. PAT. OFF.
INSULATING WALL UNITS

T H E C E L O T E X C O R P O R A T I O N

worth OF CEMESTO HOMES AND OCCUPIED!

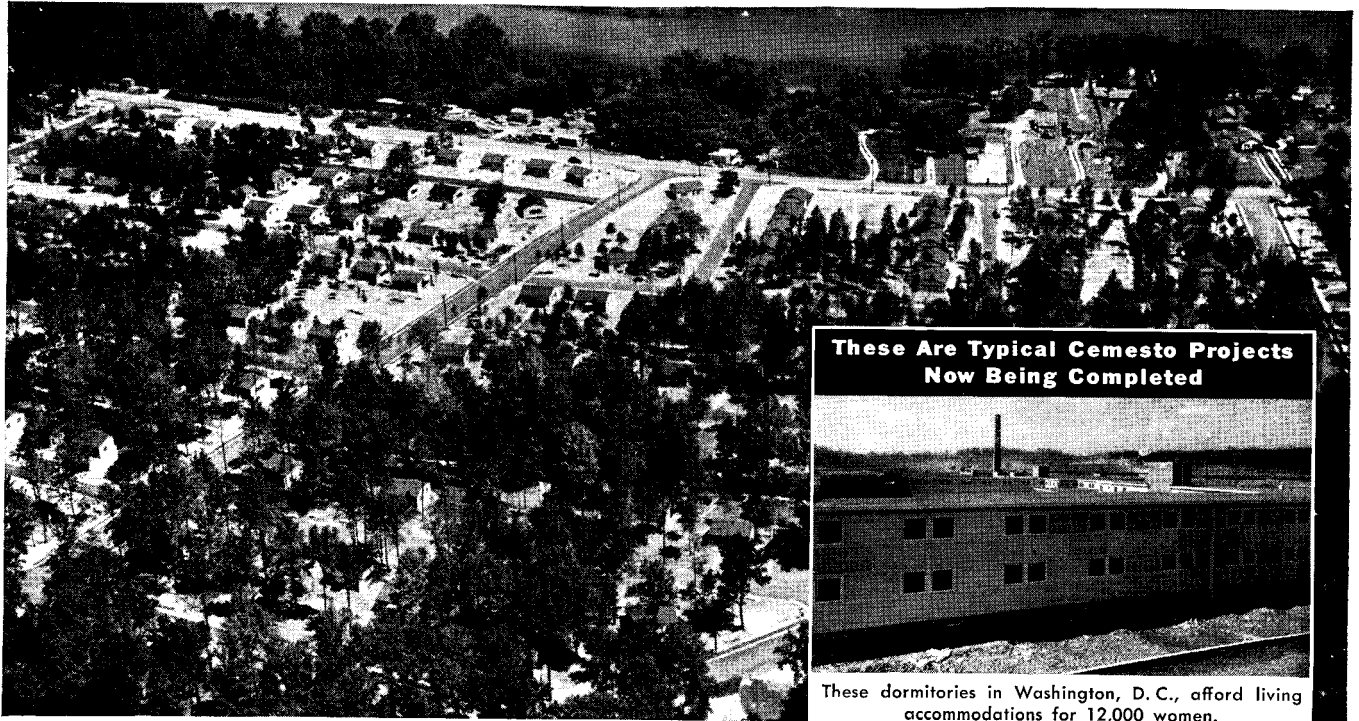

**These Are Typical Cemesto Projects
Now Being Completed**

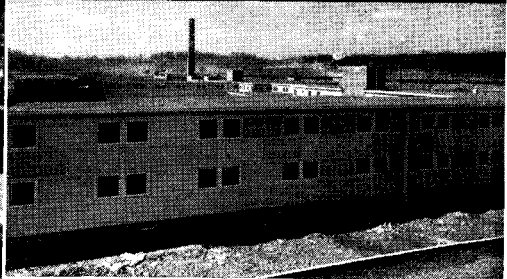

These dormitories in Washington, D.C., afford living accommodations for 12,000 women.

Sturdy, Comfortable, Economical Homes for Thousands of War Workers

12 Great Housing Projects In These States: Maryland, Florida, Michigan, Mississippi, Alabama, Texas, and the District of Columbia. Also in Alaska.



Here is one section of Cemesto housing units which comprise one Florida development.



Cemesto construction is sturdy and economical. Houses are finished at the rate of 20 a day.

CELOTEX
REG. U. S. PAT. OFF.
CEMESTO
REG. U. S. PAT. OFF.
INSULATING WALL UNITS



THE CELOTEX CORPORATION, CHICAGO AR 6-43
Please send FREE booklets as checked:

- "A Vital Contribution"—28-page booklet in full color telling the Cemesto story.
- "Cemesto with Wood Framing"
- "Cemesto with Steel Framing"

Name.....

Address.....

City..... State.....

CHICAGO

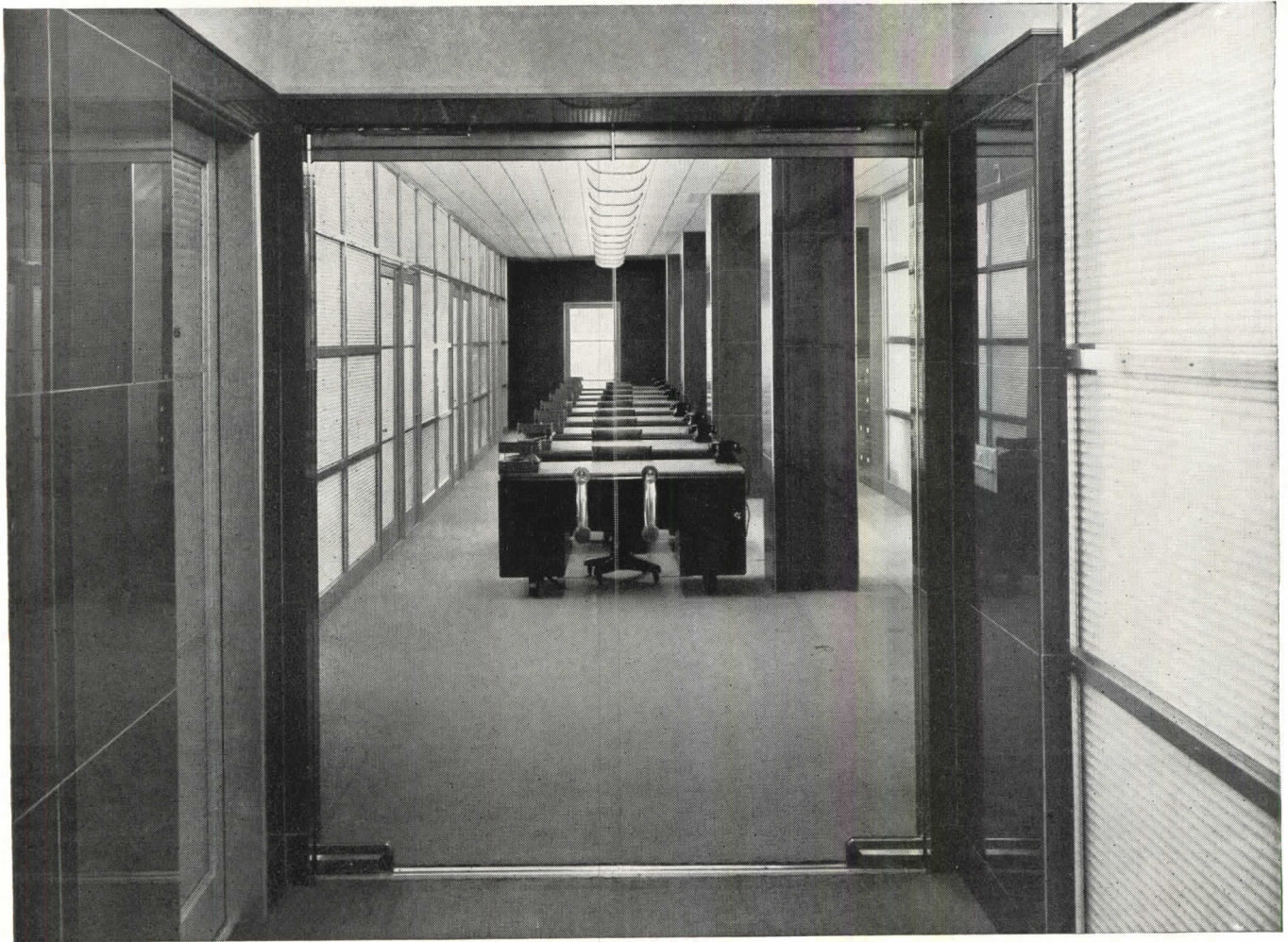

HOW TO ENGINEER DAYLIGHT INSIDE

In offices, homes, schools, stores . . . wherever people work . . . an entirely new atmosphere can now be created through use of *daylight engineering* principles.

Our own offices, illustrated above, are an example of daylight engineering. Here, the walls of the outside offices have been built of decorative, translucent glass. Daylight is not trapped in any one office. It is shared by all. Even the inside general stenographic space is flooded with outside light.

Larger window areas properly teamed with trans-

lucent walls or partitions and mirrors brighten up rooms, closets and corridors. Eyestrain conditions can be removed. Even the smallest rooms can be given a feeling of spaciousness never before enjoyed. It's engineered with glass.

Libbey·Owens·Ford glass for windows, mirrors, wainscoting and work surfaces, and Blue Ridge Glass for partitions, are available in a wide variety of types and colors. Be sure your records of L·O·F Glass are complete. Libbey·Owens·Ford Glass Company, 2363 Nicholas Building, Toledo, Ohio.



LIBBEY·OWENS·FORD

A GREAT NAME IN

Glass

MAKE THIS TEST -
Prove **BRIXMENT is BEST!**



1 Above: A cylinder of Brixment mortar (left) and a cylinder of mortar made with 50-50 cement and lime mortar (right). Both specimens were made at the same time, and subjected to exactly the same treatment. After curing for 30 days, $\frac{1}{4}$ " of water

was put into the tray and the cylinders were alternately frozen and thawed 15 times. Note in photo 2 that Brixment mortar remains intact, whereas the other mortar has crumbled badly. This simple test can be made in any ice-manufacturing plant. **2**

BRIXMENT *Makes* **More DURABLE Mortar!**

FOR permanent strength and beauty, mortar must be *durable*—must be able to withstand the alternate freezing and thawing to which it is subjected many times each winter.

Brixment mortar *is more durable*. This greater durability is due partly to the strength and soundness of Brixment mortar, and partly to the fact that Brixment is waterproofed during manufacture. This waterproofing helps prevent the mortar from becoming saturated—therefore protects it from the destructive action of freezing and thawing.

Walls built with Brixment mortar therefore *retain* their original strength and appearance. Even in

parapet walls and chimneys, where exposure is particularly severe, Brixment mortar will almost never require re-pointing.



BRIXMENT

For Mortar and Stucco

Louisville Cement Company, Incorporated, Louisville, Kentucky. Cement Manufacturers for Over a Century.

REQUIRED READING

By ELISABETH COIT, AIA



Chimu gold ceremonial knife, Peru. From "Medieval American Art"

MEDIEVAL AMERICAN ART. By Pal Kelemen. New York (60 Fifth Ave.), Macmillan, 1943. 2 v. 8¼ by 11 in. v.1: Text 414 pp.; v.2: plates, 17 pp. plus 306 pl. \$22.50

WROTE Albrecht Durer of the things brought from the "New Golden Land" to the Spanish Court: "I have never seen in all my days what so rejoiced my heart as these things . . . indeed I cannot say enough about [them]." We can now share in his delight: not only by reason of the treasure here assembled, but also because of the superbly skillful manner of the displaying.

So effortlessly do we read a smoothly-running text, enjoying a happy phrase, a precise description, a human interpretation, that we are astonished to realize presently that we have been reading a learned, detailed, documented work on a wide subject.

For "Medieval American Art" covers the significant in the cultures of peoples from Utah to Chile during the first fifteen centuries of what in Europe was the Christian Era—"pre-Columbian" is Mr. Kelemen's word for a period which came to an end with the arrival of the white man and the Christians' zealous destruction of the "heathen" art of the aborigines.

Format and arrangement make for

easy assimilation and convenient reference. In two volumes of equal size are arranged respectively some 400 pages of text and nearly 1,000 photographs. The ingenious and unusual arrangement of references and authorities might well be generally imitated. The type is large and clear, there is a map, and the arrangement of the strikingly beautiful photographs in 300 plates is in itself a work of art.

Still more so the writing. Mr. Kelemen planned his survey for "the reader generally interested in art," and under the five regions into which he has divided his territory he has enumerated, described and evaluated remains in architecture, pottery, weaving, metalwork, semiprecious stones, murals and manuscripts, etc. In architecture, for example, some 130 photographs and a splendid section of the text describe monuments in two score localities—to which total add many items classified with city planning or included with public baths and reservoirs, and monumental stairways. One chapter is entitled "Facets of Daily Life;" but the continual unobtrusive presentation of essential aspects of daily life—religious, economic, esthetic, the many mentions of miscellaneous applied arts, of tools and instruments used, and of the manner of work customary among the different peoples, while facilitating the student's work, will also delight that large public by no means particularly interested in art.

Much of this might have been achieved by the careful sifting of evidence and additions thereto, by a scholar uniquely qualified by his studies and explorations to do so, in a study charming by its arrangement, by its courteously judicial disagreement when necessary with earlier writers, its generous recording of contributions by anthropologist, archaeologist, astronomer, even destroying missionary, and the rest, on down—or up—to Zinsser. But what distinguishes this from just a scholarly, mannerly study is the author's uncommon ability to see with the eyes of a many-minded public, to record and interpret in few words, and this is perhaps the secret of a vivid vital style.

AN ENQUIRY INTO PEOPLE'S HOMES. London, W.1, (50 Albermarle St.) Murray, 1943. xxlv plus 228 pp., 5 by 7½ in., 10s.

RECONSTRUCTION AND TOWN AND COUNTRY PLANNING. By Sir Gwilym Gibbon, C.B., C.B.E. London, E.C.4 (2 Breams Buildings), 1942. 267 pp., 6 by 9¼ in., illus., 15s.

POST-WAR PLANNING IN BRITAIN . . . 1939-1943. New York (30 Rockefeller Plaza), Washington, D. C., Chicago, San Francisco, British Information Services, 1943. 80 pp., 6 by 9 in. Limited free distribution.

"POST-WAR PLANNING . . ." deals chiefly with unofficial organizations over a hundred in number, many of which have already made weighty contributions to the solution of tomorrow's planning problems. For these, in addition to mention in the classified main part of the book there is an alphabetical list with addresses and names of officials, as well as either a statement of objects or a reference to the organization in the classified section; and in spite of the sub-title "unofficial post-war planning" there is an illuminating introductory chapter giving a survey of ministries and officially appointed bodies dealing with postwar planning; and for many people not the least valuable feature of the work is the indication of items which may be found at the B.I.S. New York office.

The "Inquiry Into People's Homes," conducted by Mass Observation (a kind of Gallup Poll) for the Advertising Service Guild, is of great interest not only because of its findings and conclusions on people's preferences, but also for the method followed in the investigation. An impeccably impersonal flavor permeates the thirteen questions asked of every eleventh householder in about a dozen localities: tenants of old houses, recently developed estates, flats, garden cities, etc.; for Mass Observation felt that a certain amount of "leading" had found its way into questions of other investigators of home needs. Students of home design as well as those concerned with survey methods will note with interest the substantial agreement between results in the two types of investigation; and, incidentally, the similarity between the British and the American homemak-

(continued on page 28)

Opacity

PRINTS ARE WHAT THE PENCILS MAKE THEM

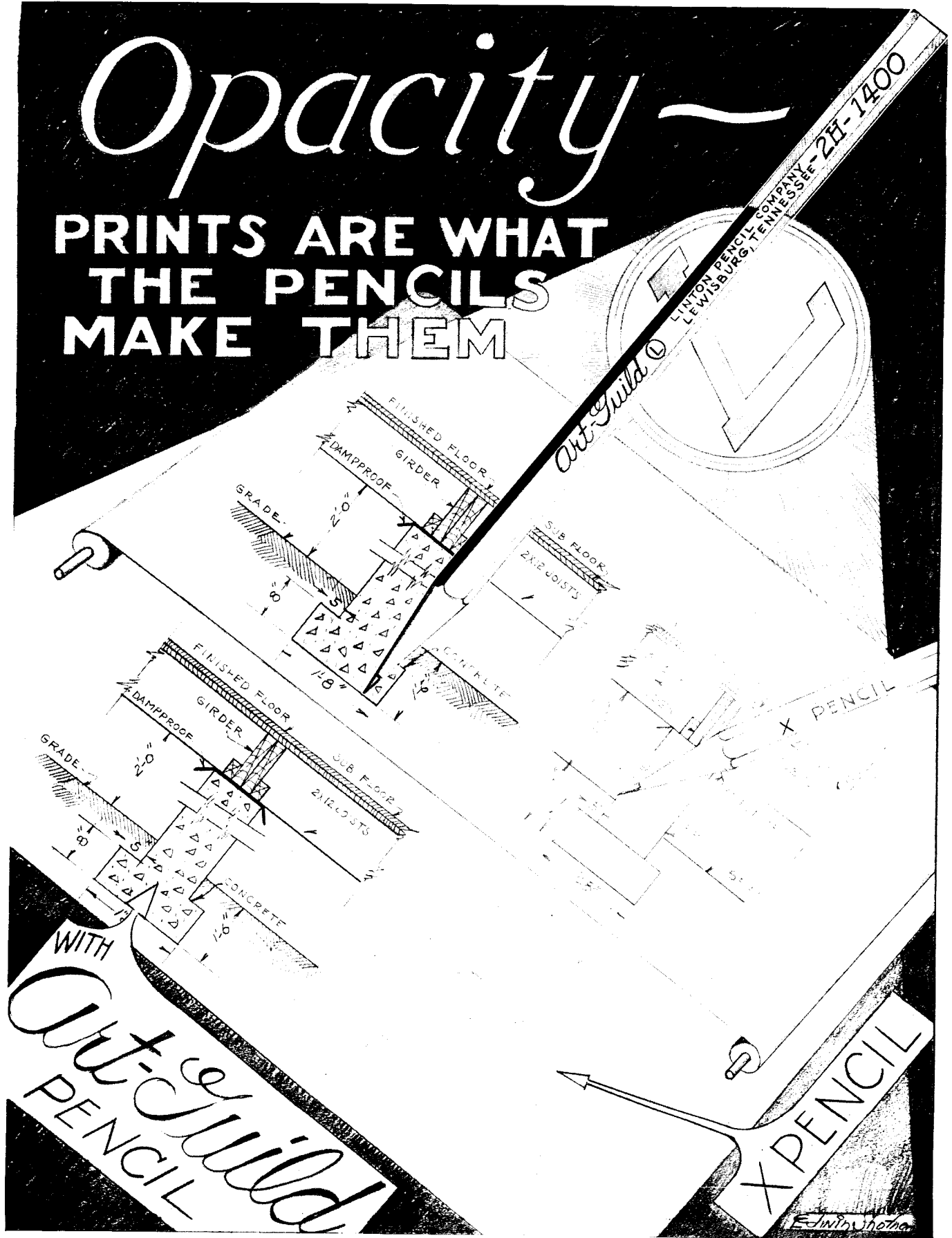

This drawing is one of a series made with Art-Guild BONDED LEAD drawing pencils

Art Guild pencils are available in 17 precision-milled degrees—6B to 9H. Beautifully finished in green lacquer, they come neatly packed in a metal box.

Try them at our expense. We will gladly send you a few Art Guild pencils for personal test. Just drop us a note on your letterhead, specifying the degrees you prefer.

LINTON PENCIL CO., Lewisburg, Tenn.

SALES OFFICES

112 West Ninth Street
Los Angeles, California

38 South Dearborn Street
Chicago, Illinois

3525 Southwestern Boulevard
Dallas, Texas

RE-LIGHTING

the new **manpower** *requirement*
production

HERE'S ONE ANSWER
to this problem...



Because most plants operating today were designed for peacetime, *daylight* working schedules, *their lighting equipment is inadequate for night work!*

The folder illustrated gives one answer to industry's problem of *re-lighting*. Silv-A-King's new fluorescent reflectors of non-critical, metal-saving Silv-A-Tex are durable, efficient, inexpensive, and available for prompt delivery. For complete descriptions and specifications of Silv-A-King "Victory" units, write for a copy of "Catalog 43-V" today!

BRIGHT LIGHT REFLECTOR COMPANY, INC.
308 Morgan Avenue, Brooklyn, N. Y.



SILV-A-KING MAKES *Light* WORK FOR YOU

REQUIRED READING

(continued from page 26)

ers' desires: predominantly one-family or semi-detached homes with gardens and privacy; really serviceable equipment and layout; absence of any expressed wish for luxury or semi-luxury features; a strong desire to continue in the same type of home (though better equipped) in the neighborhood dear by reason of friends and familiar scenes.

Few people are as well equipped to set forth the larger aspects of reconstruction and planning as Sir Gwilym Gibbon, recently director of the Local Government Division of the Ministry of Health, who confesses to a goodly share of responsibility for developments during the past two decades. He combines understanding of the aims underlying work accomplished by his generation with knowledge of the obstacles in the way of greater and speedier achievement, and a fearless, independent, analytic attitude. His book is suggestive and inspiring to those concerned with cis-Atlantic planning; and the planning-minded will be glad that between the writing of the main part of the work and its publication, appeared the Uthwatt Report (Final Report of the Expert Committee on Compensation and Betterment) and the Scott Report (Report of the Committee on Land Utilization in Rural Areas) which gave opportunity for this able mind to analyze and evaluate two of the most exciting and radical documents of the day.

NEW FRONTIERS IN AMERICAN PAINTING. By Samuel M. Kootz. New York (67 West 44th Street), Hastings House, 1943. 65 pp. plus 89 plates, 8½ by 10½ in. \$5.00.

STRONG opinions clearly and forcibly expressed, canalizing present-day currents of American painting, thought-provoking and stimulating by its attack, its style and admirable format.

To Mr. Kootz the two great movements in art "after Cezanne" are Abstraction and Expressionism; but the emphasis of the work is on sensations and ideas rather than techniques. More space is given to Realism and the New Realism than to the methods the author prefers. Romanticism and "Class Struggle Painting" are handled in a couple of trenchant pages each; and Surrealism is discussed under the

(continued on page 30)

Ric-wil offers conduit for every need - the most complete line, meeting all conditions of service and cost

There is a Ric-wil insulated conduit system engineered to your specific needs—the transmission of steam, hot water, oil, hot or refrigerated process liquids—providing heat transfer with the lowest possible loss.

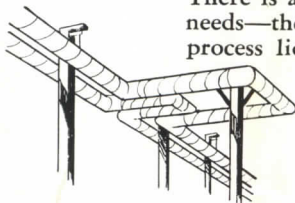

1. RIC-WIL INSULATED PIPE UNIT—SINGLE PIPE SYSTEM

Prefabricated complete units—pipe as specified, thoroughly insulated, in helical corrugated conduit, coated and wrapped with asphalt saturated asbestos felt. 21-ft. lengths for speedy installation. For underground or overhead systems.

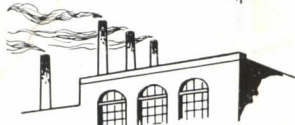

2. RIC-WIL INSULATED PIPE UNIT—MULTIPLE PIPE SYSTEM

Any specified combination of pipes in prefabricated conduit—insulated and protected the same as the single pipe system. Any or all of the pipe lines may be specially insulated to meet job requirements.

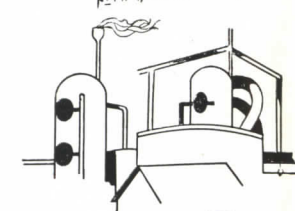
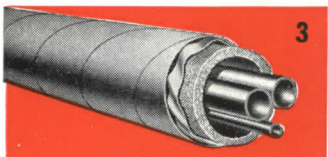

3. RIC-WIL INSULATED PIPE UNIT—FOR PROCESS LIQUIDS

An adaptation of the multiple system used where a steam or hot water line heats fluids in other lines. Pipes are insulated from the exterior but not from each other. Sizes and specifications as required—conduit same as for other insulated pipe units.

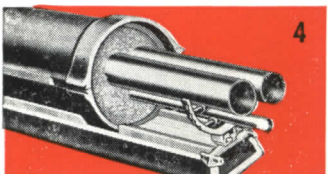

4. RIC-WIL STANDARD TILE CONDUIT—TYPE F

Vitrified glazed A. S. T. M. Standard Tile Housing—acid and waterproof—with foundation type base drain supporting weight of piping through correctly engineered pipe supports. Positive locked-in-place cement seals on sides and ends. For single or multiple pipes.



5. RIC-WIL SUPER TILE CONDUIT—TYPE F

Same advantages as Standard Tile but with walls approximately double thick for strength under heavy traffic or where overhead load is above normal. Will support concentrated static load of 6 tons per wheel under actual installation conditions. Base drain of extra-heavy tile.

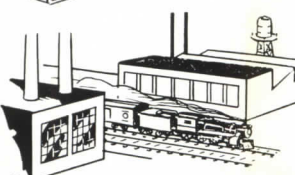
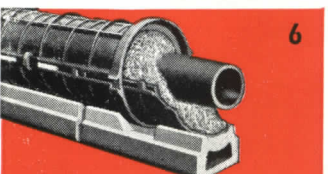

6. RIC-WIL CAST IRON CONDUIT—TYPE F

Heavy reinforced cast iron conduit for use where underground pipe lines run close to or under railroad tracks. Durable, water-tight and vibration-proof. Positive locked-in-place cement seals on sides and ends with metal clamps for extra tightness.

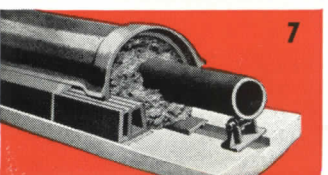

7. RIC-WIL TILE CONDUIT—UNIVERSAL TYPE

Where installation conditions dictate the use of a concrete pad Ric-Wil Universal Tile is recommended. Side walls are double-cell vitrified trapezoidal block design. Arch may be Standard Tile, Super-Tile, or Cast Iron.

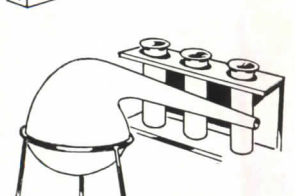

8. RIC-WIL TILE CONDUIT—TYPE DA

For oil or process liquids where conduit must be insulated but individual lines are not insulated from one another. Insulation is a diatomaceous earth lining, moulded and keyed to inside of tile. May also be used (Type DF) with fibre insulation for steam heat, power and superheated steam. Applicable to Standard, Super-Tile and Cast Iron.

Ric-wil accessories are available in all type systems; standard and special fittings, factory fabricated or field fabricated expansion devices, alignment guides, and anchors. Descriptive bulletins on request.

GET THE ORIGINAL—SPECIFY RIC-WIL

RIC-WIL INSULATED CONDUIT SYSTEMS
THE RIC-WIL COMPANY · CLEVELAND, OHIO
AGENTS IN PRINCIPAL CITIES

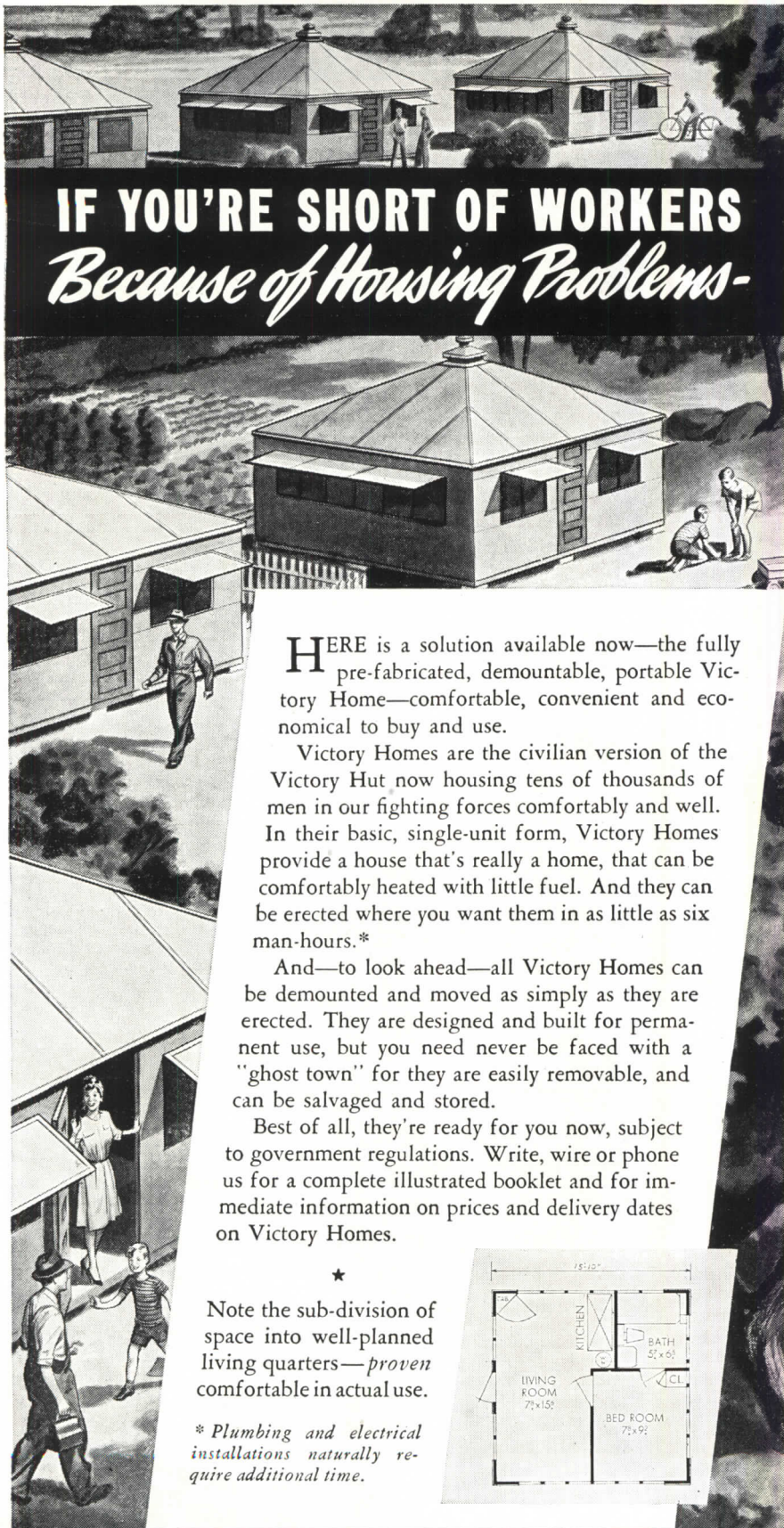

IF YOU'RE SHORT OF WORKERS *Because of Housing Problems-*

HERE is a solution available now—the fully pre-fabricated, demountable, portable Victory Home—comfortable, convenient and economical to buy and use.

Victory Homes are the civilian version of the Victory Hut now housing tens of thousands of men in our fighting forces comfortably and well. In their basic, single-unit form, Victory Homes provide a house that's really a home, that can be comfortably heated with little fuel. And they can be erected where you want them in as little as six man-hours.*

And—to look ahead—all Victory Homes can be demounted and moved as simply as they are erected. They are designed and built for permanent use, but you need never be faced with a "ghost town" for they are easily removable, and can be salvaged and stored.

Best of all, they're ready for you now, subject to government regulations. Write, wire or phone us for a complete illustrated booklet and for immediate information on prices and delivery dates on Victory Homes.

★
Note the sub-division of space into well-planned living quarters—*proven* comfortable in actual use.

* Plumbing and electrical installations naturally require additional time.

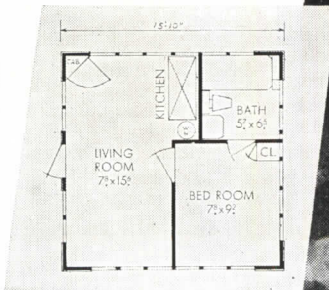

TEXAS PRE-FABRICATED HOUSE AND TENT CO.

Dallas, Texas

MAKERS OF "VICTORY" HUTS AND "VICTORY" HOMES

REG. U. S. PAT. OFF.

REG. U. S. PAT. OFF.

REQUIRED READING

(continued from page 28)

chapter heading "Decadence in France."

The fourscore and ten reproductions, of which sixteen are in color (don't heed the list of illustrations which wearied after listing the first seven) are admirable both as prints and as presenting the subjects treated; and they encourage the observer to enjoy each "without giving it more credit than it deserves."

PERIODICAL LITERATURE

THE CYMA AND THE HOLLYHOCK.

By the Hon. Lionel Brett. *Architectural Review*, Cheam, Surrey, England (45 The Avenue) pp. 80-81, illus.

"I BELIEVE him to be among the dozen or so great European architects of the past five centuries." Thus his son in "Sir Edwin Lutyens: An Appreciation in Perspective," London, 1942. "I warn Hitchcock . . . that, having a good start, not only do I fully intend to be the greatest architect who has yet lived, but the greatest who will ever live." Thus Frank Lloyd Wright on himself as reported by H-R. Hitchcock in "In the Nature of Materials," New York, 1942. The article is a piquantly informing comparison of the two architects portrayed in books published almost simultaneously and recognized by Mr. Brett as contributions to knowledge, noting, however, "the only thing the two authors have in common is a noticeable suspension of the critical faculty."

WHAT'S THE MATTER WITH AIR CONDITIONING AS TOMORROW'S METHOD.

By Lester T. Avery. *Heating and Ventilating*, New York (148 Lafayette St.), April 1943. pp. 57-9.

"THE ALLEGEDLY high cost of air conditioning is not the reason why its use is still limited, particularly in residences," but mediocre results and poor installations resented by a public which wants perfection and will gladly pay for it. Sales of the better and more efficient equipment have been greater than those of the cheaper installations which often are noisy and give too much humidity; and the cost of adding summer cooling and dehumidifying to a forced air heating system is about \$100 a room—a modest sum in comparison with the costs of other refinements of living.

(continued on page 106)

While the design and fabrication of strip steel framing systems remains a fundamental part of Stran-Steel's operations, the necessities of war have led this company into a still wider sphere of action. Present assignments for the armed forces involve designing and shipping complete buildings, ready for rapid erection on the site.

This is a military operation today, yet its peacetime significance is obvious. Stran-Steel can promise the *post-war construction* industry new economies of time, money and materials that follow naturally from wartime engineering developments.

Wartime Engineering Holds a Promise for the Future

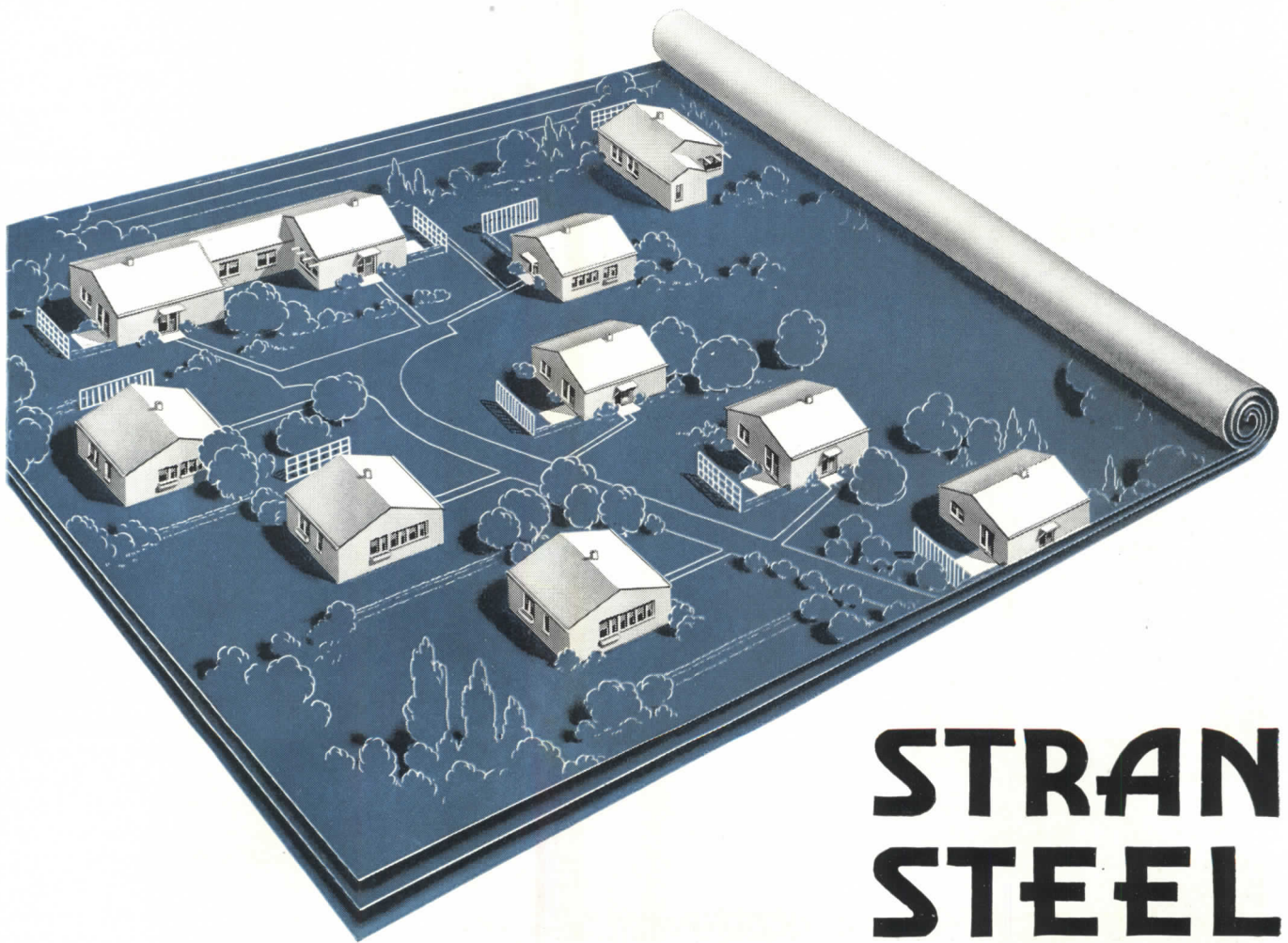

STRAN STEEL

DIVISION OF GREAT LAKES STEEL CORPORATION
1130 PENOBSCOT BUILDING, DETROIT, MICHIGAN

UNIT OF NATIONAL STEEL CORPORATION

TIME...

THE FOURTH DIMENSION

No big job is a one-man job—it's an *organization* job. And the efficient functioning of organization depends basically on one thing—quick, direct *communication*.

That is why RCA Sound Equipment is so effective in getting things done all along the line—in the architect's office, on the construction job, and in the operation of the finished plant itself.

That is why architects who have the highest reputations for designing efficient manufacturing plants so often stress to their clients the urgent importance of installing complete RCA Sound Systems in existing and projected plants.

These architects realize that RCA Sound Equipment:

- (1) *permits instant communication between plant executives*
- (2) *facilitates plant-wide broadcasts of routine or emergency announcements or instructions*
- (3) *transmits messages instantly to roving visitors, government inspectors, or others*
- (4) *raises employee morale, and lessens fatigue, by broadcasting "live," recorded, or radio programs to workers*

An RCA Sound Equipment installation specially planned for your particular plant needs can be furnished at no extra cost.

For complete information write RCA Industrial & Sound Division, Radio Corporation of America, Camden, N. J., Dept. 2-3.



RCA SOUND AND PICTURE EQUIPMENT

RADIO CORPORATION OF AMERICA • CAMDEN, N. J.

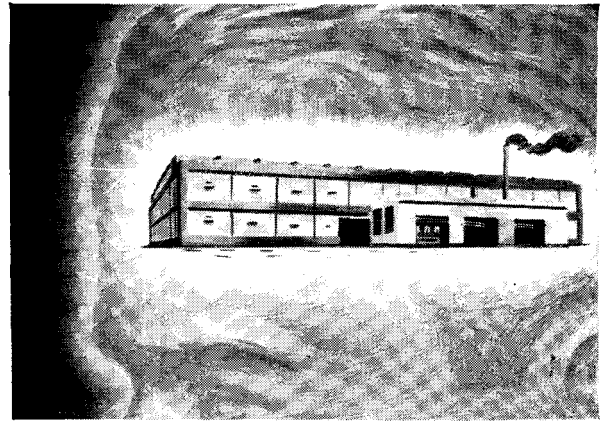

1 Here's an idea in the mind of an architect. Some day it will be a war production plant. But planning, checking, writing specifications, bills of materials take *time*.

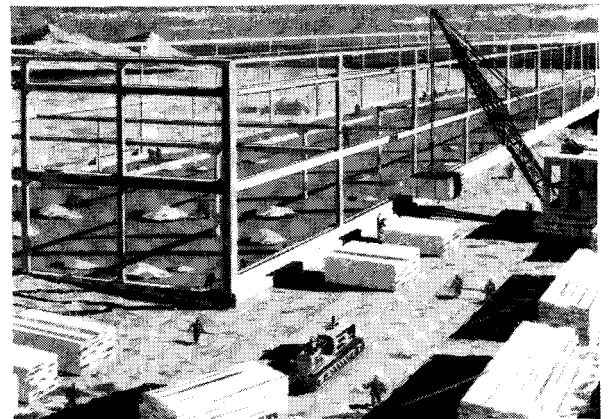

2 Here's the plant under construction. They are pushing it night and day. They'll get it built—but it takes *time*.

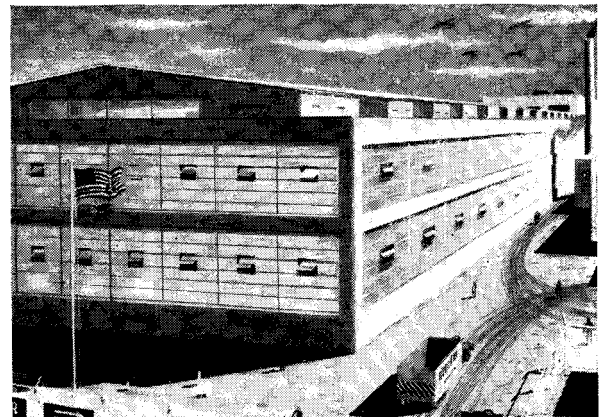

3 And here's the plant—built, equipped, and ready to go. But how fast it "goes" depends upon its facilities for saving *time*.

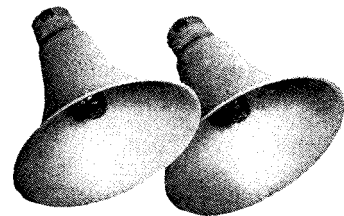

4 RCA Sound Equipment—in architects' offices, construction jobs, manufacturing plants—speeds up everything by speeding up one thing—*COMMUNICATION!*

**YOU'RE PLANNING
TOMORROW'S HOMES
NOW . . .**



Include the modern convenience and protection of the **SQUARE D MULTI-BREAKER**

The Multi-breaker eliminates fuses completely. When a short circuit or dangerous overload occurs, the circuit is cut off automatically. A simple movement of the shockproof lever restores current. There are no delays—nothing to replace.

Because it costs little if any more than fusible equipment—often actually less, the Multi-breaker merits a place in every future home of every price class. The story is the same, whether you're planning individual homes in the upper cost brackets or are concentrating on low cost prefabrication and multiple housing. It applies equally well in the commercial building field.

A Square D Field Engineer will be glad to work with you in arriving at the best electrical specifications for any project you are planning.

Currently, every Multi-breaker we produce is assigned to war-time service. But the same features which make it so valuable to the war effort, earn it a place in the homes which will be built in the future.

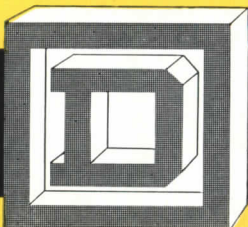
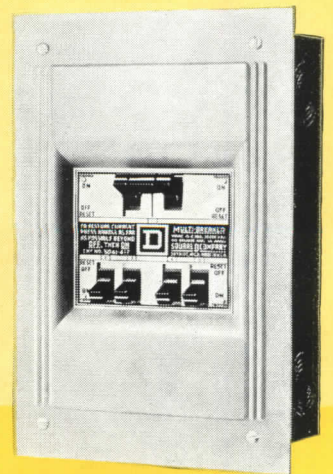

ELECTRICAL EQUIPMENT

KOLLSMAN AIRCRAFT INSTRUMENTS

SQUARE D COMPANY

DETROIT

MILWAUKEE

LOS ANGELES



ALL STEEL COILS

To save the more critical materials, it became necessary to make Heating and Cooling Coils of steel. . . . AeroFin tackled the problem and, in its thorough way, spent days of research in the developing of the most efficient and durable Coil possible. . . . The construction of the *AeroFin All Steel Coils* is such that it will meet with the approval of all engineers.

— CONSTRUCTION —

Heavy wall tubes (.049" thick). Complete solder coating over the outside of the tubes and fins (preventing external corrosion and effecting a permanent bond between tubes and fins). Brazed joints between tube and header. Piping connec-

tions welded to headers. Heating coil tubes offset to relieve expansion strains.

All such details were worked out to make *AeroFin All Steel Coils* give the maximum results under wartime conditions.

AEROFIN CORPORATION

410 S. GEDDES ST., SYRACUSE, N. Y.

Chicago

Detroit

New York

Philadelphia

Dallas

Cleveland

Toronto

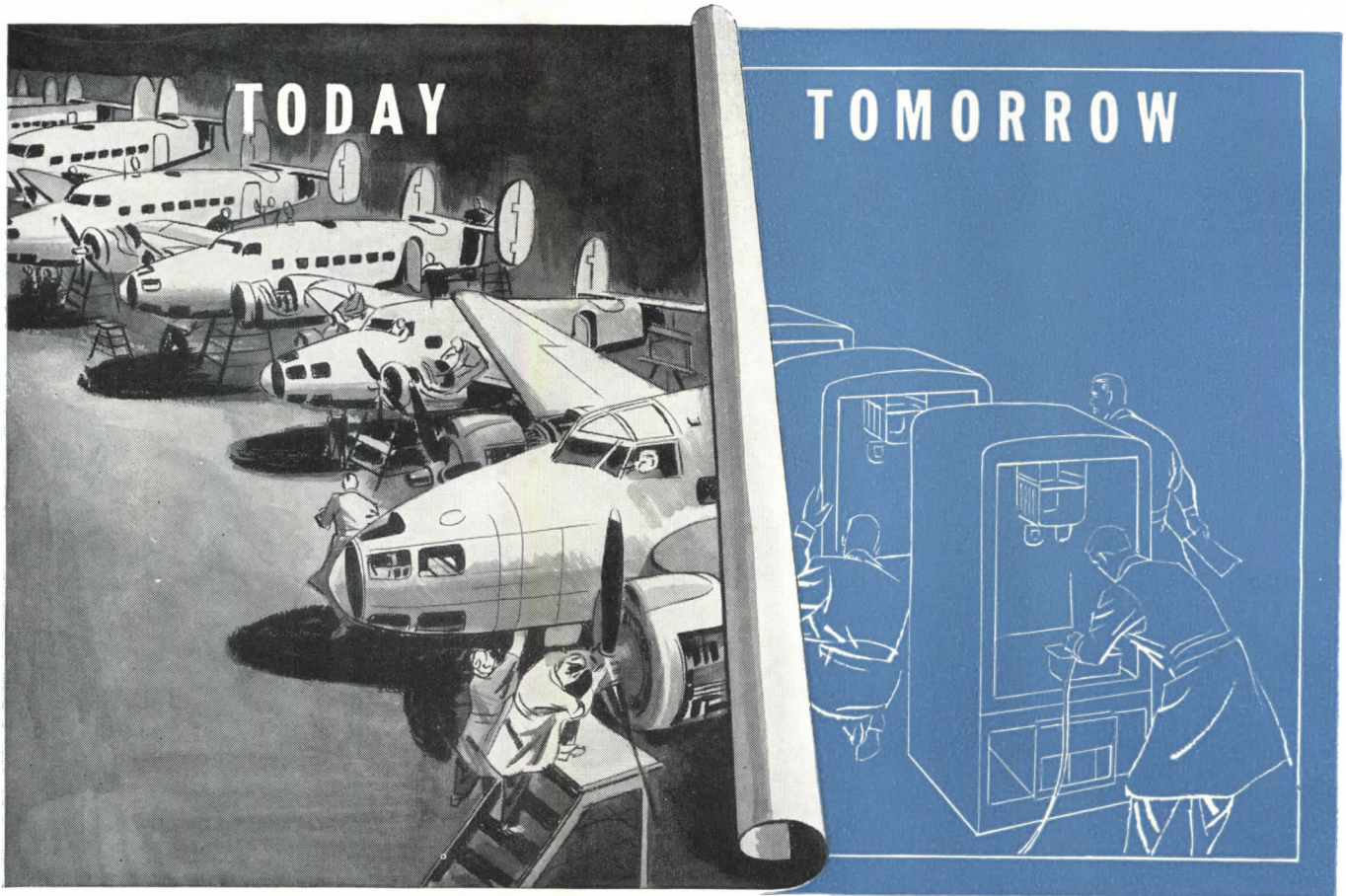

PLAN YOUR DISTRIBUTION SYSTEM

FOR *Maximum Flexibility*

Can you foretell what production demands will be placed on your plant a year or two from today? Emergency additions may be required. Quick conversion to new war products or to peacetime processes may be necessary.

The speed and economy with which these demands can be met depend to a large extent on your plant distribution system. Choosing a system *now* that provides maximum flexibility offers two important advantages:

1. Increased protection against sabotage today.
2. Faster and more economical conversion when necessity requires it.

By bringing broad engineering experience to bear on your particular problem, Westinghouse can help you select the "one best" distribution

system for your present plant. It should provide maximum flexibility with the least use of critical materials.

All systems recommended by Westinghouse are designed to use standard distribution equipment. No time is lost in building special apparatus.

For prompt action, call our local office. Or send for the helpful booklet below. Westinghouse Electric & Manufacturing Co., East Pittsburgh, Pa.

J-94561

UP-TO-DATE FACTS ABOUT DISTRIBUTION SYSTEMS

Keep up to date on latest plant distribution systems. Send for 24-page Booklet, B-3152, which briefly describes plant distribution systems, and points out the advantages of each.

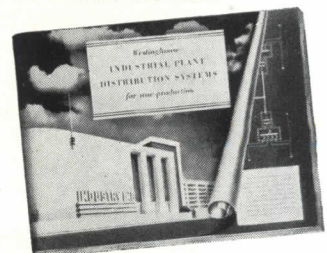

Westinghouse
PLANTS IN 25 CITIES . . . OFFICES EVERYWHERE



PLANT DISTRIBUTION SYSTEMS



Architects: Johnck & Ehmann
Contractors: James Stewart Corp.

CX4521

In a heavy black ledger in Bethlehem is a number, CX4521. It represents the plant you see above. Because of war censorship, Bethlehem cannot reveal the identity of this important plant, but can present a few design and construction details about it.

CX4521 stands for a rolling mill building and office building erected somewhere in the Great Lakes area. The plant is to be used for forming one of the most vital materials of war.

The mill building, shown above, measures 360 ft. by 900 ft. and is made up of four aisles extending 840 ft. Glass brick

has been used extensively throughout. Attached to the south end of the mill building is the two-story office building, measuring 40 ft. by 80 ft., and designed in the same clean-cut style as the mill building. The fabrication and erection of the 3000 tons of steelwork for these two structures was carried out by Bethlehem.

That black ledger in Bethlehem contains columns and columns of similar job order numbers, representing construction, often in record time, of scores of structures such as bomber assembly plants, tank arsenals, engine plants, and Army Air Corps hangars. The ledger thus gives a concise picture of the enormous amount of construction Bethlehem has handled to help produce the materiel of war.



BETHLEHEM STEEL COMPANY



UNDER THE NATION'S ROOF

June, 1943

No shortage of asbestos-cement building materials. Asbestos shingles, asbestos roofing felts, corrugated Eternit sheets, Stonewall Board ... all non-critical and available.



Architects and plant executives who wish to eliminate or reduce the unsightliness of factory exteriors at no extra cost should investigate Ruberoid's new developments in saw-tooth and other steep roof areas. These are mineralized materials providing soft green and striking red colors.



Sheet metal curtailment order has not upset flashings details. There are five sensible, practical methods all ready to be incorporated into your specifications. They are available from The Ruberoid Co.



About reducing air-cooling loads. Economies up to 20% can be effected, where proper roof specifications exist, by keeping several inches of water on the roof all summer. But, don't try it without checking up first on the specifications.



Laminated wood arch construction is doing an outstanding job replacing steel trusses for large area structures such as hangars, garages, warehouses, supply depots, etc. The roofing problem on these Curved Truss Roof Decks becomes no problem at all when you specify Ruberoid Double-Coverage (wide selvage) Roofing. Available with red, green or blue-black mineral surfacing - it provides a built-up roof especially suited to curved roof construction.



The latest Ruberoid Roofing Specification Book should be in every architect's file. Contains complete specifications and details on all types of Built-Up Roofing - (a) Asphalt (b) Coal Tar Pitch (c) Asbestos. It's right up to the minute. Ask for A.I.A. File 12-B-1.



War-time construction didn't start with Pearl Harbor. Defense construction had been under way for several years. Wide experience with hangars, hutments, housing, warehouses, war plants - all involving new problems, have created at Ruberoid a vast reservoir of case-history information ... which is available for the asking.

The RUBEROID Co.

For up-to-the-minute information on your roofing and building problems consult our nearest sales office:

NEW YORK—500 Fifth Ave. • CHICAGO—307 North Michigan Ave. • BALTIMORE • ERIE • MILLIS (Boston) • MINNEAPOLIS • MOBILE

FOR
VICTORY

all war-time
construction
is essential—

**COORDINATED
SPEED**

is vital. If you
can help on this
job—*move fast*



**DODGE
REPORTS**

Our War-Time Mast-Head!

AS IT APPEARS IN DODGE REPORTS

F. W. DODGE CORPORATION

119 West 40th Street, New York, and Principal Cities East of the Rocky Mountains

From better bomber fuel to better buildings —

Roofing

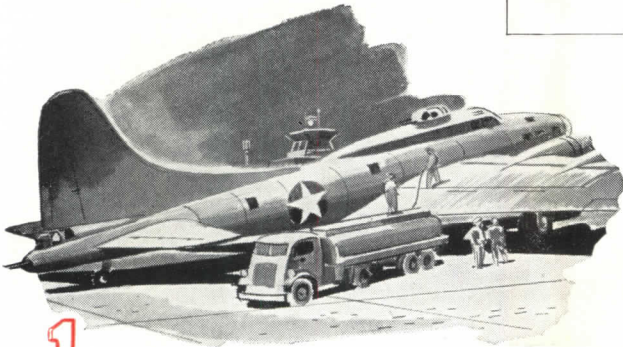

1

Current—Besides going into millions of square feet of roofs for war plants, Koppers coal derivatives today are helping produce more food (through fertilizing materials obtained from coal), better aviation gasoline (through the use of benzene, recovered from coal), synthetic rubber (also through the use of benzene), more aluminum (through electrode pitch used in recovering aluminum).

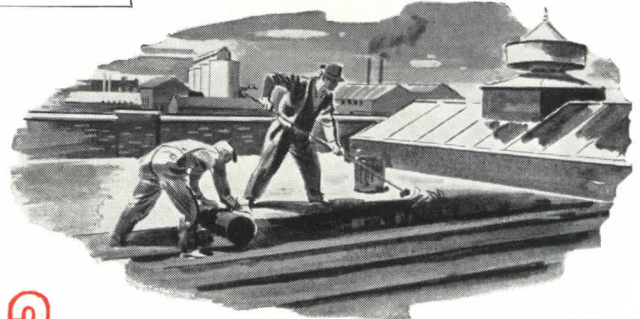

2

Contemplated—1941 and 1942 were two of the biggest years in the entire history of coal tar pitch roofing. More of it was used during that period. More valuable lessons were learned about its values. Now, with the great rush of war building construction scheduled to ease up soon, more and more of this long-lasting, maintenance-free roofing material will be available for civilian uses.

Pressure-treated Wood

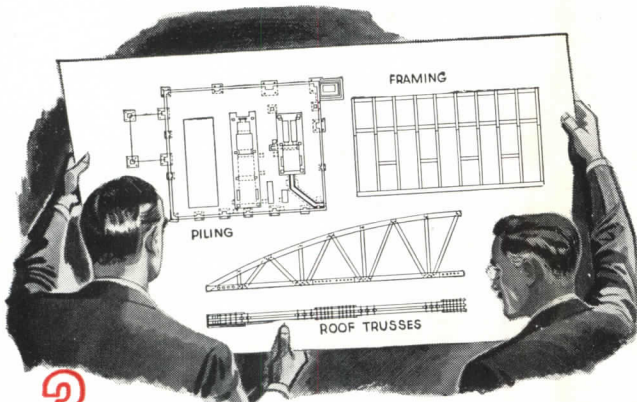

3

Current—Many new and diversified uses appeared for pressure-treated wood, as architects and engineers, under the stress of the vast wartime building program, searched for materials more durable or more economical . . . and discovered the great possibilities in pre-fabricated pressure-treated wood.

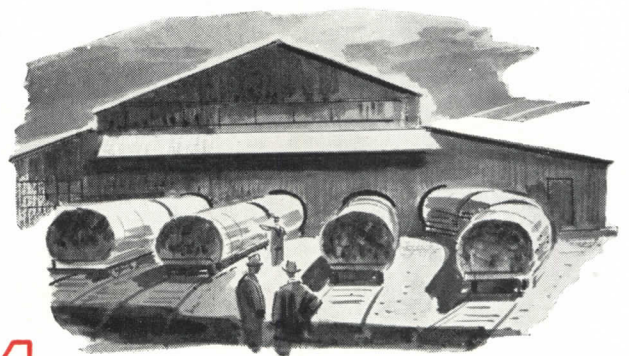

4

Contemplated—Architects and engineers have found that the use of pressure-treated wood, as permanent construction material, involves no sacrifice . . . in fact, it actually improves the installation in many instances . . . and they are planning to extend its use in normal peacetime construction.

Koppers Company and Affiliates, Pittsburgh, Pa.

KOPPERS
THE INDUSTRY THAT SERVES ALL INDUSTRY



THAT'S A PREFAB'D
SHOWER STALL
MADE OF ALUMINUM

Prefabrication has many champions. Certainly, something fine will result from the wealth of Imagineering that is being aimed at the housing problem. One thing we know, for a fact. Manufacturers are thinking seriously of standard, prefabricated utility units around which to design nonstandardized exteriors. And the material they're counting on using a lot of is aluminum.

It's no exaggeration to show two men carrying a unit this size so easily. It is a picture we see daily in dozens of plants, except that the parts are for airplanes. The men and women building those assemblies have developed skills which won't be forgotten when peace comes. They'll be

put to work, for example, on architectural products.

You'll gain, with aluminum widely used in home building. Its lighter weight will simplify your design and construction problems. Its long life will permit you to guarantee lower upkeep costs. The many attractive surface finishes possible with aluminum will give you a new tool for creating unusual and interesting effects.

Plan on lower costs for postwar aluminum products. The ingot price is 25% lower than in 1939. New manufacturing techniques and large quantity production will let you discard all your old estimates, when you begin figuring on using aluminum. ALUMINUM COMPANY OF AMERICA, 2167 Gulf Building, Pittsburgh, Pennsylvania.

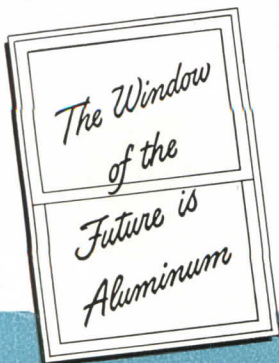

ALCOA ALUMINUM



Reg. U. S. Pat. Off.

THE SHELL, THE PEA AND THE FAIR

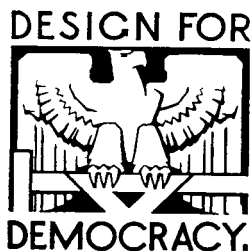

PREFABRICATION, though rarely defined, usually means, in the larger sense, the increase in the size and number of house parts that can be and are made in factories by mass production methods, parts which thus require fewer site operations for their assembly. This is the natural evolutionary development of the house building technique, ingenuity plus production schedules. It is the adaptation of the industrial method to the building field, in the interest of greater speed, precision and the elimination of waste in materials and labor. Everyone in the building industry should welcome any and all steps to those ends, better buildings faster and at lower cost. Only time will tell which schemes, systems, and organizations will prove that they actually do achieve those ends.

- ◆ Prefabrication, as thought of by most inventive geniuses that are endeavoring to produce homes by factory methods, has been considered largely in terms of the shell. Panel schemes, vertical or horizontal, with ingenious joints, have seemed to be the major, if not the only problem. Of course the shell is all important as the enclosure of space but one can become so intrigued with watching the shells that he may lose sight of "the pea." It may well be that in this game, as in the old "shell game," the "pay-off" is in locating "the pea." "The pea" in this case may prove to be the mechanical heart of the home, that unit which can be so designed as to supply heat, light and power, or any combination of these, as well as serving to dispose of all refuse. Such a "pea" is capable of full prefabrication, a unit easily manufactured, transported, and installed, as such. In addition, it can eventually be found under any type of "shell," even if produced in only a limited number of sizes. Other "pay-off peas" are likely to be prefabricated bathrooms, and integrated kitchen units. They can be made and sold according to the formulas of the automobile industry, which is so often mentioned with prefabrication.
- ◆ The trailer home is closely analogous to the automobile but as yet does not parallel the development of the automobile industry. But as soon as one departs from the small mobile house to the house of fixed location, the automobile analogy begins to break down. This is because the product then ceases to be a universally exchangeable commodity and becomes involved with factors that complicate its design, production, merchandising, distribution, operation, and maintenance. Then land values, neighborhoods, school districts, family requirements, site planning, orientation, transportation facilities, public service connections, long-term financing, government, taxation, building codes, local labor situations, the laws of real property, mortgages, liens, and assessments, all complicate the problem. With all these factors the merchandising of prefabricated houses as property is bound round with so many more woolen strings and red tapes than commodity merchandising that it is difficult to maintain our parable of the automobile. "Houses Like Fords" would be a simple feat if the house could remain a commodity as universally adapted to all conditions as the automobile is to the road (any road anywhere).
- ◆ "The shells and the pea" may thus prove less important than the "rules of the game." Manipulation of "the shell and pea" are fascinating but are subject to controls and conditions that are far beyond the scope of architecture and engineering.
- ◆ The eyes of the profession are turned to remedying and remodeling the obsolete or inefficient in the realms of these other factors that control architectural engineering. Post-war planning in its larger aspects is occupying our attention. The A. I. A., and the Producers' Council are studying it intensively.
- ◆ Those interested in providing homes in the postwar period are naturally as concerned with the problems of community planning, taxation, codes and all the other economic, social and political factors as with the problems of design, technical change and production. It augurs well for the building industry that, with all its interest in the "shell and the pea," it is not stopping at that pitch but is determined to take part in the whole fair.

HOUSING and the DEMOCRATIC PROCESS

BY JOSEPH HUDNUT

Sketches by G. T. LeBoutillier

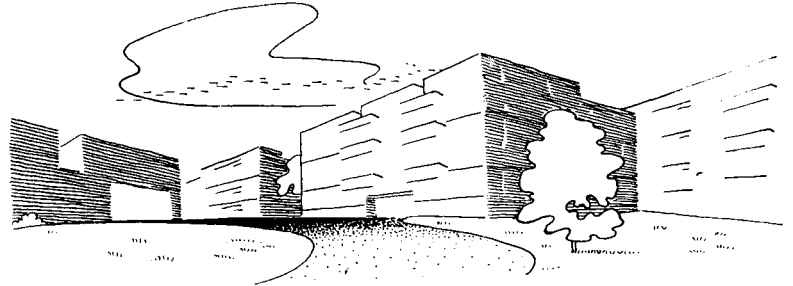

I HAVE just attended a conference on public housing. I heard many speeches—and made one myself.

Nearly all of the speeches (I will say nothing about my own) were devoted to some problem of practice: to planning and techniques, incomes and rents, tenant relationships and management, operation and maintenance. Very little was said about the *objectives* of housing, the place of housing in the pattern of society. It appeared to be taken for granted that the causes and consequences of housing, which in practice is an arduous and uncertain art, were definite, well understood, and approved. Everyone present gained some useful information; and each left the conference by precisely the same door through which he had come.

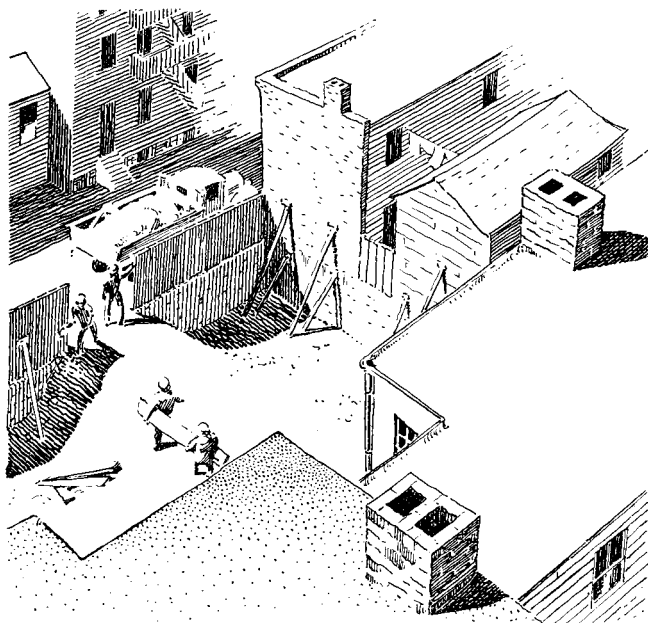

“—localities actually cleared and rebuilt—”

Housing, and especially public housing, has to do with many things besides planning, maintenance, and sanitation. These, after all, are means, not ends. If we are able by these means to promote the happiness of thousands of people, to give them health and opportunities for their children, to bring some measure of security and peace into their lives, that is a very real and important achievement; but we should not assume too casually that those ends are indeed being achieved—still less, that they are the only consequences of our activities. I venture to say that when these activities are finally appraised, these ends, even if we attain them completely, will appear less important than certain social and political consequences of our work to which we are surprisingly incurious. We are making some very far-reaching changes, not alone in the physical pattern of our cities, but in the social pattern as well. We are, within the measure of our activities, reconstructing the environment which is, in part at least, to shape the thought and vision of the generations that follow us. Our influence and our responsibility are not limited to the areas occupied by housing projects. However restricted may be the localities actually cleared and rebuilt, their presence alters the rhythm and direction of civic life as a whole: alters it perhaps in ways that are more profound and less predictable than many of us imagine. Housing projects are not merely incidents in the vast fabrics of our cities. They are organic alterations. That is true whether they are conceived as integral elements in a broad plan of development or whether, as happens more frequently, they are but patches scattered over the worn city.

Our housing authorities and those agencies associated with them are destroying an environment which is the outcome of one way of life in order to substitute an environment which will be, no doubt, the cause of another way of life. Since human thought and conduct have been shaped, in part at least, by an environment created by man, they may suffer a further change through changes in that environment. That is, to put it mildly, a somewhat daring hypothesis, and yet it is one which appears to be confirmed

by the history of mankind. Certainly it deserves our notice quite as often as does that compassionate attitude toward human suffering which is the more usual justification of public housing, or that aesthetic need for harmony in the disordered city which takes so persistent a command over the imaginations of planners.

I should like to examine a little more definitely the nature of at least one of these social changes. I should like to forget for a moment the mechanisms of housing, important as they are, and consider the broader consequences of these mechanisms. To be frank, I am not deeply interested in the mechanisms themselves. I care very little for what goes on under the hood of my car—the operation of spark plugs and carburetor, the number of gallons burned to the mile—but I should like very much to know where we are going.

Housing projects are at the best unnatural phenomena. Housing projects do not spring spontaneously from the free interaction of social or economic forces. They are, rather, products of theory—things contrived by men who, however anxious for social reform or for the relief of suffering, yet stand a little aside from the forces engendered by social conflict. No one in the lower income-group could, I think, have invented the housing project. That group, as I remember it, was at first even a little resentful of our efforts—or at least of our attitude—and had to be teased into our shining new paradise with the promise of mechanical refrigerators.

To say this of the housing project is not to condemn it. Cities themselves are, to some extent at least, works of art. Cities are shaped by the clash of economic forces but they are also shaped by idea and conscious guidance. If that were not so, they would be intolerable. Nevertheless, it must be obvious that those aspects of cities which are the result of deliberate thought invite a more jealous examination than those which appear to have had a spontaneous origin. Because they are by their nature more submissive to our control, they lay a heavier burden upon our conscience. For my part, although I acknowledge the rightness and the human usefulness of public housing, I should feel more certain of my judgment in this matter if public housing had had its origin in the economic class which it is meant to serve; if it had been demanded, fought for, and finally achieved by the very poor.

We should have had very few housing projects had it not been for the crisis created by unemployment. Housing projects were, and will be again when the war is won, agencies for relief. They are a means for promoting economic activity. They have been shaped by intentions which have sometimes only an incidental relation to more permanent social objectives; and these intentions are stamped upon their character. They account for the wholesale nature of our enterprise, its machine-like processes, its tedious uniformity. They explain the lavish expenditures for labor, the strict economies in the purchase of brains. What was wanted was a standardized industrial product capable of being turned out rapidly in the largest possible units and with the maximum utilization of labor.

Heaven forbid that I should in these days identify labor with the lowest income-group, and yet it seems to me reasonable to suppose that labor, rather than industrial capital or a government in search of expense, might have been expected to promote the public housing program. Labor did



“—demanded, fought for, and finally achieved—”

not promote that program. There were, no doubt, many reasons for this; but one reason, more important than people suppose, was an awareness—felt, rather than explained—of social consequences unforeseen and feared. Whatever else it may be, the housing project is an act of segregation. It defines, separates and establishes economic and, to some extent, social stratifications. People in a certain category, arbitrarily created, are drawn out of the ferment of urban life, re-established on new sites cleared for that purpose. These new sites are as clearly demarked from the larger complex of the city—by arrangement of buildings, by a uniform architecture and landscape treatment, by the nature of inter-communications—as though solid walls were built around them. Within that invisible wall a new habit of life is invited: not invited merely, but demanded and—by methods which have at least the color of science—guided.

Each day, as your techniques of control and management assume more definite and known conventions, the segregating nature of the housing project becomes more evident. These are institutions set into the city, not parts of the city: their occupants are more like inmates than citizens. Their former living quarters having been proved sufficiently horrible, they have become *initiates* and may claim, so long as they do not suffer an increase of income, a special right of asylum. Thenceforth like orphans they live apart, blissfully havened from the tumult and peril of the city's streets. In that environment, their lives shaped by a special Providence, the underprivileged suddenly privileged, men are surely less likely to feel that immediate responsibility for their own destiny which is the tried motive for self-improvement—still less that responsibility for a collective destiny which gives vitality to the democratic process. I know quite well that a certain degree of social segregation is inescapable in our great cities; but I am not thinking now of those vast unredeemable distances which will always, I suppose, separate the very rich and the very poor; I am thinking, rather, of those many narrow fissures which constantly corrupt the central core of democracy. These are encouraged, I fear, by the principle of economic segregation which appears to be fundamental in the present policies of housing authorities.

These tendencies are encouraged also by the compact and specialized character of housing projects and by their remoteness from the commonplace activities of city life. I read recently a pamphlet, written in that glowing language which architects use to describe their favorite children, which makes a great to-do over the “suburban-like atmosphere” which is going to prevail in a housing project to be located in the center of a *great city*. Surrounded by

lilacs, dwarf yews, and hawthornes, the dwellings painted to "look like a collection of private houses," the people who live here will never suspect that actually they are living in the congested heart of Chicago. The author-architect takes it for granted that no one in the lower income-group would live in Chicago if he could help it, that only a lack of funds prevents that group from moving *en masse* to Concord, Massachusetts. There is, it appears, something perverse and unnatural about a preference for crowds and streets, for the drama of business, for neon lights and the adventure of shop-windows.

Now, if housing authorities would take one good look at the habits and tastes of these for whom they are building, if they were to consider those things which people do like as important as those which they ought to like, if in short they were willing to admit history and custom into their designs, they would think twice before they decided that low-income people are really made happy by plumbing, fresh air and prophylactic calm. Housing authorities, when they plant their hawthornes and sycamores, are at pains to study the kind of soil which these have preferred. Trees, it appears, are less apt than tenants to survive the rigors of an abstract philosophy.

You have, to be sure, a science of housing, but it is a science more biological than social. The housing project in Chicago to which I have just referred is illustrated by an air view, in no way different from the air view of every other housing project, which certainly has more the aspect of a chicken farm than that of an environment for human life, so angular, separate and schematic is its stark parade of multiple cells. Hygiene, economy and good eggs are obviously the ideals. There is, no doubt, a biological science as apposite to men as to chickens but in practice its conclusions should be somewhat tempered for the larger and less tractable of those species.

I know that the streets of our great cities are full of clamor, confusion, dust, germs, smells and ill-mannered people—and yet there are moments when I would rather live in the meanest of streets than in the most sanitary of housing projects. The air there is less pure but more invigorating. There the life of the city is channelized; I can share its strange irregular rhythms, its moving power. I would not exchange the crowds and the traffic, the bright lights and the noise of streets for a wilderness of spirea and honeysuckle, of neat and well-kept lawns, of façades saturated with the charm of colonial days. I am sure that

people in the lower income-groups will agree with me; and I submit that their preferences, confirmed by centuries of experience, are likely to be founded upon something more fundamental than caprice.

Of course I know that streets can be improved. Of course I know that the treatment, arrangement and control of streets are matters grievously neglected by municipal authorities. I know how the lunatic industries of the nineteenth century distorted that once-beautiful theme, and I have noted the dire consequences of land exploitation, of the undirected growth of cities, and of that strange encouragement which our fathers gave to architectural indecencies. I know that slums must be cleared and cities replanned, and I know also that this can be done without fostering segregation, either social or economic. Nor do I expect all of mankind to share my desire to live in a little apartment at the corner of Broadway and Forty-second Street. You can have quiet streets, lined with sightly tenements opening into quiet courts. You can have good housing without eliminating the street: the street, which is integral with the tradition of cities, the most active channel of human intercourse, the oldest theatre of democracy.

I would return the housing project to the streets of the city and I would return it also to the city's institutions. You are not apt to develop any sense of social solidarity in a scheme which excludes the church, the theatre, and the school. I have never seen a housing project which included these except by accident, and yet I cannot imagine any device which could make more evident the separatist nature of these enterprises. That is surely an artificial—I almost said inhuman—neighborhood where men cannot feel the continuing presence of these ancient and vast traditions.

What I miss most of all in your housing schemes is a spire. You must make room for that symbol, if only to relieve the deadly monotony of your roof-lines. Next to the spire I miss the promise of the schoolhouse, the relaxation of the clubhouse and the gymnasium, the invitation of the theatre; and, to tell the truth, I am not long in a housing project before I begin to miss the barroom also. You have fresh air, plumbing, vitamins, and landscaping no end—yes, and good planning sometimes—but you have left human nature outside your gate. If I had my way, there should be no residential district in a city inaccessible to the church and the school, no area in which these are not provided for. I cannot believe any other scheme to

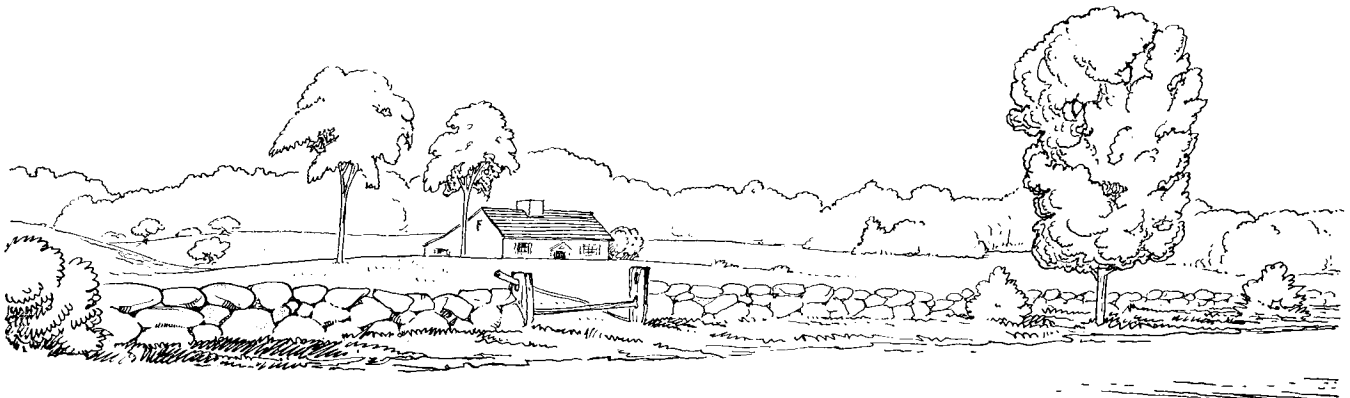

"*en masse* to Concord, Massachusetts"

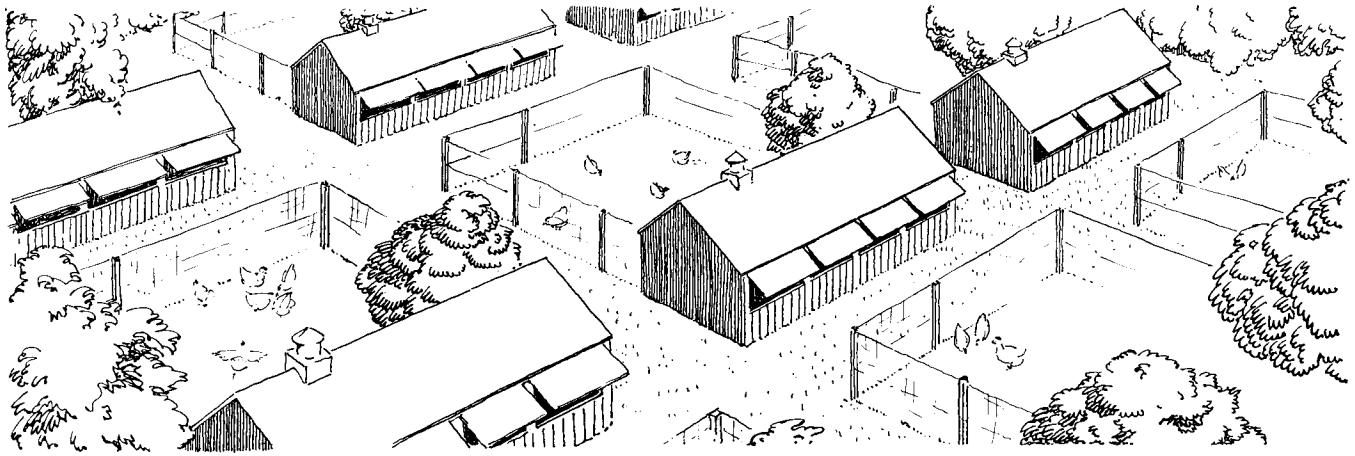

“—the aspect of a chicken farm—”

be a wholesome one—either for those inside of it or for those outside of it; and the doctrine that a certain self-respect, engendered by an escape from squalor, affords a compensation for these things of the spirit leaves me very cold indeed.

I should have a group of institutions at the center of each neighborhood—the size of which should be determined by history and experience. I seldom visit a housing project without wanting to open a great hole in its center—by a good charge of dynamite, if necessary—so as to make room for such institutions. But I would not do that if I could not at the same time open many smaller sites to be used for the dwellings of income-groups other than the lowest. Certainly I would not have institutions reserved for the use of any one group, however low or high.

The more I think of the average housing project, the better I like the dynamite idea. A good explosion would not only open a space at the center but would, at the same time, scatter the low-income dwellings out into the wider complex of the city and open channels for an admixture of other dwellings. Some housers, I suppose, would consider the method drastic; and yet I wonder whether, in the long run, it would prove more disruptive than their own.

I hope that housers will understand that I am on their side. I believe in public housing. I believe that we ought to use collective resources in this way to destroy the slums of our terrible cities and, for the sake of our children and of our democratic way of life, give to every family the opportunity of decent shelter. That will be expensive, but we can afford it. Nor is such a program, in principle at least, a program for the benefit of one class at the expense of another. When you cure a cancer in one organ of the body, that is surely to the interest of all other organs.

I am discussing not so much an idea, but the way in which an idea has been translated into practice. Partly by acci-

dent, partly through errors of judgment, and partly by forces which are only incidentally related to our central objective, habits of thought and action have been developed, conventions formulated and crystallized, special interests entrenched, until there has grown up a pattern of behavior the rightness of which we take quite too casually for granted. Now, while the war makes necessary a pause in our practice, we ought to re-examine that pattern. We should examine not processes and appearances merely, not tools and means merely, but, most searchingly of all, values and ends.

I think that much could be gained, and only a little lost, if housing projects for the lower income-group could be broken up into many small units and if these could then be widely separated (not necessarily by dynamite) over a considerable area. No one unit should comprise more than two or three buildings—and sometimes only one—or provide shelter for more than, say, fifty families, and there should be normally not more than one such unit in a block. The buildings in each unit, planned in accordance with the highest standards, occupying not more than one third of each site, should yet be distinguished from other apartments in the city by no peculiarities other than excellence in design; nor should there develop any traditions in management other than those which have become customary and accepted in other apartment buildings in the same environment. There should be no trace of the *institution*, no acknowledged or implied separation, and certainly no “trained personnel” bustling about and ready to channel the lives of tenants into accepted moulds.

If this policy were followed, many of the spectacular aspects of housing would, to be sure, disappear. We should not have the excitement—or the difficulties—which arise from the accumulation and exploitation of large areas of land; but we should be able to buy or condemn land in small parcels wherever it is to be had

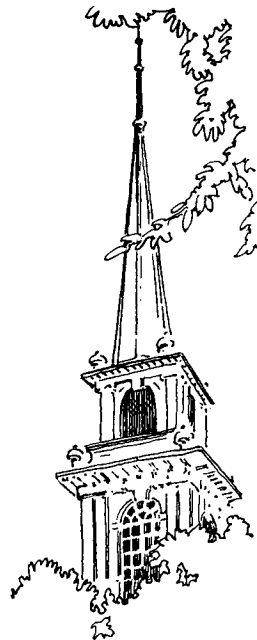

“What I miss most of all . . . is a spire.”

cheaply or wherever housing conditions are in need of reform. Those problems which arise from wholesale management might be made less difficult, and a wide range of experiment in plan and expression made possible. These are practical advantages; but far more important than these would be the social gain. Our smaller units, illustrating new and attainable standards, should not form segregated areas still surrounded by darkness but, like many stars scattered across the night, they should illumine and redeem the whole of the wide city. The people who live in these units should be invited to improve, not to change, their way of life, which would remain as before, integral with that of their community.

Housing projects organized in this way could be planned within the existing framework of the city, the evolution of which is possible only through progressive adjustments. I do not suggest that this framework is always good or that it ought not to be changed; but I submit that both judgments and action in such matters ought to rest with some agency having a wider range of responsibilities than has a housing authority. Certainly housing authorities should collaborate with town-planning authorities—not simply collaborate, but invite their guidance and control—and yet they should not forget that their peculiar premise is not city planning but housing. It should not be their business, for example, to provide playgrounds—and what, after all, could be less democratic than playgrounds de-

signed for one economic class? Or apartments so planned that the people who live in them must live actually surrounded by playgrounds? We are too eager in our ministrations and by that means defeat, in part, the ministrations for which we are specifically qualified.

Housing authorities which have thus simplified their procedures and clarified their objectives should at the same time enlarge these in such a way as to include, not low-income housing alone, but all housing. Good housing should be their objective, whether for rich or for poor. They should not be thought of merely as relief agencies, but should be given as their responsibility the total problem of shelter, wherever this touches the lives of city dwellers. It should be their task to devise processes by which these problems can be solved and, wherever that is possible, they should carry these processes into practice—whether by planning and building, or by the encouragement of private enterprise, or by legal reforms, or by subsidies and other methods of financing, or by technological experiment, education, or propaganda. Perhaps also they might, if that is not too striking an innovation, lend their influence to the encouragement of *architecture*—a term which includes not only good planning and building but also a search for those qualities of form which are as essential to the human spirit as are bread and shelter. Not least among the sins of housers is their indifference to that free and generous pursuit.



A.I.A. CONVENES AT CINCINNATI

May 26, 27, 28, 1943

It was appropriate that the 75th annual meeting of the American Institute of Architects should be held in the hospitable city named after the legendary Cincinnatus. If memory serves us right, that venerable Roman came from his peaceful pursuits of following the furrows of his farm to defeat the barbarian tribes, the Aequi and Volsci, who were threatening Rome. That accomplished, he returned to more productive and peaceful activities. Thus the architects of the country have been called to lend their talents to creating facilities for winning the war and at this convention they turned their eyes again to the problems of returning to peaceful pursuits.

An air of confidence and of seriousness pervaded the meetings. The realization was evident that problems to be solved are wider and more all-embracing than discussions of the mere designing and engineering aspects of architecture. Almost exclusively, the discussion centered around various aspects of the many problems of postwar planning. One has but to read "We Will Build Again," the well-prepared and stimulating statement

(Continued on pages 48 and 96)



Charles T. Ingham, of Pittsburgh, Secretary of the A.I.A. for the past nine years, and newly-elected Fellow, welcomes his smiling successor, Alexander C. Robinson, III, of Cleveland



Raymond J. Ashton, of Salt Lake City, Utah, new President of the A.I.A., discusses procedure with Richmond H. Shreve, of New York, who has just completed his tenure of that office



Ex-president Ernest J. Russell, of St. Louis, tells one to "Dick" Shreve and Louis LaBeaume, of St. Louis, speaker at the Dinner



Ex-presidents "Frank" Voorhees, and C. Herrick Hammond, who quietly smoke their pipes and listen, skeptical or amused



Vice-president Walter R. MacCornack, Chairman of Committee on Postwar Reconstruction, and Ralph Walker, of New York, question Albert C. Schweizer of NRPB as he leaves for his train



From the Northwest came, among others, (seated, left to right) Floyd A. Naramore, Harlan Thomas, Marcus B. Priteca, (standing) A. Glenn Stanton, Clyde Grainger, Robert Lewis Durham, Pietro Belluschi, Angus V. McIver, Lloyd W. McClenahan



M. H. Furbringer, of Memphis, pauses in a story of the old South



Frederick W. Garber, of the host-city of Cincinnati



Douglas W. Orr, of Connecticut, and H. Daland Chandler, of Boston, confer with Edward C. Kemper, Executive Secretary

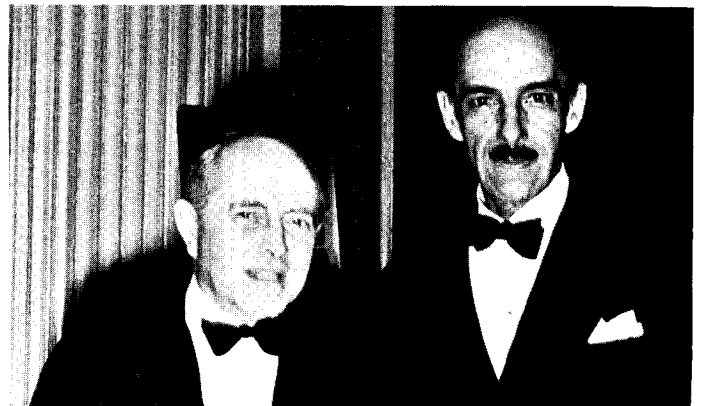

Philadelphia's Robert R. McGoodwin gives sage counsel to Edgar I. Williams, newly-elected Regional Director for New York



Robert W. McLaughlin, Jr., of New York, backs up his partner, Arthur C. Holden, as Jean Hebrard, of Detroit, and Ann Arbor, (in the center) smiles before descending to the Annual Dinner



Regional Director for the Great Lakes District, Charles F. Cellarius, talks shop or postwar planning or something with his fellow Cincinnati, Ernest Pickering, of the University

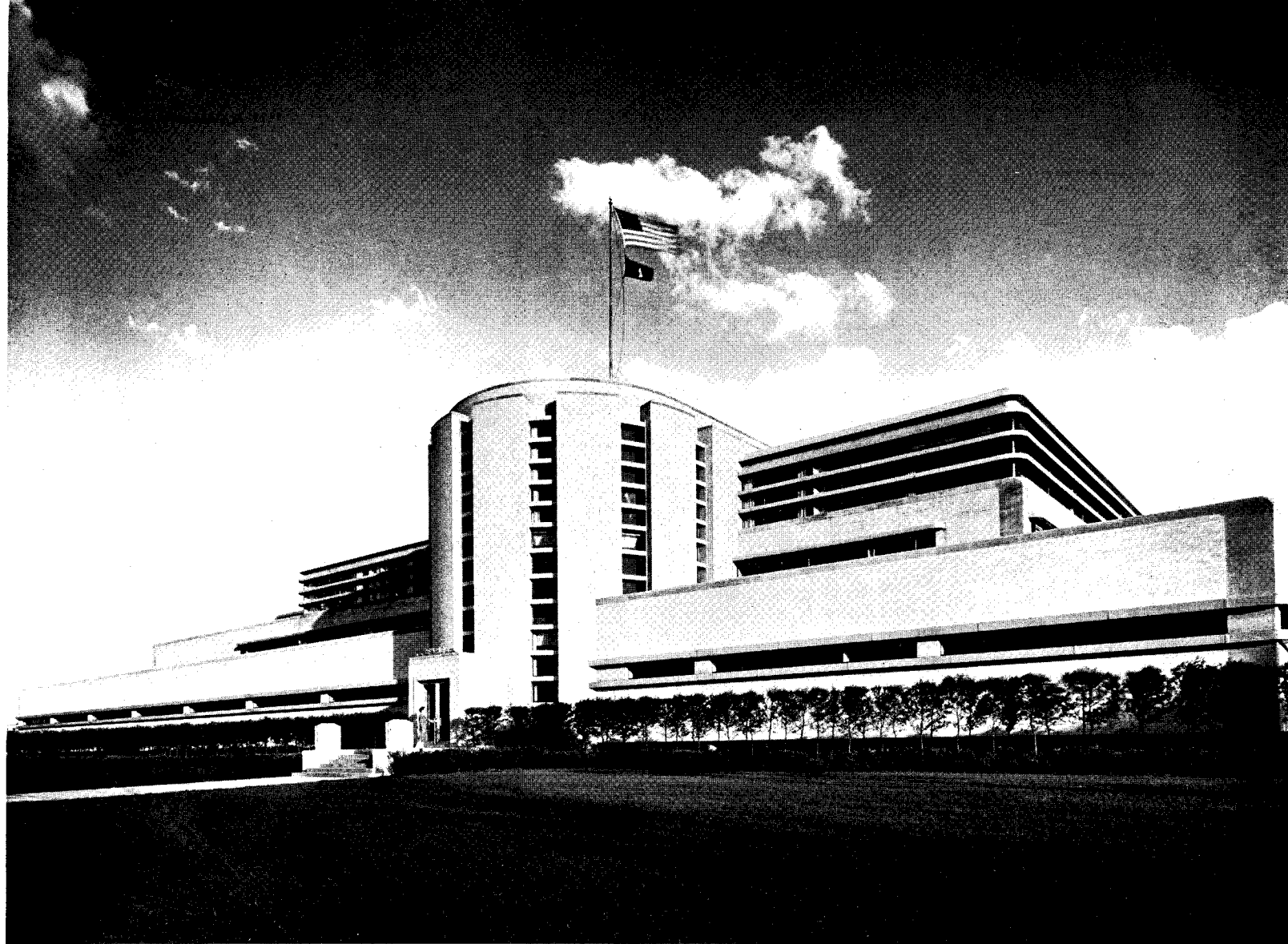

Hedrich-Blessing

LABORATORY FOR MODERN MEDICINE

MANUFACTURING PLANT FOR G. D. SEARLE & CO., SKOKIE, ILLINOIS

HERBERT G. BANSE, ARCHITECT

GEORGE A. FULLER COMPANY, GENERAL CONTRACTORS

ONE OF THE LAST of the pre-priorities plants for private industry, this medical laboratory was completed just in time to aid in the vast contribution of medicine to the war. It was designed to reflect the great advances in medical science, particularly chemotherapy, to provide expansive and functional quarters for both manufacturing and research, and virtually ideal working conditions and recreational facilities for workers.

The lack of symmetry in the facade was no whim of the designer. Firstly, the building follows the dictates of

function to an unusual degree, and the functions are highly diverse. Still more important perhaps was the unpredictable need for future expansion. Although the building allows for considerable expansion as it is, it was so planned and so placed that it could be extended without destroying the architectural design, as would be the case if it followed symmetrical lines.

The high first story is due in part to an "English-type" basement, partly to manufacturing requirements. This part of the building is in effect a windowless plant with win-



There is no whimsy in the lack of symmetry; this design will permit future expansion without greatly changing the exterior appearance

dows, hence the narrow horizontal band. The windows are only to permit employees to see out, not for lighting or ventilation.

Most of the building is completely air conditioned; the few remaining areas are heated by steam and mechanically ventilated. The air conditioning system was unusually complicated by varying requirements in manufacturing and other areas. In certain places fume exhausts are necessary, in others there are dust collectors, and it is not possible to recirculate air. In other quarters the air is irradiated by

ultraviolet bactericidal lamps. Lighting throughout the building is largely fluorescent.

The unusual proportions of the first-floor warehouse space were calculated to simplify materials handling, as it permits storage of various chemicals and other materials near the production and packaging departments. This general scheme of storage is continued on the second floor, which is served by a freight elevator from the landing platforms. A combination of inner and outer loading platform doors prevents a rush of cold air in winter.

Rear view of the Searle Laboratory. The five-acre landscaped plot provides for expansion, and for recreational facilities for workers



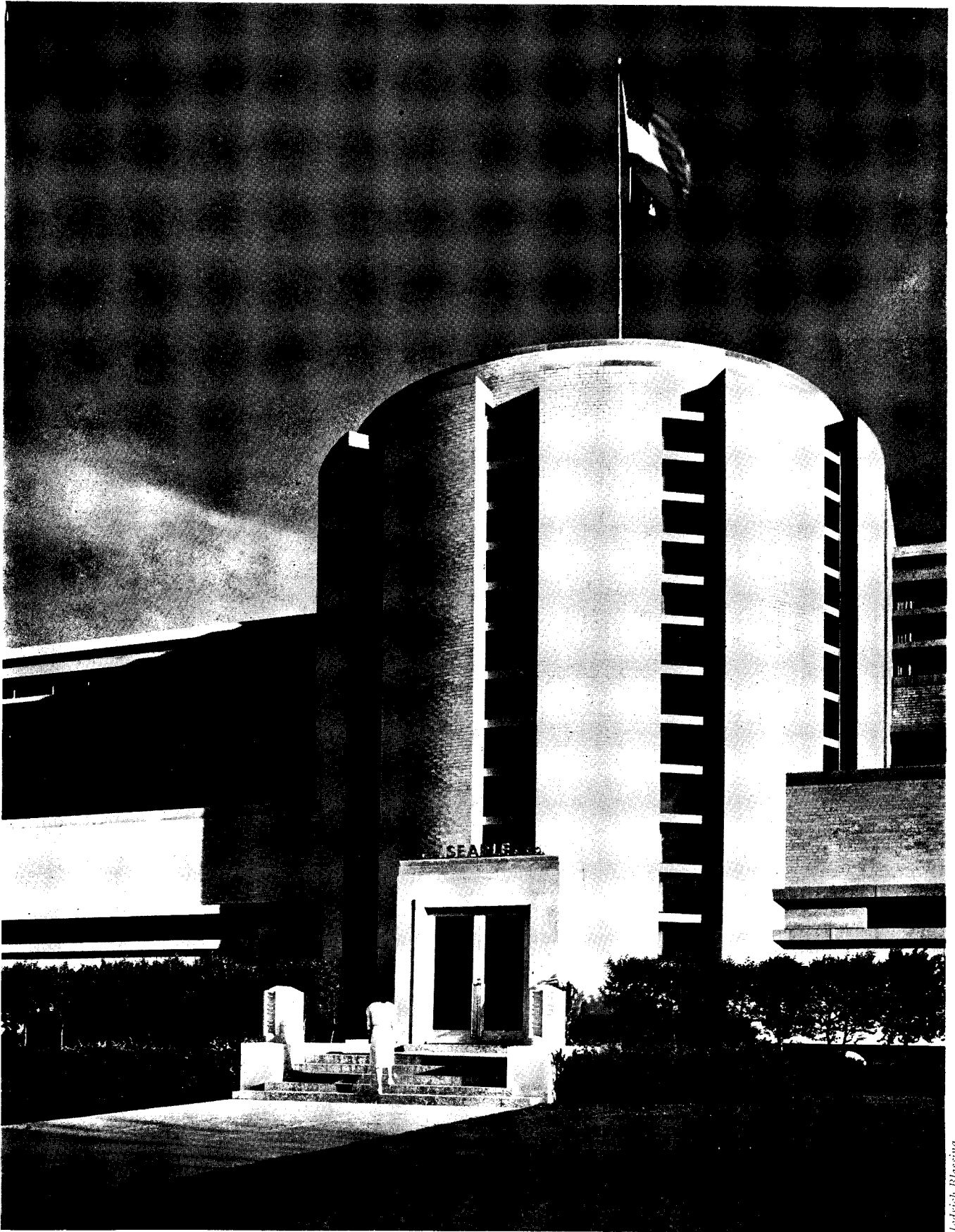

Friedrich-Blessing

Dominating the facade, this semi-circular tower section provides sumptuous lobby and reception rooms, with conference room above

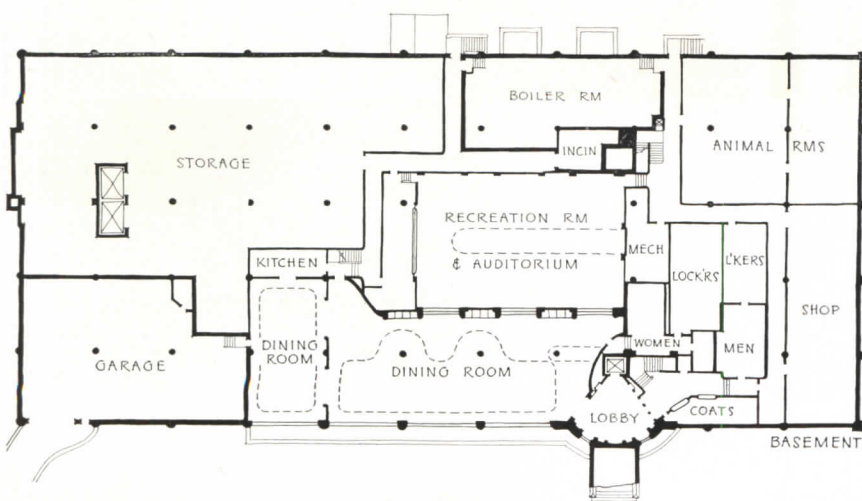
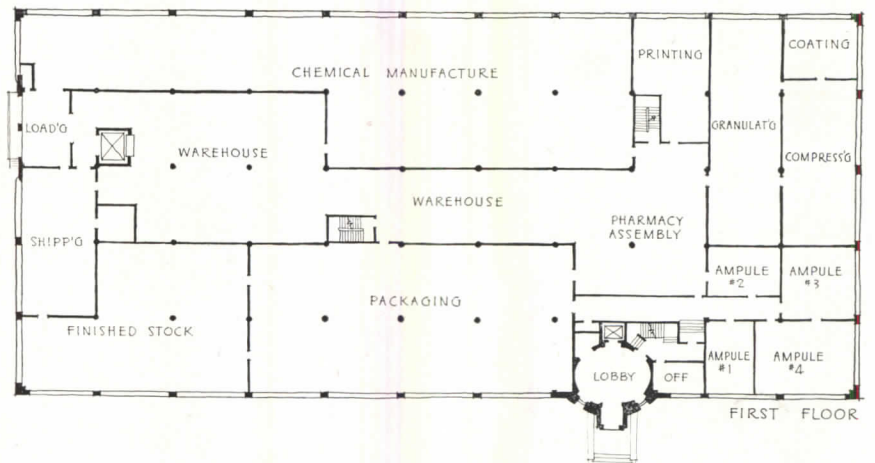

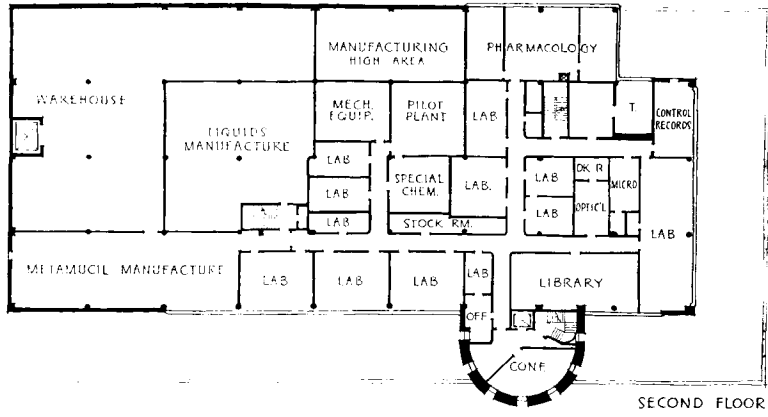
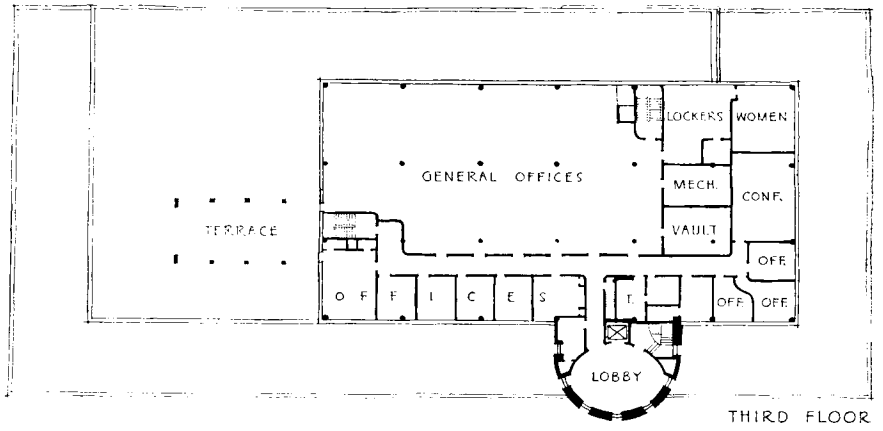

Entrance lobby on the main floor. The wall at the left is reserved for a mural depicting the company's development



Hedrick-Blesing



Auditorium and recreational room in the basement, designed to accommodate a wide variety of meetings and employees' recreation



Entrance foyer to employees' lounge and auditorium. The display cabinets show Searle medical products in various stages of manufacture



Two views of the extensive lounge and dining area. A kitchen is provided for serving special parties, not for regular meals



Hedrich-Blessing

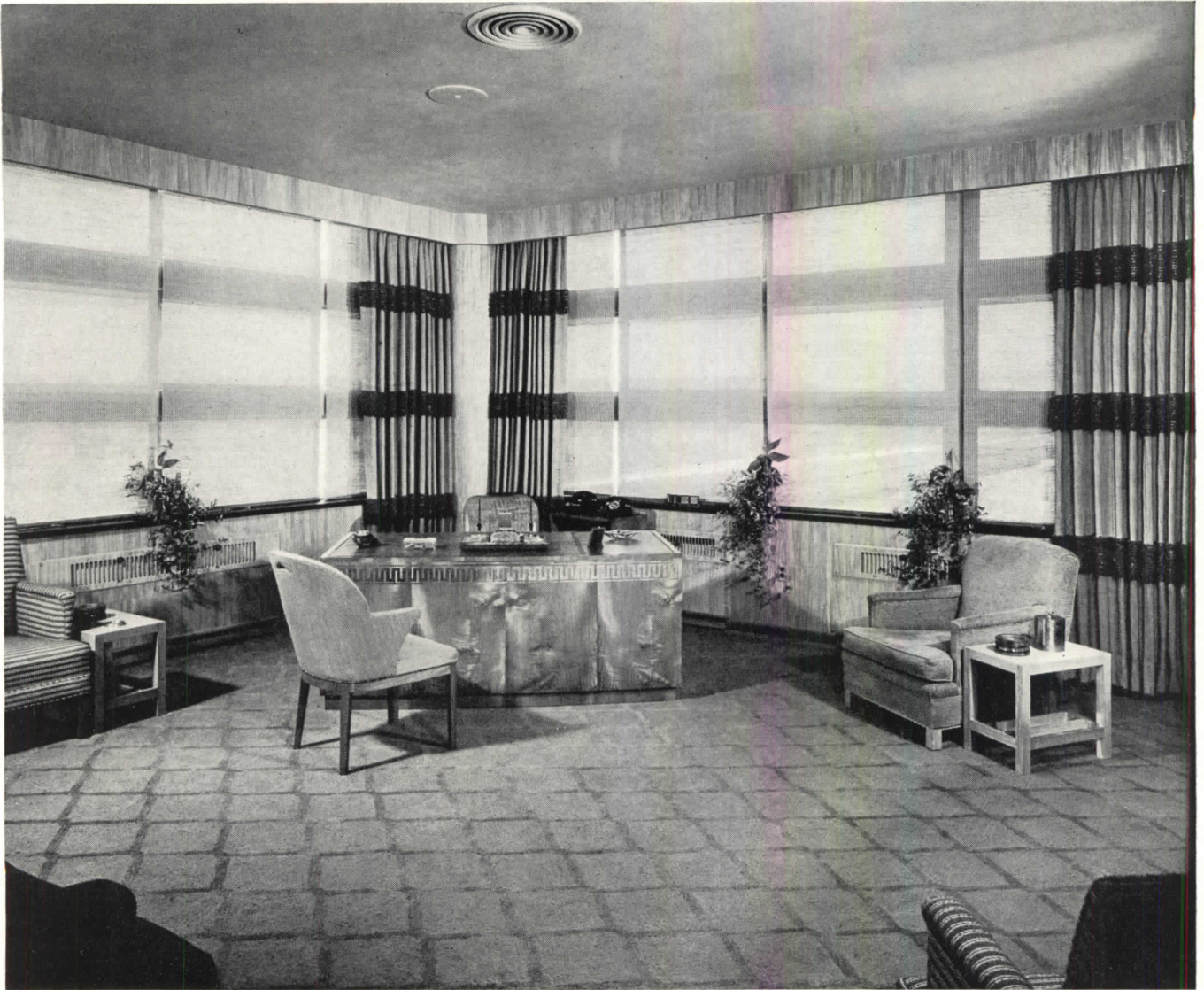

The office of the president. Furnishings here, and most others throughout the building, were designed by Felicité Reynolds, Inc.



The scientific library, on the second floor, is easily accessible from the several laboratories and from elevator and main stairs



General office space on the third floor has full windows, fluorescent lighting, acoustical ceiling, asphalt tile floor, air conditioning

Conference and seminar room for the research staff, second floor



The third floor conference room serves as a lecture school



Hedrich-Brasing

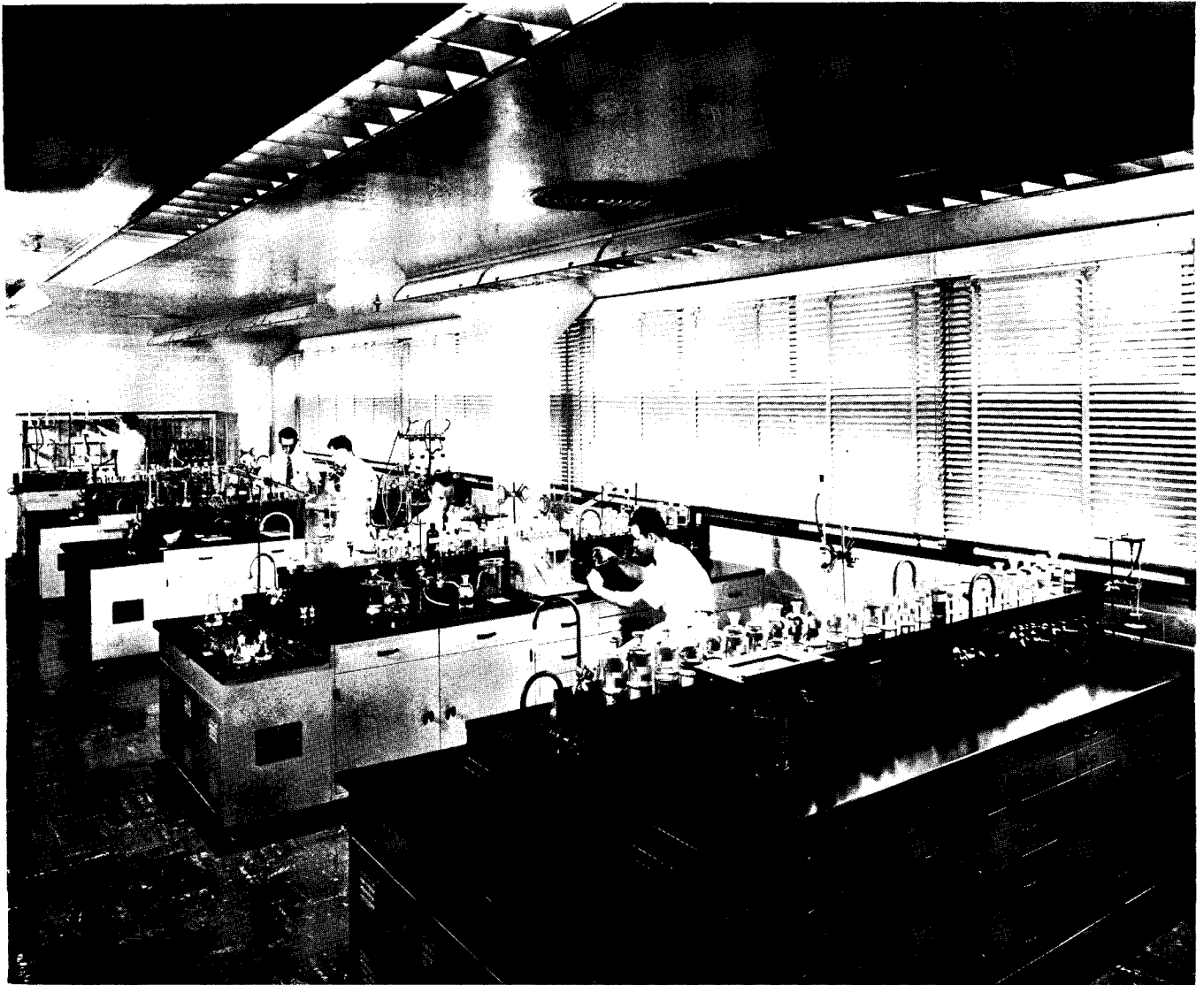

Above: analytical laboratory for the control of manufacturing processes. Right: the hospital room, for emergency treatments and for regular physical examination of all employees, is located on the third or office floor, convenient to offices, stairs and restrooms



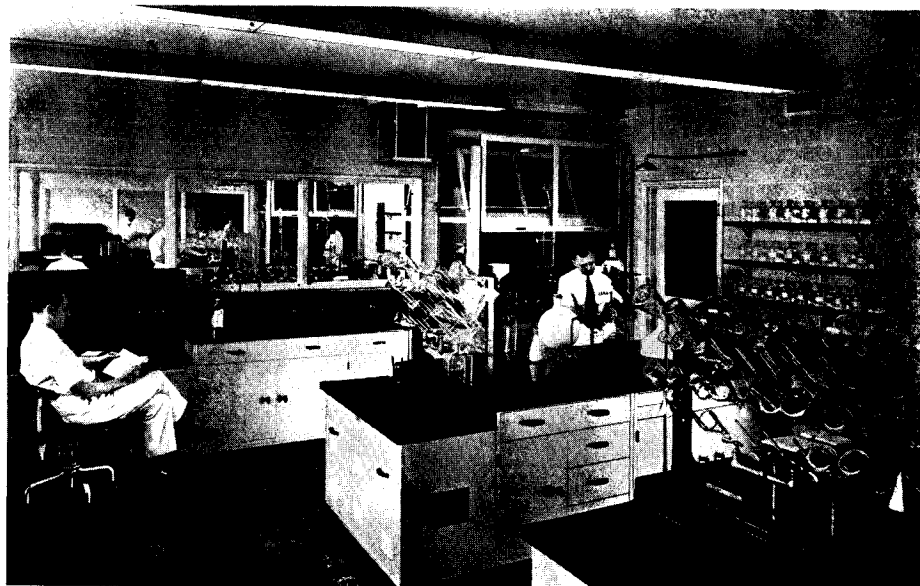
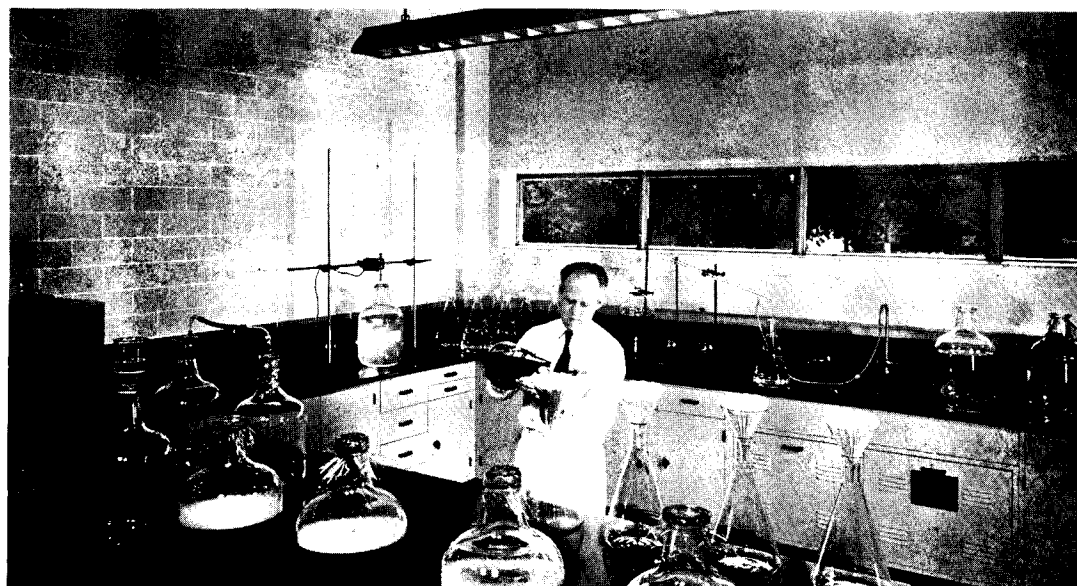
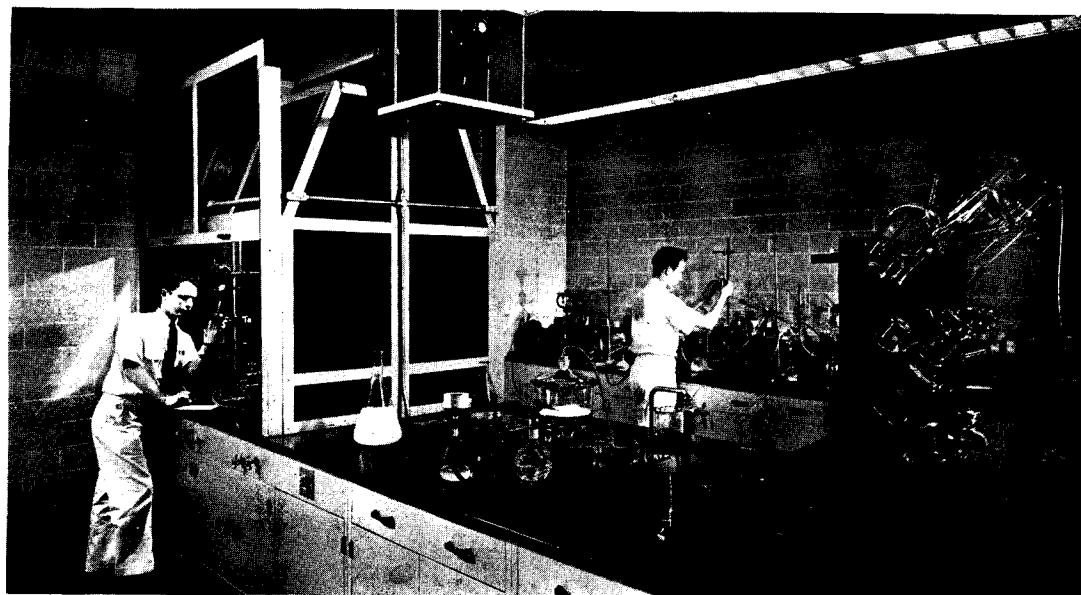

Above right: preparation laboratory, for the making of rare chemicals. Above, left: one of the "ampule" rooms, for filtering solutions. Note interior view of first floor windows. Right: laboratory for organic research

Hedrich-Blessing



MEDICAL LABORATORY ACTIVITIES

A few of the wide variety of activities that must be housed in a manufacturing medical laboratory. Left: animal colony, maintained for assay and for pharmacologic studies. Animals are kept in a special room of constant temperature and humidity. Center picture strip: specially filtered air is required for tablet-coating kettles; a view of a packing machine, and one of a machine for pharmaceutical analyses. Below: two views of intricate analytical operations; left, a micro-analytical apparatus for testing rare substances; right, a kymograph for recording animal reactions to new drugs

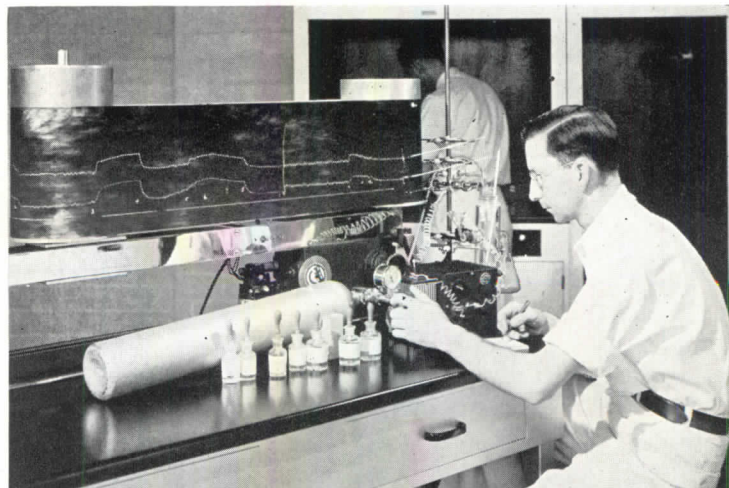
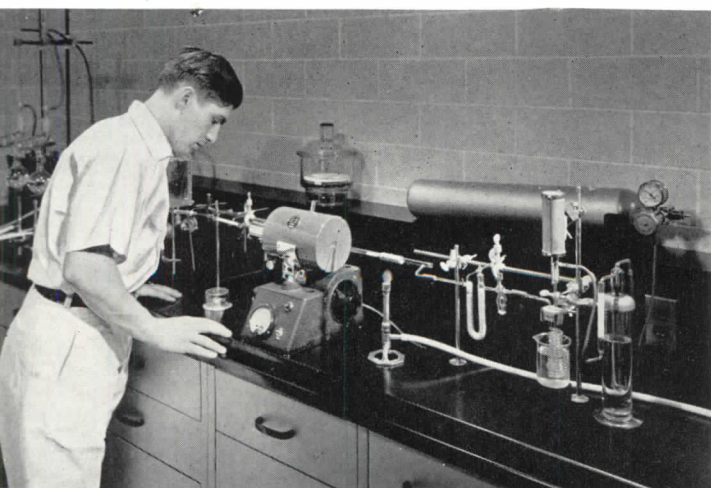
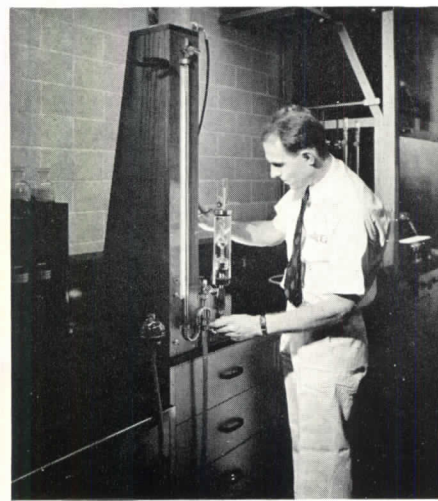
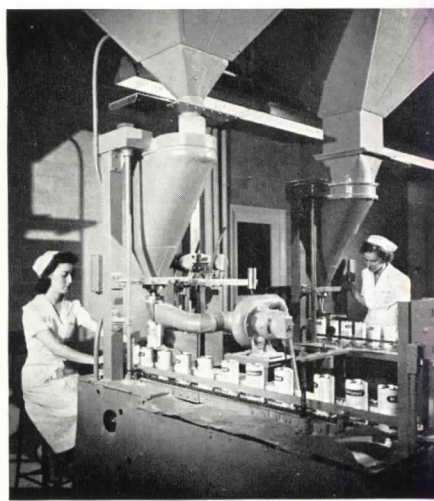

Hedrich-Blessing



PREFABRICATION:

ARCHITECTURAL RECORD'S

BUILDING TYPES STUDY NO. 78

1. ASSEMBLY LINES REACH OUT FOR MARKETS

BY DOUGLAS HASKELL

2. TECHNICAL ADVANCES: PRESENT AND POTENTIAL

BY HOWARD VERMILYA

TECHNICAL DIRECTOR, TECHNICAL DIVISION,
FEDERAL HOUSING AUTHORITY

3. LIST OF PREFABRICATORS

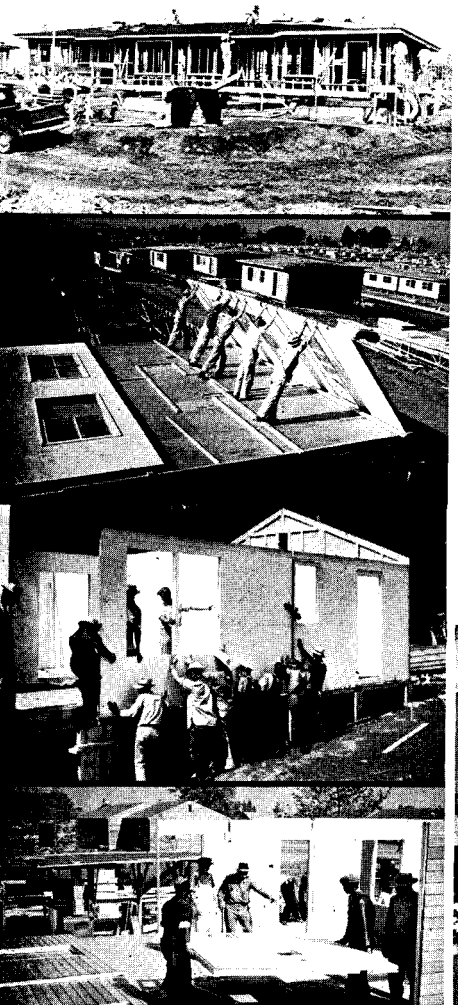

ASSEMBLY LINES REACH OUT

Prefabrication means more than panel systems and production. Distribution, its biggest postwar problem, is taking prefabricators along widely divergent paths

NO factory assembly line stands by itself. The most mistaken of all ideas about the approaching industrialization of house-building is the idea that engineering can make it automatic, through some miracle named "prefabrication." Industrial methods mean nothing apart from distribution methods!

The two affect one another. Not only does a new method of production profoundly influence distribution, but there is also a radical influence of distribution upon production. Three different ways of placing houses in use can produce three entirely different approaches to the assembly line. Whether the intention is to dispose of packaged houses as a dealer sells automobiles, or whether the intention is to place houses in consumers' hands through the department store, or whether the plan involves making units that are suitable to large-scale developments under rental operation, the market procedure makes an enormous difference in the method of designing the houses or parts, the method of locating plants, and of dealing with such professionals as architects, contractors and builders. The market approach makes a difference even in the attitude toward purely "engineering" problems such as man-hours and straight-line production.

It is this neglected aspect of the "prefab" problem which will be briefly examined here, by the simple method of looking at three or four leading projects already

under way, to see how production is fitted to the transportation and sale of the structure, to the problem of land and of community planning, to labor and finance. Such an approach may help to clarify the situation. Throughout the past decade, there has been more disturbance to mental peace from prefabricated notions about prefabrication than from any development that has taken place in the field, where man meets mortar.

II

The rounded view is the more necessary because building is being nominated once again to lead the people back into the promised land. Before examining current projects in more detail it may be valuable to make a quick general survey. In some important respects the building horizon of 1943 resembles the horizon of 1933, just a decade ago. There is the same excitement and impatience. In 1933 it looked as if house-building would be reorganized as a new industry to carry the national economy out of depression, and it is now being relied upon to lead us out of war in the same way. In 1933, glowing visions of the "house of the future" were sandwiched in the popular magazines between visions of the tear-drop automobile and the heralded \$700 airplane. Today the car of the future still takes first place, the helicopter brings up the

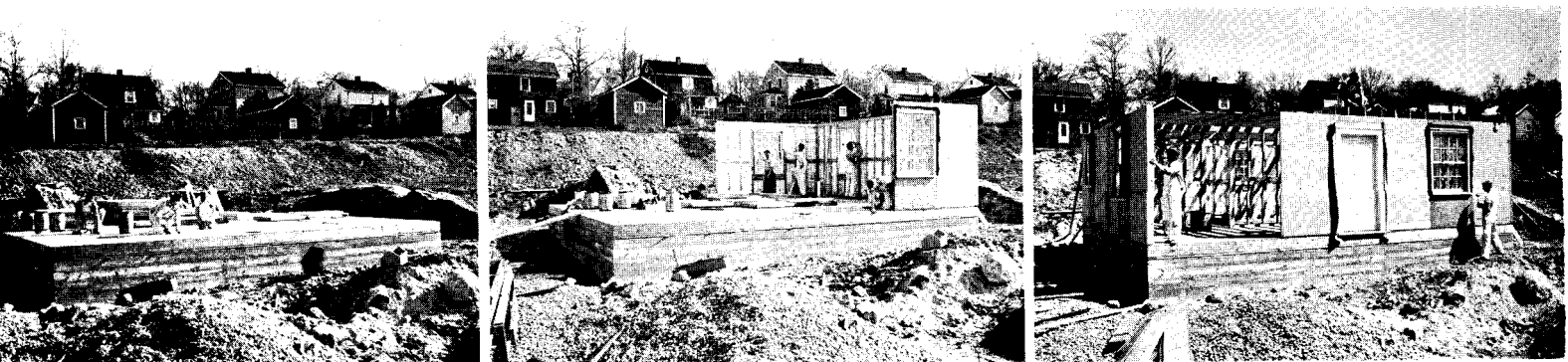

American Houses, Inc., do not make a point of construction speed records, stressing instead the predictability of the finished product. But

FOR MARKETS

By DOUGLAS HASKELL

rear, and the "miracle house" is bracketed between them.

In 1933, the heavy industry was looking desperately for new markets and the "house like a Ford" was put forward as an outlet for steel. Manufacturing facilities lay idle looking for new products, just as plant capacity may be expected to lie idle after the war. On the earlier occasion, certain industrial heroes were expected to qualify as the Fords of housing, notably the firm of A. O. Smith, the chassis manufacturers, who held the place in popular esteem now reserved even more whole-heartedly for Kaiser.

In looking forward today, we can again see enormous possibilities, but will be less surprised at finding a weak link in a perfect sounding argument. One approach to the case for industrialization is through the housing *need*. There are a dozen ways of proving that this need is virtually unlimited. One way is to start with the National Resources Planning Board's 1940 figures, showing a deficiency of 2,000,000 dwellings. Throughout five years of war the accumulated obsolescence of all dwellings, at the rate of one per cent a year, would yield another 1,500,000 in need of replacement. Putting loss by fire and storm at 150,000 units gives us a dwelling shortage of close to 4,000,000 without even counting in the war shortage. War temporaries, demolished in the name of peacetime decency, would raise the total by half a million; and as for sub-standard shelter, on any definition one

might want to choose from among the many possibilities held forth by the 1940 census, it runs to seven ciphers. The need can be interpreted so as to lie anywhere between 10 and 20 million dwellings.

This is a need, not a "demand." Demands are created out of needs, to the degree that imaginative enterprise or imaginative policy runs a need through the gauntlet of finance.

Another approach is through raw materials, pressing for markets. A government official in a good position to know has described the situation in terms of a "perfectly fiendish new potential." Steel production by the end of 1942 exceeded 1939 production by approximately 63 per cent, and half of this larger output was in the form of new alloys. Scheduled aluminum production by the end of 1943 will amount to another 63 per cent increase—not above previous United States production but above the 1938 consumption of the entire world. Pilot plants have been built for the extraction of aluminum from common clay. The famous Reynolds plant in Alabama carries the older process from the extraction of bauxite ore through to the production of finished goods all at the one place. In magnesium we exceed our peacetime output by no fewer than 50 times.

Now metal tends to industrialize any product that it enters, including housing, and, conversely, industrialized products tend to use more metal. Nevertheless, metals too will have to run a gauntlet. The limit is set by weight and the cost of transportation. One of the most experienced of prefabricators, who has worked with all types of materials, observes that the shell of a house is sold finished at not more than five cents a pound. If this observation had been made ten years earlier, much money could have been saved that was spent on experiments with the all-metal house. Although the use of metal will be vastly expanded and perhaps be made cheaper through competition of one kind against another, especially in the higher price ranges and in interior equipment, yet great caution must be used in predicting mass-production of complete metal dwellings. The 1933 attempts were based on a faulty analysis of the market.

Still another approach is through manufacturing facilities looking for an outlet. The productive capacity of General Motors alone by the end of the war is expected to exceed \$5 billion. The size of new facilities such as Ford's Willow Run is too obvious to be dwelt upon. Machine tool capacity is up, not 15 per cent, but 15

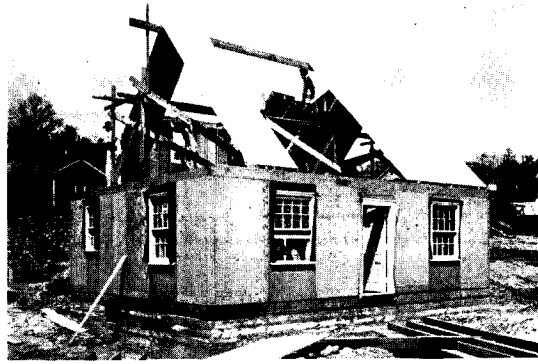
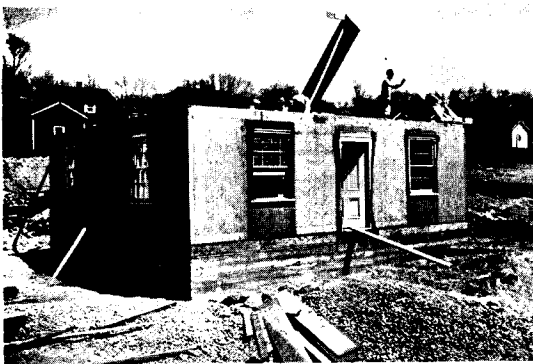

here they demonstrate that a few men can erect the structure in a few hours, in this case starting at 8 A. M., and finishing at 3:55 P. M.

times. Moreover, it is argued that large industrial manufacturers have already branched into house equipment—refrigerators, heating plants, air conditioning, kitchen cabinets. Rumors are that automobile interests are engaged in acquiring interest in promising prefabrication ventures already under operation, in the same way that they have acquired heavy control over the manufacture of airplanes through the war.

The whole question of whether the automobile industry (or the airplane industry) will do more to help or hurt housing is an "iffy" one not to be settled without deeper study. We know that the automobile industry grew largely at the expense of building. While automobile costs were halved, construction costs doubled, and this was an important feature in the picture. In the interwar era, countries such as Britain did more with housing in just about the proportion in which we did more with cars. Our cars beat our houses. *Cars have the chance again.* After an initial return to the use of old dies for immediate change-over, the automobile industry has every opportunity to proceed with the romance of the "miracle car," virtually a new product of which every necessary element has already received full engineering in detail, on busses, trucks, and other vehicles.

It would be possible to survey the future from a number of such general approaches. Every one of these inquiries ends, however, not on the question of materials, tools, or engineering but on the question of the combined operation, the *know-how* required to carry mass or quantity production through to mass or quantity sales, in the uniquely complicated housing field—complicated because it not only involves heavy expenditure but the whole question of the land. We might do better to observe what is being done by those who have already backed their guesses with their money.

III

One path for prefabrication to follow is indicated by American Houses, Inc. Intrinsically the service rendered by such a company is not a merchandising service but a professional service: *of* professional architects, *by* professional car builders and contractors, *for* professional rental management as the ideal. True, American Houses have also produced and sold houses in other ways, but their preferred field is the rental field in which expert knowledge can be brought to bear at every point to

deliver to the consumer not just a house-package but a *smooth, continuing, residential service.* New business arrangements are constantly being explored which might yield the satisfaction of ownership with the security of controlled communities.

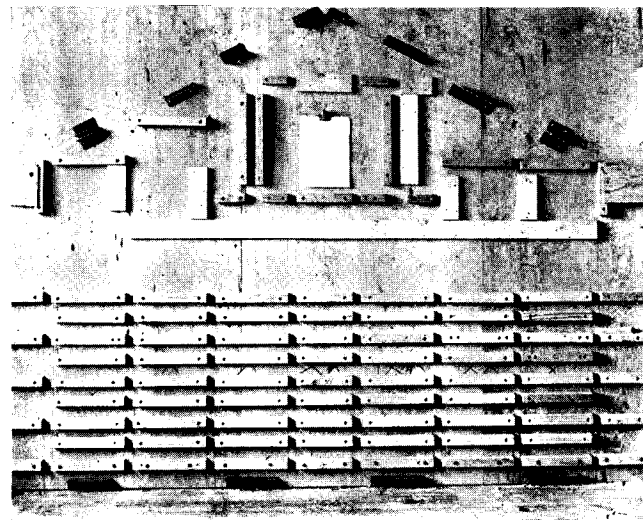

One jig table (American Houses) serves for many panel types

The whole approach is at opposite poles from selling a packaged house. Flexibility and adaptability are at a premium in the program, because the sponsors do not drop out of the picture with the sale but must achieve niceties in good site adjustment, good rental planning, easy maintenance and long-term acceptability for a continuing operation.

Standardization is therefore on no one model, style, material, finish that might be carried through with brutal manufacturing economy, but only on the modular sections of the *house-chassis.* Experience and experiment have taught the sponsors how this may be combined with the greatest diversity of either single- or multi-family plan, and with exterior materials including brick and stone as well as wood siding, asbestos shingles, and any others.

Interestingly enough, the chairman, Mr. McLaughlin, lays no stress on vast man-hour savings or individual speed records. These, he says, are relatively easy to set up. What he does stress is something more surprising: *predictability.*



First of the really large-scale site prefabrication projects of Homasote houses done by Barrett & Hilp, this one the now-famous Vallejo, Cal.,

Predictability means that even if a conventional builder were to match a "prefab" builder point by point on some specific undertaking, the "prefab" builder would still have the advantage. He could safely expect to repeat. He could be more certain that unusual performance was not due to special conditions, such as skill on the part of some individual foreman.

Accurate shop routine supplies this builder more rapidly, and more predictably, out of stock; the erection routine is worked out not by one foreman on one job but on countless jobs by competent engineering. When variability affects only 15 per cent of a job instead of 40 per cent, argues Mr. McLaughlin, there has been a formidable gain. It makes for a safer project all along the line. This means that if a conventional builder could count on getting off the site in four months, the prefab builder could count on getting off in three, adding one extra turnover for the year. This has not the exciting sound of one house off the belt every 40 minutes, but comes closer to the rate of production of large finished developments.

American Houses now have four plants of their own and eleven licensees blanketing the country. These occupy a manufacturing position midway between the house-packaging plant with its moving conveyor lines and the job-lot efforts of "site-fabrication" by large contractors. As against the first of these competitors they seek the advantage of flexibility; as against the second, of continuity. Site-fabrication is a method of minimizing risk; but the temporary plants in circus tents or tobacco barns could scarcely be set up and taken down economically for developments smaller than the wartime projects, which run as high as 5,000 houses in a group. But American Houses believes that there is a top as well as a bottom limit for highest proficiency on a single site. Even when one hundred houses have been reached, some factors in the efficiency curve begin to drop. (One thousands TDU's was the largest single order that the firm accepted, refusing even under pressure to undertake a development with 6,000 demountables.) Permanent, though decentralized, plants have the advantage meanwhile of the cumulative efficiencies that derive from steady operation.

Transportation is a factor in which decentralized plants have an advantage over one central one. Prefabrication talk is full of the phrase "truckable radius." This, however, is the chief problem for only one kind of product, the packaged house based on large wall-sections. Other kinds can be shipped by rail. For a flexible service such

as American Houses, transportation is a management problem, not a blueprint problem of statutory distances. On the basis of records, a 20-ton house averages a total of 23,000 ton-miles—enough to carry a ton around the globe. This shows how important is transportation, how valuable is professional skill in taking advantage of rate structures and special situations. In general, it has been found feasible to ship complicated elements, such as mill-work, a long distance after completion; simple elements only a short distance. On a project at Norfolk, Va., mill-work was shipped finished from Kearney, N. J., but pre-cut yellow pine from Jacksonville, Fla., was made up into panels close to the job.

A special function is performed in this "prefab" service by the element of design. Early in their experience, the sponsors found it impossible to put across modern design, new materials, and prefabrication, all three together. They chose prefabrication as their field, but have gradually discovered that it involves a new design discipline, different from stylistic "modern" and far more basic in its implications. No one is more important to the economy of the enterprise than a designer capable of evolving simple, standardized, flexibly adaptable, multi-purpose structural elements such as, for example, their famous "egg-crate" structure which is alternately usable as a simple decorative interior partition covered inexpensively on one side only, or as a decorative porch screen, or as an arbor—in every instance effective. And again, given a vocabulary not of classical features but of structural forms, no one can sound the possibilities as well as collaborating architects can, provided they adhere to this new discipline.

The experience of American Houses lays down no universal "prefabrication pattern." It does illustrate that there are advantages in prefabrication when it is adapted to some coherent idea of distribution and service. This particular one is the professional one. Doctors guard health against breakdowns, lawyers guard against disagreeable surprises, this kind of builder guards residential life, in a community, against obsolescence and decay.

IV.

Another approach is taken by a prefabrication company that is expected to organize itself, very soon, as a large corporation selling stock to the public. The name is expected to be Homasote Homes, Inc., and the capitalization

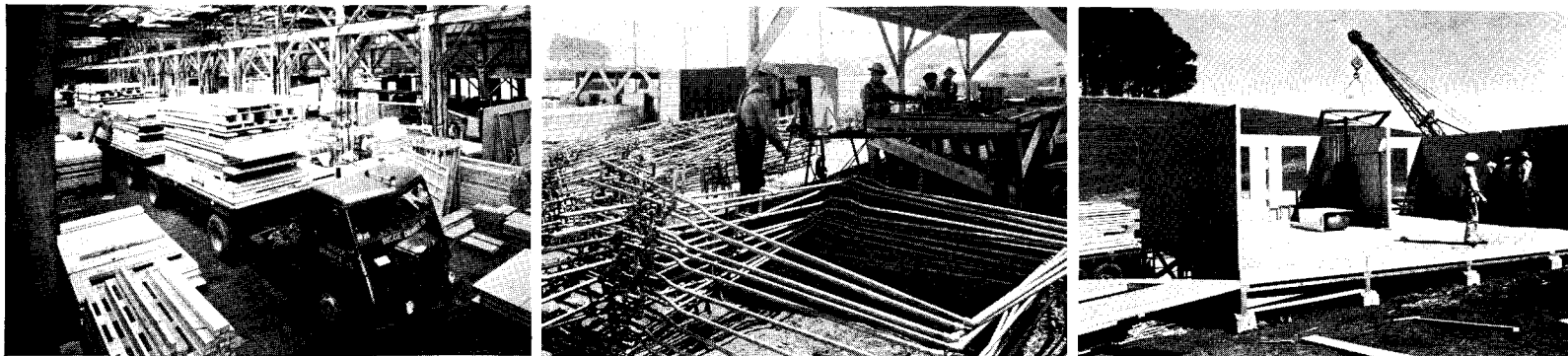

housing. Power saws and jig tables were set up at the site, and panels trucked to house plots. Even plumbing lines were pre-assembled

that is spoken of is around \$10,000,000—a business publication places it higher, at \$15,000,000.

The idea is to couple a quantity producing program with a quantity merchandising program through department stores. The product is to be put, by this dramatic means, directly before the public where the public meets most frequently and in the largest numbers.



One of the Homasote models used in department store selling

Throughout "prefab" history, special promotion has been undertaken by manufacturers of adaptable building materials. Homasote is known to the industry as a wall covering that comes in large sheets and is made of re-pulped newspaper combined with oils and adhesives before being pressed into hard boards. Such building materials are sold more profitably in the fabricated form. A "prefab" house does not have to be all steel or all plywood or all something else to make this kind of enterprise worth while. A bill of materials used in a well known Portsmouth project included:

24,000,000 ft. of lumber	6,500,000 ft. of redwood siding
90 tons of glue	46,000 squares of asphalt shingles
15,000 kegs of nails	75,000 gal. of paint
500,000 ft. of flooring	533 carloads of Homasote

In this instance the manufacturer's own product bulked less than many of the other materials, and yet it was good business to work out the "Precision Built" method, involving all the other materials, because the ultimate product

was a specialty product involving the material of the manufacturer himself.

Ever since Mr. Vaux Wilson, Jr., became vice-president in charge of sales in 1934, this company has been a vigorous promoter of mass building, using materials dealers as its first natural outlet. Before the war, a stressed-skin structural system had been adapted from the results of Forest Products Laboratory, a modular system of design for room-length panels from Bemis Foundation, and a string of more than 50 regional fabricating plants had been set up, largely in connection with big lumber yards. More recently, while Barrett & Hilp, the large contractors, were rolling up speed records by means of the new structural system at Vallejo and at Portsmouth, the home office at Trenton was equally busy. The regular sales staff was kept intact despite the absence of immediate markets, and put through a daily routine putting up and taking down experimental houses.

Meanwhile, Wilson's strongest departure has been the merchandising idea. The houses have been presented to the public in quarter-scale models taken into the department stores. In March it was Fox's at Hartford, Conn.; in April, Macy's in New York; and in May, Bamberger's in Newark, with others to follow, on a nation-wide circuit.

What Homasote expects of the department stores is to start development now of the postwar market. Although there are as yet no houses to be sold, "Own-Your-Own-Homes Clubs" are being set up, on the precedent of the Christmas Clubs organized by banks, as a method of gauging interest and starting savings rolling. To establish down payment, against prices that cannot yet be quoted, the houses are divided into two groups. On houses of fewer than six rooms the down payment is \$70 per room (a dinette is "half a room" and a bathroom is "free"); and on houses of six rooms or more the down payment is \$90 per room. These amounts are intended to represent, roughly, the 10 per cent of the total expected price that will be required for FHA financing.

The plan, then, is a downright selling plan to consumers. What the department stores may do is anybody's guess; the promoters think that 60 stores may average a thousand units, yielding the grand total of 60,000 houses. This is based on the huge daily volume of traffic through big-city stores, often in excess of 100,000 people. However the sales may actually run, they will be made to individuals. The Company is preparing for a price range corresponding to that of its development at Fort Lauderdale, where one-

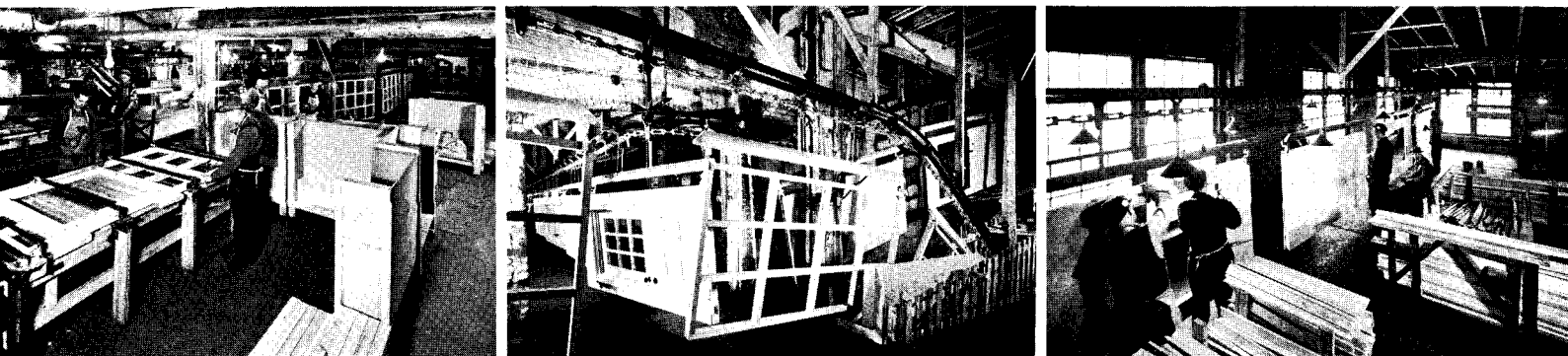

Feature of the Gunnison Housing Corporation system is an overhead conveyor assembly line, on which panels move from jig tables, through

half of the units are in the higher range running from \$8,000 up to \$15,000.

These figures are all the Company's own, and in the nature of events represent forecasts rather than achieved realizations, but they indicate the direction in which plans are going. Reasons for the department stores' interest are easy to find, since the sale of a house instantly opens a further market for house furnishings.

Some incidental trends appear to be associated, granted that the enterprise is successful as a whole. What are now independent services can be expected to gravitate under the control of either the manufacturer or the department store. Real estate service may well gravitate to a real estate department; architecture—like decorating at an earlier stage—will tend to come into an architectural department, not all in one step but by degrees. It is possible, of course, that the total of architectural work will be expanded, because house-by-house designing in the lower price ranges that will be reached through this plan has seldom been the prerogative of others than contractors and merchant builders.

It would be very false to draw a simple chart for this prefabrication plan, drawing a straight line from materials manufacturer to prefabricator, from the 50 regional prefabricators to the department stores, and from them to the consumers. Viewing the matter independently, one can see that, in addition to the department-store type of outlet, there could be others. A heavy capitalization can in itself create an economic force; for example, prefabricators already enjoy advantages in the equipment market beyond those of the largest of the contractors.

What the plan indicates is the belief that prefabrication is now adaptable to large-scale merchandising. The decentralization plants are counted on to effect economical construction and delivery. The scheme permits considerable variety in architectural planning and design, whether by independent architects or by architectural departments. In the end this project depends on the performance of the material. A show of success will, presumably, invite competition by many others.

V.

And then there is the industrialized mass-production approach. Foster Gunnison has always been the unbending advocate of mass-production by the assembly line. At the plant of Gunnison Housing Corporation at New Albany,

Indiana, packaged homes can move off the conveyor belt at the advertised rate of one every 25 minutes under the slogan "Press the Button and You Get a Home."

The Gunnison effort comes the closest of any yet, in the line of prefabrication, to the engineering and marketing method of the automobile industry, and it is not surprising that there should be rumors of automobile manufacturers' interest in it. Shop production is aimed at true mass production rather than quantity production, and the

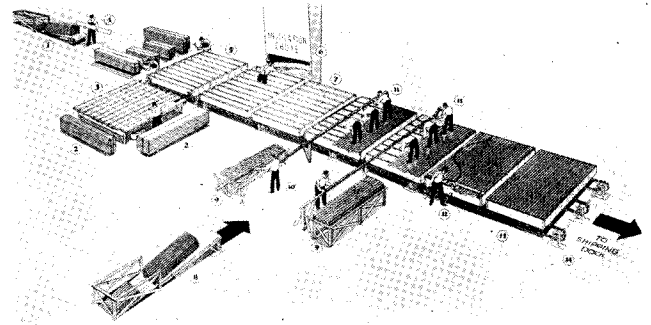

Conveyor system makes a Gunnison floor panel every six minutes

market objective is to make mass sales direct to the public through the manufacturer's own specialty dealers.

The moving conveyor belt in the New Albany plant, which replaces the stationary jig tables of more common occurrence, is real, and has been described with admiration by those who have seen it working. Floor panels, to take an example, move off at a rate of one every six minutes. The plywood with which the houses are currently covered is made by the manufacturer, who thus has a small start toward vertical organization. Since 1936 the floor and wall panels have been genuine stressed-skin trusses of the Forest Products Laboratory type, made by a hot pressing process with waterproof glue on special equipment. The method consequently represents a relatively high integration of structural engineering and process engineering.

Design, transportation, distribution, are all correlated to the conveyor belt. Plans, too, are prefabricated and offered according to number, "architectural treatment" is applied from stock, shipment is by packages and even the size of the standard panel, 4 by 8 ft., is adapted to pack-

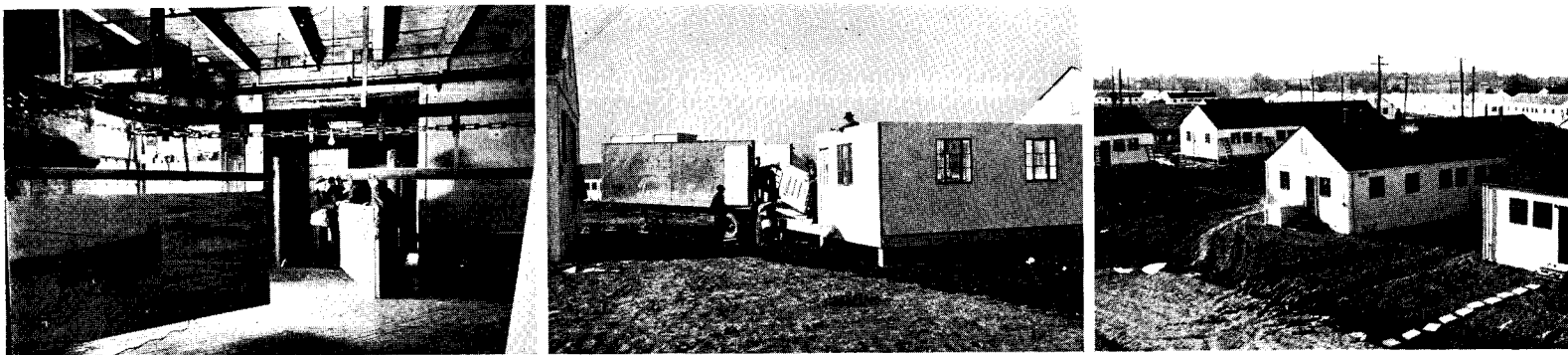

finishing operations, to loading platforms. A 3-h.p. motor is credited with material handling work that would otherwise require 125 men

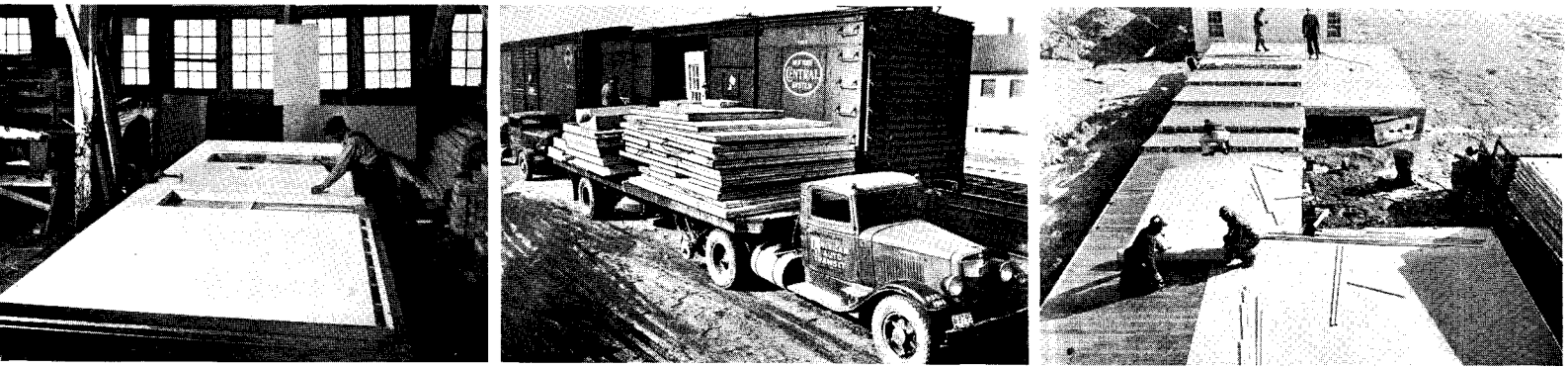

Sheets large enough for an entire wall provide unbroken surfaces in the system of The Upson Company. These pictures show the whole-wall

aged, railroad transportation. Gunnison hates to make a separate contract for every job lot as represented by some one housing project, and prefers to work at a specified rate. Time is of the essence, and he demands that the government feed its orders steadily in a manner permitting the efficiency of a steady flow.

For purposes of true conveyor-belt mass production, Gunnison has in mind a simple chart. In his opinion the one proper way for raw materials to move in the prefabrication process is straight to manufacturers of sub-assemblies. From there the path should lead to plant prefabricators, from there to dealers handling sales, erection, and service, and from these to the customer (with the aid of real estate and finance). However, life is broader than dogma, and closer attention will reveal that the house plans are quite surprisingly flexible, that there are deviations from the ideal chart, and that a dealer here and there might look like a small builder—just as the early automobile dealer sometimes looked like a bicycle shop. Perhaps the one thing that the conveyor belt most needs for efficient operation is plentiful backing by finance.

VI.

All these various approaches toward prefabrication, being made in actual practice, indicate a condition not so much of confusion as of vitality.

There are many others that could be mentioned if there were unlimited space. For example, there is the strictly

research approach illustrated by such an agency as the John B. Pierce Foundation under the direction of Robert L. Davison. Through this means there has been found a practical method of holding the door open for new materials, new construction methods, and new concepts of planning for human use, no matter how remote may be their immediate application. Large equipment companies such as the American Radiator Corporation and Standard Sanitary Corporation, in backing such research, have been far from impractical or visionary. Such research yields byproducts along the way, in the form of methods that can be issued under license, and it increases industrial "know-how" in building without being limited by one merchandising method or by one material. "Know-how" is by far the most important product that any industry has to sell.

VII.

The brief examination of prefabrication schemes in relation to the market seems to indicate that there is no one set pattern that can be called "prefabrication." It is neither a single all-embracing hope all by itself, nor a single all-threatening menace. Designers who expect to reach the top by inventing the one perfect standardized panel or the universal house-joint are foredoomed to bitter disappointment; prefabrication design has no meaning apart from some coherent scheme for distribution. On the other hand, those who fear the instant elimination of the designer have forgotten that the design function has

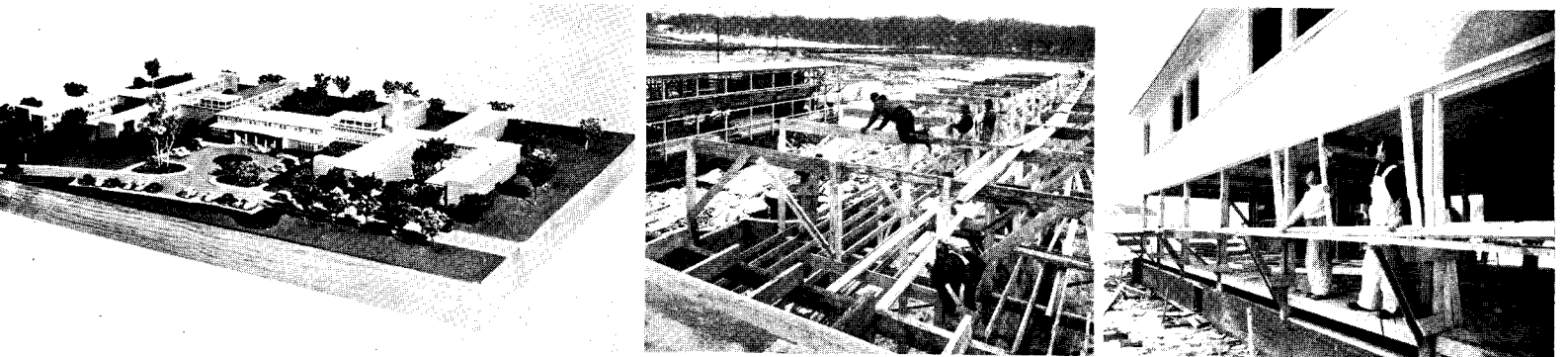

Site prefabrication of large multi-unit buildings, in this case the Arlington Farms Women's Dormitories, near Washington, D. C., to house



panels being built in a plant at North Tonawanda, N. Y., trucked to box cars, and being assembled in Dayton, Ohio, in a war housing project

not disappeared but merely taken on new forms.

"The prefabrication situation," says Miles Colean in a National Resources Planning Board pamphlet on *The Role of the Housebuilding Industry*, "is not unlike the automobile industry in the early part of the century, when wagon builders and bicycle makers rushed into the new business and when each year brought many new plants and saw the disappearance of many others. By the end of the war a considerable elimination . . . is likely to take place. A new pattern of production should be pretty well worked out and a number of seasoned organizations be ready to serve the needs of the postwar period. . . . If at the right terms and prices and in the right places the country could absorb anywhere from 900,000 to 1,200,000 new dwellings a year, for a decade after the war, a program so large as this . . . is well beyond the production of any previous decade." The housebuilding assembly line stands very near the bottom of the typical industrial curve, and the rate of climb depends on ingenuity; but it scarcely looks as if the direction could be any but upward.

In closing, a pair of remarks about the general nature of the industrial opportunity. In the building field, it is customary to correlate housing prospects and income. Yet a new industry grows not parallel with income but much faster. Thus the country's annual income in 1916 had increased above 1912 income by about 25 per cent; but during the same period the annual production of automobiles increased by about 475 per cent. This is because people buy the new product instead of other

things. To achieve this condition, the new product must make no little promises. The automobile curve picked up between 1910 and 1915 when Olds and Ford were making effective their offer to the common people of a degree of power, prestige, and adventure that were unprecedented. If prefabricated houses can emerge from the picayune phase and offer the romance, volume can grow so that prices are lowered not only in terms of cost per unit, but still more so in terms of cost measured against performance. Thus the Ford of 1924 was down to one-fourth the price of the Ford of 1904; but the price per pound was one-fifth.

Getting out of the picayune phase involves two or three decisions by the industry. One is to remember that people everlastingly buy neighborhoods, not mere houses. Houses dumped *en masse* with no further responsibility for neighborhoods on the part of the makers can only foul the nest once again, and bring tardy, ineffectual government regulation where wise industry could have opened up a whole new realm of order. Some of the war communities that prefabrication has to live down are pretty terrible.

Again, new roles cannot be played in antique costumes. Neither "traditional" design nor "modern" design as such can do justice to an expanding concept. Somehow a new breadth, depth, and directness has to be made visible. Those who think that the American people can't take an idea through the eyes have sadly underestimated the people and misread the records of the past. Faith calls to faith.

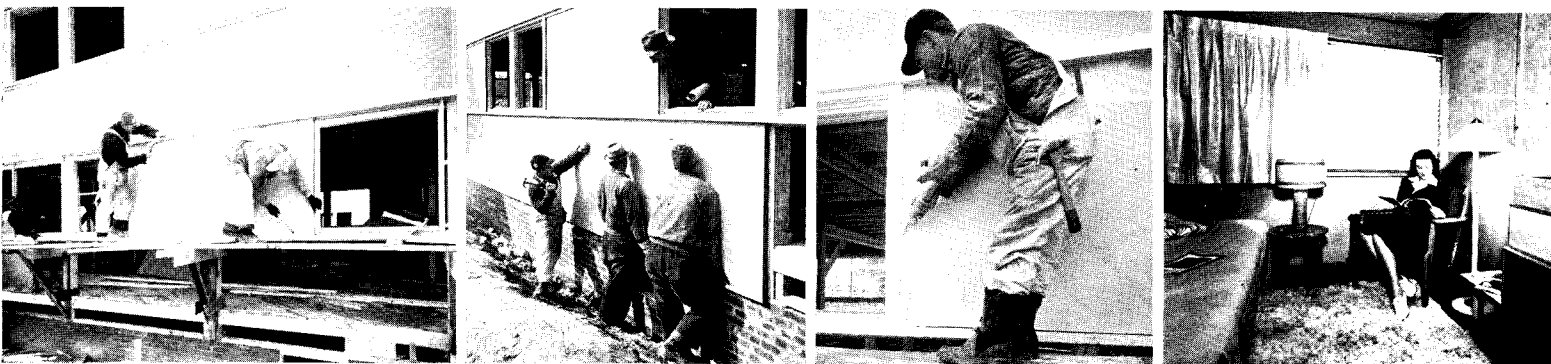

7,000 girls. Outer walls and partitions are inch-and-a-half Cemestoboard (Celotex) nailed to a structural frame of precut members

TECHNICAL ADVANCES: PRESENT

BY HOWARD P. VERMILYA, DIRECTOR, TECHNICAL

FEATURE articles, the Sunday supplements, and attention-getting advertisements stress wartime technological developments. Dramatization of the products of research laboratories stimulates dreams of the different world that lies ahead, and conjures up visions of magic houses to be pulled out of the hat at the end of the war.

In the development of postwar houses many technical advances will be used; for many of these advances have possibilities for immediate application, while others will make possible the use of heretofore uneconomical materials and building methods. Progress in housing will be made after the war, but we should not be carried away by the prospect of the novel and the spectacular, nor permit public hope to soar to impractical heights of anticipation.

War has the effect of speeding up the evolutionary process. As a result, human endeavor, especially in technical achievements, hurdles time and shortens the interval between pure research and its practical application. Scientific research is intensified, production for civilian needs is converted to the needs of the military, industry's distribution system is disrupted, and the daily existence of the home front is jarred from its peacetime ramparts.

In converting back to peacetime activities opportunity knocks at the door, offering new ways of doing old things better; solutions to that which before the war was seemingly impossible; and a chance to start anew to build on firmer foundations, and to realize expectations that make the war seem bearable.

The road over which new developments in materials, equipment and methods must travel will not be easy. Antiquated building codes, builder and consumer acceptance, and the questioning mind of lending agencies are real obstacles that cannot be dismissed casually. They will have a retarding effect upon the use of many new techniques in house construction. However, other strong forces are at work in this war which will make a return to the status quo ante improbable.

In the postwar era the struggle for peacetime commercial outlets will be keen. Each new material as well as each old one will have to justify itself in the market place. The test of experience must be met. Each material will be forced to find its own level in the nation's economy, each in relation to others. A plastic soap dish is just another soap dish unless it functions better, costs less, or has qualities that distinguish it from soap dishes of other materials.

* The opinions expressed in this article reflect the author's personal viewpoint rather than an official statement from FHA.

This competition will put all materials and devices on trial.

It is not to be expected that in a loosely-knit industry such as housing, developments of revolutionary proportions will be realized overnight. Evolutionary changes will occur as in the past. A period of experimentation following the war may be expected in which a new, better, *cheaper* system of construction and a better balanced or engineered house may emerge.

During the war many new, large organizations have entered the home building field. To meet emergency demands the development of new construction techniques, both in prefabrication and site fabrication, have been stimulated. Builders have come to realize the potentialities of the mass market and the advantages of quantity production.

At present there is no unanimity of thought as regards the fabrication of houses. One school of thought favors site fabrication and the use of precut materials. Another believes in shop fabricated structures using the stressed plywood principle in the form of panels; others consider the merit of the skeleton frame of wood or metal to which panels or conventional materials are applied; and still others argue the case of precast concrete. In addition, there are a few methods that present radical departures from normal practice, such as the balloon form which is deflated after the structural enclosure has been literally blown over the form.

Houses are composed of a multiplicity of parts requiring different functional and structural characteristics. Obviously no one material would appear to be suitable for universal application. In the postwar era, however, fabricators will have an opportunity through control of the finished product to produce an integrated house in which each material is put to its best use.

Prefabrication today stands a better chance than ever before of being given an opportunity to demonstrate its

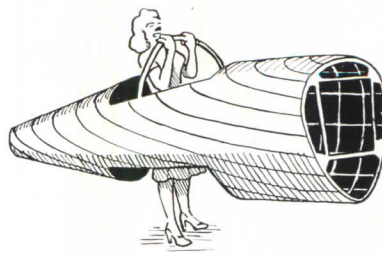

“... gluing methods for aircraft . . . useful to prefabrication”

AND POSTWAR

DIVISION, FEDERAL HOUSING ADMINISTRATION*

possibilities. The feasibility of shop fabrication has been shown; the important question now is one of sufficient sales demand to provide the quantity production necessary to its commercial success. For some years it may be anticipated that efforts will be centered primarily upon market development and the utilization of such industrial processes as can be readily incorporated in the various prefabricated systems. When quantity production is more definitely assured, attention probably will be concentrated on major technical improvements in the product.

In the immediate postwar picture two objectives stand out beyond all others. First, the housing industry must be organized to function as quickly as possible after hostilities cease; this will necessitate using the tools and materials readily available. Second, material and equipment producers must convert from wartime to peacetime production with equal speed.

Whether producers plan to reconvert to their former peacetime products of the same or modified design or to manufacture new materials or products of new design, their immediate sales problem will dictate the production of items that conform to present day building techniques. Since designers are limited to the use of available products, and peacetime conversion must be at a relatively high tempo, few significant changes are likely to occur in house construction immediately after the war.

Technological Developments

The door through which we glimpse the developments of the past few years is only partially open. It is impossible to foretell how practical many of the processes now in development will be. All that can be done at this time is to indicate possible developments and attempt to distinguish between those immediately possible and those which, if they prove practical, may have potentialities.

We do know that the prefabrication industry doubtless

will find useful the gluing methods developed for the aircraft industry, which greatly reduce drying time, the use of heated concrete dies for molding laminated sheets, and vacuum bag molding of plywood. Methods of fixing the moisture content of wood will permit precision manufacture and the quantity production of interchangeable wooden parts. Powder metallurgy provides new and better ways of producing many parts and items made of metal, and overcomes many handicaps in metallurgy. Water and fire resistant fabrics will be available for wall coverings, possibly adapted as surface coverings for prefabricated structures.

The science of electronics—now progressing at amazing speed—holds possibilities for a wide range of automatic control of heating, lighting and other mechanical equipment. Heatronics, or high-frequency molding and curing methods of plastics, open the door to the production of thick plastic sections and laminated structural members. Laminated materials of plastic and paper prepare the way for a new material with many practical uses. Polarized glass and plastic shatter-resistant sheets will offer new possibilities in window glazing. The perfection of the helicopter may make the airplane as common as the automobile and present not only new freedom in where we live but also problems in the design of houses or space on which to land and in which to store the "skymobile."

Electrical Trends

Electrical installations which had reached a high plane of development before the war may be expected to go to further heights in the postwar period. Fluorescent lighting units have reached a stage of development which promises their increased use in residential structures. And, it is possible that they will increase the use of recessed and cove lighting, and cold cathode lighting is being developed for domestic as well as industrial uses. Developments in lighting methods no doubt will be influenced by the trend toward a higher level of general illumination.

With the probability of many women remaining in industry, there will be an increased demand for houses adequately wired to permit greater utilization of labor-saving household appliances. Rubber substitutes and plastics will play a large part in wire insulation, and improvements in and greater use of continuous outlet strips would appear logical. There also undoubtedly will be a tendency to use more built-in electrical equipment.

The Heating of Houses

In the postwar era radiant heating will probably receive greater emphasis than it has in the past. Recent developments offer the possibility of using infra-red "drying" lamps as sources of radiant heat in bathrooms and kitchens, and in spaces in which heat is only occasionally required.

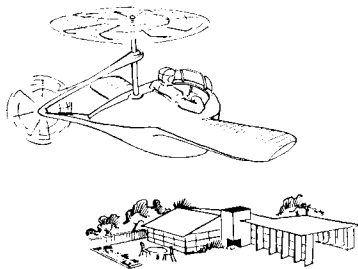

"... houses ... in which to store the skymobile"

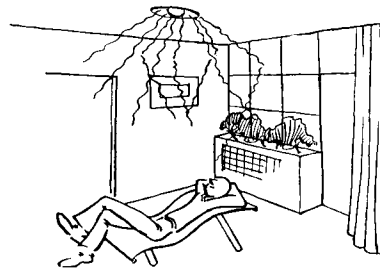

"... using infra-red lamps as sources of radiant heat"

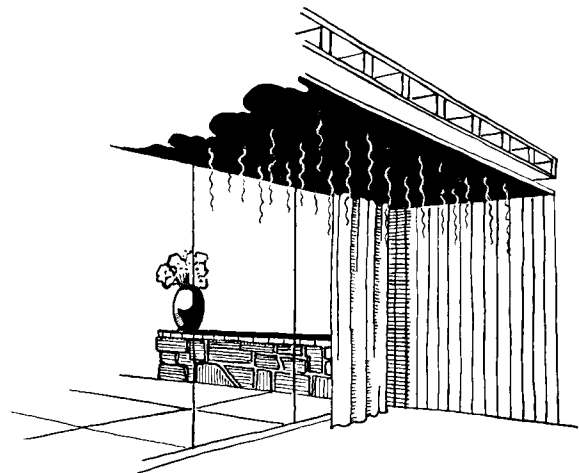
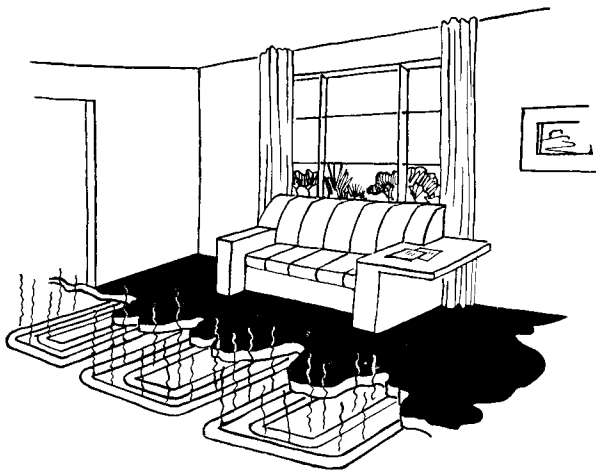

"Radiant heating floor, wall and ceiling panels using either hot water or warm air . . . are in an advanced stage of development"

Radiant heating floor, wall and ceiling panels using either hot water or warm air as the means of heating, are in an advanced stage of development which augurs well for its more general adoption after the war.

Heating methods now being given consideration contemplate maintaining a household air temperature less than that required for comfort but with supplemental devices in each room to step up the temperature to the comfort level when desired. The supplemental heating sources can be provided by radiant heating lamps, higher temperature heating surfaces, or unit heaters. Heating systems so designed might develop desirable economies in their operation.

Economies in the burning of coal as a fuel, accompanied by a high degree of cleanliness and smoke elimination, is promised by such developments as that of the Fellows downdraft furnace which is being perfected at the University of Illinois. Research aimed at greater economy in coal consumption now being conducted at the Batelle Institute probably will have an important effect on the design of future coal burning heating equipment.

Refinements in the development of air conditioning equipment is more than speculative opinion. One important manufacturer has developed for use in war plants a device which by ionization removes dust from the air. If this device is capable of being produced at an attractive price it would be adaptable to residential use, especially in smoke-ridden areas. Elsewhere it would also appeal to

employed women having but limited time for housekeeping chores.

Principles developed for heating airplanes at high altitudes may have long range possibilities for use in the heating of buildings. At present necessary secrecy as to the details of these methods, however, limits general knowledge of this equipment and consideration of its future. Heating equipment that combines the heating of space with the domestic hot water system is not beyond the realm of realization for use in small houses of low heat loss. An important factor in the use of the space-domestic hot water heater is the problem of corrosion which in time may be solved by the use of one of the new alloy metals.

Plastics for Plumbing

Plastic pipe and tubing, a comparatively new development, is immediately available for use in the plumbing systems of postwar houses. Its use for cold water supply lines is at present proposed in a number of housing projects and for hot water supply piping in a few structures where automatic controls will limit water temperatures to 180°. Plastic pipe and tubing has a wide range of usefulness for gas and oil as well as water piping. This material is easily bent and can be joined by a simple heat welding method or readily assembled with fittings. An allied material, plastic coated fiber pipe, offers a new material for drainage lines, plumbing vents, downspouts for roof water,

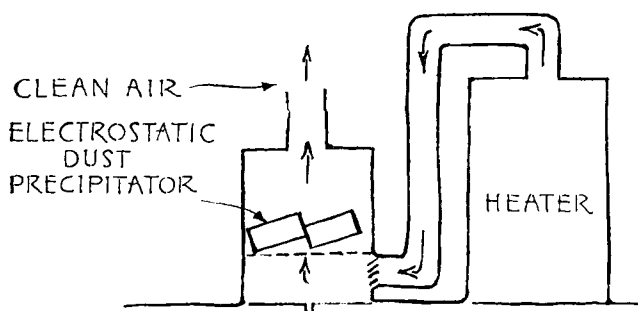

". . . a device by which ionization removes dust from the air"

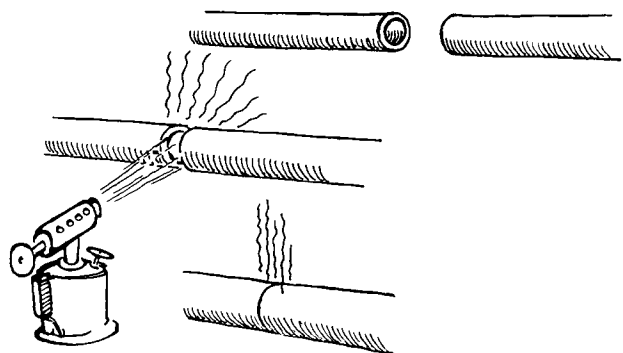

"Plastic pipe . . . can be joined by simple heat welding"

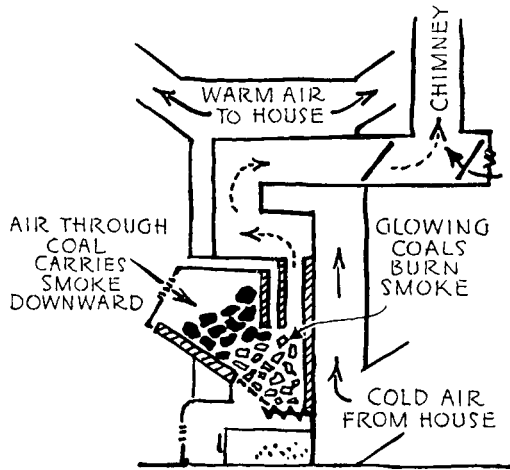

"Fellows downdraft furnace perfected at University of Illinois"

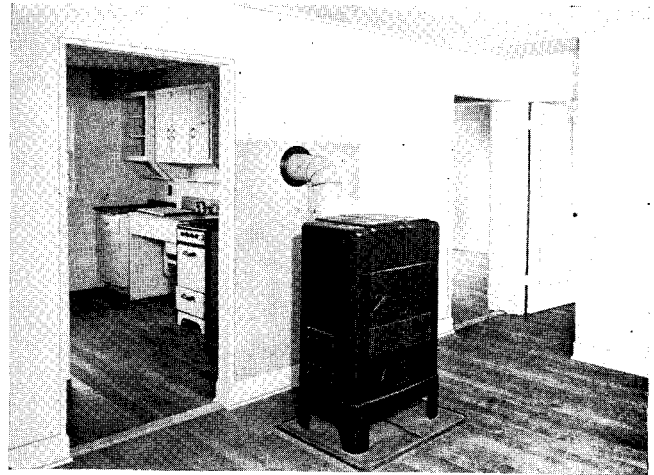

Coal space heater as developed for wartime prefabricated houses

and similar purposes for which metal has always been used.

A variety of plastic fittings, shower heads, drains, and possibly bathtubs, shower stalls, and lavatories will find their place in houses. Some of these are here, others are still on the designer's drawing boards and merely await commercial demand to go into production. With the remarkable advances being made in the manufacture of glass with new and improved characteristics—more resistant to temperature changes and tempered to resist stress and strains—we need not be surprised if this material also appears on the postwar horizon in the form of plumbing pipe, fittings and fixtures.

New Products and Structural Trends

Structural design of houses and new products in the postwar era, if present thinking is an indication, may affect the planning of our homes. In single-family houses we may look forward to development of the one-story house with greater integration of the outdoors and the indoors, and houses in which the plan can be rearranged at will.

As a result of developments in radiant heating the use of a concrete slab laid on the ground has more attractive possibilities than heretofore. Large sheets of laminated materials which combine weather resistance, heat and sound insulation, and an interior decorative surface offer possibilities as curtain walls in structural systems of the post and lintel type. A forerunner of these is already

seen in laminated cement-asbestos and insulation board. To eliminate or minimize joints in wall and ceiling surfaces, the demand of prefabricators will develop a market for large, wall-size sheets combining insulation and finished surfaces.

The fuel shortage forcefully brought to the attention, particularly of individuals living on the Eastern Seaboard, the advantages of well-insulated houses and the high heat loss which is experienced through windows. With the tendency toward use of larger glass areas and the stress laid upon the utilization of solar heat, increased use of windows with double-glazing of glass or transparent plastic may be anticipated. One manufacturer is now studying the possibility of sandwiching venetian blinds between two layers of glass. More and more window frames and sash unquestionably will be made of impregnated wood, aluminum, or steel alloys.

New plastic materials indicate improvements in laminated doors, and related to these materials, the resinous paints will provide more durable finishes for interior trim, floors, walls and ceilings. Plastics will find more important uses in hardware fittings, counter tops, window screens, plumbing fixture fittings, towel bars, parts of household equipment, and extruded shapes for many other purposes.

A wide variety of sub-assemblies are in process of development, ranging from window frames complete with sash, double-glazing and screens, to prefabricated closet

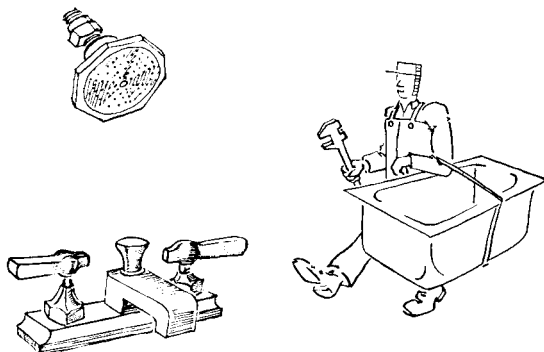

"A variety of plastic fittings . . . drains, and possibly bathtubs"

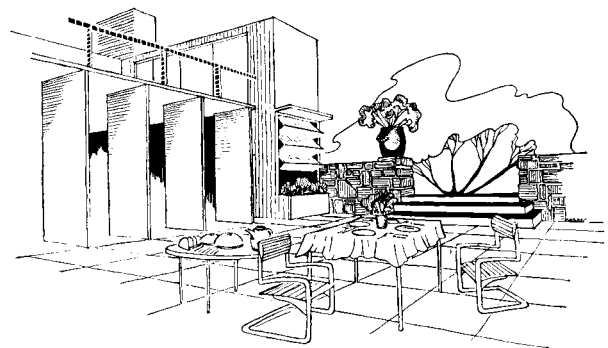

". . . house with greater integration of outdoors and indoors"

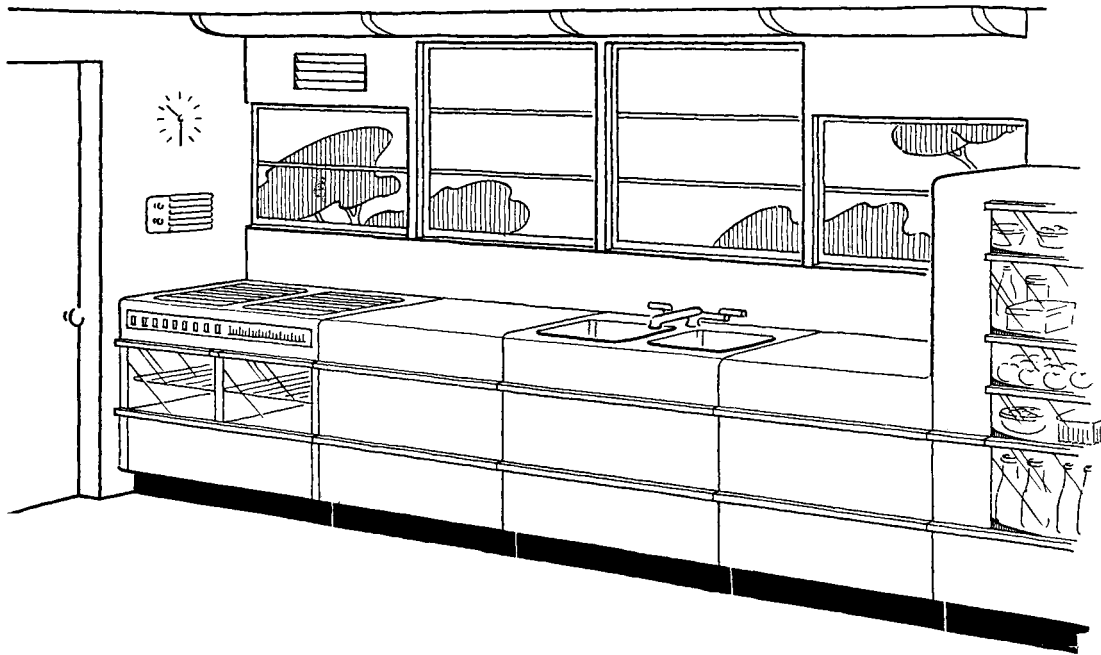

"Greater revolution may be expected in the general conception of manufactured kitchen equipment than in any other. . ."

and storage units. Many of these have good prospect of use in both factory and site constructed houses. And, there are indications that preassembled bathroom and kitchen units will become a reality, especially for use in prefabricated houses.

Modernized Kitchens

Greater revolution may be expected in the general conception of manufactured kitchen equipment than in any other one part of the house. Integrated sinks, cupboards, ranges and refrigerators of greatly improved design and made in standardized units are being developed. Glass-enclosed ranges that permit the cook to watch the cake without opening the oven door will be available. A wide range of electrical appliances in many instances may replace the familiar kitchen range or the components of the range may be distributed and incorporated within the kitchen units. Improved dishwashers, garbage disposal units, and much other labor-saving equipment probably will be of the luxury type for houses of more than average cost. At the same time it may be anticipated that kitchens in low cost houses will be designed to a higher standard than now prevails. Stainless metals, plastics, glass, wood, resin paints and laminated sheets will play an important role in creating kitchens easily cleaned and sufficiently attractive to serve as dining areas.

Flexible House Planning

Long-span construction using resin-bonded plywood, laminated structural members, or light-weight metallic girders or trusses holds the promise of realizing the flexible planning of houses—today merely an interesting idea. Continuous spans between exterior bearing walls, or exterior wall columns, make flexible planning possible by the use of non-bearing partitions, folding partitions, curtains, and standardized prefabricated closet units. Flexible planning means that the interior arrangement of living space can be changed at will or rooms made to merge to increase

their utility. The importance of the idea lies in the possibility of altering a fixed area to meet the changing needs of families or of different owners. Carried a step further, even exterior curtain walls might be so made that the barrier between the outdoors and indoors would no longer exist.

War has accelerated technical developments. If we do not want to lose the momentum and if we desire to achieve the potential improvements that may materialize as a result of these developments, we must adopt a realistic approach. If the progress inherent in these technical developments is to be realized, architects, builders, financiers, building officials, material producers, and labor must plan for their utilization. Obstacles known to retard building progress must be removed; building requirements must be placed on a flexible basis, that of performance; and the producers of housing must fulfill their obligation to society by building a better and a lower-cost house.

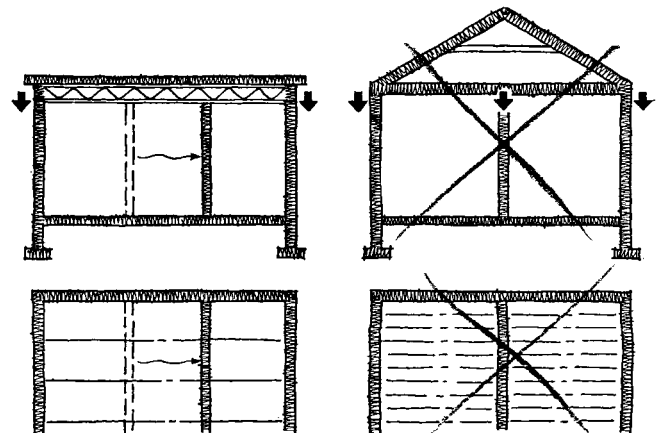

LONG SPAN ROOF CONSTRUCTION. BEARING WALLS OUTSIDE ONLY. INTERIOR PARTITIONS MOVED AT WILL. FLEXIBILITY.

SHORT SPAN CEILING BEAMS. BEARING PARTITIONS CANNOT BE MOVED. NO FLEXIBILITY.

"Long-span construction . . . promise of flexible planning"

A LIST OF PREFABRICATORS

IN the formative period of the industrialization of house production methods no clear-cut classifications can be drawn, nor can any concise definition of "prefabricators" be given. The list below includes the names of firms and associations which are identified with prefabrication in various capacities, from basic research to the production of partially or wholly prefabricated dwellings. Proprietors of patented panels or construction systems are included as well as manufacturers and contractors who have been producing government or industrial housing on a quantity or mass-production basis. The list includes both large and

small operators, some national in scope, others definitely local, some active for years, others new in the field. Naturally, the list is subject to change as new companies enter the field, or, having fulfilled their purpose, are merged with others or are discontinued. This list does indicate, however, the large variety of firms which are producing, experimenting, and contributing to the development of the prefabrication industry. Additional information on this list, or corrections, will be welcomed for inclusion in a supplementary list to be published in a future issue.

A

Adirondack Co., 142 E. 45th St., New York, N. Y. Fabricators of houses and farm buildings. Exclusive distributors for Ivon R. Ford Lumber Co. Licenses plants to use their system. Units of wood frame and plywood or composition board. Established 1932. Rate of production 250 houses a month.



Aladdin Co., The, Bay City, Mich. Producer of wood frame houses of conventional design. Present work is largely buildings for the armed forces. Units are shipped to Alaska, Southwest Pacific, Iceland and Africa. The mobile "Pullman" house developed in 1937. Firm established in 1906. 100,000 houses built prior to 1942. Present rate of production 1,000 houses a month. Plants located in Michigan, Oregon, Georgia and Illinois.

Allied Housing Associates, Langhorne, Pa. Fabricators of houses, dormitories, shelters, aviation spotting towers and the like. Wood frame units covered with Homasote. Conventional exterior materials may be applied if desired. Firm established 1936. 450 dwelling units built for private use prior to 1942. Present rate of production 200 houses a month. Anticipated rate 600 houses a month. Factories in Bristol, Pa., Norfolk, Va., Baltimore, Md. Serve the Eastern Seaboard.

American Builders, Inc., 611 Alaska St., Seattle, Wash.

American Coal & Supply Co., Fort Wayne, Ind. Shop fabricated wood frame and plywood units for walls, floors, partitions, ceilings, and roofs. Finished flooring and roofing are field applied.

American Houses, Inc., 570 Lexington Ave., New York, N. Y. Fabricators of houses for public and private projects in all parts of the country. Licenses other organizations to use its designs. Con-



Rodney McKay Morgan

ducts research laboratory to study technical problems of construction and engineering. Houses produced are of all styles, but those for real estate projects are largely traditional Colonial. Modular units made for walls, floors, and roofs of wood frame and plywood. Conventional exterior finishes are generally applied to the houses at the site. Company established in 1932. Present rate of production 2,000 houses a month. Anticipated rate 2,500-4,000 houses a month. Eleven factories in 9 states are capable of serving the entire U.S.A. The company employs 10 or 12 architects. (See also pages 62-3, 64-5.)

American Rolling Mills Co., Middletown, Ohio. Because of the war the company has discontinued, for the present, the fabrication of houses. Before the war they made steel units for floor, wall and roof construction. They may at a later date again enter the field as subcontractor for formed metal parts.

Andersen Corp., Bayport, Minn. Primarily manufacturers of windows, which they have mass-produced for many years, the company has utilized its extensive factory facilities to supply house units of various other sorts.

Anderson Nichols Co., Topeka, Kan. Originators of "Gold Seal Homes," which were offered for sale in two different designs, the company has recently discontinued operations in Topeka.

Armor Products, 21 West St., New York, N. Y. Sales agents for the export trade Stran-Steel, Homasote and other similar companies. The company maintains an engineering staff of designers. They fabricate wood houses for domestic as well as foreign fields.

B

Bailey, Edward J. & Co., Duncan St., Philadelphia, Pa. Fabricators of warehouses, steel filling stations, and the like.

Bank Building & Equipment Corp. of America, 7513 S. Broadway, St. Louis, Mo. Fabricators of units for houses, usually with composition board exteriors. The firm has been identified chiefly with work on housing projects.

Barlow & Williams, Indianapolis, Ind. Shop fabrication of wood framed units for floors, walls, partitions, ceilings, and roofs. Conventional exterior finishes are applied to the houses at the site.

Barrett & Hilp, San Francisco, Cal. General contractors who build industrial and private projects of all kinds. They have erected large groups of prefabricated houses, notable among which are the project of 922 units at Vallejo, Cal., and homes for 5,000 shipyard workers at Norfolk, Va. Some of their houses have been Homasote "Precision-Built" homes of composition panels nailed and glued to a wood frame. The company entered the field of prefabrication in 1941. They can erect approximately 56 houses a day. They operate on a nation-wide scale.

Bates Prefabricated Structures, Tribune Tower, Oakland, Cal. Fabricators of wood frame and plywood units for houses, most of which are demountable. 1,400 houses have been contracted for to date. Present rate of production is 50 houses a day. Two plants are now operating in California, and a third will soon be in operation.

Beck, Henry C., Co., 406 Construction Bldg., Dallas, Texas. Site fabrication of demountable houses of wood construction in the \$3,000 price range. The firm has built 5,000 houses to date. Field of operation is the Southern states.

Beers Steel Building Corp., 116 Nassau St., New York, N. Y. Fabricators of steel parts for factories and warehouses. The company keeps a stock of designs and materials that are likely to be applicable to future work, but they do not stock the whole building.

Bell Lumber Co., Green Bay, Wis.

Bemis Foundation, M.I.T., Cambridge, Mass. A non-profit organization established in 1921 for the purpose of conducting research and experimentation in the field of housing. It has studied and analyzed many structural materials and methods, built houses of steel, gypsum slabs and various composition boards. Its studies have hastened the acceptance of the modular system of design and the standardization of building construction.

Bennett Lumber Corp., N. Tonawanda, N. Y. Dealers in lumber, ready-cut to house sizes and fabricators of sectional houses of wood frame and sheet material construction. The company has built 250 units for Wright Field at Dayton, Ohio.

Established in 1923, it can produce 100 units a month.

Bent Steel, Inc., 43-24 37th St., Long Island City, N. Y. The company has built several experimental houses in steel for real estate companies. Exteriors of the houses are flush steel panels painted with stippled finish to resemble stucco. Priorities have forced them to discontinue work in this line until after the war, when they hope to resume operations.

Berger Manufacturing Co., Canton, Ohio. A subsidiary of Republic Steel Corporation, this company manufactures steel framing for prefabricated houses. Their steel floor joists are pierced with holes to allow for passage of pipes, conduits or hot air panel heat.

Bethlehem Steel Co., Bethlehem, Pa. Manufacturers of special lightweight steel sections for houses which are welded together at the site to form a skeleton frame, to be covered and finished with conventional materials.

Better Built Houses, 821 Eckles Building, Ogden, Utah.

Blaw Knox Co., Blaw Knox, Pa.

Braden Steel Corp., 3 N. Madison St., Tulsa, Okla.

Brooks-Skinner Co., Quincy, Mass.

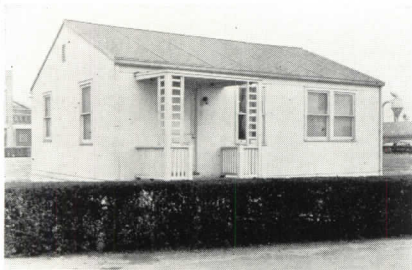

Bruce, E. L., Co., Memphis, Tenn. Primarily dealers in lumber and flooring, this company now fabricates, under patents of Carpenter Houses, Inc., of Baltimore, Md., units for demountable houses. Their business in this line is all in connection with the war effort. Besides prefabricated units, all necessary parts of the houses, including vitreous-lined steel chimney flues, are shipped to the site. Erection of the houses takes 6 hours, excluding time spent in trimming and painting them and connecting them to the public utilities. The company is now equipped to build 200 houses a month, anticipates raising the number to 500.

Burmester Housing Corp., Middleton, Wisconsin. Fabricators of wood houses covered with plywood, Homasote, or other sheet materials. The company erects and sells the houses to the consumer, or it markets them through lumber dealers and sales organizations. It offers houses of 12 different designs. Wiring and piping is installed in fabricated units. The company was established in 1938.

Bush Prefabricated Structures, Inc., 370 Lexington Ave., New York, N. Y. Producer of both factory-fabricated and site-fabricated houses, all demountable, most of the houses are wood covered with siding or plywood with interiors of Upson board. A specialty is a building 20 ft. wide which can be obtained for war uses, in any length desired. Established in 1933, the company has built about 600 units to date, has at least 500 on contract. Plants are located in Brooklyn, N. Y., and Groton, Conn.

Butler Manufacturing Co., 13th St. & Eastern Ave., Kansas City, Mo. The present production of this concern is entirely factory-fabricated military barracks.

C

Carleton Lumber Co., 2000 North Interstate, Portland, Ore.

Carl's, Charles W., Sons, Gole St., Trenton, N. J.



Celotex Corp., 120 S. LaSalle St., Chicago, Ill. Originators, with the John B. Pierce Foundation, of the Celotex "Cemento" house built of post and girder construction in which one thickness of wall material constitutes both exterior and interior finish. The houses were designed for the employees of the Glenn L. Martin plant in Baltimore. 35 man-hours of labor erect foundations, walls and roof. Parts of 1,500 houses are being built each month. Plants in Metuchen, N. J., and Marrero, La., produce the cemento board. Precutting is done in outside mills.

Chesbro-Whitman Co., Inc., 38-21 12th St., Long Island City, N. Y.

Cincinnati Mfg. Co., Evans St., Cincinnati, Ohio.

City Lumber Co., 75 Third St., Bridgeport, Conn.

Crawford, Inc., New Orleans, La. Factory fabrication of wood frame house units. Floor and roof units are sheathed with plywood, wall units with siding on the outside, gypsum boards on the inside.

Curtis Co., Clinton, Iowa. The company has for many years prefabricated, on an extensive scale, windows, doors, stairs, and many other parts of houses and house equipment.

D

Dean, Allison H., Co., 208 Southwest Broadway, Portland, Ore. Fabricators of "Haul-A-Way" homes which are mass-produced on an assembly line, sold completely finished and furnished, equipped with sink, stove, and refrigerator.

Decatur Iron & Steel Co., Decatur, Ala.

Des Moines Steel Tank Co., Des Moines, Iowa.

Dixie Culvert & Metal Co., Atlanta, Ga.

Douglas Fir Plywood Association, Tacoma, Wash. The association has conducted studies to show the possibilities of plywood as a construction material, particularly for "Dri-Bilt" prefabricated houses. The results of their research on the material itself and on the ways of using it are available to the public.

Dulaney-Fuller-Wilson, New Albany, Ind.

E

Economy Portable Housing Co., West Chicago, Ill. Factory fabrication of wood frame and plywood panels in full wall lengths and full story heights.

Edwards Mfg. Co., 403-13 Culvert St., Cincinnati, Ohio.

F

Field Lumber & Improvement Co., 651 W. Baltimore St., Detroit, Mich. Manufacturers of prefabricated structures for government war housing. Their designs allow the houses to be taken down and re-erected with 85 per cent salvage.

Freeman, O. I., Atlanta, Ga.

Forbert Corp., McGeheysville, Va. Factory fabrication of houses, some of which are built under J. B. Pierce Foundation patents. Many of the houses have exteriors of Cemento board. The firm is now supplying dormitories and bar-

racks and houses for aircraft and shipyard workers. Truck transportation is practical within a radius of 300 miles from the plant; rail transportation within 1,500 miles of the plant is economical.



Ford, Ivon R., Lumber Co., McDonough, N. Y. Established in 1935, the company now prefabricates houses on its own account and also offers to others on a royalty basis, use of the patents and system on which its "Factory Built Homes" are based. 555 houses were sold prior to 1942. Its plant can produce 60 units a month.

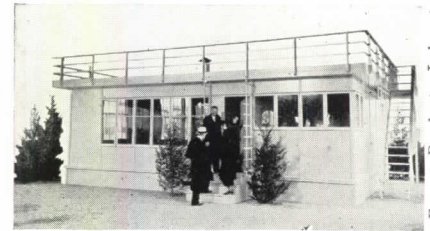

Forest Products Laboratory

Forest Products Laboratory, U. S. Dept. of Agriculture, Madison, Wisconsin. Through this agency the government has conducted studies of new construction methods. As early as 1935 the laboratory was experimenting with stress-skin plywood panels. The houses they have built have served as models for thousands which are going up today. (See also page 66.)

G

Gate City Sash and Door Co., Ft. Lauderdale, Florida.

G B H-Way Homes, Inc., Walnut, Ill. The firm might be called "regional fabricators" since they have distributed houses within an area 200 miles from their plant. Rate of production on two types of houses has been 50 units a month. On Feb. 1, 1943, they discontinued all prefabrication of residential construction and converted their facilities to production of other war materials, including a few types of essential farm buildings.

Geiger Engineering Mfg. Co., Inc., Union, N. J.

General Fabricators, Inc., 1710 Eye St., N.W., Wash., D. C. Factory fabrication of wood frame with Masonite Tempered Presdwood exteriors. Approximately 6,000 houses have been built to date. Rate of production is 900 houses a month.

General Houses, Inc., North Pine Grove, Chicago, Ill. Began production, in 1932, of a steel frame house covered on the outside with sheet steel frames, and on the inside either with the same material or with cement composition boards.

General Panel Corp., 420 Lexington Ave., New York, N. Y. Makers of the "Packaged Building" which is fully demountable, and uses the same module for vertical and horizontal members. The system was developed by Konrad Wachsmann of New York and Professor Walter Gropius of the Harvard Architectural School.

Georgia Housing & Supply Co., Macon, Ga. Factory fabrication of wood frame panel units covered with wood boarding or fiber board. Conventional exterior finishes are applied to the houses at the site.

G. F. Manufacturing Co., Exira, Ohio.

Golden, M. H., San Diego, Cal. Builders of precast, reinforced, channel shaped, concrete wall units 2 ft. wide and one story high. The units are assembled with bond beams, and studs are made with a cement gun.

Gordon-Van Tine Co., Davenport, Iowa. Engaged in prefabrication of houses from their own plans or from plans submitted by others.

Gorman Lumber Sales Co., 1621 Tidelwater Ave., Oakland, Cal.

Grand Rapids Mobile House Corp., Grand Rapids, Mich.

Green Lumber Co., Laurel, Miss. Prefabrication of wood houses, most of which are for Army barracks and war housing projects. The firm was established in 1941, has produced 4,000 units to date. Plant capacity is 550 houses a month.



Green's Ready-Built Homes, 1221 18th Ave., Rockford, Ill. Assembly line fabrication of wood frame and plywood panels, made in long lengths, and covered on the outside with beveled siding. Firm was established in 1941 and has built public war housing projects. Its plant can produce 150 houses a month.



Gunnison Housing Corp., New Albany, Ind. Factory fabrication of houses on an assembly line. Wood frame and plywood panels with both exterior and interior finish are made in the plant, joined together at the site. The company was organized in 1935. Produces 600 houses a month. Dealers throughout the nation sell houses in every state. (See also pages 66-7.)

Gunnison Magic Homes, Inc., Louisville, Ky.

H

Harnischfeger Corp., 6785 Greenfield Ave., Milwaukee, Wisconsin. Factory fabrication of wall, floor and roof units consisting of steel studs covered with insulating board or plywood. Panels a story high and 3-4 ft. wide are joined in the field by means of special steel connectors. Company established in 1935. Plant capacity 300 houses a month.

Harry Steel Co., 2337 Papin St., St. Louis, Mo.

Hauserman, E. F., Co., Cleveland, Ohio. Steel panel construction.

Hayward Lumber & Investment Co., 4085 Sheila St., Los Angeles, Cal.

Hobart Welded Steel House Co., 1220 Hobart Rd., Troy, Ohio. Producers, before priorities on steel, of mobile all-steel houses which could be put on a truck and

driven to the site. The houses were of Cape Cod and Georgian design and sold for \$4,500 exclusive of foundations and connections to utilities.

Hodgson, E. F., Co., 1108 Commonwealth Ave., Boston, Mass. Established in 1892, the company has made sectional houses of all sizes in a great variety of designs over a long period of years. It contributed houses to World War I and is now producing again for the Army and Navy. Most of its houses are of Colonial design with western red cedar exteriors. Prior to 1942 it has built more than 100,000 houses. Its plant at Dover, Mass., is capable of fabricating 50 houses a day.

Hollow Concrete Wall Mould Co., Troy, Wisconsin.

Holt-Fairchild, 7 Court St., Arlington, Mass.

Holzer Sheet Metal Works, Inc., 317-31 Burgundy St., New Orleans, La.



Homasote Co., Trenton, N. J. Manufacturers of Homasote fiber board and developers of Homasote "Precision-Built" construction. In 1935 the company began research into various types of construction and problems connected with housing. Methods and materials that it has developed were used in the large housing groups at Vallejo, Cal., and Portsmouth, Va. The company establishes local prefabricating plants near locations where buildings are to be built. Many of the features of their method of construction are covered by patents so the system is offered to users on a franchise basis. (See also pages 64-5, 66.)

Home Building Corp., Kansas City, Mo. Factory fabrication of wood units for houses and of special metal enclosures for mechanical units.

Homes, Inc., 13th Place and So. Lewis St., Tulsa, Oklahoma. Factory fabrication of wood and plywood house units. The company was established in 1941, is equipped to produce 15 houses a month.

The Horsley Co., 18 East 48th St., New York, N. Y. The company has developed processes for the standardized construction of housing of all sorts, schools and hospitals, churches for military areas, and for rafts, pontoons, oil tanks, and the like. It licenses plants to fabricate according to its systems.



Houston Ready-Cut House Co., 3601 Polk Ave., Houston, Texas. Organized in 1917 to build houses for the oil industry, this concern has fulfilled housing contracts for FWA, FSA, CCC and the Dept. of Agriculture. It had built, prior to 1942, 1,200 houses. Plant capacity is 600 units a month.

Hussman-Ligonier Co., St. Louis, Mo. Factory-fabrication of houses. Some of its executed projects are in Norfolk, Va.,

Louisiana, Mo., Middle River, Baltimore, Md., and Kingsbury-La Porte, Ind. Established in 1921, the company is equipped to produce 350 units a month.

I

Illinois Lumber Mfg. Co., Cairo, Ill. Factory fabrication of houses in the \$3,000 price range, many of which are of yellow pine frame, red cedar shingle exterior covering. 400 houses have been built to date. The company anticipates expansion of service after the war.

Indiana Demountable Housing, Inc., 907 E. Michigan St., Indianapolis, Ind.

Insulated Steel Construction Co., Solon, Ohio. Originators of a system of steel house construction in which floors and walls are made of hollow steel box-shaped pans and exteriors are made of enameled steel sheets.

International Mill & Lumber Co., 1905 South Winona Ave., Bay City, Mich.

International Derrick & Equipment Division of International Stacy Corp., 895 Michigan Ave., Columbus, Ohio.

Iron and Steel Products, Inc., 3501 Carrollton Ave., New Orleans, La.

J

Johns-Manville Corp., 22 East 40th St., New York, N. Y. Manufacturers of numerous sheet materials, for floors, partitions, walls, and roofs which are used as finishes and insulation in prefabricated houses.

Johnson Housing, Inc., 235 South Dock St., Sharon, Pa. Fabrication of wood demountable houses in six different designs. All paint except the final coat is applied to the houses in the factory which is equipped to produce 8 houses a day.

Johnson, John A., Contracting Corp., 270 41st St., Brooklyn, N. Y. A large contracting company which has had contracts for the carpentry work on 12 large projects in the New York area built under the supervision of the U. S. Housing Authority. The company entered the field of housing in 1941, has built approximately 5,000 units to date.

Juul Steel Houses, Sheboygan, Wisconsin. Factory fabrication of demountable houses with pressed steel panel exteriors. Priorities have caused temporary postponement of production.

K

King, T. C., Co., Anniston, Ala. Producer of factory fabricated panels and pre-cut wood framing for the Army, CCC Camps, and housing projects. Established in 1935, the concern had built 10,000 units prior to 1942, has capacity of 500 units a month.

Klinger Dri-Bilt Construction Co., 122 Courtview St., San Antonio, Texas.

Knap-America, Inc., Los Angeles, Cal. Fabricators of precast concrete panels for wall construction which are assembled by means of wood splines.

Kolb Prefabricated Buildings, 250 West 57th St., New York, N. Y. Established for prefabrication in 1910, this company is now engaged entirely in work for the government. They have built houses of wood and plywood construction for the Army, the Navy, the FPHA, and for export.

Kroening Engineering Co., 4500 W. Mitchell St., Milwaukee, Wisconsin.

L

Latisteel Corp. of California, Pasadena, Cal.

Lea, W. F., Los Angeles, Cal. Producers of lightweight galvanized steel sections for houses, which are bolted together at the building site, to form a skeleton frame. Conventional materials are then applied to the frame.

Leird Lumber Co., Little Rock, Ark.

Le Tourneau, R. G., Peoria, Ill.

Lewis Manufacturing Co., Bay City, Mich.

Libbey-Owens-Ford Glass Co., Toledo, Ohio. One of this company's plants, located in Ottawa, Ill., factory fabricates frame and plywood panels. It has a capacity of 20 houses a day.

Long Bell Lumber Sales Corp., Long Building, Kansas City, Mo.

Luhning Lumber Co., Inc., Evansville, Ind.

M

Martins Steel Products Co., Mansfield, Ohio.

Masonite Corp., Chicago, Ill. The company fabricates wood frame panels covered with fiber boards which it manufactures.

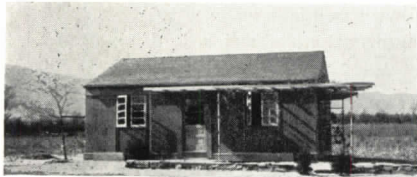

Matern, Graff & Paul, 10 Rockefeller Plaza, New York, N. Y. Prefabrication designers and engineers who plan buildings, license mills and builders to fabricate and erect them.

McCarthy, Robert, 1050 Kirkham St., San Francisco, Cal.

Mengel Co., The, Louisville, Ky.

Minter Homes Corp., Huntington, W. Va.

Modern Builders, Inc., 1107 East Iowa St., Evansville, Ind.

Modern Way Homes Co., Franklin St., Chester, Pa. Fabrication of wall length and story height panels, to which doors and windows, pipes and conduits are applied in the factory.

Modulok, Inc., 700 Cathedral St., Baltimore, Md. Fabricator of 1 and 2-story barracks and houses of wood and Cemesto board.

Moore & Moore Lumber Co., 100 E. Florida Ave., Youngstown, Ohio. Fabricates houses of 12 different designs, which are sold, with the lot on which they stand, for about \$5,000.

N



National Homes Corp., Lafayette, Ind. Assembly line fabrication of wood frame and plywood houses. Before the company turned its resources entirely to government work it offered the public houses of 14 different designs, each with a different name. It has produced 2,872 homes for the workers of the Willow Run Plant of the Ford Motor Co. Established in 1940, the firm has built approximately 3,000 houses to date. Its present capacity is 750 houses a month and it soon hopes to raise this figure to 1,020.

National Housing Co., 2310 Butler St., Dallas, Texas.

National Log Construction Co., Grayling, Mich. Manufacturers of hollow logs cut to house sizes, jointed and fitted. Its plant has been moved to make room for an airfield, but it expects to operate again after the war.

Nelson Cement Stone Co., East Braintree, Mass. Fabricators of foundation walls for houses consisting of pre-cast concrete panels 8 ft. high and of variable width.

New Castle Products, 654 S. 25th St., New Castle, Ind.

Niagara Realty Corp., 105 Court St., Brooklyn, N. Y. Factory fabricated houses in the \$3,000 price range.

Northwest Wood Products Co., Wonewoc, Wisconsin. Fabricators of wood stud and plywood panels which are assembled by means of wood splines.

Norwood Sash & Door Mfg. Co., Norwood, Cincinnati, Ohio. Factory fabrication of houses with plywood exteriors and interiors. Rate of production 10 houses a day.

O

Oregon-Washington Plywood Co., Olympia, Wash.

P

P.H.C. Housing Corp., 300 Fourth Ave., New York, N. Y. Manufacturer of standardized assemblies which are suitable for use in houses of any size or shape. Proposed capacity 500 houses a month.

Pacific Coast Aggregates, Inc., San Francisco, Cal. Manufacturers of concrete slab wall panels to be used with concrete studs and concrete corner posts.

Pacific Huts, Inc., Seattle, Wash. Builders of hutments of glued laminated arch construction for the Army.

Pacific Systems Homes, Inc., 5800 South Boyle Ave., Los Angeles, Cal. The company started to make ready-cut houses in 1908, now produces prefabricated units at the rate of 300 a month.

Page & Hill Co., Minneapolis, Minn. Dealers in pre-cut and pre-fitted lumber for log construction.

Palace Travel Coach Corp., Hemphill Road, Flint, Mich. The company produces by assembly line methods expandable-type houses which are in use in more than 100 localities throughout the country. The company has extensive plans for the future when restrictions on private building are removed.

Palisade Structures, Inc., 420 Lexington Ave., New York, N. Y.



Pease Woodwork Co., Inc., Blue Rock & Turrill St., Cincinnati, Ohio. The company fabricates panels for walls, ceilings and floors and pre-cuts all other material needed for their houses. 500 "Peaseway" houses were built prior to 1942. Present rate of production is 250 houses a month.

Pemberton Mill and Lumber Co., Pemberton, N. J. Fabricators of demountable houses, barracks, hutments, dormitories, and other buildings of war necessity, most of which are located in the Eastern States.

Pierce, John B., Foundation, 40 West 40th St., New York, N. Y. The Foundation is a research organization which studies, experiments with, and develops methods of construction. It is particularly interested in prefabrication of houses and is responsible for many contributions to the design, the engineering and the construction of them. Large groups of houses are

built by contracting firms in cooperation with the Pierce Foundation. Notable among these is the development built for the Glenn Martin plant near Baltimore. The foundation has cooperated in the development of a completely prefabricated plywood house and also a house with single-wall of "Cemesto" board construction.

Plywood Products Co., Overland, Kansas. Fabricator of pre-built wall units of plywood glued to a wood frame. The sections are canvas covered on the interior.



Plywood Structures, 6307 Wilshire Blvd., Los Angeles, Cal. The company, established in 1939, licenses prefabricators to manufacture panels and to use a connecting device which they have perfected. Over 6,400 of their units have been built for war housing, many for dormitories at Vallejo, Cal., and for Army barracks.

Portland Cement Association, Chicago, Ill. The association has developed the "tilt up" method of concrete wall construction. Reinforced concrete walls are cast on the ground and then raised into place. At corners, there are cast-in-place columns.

Portland Door Co., 4701 S. E. 24th St., Portland, Ore.

Poston-Springfield Brick Co., Springfield, Ill. Makers of pre-cast, cored, reinforced concrete units 6 in. x 12 in. x 20 ft. in size to be used for wall and floor construction.



Prebilt Co., Revere Beach Parkway, Revere, Mass. Prefabricators of houses of all styles, many of Cape Cod design, stables, kennels, garages, filling stations, greenhouses and the like. 2,000-3,000 houses have been built to date.

Prebilt Housing Corp., Jackson, Miss.



Prefabricated Products Co.

Prefabricated Products Co., Lloyd Bldg., Seattle, Wash. Factory fabricated demountable houses. About 1,000 houses have been built to date.

Purdue Research Foundation, Purdue University, Ind. The foundation, an endowed agency, has been engaged in research into housing methods and practices since 1935. It has built houses of steel, concrete and wood and tested them from the standpoint of cost versus value. Reports and studies on low cost housing have been published.

R

Robertson, H. H., Co., Pittsburgh, Pa. Manufacturer of panels of formed steel units which interlock with one another along their longitudinal edges. The assembly consists of a parallel series of keystone shaped cells with flat steel sheets welded to one side. The span and load of the individual building determines the gauge of the steel.

Rock Island Sash & Door Co., Rock Island, Ill.

S

St. Elmo Housing Co., St. Elmo, Ill.

St. John's Portable Building Co., St. Johns, Mich.

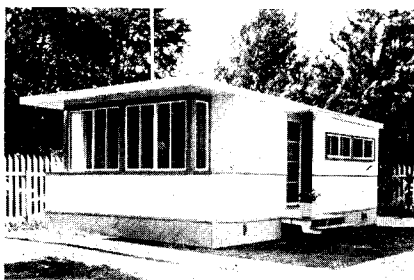

Schult Trailers, Inc., 1730 S. Main Street, Elkhart, Indiana.

Schunack, C. E., Inc., Meriden, Conn.

Scott Lumber Co., Wheeling, W. Va. Wood frame and plywood panels, shop fabricated, to be covered at the site with conventional materials.

Sears Roebuck & Co., Chicago, Ill. Over a period of 30 years at least 100,000 pre-cut houses have been produced by this company which offers a wide variety of standardized designs. Prefabrication of this company is now being handled by its subsidiary, Norwood Mfg. Co., Norwood, Ohio.

Shurtleff Co., The, Elgin, Ill. Wood frame and plywood panels, factory fabricated.

Skyline Lumber Co., Roanoke, Va. Factory fabricated wood frame and plywood units.

Soule Steel Co., 1750 Army St., San Francisco, Cal. Fabricator of units for houses of steel frame and sheet steel covering.

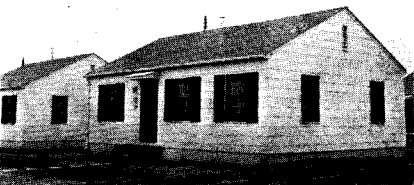

Southern Mill and Mfg. Co., 525 Troost Ave., Tulsa, Oklahoma. Established in 1919, the firm produces "Sturdy-built" sectional houses. The first buildings it built were for the oil industry. It has now expanded operations to include all kinds of housing. Factories are located in Oklahoma, Texas and Kansas. 4,500

units were built prior to 1942. Present rate of production is 450 houses a month.

Southwest Mfg. Co., West Madison St., Phoenix, Ariz.

Speedwall Co., 5035 First Ave., South, Seattle, Wash. The company is a subsidiary of I. F. Laucks, Inc., manufacturers of glue, a commodity closely allied to the production of plywood. It has built a 10,000-unit housing project for Kaiser Shipyard workers at Vanport, Ore. Present rate of production is 150 houses a month.

Standard Houses Corp., Chicago, Ill. Shop fabricated wood frame and plywood panels.

Standard Houses, Inc., 5th St. Viaduct and Valley Rd., Richmond, Va.

Star Mfg. Co., Oklahoma City, Oklahoma.

Steel Buildings, Inc., Middletown, Ohio. Producer of houses of interlocking steel pan construction known as "Steel Ox."

Stefco Steel Co., Michigan City, Ind.

Steger Furniture Mfg. Co., Steger, Ill. Producers of houses of stressed plywood panels made demountable by means of a special locking joint.

Stewart & Bennett, National City, Cal. Manufacturers of houses of stressed-surface plywood who have built for three large housing projects in California. The "Port-O-Barracks" for Army use, can be set up by two men in 45 minutes.

Stran-Steel Division of Great Lakes Steel Corp., 607 Shelby St., Detroit, Mich. Producers of light steel sections for houses made up of channels set back to back.

Structiform Engineering Co., 234 S. Wabash Ave., Chicago, Ill.

Structures, Inc., 646 N. Michigan Ave., Chicago, Ill.

T

Takapart Products, 28 Brooklyn Ave., Freeport, N. Y.

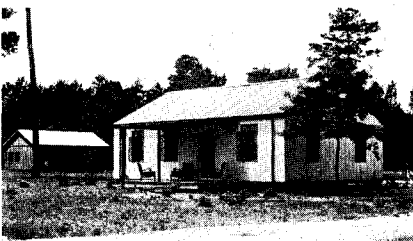

Tennessee Coal, Iron & Railroad Co., Brown Marx Building, Birmingham, Ala. A subsidiary of U. S. Steel Corp., this company has developed "U.S.S. Panelbilt" prefabricated houses of steel frame and galvanized box-ribbed sheet steel exterior walls, which are delivered with an oven-baked primer coat of paint. The steel frames are welded except for field connections which are made with bolts.



Texas Prefabricated House and Tent Co., Dallas, Texas. Manufacturers of fully prefabricated, demountable, portable "Victory Huts," "Victory" houses and adapter units. Most of the structures are square in plan, have flaps to close window openings. Being far superior to tents and capable of being ventilated for use in the South, insulated for use in the

North, they are extensively used by the armed forces in all parts of the world. The firm, established in 1940, builds 500 houses a day (175,000 annually).

Thayer Portable House Co., Keene, N. H.

Timbolok, Inc., Hawthorne, N. J. Makers of pre-cut wood wall construction consisting of tongued and grooved timbers.

Tournapull Housing Corp., Tournapull, Ga. A subsidiary of Le Tourneau Co. of Georgia, producer of prefabricated houses of steel.

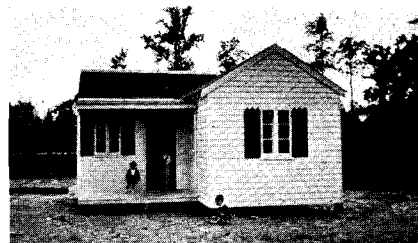

Travelodge Corp., 1120 Madison St., Lynchburg, Va. Producers of prefabricated wood panels. Established in 1940 the firm has built 1,300 houses, has a capacity of 840 houses a month. 14 factories are now producing barracks for the armed forces.

Turnwater Lumber Mill Co., Olympia, Wash.

U

Underwood, D. T., Construction Co., Birmingham, Ala.

United Metal Products, Diebold Safe & Lock Co., 818 Mulberry Rd., Canton, Ohio.

U. S. Plywood Corp., 616 West 46th St., New York, N. Y. Makers of plywoods of all sorts, many of which are used in prefabricated houses.

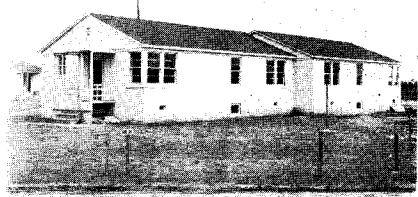

Upson Co., Lockport, N. Y. Makers of "Strong-Bilt" panels which are used as interior finish for prefabricated houses. The panels, being large enough to cover the average-sized room, eliminate all visible joints. (See also pages 68-9.)

V

Van Gordon, C. S., & Son, Eau Claire, Wisconsin. Factory fabrication of wood frame houses, many of which are covered with cement and asbestos shingles.

Vokes, H. L., Co., Chester Ave., Cleveland, Ohio.

W

Watkins, Inc., Wichita, Kansas.

Weber, Kem, 6707 Millner Road, Los Angeles, Cal. Industrial designers of a system of prefabrication for houses.

Wilkinson Co., Inc., 907 E. Michigan St., Indianapolis, Ind.

Workmen's Housing Corp., Cleveland, Ohio. The company makes units of frame and plywood, and also specializes in a siding made of plywood in exceptionally wide strips.

Y

Young, E. C., Co., Randolph, Mass.

FPHA TO USE PLASTIC TUBING

. . . Saran tubing accepted for hot and cold water lines

SINCE Pearl Harbor dozens of ingenious technical developments have been suggested to speed the war and save vital materials, but it has been a case of "many are named but few are chosen."

It is real news, therefore, that one of the more revolutionary ideas—plastic piping—has been officially chosen, and will soon be put to work. After exhaustive tests extending over several months, the Federal Public Housing Authority has accepted plastic for water lines in publicly financed war housing, with the full blessing of the War Production Board.

To be more specific, it is plastic tubing, not piping, that is to be used in public housing now, though the material has passed its tests for rigid piping in larger sizes.

Still more specifically, it is one particular material of the huge plastic family that has been accepted. That is what bears the trade name of "Saran." It is technically known as vinylidene chloride, and is a basic material produced by the Dow Chemical Company. For the tubing the material will be extruded by several firms, of which the FPHA instruction sheets list fifteen. The finished tubing will thus be available through regular distribution channels in virtually all parts of the country, though the FPHA recommends its use principally in areas of difficult water conditions.

As for this latter point, the FPHA instructions carry this note: "Saran tubings and fittings have been classified by OPA and a ceiling price established. This price will compare with copper tubing and fittings; therefore, it is desirable that its use be confined to those sections of the country where the use of copper tubing would be desirable from the point of water characteristics. A list of various cities has been made part of this Bulletin, together with a map showing average water hardness and pH, in order that its selection may be more easily determined." The map shows those areas to be confined primarily to

the eastern seaboard, some of the southern states, and the two extreme northwest states of Oregon and Washington. Also certain areas are named in Indiana, Ohio, Kentucky, Wisconsin, Tennessee and Texas.

The FPHA program is really a preliminary one, since present manufacturing facilities are limited and future needs for the material are not ascertainable. The arrangements call for the manufacture of some 600,000 feet of tubing and 200,000 fittings per

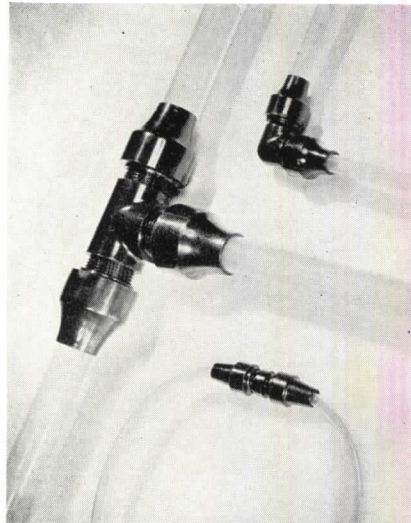

Fittings and tubing are of same material

month, and the use of them in public housing is established at 5,000 dwelling units per month for three months, or a total of 15,000 units for a preliminary program. The use of this material for such a number of units is calculated to save approximately 500 tons of galvanized steel pipe.

The tubing is to be used for both hot and cold water lines. Exceptions are made for connections between waterbacks and range boilers, between direct fired coal water heaters and storage tanks, and overflow lines from relief valves, for which standard weight galvanized iron pipe is called for. The FPHA instructions note that the tubing is considered safe within a

range of 200° F. and 100 lb. per sq. in. working pressure.

Saran tubing is a semi-translucent material; it comes in three sizes— $\frac{3}{8}$ ", $\frac{1}{2}$ ", and $\frac{3}{4}$ "—and for these sizes has a nominal wall thickness of .062". It is installed much like copper tubing, with fittings for flare connections, and handles much like copper. The labor involved is about the same, but perhaps some more care will be required. Its installation is to follow *specific instructions* of FPHA:

"Saran' plastic tubing is readily bent to necessary turns and the use of elbows will not be required for offsetting or change of direction. In fact, it is desirable to use the minimum number of connections, where a practical turn of the tubing can be effected without applying too much stress by the use of a sharp bend.

"*Supports:* When piping is exposed and installed in a horizontal position, it should be supported at intervals not exceeding three feet, in order that it may be kept in perfect alignment.

"*Flaring Tool:* The flaring tool must be used in preparing flare on tubing. Tubing can be flared at normal temperatures of 60° to 80° F. When lower temperatures exist, tubing should be warmed prior to flaring. Method of flaring is similar to copper

(continued on page 94)

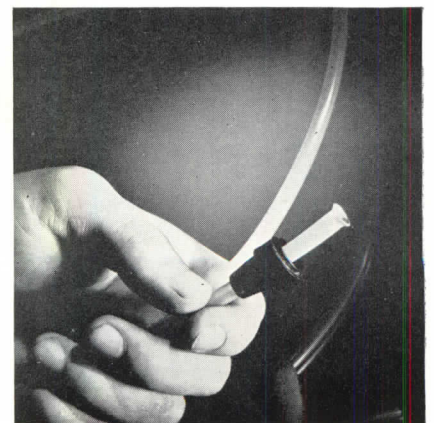

Joint ends are flared, like copper tubing

PAINTS: PRESENT AND POSTWAR

By BURR PRICE*

Current research, done with wartime urgency, is changing paint formulations and bringing new developments which make obsolete many of the architect's favorite specifications for finishes

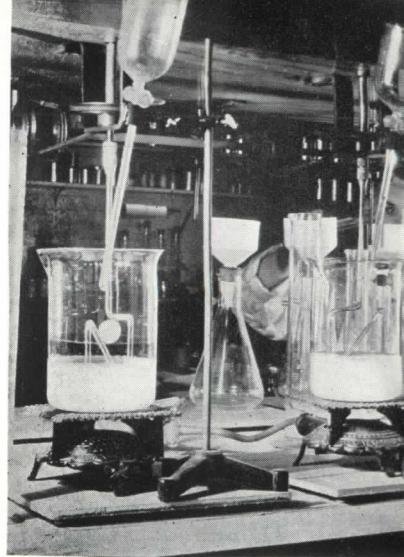

WITH a continuing and increasing need for conservation of critical materials, the manufacture of paints and varnishes at this time is calling for ceaseless laboratory work and production ingenuity, with reformulations and new specifications being the order of the day. Accordingly, it is obvious that an architect's existing paint manual and past practices should be carefully reviewed in the light of what is now transpiring, what may be expected in the immediate future and what the postwar period will bring. This article is a brief presentation of those three phases.

In the fifteen years preceding the outbreak of the war in 1939, the paint industry underwent an almost revolutionary change, in which the chemist and chemical research became dominating factors for the first time. Great progress was made in the development of architectural finishes, maintenance paints and industrial coatings through the perfection of synthetic resins, synthetic oils, new pigments and solvents, new processes. This change had completely revised previous concepts of speed and application, drying time, durability and protective qualities. With the advent of the war, the industry was in the strategic position, fortunately for the country, of being able to respond to the immediate call for protective coatings of existing formulations and to meet new technical requirements, for practically everything that fights, flies or floats needs paint.

At the present writing, seventy-five per cent of the production of the paint industry is being taken for military purposes. Despite this, materials are available for essential civilian use. The drastic curtailment in civilian new construction frees the proportion of paint formerly devoted to that end to be used for necessary maintenance and repair of existing structures.

The quick-drying paints, varnishes and enamels are unavailable for specification on paint work other than for the military services. To supply the essential civilian paint market, the industry is currently undertaking a comprehensive reformulation of outside house paints and several classifications of interior finishes such as flat wall paints, gloss and semi-gloss wall paints, enamels, wall primers, varnishes and colors in oil. This has been made necessary because of a growing shortage of drying oils, first foreseen many months ago and now acute. One by

one, the drying oils have become scarcer; at the outset, the imported oils and now the domestic supplies. At the moment, there is an imperative need for the most economical and conservative use of linseed oil, last standby of the industry—not for reasons of primary scarcity or for direct military considerations, but because linseed oil is in increasing demand for its food values, its importance in the Lend-Lease program.

Changes have already been made in formulations, and still others are certain to come. It is for this reason that all paint specifications should be restudied by the architect and construction engineer. Some of the modifications are slight, others are more extensive. In view of the changes made and to come, it would be well for an architect or engineer to maintain contact with the paint manufacturer whose material he proposes to use, give him data on the type of work to be done and the conditions, and obtain current information on the best available material for such purposes.

Pigment Situation Easier

Pigments for all types of paints are in a relatively easy position. Lead seems to be plentiful, and there are adequate supplies of titanium and American-process zinc pigments. Aluminum, of course, is wholly off the market. Color pigments are obtainable, though they are tight in certain instances, with chromes and reds quite scarce.

Linseed Oil

It is the oil supply, however, which is of most concern. Use of linseed oil for paint and varnish manufacture has been cut down progressively in the last six months, except for military purposes. First the cut was to eighty per cent of a base period in 1940 and 1941, then to seventy per cent, then to fifty per cent and with a prospect, as this is being written, of even further reduction.

To spread the amount of oil allotment over a larger production, manufacturers are substituting bodied linseed oil for some of the raw linseed previously used in ready-mixed linseed oil paints.

Bodied oil is a heat-treated product of greater viscosity and calls for a larger amount of thinner to produce an equal volume of paint. For example, House Paint Specification 8000-E of the Army Engineer Corps calls for a pigment content of 64 per cent and a vehicle con-

* Managing Editor, National Painters Magazine.

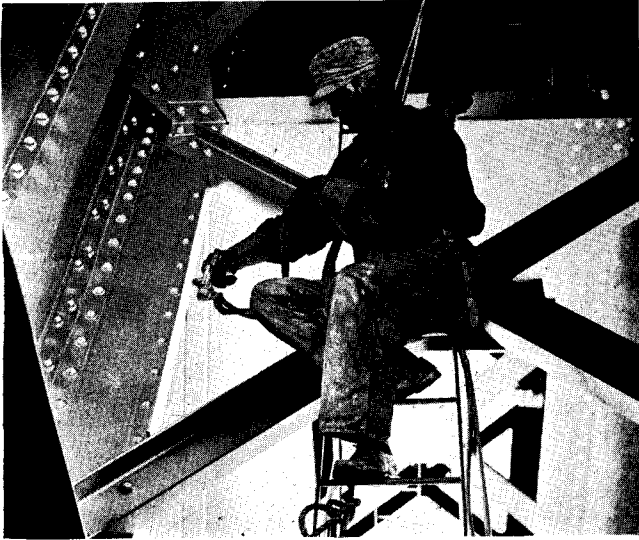

tent of 36 per cent. The vehicle was divided as follows: 83 per cent raw oil, 5 per cent bodied oil and 12 per cent thinner. By changing the vehicle to $33\frac{1}{3}$ per cent of raw oil, $33\frac{1}{3}$ per cent of bodied oil and $33\frac{1}{3}$ per cent of thinner and drier, a saving of 26.3 per cent of oil was effected. Bodied oil may also be used in white lead paints.

Recently, after months of study, government experts and paint industry technicians have arrived at maximum poundages of linseed oil which will be permitted for each gallon of paint. For outside house paints, a formula has been evolved calling for the above $33\frac{1}{3}$ per cent division of raw oil, bodied oil and thinners. Lowered poundages of oil per gallon for the several groupings of interior finishes have also been developed, and it is estimated that the potential savings for both exterior and interior types will amount to at least 80,000,000 pounds of oil a year.

Paints have been made up and tested which carry the amount of oil stipulated for each classification, and there is no question in the minds of government and industry authorities that adequate and proper paints can be made according to the reduced oil formulas.

In recent years, the two-coat paint system appeared on the market. This consisted of a special primer for penetration and adhesion and an outer coat formulated to resist the elements. The special primers were largely based on the use of substantial amounts of bodied oil.

Other Oils

There are other important drying oils of which wide use has been made in the paint and varnish industry. Perhaps the best known is Chinawood, or Tung, oil; also oiticica and castor oils, which are importations, under direct allocation and not available except in a few highly technical coatings. Then there is the oil of that versatile vegetable product, the soy bean, which was rapidly coming into greater use, but its food elements are even greater than its qualities as a semi-drying oil and hence it is now largely out of the picture. Another one, fish oil, is practically unobtainable, because the fishing vessels have been taken over by the navy.

The paint and varnish chemist has been and is still

learning many things on the subject of drying oils, as he struggles with current-day production problems. One of them is that Tung oil is not indispensable for certain purposes. Another is that it is now possible to take an oil molecule apart and use one portion for one purpose and one for another. For example, the linseed oil molecule can be rearranged in such a manner as to reproduce the properties of Tung oil. By such synthetic manipulation, also, the several distinct properties of the soy bean oil can be separated and each put to work at the job for which it is best suited. Through these developing studies of drying oils and their use with synthetic resins, the paint industry will be in a position to produce important new formulations after the war, with speed of drying, smoothness of application and durability of finish.

Water-Mix Paints

In the field of water-mix paints, the current situation is generally far easier. In the last year or so, there has been an industry-wide activity in the marketing of water-thinned resin emulsion finishes which are offered broadly for inexpensive, one-coat, washable coatings for practically every interior surface such as plaster, wallboard, composition board, wallpapers, etc. The properties of these synthetic paints include high hiding, fast brushing with a large-size brush or a roller applicator, quick-drying, and absence of odor. They require no sizing or priming except on very porous walls. They act as sealers of the surface and may be overpainted with oil paints without causing lifting or peeling.

Resin emulsion paints are made according to a variety of formulas, with pigments such as the zinc sulfides and titanium; some contain casein and some use an alpha protein derived from soy beans; some contain oil, others do not. Some are in paste form, others in powder. They are thinned with a half-gallon of water to a gallon of material to make a gallon and a half of paint. The resin is not dissolved by the water. The action is described as being like adding water to milk; you do not dissolve the butter fat, but just dilute the emulsion of insoluble fat in water. The resin is present in microscopic particles, which unite to form a continuous film when the water is removed by the drying out process. After the water evaporates, oxidation of the resin occurs and ultimate hardness, toughness and washability are achieved.

A development of the last four or five years, and used at the New York World's Fair in their early stages of development, resin emulsions have since been the subject of further study and improvement. Their current vogue for use on single small jobs and large housing developments alike, is wide and the consensus is that they have established themselves definitely as paints of tomorrow in the fields for which they are intended.

Cement Base Paints

Another material which is plentiful is the Portland cement base type of water-mix paint, which is designed for use on concrete, stucco and masonry surfaces, and on residential, institutional and industrial jobs. These products have the quality of keying themselves to the surface and forming hard, cement-like finishes of great durability and weather-resistance and may be used for

interior or exterior purposes.

Casein Paints

Casein type water-mix paints for the interior (and some for exteriors when re-inforced) have reached a high state of development, but the adequacy of supply is a matter of concern inasmuch as war transportation difficulties have resulted in placing processed caseins on the allocation list.

One-Coat Oil Paints

Also available today are one-coat oil paints for use on all interior surfaces, such as wood, plaster, wallpaper, concrete, brick and masonry, and also over old calcimine without removing the old coat. They are made of pigments such as titanium and zinc, with specially treated oils, require no sizing or priming and brush on easily to give a uniform finish.

Synthetic Resin Products

Much of the pre-war progress achieved by the paint industry was, as noted previously, due to the development of synthetic resins, such as the phenols, phenol-formaldehydes and alkyds. These were used in formulations of pigments, special oils, solvents and driers by advanced methods which would bewilder a paint and varnish production man of twenty-five years ago, and the resultant combinations gave paints, varnishes and enamels which met the developing demand for speed, drying, and resistance. However, the components of these resins were and are needed in the production of munitions and for other war purposes. They are on strict allocation and their use is confined to coatings for war use only or for extremely high priorities; in some instances, even the armed forces have been obliged to accept coatings in which replacements were used. These paints will, of course, return to the commercial market after the war, with many perfections which have been developed by the raw materials chemist, the paint and varnish chemists and production technicians.

Metallic Paints

Another and early war casualty was aluminum paint in its various forms, dependent on a wide variety of special oil vehicles which likewise were restricted, but here again the postwar picture is as bright as the metal itself, because of continuing research and progress reported.

Still another material which was rapidly coming into its own for industrial and factory use, and which is not now commercially obtainable, is the chlorinated rubber base paint, which is a synthetic product highly resistant to acid and alkalis. Chlorinated rubber paints are for use on the walls and floors of industrial plants. Wax-impregnated paints, too, are a comparatively new development of which there is not an adequate supply because of material restrictions. These are products with high dirt-resistance and water-repellent properties, for use likewise in industrial establishments.

Rust-Resistant Paints

One of the most important questions confronting the architect and engineer is that of reducing the corrosion

of steel and non-ferrous metals in buildings they design. The loss of iron and steel alone runs into staggering figures each year, it having been estimated that in the United States there is an annual loss of 24,000,000 tons due to inadequate protection. Near the seacoast and in the vicinity of manufacturing industries, the need for modern development in protective finishes has become imperative.

The paint chemist in recent years has studied the question of rusting, and has found that the fundamental factors in corrosion resistance in addition to film durability are moisture resistance, chemical resistance and presence of an inhibiting pigment. Moisture resistance in wood protective coatings has long been a desired consideration, and in the matter of metal surfaces it is even more vital, because all metal has a molecular film of moisture which must be overcome. Since no organic coatings are 100 per cent moisture-proof, there is an initial alkaline reaction which can only be met by applying primers of proved chemical resistance. Metal protective primers and paints must also have the chemical resistance properties necessary to all atmospheric conditions, fumes, acids and other corrosive chemicals.

There are several types of metal primers available: Dry red lead mixed in linseed oil; sublimed blue lead; zinc oxide and iron oxide; zinc dust and zinc oxide; zinc dust, zinc oxide and iron oxide; zinc chromate. Studies in zinc chromate's inhibitive qualities have shown remarkable results in performance, and primers of zinc chromate and special synthetic varnishes are now being used on naval vessels. Zinc dust formulations are advocated for use on galvanized surfaces.

One or two coats of the metal primers are followed in modern practice by two or more coats of exterior paint, frequently a chemical-resistant enamel, aluminum bronze powder or other pigments in the same vehicle as the primer. In all of the experimentation with metal primers and paints, the industry's scientists have paid great attention to the importance of the vehicle.

Preparation of the surface before metal painting is a vital consideration, as it is in all painting operations, as failure to have a clean base is a definite cause of subsequent failure.

Fire Retardent Paints

For many years, the paint industry has been experimenting with fire-retardent paints and they have now been perfected to the point of real effectiveness. One type is largely based on chlorinated rubber and other chlorinated compounds and is used in the impregnation of cotton duck employed in the production of army tents. It penetrates the fabric and dries quickly. When exposed to flame, the chlorine compounds in the coating evolve to smother the fire. Another type of fire-retardent paint includes zinc borates, as various types of phosphate compositions are also used. The action of these products is to seal the surface when exposed to heat, the fusion of the products forming a more or less glass-like coating which tends to prevent the flames from igniting the combustible areas beneath. Obviously, these materials are made with ingredients which are not available during the war for commercial production but they will be definitely on the market in the postwar period.

Predictions are being freely made on the tremendous

postwar possibilities of luminous paints, both from a decorative and a practical point of view. They may supplement electric lights in the postwar home, through their ability to absorb enough sunlight during the day to radiate at night from walls and ceilings with sufficient strength to make objects visible in the average room. That may be pure speculation, but it is certain that they can and will be employed to produce a variety of color schemes in a room through manipulation of light.

Fluorescent Paints

Use of fluorescent paint to create startling and mysterious decorative effects in theatres, restaurants, cocktail lounges, etc., became possible with the final development of "black light." This near ultra-violet ray of the black light has very little effect on ordinary surfaces but if directed against surfaces with fluorescent paint the plans and designs so treated will shine with a luminous glow, producing a most dramatic accent when contrasted with semi-darkness.

The patterns reflect in strong colors and decided outlines, yet they give no sensation of glare and are easy on the eye. Thus the luminous decorations give new charm and vitality to otherwise unattractive walls that cannot be too brightly lighted. If these designs are properly done and located in an auditorium, they actually can add to the comfort of the occupants by relieving the eye strain caused by the customary strong light of a motion picture beam in a dark theatre.

Fluorescent coatings are those luminous products which glow only when activated by black light. Phosphorescent coatings glow when activated by short wave visible as well as black light and continue to glow for appreciable periods after the exciting light has been extinguished. Neither paint is more toxic than other regularly used paint.

The usefulness of fluorescent coatings is, of course, limited by the availability and cost of black light units, but they are remarkable potentials, as experiments have shown that when properly formulated they may retain more than fifty percent of their fluorescent brilliance after a year or more of exterior exposure.

The phosphorescent coatings, which also have had certain use in theatres for staging and costume effects, may find definite employment in the future as interior markers for exits, guide lines, obstructions, etc., in public buildings, industrial plants and in homes during periods of power failure or blackout.

Fluorescent Light and Color

Fluorescent light also is a matter which must be considered in the application of painted color, because the color effects under this new form of illumination are as different from incandescent lighting as an incandescent bulb is from natural daylight. It is also a fact that the fluorescent lamp likewise produces a different color effect than daylight, even though it is the closest approximation to outdoor light. In selecting a paint color scheme for an interior lighted with fluorescent lamps, it must be remembered that there are three shades of fluorescent white light to take into consideration, each one of which has a different effect on painted color. These are:

1. "Daylight," a slightly bluish light, closely matching

the color of natural daylight in the shade of a tree on a Spring day.

2. 3,500 degree white, usually referred to as white, which has a tendency to emphasize green and yellow pigments. It is the most widely used of all the white shades.

3. Soft white, a composition of pink and daylight phosphors, which is considerably warmer than the other whites and tends to emphasize the blue and pink pigments at the expense of yellow and green.

With these facts in mind, it is obvious that an established color scheme should be viewed under the shade of fluorescent light which will be used to illuminate it, if unpleasant surprises are not to follow. For instance, in a test, blossom pink showed yellowish under a 3500 degree lamp, a purplish pink under a daylight fluorescent lamp and an intensified normal pink under the soft white fluorescent lamp. In issuing their color cards, manufacturers are now taking into consideration the tested effect of fluorescent light on their color items.

Color and Light as Partners

In a different sense, color and light are coming to play an increasingly important role as partners in the conservation of illuminating costs and the establishment of improved working conditions in industrial plants. This is achieved through the employment of color contrast and light-reflecting paints.

By painting machinery in colors having high light reflecting qualities, the amount of light at the immediate working point is increased. When the bodies are thus painted and the moving parts are painted in contrasting hues, the danger points are spotlighted clearly, with consequent decrease in accidents and speeding up and improvement of production through the ability of the operator to detect flaws and faulty pieces.

In many industrial plants, a well-designed lighting system is robbed of its efficiency by dull, dingy ceilings and walls and floors. Light is blotted up. Now, walls, ceilings and floors alike are being painted in colors that are high in reflection value, so that the entire plant interior becomes a huge lighting unit with the light "bouncing" from one surface to another.

The full development of this partnership between color and light may be expected in the years immediately after the war, with paint engineers and lighting engineers working in close relationship. Likewise, color experts will work with medical and hospital authorities in making widespread use of the proven therapeutic values of different colors on various types of patients.

In accordance with the custom of the day, the paint and varnish industry and its individual units are today closely studying their postwar economic and technical problems. No announcements have been made with regard to new products, but the research work which was responsible for the tremendous progress in the fifteen years before the war, which was accelerated by the unprecedented demands of our vast military effort, is most certainly continuing with an eye to demand of a revived construction industry and of a competitive market in which the nation will expect new and better things for their new and better world. Thus it may be anticipated that the paint industry will come forth with a world of new materials.

STORE FRONT AWNINGS

By W. J. Ward, Jr.

A store-front awning may be mounted in the open, under a hood, or in a recess, and cost of installation increases accordingly.

In general, awning boxes and hoods are of steel construction, the exposed surfaces being covered with any store front metal. They must be rigid or have rigid backing to insure easy operation of the awning. For this reason the drawings show a steel channel or wood beams forming the back.

Arms are of three main types: vertical non-folding, vertically folding (also called "the scissors type"), and laterally folding. The scissors type operates on the pantagraph principle with slight differences among the products of different manufacturers. The one shown is adjustable by means of the sliding pivot which is adjusted, then bolted in place on "A". To drop the awning farther down, bolt "B" is moved to a hole nearer the end of "C". With this type the awning pitch must be sufficiently steep to allow the awning to operate by gravity. Special goosenecks or offset necks may be provided on both of the vertical arm types.

The lateral arm operates like a human elbow, bending at its center, but the joint moves inward toward the center of the awning. The arm is forced open by a spring as shown, making it especially suitable for cases where the awning roller cannot be mounted far enough above sidewalk level to insure correct operation of the scissors type arm.

Note that the hood is adapted for use with any type arm. The partially enclosed recess may be used only with the vertical type arms. The completely enclosed recess is best adapted for use with the lateral type but may be used with the two other types if a vertical pocket is provided for the arms in the window frame or near it. Vertical arms can be provided with strips of store front metal (attached to one section in the case of the scissors type) which completely cover the vertical pocket when the arms are in the closed position.

Operation of the awning roller is usually by means of a worm gear which can be driven by a detachable winding brace, or, from almost any point on the store front, inside or out, by a geared shaft system, hand or motor operated.

Awning fabrics may be of cloth, metal, or plastic. Cloth is relatively inexpensive but its architectural value is not great after three years or so, when its colors have been dulled by sun and dirt and when cigarettes or matches dropped from windows above have burned holes in it. For this rea-

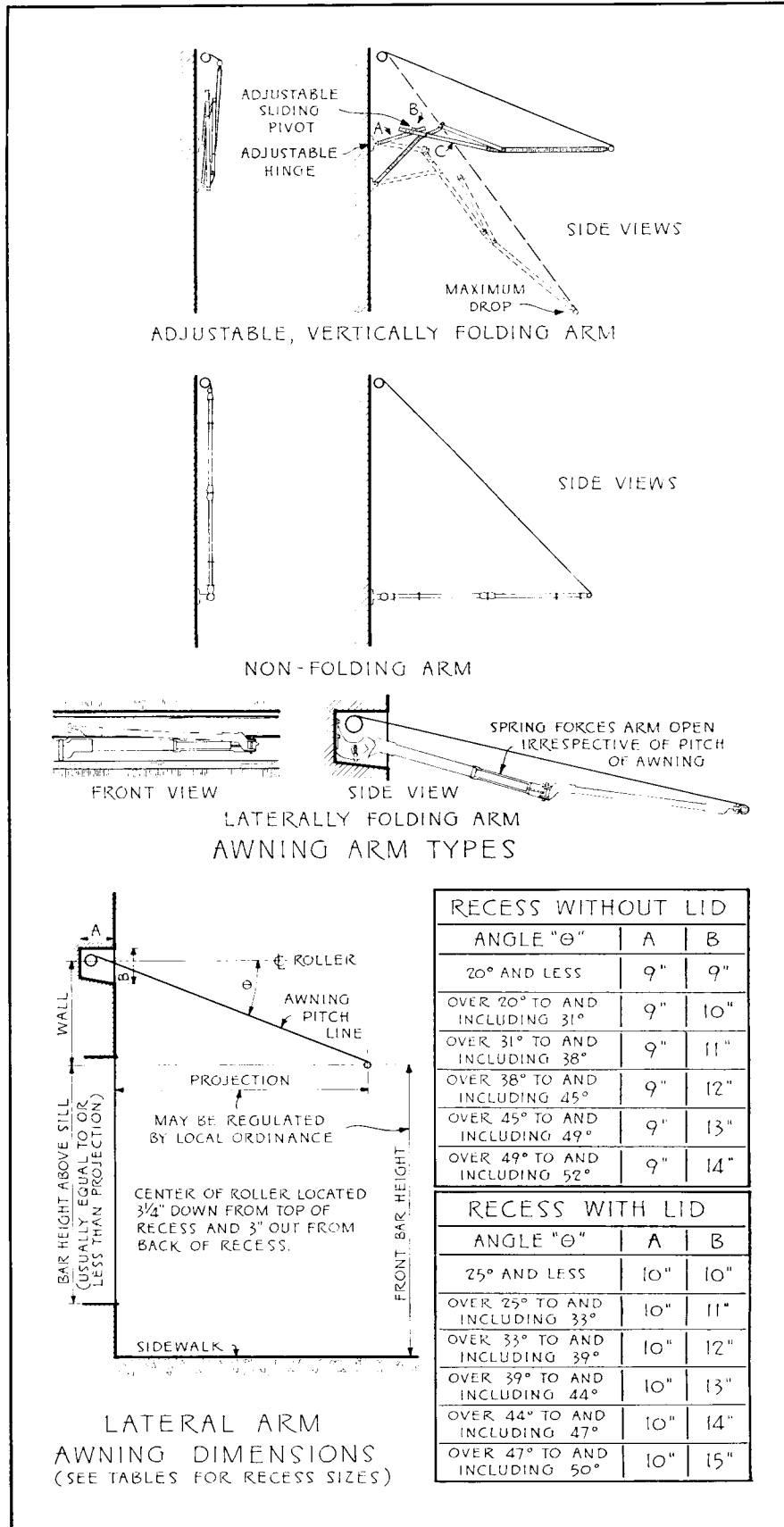

STORE FRONT AWNING HOODS AND BOXES

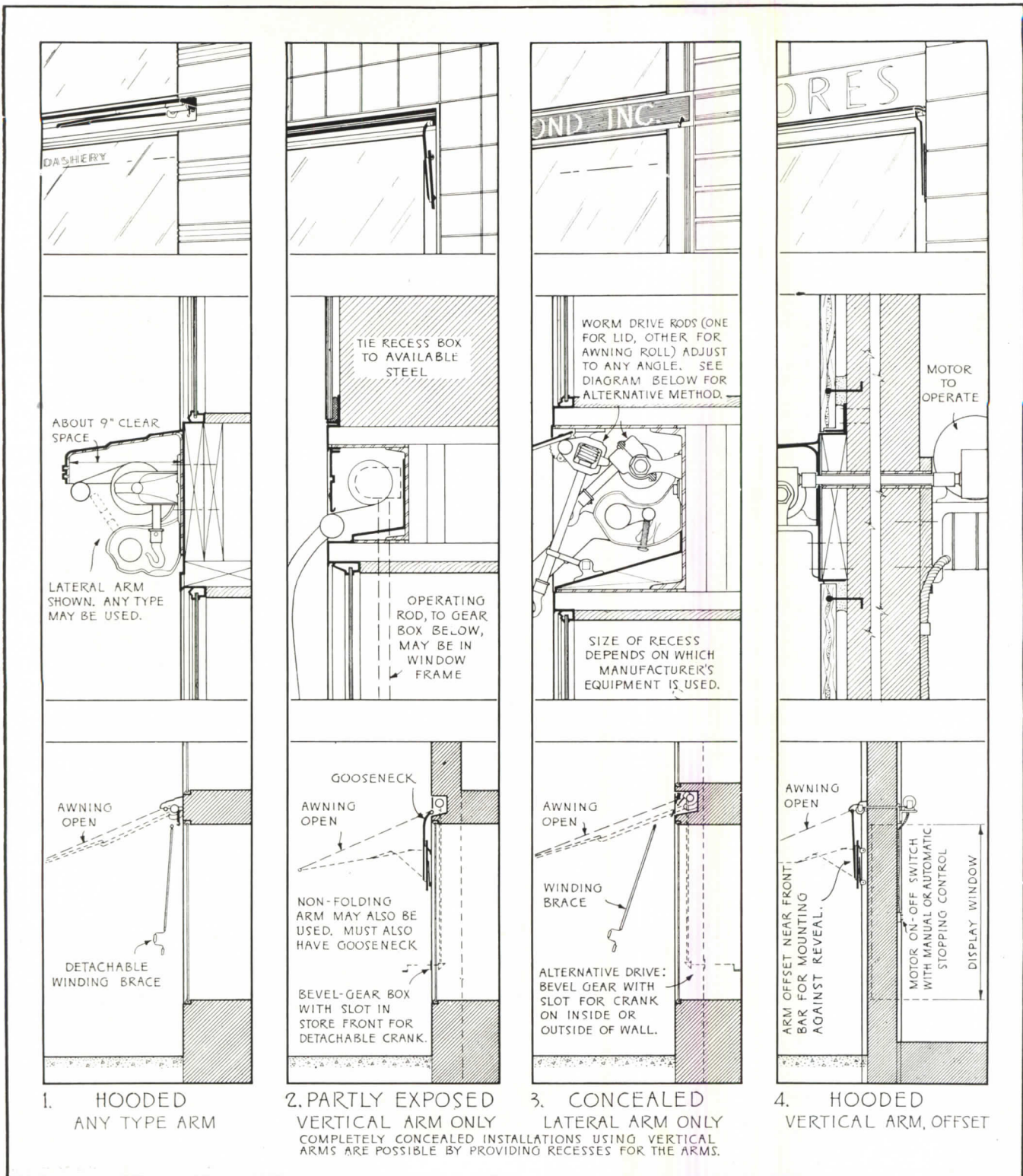

son fabrics made of interlocking, light metal or plastic strips have been introduced and promise better service and greater harmony with modern store front styles.

Note that the lateral arm diagram

and tables apply specifically to the product of one manufacturer; in this case, the Fanner Mfg. Co. of Cleveland, Ohio. Others' products will require slightly different dimensions for "A" and "B" and the note about

locating the awning roller will not apply.

Aid in developing and checking these drawings was given by John M. Hatton and by Morris Ketchum, Jr., architects.

BUILDING FOR SCIENCE

ONE of the most interesting problems of architectural design and construction was the "Searle Circle of Production"—the Laboratories of G. D. Searle & Company.

To create, in modern, streamlined terms, a building dealing not only with conference rooms, executive offices, and personnel conveniences, but with chemotherapy, biological and biochemical products, required a special quality of architectural vision, and construction resourcefulness.

The Searle Company knew exactly what was needed to take care of delicate scientific operations, highly specialized personnel, and extra-normal conditions of procedure, temperature and production, and selected

Herbert Barse of Chicago, Illinois, to bring its standards to visible and architectural reality.

The result was a design which was one of the outstanding conceptions of modern manufacturing and scientific efficiency.

The Fuller Company brought to the job 61 years of diversified construction experience, together with a large, flexible organization of seasoned experts.

As Fuller construction has served commerce, finance, education, science and war, so Fuller, with its vast experience, will, in the post-war era of reconversion, reconstruction and expansion, serve in the future progress of America.

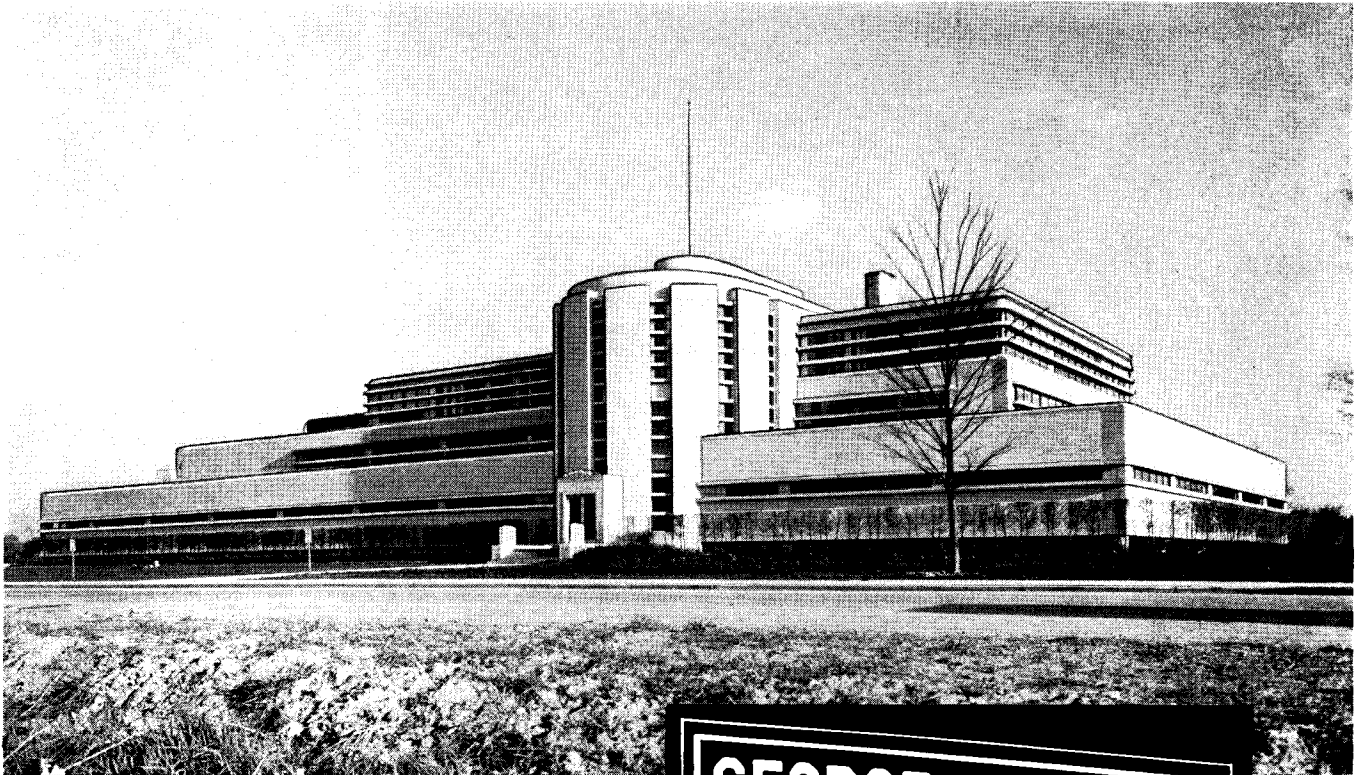

GEORGE A. FULLER COMPANY

*New York • Washington • Chicago
Boston • Philadelphia • Los Angeles*

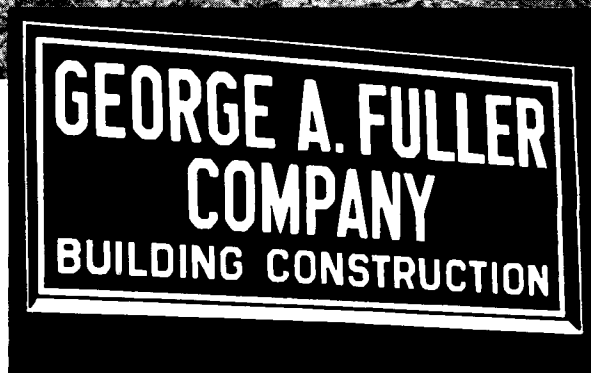



Figure 1

REDWOOD PLASTICS

A NON-CRITICAL phenolic type thermoplastic, chemically perfected from the phlobaphenic structures of the Redwoods, is now available in abundant quantities for both war and civilian production of countless items formerly manufactured from hard rubber and other thermosetting plastic compounds.

The Redwood plastic embodies in one composite form both resin and filler employed in the molding of an endless variety of products. (Figure 1) It is readily adaptable to either compression molding or the standard equipment of hard rubber plants. When special properties are desired, it can be mixed easily with other resins and plasticizers with absolute control of the formulation ingredients.

Given the name of Shellerite, the new plastic was developed jointly by the Pacific Lumber Co., San Francisco, the Institute of Paper Chemistry, Appleton, Wis., and the Sheller Manufacturing Corp., Portland, Ind.

CLOTHES-DRYING LOCKERS

LOCKER rooms planned to provide for complete drying of workers' clothes in ventilated locker cabinets are being installed in several large industrial plants designed and now under construction by The Rust Engineering Co., Pittsburgh, Pa.

This new solution to the problem of between-shift drying of workers' clothes utilizes an air-tight room (glass

block is being used in the instances now under construction) in which air pressure is maintained above normal. Air is drawn into this room through ceiling grilles by the fan in the equipment room of the wash and locker building; it is, of course, heated in winter. The only exit provided for the air is through louvers in the bottoms of the lockers, which are wood construction. Forced through these louvers by the pressure, the air is sucked up through the full interior height of the lockers into plenum chambers set on the locker tops. From here it is vented to the outside.

This device provides a constant stream of air through the dampened clothes from the bottom to the top of the lockers, assuring both a quick and a thorough drying.

NON-METALLIC SHOWER CABINET

CONTAINING less than one pound of metal, the new Weisway V De luxe cabinet shower features a plastex receptor processed under 3,000,000 lb. pressure and said to be exceptionally strong though light in weight. The walls of the cabinet are $\frac{1}{8}$ in. smooth, hard-pressed fiber-board, finished inside and out with two coats of white high-temperature baked enamel, each coat baked on separately. Henry Weis Mfg. Co., Inc., Elkhart, Ind.

FLUORESCENT LAMP STARTER

AN AVERAGE rated life of three years for a fluorescent lamp starter has been announced by General Electric Company's Appliance and Merchandise Department.

First starter to carry the three-year rating is called the "Watch Dog." It is a manual-reset type for 40-watt lamps. The mechanical features which prolong the life of this starter also help to conserve the life of the lamp, life of the ballast, power consumption and maintenance service, it is claimed. These mechanical features are precision lamp starting, and dead lamp lockout which eliminates blinking and flickering when a lamp burns out. When a dead lamp is removed, the "Watch Dog" is reset simply by pressing a button on top of the starter. The

new lamp is then inserted, and the "Watch Dog" brings it into the circuit immediately. General Electric Co., Bridgeport, Conn.

BAR WINDOWS

FIRST PRODUCED in aluminum in combination with steel, later entirely in aluminum, and now in wood, the Geysler Bar Window has horizontal glass-receiving bars carried in continuous unbroken lines across vertical members slotted to receive and engage the bars. Glass panes from 30 to 44 in. wide by 17 to 24 in. high are used. The absence of exterior vertical interruptions between the panes gives an effect of continuous ribbons of glass running the full length of an opening. (Figure 2) Ventilating panels are assembled in the shop. The rest of the material is delivered in bar form for assembly at the job site. E. K. Geysler & Co., 200 Cedarhurst St., Pittsburgh, Pa.

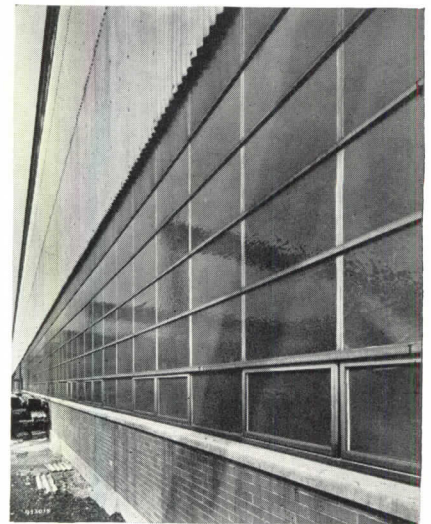
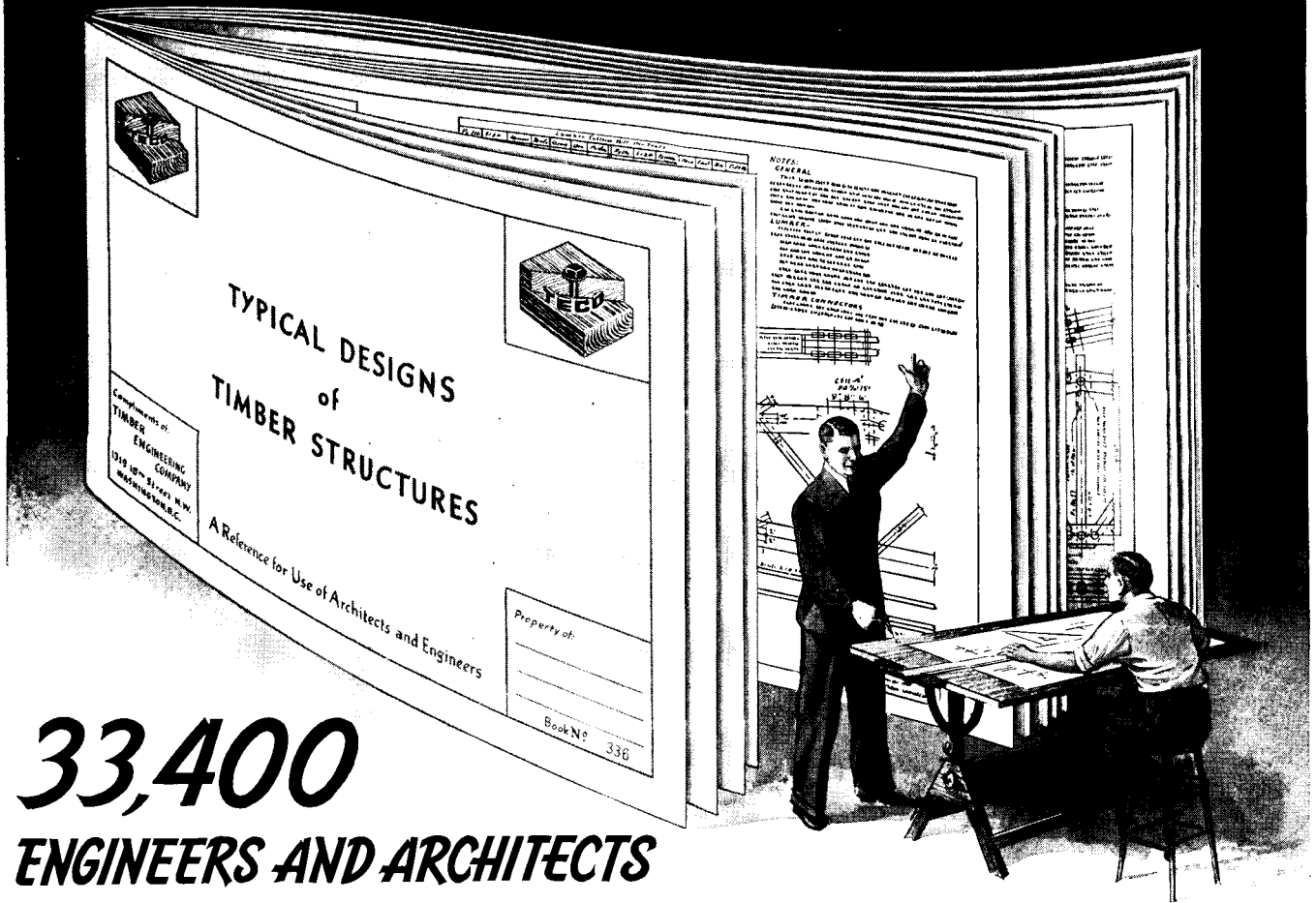

Figure 2

WATERPROOF ADHESIVE

AN ALL-PURPOSE waterproof type cement, designed for use as an over-all adhesive for cementing resilient floor materials to on-grade concrete floors, does not require the use of a primer unless the concrete floor is unusually dirty. This material, Armstrong's No. S-220 Cement, is said to eliminate stretching or crawling of resilient floor materials after the installation has been completed. Armstrong Cork Co., Lancaster, Pa.

(continued on page 90)



33,400
ENGINEERS AND ARCHITECTS
REQUESTED THIS FREE BOOK

In "Typical Designs of Timber Structures" we have assembled the design drawings of 70 representative types of timber structures that have been engineered under the TECO Connector System of construction. It abounds in suggestions for solving design problems. One prominent architect writes: "It is one of the most useful pieces of work that I have received in 20 years." A request on your professional letterhead will bring you a complimentary copy of this most valuable reference book. Write while it is available.

The TECO Ring Connector spreads the load on a timber joint over practically the entire cross-section of the wood . . . brings the full structural strength of lumber into play.

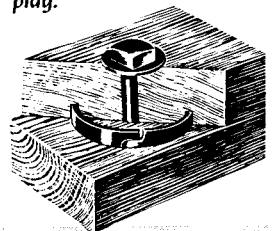

TIMBER ENGINEERING COMPANY
 NATIONAL MANUFACTURERS OF **TECO** TIMBER CONNECTORS AND TOOLS
 WASHINGTON, D. C. PORTLAND, OREGON

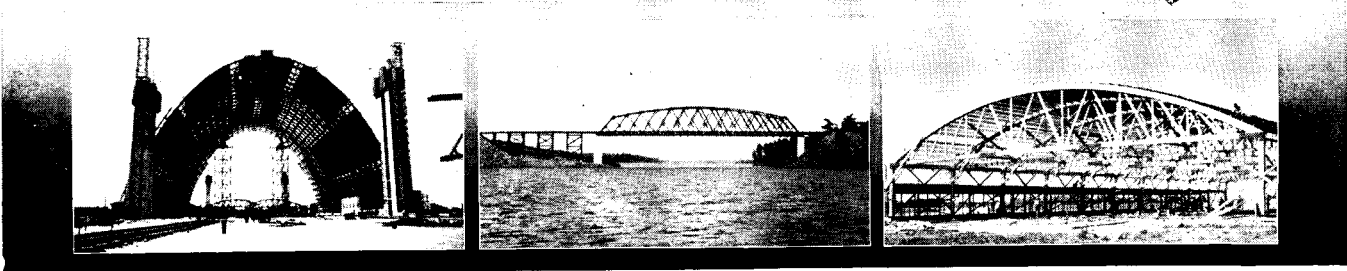

(continued from page 88)

TWIN-THREAD SCREW

REGISTERED as the Twin-Fast Screw, a new patented screw for wood, plastic and combination assemblies has two parallel threads which start at opposite sides of the shank and terminate in a single, centered point to afford greater thread pitch and quicker driving speed. Cylindrical in contour rather than tapered, the new screw is

said to be unusually strong, with an increased thread area which gives it added holding power and makes possible the use of shorter and fewer screws. The centered point offers a "balanced driving" feature which, according to the manufacturer, prevents misalignment of assemblies by eliminating the eccentric movement of the single-thread screw with its off-center

point. Twin-Fast Screws come in all standard sizes, in steel and brass, with round, flat and oval heads. The Blake and Johnson Co., Waterville, Conn.

NON-METALLIC REGISTERS

A COMPLETE line of non-metallic grilles and registers for wartime installations includes two models of adjustable deflection grilles, one with vertical bars, the other with horizontal. The bars rotate through an arc of 90° and are individually adjustable. Each bar is capped with steel. An adjustable double deflection grille consists of two sets of individually adjustable wooden bars in a single frame. The vertical front bars provide any desired sideways deflection, and the horizontal rear bars direct the air stream upward or downward. Two adjustable registers consisting of the same vertical-bar grilles, are equipped with multi-shutter dampers. A flame-proof prime coat finish is standard on all models. Tuttle and Bailey, Inc., New Britain, Conn.

PROPELLER FANS

A NON-METALLIC panel contributing to quicker operation is featured in a new line of Autovent Propeller Fans. Four types are now in production: Standard Direct Drive, in 18 sizes, with wheel diameters from 10 to 48 in.; High Powered Direct Drive, in 16 sizes, with wheel diameters from 12 to 48 in.; Standard and High Powered Belt Drive, in 6 sizes with wheel diameters from 24 to 54 in. All the fans are available for single phase, 115 or 230 volt, and three phase, 220 or 440 volt, 60 cycle alternating current; or 115 or 230 volt, direct current. Motors are totally enclosed. Herman Nelson Corp., Moline, Ill.

SEWAGE CONNECTIONS PERMITTED

BUILDERS are now authorized to make house and project connections to sewage facilities if they meet limits and costs set forth under the provisions of Supplementary Preference Rating Order P-141-a, and if their municipal authority addresses to WPB a letter of certification, the War Production Board announced recently.

(continued on page 92)

Today, the greater portion of White-Rodgers manufacturing facilities is devoted to the manufacture of aircraft controls.

In the design and manufacture of this wartime equipment new applications of the White-Rodgers Hydraulic-Action principle of temperature control are being developed — applications that one day will bring added safety and convenience to a world at peace.

Until then, standard temperature and pressure controls for heating and refrigeration are available for high priority installations essential to the war effort.



Official photo
courtesy U. S. Navy

Series 150 Heavy-Duty Line Voltage Room Thermostat — will handle multiple unit coolers or heaters—available with locked dial and "on," "automatic" and "off" dial positions to serve as manual control.

WHITE-RODGERS ELECTRIC CO.

1229F CASS AVENUE

ST. LOUIS, MISSOURI



1941 **Chiming a cheerful welcome for the Smiths...** War seemed a million miles away. Women played bridge . . . Men talked baseball . . . Edwards door chimes and other communication conveniences brought gracious living to homes . . . efficiency to offices, hospitals, factories.

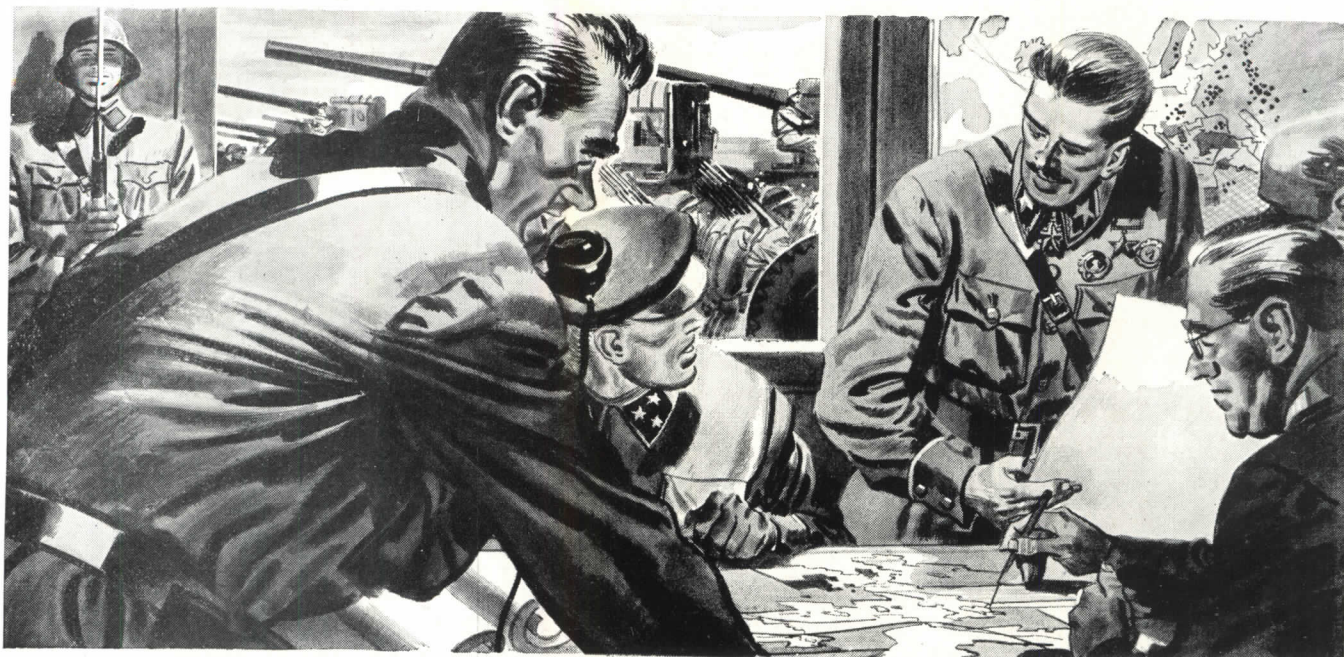

1943 **Plotting a bloody welcome for Hitler...** Today, Edwards equipment streams out to every fighting front. In Russia . . . where Red Army strategists are coordinating their military might, Edwards phone systems help carry the instructions that are smashing Hitler's armies.

194? "Battle-plans" for post-war construction

• Whether it is the lightning thrust of a Russian counter-attack, or convoy defense in the South Pacific, allied striking strength depends on high-speed communications. And in these vital operations Edwards equipment plays an important part . . . But, it is necessary now to look to the peace that will be won. Industry, together with the architect, the engineer, the contractor, must

envision the vast job ahead: the factories, housing projects—the infinitude of reconstruction work. Edwards is already at work, converting newly-perfected wartime communications into peacetime products . . . so that you, as the men who will rebuild the world, will be able to equip your projects with the most advanced communications equipment.

Edwards and Company, Norwalk, Conn.
In Canada, Edwards and Company, Ltd.



EDWARDS

SINCE 1872
Communication Equipment for
Homes, Institutions and Industry

(continued from page 90)

Such a letter must certify that the project served is authorized under L-41 (which rigidly controls civilian construction); that the cost of the material for sewer connections is less than \$1,500 for underground construction or less than \$500 for other construction; and that the connection is built in accordance with Housing Utilities Standards. The letter in and of itself constitutes authorization to construct sewage connection facilities. Previously, industrial and domestic customers needed permission from WPB.

NO PAINT SHORTAGE

DESPITE the tremendous demands upon the paint industry for war purposes and the growing shortages of some of the materials previously used in the manufacture of paint, there will be sufficient paint to meet civilian demands, according to Ernest T. Trigg, President of the National Paint, Varnish and Lacquer Association. This is due, Mr. Trigg explained, partly to the industry's constant experimentation with substitute materials, and partly to the drastic curtailment in ci-

vilian new construction, permitting the allocation of the proportion of paint formerly devoted to that use to necessary maintenance and repair of existing structures.

PHOTOELECTRIC PROTECTION

A NEW photoelectric protection system now available projects a fence of invisible light over distances as great as 1500 feet and gives instant local or central-station alarm if an intruder enters the protected area. Designed to meet government requirements, the equipment has an unusually long operating range and is especially suited to the protection of harbors, yards, docks, industrial properties, airports, and similar large areas. Photoswitch Inc., 77 Broadway, Cambridge, Mass.

WHAT 1942 PROVED FOR 194X

194X . . . V day for building . . . the subject is rife with speculation about new and better design, construction methods and equipment. Since that long cold fuel-conscious winter of 1942, however, one standard for postwar heating equipment has become certainty. THE BOILER MUST BE CONVERTIBLE.

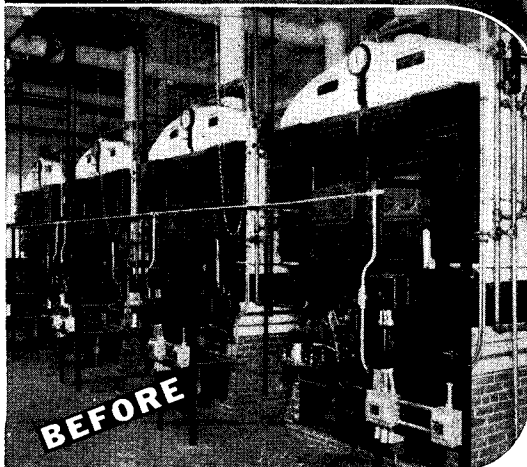
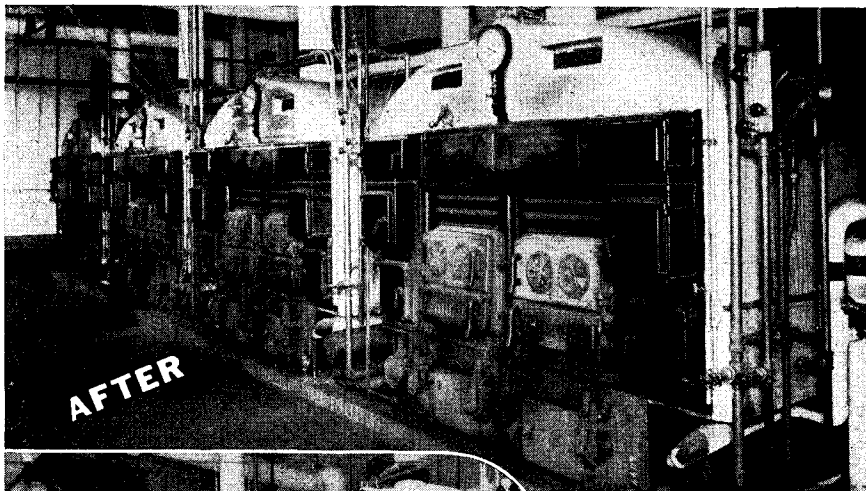

H.B. *Smith*

BOILERS

in the Heath St. Housing project . . . oil-fired in 1941 — converted in 1942 . . . easily, quickly and without loss of efficiency!

IN 1942, every Architect and Engineer who had specified H. B. SMITH boilers for public and commercial buildings could tell his clients that their boilers were easily convertible to hand or stoker firing.

In 194X . . . whatever may be their design, you can be sure of this . . . H. B. SMITH boilers will continue to be built as truly all-purpose boilers suited for use with any fuel.

THE H. B. SMITH COMPANY, INC., WESTFIELD, MASS.
BOSTON NEW YORK PHILADELPHIA

RUST PREVENTIVE PAINT

COMPOUNDED of a special iron oxide deposit found only in the Southwest desert country, a rust preventive paint known as S.R.P. is said to offer unusual protection for exposed surfaces and to inhibit electrolysis and corrosion. L. Sonneborn Sons, Inc., 88 Lexington Ave., New York City.

MINERAL WOOL OUTPUT

MANUFACTURE of mineral wool for home insulation in 1943 will exceed the output of any previous year, Wharton Clay, Secretary of the National Mineral Wool Association, has announced. He predicted that enough wool will be produced to insulate 600,000 houses, at an average of one ton per house, with potential annual savings of 200,000,000 gallons of fuel oil and 650,000 tons of coal. These figures are based on the assumption that two-thirds of the homes to be insulated are heated by oil, the remainder by coal, with each ton of mineral wool saving three tons of coal or 500 gallons of oil each heating season. In anticipation of an even more stringent fuel oil shortage next winter, mineral wool manufacturers are continuing their policy of giving first attention to oil heated houses that can not be converted to coal, Mr. Clay said. This is in line with the government's campaign to increase home insulation as a necessary fuel conservation measure.

"POWDERED DAYLIGHT" for war plants

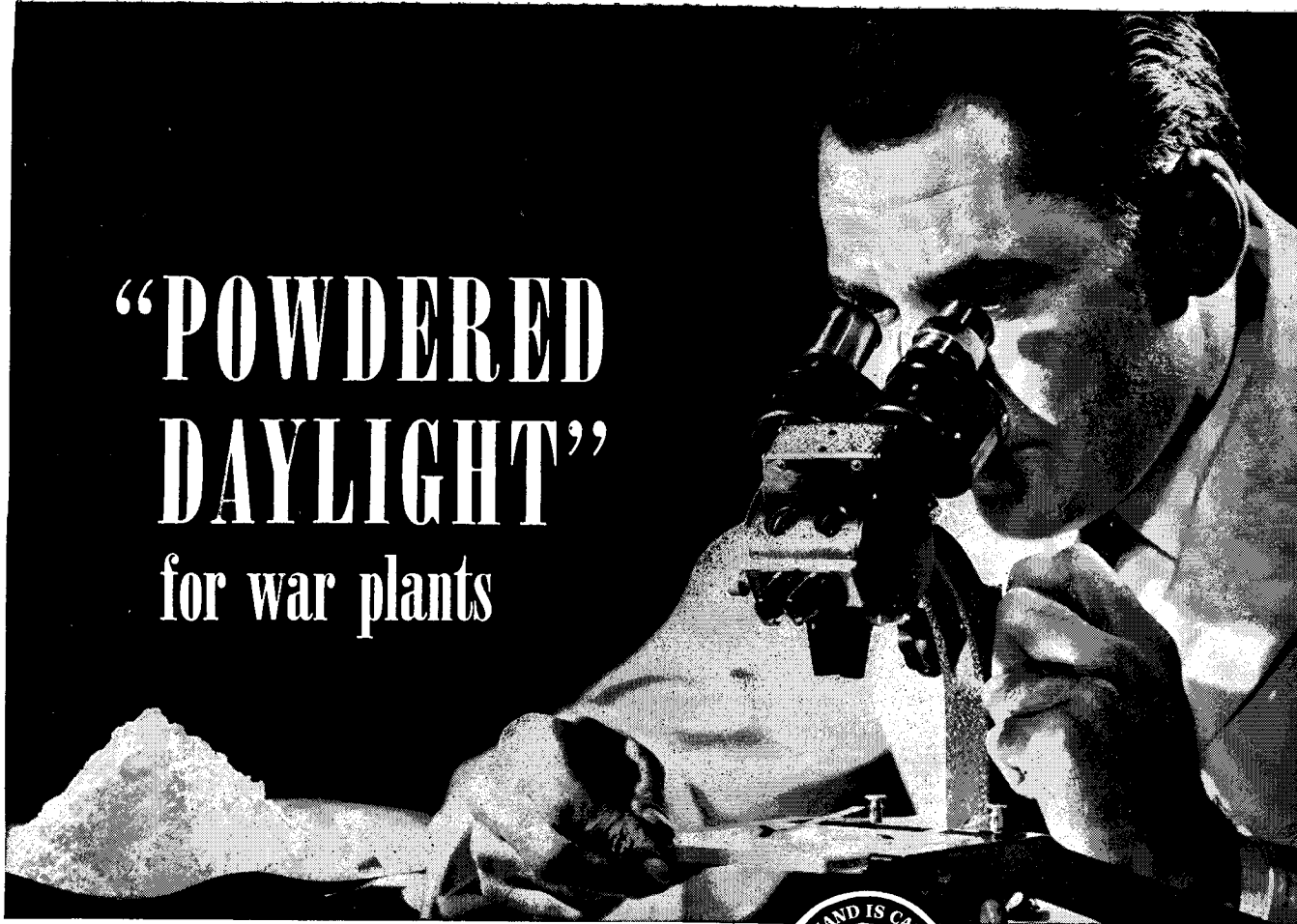

● A vital chemical of war is "powdered daylight" — fluorescent powder that makes cool, glare-free, shadowless light to speed production in plants throughout America.

Complex compounds called phosphors are pulverized, refined and milled to the fineness of face powder. Precisely blended and mixed with binders to assure even coating, tiny phosphor particles are *fixed* inside the glass tube by high-temperature baking. There, in very low-pressure argon gas and mer-

cury vapor, the "Black Light" magic of ultra-violet rays transforms phosphor energy into visible light more constant than daylight — and just as kind to the human eye.

More than ten years of independent research have made coatings with smoother textures a unique feature of Sylvania Fluorescent Lamps. They have also brought other points of Sylvania Lamp superiority: uniform colors, higher light output and longer life — at



progressively lower costs.*

Improvements take place every week at Sylvania. Many of them, like the "Mercury Bomb," conserve strategic materials and labor, and at the same time improve quality. All of them serve fluorescent progress, which is aggressively aimed to bring better lighting to industry, commerce and the home when Victory is won.

While today's Sylvania Fluorescent Lamps are serving three-shift days in America's war plants, tomorrow's are being made even better. Specify Sylvania Fluorescent Lamps for replacement and be assured of all the improvements offered by constant research.

FAR MORE LIGHT AND LIFE FOR YOUR MONEY

*Compared with 1939 a dollar invested today in Sylvania Fluorescent Lamps buys more than four times the lumen output and approximately five times the lamp life.

SYLVANIA
FLUORESCENT
DOLLAR
BUYS:

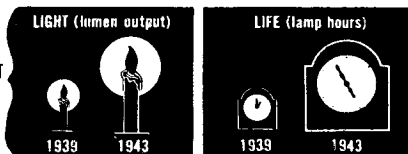

(Based on decreasing price and increasing efficiency and durability of Sylvania 40-Watt White Fluorescent Lamp)

Even on existing circuits, a change-over to fluorescent—Sylvania Lamps, Fixtures and Accessories—will probably more than double the light you get for the same wattage.



SYLVANIA

ELECTRIC PRODUCTS INC.

formerly Hygrade Sylvania Corporation
Salem, Mass.

Incandescent Lamps, Fluorescent Lamps, Fixtures and Accessories, Radio Tubes, Electronic Devices.

FPHA TO USE PLASTIC TUBING

(continued from page E6)

tubing, and anyone accustomed to this process should experience no difficulty in producing a satisfactory connection.

"Connections: A flared fitting connection shall be made watertight with a pair of pliers or a wrench, not more than 5 in. in length. A connection made in this manner will test to 125 lb. per sq. in., without leaks. Larger

wrenches will cause too heavy stress on the fitting and tubing, and rather than producing a tighter connection, it will result in weakening the joint and producing leaks. All connections between plastic fitting adapters and metal IPS connections shall be made with proper thread pipe compound.

"Service Main: Service main from the building to the lateral water main

shall be made in one piece, and, except where a service valve or stop and waste is required, between the main and the building."

The instructions do not refer to use of the material for gas lines, but according to Vincent T. Manas, who is in charge of tests and instructions for WPB and FPFA, it is suitable for them. It has not, however, yet been approved for "bottled" gas.

Tests it has passed

Tests and research have been carried out for several months. The principal laboratory tests were made at the University of Iowa, with others by the manufacturer, the National Bureau of Standards and the Department of Agriculture.

At normal temperature (70° F.) pressure tests have shown satisfactory performance at 500 lb. per sq. in. Other tests made, also noted "tubing satisfactory," carried temperature up to 210° at 240 lb. per sq. in.

The tubing was flexed and distorted by hand, with no damage to tubing or connections.

The test data include results of several tests for shock or water hammer, with remarks: "Tubing and fittings withstood the shock very readily and no indication of weakness or leaks resulted. It is to be noted that pipe noises would be either entirely or partially eliminated, due to the shock absorbing quality of the tubing."

Freezing tests showed that the tubing expands with the formation of ice. On thawing, the tubing returns to its original shape, with no change in its physical condition. While it is frozen, however, the tubing is brittle, and may be broken by hammering.

Department of Agriculture tests for toxic results have "conclusively proved that the tubing may be used safely for potable water supply, without any toxic or injurious results. Tubing has also undergone considerable tests from the point of corrosive waters, and results are excellent for use in any locality where steel pipe or any other metal pipe will be seriously affected in a short period of time, by the characteristics of the water."

Thus does one "plastic" material pass its first tests and begin to fulfill oft-made promises that it would invade the field of plumbing.



BARCOL OVERdoors
MEET UNUSUAL REQUIREMENTS

Barcol OVERdoors of various types in hundreds of war production plants are giving long-lived trouble-free service necessary to efficient plant operations. This picture, for instance, shows a Motor-Operated Barcol OVERdoor of the hi-lift weight-counterbalanced type, specially arranged for a railroad track entrance and to clear a travelling overhead crane. For new installations, and to replace existing unsatisfactory doors, specify Barcol OVERdoor.



Factory-Trained Sales and Service
Representatives in Principal Cities

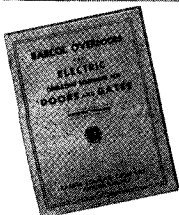

GET THIS MANUAL
Includes data on the principal features of Barcol OVERdoors, and detailed description of the various types of Electric Operators for Doors and Gates. Write for INDUSTRIAL MANUAL F-1298.

BARBER-COLMAN COMPANY

102 MILL ST.

• ROCKFORD, ILL.

When the Time Comes . . . **EXPECT THIS FROM US**

Speed in switching to full-out peace may be even more vital than the time it took to change to war.

It will be important to you. It will be important to workers who need productive jobs. It will be of the utmost importance to every business . . . to all America . . . in order to avoid "make work" expediences . . . in order to keep the kind of America we fought for.

When war came, LCN stepped out instantly on what we knew was the shortest road to peace—full scale production for war.

Today, even as we apply every productive resource to increase our swelling flood of war material, we at LCN find time . . . make time . . . to forge our plans for peace. We will be ready with our answer to the critical problems that will be upon us.

Expect us, then, when that time comes, to switch over to the business of peace with utmost speed—for you, for us, for America.

It is the one adequate answer that American business can and must make.



DOORCLOSERS

NORTON LASIER COMPANY, 466 WEST SUPERIOR STREET • CHICAGO

A.I.A. CONVENES AT CINCINNATI

(continued from page 48)

of Walter R. MacCornack's Committee on Postwar Reconstruction, to realize the breadth and depth of the thinking that must be done in solving problems of the future. Some 18 topics were listed in the report, including employment, finance, taxation, city planning, land values and land use, government relationships, technical improvements in design and

construction, transportation, housing, recreation, and needed legislation. The report of the committee should form a basis for a program for individual thinking and for Chapter activity. The need for a more unified profession was strongly felt.

The Producers' Council, which met in Cincinnati at the same time, devoted its major reports and discus-

sion to the coordination of postwar planning, and was equally comprehensive in its scope.

The report of the Board of Directors brought out the question of the architect and governmental relations. The work of Mr. D. K. Este Fisher, Jr., in Washington, has been invaluable in this connection. The report showed that corporate membership in the Institute has risen to 3,768—the largest in its history. Through state association affiliations, the total strength is 6,143. The finances of the Institute were shown to be in better condition than for many years past.

Raymond J. Ashton, F.A.I.A., of Utah, was elected president of the Institute. Born in Salt Lake City, 1887, he was educated in the city schools and at the University of Utah School of Engineering. From 1909 to 12 he was traveling and studying in Europe. In 1914, he went to Chicago, worked in the offices of David Adler and of Schmidt, Garden, and Martin, and attended the Atelier Puckey. He was also active in the Chicago Architectural Club. After practicing alone under his own name in Salt Lake City, he formed his present firm in partnership with Raymond L. Evans, in 1922. At the beginning of the war a partnership for defense work was formed with Leslie S. Hodgson, and under these names, the 200-bed Bushnell Hospital at Brigham City, Utah, and various housing projects were completed. In 1942 the partnership was further expanded to undertake a complete Naval Supply Depot. Mr. Ashton's firm has done college buildings of many kinds and office, industrial, commercial, and ecclesiastical buildings throughout the state. Having served as a member of the Board of A.I.A., and last year as treasurer, he enlarges his sphere of activity and influence as president. He lives on a 21-acre farm north of Salt Lake City, where he indulges his two hobbies of "would-be" farming, and cooking.

Alexander C. Robinson, III, of Cleveland, was elected secretary of the Institute, and J. R. Edmunds, Jr., of Baltimore, treasurer. Edgar I. Williams, of New York, was elected Regional Director for New York district, and Douglas William Orr, of New Haven, Regional Director for New England.



Tear only follows Neglected Wear

Neglect of normal wear spells rapid, wasteful disintegration. In today's fuel emergency, neglect of heating equipment is sabotage.

The normal wear that has occurred in your heating system takes on a double significance today. Be sure that neglect doesn't allow this normal wear to develop into mechanical deterioration with resultant heavier demands on critical materials and manpower.

Fuel is a critical material. In your own interests and in the National Interest, check your heating system with extra care this summer. At every point, from boiler through mains, traps, valves, pumps, radiation and returns, see that minor replacements or corrections are made now to keep wear at normalcy and keep use of fuel to a minimum.

Dunham Differential Heating stretches the heat values of steam and advances fuel economies far beyond ordinary concepts. We will gladly send details. Just write to our Chicago office.

C. A. DUNHAM COMPANY

450 E. OHIO ST. • CHICAGO

TORONTO, CAN.

LONDON, ENG.

**DUNHAM
DIFFERENTIAL
HEATING
MAKES FUELS
GO FURTHER**

ARE YOU THINKING

ABOUT THE FUTURE?

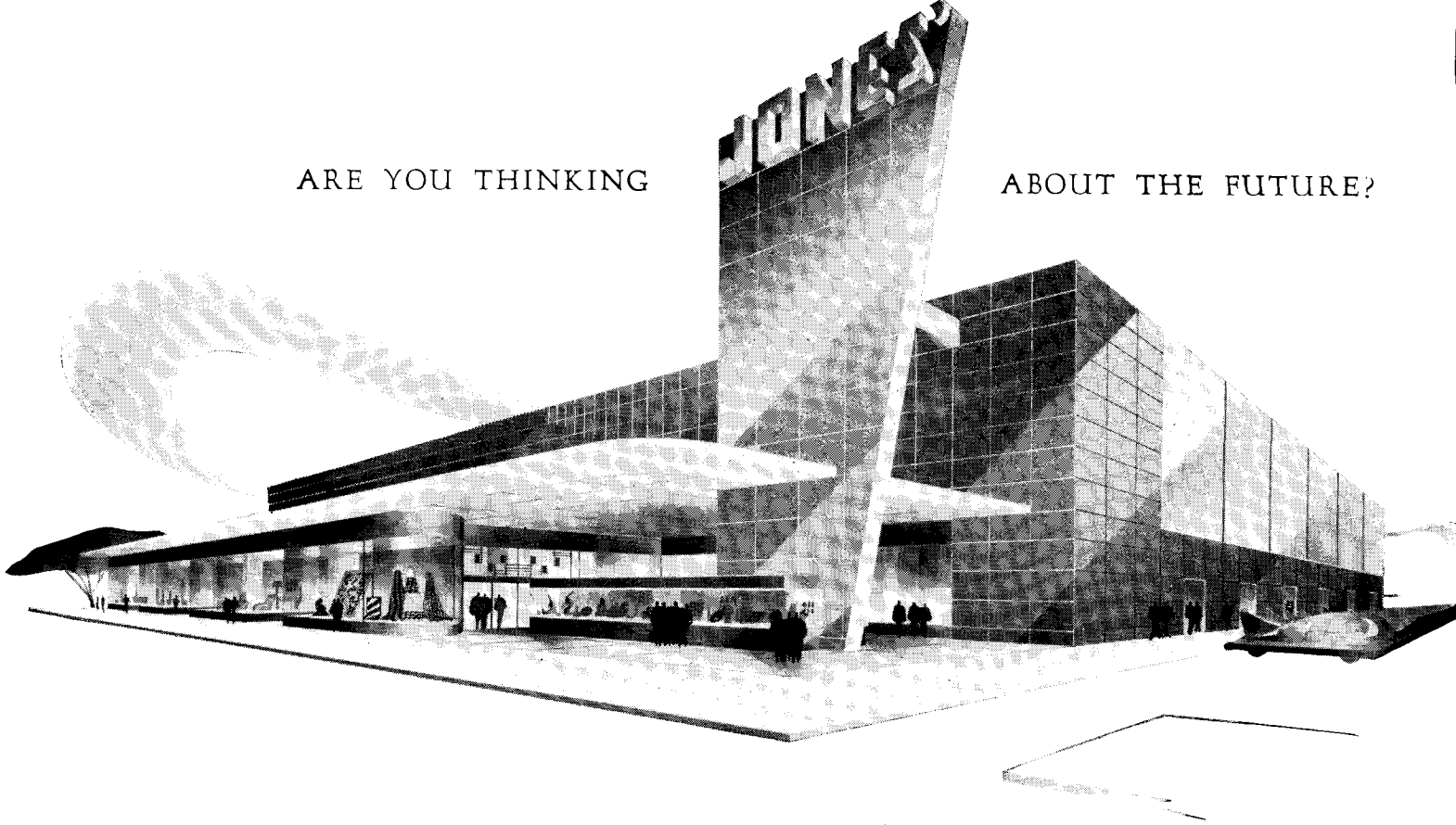

What Steel has to offer for the buildings of 194X

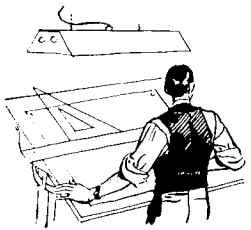

THE qualities that have made steel the A-1 material for thousands of war uses will again

make it a prime material for construction after the war. No other material can do so many jobs so well.

Here are a few things that you can obtain with steel that will improve post-war buildings of all kinds:

GREATER STRENGTH. Steel-framed buildings have shown their greater strength again and again during severe bombings of London and other European cities. Future construction should take this into consideration for all types of buildings. Steel frames for homes offer greater resistance to damage from tornadoes, high winds or earth movement.

MORE LIGHT AND AIR. Steel windows and large glass areas made possible with steel framing bring the outdoors into the house. Living is more healthful and enjoyable.

IMPROVED AIR CONDITIONING. Great advancements in heating and air-conditioning are now being perfected and will be ready right after the war. Warm air systems using steel furnaces and steel

ducts will clean the air to a degree never obtained before. Temperature and humidity controls are being improved which will assure freedom from drafts, cold areas, and incorrect humidity.

BEAUTY. U·S·S Stainless Steel and Porcelain enamel on U·S·S VITRENAMEL Sheets are finding new uses for kitchens, bathrooms and outdoor trim. Store fronts of porcelain enamel are highly decorative—never need painting.

DURABILITY. U·S·S Steels will be obtainable with corrosion resistance ranging from that of ordinary steel to the permanence of stainless steel. Greatly increased capacities for making electric furnace steels will help to reduce their cost. Surface finishing, such as Bond-erizing, will help to make painted surfaces more durable.

PREFABRICATED UNITS. Mass production of prefabricated units, such as windows, cabinets, closets, stairways, bathtubs, sinks and lavatories, will help to reduce costs on these items. Prefabricated homes and farm buildings with steel wall sections have already found wide use in some districts. Look for increasing developments along this line with more attention to exterior and interior beauty.

BETTER PROTECTION. Danger from fire, lightning, rain, snow, wind, sun and termites can be reduced with proper use of steel. Roofing of U·S·S Copper Steel for modern and colonial style buildings will last indefinitely if properly maintained. Porcelain enamel corrugated roofing and siding never needs painting.

MORE EFFICIENT INSULATION. Steel insulation reflects 95% of radiant heat. Winter heat trying to escape is directed back into the house. Summer heat from the sun is kept out. Steel insulation sheets retard fire, form dead air space between walls, are water-proof, vermin-proof and do not pack down.

Write for information

Late information is available which gives complete details on these and many more items made of U·S·S Steels. Address U. S. Steel Corporation Subsidiaries, 621 Carnegie Building, Pittsburgh, Pa.

**U·S·S
BUILDING SHEETS**



CARNEGIE-ILLINOIS STEEL CORPORATION, *Pittsburgh and Chicago*

COLUMBIA STEEL COMPANY, *San Francisco*

TENNESSEE COAL, IRON & RAILROAD COMPANY, *Birmingham*

United States Steel Supply Company, *Chicago, Warehouse Distributors*

United States Steel Export Company, *New York*

UNITED STATES STEEL

(continued from page 14)

special casualties—the blind, the deaf and the maimed; mandatory re-employment by pre-enlistment employer.

ASSOCIATION OF FEDERAL ARCHITECTS ELECTS OFFICERS

The Association of Federal Architects, at their Annual Meeting in Washington on April 26, elected Al-

bert G. Bear President for the year 1943-44.

Mr. Bear, a member of the American Institute of Architects and the Society of American Military Engineers, is well known among government architects. He has been connected with the Construction Service of the Veterans Administration for the past fifteen years, and at the present time is Chief

of the Specification Sub-Division of the Technical Division of that organization.

Marshall Shaeffer was elected Vice President and Florian Elliott, Secretary. The following members were elected to the Board of Directors: W. Ellis Groben, F. H. Mahlman, Ben Howes, D. W. Twiddy, J. H. Morrissey, H. W. Meahin, M. Scheingarten, E. M. Kilerlane, C. H. Irwin, William Reick, and F. J. Ritter.



PREFABRICATED DEMOUNTABLE HOMES engineered at PEMBERTON

Today, Pemberton's manufacture of Prefabricated-Demountable Homes, Barracks, Hutments, Dormitories, Cantonment Groups, Mess Halls, Canteens and other War-emergency requirements of the Government take precedence over all other business. The Pemberton Mills have turned out thousands of units as a part of the Nation's war effort.

In addition the Pemberton Lumber & Millwork Corporation's plants at Pemberton have developed and produced thousands of Trusses and Sub-assemblies for war projects from Maine to Florida, and as far west as Utah.

Important Government Projects Supplied by Pemberton Mills

- SAMPSON NAVAL TRAINING STATION, New York
- BROOKLYN-BALTIMORE HOUSING PROJECT (1000 units)
- WAR-WORKERS HOMES, Hartford, Conn.
- BARRACKS AND CANTONMENT ASSEMBLIES, Fort Dix, N. J.
- PREFABRICATED HOMES, Middle River, Md.
- MIGRATORY FARM WORKERS HUTMENTS, King Farm, Morrisville, Pa.
- FARM SECURITY ADMINISTRATION DORMITORIES (in several areas)
- WAR-WORKERS HOUSING, Elkton, Md.
- TILTON HOSPITAL SUB-ASSEMBLIES, Fort Dix, N. J.
- (and scores of other U. S. Government war projects)

The Pemberton organization quickly became a factor in the rapid erection of thousands of War-emergency structures because its Engineers have been applying advanced construction methods to the present-day building needs of a Nation at War.

For Tomorrow, Pemberton's skill in the manufacture of Prefabricated-Demountable buildings of all types—a special objective of Pemberton research in peace as in war—will be graphically portrayed in the mass production of finer permanent homes.

Send for Illustrated Brochure No. P-32 at the address below.

PEMBERTON LUMBER & MILLWORK CORP.

Prefabricated-Demountable Industrial Buildings, Homes, Dormitories, Cantonment Barracks, Cafeterias, Field Offices, Administration Buildings, Hutments, Trusses, Sub-assemblies, etc.

Prefabrication Plants, Mill & Lumber Yards • PEMBERTON, NEW JERSEY • Tel. PEM. 8011

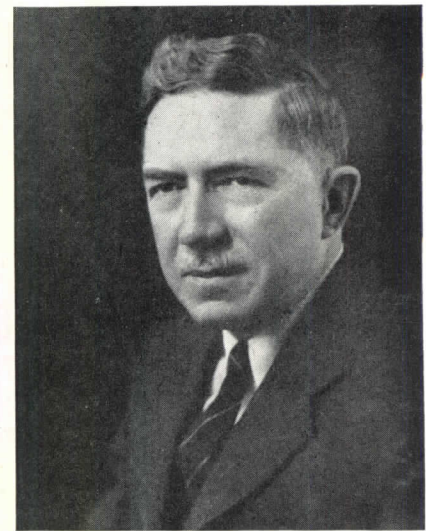

Conroy Studios

HUGH FERRISS

ARCHITECTURAL LEAGUE OF NEW YORK INSTALLS NEW OFFICERS

At the recent annual meeting of the Architectural League of New York Hugh Ferriss was installed as president.

Widely known for his imaginative drawings of the city of the future, Mr. Ferriss toured the United States on the Arnold W. Brunner Scholarship of the Architectural League, to make drawings of war plants. These drawings were shown later at the Metropolitan Museum of Art in New York. He has just received a grant for creative work from the American Academy of Arts and Letters.

Other officers installed were: J. Scott Williams, First Vice President; Eleanor M. Mellon, Second Vice President; C. Earl Morrow, Third Vice President; Nancy V. McClelland, Fourth Vice President; Frederick G. Frost, Jr., Fifth Vice President; J. Theodore Haneman, Secretary; and H. Douglas Ives, Treasurer.

(continued on page 100)

WAR HOME

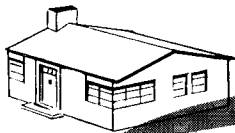

INDUSTRIAL PLANT

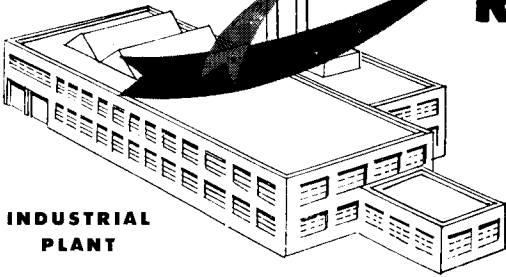

HOSPITAL

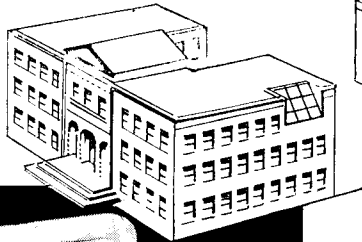

SCHOOL

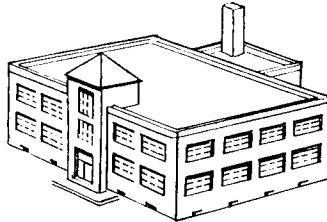

BARRACKS

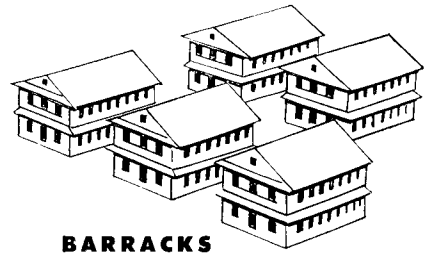

RUGGED, QUALITY PLUMBING *for* war construction

MANY architects today are busy designing homes for war workers, industrial plants, Army and Navy bases, hospitals and schools. All of these require modern, efficient plumbing equipment.

To meet this need, Crane Co. has designed a line of equipment using a minimum of critical materials. This line has received government approval for all types of war construction jobs.

Your plumbing contractor or Crane Branch will gladly give you further information on plumbing and heating equipment for any plan on which you are working and will assist you in the specifications on such jobs.

ENTERPRISE LINE

The Enterprise line of plumbing equipment is Crane's answer to America's conservation program. This equipment is designed to use the minimum of critical metals. The plumbing fixtures are made of non-priority materials and the trimmings are cast iron heavily galvanized inside and out. The complete line includes equipment for any war construction need.

CRANE

CRANE CO., GENERAL OFFICES: 836 S. MICHIGAN AVE., CHICAGO
VALVES • FITTINGS • PIPE • PLUMBING • HEATING • PUMPS

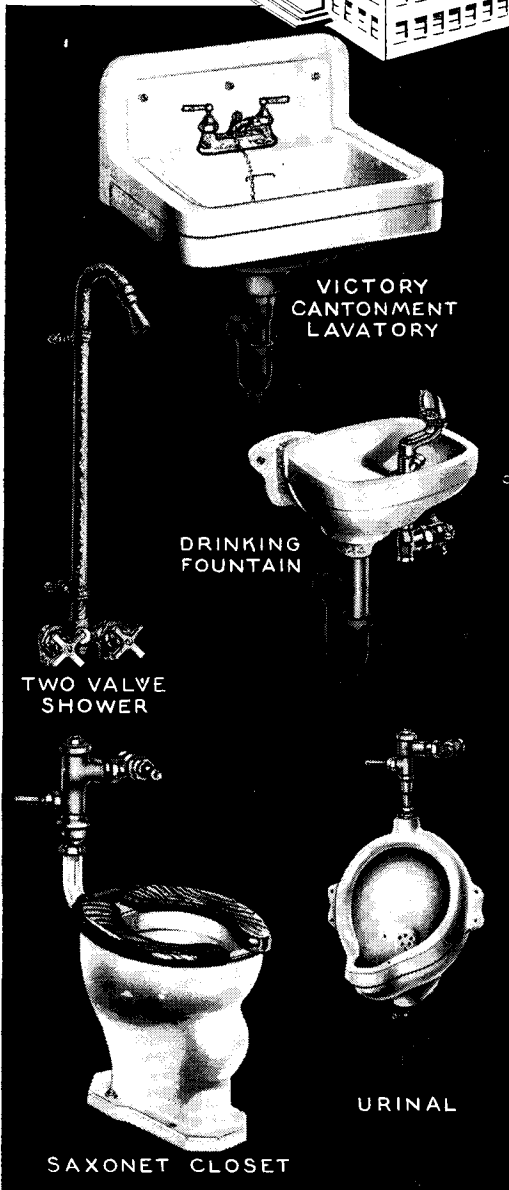

VICTORY CANTONMENT LAVATORY

DRINKING FOUNTAIN

TWO VALVE SHOWER

SAXONET CLOSET

URINAL

NATION-WIDE SERVICE THROUGH BRANCHES, WHOLESALERS, PLUMBING AND HEATING CONTRACTORS

(continued from page 98)

WAR HOUSING REPORT

Approximately 123,500 new war housing units were completed and made available for war workers during the first quarter of 1943, and 147,000 units were placed under construction, NHA Administrator John B. Blandford, Jr. has announced. This represented an increase of more than 25 per cent over the last quarter of

1942 in number of completions and of more than 60 percent in the number of units started, Mr. Blandford said.

The report reflected a sharp acceleration in starts under the publicly financed phase of the program, which includes dormitory units and trailers as well as family accommodations in new structures. All but a minor per-

centage of the publicly financed war housing started during recent months represents temporary construction schedule for postwar dismantling.

DELAYED PAYMENT PLAN FOR FUEL CONSERVATION LOANS

To assist the national drive for fuel economy, FHA has established a delayed payment plan for loans insured under its Title I program which finance fuel conservation installations this spring and summer, Federal Housing Commissioner Abner H. Ferguson has announced.

The FHA has notified the 5,000 private lending institutions authorized to operate under its Title I program that initial payments on loans made between April 20 and September 1, 1943, if the entire proceeds are used for the conversion of heating equipment to the use of other fuels, for application of insulation within existing structures, or for installation of storm doors, storm windows, or weatherstripping.

Loans for these purposes are available in amounts up to \$2,500, payable in monthly installments over as long as 36 months.

REVISED BUILDING CODE

The Recommended Building Code of the National Board of Fire Underwriters, which serves as a model for building regulations in many cities throughout the country, has been revised to conform to advances in knowledge and experience which have resulted from new methods and materials, and to suggest means of protection required by new hazards, it has been announced by W. E. Mallalieu, General Manager of the Board.

The Code does not attempt, however, to dictate choice of materials, assemblies or designs, so long as a proper degree of safety and health is attained, Mr. Mallalieu said. An outstanding addition to this 1943 Recommended Building Code is an appendix in which the fire resistance rating, in hours of duration, is given for different forms of construction. This appendix covers walls and partitions, columns, beams, girders, trusses, and floor and roof construction.

(continued on page 102)

SPEED UP CONSTRUCTION

WITH ARMOR

PREFABRICATION!

A REPUTATION BASED ON PRE-WAR PERFORMANCE

For seven years Armor Prefabrication has been a tried and proven system for getting thousands of buildings up quickly.

Here is a way to erect strong, sturdy, suitable structures with a minimum of time and labor in torrid, temperate or frigid zones.

Armor engineers are ready to assist you in selecting or designing the structure best suited to your requirements.

Write or wire for full details



- HOUSES
- BARRACKS
- NOSE HANGARS
- HOSPITALS
- POWDER MAGAZINES
- UTILITY BUILDINGS
- MESS HALLS

ARMOR PRODUCTS, INC.

21 WEST STREET NEW YORK 6, N. Y.

An Architect Points Out



some major advantages provided by **OIL BURNING SYSTEMS FOR CHURCH HEATING**

Herbert E. Matz, of Cherry and Matz, prominent New York architects for the past 20 years, has designed many fine churches throughout the New England States. Oil heating systems were installed in many of these jobs, and based on his experience Mr. Matz has this to say of their use,

"Prior to curtailment of critical materials we were commissioned on many prewar churches, heated in most cases with oil burning equipment. Our specifications usually mentioned burners of two or three acceptable manufacturers, and invariably 'Petro' was selected by the Building Committee after careful study and investigation.

"Oil fuel has proved the most desirable method of church heating, due to control of heating, saving of valuable space, and saving of janitor labor which with church management is a very important overhead item."

Mr. Matz's remarks are a reminder that when peace is restored it will bring back into proper focus such long-swing considerations as over-all operating economy.

Today everything must be secondary to our fight to re-establish the things churches typify, and Petro's production and energy is absorbed in providing fighting tools.

But thousands of Petro Oil Burning Systems previously installed are exceeding their rated capacities every day to meet war-time necessities. By standing up unflinchingly under this excess demand they are piling up additional evidence to guide everyone who is involved in structural planning for the post-war era.

When peace and normal activities are restored, the need for reliable, economical and long lived firing equipment will again be met most thoroughly by the Petro Systems that will be waiting to go to work.

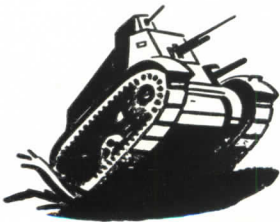

OIL IS AMMUNITION USE IT WISELY

Full data on Petro Industrial Burners are in Sweet's—or Domestic Engineering—catalog files, or we will gladly send copies on request.



PETRO

Cuts Steam Costs



PETROLEUM HEAT AND POWER COMPANY

STAMFORD

—Makers of good Oil Burning Equipment since 1903—

CONNECTICUT

**WAR PLANTS TODAY
point tomorrow's trend..**

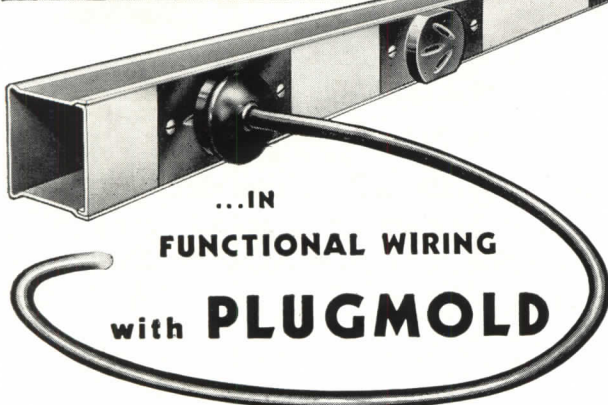

...IN
FUNCTIONAL WIRING
with **PLUGMOLD**

● Plugmold along busy work benches, assembly tables and in engineering and inspection departments is the ideal means of providing unlimited numbers of electrical outlets right where they are needed to save motion... eliminate long extensions... step up production.

Now and later these same NEEDED advantages find application in every building, in every school, hospital, apartment and office and in every electrically up-to-date home. Immediately available on suitable priority. Conforms to Federal Specification W-R-32. Listed by U.L.

We invite inquiries from architects. Our engineering department will be glad to assist you in every way possible. The Wiremold Company, Dept. AR - 6, Hartford, Conn.

WIREMOLD can help you
produce for **WAR**... and plan for **PEACE!**

"HELPING HAND" LITERATURE FOR PLANT OPERATORS

- Bulletin, "Wiremold Industrial System-Wiring Speeds War Production".
- Engineering Data Sheets, Plugmold Multi-Outlet Wiring Systems.
- Wiremold Catalog and Wiring Guide
- Engineering Data Sheets No. "3000" System Wiring for Industrial plants.
- "Pancake" Wiremold Overfloor Wiring System for Office and factory.

CHECK and return with your name and address

THE RECORD REPORTS

(continued from page 100)

POTENTIAL USEFULNESS OF PLASTICS IN BUILDING INDUSTRY STRESSED AT MEETING

For one important clue to the future of plastics in architecture, watch the aircraft industry. Recent advances there in fabrication of structural parts, employing new synthetic plastic resins in combination with materials like cloth, wood, paper and Fiberglas, have surprised even plastics technicians.

By simple, inexpensive methods these familiar substances are being made into wing tips, nose pieces, cowlings, and other structural shapes, large and small, that are equal or superior to airforms produced from conventional materials by conventional processes. Little imagination is needed to translate these airplane parts into building parts. The difference is mainly a matter of size and shape.

The manufacturing process—low-pressure molding—is a live topic in the plastics industry. No single subject received more attention from the 700-odd manufacturers and fabricators attending last month's meeting of the Society of the Plastics Industry in Chicago.

Low-pressure molding is not complicated in principle. One or more thicknesses of the material to be molded are coated with plastic resin, placed on a mold, and subjected to whatever heat and pressure may be required for shaping and curing. Actually no heat or pressure is needed with some of the newest resins. The enormous advantage of the low-pressure process is that it allows molding to plastic-laminated or impregnated forms in sizes and shapes formerly obtainable only with prohibitively expensive hydraulic presses.

While the principle of low-pressure molding is simple and well known, certain details of its application vary with the manufacturer and might almost be classed as trade secrets. Consequently the experts who discussed low-pressure molding at the plastics meeting in Chicago last month had an attentive audience. One of them was J. D. Lincoln of the aircraft division of the Virginia-Lincoln Furniture Company, Marion, Virginia. Large molders of plywood before the war, this firm moved readily into the production of laminated structural parts for aircraft.

Describing the combination of plastic resin and Fiberglas as a "reinforced plastic," Mr. Lincoln told of tests in which the finished product attained a tensile strength of 80,000 lb. per sq. in. He exhibited a low-pressure laminate of paper and plastic with a tensile strength of 19,000 lb.

The ease with which large structural shapes can be fabricated by low-pressure molding gives the process great potential usefulness in building, the speaker held, citing refrigerators, ranges, bathtubs and wall sections as probable future applications. Asserting that theoretically an entire house can be constructed by this method, he pointed out that his organization already has fabricated for military use a spherical structure 26 ft. high.

Throughout the meeting there was evidence that manufacturers serving the building industry are far from unaware of the possibilities of plastics. On the registration lists were many names that long have been familiar to the architect-engineer, including American Radiator, Barber-

(continued on page 104)

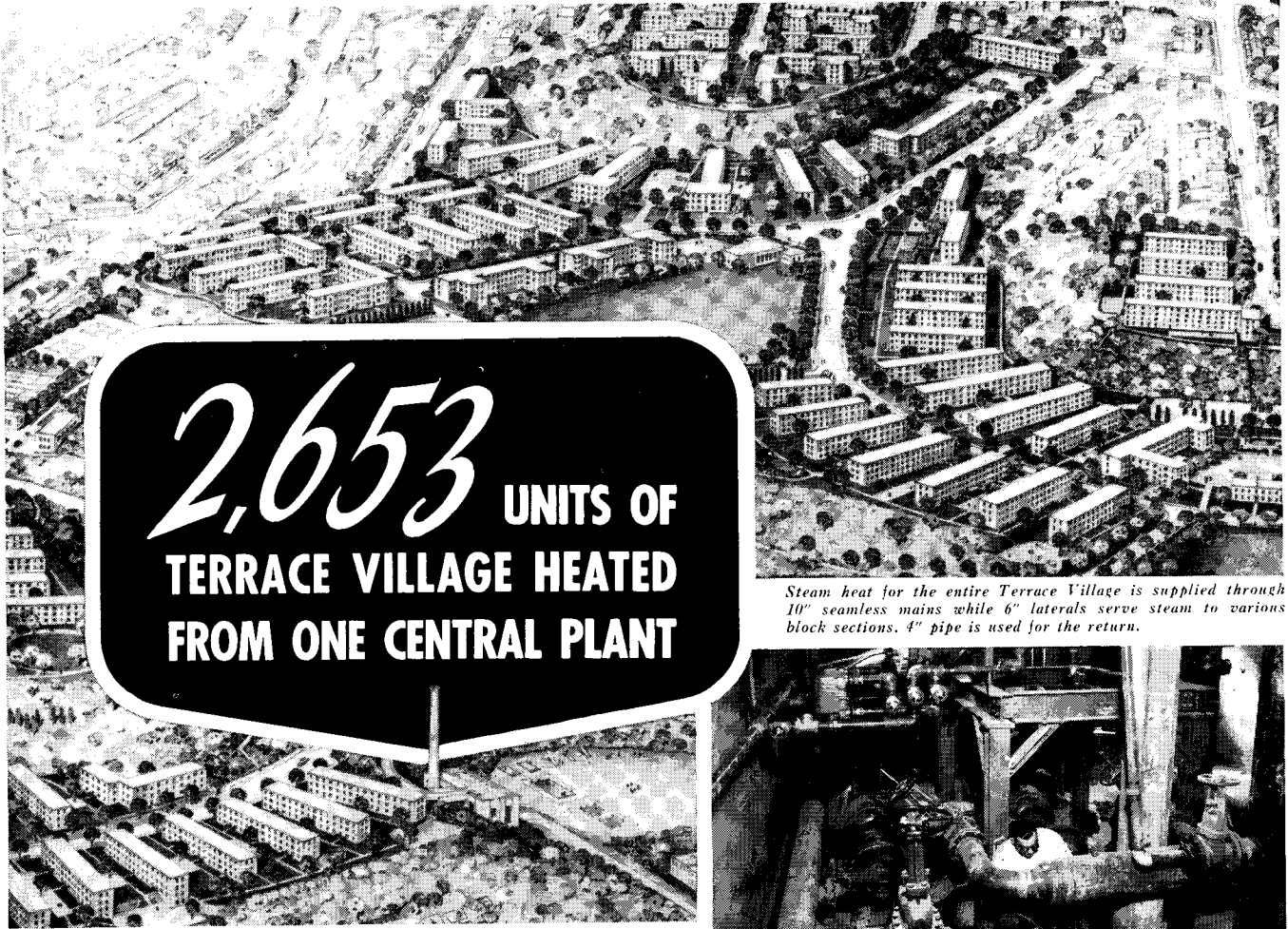

2,653 UNITS OF
**TERRACE VILLAGE HEATED
 FROM ONE CENTRAL PLANT**

Steam heat for the entire Terrace Village is supplied through 10" seamless mains while 6" laterals serve steam to various block sections. 4" pipe is used for the return.

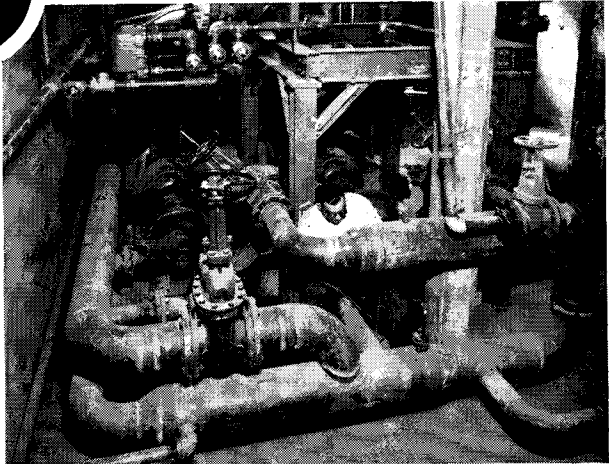

—Major tonnage of pipe is
NATIONAL!

TERRACE Village, Pittsburgh, is one of the nation's largest housing developments. It contains 2649 family units, 3 recreation and management units and 1 administration building—a total of 2653 units. All buildings are efficiently heated from one central boiler plant.

The development has been completed for more than a year, and heating throughout the entire community has been entirely satisfactory.

This shows that sound design,

backed up by proved materials and good installation practice, brings sure results. The major tonnage of pipe for the heating was the same NATIONAL Pipe that has been giving good service for more than 50 years in all types of buildings. It has been improved, of course, from time to time with new methods and processes of manufacture.

Can you get such pipe today? Yes, if you are engaged on a war job which is helping to bring Victory. It's true

that much of the pipe we make is going into such projects as the world's biggest oil line from Texas to New York . . . or huge quantities of new ships, trucks, tanks and jeeps, bombs and shells . . . but war housing developments, industrial plants, hospitals and military buildings are getting their share, too.

And in the future, as in the past, NATIONAL Pipe promises the greatest value per dollar of cost for any type of building project.

NATIONAL TUBE COMPANY

PITTSBURGH, PA.



Columbia Steel Company, San Francisco, Pacific Coast Distributors

United States Steel Export Company, New York



WAR HOUSING EXPERIENCE

YOU CAN USE—

TYPICAL HOUSING PROJECTS WITH KITCHENS BY KITCHEN MAID



Project	Location	Kitchens	
Red Hook Housing Project	New York, N. Y.	2581	212
Woodhill Homes Project	Cleveland, Ohio	568	423
Vineyard Hill Project	Wheeling, W. Va.	302	1252
Prospect Hill Housing Project	Pawtucket, R. I.	310	267
Ordnance Plant Houses	Charleston, Ind.	36	440
Newfoundland Base	Newfoundland	80	600
Home Building Corp.	Kansas City, Mo.	800	110
Colonial Hills & Dales Housing	Columbus, Ohio	200	20
Army Staff Residences	Crab Orchard, Ill.	15	138
Lone Star Ordnance Plant Houses	Leary, Texas	60	240
Parklabrea Housing	Los Angeles, Cal.	2649	135
St. Charles Apartments	Silver Springs, Md.	77	250
Cartridge Loading Plant Houses	Alton, Ill.	50	346
Wills Homes, Inc.	Dayton, Ohio	10	397
Seminary Heights Project	Arlington, Va.	3550	160
First National Development Co.	Chicago, Ill.	30	1703
Parkmerced Housing	San Francisco, Cal.	2394	200
Gulf Port Mortgage Co.	Galena Park, Texas	39	727
			50
			1287
			105
			293

In a few short years, more than 33,000 Kitchen Maid kitchens have been sold for housing projects of practically all types—everywhere. This exceptional experience in advanced cabinetry design and low cost composite construction should be of great value to you on any war housing job. It's yours for the asking. Just write *The Kitchen Maid Corp., 636 Snowden Street, Andrews, Indiana.*



THE RECORD REPORTS

(continued from page 102)

Colman, Crane, C. F. Church, Revere Copper & Brass, Bryant Electric, U. S. Gypsum, Owens-Illinois, Libby-Owens-Ford, Pittsburgh Plate Glass, General Electric, Cutler-Hammer and Servel.

SUMMER COURSES

Lowthorpe School at Groton, Mass., announces a four week summer course in Design and Freehand Drawing, to be given by Josef Albers from June 21 to July 16. Mr. Albers taught at the Bauhaus in Berlin from 1923 until its closing in 1933. Since then he has been Professor of Art at Black Mountain College and has lectured at the Graduate School of Design, Harvard University.

Mr. Albers' course will cover basic exercises in design and drawing, leading to an appreciation of the functional qualities of form and space relationships.

The 12 weeks Summer Term of the School of Design in Chicago, from May 24 to August 7, is offering an intensified program in pace with wartime and postwar requirements. Day and evening courses include Camouflage, Mechanical Drawing and Drafting, Blue Print Reading, Production Illustration and Industrial Design.

A separate 6 weeks Summer Session will be held from June 21 to August 1 in Chicago and at the School Farm at Somonauk, Ill.

PAN AMERICAN ARCHITECTURAL COMPETITION

The Ministry of Public Works and Communications of Ecuador announces an architectural competition for the selection of a design for a new Legislative Palace to be erected in Quito. Total cost of the structure shall not exceed 15,000,000 Ecuadorean sucres, equivalent to approximately \$1,000,000 U. S. currency.

The competition will be divided into two stages, the first of which will close October 1, on which date competitors will be required to deposit their drawings with the Director General of Public Works in Quito. From these drawings five will be selected, the authors of which will be invited to participate in the second stage, in which the awards will be made.

Complete details of the competition may be obtained from the Pan American Union, Washington, D. C.

CHRISTMAS CARD COMPETITION

A national competition designed to create "a collection of pictures which will reflect, for our own times, the eternal and universal symbols of Christmas," is being sponsored by Artists for Victory, Inc. in cooperation with American Artists Group, Inc. Twelve prizes totalling \$1,000 will be awarded. All prize-winning pictures will become the property of the American Artists Group, Inc. and will be reproduced as Christmas cards. All pictures accepted by the Jury, whether prize winners or not, will be shown in exhibitions throughout the country.

The competition is open to all artists and designers regardless of their affiliation with any organized group. Entries must be received on or before July 1, 1943, and should be sent prepaid to Artists for Victory Christmas Card Competition, 106 Seventh Avenue, New York City.

GRADUAL CONTROL

has been an outstanding feature of Powers regulation since 1891. With this type of control, valves or dampers are opened or closed gradually, which results in exceedingly close regulation and the maximum of comfort obtainable with automatic control.

● THE POWERS REGULATOR CO., 275 Greenview Ave., Chicago—231 E. 46th St., New York. Offices in 47 Cities. 43

WRITE FOR BULLETIN NO. 200

POWERS TEMPERATURE and HUMIDITY CONTROL

No matter how long deferred **VICTORY** will mean **BUILDING**



When you are
ready to plan
and to build

**FITZGIBBONS
STEEL BOILERS and
AIR CONDITIONERS**

will be ready
to serve you

It may be grim years away, it may be closer than we dare hope... but before the echoes of Victory celebrations have died, thousands of potential home owners will be talking of new homes. Then, as now, "Heat by Fitzgibbons" will be a standard of excellence, a mark of quality in the homes you plan and build.

FITZGIBBONS

Fitzgibbons Boiler Company, Inc.

101 PARK AVENUE, NEW YORK, N. Y. WORKS: OSWEGO, N. Y.
OFFICES IN PRINCIPAL CITIES

BUY U. S.
WAR BONDS
and STAMPS



REQUIRED READING

By ELISABETH COIT, AIA

(continued from page 30)

EARLY TOWN PLANNING IN NEW YORK STATE. By Turpin C. Bannister. New York History, Cooperstown, N. Y., April, 1943. pp. 185-195. illus.

A STUDY, by the editor of the American Society of Architectural Historians' Journal, of the foundations and growth of a number of New York State communities during the Colonial and early Republican periods, showing differences in the character of the

town (quite independent of the highly differentiated styles of building) resulting from Dutch, English, New England and other influences: the Dutch compact plan with flexible craftsmanship, non-geometrical order and an air of intimacy and comfort; the many towns modelled on Philadelphia's checkerboard with a central communal open space (a design based

on John Evelyn's rejected plan for rebuilding London after 1666); the prim layout of Hudson, colonized by New Englanders and glorified with a "parade" designed for enjoyment of river views and Catskill sunsets; radiation as a variant of the gridiron pattern at Buffalo under Joseph Elliott, a brother of L'Enfant's successor at Washington; the gracious and spacious 18th Century design by a Frenchman for Manhattan, a design lost in the gridiron pattern of 1811.

PREFABRICATED HOMES. New York, (114 East 32nd St.), April, 1943. 32 pp., illus. \$2.00 a year.

THE FIRST number of a monthly, edited by Eugene Clute, and containing articles by Robert L. Davidson, director of the John B. Pierce Foundation's research; by Foster Gunnison, president of the Gunnison Housing Corp.; and by Robert W. McLaughlin, chairman of American Homes, Inc., as well as notes on materials, prefabrication methods, etc. Hail, Little Brother!

ARCHITECTURE AFTER THE PEACE. By Joseph Hudnut. Magazine of Art, Washington, D. C. (Barr Building), April, 1943. pp. 122-127 illus.

THE DEAN of the Harvard Graduate School of Design points out that science and social consciousness will determine the character of future buildings. Science and business are deciding now which new materials and processes will be used by "the building industry;" and architecture must accommodate itself to changes easily foreseen. It is probable that the themes of architecture will become, as they were in the middle ages, collective in character . . . with a dignity which has its source in a service rendered not to individuals but to society. Great Tudor, Colonial and Italianate homes will be used only as refuges for superannuated policemen; the learned world will pursue its thought "in halls unshadowed by majestic towers" in a world recking little of private magnificence, and monumental façades for utilities. Main Street will again become a social center, with grass-planted play areas for children and arcade-shaded sidewalks for social intercourse and for window shopping in stores, automobile access to which will be through service streets.

PLANS AND SPECIFICATIONS FOR MASS FEEDING

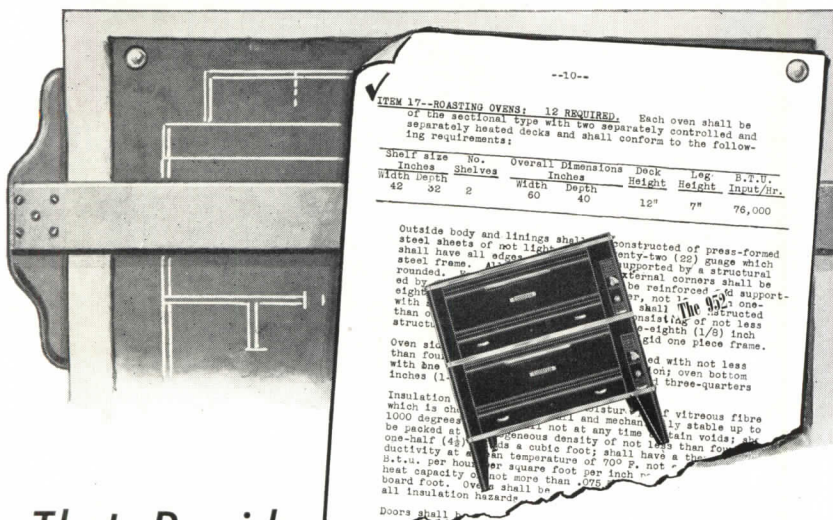

That Provide BLODGETT ROASTING OVENS . . .

PROVIDE ALSO assurance that you have laid out an installation which is modern, which has the safety factor of reserve capacity for the cooking job expected and which is backed by a manufacturer whose reputation is based up-

**42 MODELS OF BAKING
and ROASTING OVENS—
TO MEET ANY NEEDS**

on 95 years of making roasting and baking ovens exclusively.

BLODGETT Roasting and Baking Ovens are designed and engineered for tough usage. They combine large capacity with low floor space. They are noted for easy, trouble-free operation, require a minimum of lifting and handling of foods. They are widely known and used and do not have to be "sold."

ATTENTION, MASS-FEEDING DESIGNERS! Starting next month, Blodgett will present in Architectural Record, a series of successful mass-feeding installations as a service to those responsible for mass-feeding design.

THE G.S. BLODGETT CO., INC.
34 Maple Street, Burlington, Vermont

*The Green Lumber Company
of
Laurel, Mississippi
announces
the completion of its 4,000th
prefabricated dwelling unit
for
men in the armed forces
and workers in America's
vital war industries*

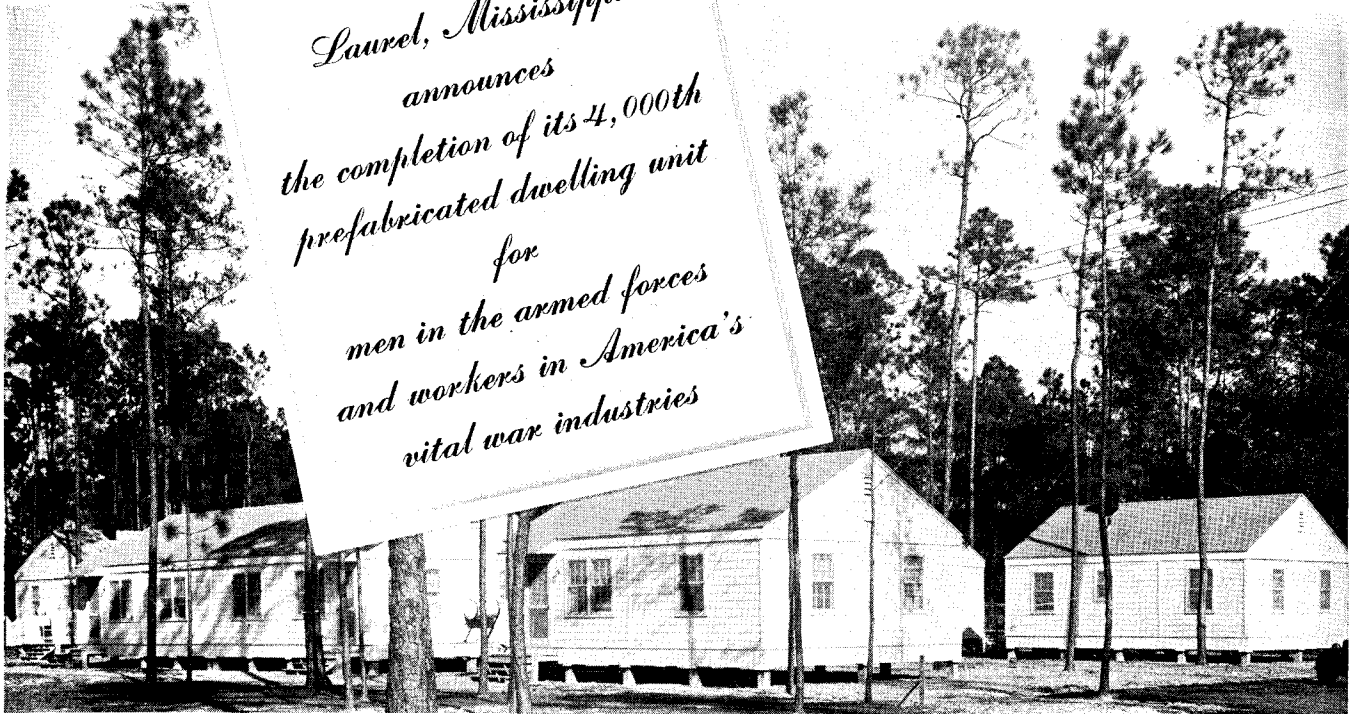

**YOU ENJOY THESE
ADVANTAGES**

when you specify..

**MILWAUKEE
BUILDERS HARDWARE**

You set a high standard on Hardware Fittings when you write in "MILWAUKEE" for all types of building, war housing, public buildings, factories, commercial buildings, as well as training camps and barracks. The MILWAUKEE Line is complete, with hinges, closures, fittings and hardware for practically every type of use—used and recommended for its superiority for many years, by architects, contractors and builders. Use it to YOUR profit!

MILWAUKEE "NU-JAMB"

Double-Acting Spring Hinge
Requires no hanging strip

★ ★

**MILWAUKEE
STAMPING COMPANY**

814-B South 72nd Street
Milwaukee, Wisconsin

- Attractive Styling
- Easier Installation
- Longer Service
- Customer Satisfaction
- Correct types and designs for ALL needs

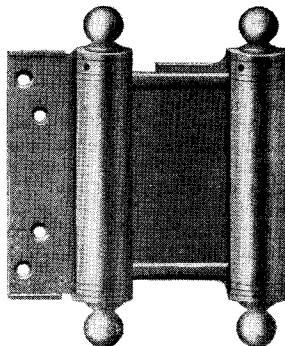

For
UNIT **Widest Hangar Spans**
ALL-GLUED LAMINATED Arches

Pre-war Northwestern Airlines hangar. "Unit" segment arches used with 2" D & M Sheathing.

**Cost Less Than Any
Other Type of Construction**

... based on recent comparisons. Safety factors, fire resistance are amazing to those accustomed to conventional materials. Practical for spans of 200 feet and over. Proved by years of pre-war experience that assure you of creditable results. Prompt deliveries, fast erection. Engineering service available. Write, phone or wire *Unit Structures Inc., Peshtigo, Wis.* Plants at Peshtigo and at Sayville, L. I., N. Y.



Copyright 1943, Unit Structures, Inc.

MINERAL WOOL... on the job for Uncle Sam



... helping to Save Fuel for War Needs

THE MILLION TONS of *Mineral Wool* now installed in American homes is already saving tremendous quantities of fuel (and therefore, transportation) for war work.

In 1943, the industry will produce enough wool to save 270,000,000 gallons of fuel oil, or the equivalent in other fuel.

Fuel is "ammunition", and must be saved. The U. S. Government has launched a campaign, urging insulation *NOW*... this spring and summer... when labor and materials are available.

* * *

To encourage insulation NOW... FHA will insure loans with first payment deferred until November first.

* * *

For maximum fuel saving (and year round comfort) ceiling and walls should be blanketed with full-thick mineral wool, or equivalent.

Architects can cooperate with the Government and all allied industries, by urging their large as well as small clients to act now.

NATIONAL MINERAL WOOL ASSOCIATION

1270 Sixth Avenue New York, N. Y.

3 "MUSTS" FOR PENCIL USERS

Pencil Craftsmen — be they Engineers or Architects, Designers or Draftsmen — demand 3 basic qualities in drawing pencils:

1. Featherlight smoothness
2. Rich uniformity of tone
3. Freedom from point breakage

WINNER *Techno-TONE* drawing pencil contains specially milled and refined graphite which puts it high on the preference list of professional pencil users. Yes, it costs a few pennies more, but what true craftsman would let that stand in his way! We'll gladly send you a sample of your favorite degree.

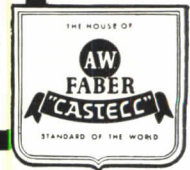

WINNER
Techno-TONE
DRAWING PENCIL

America's Standard of Drawing Pencil Excellence

A·W·FABER·Inc. NEWARK, N. J.

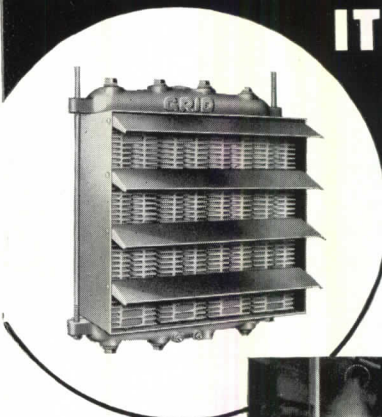

IT'S STILL A Different UNIT HEATER

Grid Unit Heater is now made with Cast Iron heating sections to cooperate with the war effort. Patent applied for.

The cast iron Grid Unit Heater is engineered and designed to operate with either steam or hot water — for steam pressures from 2 lb. to 250 lbs. No electrolysis to cause corrosion as only one type metal is in contact with steam or hot water. Easy to keep clean... nothing in atmosphere can plug up its heating sections... built to outlast other types of heating equipment... no maintenance cost. Ask for new catalog information and capacity tables.

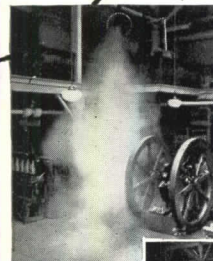

Grid Unit Heaters deliver warm air to the floor line — proof in these views.

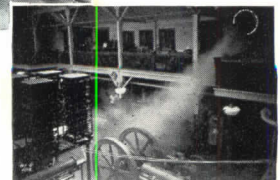

D. J. MURRAY MFG. CO., Wausau, Wis.
Offices in Principal Cities.

GRID UNIT HEATER

POST-WAR HOUSING

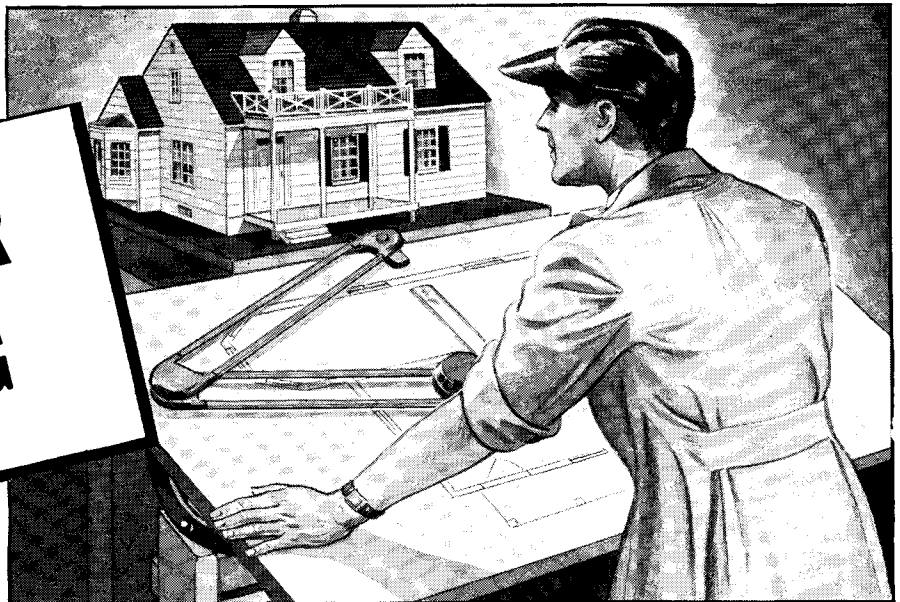

Designed for your new markets

Low-cost housing will be a large part of the residential building industry's post-war volume. In successful low-cost housing the architect's design considers each part that goes into the house from the standpoint of (1) waste, and (2) that part's relationship to every other part of the structure.

In successful homes of all price classes, the architect's design expresses his creative knowledge of the needs and tastes of his community.

For these reasons it is essential that a system of construction allow the architect complete flexibility of design. At the same time, the system must possess a high degree of manufacturing efficiency, produce a structurally sound house.

Engineered housing is the answer. Partly because it is decentralized prefabrication, engineered housing encourages freedom of design.

Engineered housing

For seven years and at a research outlay of \$300,000, Homasote Company has been applying sound engineering principles to the problem of building a home. Homasote's purpose: to help the architect who specifies Homasote Building and Insulating Board sell more and better houses, profitably.

Result of this exhaustive research is Homasote Precision-Built Construction—a system which:

(1) enables the architect to incorporate all the engineering economies of prefabrication into the homes he designs;

(2) is based on the use of Homasote Board—oldest and strongest building and insulating board on the market—and other standard materials readily available in the local area;

(3) insures the architect's reputation against identification with jerry-building;

(4) saves the architect's detailing time—thereby increasing his productivity—by providing complete charts and reference tables;

(5) is adaptable to any architect's design, with no change in a single overall dimension greater than two inches.

\$36,000,000 experience

The soundness of Homasote Precision-Built Construction has been proved in \$6,000,000 worth of pre-war, architect-designed, private homes erected in every part of the country—and \$30,000,000 worth of government housing.

To the foresighted architect, Homasote Precision-Built Construction is the key to vast, post-emergency markets: low-cost housing projects, large realty developments, machine-perfect homes in all price classes.

For more details, write HOMASOTE COMPANY, Trenton, New Jersey

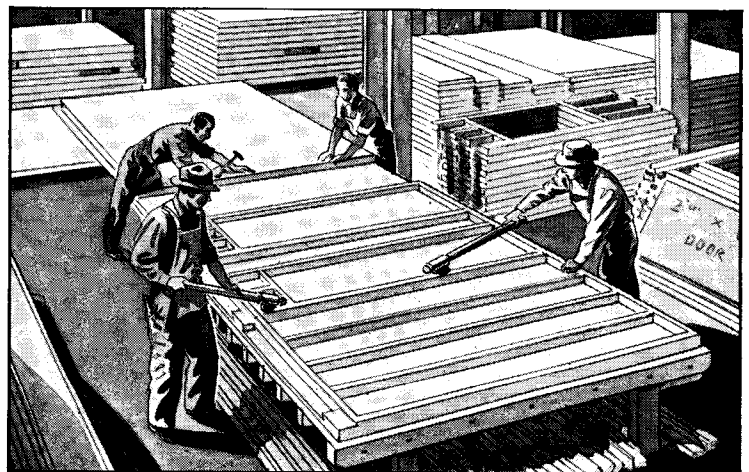

HOMASOTE

Precision-Built

HOMES

"FORD FACTORY BUILT" poultry houses and small farm buildings HAVE GONE TO WAR!!

We urgently need

**LUMBER DEALERS,
MILLWORK CONCERNS,
MANUFACTURERS** with idle plant capacity and woodworking machinery to assist in manufacturing these buildings to take care of our large volume of orders—

We can put you in the "small war building" prefabrication business at once and load your plant with orders as soon as you say the word—you will have no selling expense—we take care of that nationally and locally, too. Right now we are swamped with orders for poultry houses, and other small farm buildings, tool houses, etc. All priority orders.

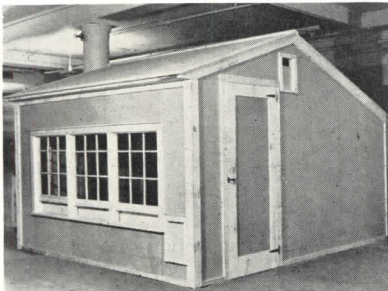

FORD'S POPULAR SIZE POULTRY HOUSE—dimensions 10' x 12', complete with nest and roosts, in tremendous demand this year.



Ford Double Construction Homes. A practical, economical method. FHA approved construction is a major item to consider for war housing or postwar projects.

You can establish your company in factory prefabrication now with a minimum of capital investment using the successful Ford system of shop assembly which requires no expensive handlings equipment. We furnish blue prints and other details, as well as assist in shop layout and production, under the personal supervision of Ivon R. Ford, prominent New York State lumber dealer and manufacturer, who places at your disposal his years of successful prefabricating experience.

Never before have you had such an opportunity—so move quick! Write or wire today. You can be shipping orders within three or four weeks and keep profitably busy for the duration.

Once established with the "Ford Factory-Built" System of manufacturing and distribution, you will be all set to meet any kind of conventional or prefabrication competition in the big Post War Market.

IVON R. FORD LUMBER CO. McDonough
National distributors: New York
Adirondack Co., 142 E. 45th St., New York City

Fresh Air Is SURE with "ALLEN'S"

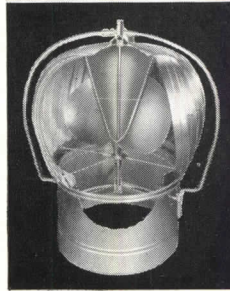

**A
TYPE
FOR
EVERY
NEED**



Perfect ventilation is a war-production "must." Let Allen ventilation engineers report on your needs and recommend the most suitable type of equipment. Allen provides wide choice—famous self-operating Coni-Vane Turbines; Electro-Wind Coni-Vane with auxiliary power; Stationary types of various forms. Let ALLENS clear the atmosphere for maximum production.

Send today for fully descriptive and illustrated catalog. Wire or telephone if urgent. Representatives in most principal cities.

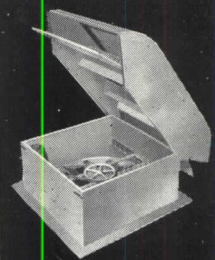

The ALLEN Corporation

9761 Erwin Ave. • Detroit, Michigan



**SYMBOL OF QUALITY
IN WIRING DEVICES AND
CONTROL APPARATUS**

for 53 years

Available now for dependable control of light, heat and power if ordered with proper priorities . . . Send for current Catalogs for war service installations.

HART & HEGEMAN DIVISION
ARROW-HART & HEGEMAN ELECTRIC COMPANY, HARTFORD, CONN.

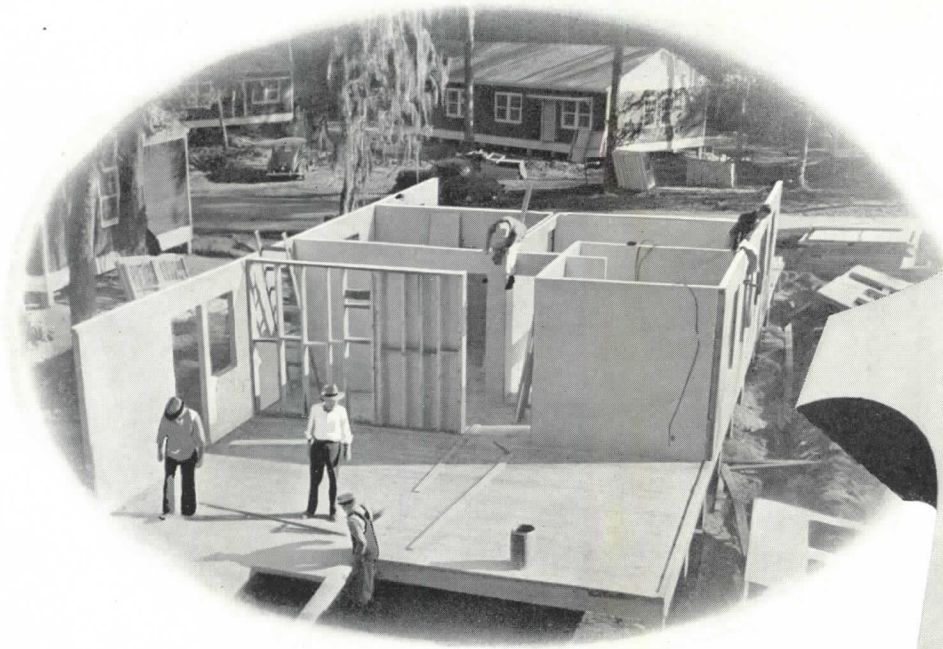

Dry-built full-wall construction, provided by Strong-Bilt Panels, is adaptable to all types of prefabrication. Successfully used in many thousands of housing units.

Strong-Bilt Panels are better adapted for prefabrication, we believe, than any other material providing full wall construction

WE HAVE WORKED closely with many manufacturers of prefabricated houses as well as hundreds of architects and contractors planning and building by conventional methods. Our experience in this advanced type of interior wall construction is available to all who are planning for immediate or postwar requirements. We welcome the opportunity of discussing the features of Strong-Bilt Panels with any architect, builder or house manufacturer not familiar with their advantages. Write The Upson Company, Lockport, New York.

Upson Quality Products
Are Easily Identified
by The Famous
Blue-Center

THE CRACKPROOF BEAUTY SURFACE
FOR WALLS AND CEILINGS



**UPSON
STRONG-BILT
PANELS**



AMERICAN PENCIL CO. NEW YORK - VENUS - DRAWING - HB

"OUR POST-WAR PLANNING DEPARTMENT"

For war-time plans or post-war planning, more draftsmen, architects and engineers like and use the Venus Drawing Pencil than any other make.

They know they can rely on the strength and smoothness of Venus Drawing. They know that each degree of hardness is exact and unvarying—whenever and wherever they buy.



Here's your chance to find out for yourself why Venus Drawing is the tops. Just mail us the coupon below—circling the two degrees you would like to try—and we will gladly send you free samples.

VENUS Drawing PENCILS

American Pencil Company
 Dept. 144, 500 Willow Ave., Hoboken, N. J.
 In Canada: Venus Pencil Company, Ltd., Toronto

Please send FREE samples of the two grades circled:
 9H - 8H - 7H - 6H - 5H - 4H - 3H - 2H - H - F - HB - B - 2B - 3B - 4B - 5B - 6B

NAME and title _____

FIRM NAME _____

ADDRESS _____

CITY _____ STATE _____

...QUARTER-CENTURY Prefabricating experience

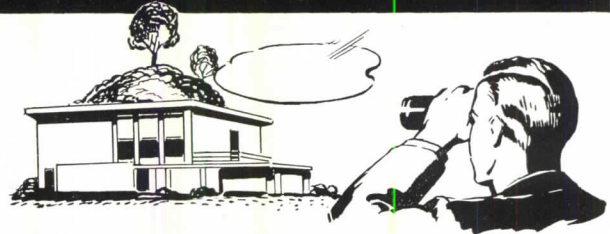

THE LONG-HAUL VIEW

Houston Ready-Cut House Company takes the long-haul view—what is happening now to win VICTORY will make life richer and finer when peace is won. The new precisions—materials—techniques that come out of this war will be used by Houston Ready-Cut. Our plant, which has built 10,000 homes in 25 years, is now in full production, serving industry in its war requirements; after VICTORY we'll be on the alert to serve again civilian needs.

Buy a home in the peace to follow—
 with the Bonds you buy today.

WORKING NOW FOR U. S. BUT LATER FOR YOU

HOUSTON Ready-Cut HOUSE CO.
25 years Prefabricating Houses
 POLK AVENUE HOUSTON, TEXAS

1944?

We'll be ready

Out of the experience in providing military needs are coming revolutionary developments in Automatic Control.

MINNEAPOLIS HONEYWELL
 CONTROL *Systems*

**NO CRITICAL
METALS IN
THIS FLASHING!**

**Time-tested Johns-Manville
Asbestile Flashing
gives extra protection at
the points where most
roof troubles start**



HERE IS A FLASHING SYSTEM that permits your clients to make necessary repairs to existing built-up roofs . . . even to apply a complete new roof with flashings . . . without the use of any critical metals.

It's the J-M Asbestile Flashing system . . . proved for years in actual service . . . called by many experienced roofing contractors "the foolproof flashing."

The flashing felts used are basically the same as the asbestos felts used in the well-known Johns-Manville Smooth-Surfaced Asbestos Roofs. They are fireproof and rotproof.

The waterproofing or cementing agent employed is J-M Asbestile . . . a heavy-bodied, plastic material composed of asbestos fibers, asphalt and other mineral ingredients. After application, Asbestile hardens, and becomes an integral part of the wall itself!

This means maximum assurance against leakage . . . extra protection for the building structure and for the equipment under the roof!

For details on J-M Asbestile Flashing and J-M Asbestos Roofs, write for a copy of the 48-page book, "Things You Should Know About Your Roof." Johns-Manville, 22 East 40th St., New York.

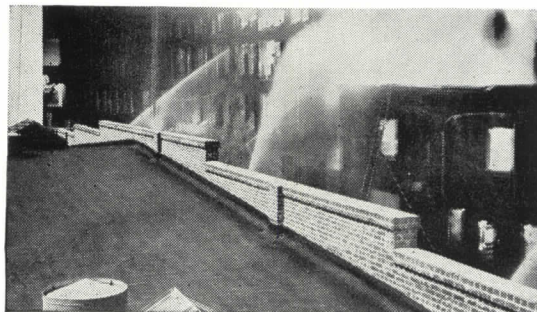

And be sure you specify a FIRE-SAFE roof!

That means a roof that cannot burn . . . a J-M Asbestos Roof. Many buildings, threatened by outside fires, have been saved by just such roofs. And J-M Roofs are rotproof . . . need no periodic coating against the drying-out action of the sun.

Johns-Manville

Asbestos

Built-Up Roofs



MODERNIZED AFTER 35 YEARS...



BUT REWIRED WITH THE ORIGINAL OKONITE CABLE

• In 1907 the Chicago & Northwestern Railroad wired its then new office building with Okonite cable. Recently the building was modernized and the original cable was found to be in such good condition that it was reinstalled in all the circuits. The conductor tinning was in excellent shape, with no bare copper visible, and the insulation was in very good condition. The wire insulation, after 35 years' use, was flexible and could be bent upon itself without cracking or injury. The braids over the conductors, as well as the outside braid, were strong and well saturated.

The Chicago & Northwestern Railroad, in selecting Okonite more than 35 years ago, is now benefiting by using it again at a time when it also contributes to our country's war effort in the conservation of critical war materials. Good wiring—Okonite wiring—pays. And in this instance it paid twice... The Okonite Company, Passaic, New Jersey. Offices in principal cities.

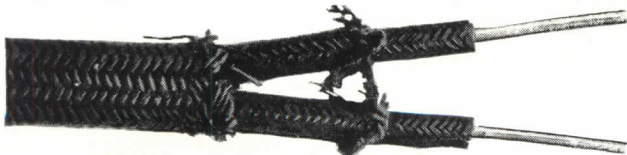

Un-retouched cut-back section of #12 twin conductor Okonite wire removed from the Chicago & Northwestern office building after 35 years' use. Note its excellent condition. 3317

OKONITE

INSULATED  WIRES & CABLES

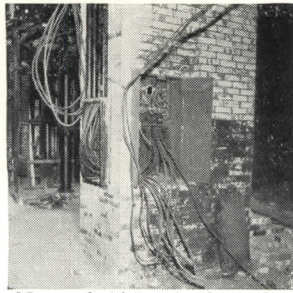

New and old junction boxes for the riser cables are side by side. "This building had an unusual first-class job of old-fashioned wiring and as a result we were able to use a good deal of it," said the electrical contractor.

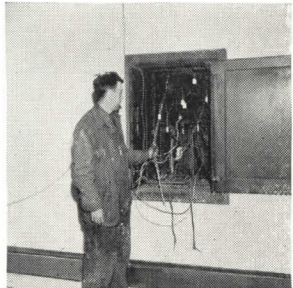

Each end of each floor has a panel. Receptacles, switches and plugs are new but the lighting circuits are mostly old. (90% of the old circuits with #12 wire were reused). The outlets were increased three for one.

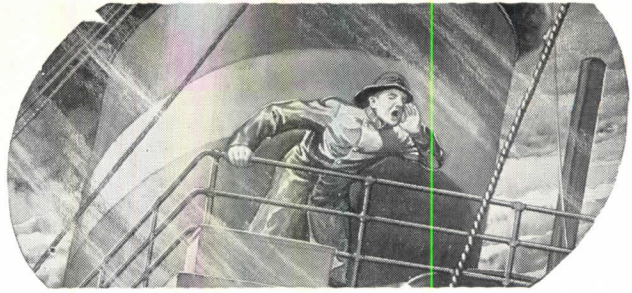

UNHERALDED HEROES!

Our compliments to the men of the Merchant Marine. We are proud that the ships they man are equipped with Jamison Cold Storage Doors.

Uncle Sam's fleets are now getting the best that our 50 years' experience can provide.

When Victory comes, the best will be yours.

Today, for service suggestions to increase the life of your doors consult our nearest branch, or address

JAMISON COLD STORAGE DOOR CO.

Jamison, Stevenson and Victor Doors

HAGERSTOWN

MARYLAND

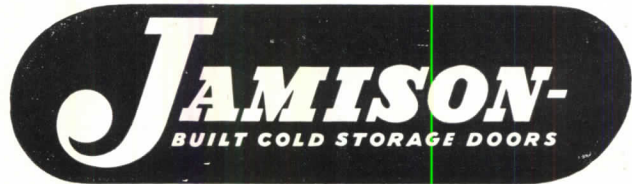

See our catalog in Sweet's Catalog File

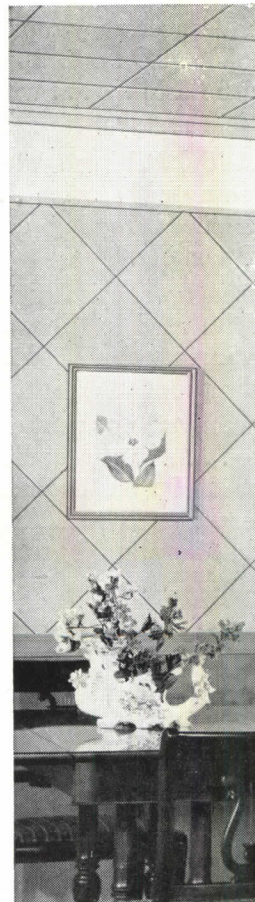

NU-Wood INSULATING *Interior Finish*

DECORATES . . . fadeproof colors . . . unique texture . . . the most beautiful insulating interior finish.

INSULATES . . . helps save fuel . . . provides added comfort.

QUIETS . . . creates a restful atmosphere—helps bring refreshing sleep.

BUILDS . . . permits low-cost subdividing of existing dwelling space . . . makes homes more useful.

For full information, write

WOOD CONVERSION COMPANY

Dept. 115-6, St. Paul, Minnesota

Gunnison Homes

A NATIONAL INSTITUTION

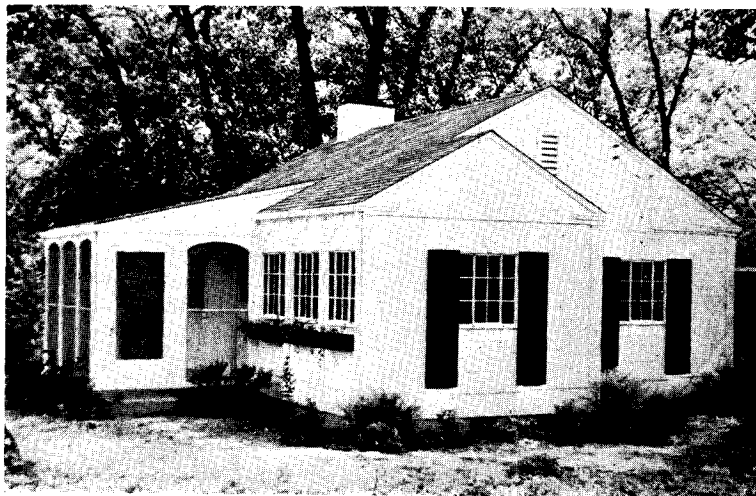

Typical 4 room Gunnison Home occupied by war workers in many Defense Areas.

PRESS A BUTTON GET A HOME

Everyone who has ever been interested in Prefabricated Homes has always dreamed of the day when one could press a button, start conveyors moving, and then see homes pour out just like automobiles come off an assembly line. That dream has been accomplished at the Gunnison plant. For months the nation's leading industrialists have been coming to see this mechanical marvel, the first and only one in this great new industry.

We are producing one, two and three bedroom houses both right and left hand plans. You can step into our plant, choose the size and plan of home you want, press a button, and then in 25 minutes see your finished home come off the assembly lines. It is all done by highly specialized machines and power driven conveyors. You see the whole operation from raw lumber and raw plywood right on through to the finished product. Floor panels, walls, ceilings, roofs, gable ends all come off separate conveyors carefully synchronized so that your whole home arrives at the shipping dock as a complete package. As the conveyors move past the workers, all frames are assembled, insulation installed, surfacing materials applied as well as exterior and interior finishes, doors and hardware are hung and also windows and screens. All day long a home comes off the line every 25 minutes, without noise, fuss or confusion of any kind.

After the War, our National Dealer Organization will be rapidly expanded along the most streamlined methods for mass-selling. If you are experienced in specialty selling, have a sound business and financial record and are interested in becoming a Gunnison Dealer, we shall be pleased to send, free, our booklet, "After Victory — Satisfy Your Ambition."

GUNNISON HOUSING CORP.
New Albany, Ind.

© 1943

Rely upon

MADE IN U.S.A. L. & C. HARDTMUTH, INC. "KOH-I-NOOR" #1500

KOH-I-NOOR

Ask the first Koh-I-Noor pencil user you meet, and then ask a hundred more, and you will get the same unfailing answer, "Koh-I-Noor can be relied upon to give you definite protection from all lead pencil troubles."

Throughout the fifty-odd years the Koh-I-Noor pencil has been on the market, we have, through constant research, painstaking effort and strict adherence to material specifications, supplied critical users with a drawing instrument of superlative quality.

Rely upon Koh-I-Noor.

#1700 TECHNICAL CRAYON PENCILS with small diameter lead, slightly soluble in water, are manufactured in 40 colors.

SEND FOR FREE CATALOG NO. 3

KOH-I-NOOR
 PENCIL COMPANY INC.
 373 FOURTH AVENUE • NEW YORK

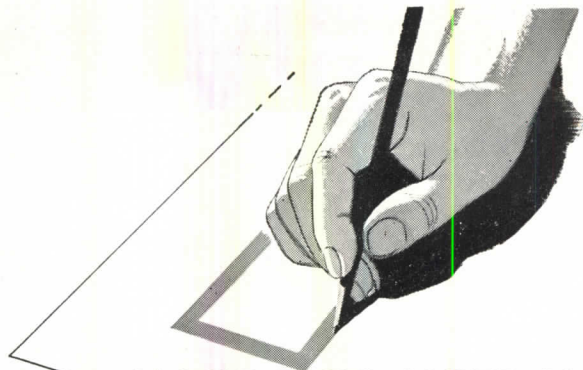

**MAKE THIS NOTE NOW
 ON POST-WAR WINDOWS**

In post-war housing, the accent will be on *windows*. Better windows—more weather-tight, more beautiful—and made of WOOD. Windows that operate more efficiently throughout a long life of service. Windows that permit the architect wide latitude in creating greater individuality. Curtis research is at work to give you and your clients more window value. We'll gladly provide literature that can aid you in planning windows for post-war houses. Write us—there's no obligation, of course!

CURTIS COMPANIES SERVICE BUREAU

Dept. AR-6R, Curtis Building, Clinton, Iowa

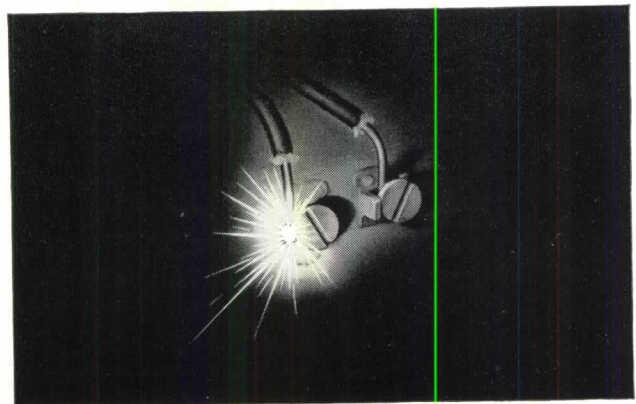

How Far Will It Reach?

Throughout your plant, the hand of fire lies always waiting to destroy war-essential buildings, machinery and materials. It's vital to eliminate all hide-outs, such as loose electrical connections, faulty flues, greasy refuse, dirty, oily motors and other unnoticed hazards.

There's only one sure way to block fire *completely*. Cover every corner of your plant with

Sprinkler Fire Protection that will *stop fire at its source!*

Grinnell Systems are engineered and prefabricated to meet your special requirements, by the leader in sprinkler fire protection. Call in a nearby Grinnell engineer for advice. Grinnell Company, Inc., Executive Offices, Providence, Rhode Island. Branch offices in principal cities.

GRINNELL
 Automatic Sprinkler Fire Protection



...stove.
 ...basement includes vegetable storage, electric
 room, laundry, tubs, washing machine, electric
 with s
 walls
 with
 baser
 room
 iron

NOT FOR SALE

Beautiful home, facing lake, five rooms and bath, full basement, air conditioned, water softener, automatic hot water heat, heatilator fireplace, Masonite exterior and interior, Cell-U-Blanket insulation, living room 14' x 25' with solid walnut paneling, kitchen and bath walls in two tone Marlite, kitchen equipped with electric stove, refrigerator, mix-master, basement includes vegetable storage, recreation room, laundry, tubs, washing machine, electric ironer, clothes dryer, and workshop. This is a prefabricated house, one of eight designs that can be erected in a day and ready to live in within ten. But due to the fact that our plant is occupied 100% on war work we cannot offer this home for sale. After the war we hope to be able to sell such houses and give the people a means of enjoying the peace that we are today working and fighting for.

the
 live
 our
 can
 we
 give
 that
 basement
 room, l
 ironer.
 a pr
 that
 the

...with solid walnut paneling, kitchen and bath
 ...in two tone Marlite, E...
 ...

GENERAL FABRICATORS, INC.

ATTICA, INDIANA

BOOKS

DESIGN OF MODERN INTERIORS

by James Ford and Katherine Morrow Ford

The first comprehensive survey of recent American interior design, exclusively in terms of modern architecture and related arts. Analyzes the latest advance in modern custom design—shows how to apply to defense housing—discusses best placement for circulation, privacy, comfort, safety, storage, and general convenience. Explains choice of colors, materials, designs, etc. 324 illustrations. 132 pages. 124 architects and designers represented. 8½ x 10¾. Cloth bound. \$5.00.

BETTER HOUSES FOR BUDGETEERS

by Royal Barry Wills

104 pages. 9 x 12¼ in. 102 illustrations and plans. Price \$3.00.

WORKING DETAILS, PART I: DOMESTIC

(British Publication) Edited by Mildred W. White

Illustrates by photos and detail drawings handling by various internationally known architects of such details as windows, doors, staircases, kitchens, furniture, fireplaces, etc. 140 pages. 9 x 12½. Price \$4.00.

THE MODERN HOUSE

by F. R. S. Yorke (published in England)

Photographs, plans, construction details and technical descriptions of English, American and Continental houses. Over 500 illustrations. 150 pages, 10 x 7½. —\$6.00.

GUIDE TO STANDARD SPECIFICATIONS

by Harold Sleeper, AIA

Federal specifications in the construction field—with notes on their use. Arranged by trades in twenty-three divisions. A time and labor saver for specification writers. 28 pages—8½x11—75c.

THE RESTORATION OF COLONIAL WILLIAMSBURG

A pictorial survey including floor plans, elevations, details, maps and garden plans, samples of paint colors, etc. Textual story by the Restoration architects and designers. 104 pages, 9x12, blue cloth covers, \$1.50.

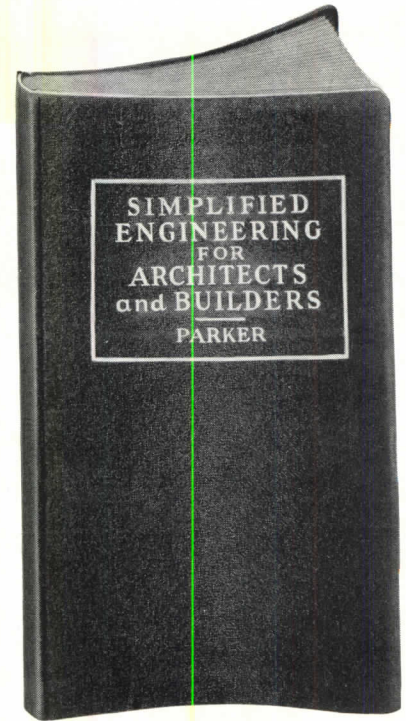

SIMPLIFIED ENGINEERING

FOR ARCHITECTS AND BUILDERS

By HARRY PARKER, Professor of Architectural Construction, University of Pennsylvania

Presents the design of beams, columns, slabs, etc., so simply, so concisely, that you can readily follow the explanations without previous training in the subject. Brings to your fingertips the important terms and basic principles employed in the design of structural members in building construction—with a host of examples illustrating just the sort of problems that must be faced in practice. No preliminary knowledge of the subject required. Theory and derivation of formulas reduced to a minimum. All necessary tables are included, no other books required to supplement its use. 214 pages—96 illustrations—flexible binding—\$2.75.

Any of the above books will be mailed postpaid anywhere in the United States. Send your order and payment direct to

ARCHITECTURAL RECORD BOOK DEPT. 119 WEST 40TH STREET NEW YORK, N. Y.

Architectural Record Book Department

119 W. 40th St., New York

Please send books checked.

Money order or check for
\$..... enclosed.

Name

Address

CityState AR-643

- Design of Modern Interiors ... \$5.00
- Better Houses for Budgeteers.. 3.00
- Working Details, Part I: 4.00
- The Modern House 6.00
- Guide to Standard Specifications .75
- The Restoration of Colonial Williamsburg 1.50
- Simplified Engineering for Architects and Builders 2.75

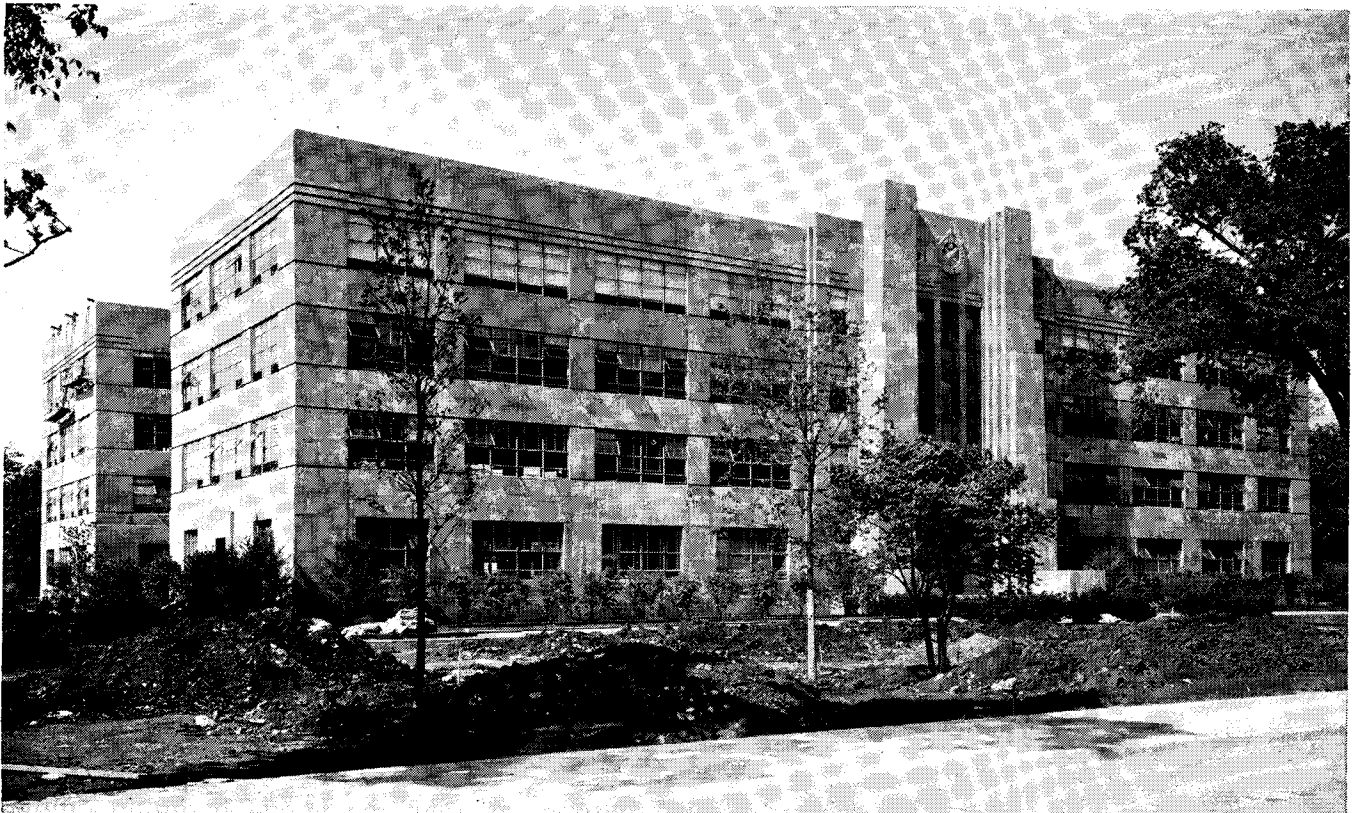

CONCRETE

HAS WHAT IT TAKES FOR WAR CONSTRUCTION

FOR EXAMPLE . . .

A Modern Arsenal

Concrete construction in which walls are integral with framing, floors, and roofs has the rugged strength and fire resistance essential to war buildings.

1. Concrete saves steel.
2. Transportation facilities are conserved, since the bulk of concrete materials are usually found locally.
3. Construction is expedited by improved methods, easily accessible materials, local labor.
4. Architectural distinction is easily obtained by interesting textures and simple decorative effects produced economically in the forms.



All-concrete Administration Building of arsenal in middle west. Designed by U. S. Engineer Office. Priester Const. Co., Davenport, Iowa, contractor.

Basement area of heavy ordnance building. T. S. Willis, Janesville, Wis., and Priester Const. Co., contractors.

To help get the maximum service which Architectural Concrete can render, the Portland Cement Association's staff of skilled concrete technicians is available to assist designers and builders of war structures. Ask for this service.

PORTLAND CEMENT ASSOCIATION, Dept. A6-8, 33 W. Grand Ave., Chicago, Ill.

A national organization to improve and extend the uses of concrete . . . through scientific research and engineering field work

BUY MORE WAR BONDS AND SUPPORT THE RED CROSS

PREFABRICATION PLUS

Army-Navy Barracks

Houses

Mess Halls

Gun Towers

Office Buildings

Airplane Hangars

Observation Towers

Designs prepared to fill your needs.

Plants located throughout the entire United States

THE TRAVELODGE CORPORATION LYNCHBURG, VIRGINIA

New York Office: 307 Fifth Avenue

Tulsa, Oklahoma Office:
2630 South Trenton St., Tulsa, Okla.

TIME-SAVER STANDARDS IN BOOK FORM

For the benefit of subscribers to ARCHITECTURAL RECORD. Time-Saver Standards published from October 1940 to March 1942 inclusive have been reprinted as a 96-page book. Each of the 53 subjects is generously illustrated with detailed line drawings and diagrams.

Take the subject of "Plumbing Systems for Low-Cost Housing": in six pages are shown diagrams of water supply piping for a one-story house, for a two-story house, and for a two story flat. There are 12 diagrams (plus definitions) of drainage and vent piping installation. There are tables of sizes of fixture branches and other outlets, air gaps, water heater capacities, minimum sizes of traps, drains, etc. in addition to explanatory text. Equally valuable are the standards for design of

FACTORIES
BATH HOUSES
BUS TERMINALS
FIRE HOUSES
JAILS

HOSPITALS
STADIA
SHOW WINDOWS
CLASS ROOMS
COMMUNITY BUILDINGS

Thousands of architects, engineers, and draftsmen make use of AR Time-Saver Standards. Those who have not accumulated the Standards already published can still secure a copy of them in this convenient book form, by subscribing to ARCHITECTURAL RECORD. The price of a one-year subscription in combination with the book is \$3.75.

Order today. (Money back if not satisfied)

Architectural Record
119 West 40th Street, New York

The New Laboratories

of G. D. Searle & Co., Skokie, Ill.

Manufacturing Chemists, were—

- **DESIGNED**
with Kewaunee Skill
- **PROVIDED**
with Kewaunee Conveniences
- **PRODUCED**
with Kewaunee Efficiency
- **INSTALLED**
with Kewaunee Care



C. G. Campbell, President
5046 S. Center St., Adrian, Michigan
Representatives in Principal Cities

*Do you know why
Cabot's Collopakes have
greater hiding power?*



The answer is easy. The pigments in Cabot's Collopakes are reduced to sub-microscopic fineness and colloiddally compounded in the oil, according to the patented Cabot Collopakes process. Pigments and oil do not separate but penetrate into the wood together forming a tough uniform film of greater hiding power, greater covering power—and longer life. That's why today, as in the past, Cabot's Collopakes are widely used by leading architects.



Free *White Book*. Shows many prize winning houses painted with Cabot's Double-White, Old Virginia White and Gloss Collopakes. Contains full information. Write for your copy today. Samuel Cabot, Inc., 1282 Oliver Bldg., Boston, Mass.

CABOT'S
DOUBLE-WHITE
and Gloss Collopakes



Samson Spot Sash Cord

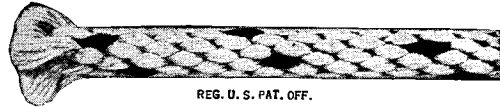

REG. U. S. PAT. OFF.

By specifying and using Samson Spot Cord for hanging windows, with suitable weights and pulleys, you obtain perfect balance by a time-tested method. You also guard against the use of inferior unidentified cord.

Samson Cordage Works, Boston, Mass.



★

FREEDOM
Freedom is a government of, for
and by the people. As Americans,
we inherit it. As a Nation, we
have earned it. Let's preserve it.



Swimming Pool Service

WAR production has very rightly set up priorities which make new W&T equipment for swimming pool chlorination unavailable for the duration, although priorities are obtainable for essential chlorine control apparatus where needed for water supplies, sewage plants and war industries. Meantime the Wallace & Tiernan organization is co-operating with architects and engineers in keeping present installations in top working condition.

Ask us about this service; also for W&T swimming pool technical publications.

WALLACE & TIERNAN CO., INC

Manufacturers of Chlorine and Ammonia Control Apparatus
Newark, New Jersey

Represented in Principal Cities

Where can I get it?

and

When can I get it?

For the men with building jobs to finish *now*, the second question is all important. They will find in the 1943 Sweet's File hundreds of items of building material and equipment which can be had at once — some, of course, with the necessary priority assistance.

Also available now are the services of 172 firms of contractors and engineers whose work and experience are described in detail in the 400-page Section 1, "Contractors and Special Services." These qualifying data will be of tremendous and timely use to all contract awarding authorities.

But one of the most valuable features of this war-time Sweet's File is the inclusion of basic information on the normal products of hundreds of manufacturers who have converted their plants, for the duration, to manufacture war goods. Planners of postwar building projects — projects which will offer immediate employment to thousands of returning service men — will appreciate the foresight of manufacturers who thus make it possible to advance this important work.



Nation-wide **SERVICE** for America's **UNDERWOODS**

TODAY with the rapidly increasing demand for typists and secretaries, it is more important than ever that typewriters be kept in good working condition.

That's why you're fortunate if your machines are Underwoods. In the first place, they are so ruggedly built that they stand up under exceptionally severe use, and in the second place, when maintenance work does become necessary you will find thoroughly trained service representatives operating out of 436 offices located in as many cities from one end of this country to the other. Not only is there an Underwood Branch within reach, but the staffs are large enough to give prompt and adequate service.

UNDERWOOD ELLIOTT FISHER COMPANY
One Park Avenue, New York, N. Y.
Service everywhere through a nation-wide organization

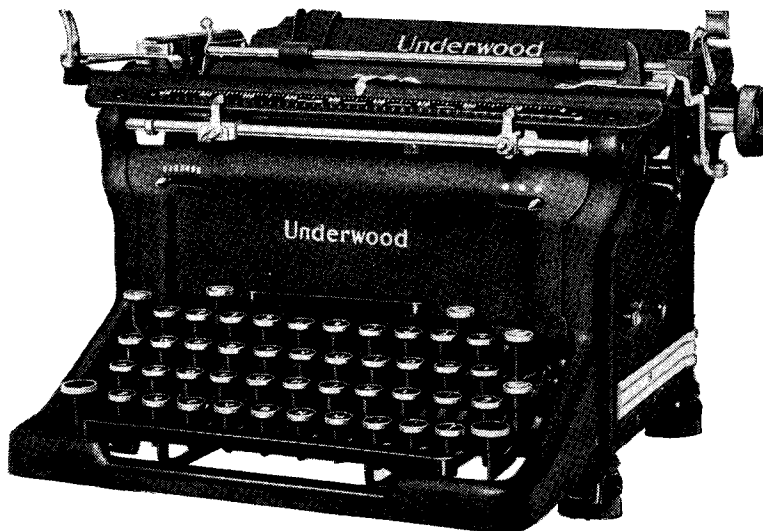

UNDERWOOD *Typewriter Leader of the World*

Why does this man get
61% MORE LIGHT?



Light from floors is the answer. Light-colored floors made with Atlas White portland cement instead of standard gray portland cement or still darker materials increase illumination on vertical work surfaces and undersurfaces. With better illumination, workers see better, spoilage decreases and production increases.

When light strikes a dark floor, most of it is absorbed. It is wasted. When light strikes a light-colored concrete floor made with white cement, much of it is reflected. The light is salvaged. It is used over and over again. Tests by General Electric in the Consolidated Aircraft plant at Fort Worth show that the white-cement floor compared with the gray-cement floor in the same plant—

- ▶ reduces shadows and dark areas;
- ▶ increases illumination on vertical work surfaces by 20%;
- ▶ increases illumination on underside work surfaces by 61%.

Light-colored concrete floors made with Atlas White portland cement help bring the production-speeding advantages of better light. For the complete story, write today for your copy of the new 24-page book, "Light from Floors." Universal Atlas Cement Company (United States Steel Corporation subsidiary), Chrysler Building, New York City.



HOW ABOUT MAINTENANCE?

Experience shows white-cement floors are easy to clean, easy to keep clean, and retain their reflection advantage. Maintenance is simple—frequent sweeping, occasional damp mopping, periodic scrubbing.

AR-F-18



**ATLAS
WHITE CEMENT**
For Light-Reflecting Floors

INDEX TO ADVERTISEMENTS

Catalogs of concerns marked (s) are filed in Sweet's File (1943)

	Page		Page
AEROFIN CORPORATION	34	LOCKWOOD HARDWARE MFG. CO.	20
Agency: James C. McAward & Assoc.		Agency: Wm. B. Remington, Inc.	
ALLEN CORPORATION	110	LOUISVILLE CEMENT COMPANY, INC.	25
Agency: Whipple & Black		Agency: Doe-Anderson Adv. Agency	
ALUMINUM COMPANY OF AMERICA	40	MESKER BROTHERS	2-3
Agency: Fuller & Smith & Ross, Inc.		Agency: Padco, Inc.	
AMERICAN BRASS COMPANY	8-9	MILLER COMPANY	2nd Cover
Agency: Ivey & Ellington Inc.		Agency: J. M. Hoberson, Inc.	
AMERICAN PENCIL COMPANY	112	MILWAUKEE STAMPING COMPANY	107
Agency: Doremus & Company		Agency: Morrison Adv. Agency	
ARMO PRODUCTS, INC.	100	MINNEAPOLIS-HONEYWELL REGULATOR CO.	112
Agency: Sam Galley		Agency: Addison Lewis & Associates	
ARROW HART & HEGEMAN ELECTRIC CO.	110	MONSANTO CHEMICAL COMPANY	15
Agency: Norris L. Bull		Agency: Gardner Advertising Co.	
BARBER-COLEMAN COMPANY	94	MULLER BRASS CO.	17
Agency: Cummings, Brand & McPherson		Agency: R. C. Breth Inc.	
BETHLEHEM STEEL COMPANY	36	MURRAY D. J. MFG. CO.	108
BLODGETT, G. S. CO., INC.	106	Agency: R. C. Breth Inc.	
Agency: Townsend Adv. Service		NATIONAL MINERAL WOOL ASSOCIATION	108
BREIDERT, G. C., CO.	21	Agency: Roy S. Durstine Inc.	
Agency: Meyers Company		NATIONAL TUBE COMPANY	103
BRIGHT LIGHT REFLECTOR COMPANY, INC.	28	Agency: Batten, Barton, Durstine & Osborn	
Agency: Tracy, Kent & Company, Inc.		OKONITE COMPANY	114
BYERS, A. M. COMPANY	4	Agency: Doyle, Kitchen & McCormick	
Agency: Ketelium, MacLeod & Grove, Inc.		OZALID PRODUCTS DIVISION	1
BYRNE DOORS, INC.	3rd Cover	Agency: Young & Rubicam Inc.	
Agency: Ralph L. Wolfe & Associates, Inc.		PEMBERTON LUMBER & MILLWORK CORP.	98
CABOT, SAMUEL, INC.	121	Agency: Bathrauff & Ryan	
Agency: Harold Cabot & Company, Inc.		PETROLEUM HEAT & POWER COMPANY	101
CARNEGIE-ILLINOIS STEEL CORPORATION	97	PORTLAND CEMENT ASSOCIATION	119
Agency: Batten, Barton, Durstine & Osborn		Agency: Roche Williams & Cunningham, Inc.	
CELOTEX CORPORATION	22-23	POWERS REGULATOR COMPANY	104
Agency: MacFarland, Aveyard & Company		Agency: Earle Ludkin & Co.	
CRANE COMPANY	99	PROPELLAIR, INC.	126
Agency: Buchen Company		Agency: Erwin Wasey & Co.	
CURTIS COMPANIES SERVICE BUREAU	116	RADIO CORPORATION OF AMERICA	32
Agency: Buchen Company		Agency: Kenvon & Eckhardt Inc.	
DIXONS TYPHONITE ELDERADO PENCILS	14	RAYMOND CONCRETE PILE COMPANY	19
Agency: Federal Advertising Agency		Agency: Needham & Grohmann	
DODGE REPORTS	38	RIC-WIL COMPANY	29
DUNHAM, C. A., COMPANY	96	Agency: G. M. Basford Co.	
Agency: Western Advertising Co.		RUBEROID CO.	37
EDWARDS & COMPANY	91	Agency: Ferry-Hanly Co.	
Agency: Ferry-Hanly Co.		SAMSON CORDAGE WORK	121
ELECTRIC STORAGE BATTERY CO.	18	Agency: Callaway Associates	
Agency: Geare-Marston Inc.		SLOAN VALVE COMPANY	4th Cover
FABER, A. W., INC.	108	Agency: Reincke, Ellis, Younggreen & Finn	
Agency: Advertising Associates		SMITH, H. B. CO., INC.	92
FITZGIBBONS BOILER COMPANY, INC.	105	Agency: Bordeaux Company	
Agency: Peterson & Kemper, Inc.		SQUARE D COMPANY	33
FORBERT CORPORATION	125	Agency: Reincke-Ellis-Younggreen & Finn	
FORD, IVON B. LUMBER CO.	110	STRAN STEEL DIVISION	31
Agency: Geyer Cornell & Newell Inc.		Agency: Campbell Ewald Company	
FULLER, GEORGE A. COMPANY	87	STREAMLINE PIPE & FITTINGS DIVISION	17
Agency: Geyer Cornell & Newell Inc.		SWEETS CATALOG SERVICE	122
GENERAL ANILINE & FILM CORPORATION	1	SYLVANIA ELECTRIC PRODUCTS, INC.	93
Agency: Young & Rubicam Inc.		Agency: Arthur Kudner, Inc.	
GENERAL FABRICATORS, INC.	117	TEXAS PRE-FABRICATED HOUSE & TENT CO.	30
GREAT LAKES STEEL CORPORATION	31	Agency: Frank Guenther Law Co.	
Agency: Campbell-Ewald Company		TIMBER ENGINEERING COMPANY	89
GREEN LUMBER COMPANY	107	Agency: Campbell-Ewald Company	
GRINNELL COMPANY, INC.	116	TRAVELodge CORPORATION	120
Agency: Horton Noves Company		UNDERWOOD ELLIOTT FISHER COMPANY	123
GUNNISON HOUSING CORP.	115	UNIT STRUCTURES, INC.	107
HART & HEGEMAN DIVISION	110	Agency: Hoffman & York	
Agency: Norris L. Bull		UNITED STATES STEEL CORPORATION	
HOMASOTE COMPANY	109	SUBSIDIARIES	12-97-103-124
Agency: Doremus & Co.		Agency: Batten, Barton, Durstine & Osborn	
HOUSTON READY CUT HOUSE CO.	112	UNIVERSAL ATLAS CEMENT CO.	12-124
Agency: Erwin Wasey & Co.		Agency: Batten, Barton, Durstine & Osborn	
IMPERIAL BRASS MFG. CO.	6	UPSON COMPANY	111
Agency: Kreicker & McLean, Inc.		Agency: McCann Erickson, Inc.	
JAMISON COLD STORAGE DOOR CO.	114	WALLACE & TIERNAN COMPANY, INC.	121
Agency: Charles Blum Adv. Corp.		Agency: G. M. Basford Company	
JOHNS MANVILLE	113	WEBSTER WARREN & COMPANY	14
Agency: J. Walter Thompson Company		Agency: William Jenkins Advertising	
KEWAUNEE MFG. CO.	121	WESTINGHOUSE ELECTRIC & MFG. CO.	13-35
Agency: Rogers & Smith		Agency: Fuller, Smith & Ross	
KITCHEN MAID CORPORATION	104	WHITE-RODGERS ELECTRIC CO.	90
Agency: Carter Jones & Taylor		Agency: Frank G. Japha	
KOPPERS COMPANY	39	WIREMOLD COMPANY	102
Agency: Ketchum, MacLeod & Grove, Inc.		Agency: Edward W. Robotham & Co.	
KOH-I-NOOR PENCIL COMPANY, INC.	116	WOOD CONVERSION COMPANY	114
Agency: Roeding & Arnold		Agency: Buchen Company	
LCN DOOR CLOSERS	95	WORTHINGTON PUMP & MACHINERY CORP.	11
Agency: J. R. Hamilton Adv. Agency		Agency: Moser & Cotins	
LIBBEY-OWENS-FORD GLASS COMPANY	24		
Agency: Fuller, Smith & Ross, Inc.			
LINTON PENCIL COMPANY	27		

New York—General Manager: H. Judd Payne. Advertising Manager: Tom Tredwell. B. B. Orwig, 119 West 40th Street. Boston—Robert Marshall, 855 Park Square Bldg.; Chicago—C. B. Riemersma, F. H. Bowes, 700 Merchandise Mart; Cleveland—Homer Andrews, 321 Hanna Bldg.; Los Angeles—W. R. McIntyre, 400 East Third St.; Philadelphia—Tom Tredwell, 1321 Arch Street.

*Housing Aircraft Workers, Wilson Point, Essex, Md.

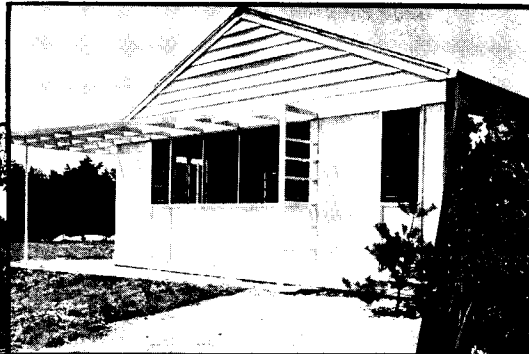
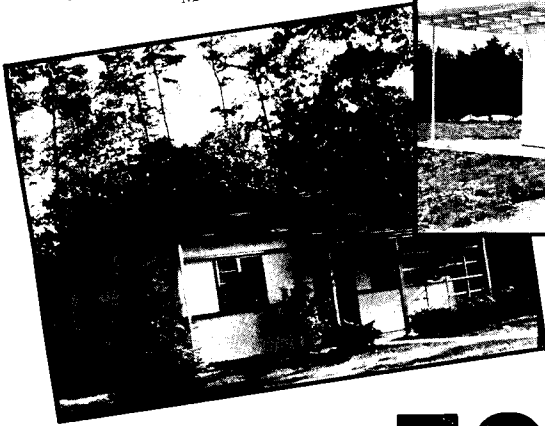

*Camouflaged Site Garden Planning, Maryland



**Vertical Single Wall Construction, Newport News, Virginia

FORBERT

Factory-Fabricated Housing

MASS produced, factory-fabricated housing is now available through the facilities of the Forbert Corporation. Hundreds of these houses have been factory fabricated in our Virginia plant and delivered to locations hundreds of miles away where they have been speedily erected to give hosts of war workers low-cost, substantial housing.

Many Forbert factory-fabricated houses have been built under the patents of the John B. Pierce Foundation, oldest and best known research organization in prefabrication. These houses have a sturdy wall of Celotex Cemesto board which combines the strength, weather and fire resisting qualities of asbestos and cement with the insulating qualities of Celotex. Hundreds of other units of our V-home type are now housing shipyard workers.

Plant facilities of Forbert Corporation comprise some 18 buildings including large multiple warehouses which permit a complete inventory of hous-

ing units ready for instant shipment. Adequate machinery and kiln drying facilities assure well-built houses. Spur railroad connections and scientific loading on freight cars or trucks guarantee quick delivery of compact factory-fabricated wall panels, frame members and doors as well as windows glazed and equipped with hardware ready for site erection.

Forbert factory-fabricated houses are now housing war workers for aircraft, munitions plants and shipbuilding yards. Dormitory and barrack type living quarters have also been manufactured in quantity and delivered on time.

If you want sturdy, low-cost shelter in a hurry, or if you are now planning a postwar housing development, be sure to write or wire us. A Forbert housing engineer will be pleased to work with you.

FORBERT CORPORATION
McGaheysville, Virginia

***Celotex Cemesto Board being applied to Horizontal Type Construction

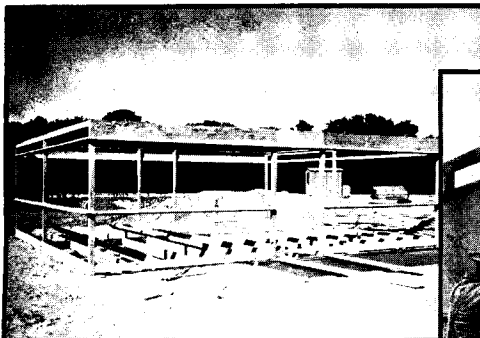

*Skeleton Framework of Horizontal Type Construction

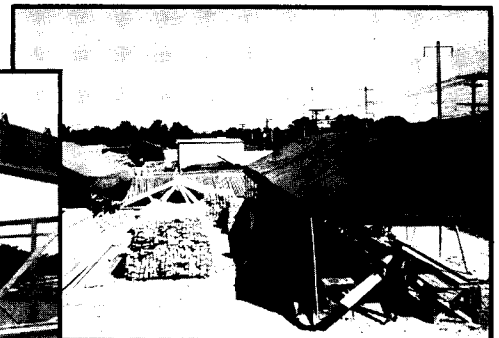
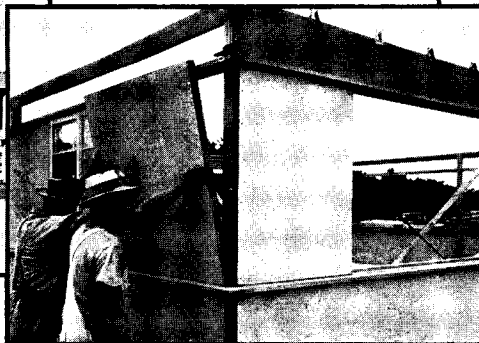

Field Shop which handles rough lumber items not requiring factory-fabricated millwork

* The buildings built under the patents of the John B. Pierce Foundation. ** Vertical Type Construction. Patent Pending. *** Cemesto Panels manufactured by the Celotex Corporation.

HAVE YOU a problem involving Dust? Here's how PROPELLAIR Fans can help you solve it!

The drawing at the right illustrates one of the many difficult ventilating problems involving dust that have been successfully solved by Propellair Fans because of their unusual efficiency against high static pressures.

Standing with faces close to their work of exact and intricate grinding, die workers in a large Middle Western drop-forge plant were breathing fine emery and steel particles thrown off by portable high-speed grinders. Results: absenteeism due to sickness, and lessened production.

Propellair ventilating specialists installed two 1 h.p. Propellair Fans and duct work for each bench, plus an individual dust collector on the floor above. Each pair of fans, operating together against high static pressure (1.4"), functions as a "dust elevator." They move 4000 cubic feet of air per minute, at velocities over the blocks of 1500 to 1800 feet per minute, exhausting all dust and steel particles produced by the worker.

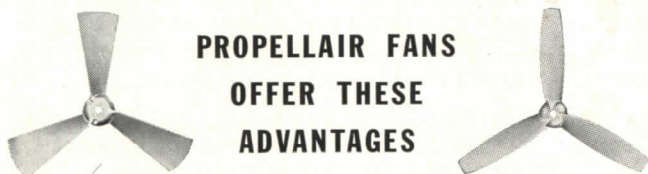
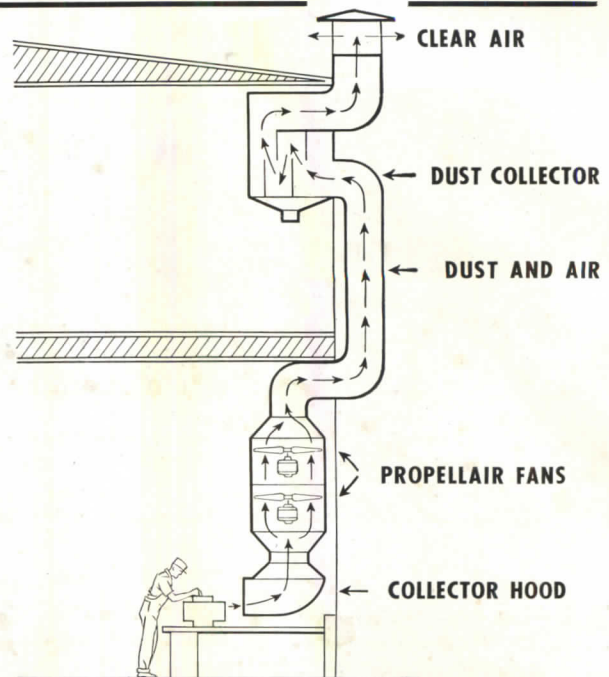

PROPELLAIR FANS OFFER THESE ADVANTAGES

AXIAL-FLOW, AIRFOIL PROPELLERS,

especially designed by Propellair engineers, deliver maximum air with minimum horsepower. Air flow is even over all parts of the blades—the *whole* fan works, not just the tips! These unique propellers are also non-overloading—from free air to complete block-off, horsepower remains virtually constant as long as motor speed is constant. The number of blades, and their angle and shape, depend on the job to be done.

CURVED ENTRANCE RING,

in addition to serving as a sturdy support assembly, reduces tip loss and enables Propellair Fans to deliver *maximum air per horsepower*. Introduced in 1930, as a result of exhaustive experiments and tests by Propellair engineers, this design makes possible the utilization of the "Airfoil" air-movement principle in the *entrance ring* as well as in the *propeller*.

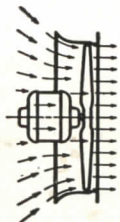

A PROPELLAIR FAN FOR EVERY APPLICATION



CD—Direct connected to electric motors. For ducts, hoods, roof ventilators or panels.

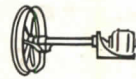

CE—Extended shaft fans for ducts, dryers, etc., where motor must be outside the air stream.



CF—For belt drive from separate motors, engines or line shafts. Also with extended shaft assembly.

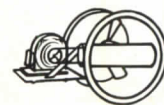

CS—Heavy-duty complete belt-driven unit in duct section. For severe dust, corrosive or explosive vapors.

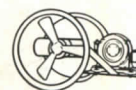

CSV—Heavy-duty complete belt-driven unit for high temperatures in ducts, pipes, and as stack boosters.



CSB—Heavy-duty complete belt-driven unit for ducts or stacks to handle explosive vapors, dust, or high temperatures.



CU—Low-stand, tiltable, portable cradle fan for hardening-room service, product drying or cooling.



CM—Heavy-duty pedestal blast fan for cooling men and products in heavy industries.



C—Industrial circulator fan for general air-circulating service of all types.



CB—Slow-speed, ultra-quiet complete belt-driven fan. For office or room ventilation.

If you have a pressing industrial ventilating problem, you should have our Propellair catalog No. 10-H. It contains many pages of technical tables, charts, diagrams and other valuable information for architects, engineers and plant men—and of course describes and illustrates the complete Propellair line. We will mail the catalog on request or, if you prefer, we will ask the nearest Propellair ventilating specialist to deliver your copy personally and at the same time discuss your specific problems. *Write!*

