



Samuel Chamberlain

WITH DIXON'S TYPHONITE ELDORADO

#### TECHNIQUE USED

The restrained gray mood of this old English Castle has been captured by Mr. Chamberlain with HB, F and 2H *Typhonite* Eldorado pencils. The principal layout of the drawing was made with a 3B. Distant values were obtained with a flat 5H. A coarse sketch paper (Canson and Mongolfier) was used.

#### "BLOODY, BUT UNBOWED . . ."

*How the ghosts of former defenders of this old fortress, which has overlooked the English Channel since Norman times, must have cried out in protest when German bombs struck! This great historical and architectural work, battered, but undaunted, somehow symbolizes England's indomitable pride and courage. Dover Castle is here reconstructed by Samuel Chamberlain, Typhonite Eldorado in hand. Another in a series brought to you by Pencil Sales Department 225-J11,*

JOSEPH DIXON CRUCIBLE COMPANY, JERSEY CITY, NEW JERSEY

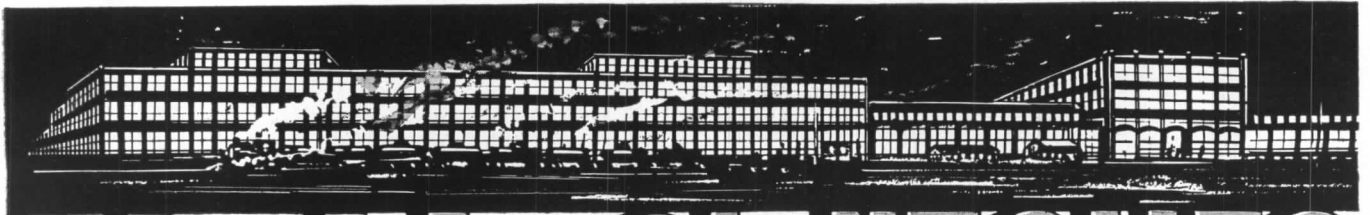

# H & H - SWITCHES

## UPHOLD PLANT MAINTENANCE



*DIVERSITY* of types meets "current" needs for new construction, conversion or replacements. Heavy-duty controls for lighting or power circuits:—specification-grade T-rated 10, 20 and 30 Ampere "Type C" Switches, Rotary Snap Switches, Ceiling Pull Switches, Door Switches, Flush Tumbler Switches with or without outlet box covers.

*DEPENDABILITY* of mechanisms meets war demands for uninterrupted service on critical jobs. For more than a half-century, H & H Switches have been *tested-by-use* for emergency conditions now general. Among the first in the field, they were long since promoted to the "ranking line" for under-fire assignments the world over.

**HART & HEGEMAN DIVISION**  
THE ARROW-HART & HEGEMAN ELECTRIC CO. HARTFORD, CONN.



*Looking ahead with Asbestos*



**HOME OWNERS ARE TO HAVE HELP**

**"keeping a roof over their heads"**

There will probably be as many different "homes of tomorrow"—and good ones, too—as there are architects dreaming about them now. But of one thing we're sure: Home owners are going to be mighty pleased with the extra protection of a "Century" life-time roof.

What home owner of the future will be happy with shingles that can rot, curl, split or catch fire, when he finds out that K&M "Century" asbestos-cement shingles will do none of these things? Or how pleased will he be at getting a roof that can require expensive repairs, when "Century" shingles actually get tougher with age?

This life-time quality of "Century" shingles is due to the combining, under tremendous pressure, of uniform percentages of asbestos fibre and Portland cement. The charm they bring to roofs is the inevitable result of soft,

mellow, "blendable" colors; the weathered texture, the irregular edges casting heavy shadow lines.

Though the war effort has drafted a considerable portion of K&M's producing capacity, these durable and attractive shingles are available for those civilian projects that come within the wartime building limitations. When peace returns, of course, "Century" shingles will resume their career atop Tomorrow's homes. Meanwhile, you may be sure, K&M asbestos research continues to search for new ways by which Nature's strangest mineral may benefit mankind.

\* \* \*

*Nature made asbestos;*

*Keasbey & Mattison, America's asbestos pioneer,  
has made it serve mankind . . . since 1873*

**KEASBEY & MATTISON**  
COMPANY, AMBLER, PENNSYLVANIA

*Makers of*

asbestos-cement shingles and wallboards; asbestos and magnesia insulations for pipes, boilers, furnaces; asbestos textiles; asbestos electrical materials; asbestos paper and millboard; asbestos marine insulations; asbestos acoustical material; asbestos packings; asbestos corrugated sheathing and flat lumbars; asbestos-cement pipe for water mains



# Another turn of Hospital Duty for **BYERS** **WROUGHT IRON**



St. Joseph's Hospital Addition . . . Pittsburgh, Pa., Leo A. McMullen, Architect

Because air raids can convert any community into a front-line battle ground, adequate civilian hospital facilities have become a big consideration in national defense. Materials for constructing such projects must be diverted from other important uses. It is vital to avoid any further drain for unnecessary repairs.

In the St. Joseph's Hospital Addition at Pittsburgh, Pa., Architect Leo A. McMullen wrote his specifications with these facts in mind. Vents, waste lines over 2-inches, soap distributing lines, and the 4-inch hot and cold water lines—all services where active corrosive attack could be anticipated—were piped with Byers Wrought Iron.

There is plenty of engineering

evidence to support this selection. Surveys made in several large cities have shown wrought iron serving in similar applications for periods up to 50 years. In some cases, the wrought iron replaced other materials, and had doubled and tripled their service life, with no sign of failure.

Writing specifications is a bigger-than-ever responsibility today, for every active project is tied up with the war effort, and uses war material. In cases where corrosion is a factor, our "Experience Pool" can help you. This

"pool" is our name for a file of hundreds of actual case-histories covering the performance of wrought iron in many varied applications. It provides the architect and engineer who has no time for personal study and investigation, with an authoritative guide in selecting durable materials. If you care to write us about any specific problem, we will be glad to tell you how wrought iron has served in similar situations. Ask, also, for our General Catalog, which gives complete dimensional data on all Byers products.

A. M. Byers Company. Established 1864. Offices in Pittsburgh, Boston, New York, Philadelphia, Washington, Chicago, St. Louis, Houston, Seattle, San Francisco.

CORROSION COSTS YOU



MORE THAN WROUGHT IRON

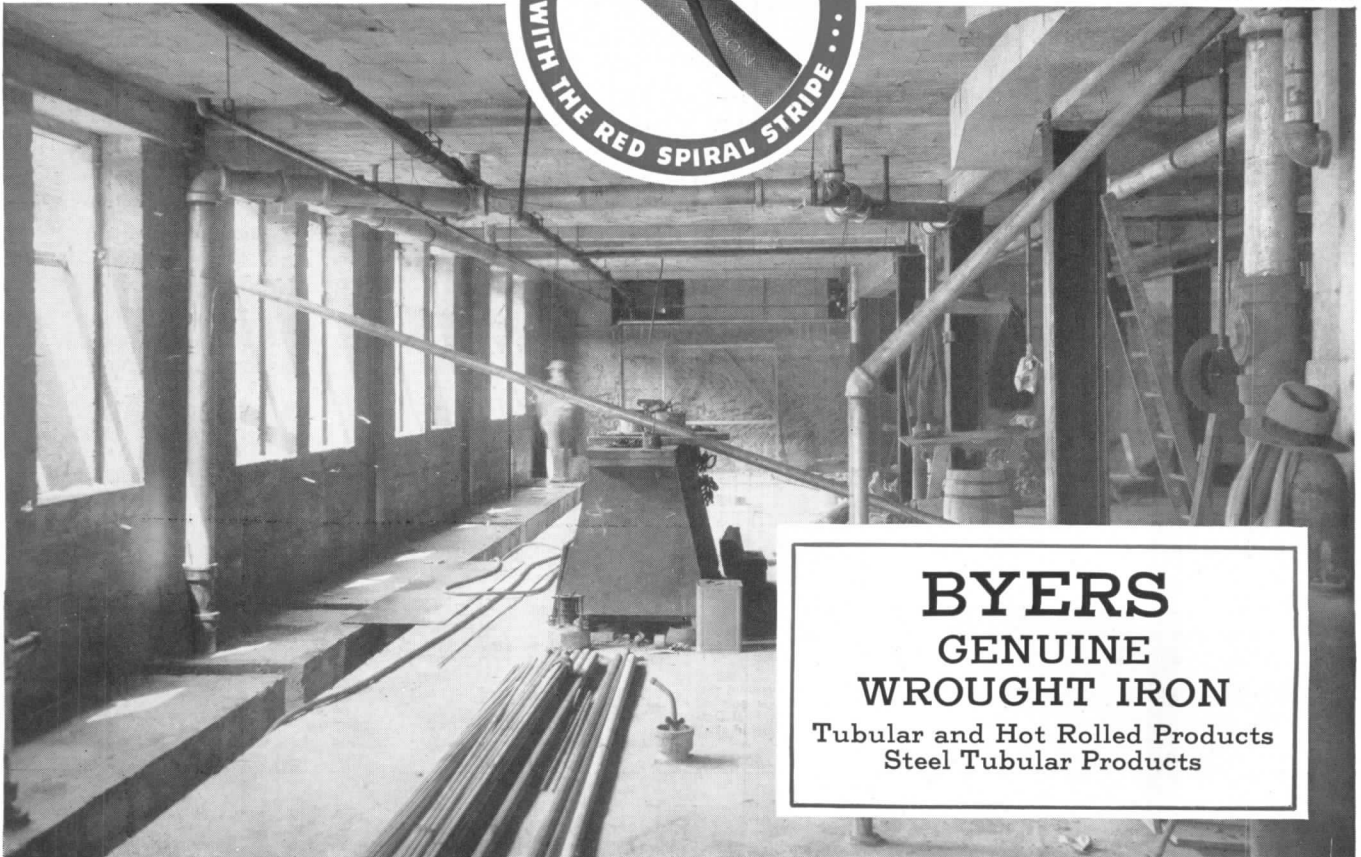

**BYERS**  
**GENUINE**  
**WROUGHT IRON**  
Tubular and Hot Rolled Products  
Steel Tubular Products



# RECORD

COMBINED WITH AMERICAN ARCHITECT AND ARCHITECTURE

VOL. 92

NOVEMBER 1942

No. 5

## CONTENTS

<b>HIGHER STANDARDS OF LIVING</b> . . . . .	31
An Editorial . . . by Kenneth K. Stowell	
<b>FUNCTIONS, FACTORS AND FUTURES</b> . . . . .	32
An analysis of the objectives of the building industry, the factors involved, and the functions that will persist in the postwar trend toward unification.	
<b>N.B.C. BROADCASTING BUILDING</b> . . . . .	37
Planned for modern traffic conditions in San Francisco, luxurious in color and appointment, this was the last word in pre-war radio stations; Albert F. Roller, Architect.	
<b>OUTLINES OF POSTWAR PATTERNS</b> . . . . .	41
By Emerson Coble . . . Resumé of current thinking on the problems and opportunities of both the short and long range postwar construction program.	
<b>SIX SMALL HOUSES</b>	
1. in Washington . . . Donald Dwight Williams, Architect . . . . .	47
2. in California . . . Raphael S. Soriano, Architect . . . . .	48
3. in Texas . . . . . Mackie and Kamrath, Architects . . . . .	50
4. in California . . . Philip Joseph, Architect . . . . .	52
Office of John Ekin Dinwiddie . . . . .	
5. in Oregon . . . . . Van Evera Bailey, Architect . . . . .	54
6. in Massachusetts . . . Royal Barry Wills, Architect . . . . .	56
<b>FREEDOM AND SPACE IN SMALL HOUSE PLANNING</b> . . . . .	57
. . . BUILDING TYPES STUDY NO. 71	
Considerations which will influence the planning of the postwar houses that will be demanded when prospective owners will be building to suit their needs and tastes.	
<b>PLANNED FOR SPACE AND FREEDOM</b> . . . . .	63
House in Wisconsin, George Fred Keck, Architect.	
<b>TIME-SAVER STANDARDS—Louvers</b> . . . . .	69
<b>THE RECORD REPORTS</b> . . . News from the field . . . . .	7
<b>REQUIRED READING</b> . . . Reviewed by Elisabeth Coit, AIA . . . . .	18
<b>FOR BETTER BUILDING</b> . . . News of materials, equipment and methods . . . . .	74
<b>INDEX TO ADVERTISEMENTS</b> . . . . .	102

## NEXT MONTH

WITH NEW RULINGS being announced week after week regarding the use and disuse of critical materials, we are being made gravely aware of the critical situation that exists. Priorities had to give way to more rigid rationing so there would be "no more tickets sold than there are seats in the theater." The WPB experts are combing through every project to save every ounce of strategic material that can be dispensed with and still have the buildings stand up. Better and faster methods of building without critical materials are being used and they will be explained and illustrated in the December Building Types Study (No. 72) covering Industrial Buildings, their construction in reinforced concrete and wood. . . . And there is a remarkable cantilever-roofed airplane hangar of unusual timely interest, for its trusses are of reinforced-concrete and exposed above the roof. . . . Another feature is a school in the country, unique in plan and economical in design, yet as pleasant to see as it is efficient in use. . . . People who always used their own automobiles are now riding buses, and the bus stations are being taxed to capacity. A new station in the south is shown in the December issue, as it is interesting in both design and construction. . . . Nor are the pertinent subjects of Postwar planning and Housing neglected in the final issue of the year that has seen the most far-reaching changes ever encountered in building.



Copyright 1942 with all rights reserved  
H. JUDD PAYNE, Vice President in charge of MAGAZINE DIVISION

F. W. DODGE CORPORATION

EDITORS: *Editor-in-Chief*: Kenneth Kingsley Stowell, AIA, *Managing Editor*: Emerson Goble, *Associate Editor*: Edward J. Whiting, AIA, *Desk Editor*: Florence A. van Wyck.  
CONSULTANTS: *Industry relations consultant*: Thomas S. Holden. *Statistical consultant*: Clyde Shute. *Building economics consultant*: Norbert Brown. *Field research consultant*: Clifford Dunnells, Jr. *Librarian*: Jane Graf.  
ARCHITECTURAL RECORD (combined with American Architect and Architecture) is published monthly by F. W. DODGE CORPORATION, 34 No. Crystal St., East Stroudsburg, Pa., with Editorial and Executive Offices at 119 West 40th Street, New York, N. Y. Thomas S. Holden, Pres.; Howard J. Barringer, Vice-Pres. and Treas.; Irving W. Hadsell, Vice-Pres.; Chauncey L. Williams, Vice-Pres.; Sanford D. Stockton, Jr., Secy.; Walter F. De Saix, Asst. Treas.; Edwin H. Freed, Asst. Treas. Member Audit Bureau of Circulations and Associated Business Papers, Inc. ARCHITECTURAL RECORD is indexed in Reader's Guide, Art Index and Industrial Arts Index. Subscription rates: United States and Possessions, Canada, Cuba, Mexico, Central and South America, \$3 the year, \$5 for two years, \$6 for three years; elsewhere, \$5 the year; single copy, \$1. Circulation Manager: A. L. Erickson.  
Every effort will be made to return material submitted for possible publication (if accompanied by stamped, addressed envelopes); but the editors and the corporation will not be responsible for loss or damage.  
Other Dodge Services: REAL ESTATE RECORD AND BUILDERS' GUIDE, SWEET'S CATALOG FILES, HOME OWNER'S CATALOGS, DODGE REPORTS, and DODGE STATISTICAL RESEARCH SERVICE.

Architects didn't worry about telephone booths when they worked like this

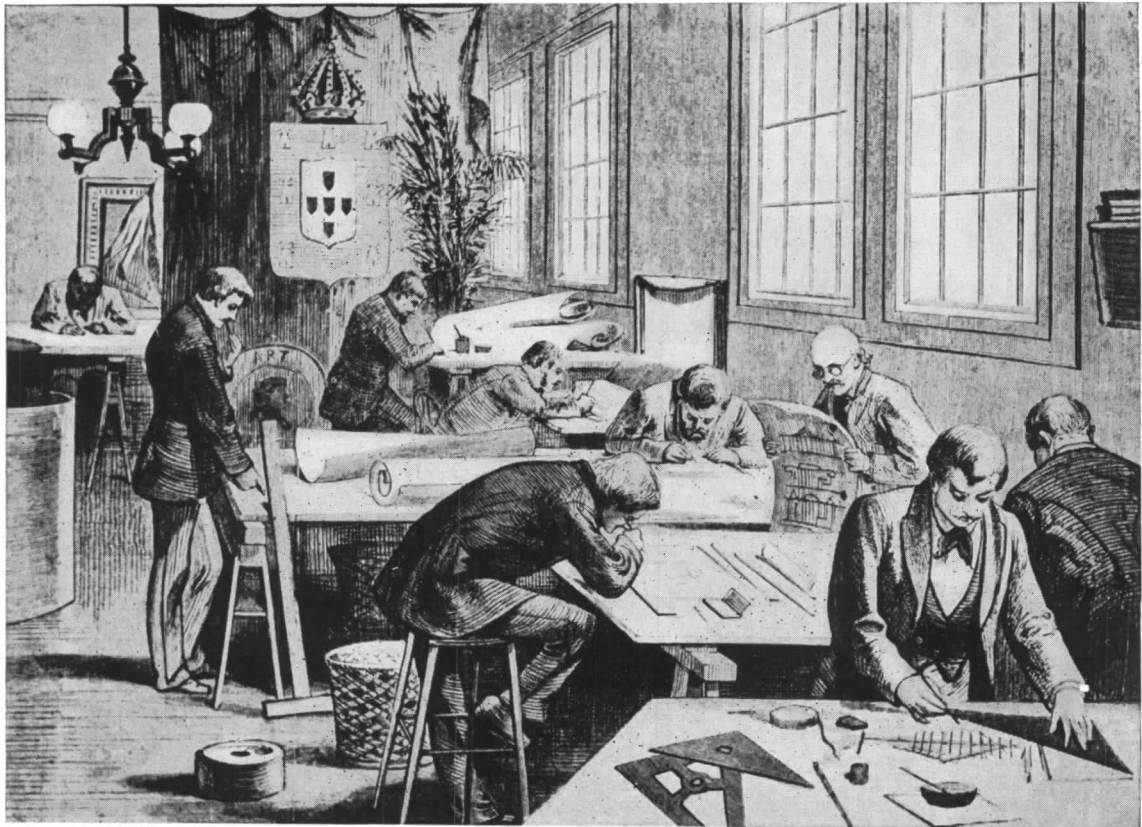

From Architectural Collection—Bettmann Archive

**TODAY**

a modern built-in booth is an important part of your plans for future building - -

When you're drawing up plans for future building or remodeling of public places, make sure you include modern built-in telephone booths. If you specify Burgess Acousti-Booths, they'll add a note of distinction to your design.

Acousti-Booths provide greater privacy and comfort for users because they're of patented Burgess acoustic construction. They're doorless because doors aren't needed. You won't have a design problem because they're ready to install. And their all-wood construction makes it easy to match any decorative scheme. Burgess Battery Company, Acoustic Division, 2821-A W. Roscoe Street, Chicago, Ill.

Operating under Burgess Patents

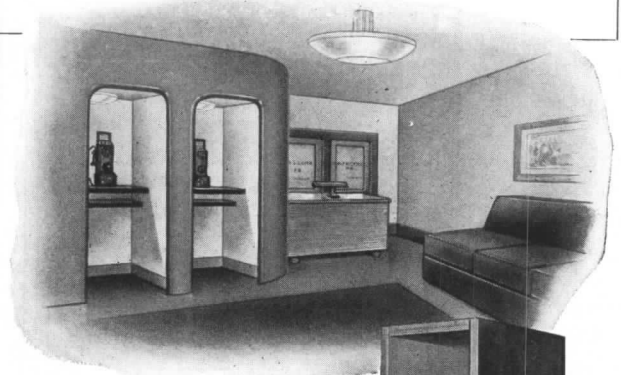

Private. Acoustic construction keeps noise out, keeps user's voice inside. Conversation won't be overheard.

Easy to use. Ample room inside. No door to jam or cause trouble. Always well ventilated.

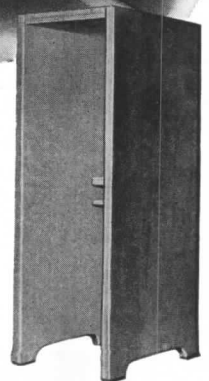

**BURGESS TELEPHONE** *Acousti-Booths*





## WASHINGTON NEWS

By WILLIAM J. CASEY

**Construction Schedules Being Further Reviewed • New Reinforcing Steel Allowances • Simplification of Steel Products • Application for Project Amendments • Round Up on Construction Control • Housing for War Workers • Longer Work Week for NHA Jobs • Defense Rental Areas**

CONSTRUCTION for the months ahead is again being subjected to close scrutiny. Slated for elimination are not only such unessential construction projects which may still be on schedule for completion, but also many projects which would normally be considered essential to war production. If they can't stand up in competition with direct and immediate use of materials and manpower in war production, they will be wiped out. This seems to mean also a swinging of the pendulum back to dormitory and other temporary housing.

One area of construction, however, seems to be in for a boom. Secretary Stimson's statement that more than 2,000,000 men will be in the air corps by the end of 1943, the President's decision to set as the 1943 production goal the rate of 125,000 planes per year indicates that military strategy will be to bomb our way to victory. This can't be accomplished without substantial construction of aircraft and plane part factories, training bases, etc.

The War, Navy, Commerce and Interior Departments, Maritime Commission, Federal Works Agency and TVA have been told that priority assistance already granted to a large part of the non-military construction program will be revoked. Each agency has been told which of its construction projects were found essential in preliminary WPB surveys. All others are slated for elimination. The agencies involved have a chance to submit their own list of projects which they wish to complete and the facilities organization will make the final decision.

### Facility Clearance Board

Control over all military and civilian construction projects is now channeled in a Facility Clearance Board and a Facility Review Committee. The Facility Clearance Board will pass on all new projects costing \$500,000 or more. The Facility Review Committee will pass on all new projects costing between \$100,000 and \$500,000 and

review all projects now under way, regardless of cost.

The Facility Clearance Board has final say as to any facility or construction project costing \$500,000 or more, whether publicly or privately financed. In considering it, the Board reviews the necessity from the point of view of the war effort, location, method of construction, use of critical materials, and consumption in operation of materials, manpower or services.

The Board takes over the jobs formerly done by the Plant Site Board of WPB, the Facility Committee of the Requirements Committee, the Facilities Clearance Committee of the Army and Navy Munitions Board, the Special Committee on Facilities of the War Department and the Facilities Cut-back Committee of WPB. An important addition, however, is the power to consider projects in view of their essentiality to the war effort.

Members of the Facility Clearance Board are: Ferdinand Eberstadt, Vice Chairman of WPB on Program Determination, Chairman; Colonel Gordon E. Textor, Acting Chairman; S. E. Skinner, Director, Production Division Headquarters, Services of Supply, U. S. Army; Brigadier General Bennett Meyers, Chief of Staff, Material Command Headquarters, Army Air Forces; Joseph W. Powell, Deputy Chief, Office of Procurement and Material, Navy Department; Rear Admiral E. M. Pace, Director of Materials, Bureau of Aeronautics, Navy Department; Rear Admiral Howard L. Vickery, Vice Chairman, Maritime Commission; Maurice Wertheim, Consultant to Director, Office of Civilian Supply, WPB.

On projects costing between \$100,000 and \$500,000, the Facility Review Committee will have the same powers and duties as the Facility Clearance Board has for the larger projects. In addition, the Committee may review any facility or construction projects, regardless of size or total cost. This review may include projects already under way as well as those approved and not yet started.

(continued on page 8)



"Well, shall we form a primary conversation group in the area for relaxation?"

—Drawn for the RECORD by Alan Dunn

(continued from page 7)

The purpose of such review is to determine whether the approval should be withdrawn and construction stopped. The basis for such actions will be the relation of the project to the war effort.

Members of the Facility Review Committee are: Colonel Textor, Chairman (representing the Vice Chairman of WPB on Program Determination); Don Uthus, Deputy Chairman; Captain W. H. Smith, U. S. Navy; Lieutenant Colonel Richard N. Tatlow, U. S. Army; John Nelson Franklin, Maritime Commission. Representatives of the Office of Civilian Supply and the National Housing Agency will be designated shortly.

Any agency, public or private, sponsoring any construction project, whether publicly or privately financed, must clear the project through the Facility Clearance Board or the Facility Review Committee.

No funds may be expended or committed by letter of intent for any project costing more than \$500,000 without clearance by the Board. Likewise, no project, regardless of cost, may be submitted to WPB for final allotment or priority determinations unless it has been cleared.

### New Reinforcing Steel Allowances

Following new strength allowances for steel construction, reported last month, WPB has issued national emergency specifications for the design of reinforced concrete buildings. The manual governs the use of reinforcing steel for all Government work for which contracts are placed after December 4.

The purpose of this is to conserve the supply of reinforcing steel by requiring larger structural members and higher unit tensile stresses in reinforcing steel. Tensile stress has been increased from 18,000 lb. to 20,000 lb. per sq. in. for structural grade bars, and from 20,000 to 24,000 lb. per sq. in. for intermediate and hard grade bars. WPB estimates that these allowances will produce a saving of about 25% in reinforcing steel, which may amount to between 150,000 and 250,000 net tons.

### Simplification of Steel Products

In a further effort to save steel, WPB is limiting the varieties of steel

mill products. WPB will issue new schedules for various steel products limiting varieties and shapes, and defining compositions, types, and grades. It is pointed out that restrictions on structural steel have resulted in a sharp rise in concrete construction, and consequently in a greater demand for reinforcing bars and spirals.

The first of two schedules already issued covers concrete reinforcement steel and establishes a list of permissible sizes of steel reinforcing bars by adopting the simplified practical recommendation R26-42 of the National Bureau of Standards.

### Application For Project Amendments

After October 26, all applications for amendments to construction projects authorized by a preference rating order of the P-19 series must be filed on the new form, PD-200B. The form is available at FHA and WPB field offices. It should be used for requests for a higher rating and for items not previously authorized or for increases in quantities previously authorized. When a higher rating is requested, the applicant must list the items required and describe the efforts made to obtain these items with the authorized rating.

Requests for projects amendments will not be accepted on PD-1A forms or by letter after October 26. It is possible to request by letter, however, permission to alter delivery dates or to extend expiration dates as authorized on the original application.

### Round Up On Construction Control

Control of the country's No. 1 industry, construction, is now centralized in the Project Requirements Plan. Not in initials alone is this the PRP for builders. Stop-construction Order L-41 and Form PD-200, together form the scissors which WPB is using to cut construction to fit the war pattern. Almost all applications for authorization to build must be made through this Plan, both when priorities assistance is required and where the application is a straight request for authorization. PD-200 has just been revised to serve this dual purpose. After October 1 the old form will be accepted only in emergency cases. Only such types of building as L-41 per-

mits will be granted authorization. Utilities must use the plan under P-98 to get a preference rating for materials needed in new construction connected with various specified facilities. Builders must apply on PD-200 to get a P-19-h rating for defense project construction. Hotels, apartment houses, industrial plants, road builders, persons whose property has been taken over by the Government—all persons desiring to begin any job, whether large or small—must apply on PD-200. Here is how the Plan works:

(1) *If you have materials.* If you wish to begin construction of the types permitted under L-41, and you have sufficient materials on hand, you file PD-200 for authorization to proceed with the work. WPB grants the authorization on PD-443 and you go ahead. In order to facilitate such applications WPB recently built a blanket authorization plan into PD-200, whereby you may list any number of routine miscellaneous jobs in connection with a single building or project in one application, providing no job costs over \$5,000. Although no limit was placed on the aggregate cost of such blanketed jobs, expect WPB to set an overall figure soon.

(2) *If you need materials.* If you need a preference rating to get materials for the proposed construction you file your request on PD-200 as before, except that under the revised form machine tools and other metal-working equipment may be included in the application. PD-1A's formerly used for such items are now limited to cases where no construction is involved in their installation. Like the Production Requirements Plan, the construction PRP permits you to order materials in the amounts specified on your authorized PD-200. However, if you need additional quantities of the rated materials, require priority assistance to get others, or desire a higher rating, you may apply to WPB on Form PD-200B.

A special provision is made for Army and Navy contractors in cases where it is urgent that construction be started before complete data can be furnished. In such cases a preliminary PD-200 may be filed, giving general data which will be used as a basis

(continued on page 10)



# EXTERMINATE THE NOISE DEMONS



... with ceilings of  
*Armstrong's Cushiontone*

IT ISN'T THE FAULT of the pupils—or of the teachers either—when noise demons make it hard to concentrate. School work is bound to slow down, and discipline suffer, as long as these costly nerve janglers are on the loose. But it's easy to trap them with ceilings of Armstrong's Cushiontone—the new material that puts efficient noise-quieting within the reach of modest building and maintenance budgets.

The 484 sound-absorbing holes in each square foot of Armstrong's Cushiontone literally trap disturbing din in corridors, classrooms, cafeterias, or other noise-producing areas. They give this material a noise-reduction coefficient as high as .75. When it's installed, the effect in any room is positive and pronounced.

Armstrong's Cushiontone is factory-painted, ready to apply. Installation is quick and easy, without undue interruption to school routine. Maintenance is at a minimum, for Cushiontone is easily cleaned, and it can be repainted whenever necessary without affecting its acoustical efficiency in the slightest. Its ivory-colored surface reflects light unusually well—helps to improve general illumination.

WRITE FOR THE FACTS—Our new booklet gives the whole story of Armstrong's Cushiontone. We should like to send you a copy. Just drop a note to Armstrong Cork Company, Building Materials Division, 1245 State St., Lancaster, Pa.

## Armstrong's Cushiontone

Made by the  Makers of  
Armstrong's Linoleum and Asphalt Tile

# DU PONT "CZC" Gives Wood DURABILITY

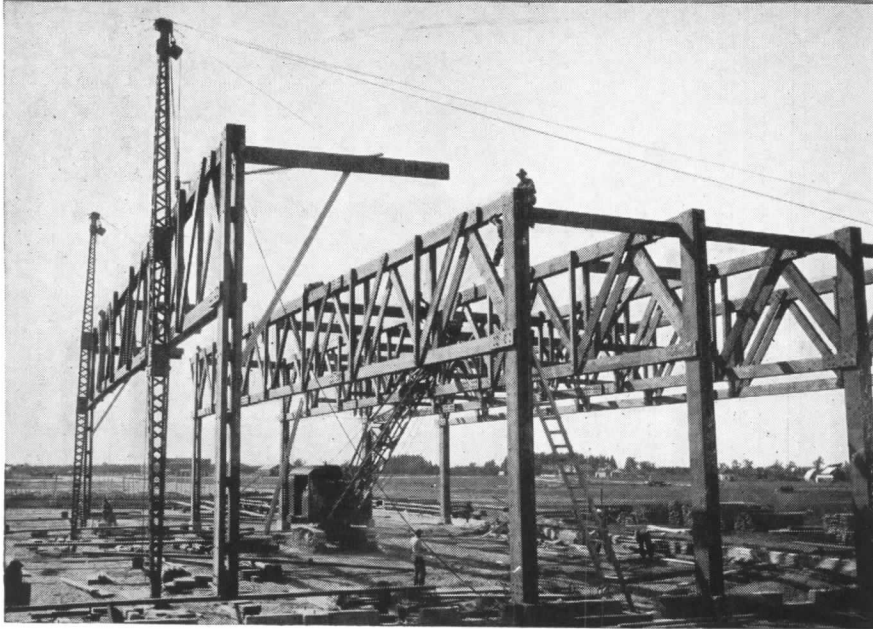

**F**OR structural timber, flooring, roofs—wherever lumber may encounter severe service conditions—architects and engineers are specifying "CZC" treated lumber.

Du Pont "CZC" gives lumber qualities of durability which make it a distinctive structural material. Chromated Zinc Chloride provides durable protection against decay, and repels termites, thereby extending the expected service life 3 to 10 times. At the same time it gives measurable fire resistance and leaves the wood clean, odorless, paintable and easily fabricated.

## ECONOMY

"CZC" treatment permits the use of less naturally durable woods which become more lasting than the better grades untreated. In addition "CZC" treatment reduces the need for overscaling to allow for depreciation in strength due to decay. Properly treated lumber suffers no

loss of strength in pressure treatment. The same values for load and stress calculations are applied as designated for untreated wood.

In addition many builders are taking advantage of "CZC" fire retardant properties by specifying pressure treatment to provide fire resistant structural timbers. Write for full information.

Plants equipped to render "CZC" treating service are located throughout the country. E. I. du Pont de Nemours & Company (Inc.), Grasselli Chemicals Department, Wilmington, Delaware.



# C Z C

**CHROMATED ZINC CHLORIDE**  
(WOOD PRESERVATIVE)

BETTER THINGS FOR BETTER LIVING... THROUGH CHEMISTRY

## THE RECORD REPORTS

(continued from page 8)

for authorization until a final PD-200 is ready.

### Housing for War Workers

Because the required volume of war housing accommodations cannot be supplied in time through new construction, the U. S. Government will lease privately owned homes and buildings and remodel them to provide living quarters for war workers and their families. The program will be on a voluntary basis for the time being, but the National Housing Agency has indicated that if it does not yield sufficient space, requisitioning, commandeering and billeting would be instituted. NHA plans to lease suitable properties in crowded war production centers at a satisfactory rental, make alterations to meet the needs of war workers and their families, rent and manage the converted properties for the duration, and then return them to their owners within a reasonable period after the end of the war. The owners will be permitted to occupy part of the converted structures, if necessary. The Homes Use Division of NHA will concentrate on houses, combination business and residential properties and small apartment houses and flats. Larger structures which are suitable for reconditioning and conversion will be leased or purchased through the Federal Public Housing Authority.

### Longer Work Week for NHA Jobs

The NHA agency has authorized a 40-hour work week in housing essential to war. The Government will reimburse contractors for overtime pay for workers where completion of projects is urgent, and where adequate labor cannot be obtained. FHA regional directors are authorized to order an increase in the number of working hours per week and to execute or change orders governing payment to the contractor for work in excess of a 40-hour week as required by the contract. No order for overtime work will be given on lump sum construction contract operations unless the overtime work will materially advance the project's completion date and where appropriate the completion date is stipulated in the changed order. If adequate to get required speed, overtime permission may be confined to one or two trades.

(continued on page 12)





# WASTING TIME.

## DOES THIS HAPPEN IN YOUR DRAFTING ROOM?

These draftsmen are busy making changes in the design of a fighter plane . . . and there isn't a day dream in the crowd. But they are wasting time—valuable time which could be saved with the Ozalid Process.

With an Ozalid whiteprint machine they could make transparent prints of the original drawings . . . apply Ozalid Corrector Fluid to the obsolete lines and then draw in the new designs. Thus, they could have new "originals" without tedious retracing . . . without the wasteful tie-ups encountered in altering Van Dykes.

Ozalid transparent and standard whiteprints are produced in two quick steps—*Exposure and Dry Development*. And because of **DRY DEVELOPMENT**—an Ozalid whiteprint machine is radically different from blue print equipment which requires liquid baths, driers, permanent plumbing connections and much floor space.

Ozalid's wide variety of sensitized materials may be used in the whiteprint machines built for major, medium or small print production—thus, everyone can produce prints on foil, cloth, or air mail weight paper—prints which will have blue, black, maroon or sepia lines on a white background.

If you are not already using the Ozalid Process . . . but are changing the design of your drawings . . . you are wasting time and labor. Save these essentials in war production!

Write for new catalog "Simplified Printmaking" which explains all the advantages of the Ozalid Process.

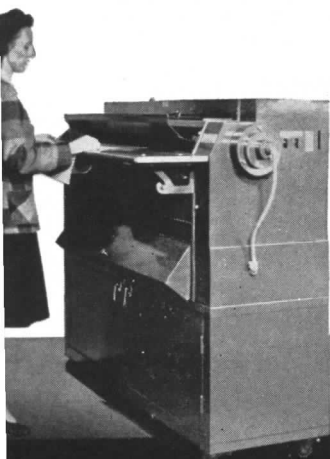

SPECIFY **Ozalid** WHITEPRINTS

**OZALID PRODUCTS DIVISION**  
GENERAL ANILINE & FILM CORPORATION  
JOHNSON CITY, N. Y.

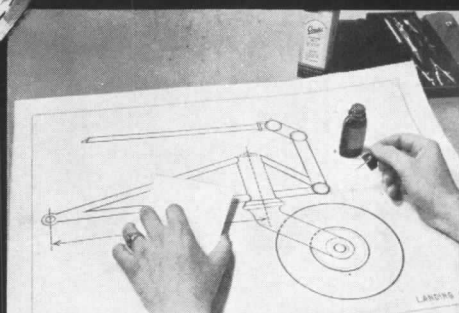

This is an Ozalid transparent print of an original tracing. The draftsman is applying corrector fluid to that part of the design which is to be changed.

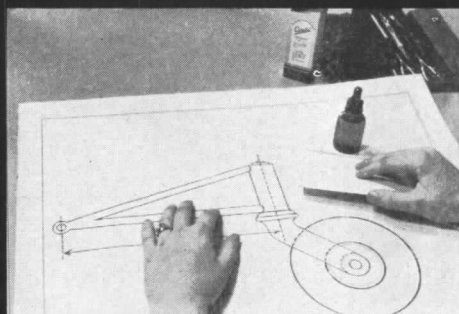

The lines are quickly eradicated . . . and the print is dried with a desk blotter. Only that part which will be the same in the "new" design remains.

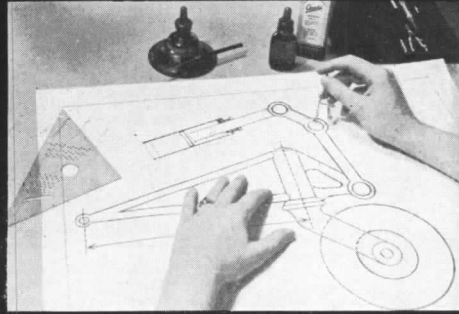

The changes are drawn in . . . and a "new" original is ready to produce subsequent prints.

# YOU CAN REDUCE THIS "AID AND COMFORT" TO THE ENEMY



Startling figures? . . . Then add to them the 19,200 deaths from plant accidents during the same period and you will understand why the Axis war lords studied this report with gloating satisfaction.

## W.P.B. RECOMMENDS GOOD LIGHTING TO REDUCE ACCIDENTS

The following appears on page one of the publication "PLANT EFFICIENCY", issued by the War Production Board:

“ Striking examples of close relationship between the quality of lighting and accident frequency are not difficult to find . . . So many factors are involved in industrial accidents that it is practically impossible to say what percentage is caused by poor lighting. It is reasonable to assume, however, that with the quicker perception and greater clarity of vision which good lighting makes possible, accident hazards will be recognized faster and more clearly, with correspondingly increased chances of avoiding them . . . ”

## HOLOPHANE HAS PIONEERED IN GOOD LIGHTING—SINCE 1898

For more than two generations, this organization has concentrated on the advancement of illumination in American institutions. All through these years, Holophane engineers, in the field and in the drafting rooms, have played an important role in the development of PLANNED LIGHTING for industry . . . Since Pearl Harbor they have shown hundreds of plants the way to faster, smoother war production through lighting engineered to meet specific manufacturing needs and working conditions . . . The Holophane principle of light control calls for prismatic glass units, which require a minimum of critical materials. They provide efficient light for essential working areas with assured savings in man hours, electric power and maintenance costs.

## FOR SAFE, EFFICIENT ILLUMINATION, CONSULT HOLOPHANE ENGINEERS

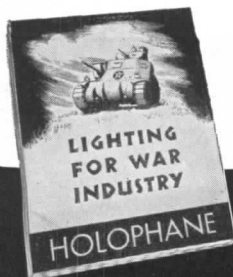

Plant management is urged to investigate the signal advantages that Holophane lighting can bring to the plant today. Without charge, the Holophane engineering department offers consultation and recommendation for the most effective, economical illumination . . . Write for the latest Holophane bulletin "Lighting for War Industry", available to plant executives.

**HOLOPHANE** CO., INC.  
342 MADISON AVENUE, NEW YORK  
HOLOPHANE CO., LTD., 385 YONGE STREET, TORONTO, CANADA

## THE RECORD REPORTS

(continued from page 10)

### Defense Rental Areas

OPA has established 97 more defense rental areas across the entire nation and including Alaska. On November 1, rents will be cut back to the levels prevailing on March 1 in 96 of the areas; in the other one (Orlando, Florida) the freeze date has been moved back to October 1, 1941. This action brings under Federal control the residential rents in every large city in America with the exception of New York. A survey of rental conditions in the New York area is now under way and OPA is seeking to develop techniques to extend rent regulation to New York. There are now a total of 287 defense rental areas, including about 70 million people. OPA has requested landlords still outside such areas to comply with provisions of the rent declaration and maintain or reduce rents to the March 1 level. OPA has in effect declared the entire country a defense rental area, thus extending nationally the control which has been exercised in 396 defense rental areas. Rents for dwelling units are stabilized at the level of March 1, 1942. In accordance with the Emergency Price Control Law, local and state authorities are given two months to reduce rentals to March 1 levels before the Federal Government steps in. OPA announces that it will amend the present regulations to close up loopholes under which landlords evade the ceiling by forcing tenants to purchase premises at exorbitant prices. OPA will give tenants security of tenure for the duration, but would make provision for bona fide sales where no change in occupancy results.

Rigid control of eviction of tenants resulting from the sale of houses has been established by OPA. Before a purchaser can obtain the right to occupy a rented property, two requirements must be met: (1) Payment of one-third of the purchase price must be made before a certificate authorizing eviction will be issued by the area Rent Director; (2) three months must pass after the issuance of the certificate before the present tenant can be forced to vacate. Money borrowed to make this one-third payment will not be considered as satisfying this requirement. Under OPA's action, landlords must now also notify OPA of all eviction actions started on grounds of non-payment of rent.

(continued on page 14)

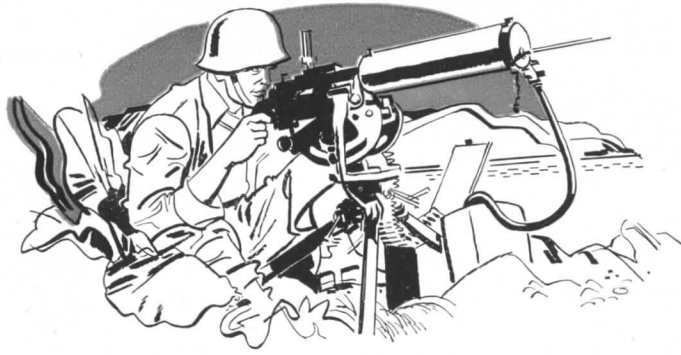

The future  
is what we're fighting for,  
isn't it?



Every reader of this advertisement believes, somehow, that the future is worth the fight. Production records say so. Your personal sacrifices say so. Your crowded hours say so.

We read your hearts as we read our own.

But what about this future, anyway? Are we going to accept it as it is served up to us, or are we folks in industry going to do a job of pre-fabrication on it?

We can, you know.

We *can* do some Imagineering, here and now. We *can* decide where we go from here. We *can* slip an eighth day of thinking time into our crowded seven-day week, if we will.

We can build new models, in our minds at least. We can take the facts and the promise of the new materials and methods we are learning about in the war, and dream them into the new products and improved services that will make new jobs.

We can even provide the wherewithal which will prime the future. Every War Bond we buy does that.

The future is more than a hope. It is a duty.

Getting together on future ideas is putting Imagineering into practice.

Might you and we do just that, for the sake of the boys who are fighting to give us all a future? ALUMINUM COMPANY OF AMERICA, 2167 Gulf Bldg., Pittsburgh, Pa.

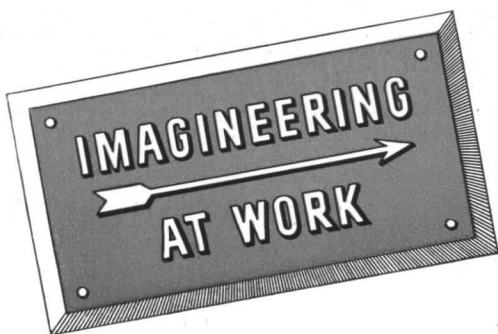

ALCOA ALUMINUM





# HERE'S SOMETHING NEW!

## —for Now or After the War



At the left the roof jacket is being dropped over the chimney section and will be nailed to the roof. The right picture shows the chimney top commonly used in low-cost war housing. Chimney tops are also available shaped like a masonry chimney, plain or enamel brick-effect finish.

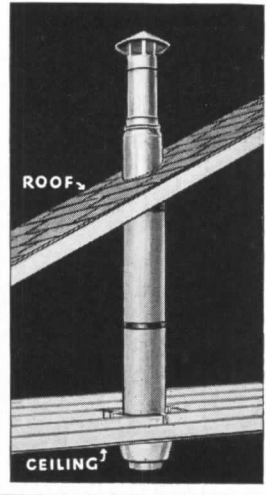

**F**OR some time now a leading manufacturer has been making a porcelain enameled metal chimney for numerous low-cost war-housing projects. If you can't use it now, remember it for your post-war work.

Architects and contractors have discovered that these chimneys have many advantages:

**1** They are extra durable. Their flint-hard, acid-resisting porcelain enamel finish resists heat and cold, acids and corrosive atmospheres—is proved by years of service on store fronts, filling stations, kitchen ranges.

**2** Tests have shown these especially designed chimneys will produce more draft than a conventional chimney of the same height. They require less space and weigh relatively little. Porcelain enameled chimneys can be used with coal, gas and oil heating equipment and are fully insulated.

**3** They are quickly installed by regular workmen. Patented expansion and contraction devices prevent leakage and damage to the roof flashing.

**4** The porcelain enamel on these chimneys is fused on ARMCO Ingot Iron at 1650° F., making the iron and its smooth coating virtually one. This special metal base was developed by ARMCO years ago and has been more widely used for this exacting purpose than any other metal.

\* \* \*

We shall be glad to have the manufacturer send you more detailed information for your current or post-war file. The American Rolling Mill Company, 3171 Curtis Street, Middletown, Ohio.

**Help Salvage Scrap Iron for Victory!**



The Army-Navy "E" pennant flies from the staff at all ARMCO plants—a reminder to every ARMCO man and woman of honors won and responsibilities to be met.



## THE RECORD REPORTS

(continued from page 12)

### BRAZILIAN ARCHITECTURE



Philip L. Goodwin

The Brazilian building at the New York World's Fair, 1939, gave architects and the public interested in architecture, a surprise. It was the excellence of the Venezuelan and Brazilian buildings, comparing them with the other foreign and general exposition buildings. The Brazilian building was designed by Lucio Costa and Oscar Niemeyer, and it showed that there was something interesting going on below the equator.

Because of this, and the desire to see what had been accomplished in the control of heat and glare on large glass surfaces in modern buildings outside of the United States, Philip L. Goodwin and George E. Kidder Smith, both A.I.A., have been spending several months this summer looking up and photographing the material to be found there. Mr. Smith was the photographer of "Stockholm Builds" and of "Lessons from Swedish Schools" (ARCHITECTURAL RECORD, October, 1942).

The January number of the ARCHITECTURAL RECORD, and a large exhibition covering one floor of the Museum of Modern Art, will show some of the results of this trip and display the choicest of a thousand black and white, and colored, photographs taken by Mr. Smith. Many original plans, personal data of some of the architects, examples of the modern tiles now being used, as well as models, will form part of the exhibition. These with many more photographs will be published in book form.

To anyone who has not been in Brazil, the variety of design both old

(continued on page 84)

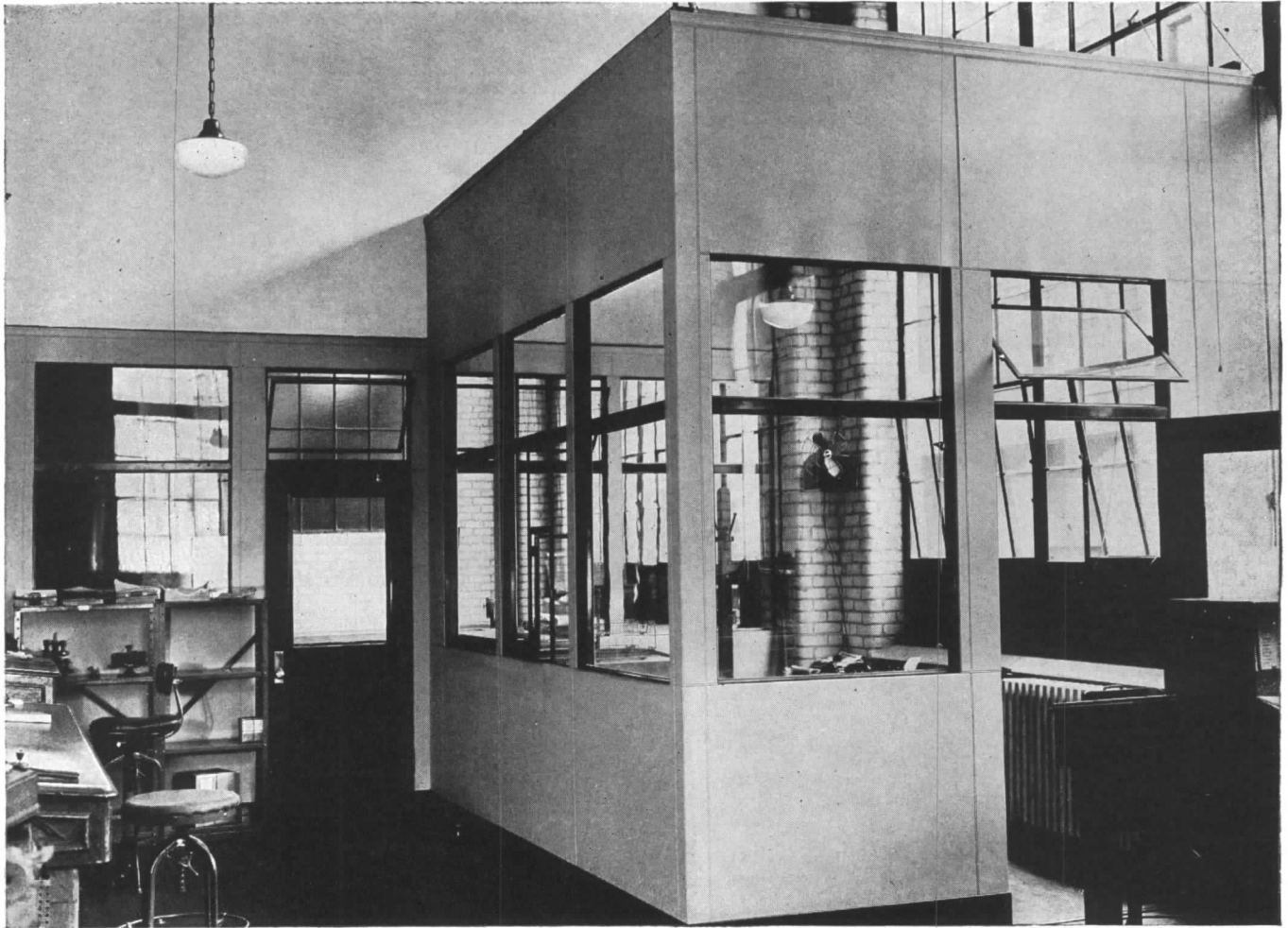

## When plant offices are needed ***FAST!***

**F**OR SPEED WITHOUT COMPROMISE ON QUALITY, specify J-M Transite Walls for plant office construction. These modern movable partitions are ideal for plant offices, because they go up in a hurry . . . and they provide long life with low maintenance. Here are other important advantages:

**RELEASES CRITICAL WAR MATERIALS.** Transite Walls are made of two plentiful materials— asbestos and cement.

**RAPID INSTALLATION.** A patented construction method makes this possible without work interruption. Relocation possible with 100% salvage.

**FIRE-RESISTANT, STRONG.** Asbestos-cement cannot burn. And Transite Walls easily stand up against all kinds of customary factory shock and abuse.

**FORMS ANY TYPE PARTITION.** Ceiling-high, free-standing, solid or in combination with glass.

**ATTRACTIVE APPEARANCE.** Natural, light-gray color just right for plant or general office use. Finish is permanent. Requires no painting, but may be waxed or painted if desired.

For details on J-M Transite Walls, see our Catalog in Sweet's or write for brochure TR-22A. Johns-Manville, 22 East 40th Street, New York, N. Y.



# JOHNS-MANVILLE

# Transite *Movable Asbestos* Walls

Reproduction of photo-mural, as shown in the Cleaver-Brooks offices, depicting representative Oil-bilt steam plant installations.

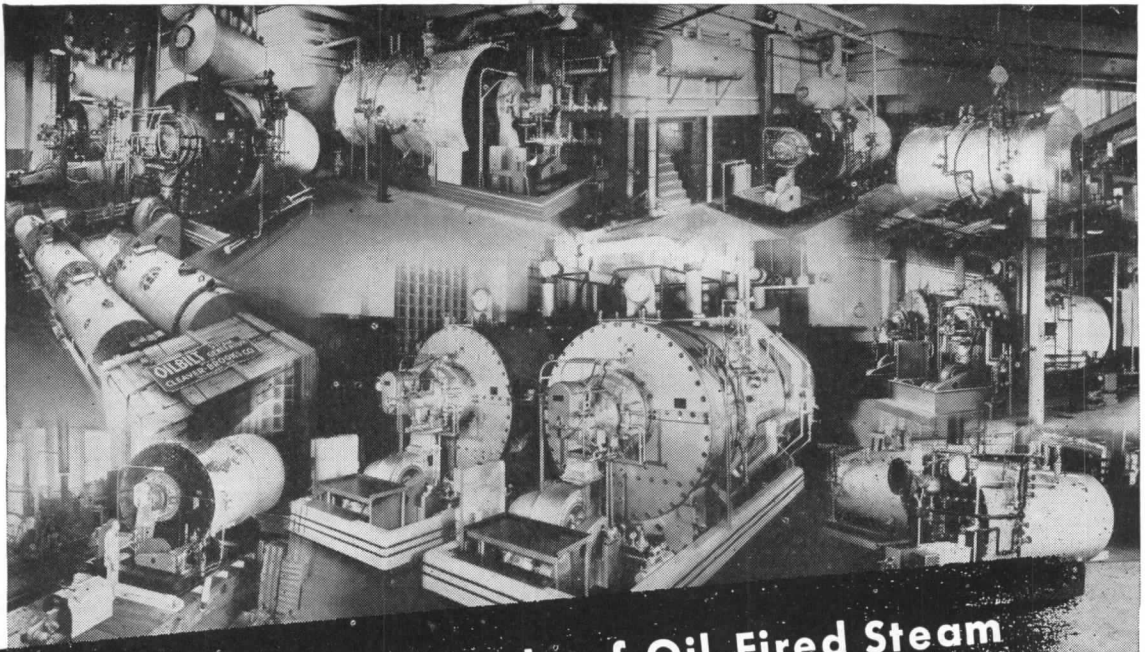

**The Cleaver-Brooks Principle of Oil-Fired Steam Generation . . . Finds a Vitally Important Application in Equipment for Our Fighting Forces**

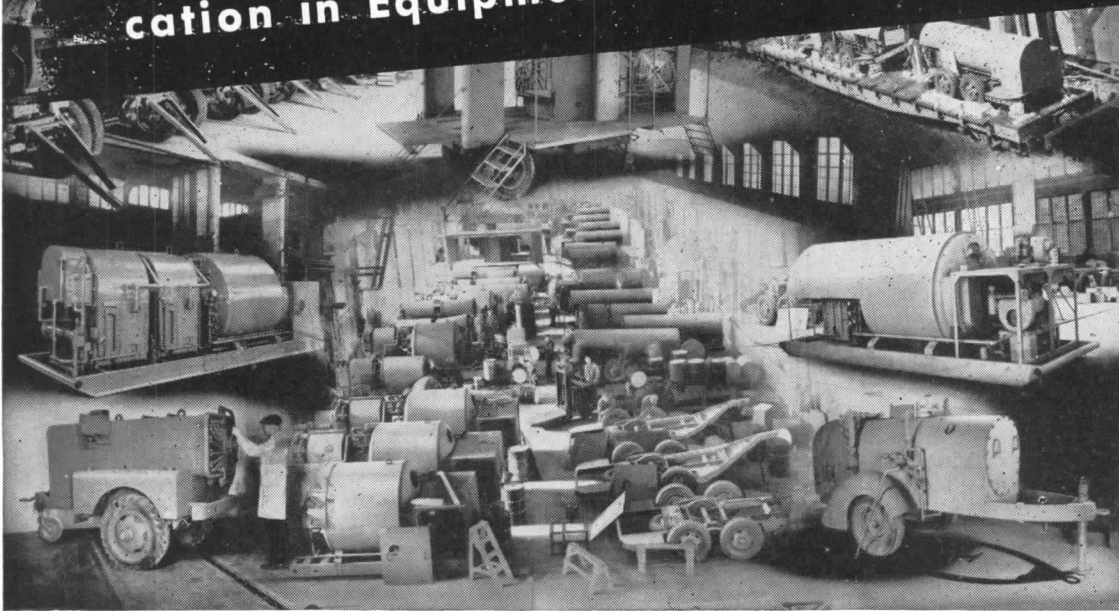

Reproduction of photo-mural which is a composite illustration of various types of Cleaver-Brooks equipment built for our armed forces.

Known for their efficient application of the multi-pass, down-draft heating principle, Oilbilt steam plants are providing steam for power and processing in hundreds of industrial establishments — helping them to meet record-breaking production schedules for war equipment.

Mobile equipment, employing the same proven principle of firing with America's ideal fuel — *oil* — and including hot water heating equipment,

special steam generating plants, portable shower bath units, distilling, sterilizing and disinfecting equipment, is contributing to the safety and comfort of our fighting forces wherever they are located.

Now manufactured for a nation at war, Cleaver-Brooks products will resume their *peacetime service* when Victory day comes.

**CLEAVER-BROOKS COMPANY**  
5119 North 33rd Street • Milwaukee, Wisconsin

**CLEAVER-BROOKS COMPANY • MILWAUKEE, WISCONSIN.**



## A CHANCE FOR CREATIVE THINKING



## "THE STORE FRONT OF TOMORROW"

THE NEW PENCIL POINTS—KAWNEER ARCHITECTURAL COMPETITION gives you the opportunity of exercising your creative ability at a time when war conditions have curtailed much of the normal demand for design work.

William Lescaze is Professional Advisor. Judges include Frederick Bigger, F. A. I. A., Washington, D. C.—Morris Ketchum, Jr., A. I. A., New York City—Samuel E. Lunden, A. I. A., Los Angeles, Cal.—Mies Van der Rohe, Chicago, Ill.—Roland Wank, A. I. A., Knoxville, Tenn.

Competition closes January 4, 1943,—write now for Program. Address The New Pencil Points, 330 W. 42nd Street, New York, N. Y.

### PRIZES

FIRST PRIZE . . . . .	\$1,000.00
SECOND PRIZE . . . . .	500.00
THIRD PRIZE . . . . .	250.00
5 HONORABLE MENTIONS	
\$100.00 . . . . .	500.00
	<u>\$2,250.00</u>



RUSTLESS METAL STORE FRONTS • DOORS • WINDOWS  
THE KAWNEER COMPANY • NILES, MICHIGAN

# REQUIRED READING

By ELISABETH COIT, AIA



Pembroke College, Entrance Gateway. From "Architecture in Cambridge."

**ARCHITECTURE IN CAMBRIDGE.** By Theodore Fyfe. New York, Macmillan (60 Fifth Avenue); Cambridge, At the University Press, 1942. 120 pp., 5 1/4 by 7 7/8 in., illus. \$2.00.

BY INCLUDING nearby Ely Cathedral in his survey, the former director of the Cambridge University School of Architecture gives us practically an epitome of English architectural styles from the later Saxon to modern times, complete except for the timber-framed house. Thirty-one line drawings form the plates which are accompanied by detailed descriptions, and there are a score more drawings in the introduction. A mellowly ripe work in the best University Press tradition, and an evidence of how, even in days such as these, time and material may be found for fine things of essential appeal.

**THE OLD BAY PATHS.** By George Francis Marlowe. With photographs by Samuel Chamberlain. New York, Hastings House (67 West 44th Street) 1942. 126 pp., 5 1/4 by 8 1/4 in., illus. \$2.00.

SOON after the last war Mr. Chamberlain, fresh from M.I.T.'s School of Architecture, began portraying his world in drawing, drypoint and photograph, with emphasis on the American scene, on architecture and kindred subjects. On appointment last month as captain in the Air Force, he left material for the last five of thirty-nine

books either published or definitely scheduled for publication by Hastings House, a firm which in recent years has given us almost a pictorial "American Guide." "The Old Bay Paths," the history of the two early routes from Boston to Hartford, will be read for a good story well told; here our main interest is in the sureness with which the photographs of old stone house, village green, common, church, shaded street, home-stead, farm . . . combine the purely picturesque of man-made scenes with vision of the life and emotions of the makers of this folk-architecture.

**A BRIEF COMMENTARY ON EARLY MEDIAEVAL CHURCH ARCHITECTURE;** With Especial Reference to Lost Monuments. By Kenneth John Conant. Baltimore, The Johns Hopkins Press, 1942. 34 pp., 6 by 9 in., plus 50 plates, \$2.00.

KENNETH CONANT'S drawings command admiration wherever they may be found. In this volume, the record of lectures at Johns Hopkins for the Community Art Program of the Carnegie Corporation, the restorations by Mr. Conant and his collaborators of mediaeval church monuments are clear, informing archaeological contributions as well as handsome illustrations.

Mr. Conant disclaims "perfectionism" for his archaeology, preferring to stress the combinations and interplay of the mediaeval church building repertory, "open hall, pillared hall, basilica, rotunda, shed form, tower and spire."

Five plates showing vault forms, from barrel to quincunx, illustrate in diagram these combinations. The others (forty-five, plus J. Bannister Turpin's Cluny frontispiece) present examples of restored churches or monasteries selected from a wide geographic circle centered on the Mediterranean.

The buildings chosen, if they exist today, are in bits and pieces, or in altered form. Mr. Conant's restorations not only show the original building, but show the view best calculated to illustrate the architectonic combinations used. The text, likewise, stresses construction, without thereby losing suavity or clarity. A

book advisedly described as delightful, and, as the author says of Gothic building, "in some ways, beyond architecture."

**MODERN CAMOUFLAGE.** By Robert P. Breckenridge. New York, Farrar and Rhinehart (232 Madison Avenue) 1942. 280 pp., 5 1/4 by 8 1/2 in., illus. \$3.50.

TO GIVE the "average reader" an appreciation of the fundamentals, technique and materials of the new almost-science of protective concealment, Major Breckenridge of the Corps of Engineers writes a concise and comprehensive outline with a minimum of technical language.

To the books by Chesney, Wittman, and Root (ARCHITECTURAL RECORD, August, '42, p. 24), the camouflage sections of Glover and of Wessman and Rose (ARCHITECTURAL RECORD, March, '42, p. 26) and of the British and United States Governments, it makes a valuable addition by its inclusion of the U. S. Army Engineers' Standard Camouflage colors. While the book will have general appeal, it will especially profit younger people and laymen apt to be confused and discouraged by more technical and more closely documented works.

**EVALUATING RURAL HOUSING.** By Charles I. Mosier. Gainesville, Florida, University of Florida, 1942. 88 pp., 6 1/4 by 9 1/8 in., tables, illus. \$0.50.

**FOUR PAPERS ON HOUSING DESIGN:** Monographs on site and unit planning. Chicago, National Association of Housing Officials (1313 East 60th Street) 1942. 39 pp., 8 1/2 by 11 in., illus. \$0.50.

**HOUSING REGULATION IN WAR TIME.** New York, Community Service Society (105 East 22nd Street) 1942. 39 pp., 6 by 9 in., gratis.

HOUSING construction is halted by the war; but priorities do not retard thought and planning.

The University of Florida Project in Applied Economics, taking a long range view of rural housing, hopes to write "functional" pupil texts to enable future generations to design better houses and to desire attractive houses in good condition. Meanwhile, with a grant from the Alfred P. Sloan Foundation, it issues a report on a 102-item questionnaire sent out via the rural schools and a statement of

(continued on page 20)



**P**ARACHUTES for air-borne invasion . . .

Carrying the attack to the enemy . . .

It's the goal of American Industry to train and equip more paratroopers than the Axis ever dreamed of—and that goal will be achieved.

It calls for new plants to produce the synthetic fibres needed in such tremendous quantity . . . plant conversion to meet many of the production problems involved.

In every war plant, heating is a vital consideration . . . for proper heat is essential to maximum output.

For 50 years, steam has proved its ability to provide steady, even, economical heat in buildings of every type.

Steam, harnessed and brought under control with Webster Systems of Steam Heating, has been used successfully in more than 75,000 buildings.

Today, we are engaged in direct war work but manufacturing facilities are still available to supply Webster Steam Heating Equipment for buildings serving the war effort.

Essential repairs for Webster Systems are available on A-10 priority, under W.P.B. Emergency Repair Order P-84. Orders should be limited to actual needs.

Warren Webster & Company, Camden, N. J. Representatives in 60 principal Cities



This is one of a series of advertisements that will tell the public of the part that Webster Steam Heating and the Webster organization plays in the war effort . . . appearing regularly in leading business, industrial, engineering and technical publications.



L. A. Cherry, of Cherry, Cushing & Preble, Consulting Engineers, Buffalo, N. Y. Member of American Society of Heating and Ventilating Engineers. M. E., Vanderbilt University.

*"The reduction of wasteful overheating with modern central steam heating controls is an important contribution to the war effort,"* says L. A. Cherry. "It saves needed fuel and takes some of the burden off the transportation system. By keeping heat loss as small as possible, a building owner reduces his own overhead expense and increases the comfort and working efficiency of building occupants. When compared with the results achieved, the cost of modern central steam heating controls is very reasonable. Operating cost is low because simplicity of equipment assures easy adjustment."

As consulting engineer for Our Lady of Victory Homes of Charity, Lackawanna, N.Y., L. A. Cherry specified the Webster Moderator System of Steam Heating for the Administration Building in 1938, the Infants' Home in 1939, the Hospital Building in 1940, the Orphans' Home in 1941, the new Nurses' Home in 1942. The heating of Pierce's Proprietaries Building, in Buffalo, is also "Controlled-by-the-Weather" with a Webster Moderator System according to plans made by this engineering firm.

**WARREN WEBSTER & COMPANY**  
CAMDEN, N. J., EST. 1888, PIONEERS OF VACUUM STEAM HEATING



# 26 of America's leading Architects and Engineers have reviewed their experiences with OIL BURNING SYSTEMS . . .

IN pre-war building architects and engineers found that Petro Oil Burning Systems resulted in owner profit and customer comfort in commercial buildings; that they provided clean, quiet surroundings in the hospital; that they lived up to their qualities of sturdiness and economy for industrial plants; and that they meant healthful living conditions for the pupils in the classrooms.

Now in our war program, Petro equipment is only available on high preference ratings, but present equipment continues to meet its most rigid test in the constant 24-hour service required in hundreds of war production plants, together with commercial buildings and schools and hospitals everywhere. And Petro engineering service endeavors to make sure that Petro Systems perform a hundred per cent wartime job.

This series of discussions of Petro Oil Burning Systems has, to date, included comment by these well known men:

Roy D. Bassette, of Smith & Bassette, Architects, Hartford, Conn.  
G. Kendrick Bringham, Consulting Engineer, Philadelphia, Pa.  
Frank W. Crimp, of Adden, Parker, Clinch and Crimp, Architects Boston, Mass.  
Wilson C. Ely, of John H. & Wilson C. Ely, Architects, Newark, N. J.  
J. Hunter Field, of Cross & Cross, Architects, New York  
Charles M. Hart, Architects, New York  
Walter Hesse, of Bloch & Hesse, Architects, New York  
C. H. Higginson, of Wm. Higginson & Son, Architects and Engineers, New York  
Alfred L. Jaros, Jr., of Jaros, Baum and Balles Engineers, New York  
Ely Jacques Kahn, Architect, New York  
Morris Ketchum, Jr., Architect, New York  
George Kosmak, Architect, New York  
R. E. Marsh, of Tooker & Marsh, Architects, New York

Henry C. Meyer, 3rd, of Meyer, Strong and Jones, Engineers, New York  
Henry V. Murphy Architect, Brooklyn, N. Y.  
Charles F. Neergaard, Hospital Specialist, New York  
Nathaniel A. Owings, of Skidmore, Owings & Merrill, Architects, Chicago and New York  
Sullivan A. S. Paterno, Consulting Engineer, New York  
James Otis Post, of George B. Post & Sons, Architects, New York  
Alonzo B. Reed; Engineer, Boston, Mass.  
Emery Roth, of Emery Roth & Sons, Architects, New York  
Max Siegel, Professional Engineer, New York  
Thomas Stapleton, Architect, New York  
Oscar Vogelbach, Engineer, Newark, N. J.  
Joseph Watterson, Architect, Mineola, Long Island  
G. Morton Wolfe, Architect & Engineer, Buffalo, N. Y.

OIL IS AMMUNITION  
USE IT WISELY

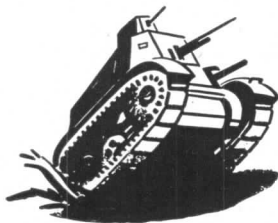

**PETRO**  
Cuts Steam Costs

**PETROLEUM HEAT AND POWER COMPANY**  
STAMFORD —Makers of good Oil Burning Equipment since 1903— CONNECTICUT

## REQUIRED READING

(continued from page 18)

its survey method, which in addition to securing information needed in Florida will be of value to the framers of housing inventories elsewhere.

The "Four Papers" selected for publication by NAHO are Eero Saarinen's "Architecture and Defense Housing," forward-looking thoughts on opportunities in design expressed in few and telling words; "Planning Housing for People," a penetrating statement on accommodation for families of unusual sizes by Catherine F. Lansing of the New York City Housing Authority; a reprint of Albert Mayer's article in the *May Pencil Points* entitled "What's the Matter with Our Site Plans;" and a reproduction of "Housing from the Tenant's Viewpoint" compiled by the ARCHITECTURAL RECORD (April, 1942) from a study by Elisabeth Coit.

The war on substandard housing ceaselessly waged by the C.C.S. Committee on Housing is as strenuous as it is unromantic and unphotogenic. But it is not without its rewards, among which must be this record: partly for the achievement reported, partly for the statement of the problem and the manner of solution here made available for other groups with similar aims.

**RECOMMENDED PRACTICE OF OFFICE LIGHTING.** New York, Illuminating Engineering Society (51 Madison Avenue) 1942. 47 pp., 6 by 9 in., illus. \$0.25.

CLEAR TECHNICAL and psychological explanation of how natural and artificial lighting may best conserve the office force's effort. Classification of difficult, ordinary, casual and simple seeing tasks and specific recommendations are so lucid and clear that readers whose personal preferences make them slow to accept certain statements regarding color in walls and furniture will doubtless be won over.

**NATIONAL PAINT DICTIONARY.** By Jeffrey R. Stewart. 2nd ed. Washington, D. C., Stewart Research Laboratory (1340 New York Avenue N.W.) 1942. 224 pp., 9 by 12 1/4 in., illus. \$7.50.

A MANY-SIDED reference work designed for chemists, contractors, manufacturers, distributors . . . consumers, by the director of the *National Paint Bulletin*, enlarged from the first edition of 1940. In one alphabet are conveniently listed and explained trade names, names of devices, processes,

(continued on page 80)

# NO INKING - IN . . . CUT TIME AND COST OF BLUEPRINTS

That's industry's urgent demand on the drafting room these days. VENUS TRACING Pencils are the answer. They give perfect blueprints and save the time and cost of ink.

A member of the VENUS DRAWING Pencil family, VENUS TRACING Pencils are now made in 4 special degrees. There's T<sup>1</sup>, the softest for smoother surfaces. T<sup>2</sup> and T<sup>3</sup>. Now we have added T<sup>4</sup> for the hard tooth of some of the newer tracing cloths and tracing papers.

VENUS TRACING Pencils draw opaque, black lines that erase cleanly and do not smear or smudge. That means, clear, crisp, clean blueprints, free from cloudiness or "ghosts".



Would you like samples of these new pencils? Just drop us a line on your letterhead.



**VENUS**

*The AMERICAN Drawing Pencil*

AMERICAN-MADE FOR 35 YEARS

AMERICAN PENCIL COMPANY, Dept. B5, 500 Willow Avenue, Hoboken, N. J.



The bonds a well-built house pays for

The Turner's bank would like to see they are the sturdy bonds of a well-built house. U.S. War Bonds are the best bonds you can buy. On Elm Street, you would see the Turner's bank. It has a fine house—framing in the hands of the metal workers. The Turner's bank would like to see they are the sturdy bonds of a well-built house.

Hats off to these unsung guardians of your health

Copper and brass are used to help in many ways. The unsung guardians of your health are the copper and brass workers. They are the unsung guardians of your health. They are the unsung guardians of your health. They are the unsung guardians of your health.

**Copper & Brass**

Lucky Mrs. Wilson... especially on Mondays

Mrs. Wilson has often blessed the day she bought her water heater. It is so comfortable, it is so safe, it is so handy. It is so handy that she has no trouble with it. It is so handy that she has no trouble with it. It is so handy that she has no trouble with it.

**Anaconda Copper & Brass**

Quartermaster to the American Home

The Quartermaster to the American Home is the water heater. It is the Quartermaster to the American Home. It is the Quartermaster to the American Home. It is the Quartermaster to the American Home.

**Anaconda Copper & Brass**

**A Contribution**

The desire for comfortable and gracious living... so ably satisfied by you... has not dissolved in the crucible of war. It is being kept alive by such messages as you see here. Reminded that copper and brass are vital to victory, Americans also are reminded of the economies and comforts these metals can bring them

**Anaconda**





Meet America's only 5-star General

Also what a job she is doing! Making the home budget perform feats of wartime magic. Taking care of her health, her family, her uniform or on medicine, whether in uniform or on a war job. Looking after the thousands and more things that keep a home going—and still managing to find time for Red Cross work and perhaps the War Bond campaign.

She's hard, of course, but that's why she's so important to winning the war. She's the woman who's making the home front a long-lasting

hardware... weather-ripping... kitchen utensils... new tanks... Allied ammunition. New tanks... pipe blanking and his water tanks... of rustproof lexline. Metal are... available... these metals are needed for tanks and planes and ships. For... of rustproof lexline and down... now make way for the electric... of war industries.

But our 5-star will make our war is... Copper will be back at it... useful if...

**Anaconda**

He can plot the future in the plans of today

The title on his office door is "Architect"—but it scarcely does him justice. His has been a leading part in making America a nation of modern skyscrapers, efficient factories and comfortable, livable homes.

Today his skill is devoted almost entirely to war-vital projects. Almost all materials for homes he would like to design are not available. Copper and brass and bronze are needed to help fight the war. He, of all people, appreciates the necessity. For the very qualities that make these metals so indispensable for home construction

make them doubly vital for war production... for ammunition, for planes and ships—and for the electrification of the plants that produce them.

But your architect can look ahead with confidence. Much of the war-time design he is developing today also counts on. When the present emergency is over, Anaconda's Copper, Brass and Bronze—for rustproof piping, for downspouts and flashings, for weather-stripping—will

be re-applied to the new buildings that will be built. He can look ahead with confidence. Much of the war-time design he is developing today also counts on. When the present emergency is over, Anaconda's Copper, Brass and Bronze—for rustproof piping, for downspouts and flashings, for weather-stripping—will

**Anaconda Copper & Brass**

One man you ought to keep in mind

You may not even know him—the man who's been in the mind of the American people. He's the man who's been in the mind of the American people. He's the man who's been in the mind of the American people.

Today, the long-anticipated war production is needed for the building of the future. The man who's been in the mind of the American people is the man who's been in the mind of the American people.

Like your building company, he's looking for the man who's been in the mind of the American people.

**Anaconda Copper & Brass**

# to Better Building!

when peace returns. With you, they look forward to the day when copper and brass plumbing can again be counted on to save the inconvenience and expense caused by rust. The Everdur\* water storage tanks they seek are doing duty in the fight for victory. But, they'll be back too . . . serving long, and saving the

unpleasantness of hot water discolored with tank-generated rust. And, although less durable materials must be used for flashings today because copper is now making munitions for our armed services, peace will likewise bring the durability and economy of copper sheet metal work back to American homeowners.

When this tremendous job of war is finished, authorities expect a long period of active building. The architect will inevitably play the leading role in adapting old and new materials, new products and new methods into a pattern for building that will bring new living standards and new economies to the American scene.

## Copper & Brass

\* Trade Mark Reg. U.S. Pat. Off.

**THE AMERICAN BRASS COMPANY**  
 General Offices: Waterbury, Connecticut  
 Subsidiary of Anaconda Copper Mining Company  
 In Canada: Anaconda American Brass, Ltd., New Toronto, Ont.

# MODERNIZING IDEAS

★ *that sparkle with decorative interest*



**A Smart Dress Shop** provides privacy and softly diffused light in its fitting room by the use of Satinol Flutex Glass. Mills, Rhines, Bellman and Nordhoff, Inc., Architects.



**A Beauty Shop** in Saks Fifth Avenue, Chicago, provides soft flattering light over the dressing tables, through Satinol Flutex panels, lighted from behind. Architect, James F. Eppenstein.



**An Office** installation demonstrates the beauty and modern efficiency of Satinol Flutex for partitions. Privacy is assured without blocking light from adjoining rooms.

## YOU CAN GET GLASS!

Decorative Glass, with its many practical advantages, is now being extensively used for modernizing jobs to replace materials no longer available. Blue Ridge patterned glasses admit an abundance of soft, diffused light—with perfect privacy. They reduce painting and refinishing costs—lend modern beauty to windows, panels and partitions. They are manufactured by the Blue Ridge Glass Corporation, Kingsport, Tenn., and sold by Libbey-Owens-Ford through leading glass distributors. Write Blue Ridge Sales Division, Dept. 1284, Libbey-Owens-Ford Glass Company, Toledo, Ohio.



**BLUE RIDGE *Decorative* GLASS**

FOR SOFT, DIFFUSED LIGHT • SMART DECORATION • COMPLETE PRIVACY



REMEMBER THE  
"3EX's"

LOUVREX

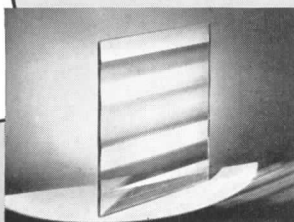

FLUTEX

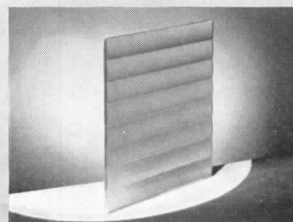

DOUBLEX

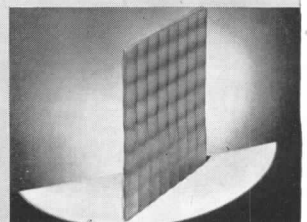

# MAHON Rolling Steel DOORS



## The MODERN Protective Closure for OUTSIDE or INSIDE Openings

The extensive line of Mahon Rolling Steel Doors offers the modern means of protection for any type of commercial or industrial building—whether for outside wall openings (as illustrated above) or for partition walls, elevator shafts, etc. Operation—by power, chain gear or hand crank—is smooth and positive, always. The interlocking slat construction presents an attractive, evenly patterned appearance. Comparison, point by point, will disclose the reasons for the thousands of installations from coast to coast—in fact, all through the western hemisphere. See Sweet's for full information or write us direct.

**THE R. C. MAHON COMPANY • DETROIT, MICHIGAN**

*Representatives in Principal Cities*

Manufacturers of Rolling Steel Doors, Shutters and Grilles; Kalamein and Tin Clad Doors, Steel Roof Deck and Cast Iron Roof Sumps.

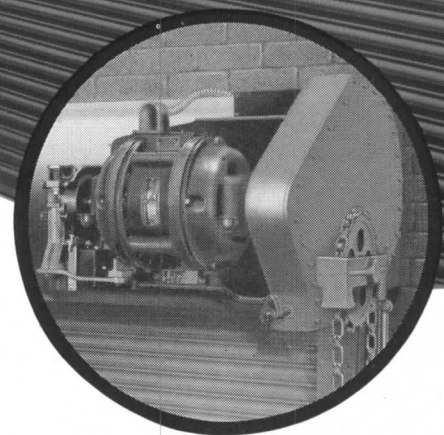

### The Mahon Power Operator runs in a bath of oil

All gears in this Mahon Power Operator are enclosed in an oil-tight gear box—run in a bath of oil. Chain-gear, manual operator functions independently—does not drive through motor shaft as is the common practice.

# MAHON



*Less Steel* SUPPORTS THE SAME LOAD.. SAFELY



## ... WITH WELDED CONSTRUCTION

Many architects specify welded steel construction because structures built by this modern method require considerably less steel. This important saving in materials is gained mainly through reduction or elimination of metal overlapping to make sound, permanent connections, and through efficient utilization of the full section of truss members.

Many other advantages of welded construction explain its long growing popularity with architects, designers and draftsmen. Greater freedom of design is made

possible by the versatility of welded fabrication . . . remodeling and additions are simplified because less removal of existing floors and walls is required. Construction is faster because drilling and punching operations are eliminated and shop handling of heavy, cumbersome members is reduced. More small units are employed and joined on the job.

The services of our Applied Engineering Department are at your disposal for consultation on your design problems.

# Air Reduction

General Offices: 60 EAST 42nd ST., NEW YORK, N. Y.

IN TEXAS

MAGNOLIA-AIRCO GAS PRODUCTS CO.

General Offices: HOUSTON, TEXAS

OFFICES IN ALL PRINCIPAL CITIES



**OXYGEN IS PRODUCTION — *Don't Waste it!***

**WHERE SPACE  
IS  
LIMITED**

**MULTI-BREAKER  
DISTRIBUTION PANEL**  
Type MH—230 Volts A. C.  
(or less) 1, 2 and 3 pole  
branches, 15-100 amp.

# Column-type **SQUARE D** PANELBOARDS

Mounting space for electric lighting and power distribution panelboards in modern industrial plants is often limited to H-beams, supporting pillars or narrow wall separations between windows. These are ideal applications for Square D streamlined column-type panelboards.

These panelboards are narrow—as little as 7¼" width in the Multi-breaker lighting panelboards. They will fit into spaces which cannot accommodate standard type panels. Available with circuit breakers, Multi-breaker branches, or with fusible circuits—plug or cartridge. All of them carry the Underwriters' approval.

A Square D sales engineer will be glad to help you in selecting the type best adapted to any particular job.

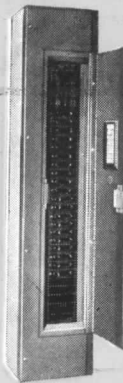

**CIRCUIT BREAKER  
LIGHTING PANEL**

Type NA1B—125-250 Volts A. C.-D. C. 1, 2 & 3 pole branches 15-50 amp.

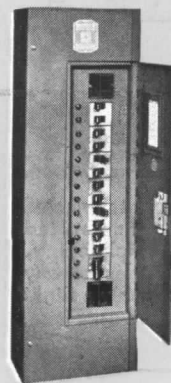

**MULTI-BREAKER  
LIGHTING PANELS**

Type NMM—115-230 Volts A.C. 1 & 2 pole branches, 15-50 amp.

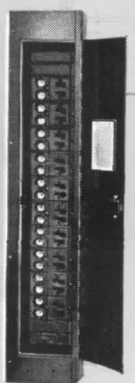

**FUSIBLE LIGHTING  
PANELBOARDS**

Type NRTC—125-250 Volt A.C.-D.C. 1 & 2 pole branches, 30 amp., plug or cartridge fuses.

CALL IN A SQUARE D MAN

**SQUARE D COMPANY**

DETROIT - MILWAUKEE - LOS ANGELES  
KOLLSMAN INSTRUMENT DIVISION, ELMHURST, NEW YORK  
IN CANADA: SQUARE D COMPANY CANADA LIMITED, TORONTO, ONTARIO



# Weather-Tested

against

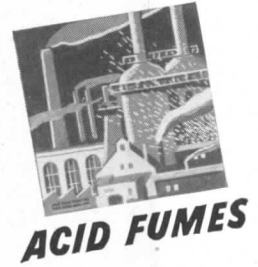

# APS

## ROOFING • SIDING • FLASHINGS

The wide acceptance of A P S Roofing, Siding and Flashings is indicated by the large number of outstanding industrials who have bought it repeatedly for uses under the most extreme corrosive conditions.

A P S Sheets have been *Weather-Tested* by Pittsburgh Testing Laboratories, and the results prove the value of the *Weather-Tested Coating*, an exclusive feature of A P S.

Get our latest *Engineer's Handbook*, illustrating and describing the tests as well as giving useful information.

### LEVINSON STEEL SALES CO.

National Distributors for APS Roofing & Siding

33 Pride St., Pittsburgh, Pa.

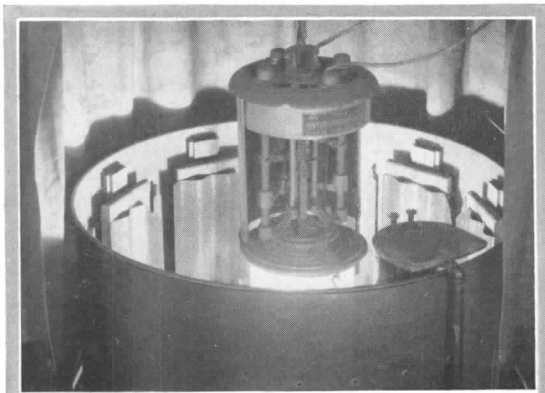

**WEATHER-TESTED FOR EXTREMES**— Here, in the Weather-Ometer, A P S panels were exposed to arc-light at temperatures up to 140°F., and then tested in cold-box at 10°F. below zero!



Asphaltic-coated sheet subjected to accelerated weathering. After 86 days definite rusting occurred.

Regular APS sheet subjected to 135 days' accelerated weathering. No checking, cracking or failures of any kind were found, only a slight dulling of the coating.

### Triple Protection

- 1 Steel protects the structure
- 2 *Weather-Tested* compound protects the steel
- 3 Mica protects and reinforces the *Weather-Tested* compound

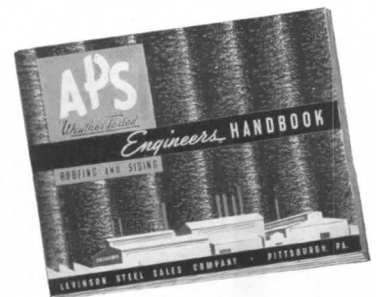

Send for this  
Engineers Handbook



# Quicker Production - Better Lighting with Day-Brite Industrial Fixtures

The DAY-LINE CONTINUOUS  
For 2-40 watt, 3-40 watt  
and 2-100 watt lamps.  
WITH NON-METALLIC REFLECTORS



The DAY-LINE UNIT  
For 2-40 watt, 3-40 watt  
and 2-100 watt lamps.  
WITH NON-METALLIC  
REFLECTORS

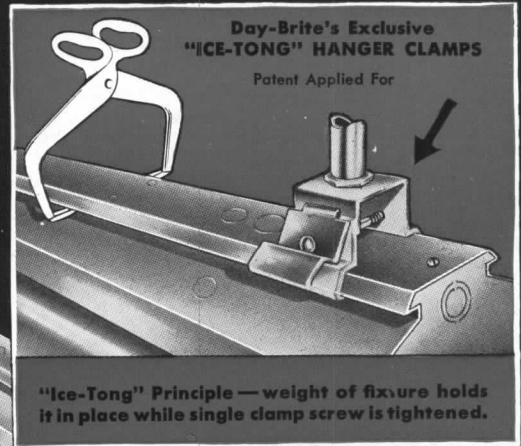
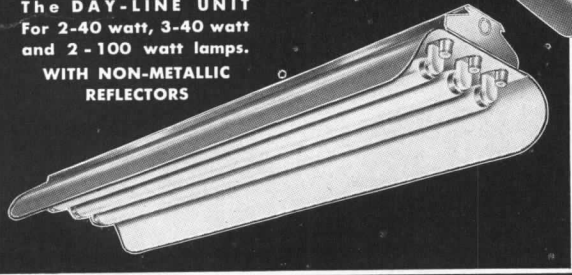

"Ice-Tong" Principle — weight of fixture holds it in place while single clamp screw is tightened.

## THE DAY-BRITE LINE IS COMPLETE

Factory, Office or Engineering Department Fluorescent Lighting Fixtures of all types—all engineered to fully utilize the higher efficiency of fluorescent lighting.

THREE ADVANTAGES are combined in the Industrial Series: (1) High reflection values and long life are assured by Day-Brite's "Super-White" baked enamel finish on non-metallic reflectors . . . (2) Speed in installation and ease of servicing are achieved through simplified mechanical design . . . (3) Maximum rigidity of the entire installation is assured by truss-like construction.

Call your Day-Brite Engineering Representative.  
**DAY-BRITE LIGHTING, INCORPORATED**  
5431 Bulwer Ave. St. Louis, Missouri



Design Patent No. D-133,458  
Other Patents Pending



The COMPLETE LINE OF FLUORESCENT LIGHTING FIXTURES *Nationally distributed through all leading electrical supply houses*



RECOGNIZED

*Experience*

*New Airplane  
Engine Plant in  
the Middle West  
Designed  
by Albert Kahn,  
Associated Architects  
and Engineers, Inc.,  
Detroit.*

ONCE MORE, Minneapolis-Honeywell helps those who help! In this new airplane engine plant in the middle west, M-H Controls govern conditions to help speed production. • No matter what control requirements may be—whether for a sleek, new modern building like this outstanding plant designed by Albert Kahn—or for an

older plant being converted to war production—Minneapolis-Honeywell has the experience, the knowledge and the facilities to produce exactly the results desired—at minimum expense. Minneapolis-Honeywell Regulator Company, 2804 Fourth Avenue South, Minneapolis, Minnesota. Company owned branches in 49 principal cities.

**MINNEAPOLIS-HONEYWELL**  
*Regulator Company*

# HIGHER STANDARDS OF LIVING



**E**VEN our President has forecast "lower standards of living" for Americans for the duration. In the public press, over the radio and in the speeches of those who are in such strategic positions we are constantly being warned to expect lower standards of living. It must be so. Yet there are millions now who are earning more than they have in years, enjoying relative prosperity, saving through War Bonds as added security for the future. The warning is that there will be, of necessity, less consumer goods to purchase and enjoy. There will be enough of the necessities, we are assured, but not more, and the luxuries will disappear. Yet I believe there will be, and already is, a "higher standard of living" in America. It all depends on our definition of those three words, "standard of living."

◆ The words themselves are simple and clear but they are susceptible to so many interpretations, to many different meanings. "Living" is an all-embracing term, implying the full range of human actions and aspirations—the satisfaction of all our needs and desires. Yet the term, "standard of living" has come to mean, "level of physical existence" or "average acquired possessions." That is a quantitative rather than qualitative definition. Of course the "standard of living" under this usual accepted definition must be lower in America, as it is everywhere else, since our productive capacity is concentrated on the tools of war. We can learn to do without many things and be the better for it. We will be a healthier nation when this war is over, due to a better balanced diet, even if less in quantity, and to more outdoor exercise now that walking and bicycling are popular perforce.

◆ But there are moral, intellectual, spiritual and human "standards of living" and these are higher now than before Pearl Harbor. These usually go hand in hand with higher levels of "creature-comfort standards." Paradoxically however, in these realms, standards may be raised by adversity. There is more righteous indignation about injustice, dishonesty, cruelty, and oppression today than before Lidice. More sense of loyalty, of responsibility, of helpfulness, more spirit of cooperation and mutual understanding exists today than ever in recent years. More men are thinking seriously in terms of liberty, equality, fraternity—in the midst of this war for power, materials and markets—than ever fought for them behind the barricades of Paris. The Atlantic Charter portends a higher standard of international living, on moral as well as physical grounds, than the world has yet seen.

◆ And in the lives of the average Americans there is a new idealism, a greater sense of duty, a more sincere seriousness of purpose that is not wholly selfish. Men now are more esteemed for what they do and are than for what they have. Men are more willing to serve their fellow men, and their greatest reward is in the personal satisfaction they take in a job well done.

◆ If this spirit engendered in the winning of the war can come to maturity in the winning of the peace, the future will be exceedingly bright and many of the problems of rebuilding a better America for every man, for every family, will be easier of solution. With that motivation, intelligence can direct our productive capacity to the creation of better communities, cities, regions—and a "higher standard of living" in every sense of the words will indeed be possible.

*Kenneth F. Stowell*

EDITOR-IN-CHIEF



# FUNCTIONS, FACTORS AND FUTURES



In reshaping the building industry for its war and postwar tasks the questions of just what the objectives are, who can best do each part, and how organize for greater efficiency may be clarified by a brief analysis of present trends.

IT'S no news to the building industry that the war has brought many upsetting changes. More are indicated as the war goes on—and the coming of peace will bring still further modifications both in the needs for buildings, and the ways of meeting those needs. Nor will the changes be limited to materials, equipment and construction methods. We can expect at least equal and perhaps more far-reaching modification in the social, economic and political controls that underlie and profoundly affect all buildings.

Changes will be brought about as the result of many forces and factors and their interactions, most of them beyond the control of the building industry itself. To the inevitability of "death and taxes" we can add the inevitability of change. And now more rapid change. How much can the various factors within the industry contribute to those changes—both external and internal, and how will they be affected by them?

The building industry will undoubtedly be called upon in the post-war period to give employment as well as to provide buildings for every purpose. To get ready for that task, both for the immediate postwar period and the longer period of reconstruction, the necessity for defining its purposes, analysing its problems, and organizing its thinking, seems obvious.

## THE PERENNIAL QUESTIONS

TO BETTER understand the problems the building industry will face in the postwar world, and to that extent, to aid in solving them, several basic questions are worthy of consideration now before it is too late.

For what does the complex industry exist? What are, or should be, its purposes or objectives? What are the functions that must be performed to accomplish those purposes? Who is best qualified to perform each of the necessary functions? How can these component parts be better organized to operate more efficiently and effectively?

Periodically the various factors which have a major stake in building become introspective and give thought to such questions, to themselves, to their collaborators (or competitors) and to tomorrow. Usually this serious mood comes on in time of comparative inactivity in an effort to account for such a state and to correct it. This time there is complete inactivity in all normal building fields and abnormal volume in construction of war services. The latter leaves stranded several factors or alters their status considerably, at least for the time being.

## PERSISTENT PURPOSES

PROBABLY the most comprehensive effort to coordinate the various functions of building came about in the depression of the 30's with the formation of the Construction League of the United States. This organization, which should find scope for functioning now, was made up of practically all the factors in the construction industry. It is worthwhile to quote a few of its objectives:

- 1) "To unify the construction industry that it may plan its future and present its aspirations as an industrial unit."
- 2) "To stabilize the industry, eliminate waste, improve its ability to serve the public, coordinate research, develop its structural and economic plans, minimize unemployment and consolidate parallel endeavors."
- 3) "To promote higher standards of living, meet competition of other industries, support timely movements for proper and efficient public works, and encourage sound financing and investment in construction projects."

Today the immediate objectives of every man in the industry is to meet war needs efficiently, with maximum speed and minimum materials. The objective tomorrow will be to meet peacetime needs, efficiently, fast and with the best materials for their purposes.

## OVER-ALL OBJECTIVES

ALL WHO ARE vitally interested in the welfare of the building industry should have, and probably do have, the same objectives, consciously or unconsciously. These might be summed up in one sentence: "More and better buildings to meet real needs more economically." To be more specific the purposes are:

1. To anticipate the needs for building more accurately, by being informed of present facilities, current activities and significant trends.
2. To provide buildings more efficiently to meet those known needs; i.e.:
  - a) Buildings better planned, constructed and equipped to serve their special purposes.
  - b) Buildings more economical in cost, both first cost and operating-and-maintenance costs. Therefore buildings erected according to scientifically determined standards of material and equipment

(Continued on page 34)

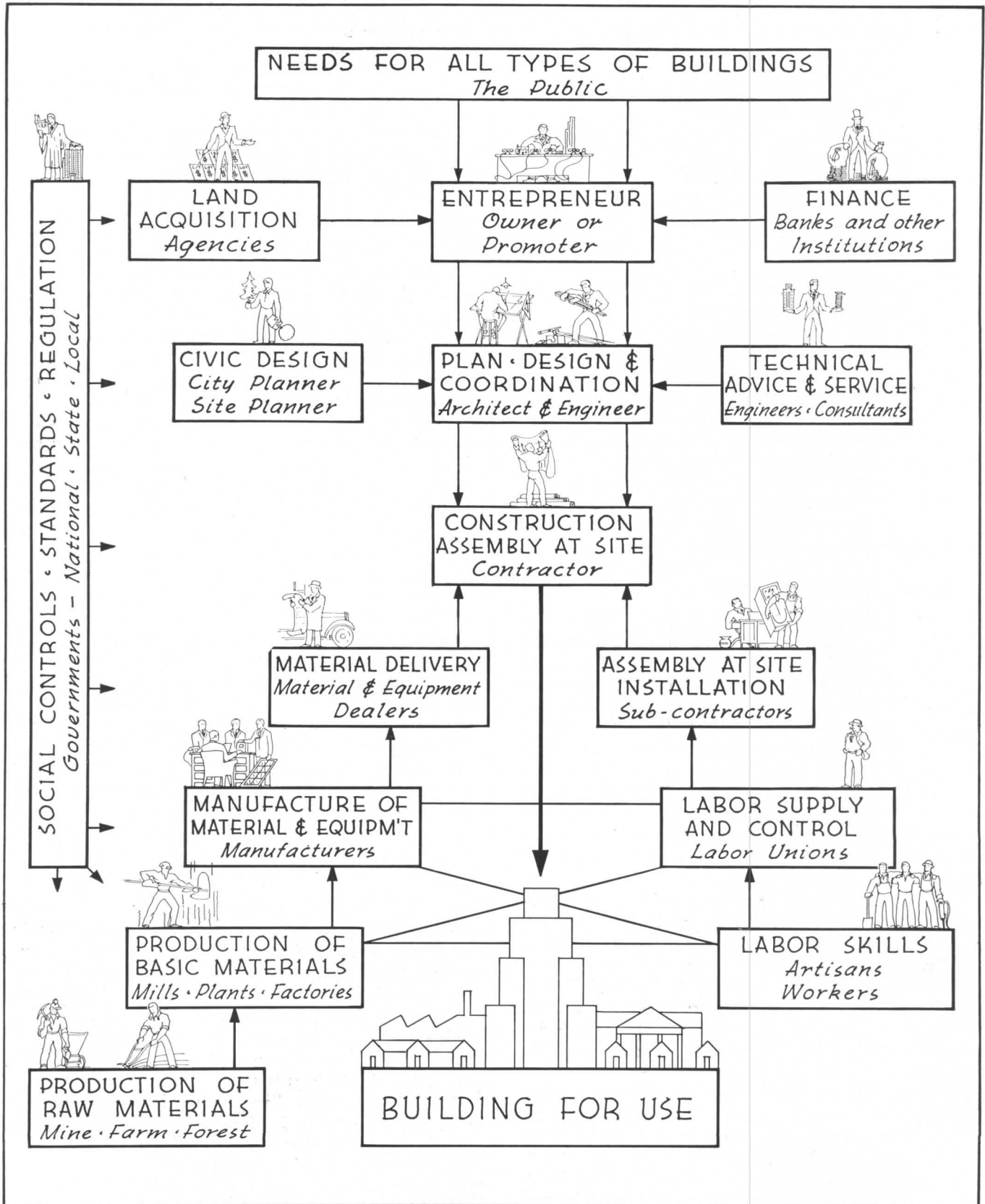

CHART OF THE FUNCTIONS OF FACTORS IN THE BUILDING INDUSTRY

For the sake of clarity, the many professions, businesses, trades and agencies are considered grouped within the classifications indicated above. The arrows indicate the main lines of control or flow.

performance, the best of each for its particular purpose and use-life. The *elimination of waste* of material, time and labor in the construction process is a natural corollary.

- c) Buildings in better relation to other buildings and to other services and utilities, in order to conserve energy, time, materials (Community and Civic Design).
  - d) Buildings flexible enough to be readily adaptable to changing needs or technical advances.
  - e) Buildings which serve both their physical utilitarian purposes and which satisfy the psychological needs and desires of the users and public.
3. To provide such buildings at a reasonable profit to all concerned in their production.
  4. To replace those buildings when they cease to function economically—or are not needed.

Unfortunately, the objectives of the building industry cannot be attained by proclamation, manifesto or debate. The actual production of better buildings for predetermined necessary uses involves conditions over which the planning and construction factors in the industry have no control, and as yet but little influence. A better-organized industry could, however, make its weight felt, and through unified action could bring about more rapidly the changed conditions necessary to its most effective work.

## FACTORS AND FUNCTIONS

UNDERLYING all building are the factors of land ownership, land use, land control and of financing means and methods. These have a much more potent effect on the progress and volume of building than the internal organization of the industry. And they are being given the consideration they merit by all factors that have a stake in building. (See "Outlines of Postwar Patterns," page 41 in this issue.) A more unified and better-organized construction industry could conceivably serve the public by producing a rational program for the changes which will be necessary in our systems of land control and financial control. But our chief concerns here are with the possible mutations of organization within the industry.

The building industry is made up of so many diverse functions and interests that its very complexity makes such unified action difficult. A better understanding of the functions of the various factors that contribute to building might do much to clarify the inter-relationship and interdependence of all the factors on one another. Such mutual understanding could do much toward unified or collaborative action. Each one of the factors has in the past been necessary in the production of pre-war and war buildings. The *functions* of each factor will be necessary in the production of postwar buildings, whether the trend is toward greater integration or greater specialization.

The accompanying simplified chart of the industry as now organized for the construction of most types of buildings, shows graphically the functions that must be performed, by whom, and their direct interrelations as determined by control or by flow from needs for building to the completed structures. For the sake of clarity the many factors contributing to each main function have not been listed but are included in the general designations. Such a chart is useful in weighing the possibilities, and the advisability, of realigning the various factors, for it indi-

cates the functions that must be performed no matter what name is given to the factor or how the factor may be combined with others.

A second chart showing the volume of building in recent years indicates the relative amounts of building that have been planned and carried out with architect-engineer services as compared with that by others. The importance of the planning and designing functions is indicated by the trend thus shown.

## COMBINATIONS FOR BUSINESS EFFICIENCY

MANY CHANGES are being suggested to combine various factors into business organizations which will perform more of the functions of building under one management than has been common in the past. The combining of talents having similar or closely-allied functions into more effective units may well bring about a realignment or reorganization of building procedure that will accomplish, in part at least, some of the objectives stated above. Such closer integration of the industry has been in the minds of its leaders for many years, especially in the early thirties when the Construction League was formed. The increased tempo of the war requirements will undoubtedly accelerate the changes that tend toward this type of unification. One concrete instance: the specialists in the planning and designing field are now uniting to a greater extent than formerly the functions of the architects and engineers. "Technical Teams for War Work," ARCHITECTURAL RECORD, May, 1941).

Again, the impetus given to prefabrication through Government acceptance and financial support, has brought about the combination of the manufacturing with the site-assembly factors in single organizations, some of which offer as well all the plan and design talents necessary for the development of housing groups. The functions of each of these re-grouped factors remain much the same but closer coordination is possible through the integration. This type of housebuilding unit may well serve the public better as a business entity than as the former separate units.

## SERVING THE PROSPECTIVE HOME-OWNER

THE POTENTIAL home-owner, even in the upper income brackets, usually has been bewildered and confused by the complexity of transactions necessary in building his house under the system which prevailed in the past, dealing with real estate brokers, land owners, lawyers, title searchers, architects, engineers, contractors, sub-contractors, landscape architects, interior decorators and manufacturing representatives and dealers, salesmen and all the rest. Practically everything else he buys is a tangible, inspectable package, sold to him at a price. From force of habit, to a large extent, he prefers the single, clean-cut transaction to the rigmarole of various fees, separate contracts, certificates for payment and constant bothersome questions.

## HOW MUCH INTEGRATION?

INTEGRATION, as well as specialization, can be carried to extremes, and the separation of functions into separate, independently operating entities was brought about not by whim or "happenstance," but because, at the time, they seemed to serve a reasonable purpose. Complete integration of all functions dates from the beginnings of building.



# ARCHITECT-ENGINEERS DESIGN AN INCREASING PROPORTION OF TOTAL BUILDING

Black Areas in Charts Show Proportion of Each Class of Building Controlled by Architect-Engineers

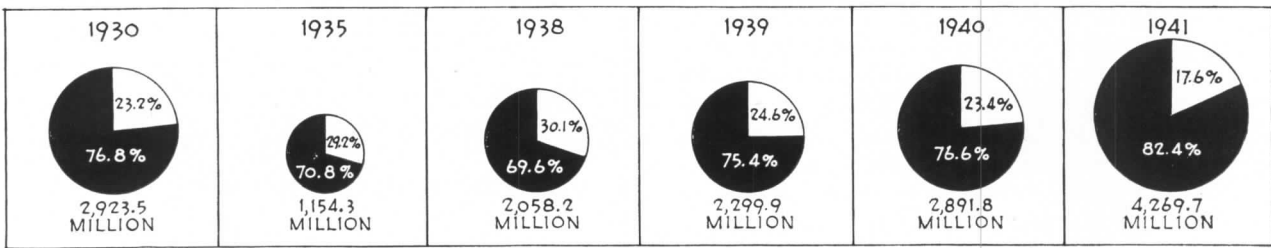

## TOTAL VALUE OF BUILDING CONSTRUCTION IN 37 EASTERN STATES

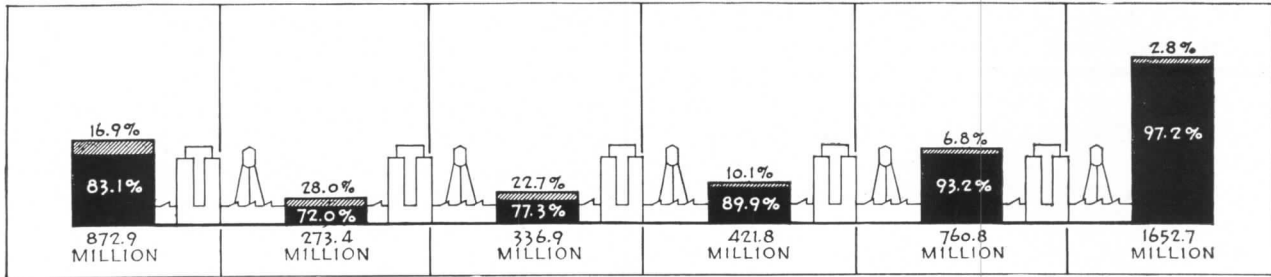

## COMMERCIAL AND INDUSTRIAL CONSTRUCTION

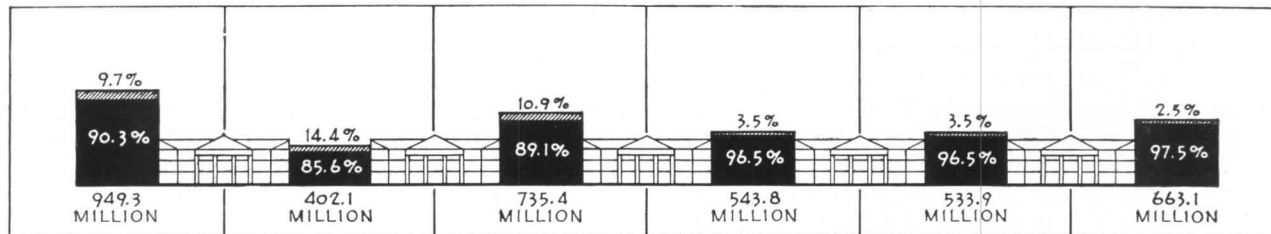

## OTHER NON-RESIDENTIAL CONSTRUCTION

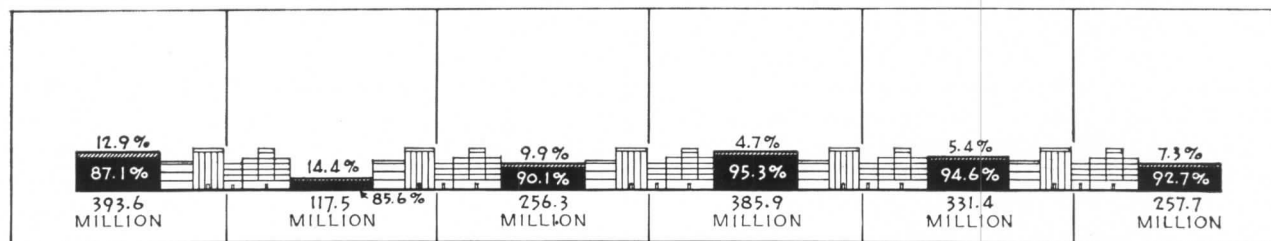

## LARGE RESIDENTIAL CONSTRUCTION INCLUDING APARTMENTS AND HOTELS

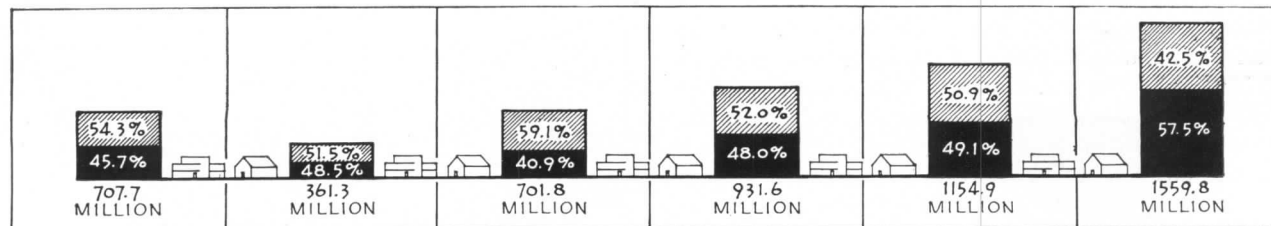

## ONE- AND TWO-FAMILY HOUSES

The basis of this chart, quickly stated, is the labor of 750 Dodge reporters, carefully checking building projects in 37 states over the 11 year period here spanned. Only change in basis of reporting occurred in 1939. In classifying projects prior to '39, only those jobs were considered Architect-Engineer Designed when name of designer appeared on report. In 1939 and since additional projects have been classified as Architect-Engineer Designed when project was owned by a company or by a public agency because it is assumed that in such work staff Architects and Engineers invariably performed the design function.

Three hundred years ago "Lo," the poor Indian, completely integrated all the functions in the construction of his dwelling. He provided the need, cleared the land, planned, designed and engineered the construction, provided the labor, produced the raw and finished materials, assembled them on the site and used and managed the building, subject only to the social control and standards of the tribe. The multiplicity of factors in the building industry came about with the increasing complexity of the needs, uses and sizes of buildings. The division and sub-division of functions to perform the various services and provide the necessary materials probably reached its maximum in the intra-war period, and the trend is definitely in the other direction.

## INTEGRATION THROUGH MASS-PRODUCTION

FOR THE PAST twenty years integration of the building industry on a mass-production basis has been described in glowing (or gloomy) terms from the *Atlantic* to the Sunday supplements—and usually with the exhortation, "See what the automobile industry has done!" The automobile industry has done miracles in reducing costs, expanding markets, increasing output with fewer man-hours.

A building, even a house, presents some as yet unsolved problems to the mass-producer and the analogy is not always valid. One essential difference between the automobile industry and the building industry is that the automobile manufacturer produces a comparatively small unit, which has universal application and provides a limited type of service — transportation. Buildings, on the other hand, must be adapted to the sheltering of all sorts and kinds of human activity, must vary greatly in size, must be fitted to varying sites, climate and orientations. And the cost of land also enters to disturb the house-marketing picture.

Another difference between the automobile and the small house is the present relative life-span and the consequent difference in the replacement market. Enforced obsolescence through frequent style changes also may be more difficult in house merchandizing than in automobile marketing. The permanence of the house in one location makes it a less mass-merchandizable commodity. The house is subject at present to the vicissitudes of taxation and assessment from which the car is relatively free. These things, among others, affect the market—and mass production economy is usually based on a known effective market.

Nevertheless, in the development of a better integrated home-building industry, certainly much can be learned from the automobile industry, especially in the realm of research and applied science, production methods, short-term financing, merchandising and distribution. The great automobile organizations themselves are keeping their eyes on the building field and are mass-producing equipment for the house. The making and marketing of parts of houses can certainly follow assembly-line procedure. The equipment and smaller parts of buildings now follow that procedure and prefabrication development is a matter of degree. There are logical extensions of their policy which undoubtedly will result in the mass-production of groups of equipment which can be standardized and still have enough flexibility to make them useful in both new construction and modernization. With the development and growth of prefabricated building panels, factory-made for site assembly, it is not difficult to see further trends toward mass production and new business organizations.

## REALIGNMENT OF FUNCTIONS

THE VERTICAL integration of manufacturing processes from raw materials to finished product ready for assembly is logical and would contribute to the industry's objectives of better service to the public. The functions of basic-material manufacturer, finished material and equipment manufacturing and the distribution to the ultimate consumers, is being considered by more than one group of existing corporations, and adds zest to the lives of small promoters.

The function of selecting and arranging manufactured parts to produce the proper plan for the particular site or the particular family will always be necessary. It is the "design" function. It may be accomplished with different building units, a slab of wall instead of standardized brick, a complete kitchen instead of hand-picked parts.

In this way, there is a realignment of functions rather than an elimination. The factors involved may change in name and in some of their operating habits and they may be absorbed in the formation of larger organizations. Even handicraft labor organizations may find that technical advances will make it advisable for them to transfer their activities to the factories rather than endeavoring to perpetuate obsolete and wasteful building methods. It would be the part of the organized building industry itself to prove the advantage of such procedure.

The site-planner and the architect in the small house field will still perform their functions, whether independently, as consultants, or as agents or employees of house-manufacturing companies. The function of the designer will be of the utmost importance in producing the right types of material and equipment for building, and in arranging the assembly of those materials in proper relationship to produce buildings which will fit particular sites and particular purposes.

There is no reason why the various factors that have functioned in the building industry cannot be realigned to take advantage of the technological developments without any revolutionary upheavals if they are aware of the trends, and if these trends are in accord with the overall objectives to which they all subscribe.

Fear and reactionary attitudes are generally the result of ignorance, a lack of understanding of the inter-relationships of parts that make the whole. As each factor sees the possibilities of achieving the objectives of the industry as a whole, it can adjust itself more readily to the changes in organization and to the realignment of its functions in harmony with the trends.

Progress is inevitable in this rapidly changing industrial society. In thinking of the changes in the line of progress it might be well if more factors in the building industry followed the philosophy of an ancient but happy negro. You remember that when he was asked how it was possible for him to be so happy in spite all his trials and tribulations, he replied, "Well, you see, Sir, I've learned to cooperate with the inevitable." The only questions here are, "What really is inevitable?" And "What can we do to make the right things inevitable?" We believe that those changes which will definitely contribute to the attainment of the stated objectives of the construction industry are inevitable, and that the industry is so flexibly constituted now that it can adapt itself readily to any readjustments of the factors that perform its essential functions, now and in the future.

The ceramic mural, 16' x 40', dominates the facade at the entrance tower. Designed by C. J. Fitzgerald to be symbolic of the radio industry, it contains 126 different colors. The tower itself is faced with fluted concrete in pink buff, the same color as the remainder of the exterior. The marquee below the mural is of bronze and stainless steel, and the entrance doors are bronze with panels of colored plastic.



## SAN FRANCISCO'S "RADIO CITY"

Albert F. Roller • Architect

STREAMLINED horizontal and vertical areas of glass block and an 80-foot entrance tower with a colorful ceramic mural identify the new 5-story home of NBC in San Francisco completed before the ban on critical materials. The general tone of the exterior is a warm pink buff. The base of the building around the garage is of sea green colored concrete and at the entrance is of terra cotta. The parapet is formed with alternating aluminum rails and flower boxes.

Designed without windows, the main administrative offices on the fourth floor receive outside light through the spacious panel of glass block.



Chas. M. Hillier



Maynard L. Parker



Chas. M. Hiller



THE main lobby provides ample public access to the studios on the second floor by means of elevators and a broad stairway. (See plans, page 40). The show windows inside the lobby tell the story of radio and publicize the programs and radio advertised products. The walls of the lobby are in Chinese lacquer red and gold leaf. The ceiling is finished in aluminum leaf. The floor is of black terrazzo with bronze strips. Entrance doors are bronze with panels of colored plastic composition.

At the far end of the lobby curved panels of glass block vertically trimmed with stainless steel flank the main stairway. Electric reflectors behind these curved sections softly illuminate the lobby at the stair entrance. The bases of the glass block panels and the steps are of black terrazzo to match the lobby floor. The walls either side of the stairway are finished in pastel green.

THE entire structure, with the exception of a public parking garage on the first floor, is devoted exclusively to radio studios, offices, and facilities. (See plans page 40). From the foyer on the second floor, reached by elevator or wide staircase from the main lobby, the visitor, through large windows can see the newsroom with its teletype machines, and the traffic department where program schedules are worked out, corrected, and kept posted on huge boards. The largest studio, 41 x 70 ft. and capable of seating 500 people, opens directly off this foyer through double doors and a vestibule. The smaller studios are just a few steps down the public corridor. The three largest studios are two stories high, and clients' observation booths are above the control rooms. The second floor also includes technical, conference, and lounge rooms. Freight elevator and second stairway are at the rear of the building.

Visible from the foyer of the third floor is the master control room, directly opposite the elevators. This room is the nerve center of the building and is so designed that one man has complete control over every studio, every line in and out of the building, and all the switches and operations. Also on this floor are smaller studios, reference and audition rooms and offices.

Administrative offices occupy the fourth floor.

Plans and specifications for the reinforced concrete building were worked out by the architect in close collaboration with NBC technical engineers and included every improvement that has been developed in laboratories or learned in the construction of studios in other cities. Every studio is set on springs, with the walls and ceilings suspended by springs, and it is thus impossible for any outside sound or vibration to reach the studios. All wall surfaces have scientifically correct acoustical treatment and are set at angles that make objectionable sound reflection impossible.

Steam heat was combined with air conditioning to maintain ideal atmospheric conditions. Controls and equipment are on the fifth floor.

Above. Interior of a large studio, showing the control room window, with the window of clients' observation booth above.

Below. Clients' observation booth looking towards the stage. Note perforated acoustical material lining the walls.

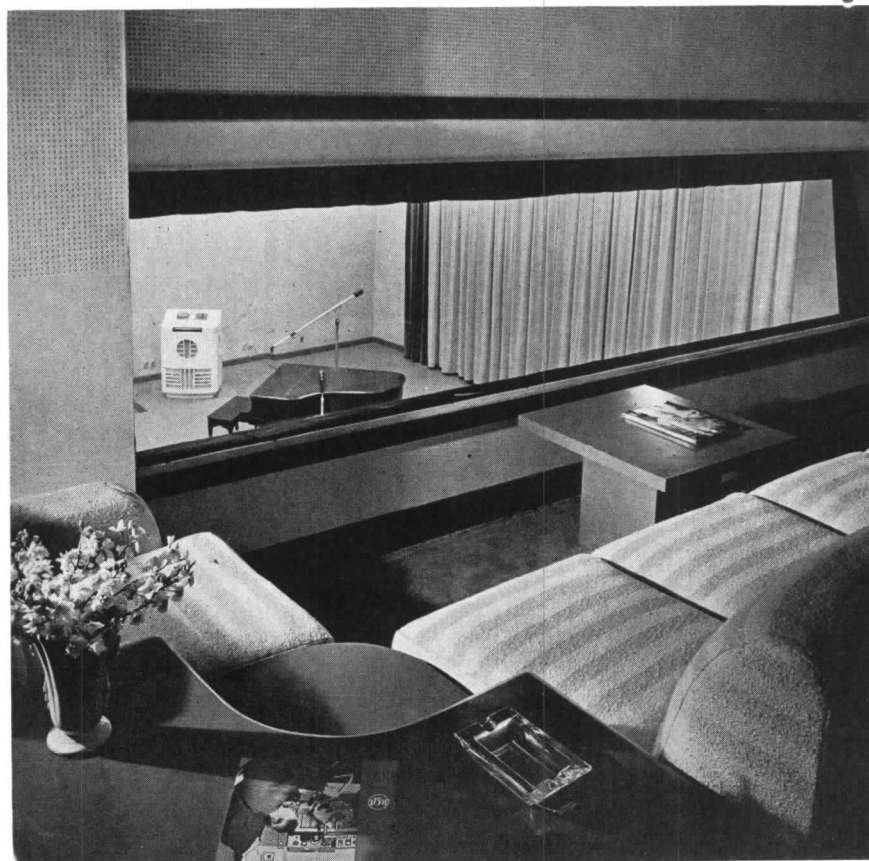

Maynard L. Parker



Executive office. Venetian blinds and draperies control the intensity of outside light flooding through the glass block. The ceiling is acoustic tile. Note air-conditioning outlets.



Chas. M. Hillier

The clients' audition room on the fourth floor is quiet in tone with walls, floor, and draperies in pale blue-green. The walls are of perforated wallboard, with rock wool behind them.

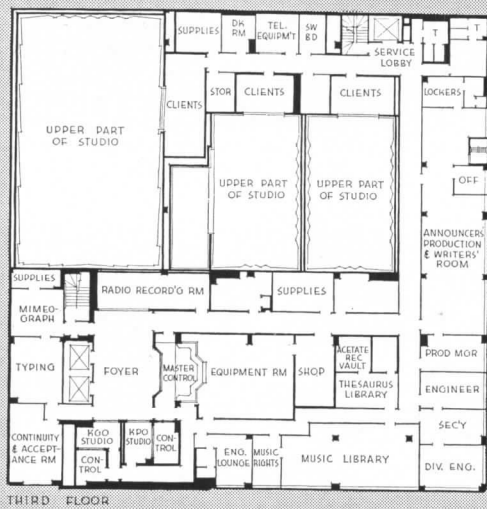

THIRD FLOOR

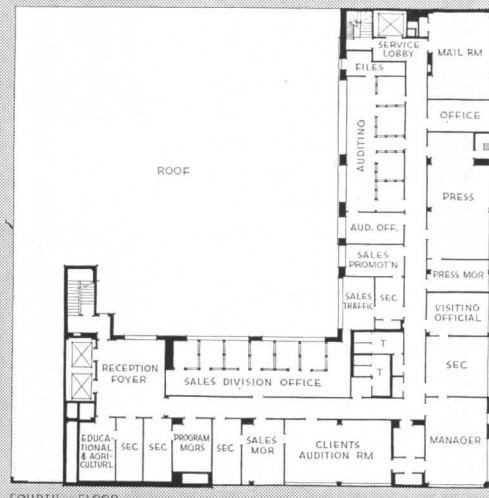

FOURTH FLOOR

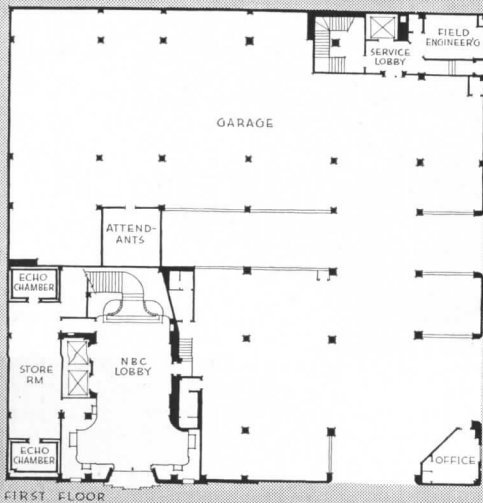

FIRST FLOOR

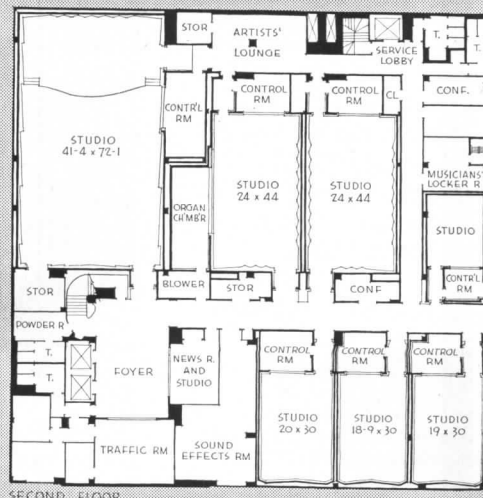

SECOND FLOOR



# OUTLINES OF POSTWAR PATTERNS

By EMERSON GOBLE

Managing Editor, ARCHITECTURAL RECORD



**F**ORGOTTEN in these war times is a lament of a former decade, when the business machine seemed paralyzed for lack of opportunity. Then it was said that business needed a great new industry to lead it out of depression, a New Frontier to usher in an era of further development. The war has changed all that. Not only has the war loaded the business machine to capacity, and then some, but it has opened plenty of new frontiers for the future.

It is clear that making the world a better place for living is all the frontier that could be asked. Making it safe for democratic living is the first job; then comes the task of making tangible the benefits of the democratic way of life, in our own country as well as across the seas. That is a task that calls for planning on a scale and on a level never before envisioned. And it will challenge the capacities of planners everywhere. Can we produce a Design for Democracy, and this time make it work?

As for construction, economists and laymen alike are agreed on the heavy role of construction in the postwar program of re-employment and rebuilding. Construction is depended on not only to take up much of the immediate burden of providing jobs and investment and manufacturing opportunities, but also to set the pace in a long-term program of raising standards of living. First it is to have ready a "shelf" of deferred construction projects, ready to absorb men, materials and money after the war. Later it is to tackle with a new freedom and a new energy some of the familiar objectives of democracy—providing better, cheaper housing for the masses, clearing slums and blighted areas, redesigning outmoded cities, providing factories and airports and highways and schools and hospitals and recreational facilities—not just for the wealthy, but for all.

It is realistic to view the two tasks separately. The first one—the projects for V-day—is an immediate, necessary, and practical field of building that requires a minimum of readjustment after the war. The second one involves essentially long-term planning, and depends for its success on the propagation of some new concepts and the removal of many obstacles that have proved stubborn in the past. It will involve many argumentative matters—the condemnation of private property, to cite just one—and will undoubtedly be delayed for deliberation. The Master Plan for every community will not develop and gain acceptance overnight. It may even involve some of what an English architectural editor calls "the pathology of post-war utopias." To delay V-day building for the settling of such matters is simply beyond the realm of possibility.

As a practical matter the V-day building program is right now rapidly gaining momentum. Under the lead of the National Resources Planning Board and the now-dormant Public Work Reserve, dozens of communities are

*A positive governmental program looking toward full employment would greatly vitalize and invigorate private enterprise. An expansionist program would permit private enterprise to operate at high output levels. There is plenty of work to do. We need improved manufacturing equipment to produce more and better goods at lower prices. We need to carry on extensive research in the laboratories of our great private corporations, in our universities, and in Government bureaus to create new products and develop new processes. We need to rehabilitate and modernize our transportation system—by land, water, and air. We need continued advance in the techniques of production, distribution, and transportation; in short in all those elements that enter into a higher standard of living. We need to rebuild America—urban redevelopment projects, rural rehabilitation, low-cost housing, express highways, terminal facilities, electrification, flood control, reforestation. Many public development projects open fresh outlets for private investment. We need a public health program, including expansion of hospital facilities. We need a nutritional program. We need more adequate provision for old age. We need higher educational standards in large sections of our country. We need a program to improve and extend our cultural and recreational facilities. We need an enrichment of the material and spiritual resources of our American way of life. We have seen how it is possible to mobilize the productive capacities of the country for war. We can also mobilize them for peace.*

—Alvin H. Hansen

"After the War—Full Employment"  
National Resources Planning Board.

*I believe it is vitally necessary for us to appraise as best we can all the long-range possibilities of the situation, to see whether we are fighting for mere survival or for greater objectives and for the promise of great rewards. The dictators of the Axis powers have inspired their peoples, and particularly the younger generation, with glowing promises of a better world built out of the spoils of conquest. This country seeks no spoils of conquest, no domination of others by force, but its destiny requires that it assume leadership in a world that will provide broader opportunities for individuals and peoples than any that history has yet recorded.*

*If the postwar prosperity which I visualize as the possible—or rather the probable—result of victory becomes an actuality, the demand for construction, as measured in annual dollar volume, is likely to be greater than anything we ever had before. There will be a large accumulated demand for houses and commercial buildings and public improvements caused by current postponements. There will be new needs incidental to the expansion of our economic activities. Work will be resumed on our highways and parkways; in all likelihood slum redevelopment, a necessary and long-awaited program, will be undertaken in many of our large cities. Postwar planning studies of Governmental and private agencies alike assign a major role to construction.*

—Thomas S. Holden

"Architectural Record" May 1942

*If we are to make our postwar cities true temples of the four freedoms, there is one central idea which, today as never before, has the acceptance of social scientists, groups of property owners and investors, and of public officials. The replanning and rebuilding of cities must be on a large scale; an isolated, uncoordinated attack, the replacement of a group of structures here and there, will not do. Our replanning must be bold, fresh, and imaginative.*

—Charles S. Ascher  
“Better Cities” National  
Resources Planning Board

*Taking all of these considerations into account, it is safe to say that—if at the right terms and prices and if in the right places—the country could absorb anywhere from 900,000 to 1,200,000 new dwellings a year, for the decade after war, and still be in need of a very large volume of repair during the same period.*

—Miles L. Colean  
“The Role of the House-  
building Industry” National  
Resources Planning Board

*Blight has overtaken one-fourth of urban America. The deterioration of property assessed at approximately forty billions of dollars has placed property owners, urban residents, and city governments in a serious plight. Unless the spread of blight is directly and effectively stopped, there will be no escape from an era of accelerated city disintegration, physically, politically, and socially—an era of wasted property values and inferior urban environment.*

*The causes of creeping blight are numerous. They rest primarily upon technological changes, which permit an ever lengthening urban radius, plus defective city patterns of land use, which make escape from old areas desirable. Existing city arrangements were conceived to accommodate a mode of urban living, commerce, and transportation that gave way to essentially different requirements more than a generation ago. We can not continue to hammer modern living, commerce, and transportation into a form that was built for horse and buggy needs.*

*The nub of the problem lies in urban land planning. The provision of adequate and wholesome housing is but a part of the larger task of replanning and rebuilding cities. Piecemeal housing efforts, which ignore the basic need of replanning, can have only partial success, and may be the cause of new blight.*

*City patterns, land uses, and traffic systems must be replanned upon a realistic basis to serve actual needs, with primary consideration given to the creation of livable home neighborhoods—free from traffic dangers, smoke, noise and visual nuisances—in which a normal and wholesome family life can exist. Until this is done, the flight from the cities by those who can escape will continue.*

—“A Proposal For Rebuilding Blighted City Areas”  
The Urban Land Institute

reviewing their postwar building needs and scheduling six-year programs for realizing them. New York City, for example, has appropriated \$22,000,000 for plans and specifications for \$660,000,000 worth of buildings to be built after the war. The Civil Aeronautics Administration has planned literally hundreds of airports as part of the war effort, with practically all of the building work waiting for the end of wartime restrictions. State planning boards and city plan commissions are taking on new activities and broadening their work. Any number of trade associations, industrial concerns, foundations, universities and other groups are devoting energetic study to postwar problems. If there is confusion and lack of coordination in all of these efforts, that is not surprising, in view of the fast pace of war and the sweeping and sudden changes that follow in its wake.

Probably more important, in the V-day market, than all of this are the blueprints for private projects that are only awaiting the lifting of building restrictions. Reporters of the F. W. Dodge Corp. are taking the guesswork out of estimating this deferred construction market, by compiling reports on individual projects now on architects' boards. While this is a comparatively recent addition to the Dodge services it is already accumulating information on millions of dollars worth of planned projects. Another look at the extent of such work was a recent survey of ARCHITECTURAL RECORD, in which more than half of the architects questioned reported projects on their boards for postwar building.

This volume of waiting work is not, however, assurance that the postwar frontier will be opened and its promises fulfilled. If present expectations of a new and brighter postwar world are to be realized, if the rebuilding of America is to be accomplished, a broader view of planning must be taken. Familiar problems of the past must be faced and solved, not just those of building costs and technical progress, but also those involving the social and political and physical patterns of the communities in which building is done. We must deal with metropolitan monstrosities that grew from the Topsy type of planning. As one observer has put it: “Our American cities were built too fast. They were built as workshops in an age of furious industrial development. They have not kept pace with the changing scene. Now we must rebuild them for better living.”

One casualty of the war that is not mourned is the complacency of less explosive times. Certainly an all-out global war does sweep aside many handicaps and prejudices. In short, war permits, indeed demands, a vigorous breaking of bonds.

While the war introduces new complexities, the separate phases of the postwar job are the unremedied troubles that have long beset American communities. Some of them have had much attention, but are still unsolved riddles. Some have been thoroughly researched, and their solutions fairly well delineated. Some—such as slum housing—have been the subject of endless debates. Others—like back-breaking taxation—have solutions too unpleasant to have been faced. And most of the troubles of American communities are so interwoven that before the new frontier for rebuilding can be opened, a fully coordinated attack must be worked out and executed.

The confusion that surrounds postwar planning for the long future is not to be resolved in one article on the sub-

ject. But it may help to list a few major fields of planning that stand out as major objectives in the campaign. The classifications here briefly reviewed are seven: 1. Need for an aroused public opinion; 2. more comprehensive planning for cities or regions; 3. land use and land controls; 4. building costs and technical advances; 5. financing; 6. taxation and municipal services; and 7. public vs. private enterprise.

## 1. An Aroused Public Opinion

In a broad way public opinion is already aroused to the need for better planning after the war. Pacing his sentry post the soldier asks himself what it is all about, what he may expect if and when he gets home. The worker, still struggling for his "rights," hopes for increased security and better living. Everybody hopes the four freedoms mean tangible advantages and better living. Business men are doing more than just worrying about it.

But while public opinion is receptive, it is also confused. And however excellent are the plans worked out in the halls of scientific planning, they will eventually depend for effectiveness on public acceptance. Perhaps it would be more realistic to recognize that public reactions to the topics of the times will be the biggest factor in the final steps taken, whether or not those steps are really solutions. Thus the greatest task of all is the education of the public in the several phases of the task of rebuilding America.

How better could an architect use his spare moments than by taking some initiative in spreading the gospel of sound planning in his own community? The mayor and the city council are already vaguely interested in a better community plan. The chamber of commerce and the real estate board are actively interested. The city planning commission is fervently anxious for all possible help. But generally speaking there is only the vaguest notion of what a community plan is and what it might do for citizens. Anything that can be done to translate the theories into terms of tangible benefits is all to the good. And a little drawing board effort would not do any harm.

## 2. Comprehensive Community Planning

Some years ago a southern city called in a well-known city planner and had him prepare some new plans for the city. He studied the city as it was and as it might be, and drew a "master plan." His plan duly completed, he received a fancy fee and departed. A few years later the subject of city development came up again, and it occurred to the city fathers to refer to the master plan. But the grand and expensive scheme was lost in the files; it simply could not be found.

If the term "master plan" has a connotation of futility that is not so much a criticism of the basic idea of comprehensive planning as it is a measure of past performance. Hundreds of cities have something that passes for a master plan. Maybe the plans were sound; maybe they represented idle dreaming. Maybe they were excellent for a certain era, such as the famous L'Enfant plan of Washington, but turned out badly because they were static, which by the

*There seems to be little difference of opinion among professional men, manufacturers, producers, labor, capital, and government that we are determined to maintain a high standard of living and that this can only be done through the typical American method of productive power. Inevitably tied to this thesis is the rebuilding and rehabilitation of our American communities. The task is a gigantic one, but may be viewed with less awe because of the example set by American industry in the great production program now reaching its height in the war production effort. The war cannot be won without a unified effort centered on a single purpose. We cannot rebuild our American economy without that same unified effort.*

—Walter R. MacCornack

(From an address read before the annual convention of American Institute of Steel Construction)

*No replanning of land patterns and uses in our cities can be made realistic or wholly effective unless it is comprehensive enough to include entire metropolitan areas. Planning effort is now diversified and uncoordinated. Within a single functioning metropolitan community we may expect to find planning done by numerous municipal governments, county governments, sanitary districts, school boards, and park commissions. This is a chaotic process.*

*Planning must become a dynamic function of government. Most of the present city planning commissions are merely advisory bodies with exceedingly limited powers. Planning procedures must be segregated as far as possible from the influence of the everyday give-and-take of political life. The essence of planning is to think in long-range terms, and to provide a pattern for the gradual rebuilding of the city in a generation.*

*The rebuilding of blighted city areas offers a vast field of operation for private enterprise. It is now a pressing need. It will also be a logical and constructive means of relieving unemployment and directing the readjustment of industry to peacetime production at the close of the present war. However, private effort alone cannot attack and cure urban blight. Replanning is a first and indispensable requisite.*

*It is also clear that no program of replanning blighted areas can be made effective unless there is vested in some public agency the power of eminent domain to assist in reassembling land in blighted districts. It is beyond the power of private effort to assemble sufficiently large areas in the blighted districts to create a new neighborhood environment.*

—"A Proposal For Rebuilding Blighted City Areas"



*There is no permanent escape from the responsibilities of the city. Indeed, recent studies indicate that real property taxes are higher per capita in many suburbs than in their central cities. It is becoming clear that much of the migration within urban areas is only an illusion of progress; too often the vigor of the new area is matched by decay in the old.*

*Large-scale rebuilding of cities means, then, comprehensive metropolitan planning.*

—Charles S. Ascher

*Even within the city it is increasingly agreed that our scale of rebuilding must be large to meet the objective of providing a physical basis for a satisfying community life; we must plan our rebuilding, not by the square block, but by the square mile. If this conception be accepted, we must clearly have an idea to guide us that will give us more than rows of sanitary barracks to replace rows of unsanitary hutches. The guiding concept which is gaining wide acceptance as an ideal in city rebuilding is that of the neighborhood: an area freed from the disruptive forces of through traffic, with a system of circulation designed for its internal needs, supplied with its own play spaces, schools, health center, places of assemblage for worship and civic discussion, its own retail shops.*

*With the acceptance of the neighborhood concept, we can free ourselves from the identification of "slum clearance" with the provision of "low-cost housing" which crept into the first legislation making Federal financial aid available for housing in 1932. We can propose the tearing down not only of substandard residences, but of decrepit warehouses and dank sweatshops; we can plan to replace them by schools, playgrounds, parking lots, markets, shops, residences, work-places—all the appropriately placed elements of integrated communities.*

*Indeed, the new way of life which the postwar city can afford will be embodied in types of buildings which have seldom existed. We must take care that our lists of postwar public works do not consist merely of the familiar courthouse and school. There must be provision for the health and welfare centers which may become as familiar as post offices—with their well-baby clinics, their nutrition advisers, their employment security offices for job registration and consultation about benefits. There will be buildings to serve new types of vocational education, groups of buildings combining the functions of school, library, and recreation center for children and adults.*

—Charles S. Ascher

*The present assessed valuation of land is, in many cases, far beyond its use or sale value, and has been the result of speculation in times of unusual prosperity. This is a situation which the tax authorities seized upon for increased revenues. Housing projects on land at a dollar per square foot, which is not at all unusual in our national housing experience, means building low-cost housing on land costing \$43,560 per acre. This is absurd, and leads to overcrowding in order to overcome high land cost per dwelling unit.*

—Walter R. MacCormack

way is a fairly general criticism of much of the planning of the past. Or perhaps they were grand conceptions of the City Beautiful, such as the great Burnham Plan for Chicago, which gave that city wonderful and costly public improvements but did nothing to stop the spread of blighted areas or slums, or to improve living conditions. In any case the soundest city planning is completely futile if the results are just filed in the city hall.

Such a background of city planning has *not* been in vain. Certainly it has not disproved the soundness of the fundamental idea of orderly planning of a city's pattern. What it has demonstrated is that city planning, either in concept or performance, has been ineffective.

It has shown, too, that there is no escape from the problems of the city. The great exodus from the city, known as decentralization, has been accelerating (until interrupted by the war) at an alarming rate. It has been pointed out that decentralization is not due just to the automobile, but to general dissatisfaction with living conditions in the city. Better transportation has only made possible the escape that has long been desired. It has been pointed out too that the flight to the suburbs has not solved any problems—it has only moved them. Many suburban areas have the same tax problems, the same municipal bankruptcy, the same blighted and slum areas, the same traffic tangles, the same noise and confusion and crowding, and the same decentralization of the central city.

Sooner or later we shall have to face the difficulties of living together in large cities. We shall have to work out the solutions—find the planning techniques and implement the plans. The war has intensified dissatisfactions such as metropolitan living conditions have produced, and has brought, in a tidal wave, a determination to do something.

It is important to remember that, in spite of lack of visible results, city planners have already formulated some excellent proposals for correcting the faults of our communities. There is, for a single example, the concept of neighborhood redevelopment. Proposals for the use of the neighborhood plan of rebuilding cities were well advanced, implemented with the necessary legislation in some states, and ready for practical demonstration. The problems of cities are by no means insoluble. On paper most of them have already been solved.

### 3. Land Use and Land Controls

Biggest difficulty in any rebuilding program is that every building project involves land. And the problems of land use and land controls and land ownership have been the obstacles that have so far been insurmountable.

Some years ago zoning was the magic word. But though zoning has been universally adopted it has been largely ineffective. Practically every city is over-zoned for large buildings of all types, and consequently the theoretical protection of zoning for the proper use of land has not been realized. Gas stations and stores and a wide variety of similar non-conforming structures have damaged neighborhood values and speeded the natural processes of neglect and deterioration. Individual property owners lose heart, sell out and leave. And gradually blight settles on a whole district.

Still property owners wait for the day when they can

sell their lot, at a whopping price, for a great apartment or office building development. The speculative fervor of land ownership is still dominant in the land situation. It has been exploited in tax assessments, and thus further perpetuated. Diverse and legally complex ownerships of small city lots are a further difficulty in the assembly of plots large enough for profitable and logical development.

And land assembly is not the only problem. Even a grand new project on a large plot is no guarantee that the same blight and obsolescence will not settle again on the neighborhood. And there is the problem of premature development of outlying land, and its attendant evils.

So of recent years there have been a number of revolutionary proposals with respect to land ownership and its rights, with the general objective of effectuating the planning and improvement of city patterns, and thus opening the frontier of rebuilding America.

These problems have already been discussed at great length. Suffice it to say here that the efforts of the building industry have always been hemmed in by matters of land use. Land ownership has dictated the types of buildings planned and erected, the type of planning and building organizations, the opportunities and limitations of the whole industry. And on the answers now being debated depend the future limitations on building.

#### 4. Building Costs and Technical Advances

For all of the rapid technological progress of the war period, for all of the new materials one day to be available in unheard-of quantities, the progress of the postwar period will depend on action against the familiar restrictive influences of the past.

Currently wartime necessities are raising strength allowances for steel in both structural steel and concrete calculations. Architects and engineers have long been saying that this country has been flagrantly wasteful of basic materials, that our buildings are much more massive and more costly than they need be, than they are in other countries. The war is also giving a boost to all labor-saving ideas such as prefabrication and assembly techniques. And emergency government specifications are cutting through local building codes and upsetting the so-called vested interests.

It is to be noted, however, that local codes are only suspended for the duration, not basically changed. How much permanent progress will be achieved is a question yet to be answered.

Labor is still stubbornly holding its vantage points. It is to be remembered, of course, that postwar plans for the democratic way of life comprehend steadily improving the lot of the working man; that is fundamental to Design for Democracy. But the plan for the future does not comprehend make-work restrictions on output or hampering alliances or jurisdictional squabbling.

Labor matters are a major concern in any coordinated attack on high building costs. Building has always been charged with costs too high for the people it serves. And always before it has been the nice vision of the untapped market of really inexpensive homes. If costs could be cut to the level of the working man a tremendous market could be opened.

And prefabrication is looked to as the means for opening

*To provide a basis for rebuilding cities by the square mile, rather than the square block, we must make urban land fluid again. We must be able to assemble it in large blocks and to devote it to suitable purposes which will sometimes be different from its present use, or the use of which the owner and the tax assessor now dream. In any case, we must plan its contribution to the community without distorting our pattern because of the pressure of earning a return upon an insupportable land value, or the desire for an unearned increment; and without necessarily asking the occupants of the new structures to meet the full cost of acquiring the site and of removing the obsolete structure that previously stood upon it.*

—Charles S. Ascher

*Though its principles have been long understood and its possibilities long recognized, the factory process has been slow in developing. First, it had to await the invention of practicable methods (like the panel systems), then the appearance of suitable, inexpensive materials (like plywood and synthetic glues) through which the methods could be made effective.*

*Facing it also was the opposition of labor fearing technological unemployment, of subcontractors foreseeing extinction, of dealers jealous of their stranglehold on the materials supply, and of lenders wary of losses in existing properties should the innovations fulfill their promise. Public skepticism, fed by both the exaggerated claims and the irresponsibility of some of the prefabricating pioneers and by the propaganda of their enemies, also held back the progress of the factory operation.*

*The Government's wartime housing program brought a new stimulus to the expansion of factory production. It provided a volume market, which previous distributing arrangements had not been able to develop. The very pressure for production forced out many of the old restraints. The rigidities in the materials supply system were often broken down, and centralized buying direct from manufacturers, either by the producers or by the Government itself, became accepted in the trade. Labor's hostility decreased, and instead of opposing the spread of factory methods labor turned to organizing the workmen in the factories. Instances have occurred where union labor has installed plumbing stacks and wiring in panels before erection—procedures almost unheard of before the war.*

*The war, if it has not created a new industry, has at least aided one to develop.*

*With the termination of war orders, however, the new industry will face a real crisis. Having grown up in dependence on the Government as its customer, it is apt to find itself crippled by lack of adequate facilities for distribution to the private market. A resurgence of the demands of local materials and labor interests may once more rise to plague it. Building codes, always subject to the pressure of local interests, may again be used against industrial innovation. The problems of land, of taxation, of finding investors in rental property may prove no lesser obstacles than they have in the past.*

*At the same time a crisis will be at hand in the course of public policy. We shall have to decide as a nation whether to have a large volume of low-priced house production with its attendant social and economic benefits, or whether out of fear of temporary disruptions, to protect certain existing interests and certain traditional ways of doing business.*

—Miles L. Colean

*Such broadening of the housing market as occurred during the past decade to a very considerable extent resulted from the liberal terms available for home purchase. As a result of prevailing financial conditions combined with Government insurance of mortgages and other devices, interest rates reached new lows, the period of repayment was stretched to 20 to 25 years, equity payments sank to 20 per cent and under some circumstances to 10 and even 5 per cent, and ample quantities of money were available for favored areas.*

*The situation showed clearly the stimulative effects of easy money. And, as the market expanded further with each successive liberalization, it indicated that an easy-money policy would have to be maintained if home purchase was to be markedly increased. Modifications in mortgage practice accomplished during the decade (notably the popularizing of amortization and the reduction in the use of second mortgages) eliminated part of the risk of the transaction to both lender and borrower. But the increasingly thin and often imaginary equities back of the loans and the long periods over which payments are rigidly prescribed create problems of their own.*

*The recognized social benefits of a large proportion of home ownership were thus obtained at the risk of possible future social unrest. One of the pressing choices of the postwar period will be whether to accept this risk and press for industrial expansion through increased sales, or to devise some means through which a large volume of housing can be produced without the dangers inherent in today's long-term contracts and also, if possible, without sacrifice of the social values of ownership.*

—Miles L. Colean

*On all sides, suggestions are made that the entire tax structure of the country should be studied with a view to creating a more scientific and equitable taxation method. For instance, in many communities the tax on real property is creating a more scientific and equitable taxation method. For instance, in many communities the tax on real property is creating thousands of cases of tax delinquency, depriving home and farm owners of their property, and threatening our large urban centers with bankruptcy. A whole foreclosure on tax delinquent property would lead to government ownership of large sections of our cities and rural communities. There is evidence that there is too close a relationship between the taxing authorities and the spending groups, and that the method of assessment and the amount of the tax levied are too often based on expediency and not on sound economic principles. Some method of relieving this situation must be found. This matter should be taken out of the talk stage and action secured. It is a national as well as a local problem, and it is recommended that it be studied now.*

—Walter R. MacCormack

this market. It is obviously true that prefabrication—whether it means assembly-line houses as such or partial prefabrication in all types of building operation—will make a large contribution toward lower-cost building. It is fitting to point out, however, that prefabrication itself depends for its success on just the same things that govern the use of older techniques. The mass market is not ready and waiting for the assembly-line house. Prefabrication faces the same financing, taxation, building code, and land-cost problems, and its difficulties with labor are greater rather than less. Prefabrication may be expected to go forward, but it has no inherent magic to thrust aside the complex troubles of all building in the past.

## 5. Financing

The financing of real property and building is one phase of the postwar task in which great progress has already been made. In the past decade it has already seen the firm establishment of the principle of long-term financing.

Still financial troubles have beset the whole business front, and they are not getting any easier or simpler. Building has, more than any other industry, been at the mercy of the ups and downs of business cycles. The building cycle in fact has been one of the most violent of all, its peaks and dips meaning the difference between feast and famine. Greater financial and monetary stability is a national objective vital to every field of business and every human endeavor, and the building industry has an interest second to none in the struggles to level off the variations in the chart. For illustration, consider how much labor relations could be improved if building organizations could count on steady, sustained activity, or how much costs could be cut if overhead could be better budgeted.

## 6. Taxation and Municipal Services

The spreading bankruptcy of large American cities is a problem of postwar building. Taxation has frequently gone beyond the point of diminishing returns, has paralyzed constructive activity in real estate development, has discouraged even normal maintenance of property, and so hastened the process of blight and the spread of slums. So tax incomes further decrease and municipalities get farther into the morass.

Conversely, the city is forced to extend and maintain utilities and services in areas that cannot carry their share of the cost. The city government has had to follow the whims of private real estate development struggling in a senseless city pattern. It must provide services and protection to suburbanites who contribute very little to the city's income.

It is apparent that tax problems are not to be solved over an architect's drawing board. But it is also apparent that a sound plan for development of the city's property resources, a sound plan for utilizing present street facilities and utilities, could contribute much to the solution of its financial difficulties. The tax problems and the physical patterns go together.

And if, through city planning adequate to the task, a

(continued on page 86)





# 6 HOUSES

## 1. RUGGED SIMPLICITY IN SEATTLE

DONALD DWIGHT WILLIAMS, Architect

DESIGNED for a young couple with a limited budget who wished a country home, this little house turns its back on the country road and opens to a sheltered garden in the rear. One ample room with wide vista towards the garden and access to the rear terrace forms the living center of the house. The rugged simplicity of construction and finish is in tune with the surroundings and emphasizes the easy transition from indoor to outdoor living shown in plan.

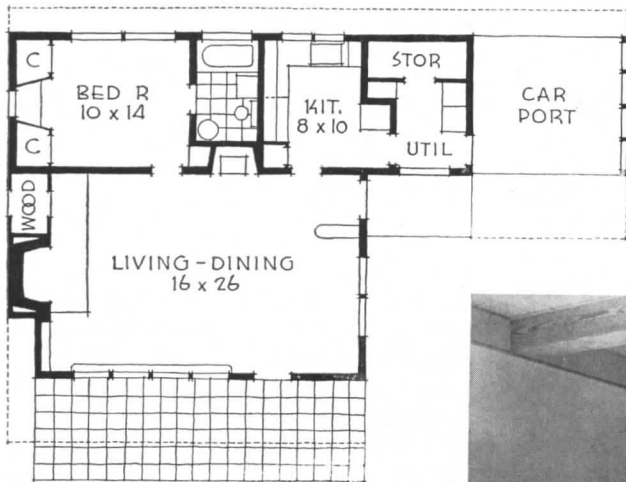

Bedrooms and services are grouped on the road side and contribute to the privacy of the living portion of the house. All corridors and halls have been eliminated and there is no space wasted for circulation. The easy, covered access from carport to main entrance is noteworthy.

The general interior treatment harmonizes with the rustic exterior and garden surroundings. The large window and door open to the rear terrace and overlook the private garden. The brick fireplace plus a large circulating heater take the place of a more expensive furnace.



Erven Jaardán

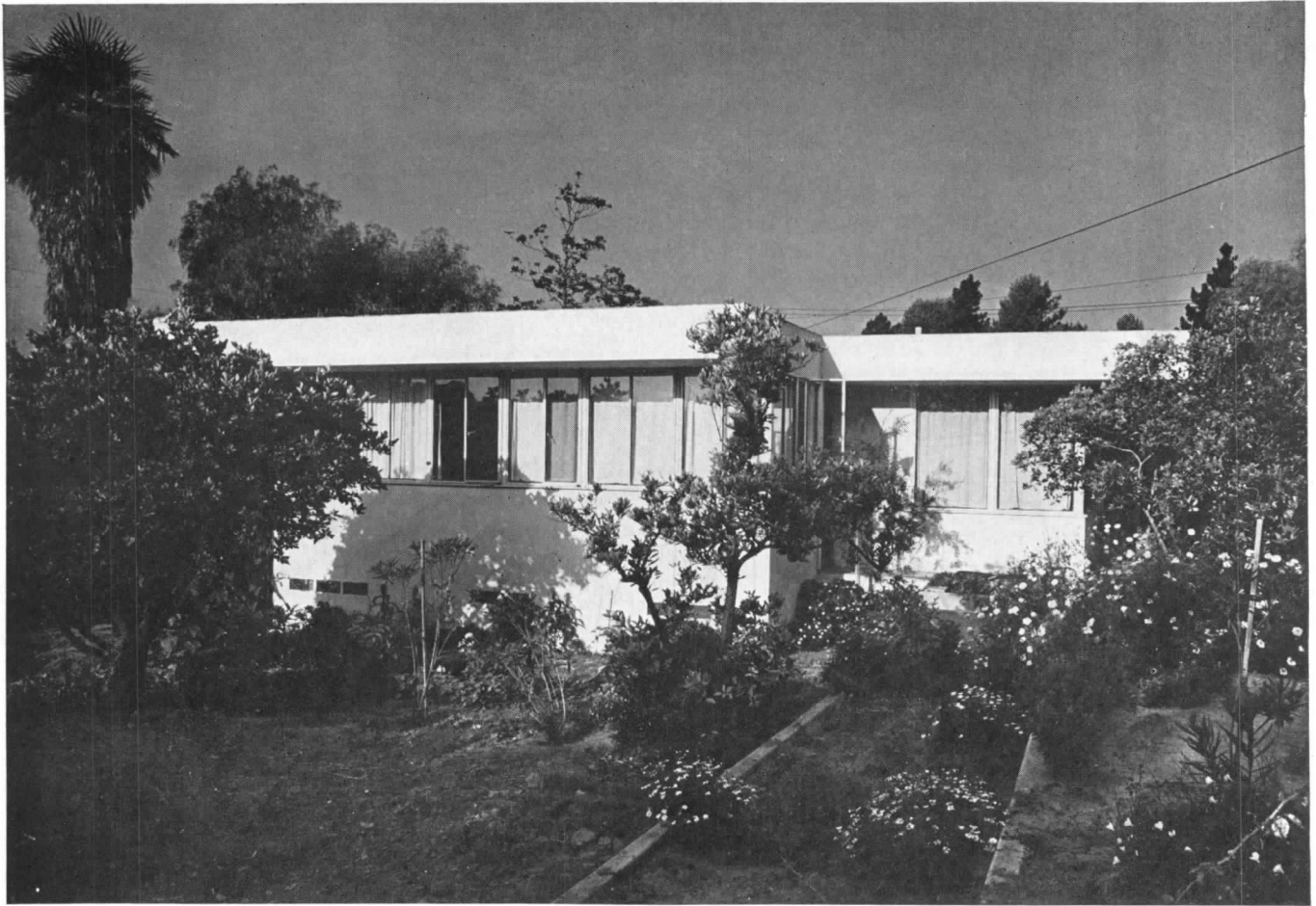

## 2. A BACHELOR'S HOME IN CALIFORNIA

**RAPHAEL S. SORIANO, Designer**



LOCATED between fine old trees on grounds which were part of a rich estate, this residence in the contemporary manner was designed for a famous ceramist. The plan is of modest dimensions, yet large enough to meet the demands of a bachelor who required sufficient space for entertaining his many artist friends.

The owner required a definite communion between outdoor and indoor spaces and there is direct access from the living room and from the studio to the gardens outside. Large areas of glass were also used to bring the outdoor panorama into the indoor living quarters. Wide overhangs protect the interior from excessive glare.

The main entrance, across a raised patio, provides access to either the living section of the house or, through a door in the west wall, to the owner's private workshop, right in back of the garage and opening into it for service reasons. The wood deck floor of this patio, suspended above a little pool, ingeniously provides space for a display of ceramics, which becomes a feature of the main entrance. The wall of the workshop is a ribbon of sand-blasted glass and at night it provides a pleasant soft illumination for the whole entrance patio.

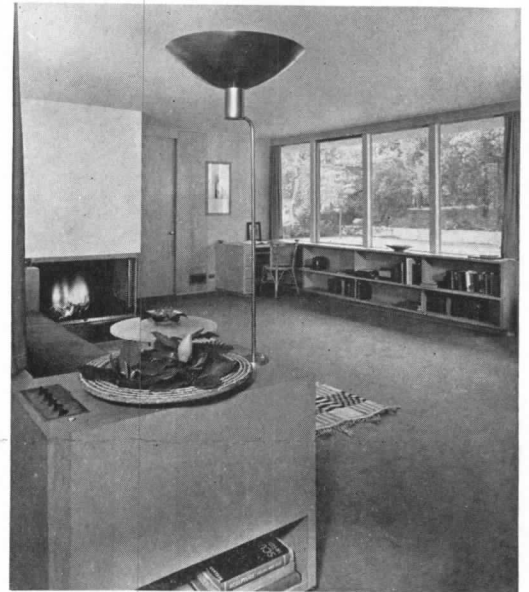
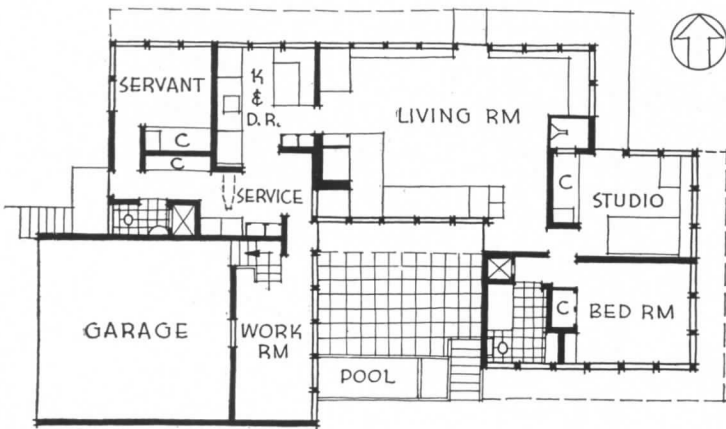

The austere simplicity of the living room is conducive to relaxation and study. The lighting is indirect. A few low chairs and a low table are the only movable furniture, the rest is all built in. There is a long comfortable couch flanked by an automatic record changer with storage for symphonic record albums and radio books. There are long bookshelves and deep shelves, some closed and others open, for the exhibit of ceramics. The fireplace, of unusual design, is open on two sides to face both the couch and the built-in desk at the northwest corner of the room. The living room ceiling and fireplace are matt white, the woodwork is 1/4-inch magnolia plywood. The carpet is sand colored, the couch olive green, and draperies are canary yellow. The other rooms in the house are colorfully painted in corals, grays and greens.

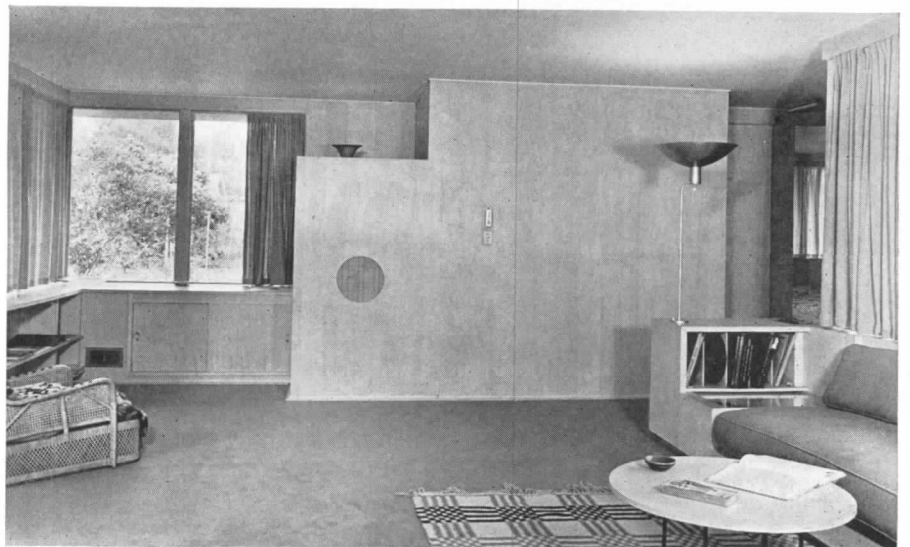



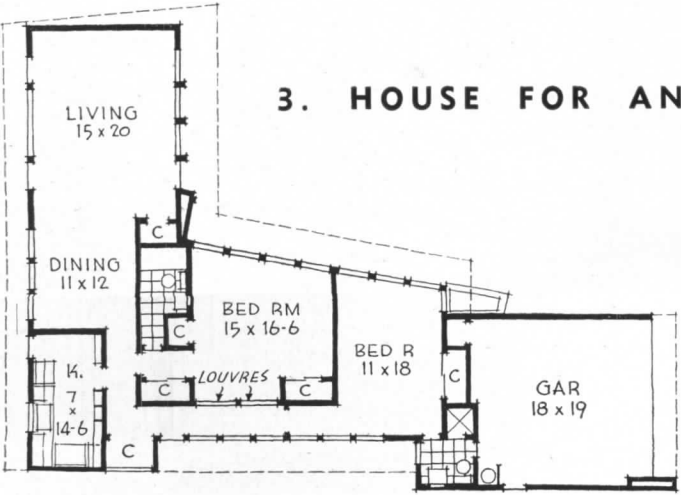
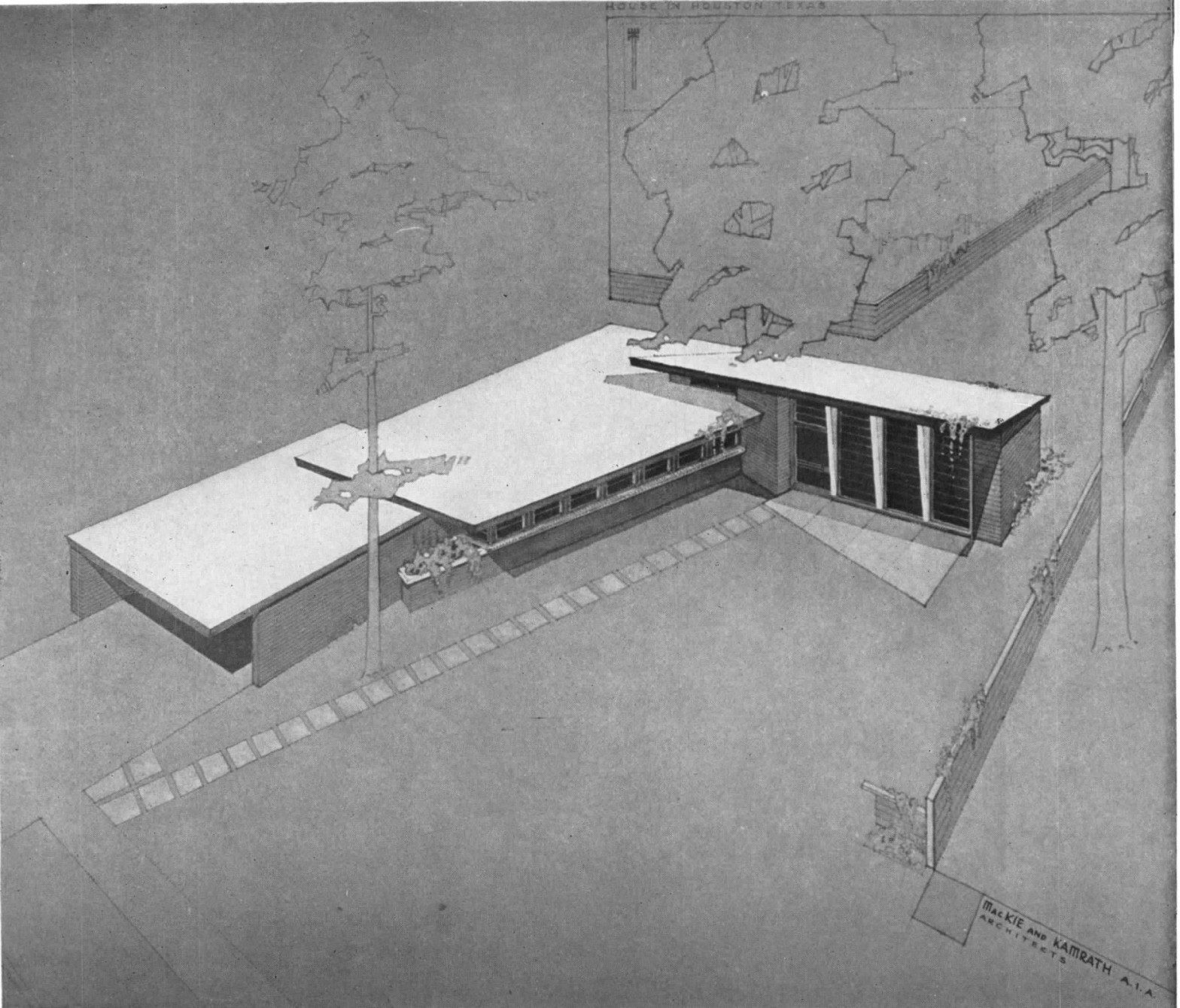

### 3. HOUSE FOR AN UNUSUAL LOT IN HOUSTON

MackIE and KAMRATH, Architects

DURING construction this home was vigorously criticized by older residents of a long-established conservative subdivision, but upon completion it was hailed by neighboring property owners as definitely improving the housing standards set by the older residences.

Considerable plan study was necessary to take advantage of the unusual-shaped lot and to conserve the valuable trees existing on the property. The living room was placed to obtain the most interesting vista, to the south and north, and the large picture window on the north side overlooks an immediate brick terrace and an interesting Japanese garden. Great care was taken to obtain good ventilation from the southeast prevailing breeze in the living room, dining alcove and bedrooms, and with this in mind, the master bedroom has a louver in the west wall to develop cross-ventilation. Its bathroom is ventilated by two clerestory type transom windows. The open carport facing the street is worthy of note.

The exterior of the house combines stock wood siding, painted a deep gray-brown and used common brick which forms the wall to the left of the front door and extends towards the street under the bedroom windows, continuing on to form a flower box. The general tone of the unpainted brick is a mingled texture of salmon and gray. The wide overhanging of the roof on the south and east sides protects the window areas from frequent rains and glaring sun, a most important consideration in dealing with local weather conditions. The window screens are painted a soft gray-green as is the underside of the roof overhang. The extending fascia board of the roof is painted light gray-brown. Window mullions are a deep brown.

The interior walls and ceilings throughout are plywood in soft neutral tones, with a small V-type butt joint. The sloping ceiling of the living room and dining alcove makes an interesting relief from the other flat roof areas and allows large windows on the south side of the living room. Broadfelt carpet is glued directly to the concrete slab throughout the house, with the exception of asphalt tilings in bathrooms and kitchen. Four-inch wall insulation is used in all roof areas and a continuous type of screened ventilation is used under the eaves. For economic reasons, stock millwork and other stock items were used throughout.

Above. The main entrance on the south wall of the living room showing unusual mullion design and sloping roof with wide overhang. Used common brick forms the wall to the left of the main entrance and extends towards the street under the windows.

Center. The main entrance from the living room itself. The unusual height of the opening is established by the upward slope of the roof over the tall window.

Right. The picture window on the opposite side of the living room overlooking the brick terrace and the Japanese garden. The living center of the house obtains an exceptionally fine uninterrupted view from one end of the property to the other in both directions.

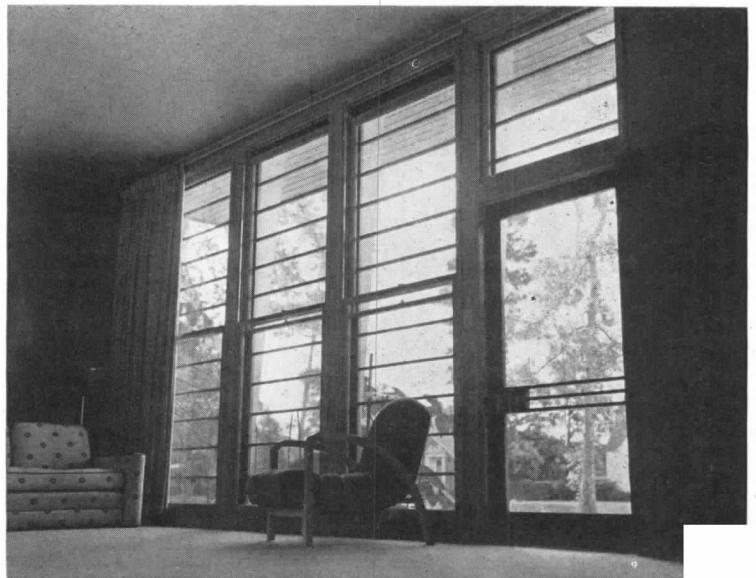
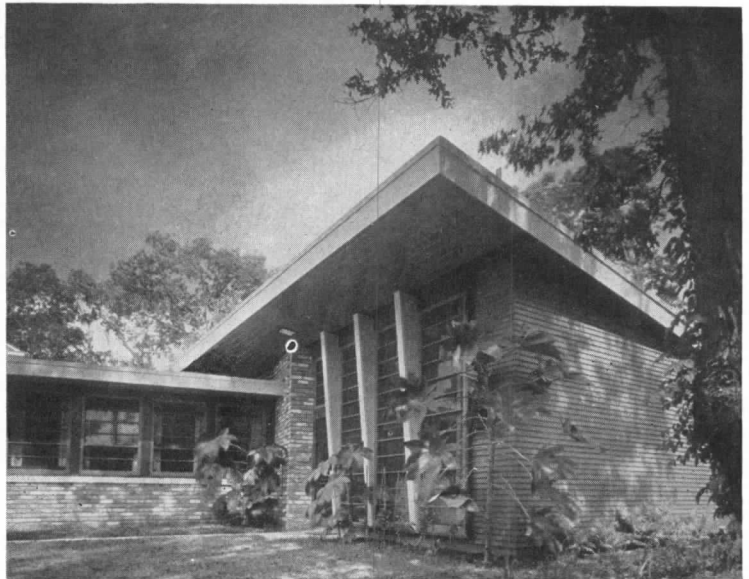

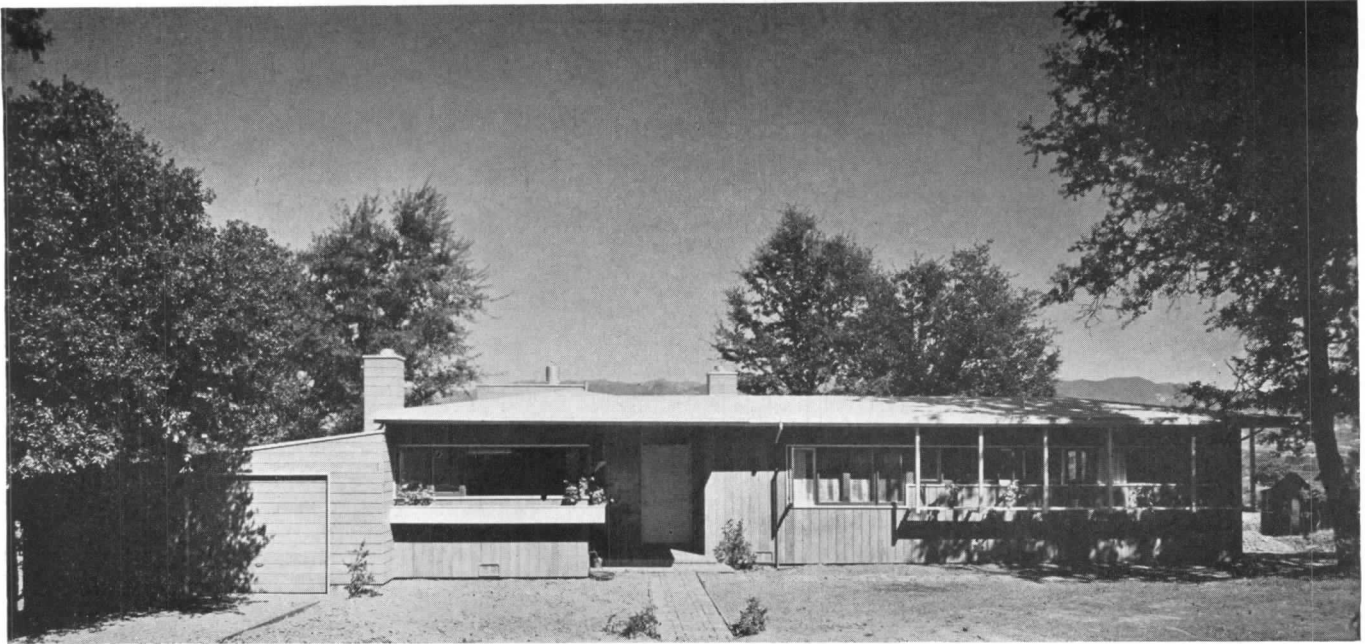

#### 4. PLANNED FOR A PANORAMA

**PHILLIP JOSEPH, Architect,**  
**office of JOHN EKIN DINWIDDIE**

THIS five-room home with a separated workshop has been conceived in a modern and refreshing manner to fit the requirements of a young couple with a small child. Of particular interest is the well-defined arrangement of the necessary elements making up the house plan. The living, dining, and garden areas are treated as one unit, with inconspicuous glass screen separation, and by their position take full advantage of the panoramic view of the foothills to the east and southeast. The glass areas are well arranged and the maximum view is achieved with the sun controlled by roof overhang. The more private bedroom unit is well designed and sufficiently separated from the living section

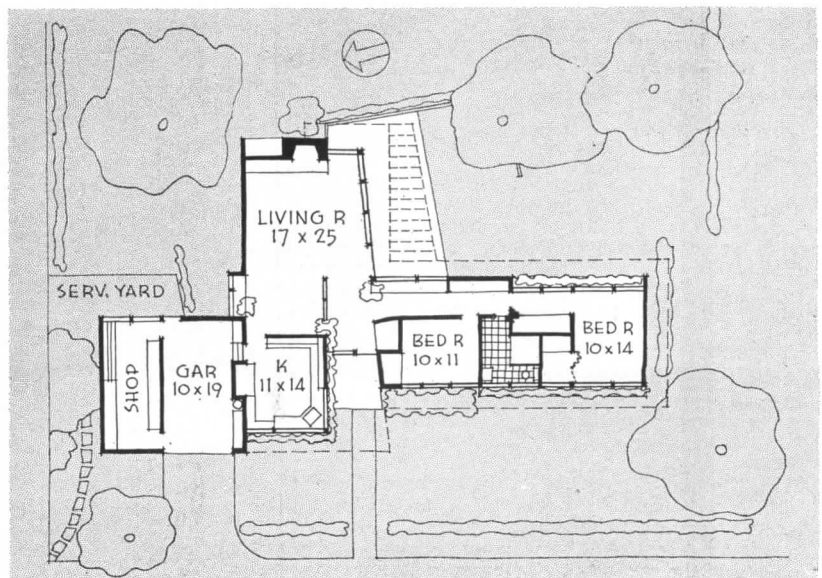
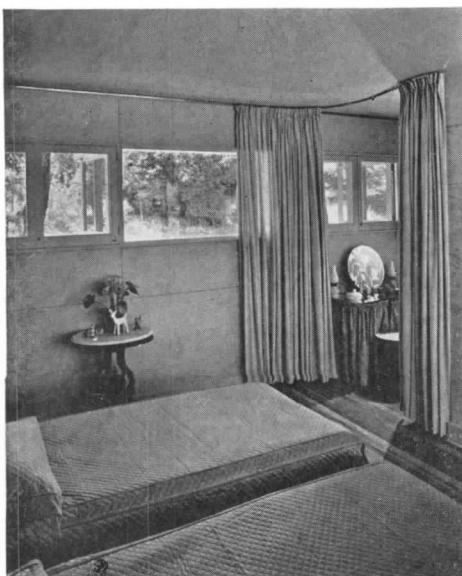
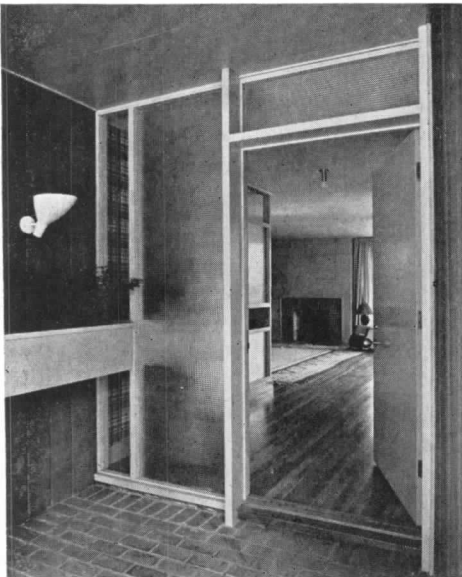





of the house. The service unit is particularly well planned. The arrangement of service yard, shop, garage and kitchen is excellent, and the relationship between the service unit as a whole and the living section of the house is well conceived.

The architectural treatment of the exterior is interesting and refreshing. The strong horizontal of the roof overhang gives unity to the composition. The flower box is unusual and adds interest and color to the entrance. The redwood siding is stained Nile green, with gray-gold trim. The sash are blue-gray.

Above. The garden entrance to the living room opening from the rear terrace. The roof overhang expresses the form of the terrace yet admits light to the living room

Below. The interior view of the living room. The large windows extending from the ceiling to the floor open towards the garden and the panorama of hills beyond



Roger Sturtevant



## 5. COMMANDING A VISTA ACROSS THE VALLEY

VAN EVERA BAILEY, ARCHITECT

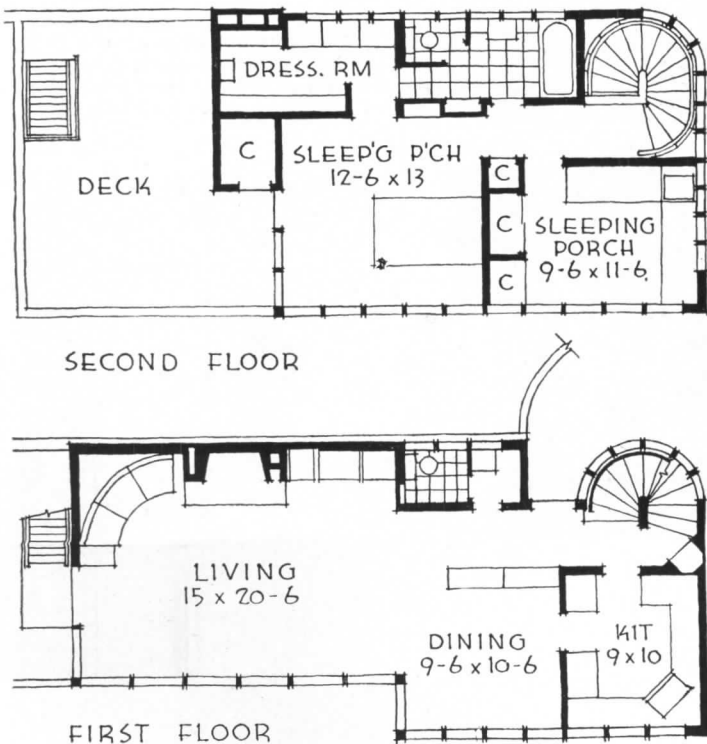

SITUATED on a rugged hillside and overlooking a broad valley to the hills beyond, this little home clearly expresses in its plan the type of location for which it was designed. The living sections of the house on both floors are carefully orientated to take full advantage of the unusual site. The service elements are properly subordinated, compact and well arranged. The large open deck on the second floor opening from the sleeping porch and partly sheltered from the sun by the overhanging roof, is an unusual and desirable feature. The outside stair from the living room terrace to the deck above is unobtrusive.

The exterior is finished with 1 x 6 fir T&G vertical boarding stained barn red. The structure is conventional, with load bearing mullions and braced diagonal shiplap sheathing. Exposed outside walls, floors and ceilings are insulated with cedar shavings.

An electric heating system with soil-heating wires imbedded in ceiling plaster has been used throughout. This was permitted by special city ordinance. Though done on an experimental basis, the system has proved very satisfactory despite an unusually cold winter tryout since construction.

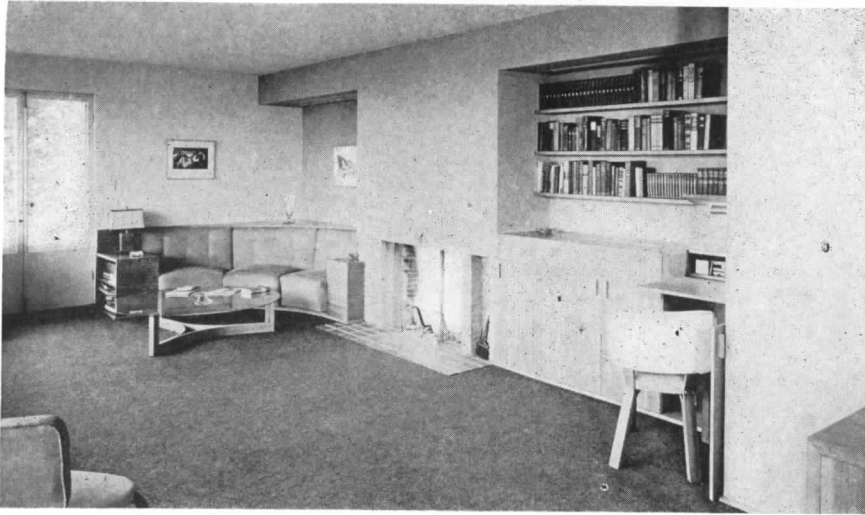

Left: Rear wall of living-room showing built-in furniture, book shelves and cabinets. The fireplace is handled with tasteful restraint and its relationship to the built-in settee is well conceived.

Below: View of the dining alcove from the living-room. Note the built-in cupboard defining the dining area; the large almost uninterrupted window area overlooks the valley below, the hills beyond.

Built-in furniture, designed by the architect, is in natural finish Philippine mahogany. Flush panel doors are of gum wood in natural finish. Floors are T & G fir covered with a broadfelt carpeting.

Below: View from the rear showing the main entrance and the interesting exterior treatment of the stair corner. The roof is of composition type with gravel finish. The mullions are load-bearing.

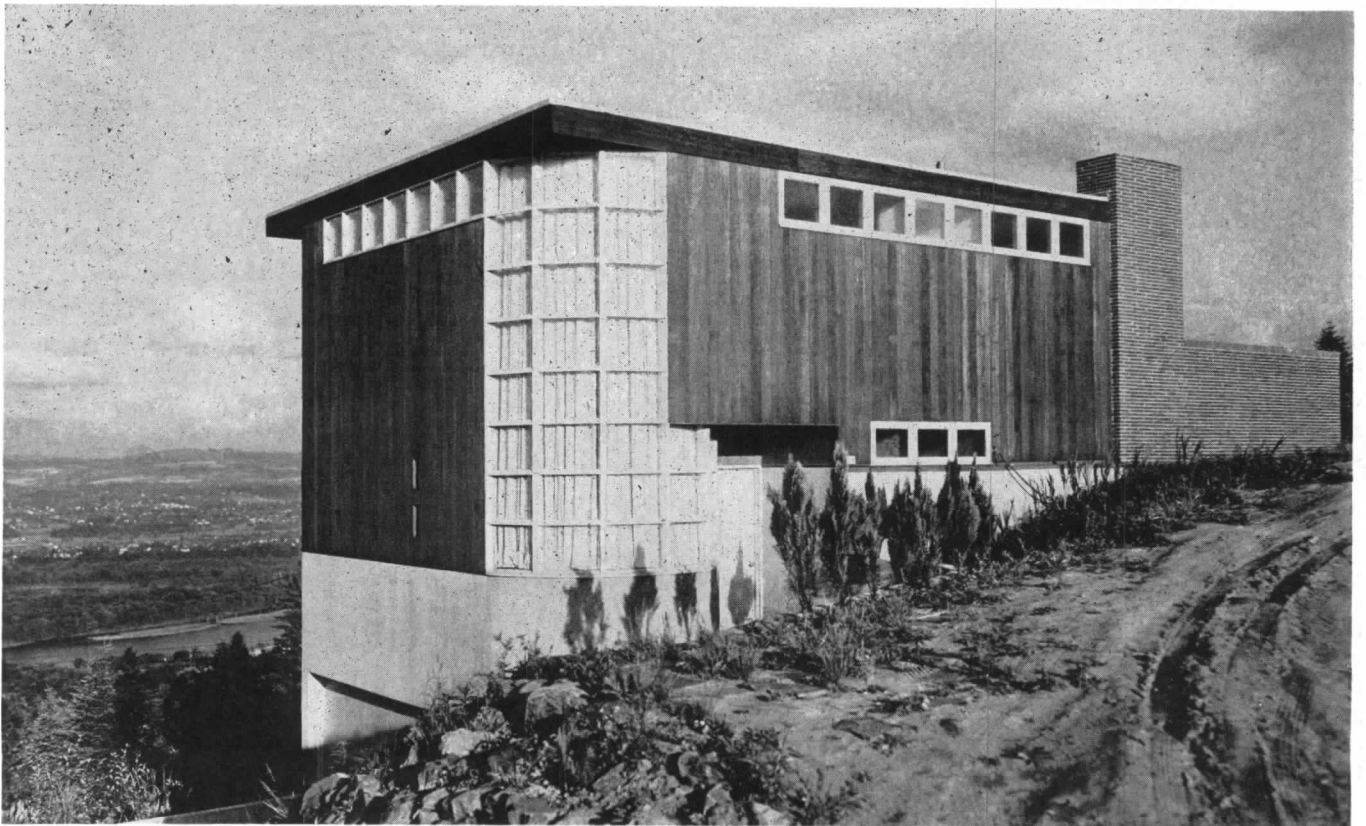
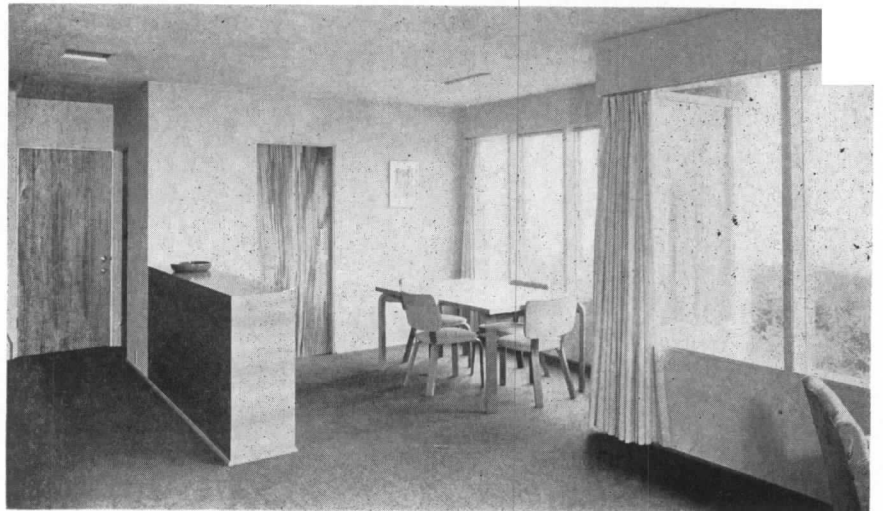

Leonard Delano





## 6. A SMALL HOUSE IN THE EARLY AMERICAN TRADITION

ROYAL BARRY WILLS, Architect

LOCATED among the birch trees in a New England town, this simple home, in the Early American manner, was one of a group of houses built for sale. Although economy ruled the design, as it did in the time when its prototypes were built, the plan was studied for modern living habits and to take the best advantage of the lot. It is arranged so that future rooms can be added in the upstairs section.

The front of the house faces East and the living and dining spaces are turned towards the South. The more private bedroom section is well isolated from the living quarters. The service unit has been carefully studied. Access from the garage to the kitchen, bedrooms or living section of the house is easy and well arranged.

The exterior clapboards are painted red; the doors, windows and exterior trim are painted white. The interiors are of simple, Colonial style, have painted doors and trim and papered walls. Fireplace is of brick with moulded wood trim and wood mantle. Standard oak flooring was specified.

The modern arrangement of the open dining alcove greatly adds to the spaciousness of the living section of the house. The kitchen adjoins garage.

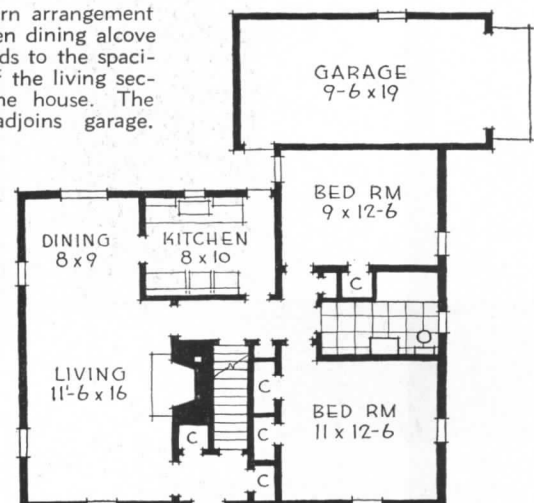

# Freedom

## and SPACE

### IN SMALL HOUSE PLANNING

“PRAISE THE LORD and pass the ammunition—and we’ll all be free.” It’s no mere chance that this refrain is running through the minds and hearts of Americans. On the battle fronts and in homes we are fighting for Freedom.

The home has assumed new importance in American life since Pearl Harbor. Those who have been forced to leave to defend it, realize more fully what their home has meant and should mean to them. Those who stay behind are spending more time in their homes because of gas and tire rationing, and even the young set, *mirabile dictu*, is finding that a good time can be had right at home. More and more families are beginning to feel now that it will be possible to save to have their own home when this is over. Their War Bonds are being earmarked for the down payment on the new home of their dreams, and they are going to be pretty critical of these new homes. They will not put up with the inadequacies and inconveniences of their present dwellings; they will demand more Freedom—more Space. For Space and Freedom are almost synonymous to us all.

Our home builder of tomorrow desires both “freedom *for*” and “freedom *from*.” To sum it up, his home must provide freedom *for* living and freedom *from* drudgery and the elements. But it is not so simple as all that. Freedom for a host of activities must be provided and, in accomplishing this, freedom from interference of one activity with another. Therefore, space must be allotted and arranged for each type of activity in relation to each other activity. But this does permit using the same area for varying activities throughout the day. For instance, the same space can be used for cutting paper dolls in the morning, writing letters in the afternoon and eating meals and studying or games at night. The greatest need for the separation of activities involves freedom from noise, sound interference. The natural segregation of activities in different parts of the house, on the basis of their sound characteristics, is a part of planning for freedom. The individuals needing quiet for concentration need sound separation from active games, the blatant radio or from Junior’s painstaking piano practice. Now, with the freedom of informal living, tight compartments are giving way to open planning and the multi-use of rooms. Space is being used for as many of the twenty-four hours as possible.

Rooms of combined use are larger, more interesting and combat that claustrophobia that made the family seek escape in the family car or the village movie. Natural divisions of room use are brought about by furniture arrangement, built-in features, low and useful cases and cabinets, or by curtains and draperies—and, in some instances, by variations in floor or ceiling levels within the room itself. Space is given a flow rather than being rigidly confined. Large windows grouped to take advantage of what view there may be are replacing the rigid symmetry of the openings of the past. Access to terraces and living porches is made as effortless as possible, and there are many attempts to break down the rigid barrier between indoor and out by introducing plants indoors and by glazing almost completely from floor to ceiling.

In some cases the old explanation, “it’s all done with mirrors,” is literally true, for the apparent spaciousness of a room can be improved about 100 percent by the judicious and imaginative placing of mirrors.

On the following pages are concrete suggestions for doing just that—suggestions that can be absorbed and adapted to the plans that architects will be called upon to draw when materials and equipment are again available.



Plan diagrams by  
George Hall, Architect

# Freedom

## AND SPACE IN THE LIVING ROOM

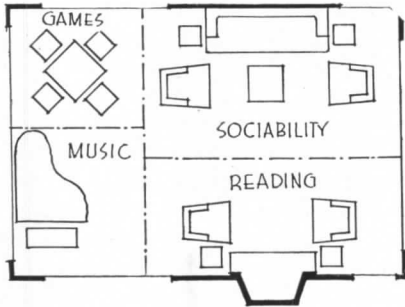

Freedom of interference in space-use can be attained by the diagrammatic study of the placing of furniture or equipment according to primary function. Window arrangement for light and view can follow.

Many different activities that must be accommodated in the living room complicate the space planning for freedom. These activities can be grouped under three headings: 1. social; 2. recreational; 3. cultural. A thorough analysis on the part of the architect of just what activities the family normally engages in is the first requisite for planning the space to provide both enough area and properly arranged area for each of the activities. The analysis must include primarily those activities that presumably will be engaged in simultaneously. Those that follow one another in point of time will permit of dual use of both furniture and space. A careful check list should be made, in consultation with the owners, of what their normal activities are, and are likely to be. A story is told of the famous British architect who would not design a house for his clients until he had lived with the family in their present quarters for a month. This was his way of analyzing their real needs and desires. While this is rarely possible, it is always an advantage to talk frankly with each and every member of the family, so that all the desired accommodations for individual or group activities can be weighed relatively and final decisions made.

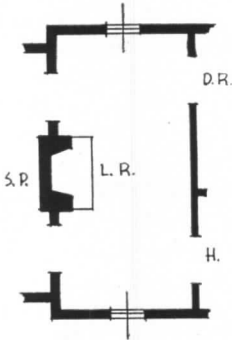

A living area too long and narrow is inimicable to freedom in use. Badly spaced doors prevent functional grouping.

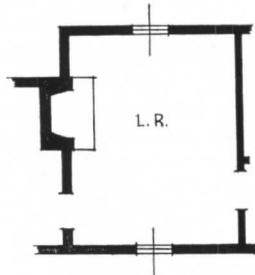

A better proportioned room with fewer doors permits rational grouping of furniture, provides adequate wall space and uses less area for mere circulation.

As each of the activities usually demands its own quota of furniture, and space for its pertinent paraphernalia, all must be enumerated and provided for in the planning. Since most families do not start from scratch with their furnishings, it is well to go over with the client the list of things which they now possess and which they plan to use in the new home. It has been disconcerting in the past to find that there is no wall space for grandmother's huge breakfront or that the only place for the grand piano is next to the fireplace. It is equally annoying to find that it is impossible to sit comfortably and to enjoy the view because sufficient space has not been arranged for the placing of chairs, or the davenport must have its back to the view. Too frequently the window sill is just high

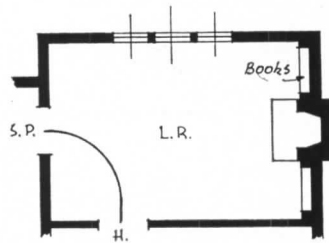
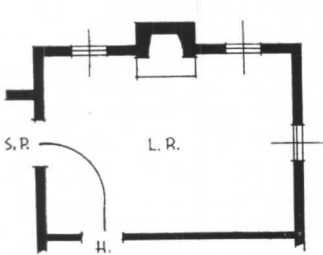

Freedom of space arrangement with adequate circulation achieved by placing doors relatively near one corner. Traffic flow causes minimum of interference with the groupings or activities. Location of fireplace depends on furniture groupings.

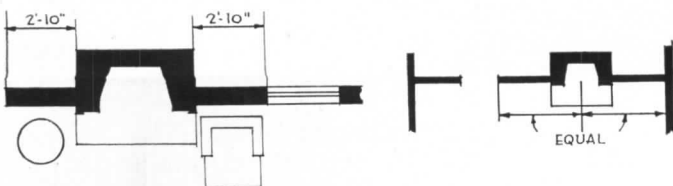

Space at sides of chimney should be minimum 2' 10" to be usable for furniture placement.

A fireplace unsymmetrically placed in relation to length of wall gives greater freedom for logical grouping of furniture.

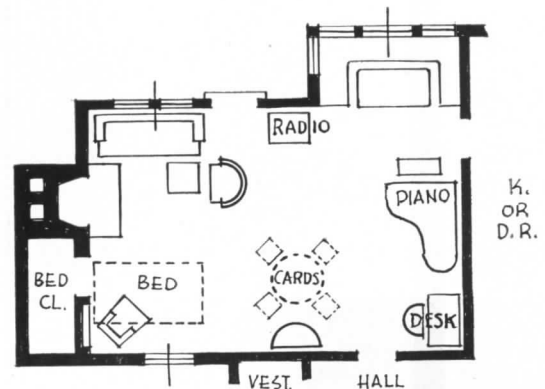

Plan of an actual living room and furniture groupings arranged to give freedom and space desired by owner. Room serves as guest room and the bed closet is deep enough for card tables.



## DEPENDS UPON PLANNING FOR KNOWN NEEDS

enough to cut off all view of the flower garden when a person is comfortably seated and would like to enjoy it.

The furniture grouping has too frequently been neglected in space planning. The same is true of storage facilities, for many of the things which should be stored for convenient use in the living room are jammed in an adequate hall closet. A modest owner's cello is not improved by being stored with baseball bats and roller skates. Accessible storage space can be accommodated between rooms, and the walls of the cabinet and closet space can be used as sound barriers between quiet and noisy areas of the house. Clients will rise to bless the architect who provides a "space for everything" even though habitually nothing is in its place. Card tables and folding chairs are a part of the clutter in many a ménage and hamper the freedom of expression of the host who pokes around behind the children's coats to get them out on occasion.

At practically all home social functions, whether neighborly chats or serious discussion groups, bridge games, or home movies, smoking and liquid refreshments are part of the program of hospitality. A convenient ash tray and a place to set a frosted glass without irreparable damage to a mahogany heirloom are part and parcel of the architect's planning for freedom from embarrassment and inconvenience.

Again, with the possibilities of extensive television service, the location of this radio may have an important bearing on the arrangement of the room, so that a maximum number of observers will be able to see the screen without upsetting the entire room arrangement.

Freedom for individual activity is even more important in space planning than the less frequent social gatherings. Privacy, both visibly and acoustically, is necessary for those pursuits that require concentration. Reading, study, musical practice, writing, and many hobbies may well be segregated into the private quarters of each individual.

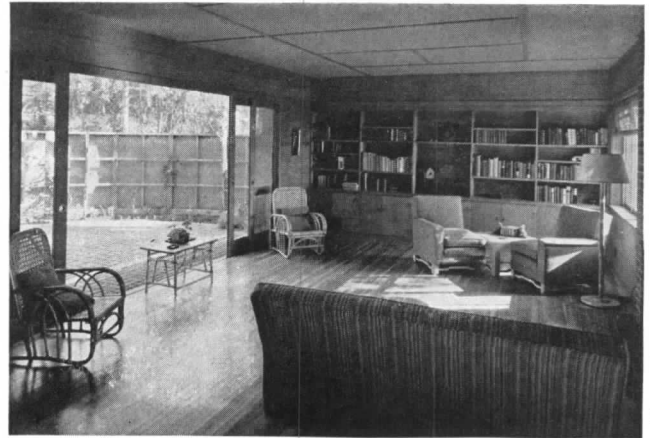

Roger Sturtevant

Freedom and space attained by opening up the garden side of the living room with sliding doors. The terrace with its windbreak wall of wood forms an outdoor extension of the living area. Designed by Clarence W. W. Mayhew, Architect.

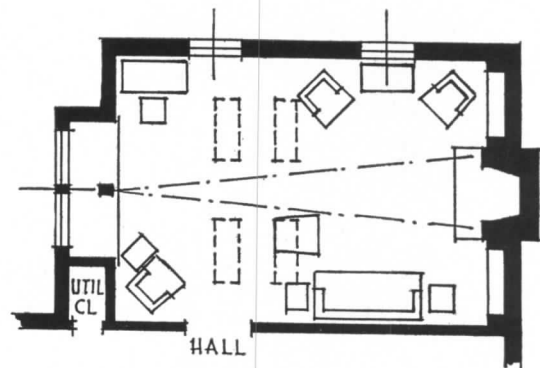

Living room designed for a family addicted to home movies and bridge. Movie projector conveniently stored in cabinet over utility closet which holds bridge tables and chairs. Films and game paraphernalia in built-in storage cabinets under window at left.

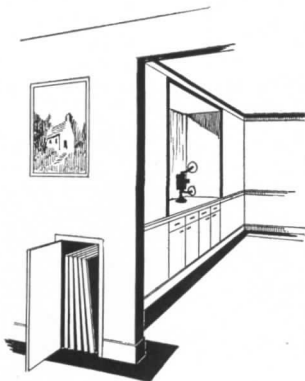

Projector end of living room shown at right. Card table and chair storage easily accessible from hall.

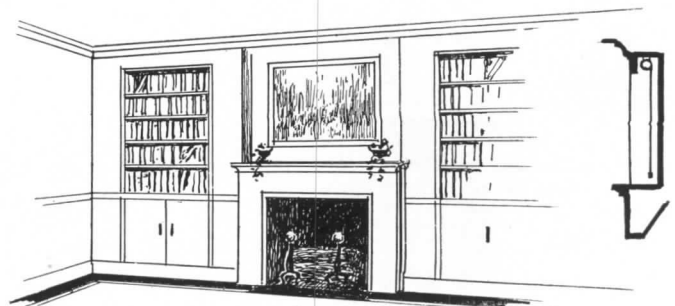

Sketch of the living room shown in plan above. The screen for the projection of home movies is concealed in the cornice above the fireplace. Chairs and sofa are easily swung into position for viewing films, and the living room quickly becomes a theatre.

# Freedom

## GAINED AND SPACE SAVED BY

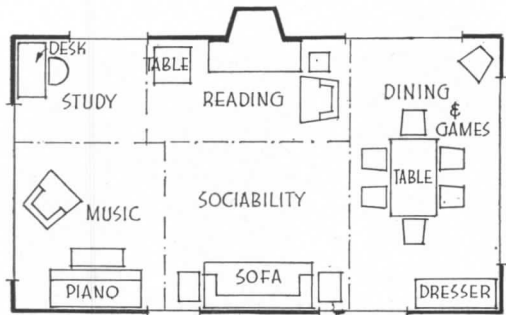

Use of part of living room for dining complicates planning, but increases sense of space. Dining table and chairs are useful for other purposes

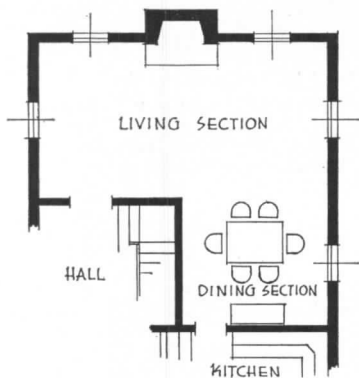

An L-shaped room segregates dining from other activities and gains sense of space

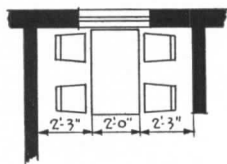

Minimum dimensions for informal dining area are 6 ft 6 in where free-standing chairs are to be used for better comfort and for ease of circulation

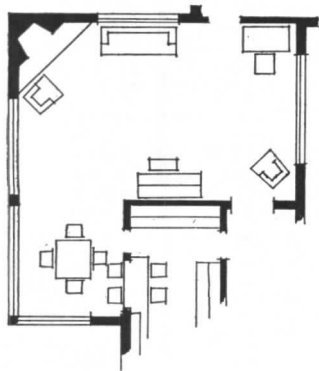

A modern L-shaped living room in which the dining area seems even more spacious, as one side is open and two are entirely of glass. The snack bar counter arrangement of the kitchen is convenient as it serves as a pass-door at meal times

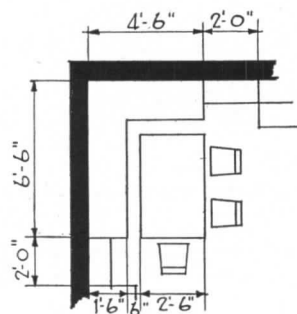

A banquette arrangement in a corner conserves space. It also makes a useful work or study area

A dining projection adds to spaciousness of this living room. The table can be turned in the opposite direction when not used for meals, and the table and chairs can serve other purposes

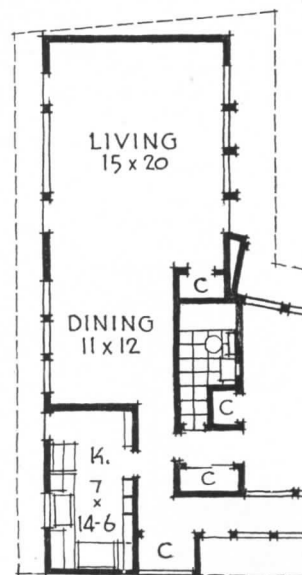
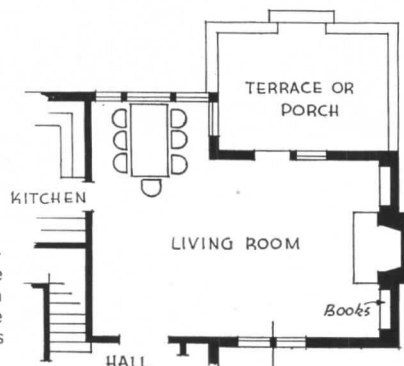

To obtain views in two directions, dining area takes a less desirable location and serves as a passage. MacKie & Kamrath, Architects

# COMBINING LIVING AND DINING AREAS

to the problem of serving meals than combining the dining and living areas. Food serving would be vastly simplified, and many steps saved, through the more direct connection between food preparation and food consumption. The objection is, of course, that the sights, sounds and odors of the kitchen might be offensive to the diners. Screens, curtains and cabinet partitions which do not go to the ceiling, however, can be used to cut off the unattractive view of pots and pans.

As the less aesthetic operations of cooking and of cleaning up come before and after the meal, rather than simultaneously with it, the dinner guests therefore need not be present in the dining area during these periods. Many odors of cooking rather whet the appetite than otherwise, and objectionable odors can be removed at their source by proper mechanical ventilation. In addition, the processes of food preparation have been so simplified by the merchandising of packaged and frozen foods ready for cooking, that much of the former unsightly jumble has been eliminated. The improved gas and electrical appliances for both preparing and cooking the food are decorative rather than otherwise. Also, with the mechanical servants replacing the family retainer in most homes, the culinary art is again being practiced by the housewife. The combining of kitchen and dining areas might give her greater freedom for the practice of her art, as well as the psychological advantage of larger space. It would tend to solve the "small-child-in-the-morning" problem, for under proper supervision the dining area could be used as a play area by the child. This would be especially true if some form of folding table were used for dining.



Cushing-Gellatly

A combined living and dining room, in which the china and glass cabinets are made an attractive feature of the design. Lyford & Magenau, Architects

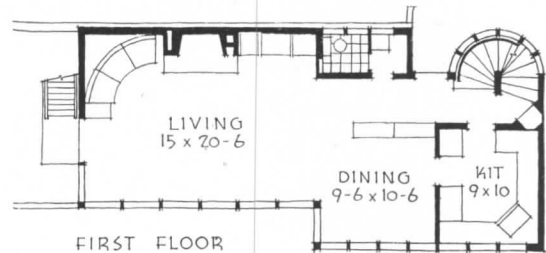

Above: spacious plan in which living and dining areas are divided but not separated. Van Evera Bailey, Architect

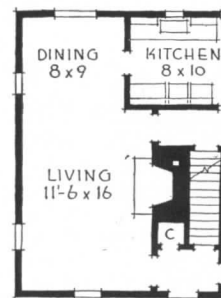

Left: here the living room is narrowed to form dining space and to add space to kitchen. Royal Barry Wills, Architect

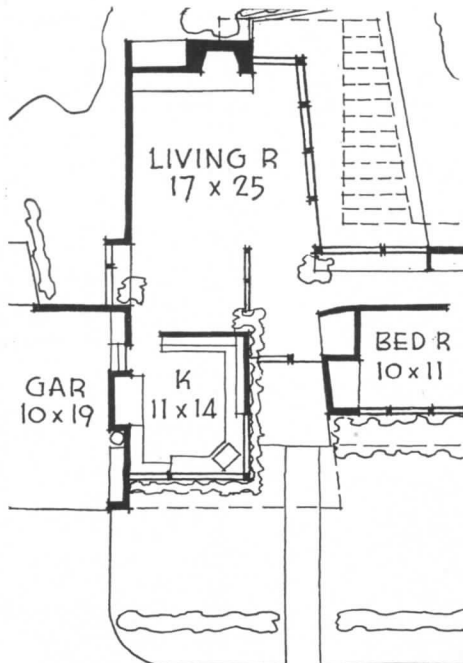

A successful plan in which a bay window adds apparent space to the dining portion of the living room, into which the dining table can be extended. Philip Joseph, Architect, office of John Ekin Dinwiddie

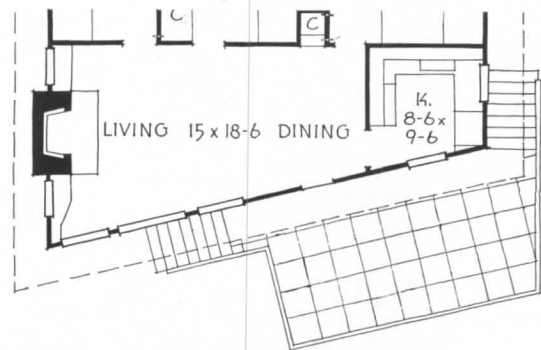

Since the dining area does not need to take as much width in the living room as the other portion, the room itself has been narrowed toward the dining end, to produce an interesting shape as well as a functional one. George Fred Keck, Architect



# Freedom

## FROM DRUDGERY IN THE KITCHEN—

Freedom from drudgery has been given more attention in the kitchen than in any other room in the house. This is natural because it is the work room that must be used much of the day every day. Studies have been made of the steps and motions that are normal to kitchen drudgery and the experts have rearranged the equipment and changed its dimensions to make kitchen work less tiring and time-consuming. Standardization of equipment has also simplified the architect's work so that it has become largely a matter of choosing and assembling standardized parts for convenience and maximum utilization of space. Manufacturers are constantly increasing the efficiency of their units to such an extent that drudgery and unsightliness have almost disappeared from the kitchen. There is no longer the objection, therefore, to eating at least a few meals in the kitchen and various plans have been worked out to incorporate dining space in such a way that it can be used for various purposes when meals are not being served. These dining units vary from small chairs at a table, or stools at a counter, to comfortable upholstered dining alcoves. The additional space increases both the livability and the workability of the kitchen. It is already having another effect in kitchen decoration. The room is becoming more colorful, and losing some of its hospital laboratory appearance while still retaining its cleanliness and orderliness. The results of the research going on quietly during the war will undoubtedly produce much improved kitchen equipment and furnishings and will free the housewife still further from many inconveniences.

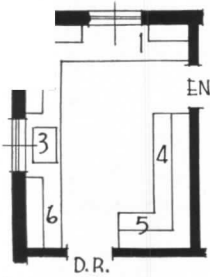

A kitchen plan showing the "production line" arrangement of counters and equipment which is both time and labor-saving. 1. receiving and cold storage near entry. 2. preparation counter; 3. washing and watering; 4. cooking; 5. serving; 6. receiving counter for soiled dishes adjacent to 3

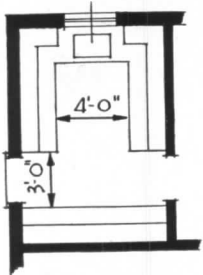

Minimum clearances in an efficient U-type kitchen

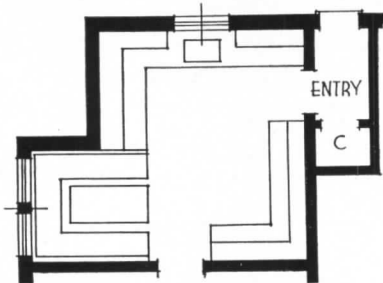

Dining alcove which seats five persons comfortably and six with a chair put at the end of the table

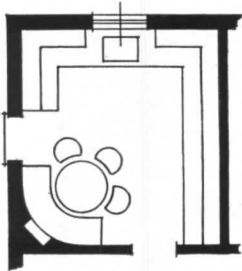

Quarter circle banquette. Chairs slide under the table

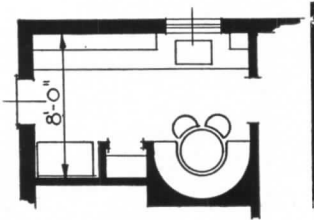

Semi-circular kitchen-dining arrangement. Sink and window should be further to the left

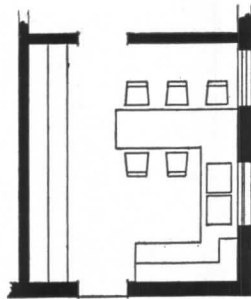

Lunch counter type of food service in kitchen arranged for easy serving



Cushing-Gellatly

A kitchen which includes a washing machine as well as continuous counter space. Electricity frees the housewife from drudgery. Lyford & Magenan, Architects

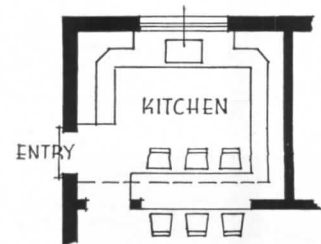

A lunch counter which can be used either from the kitchen or the adjacent room. A sliding panel closes the opening

# -AND FOR MORE USEFUL BEDROOM SPACE

The bedroom is increasingly important in the modern house, as it is an individual's private domain and has many more uses than those of sleeping, dressing and storage. It becomes a home within a home for the particular member of the family. It becomes a sitting room, reading and study room, hobby work room, music room, play room, and, on occasion, a gymnasium. It is increasingly important in planning the house to make sure of the interests and avocations of each member of the family and to know which bedroom is to be assigned to each. Only in this way can those facilities be provided which will take care of the special needs of each individual. A space may be needed for the display of hobby collections, and plenty of storage space for the accumulation of sports equipment in the case of the younger members of the family. A desk or writing table is considered almost as essential in the bedroom as the bed itself, and the location of the book shelves for the owner's favorites is a detail not to be overlooked. Too often bedrooms have been mere cubicles in which no amount of ingenuity could arrange furniture with a semblance of convenience.

The master's suite usually requires special attention, and the arrangement of beds within the room merits the most careful consideration. It should allow maximum open floor space and provide wall space for the essential pieces of furniture, including a comfortable chair for each person. Seclusion and quiet for the master bedroom can be obtained by the arrangement of the closet space and private bath that separate the room from the hall.

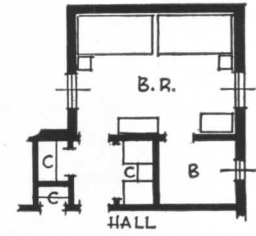
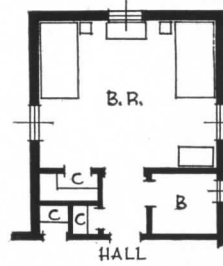

Free space in the center of the room is gained by placing beds in corners along walls as shown in these plans. Closet space, passage and bath insure quiet

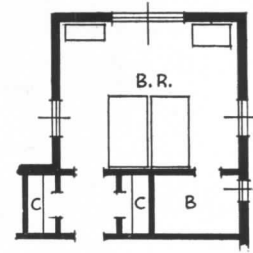
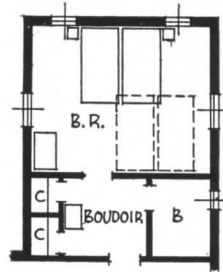

Beds arranged for free circulation. Dotted lines show a less desirable location

A poorer placing of beds as occupants face windows and beds block the circulation

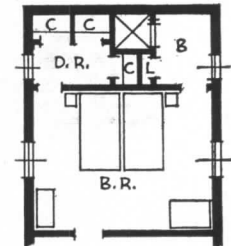
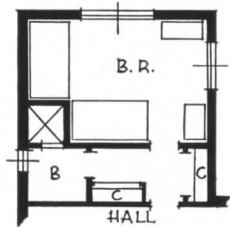

A more unusual plan giving maximum free space in the small size double bedroom

An arrangement preferred by some where sound insulation is not desired



A convenient dressing room arrangement in which closet doors become parts of triple mirror



Built-in beds reminiscent of old world custom are favored by younger members of the family. Under-bed storage saves otherwise wasted space for toys



A bedroom which combines the functions of sitting room and study. The fireplace is desirable. Alice Morgan Larson, Architect—Van der Gracht & Killiam, Associates

Samuel H. Gottscho

# Freedom

## BY ADDING JUST ONE SMALL ROOM

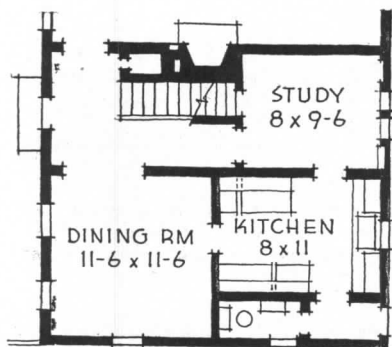

The study serves a multitude of uses. This one would serve as guest room or as maid's room

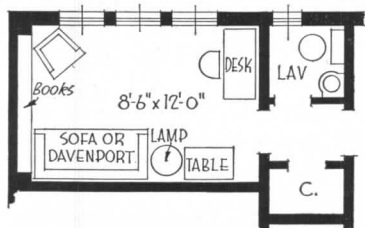

A study arranged to serve also as a guest room. First-floor lavatory and a closet are adjacent

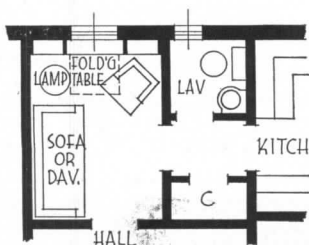

A minimum room with maximum possibilities, is accessible from either hall or kitchen, and can be closed from either

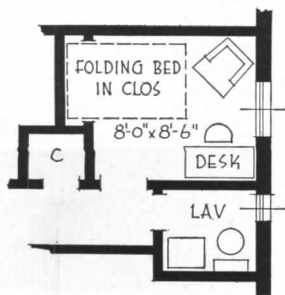

Space is conserved in this study-guest room with closet type bed

It is often possible to increase the livability of even a small house by adding just one small room, usually known as the "study." This serves many varied uses and various members of the family. It provides a retreat from the noise that may be necessary in other portions of the house and privacy for business conversations when the master of the house must talk things over without disturbing the normal activities of the living room. He also may use this room when he brings work home from the office. Slightly enlarged it may even be called the library or the gun room. It makes a convenient place to store the master's tackle, guns and other sacred possessions.

It takes the place of the old spare room in accommodating the over-night guest; it serves as the family office. It may prove a God-send as an isolation ward if little William should get scarlet fever. Also when Susan has callers, father can still read his evening paper in peace. Such a room need not be large, but does need careful planning to accommodate comfortable chairs, a convertible couch or closet bed, book shelves and a desk. A fireplace adds immeasurably to its comfort and its atmosphere. It will naturally have its own small radio. The lavatory should be provided adjacent to the room but separated from it so that it will not be necessary to pass through the room. Many times it will serve as either a powder room or a coat room when a party is in progress. Various solutions to the planning problems of the room are shown in the plans at the left.

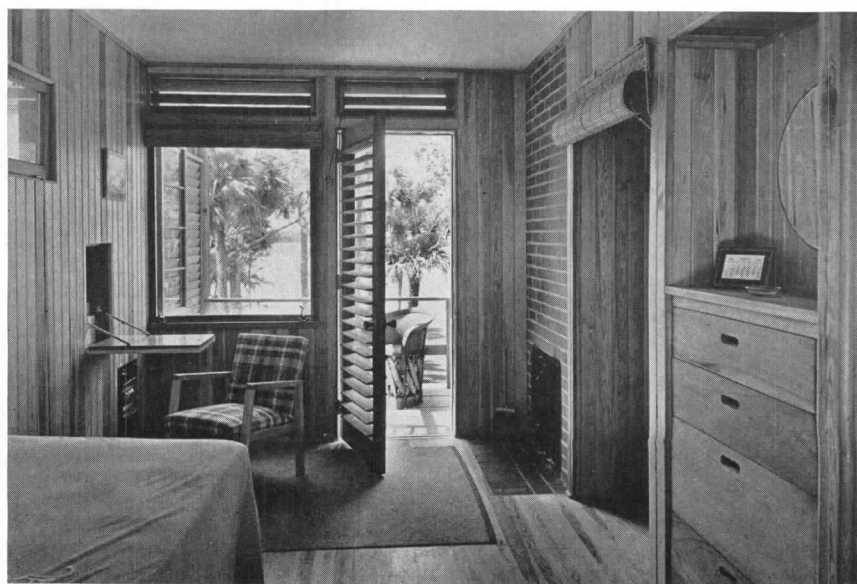

A guest room provided with folding writing desk, built-in heater, fireplace and dresser. Alice Morgan Larson, Architect—Van der Gracht & Killiam, Associates





## PLANNED FOR SPACE AND FREEDOM

GEORGE FRED KECK—Architect

OPENING to surrounding terraces and gardens with spacious vistas of trees and hills, this summer residence is located on sloping grounds a few hundred yards from the shores of Green Bay. Widely overhanging pitched roofs, combined with high windows, were designed to extend the open panorama to the sky itself, taking advantage of the dramatic patterns of storm clouds and Northern Lights.

The plan is well integrated with respect to service, social, and the more private bedroom elements. The big story-and-a-half living room and connecting game room were primary requirements of a socially inclined family consisting of a surgeon, his wife, who is composer of contemporary music, and their two children of college age, one a boy and the other a girl. This social living center of the house opens in huge glass areas to terraces on the east and west. The large west terrace and glass dining room face toward the bay. The service units and road are to the north and the sleeping rooms face the south. A segregated studio and composing room is on the third floor and above this a sun terrace affords an uninterrupted view.

Local stone, largely uncut, was used for building purposes. Taken from the ground and laid up in its natural form, it provides a rough textured wall surface. The wood is fir, treated with wood preservative and left in natural finish both inside and outdoors. Fireplaces are equipped with heating units and the residence can be used all year.

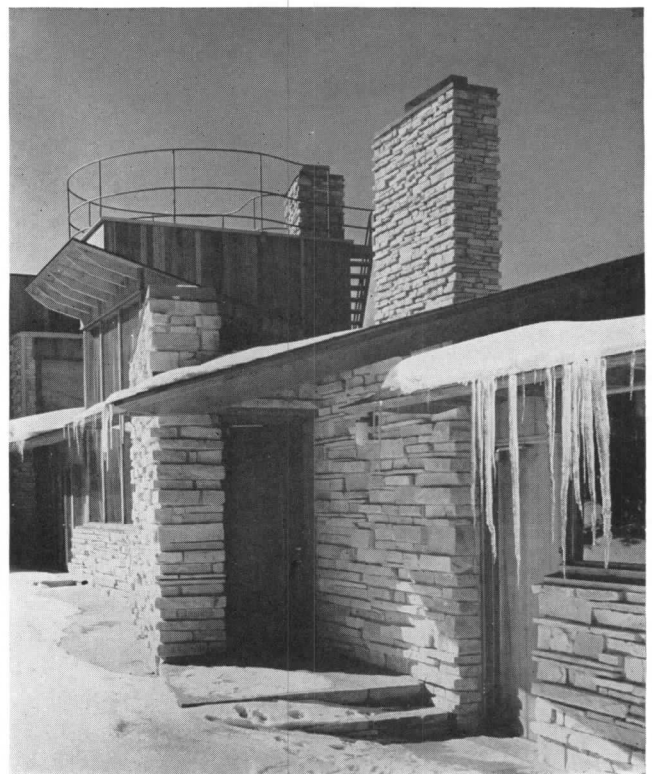

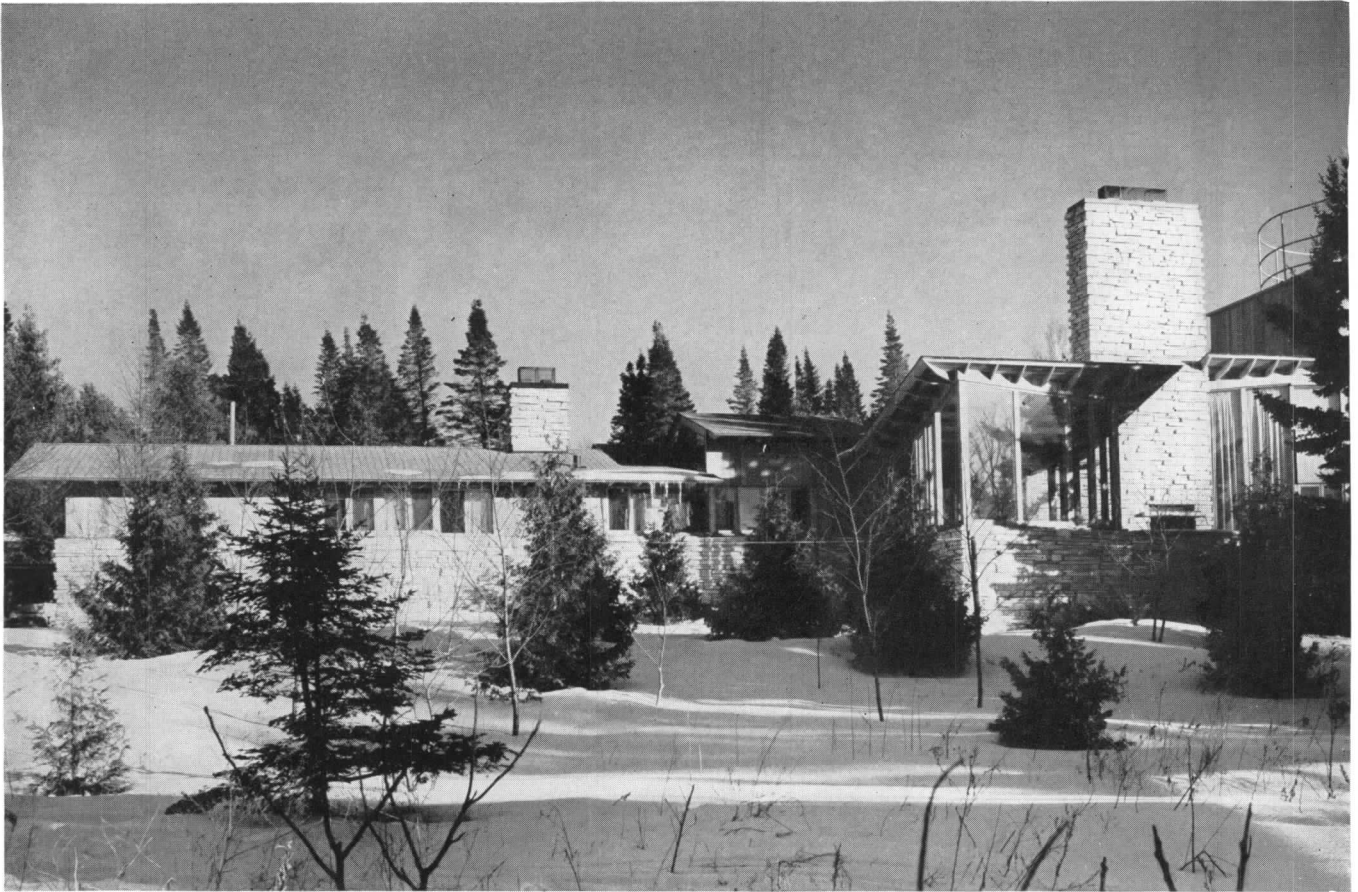

Above. The glass dining room projects in the right foreground. The lightness of the wide glass areas contrasts sharply with the heavy stone masonry of the chimneys.

Below. The plan expresses to an unusual degree the open and intimate relationship of indoor social and living space to outdoor terraces and surrounding areas.

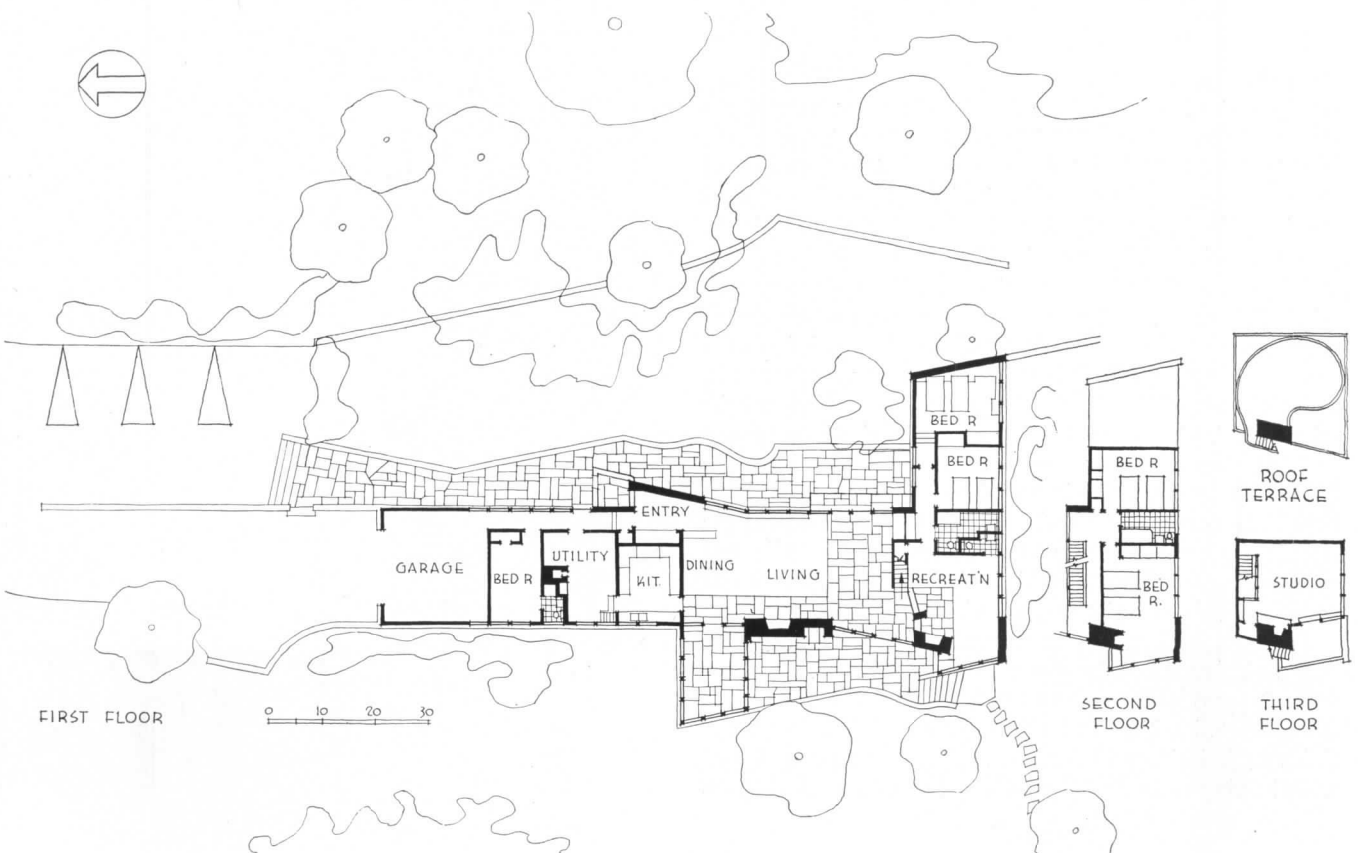

At right. The west elevation showing bedroom wing with recreation room below. The exterior stairway leads from the studio terrace to the high sun deck with its wide view.



Below. Interior of living room looking towards entry and showing unusual scissors truss construction of ceiling. Large windows at right look towards the sky. (See section page 68)



William Keck



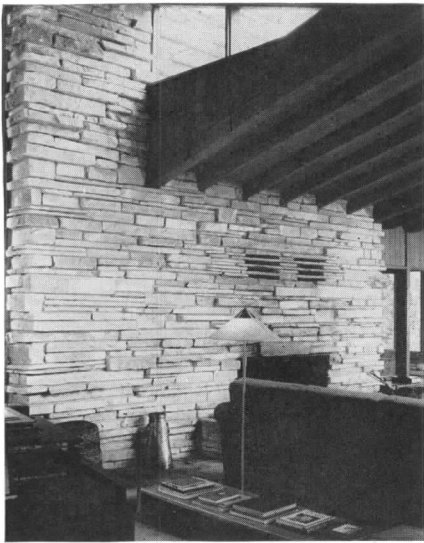

Right. Section through living room and fireplace. Unusual height of the large living room window, permitting a wide panoramic view, is obtained by the use of scissor truss roof construction.

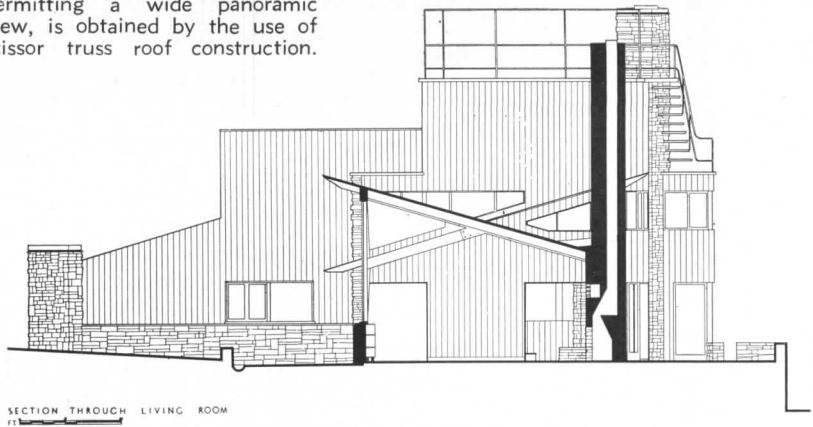

SECTION THROUGH LIVING ROOM

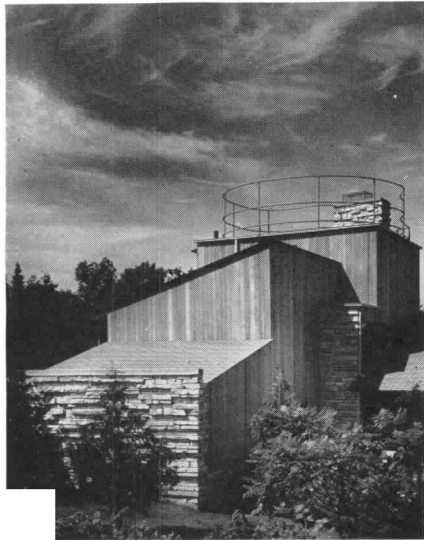

Above left. The main fireplace in the living room. The stone grille is for a large unit heater. Left. The bedroom wing from the east. The lines of the pitched roof build upward to the sun deck.

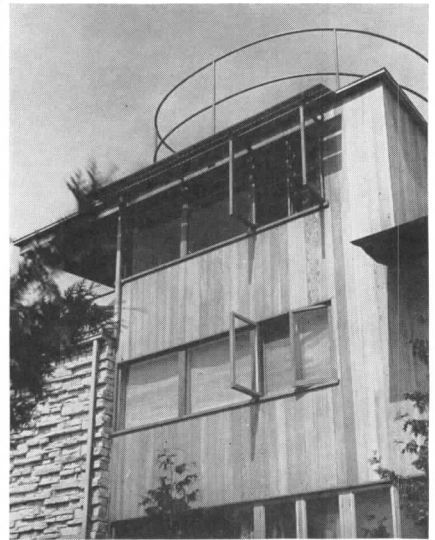

Right. The sun deck, studio, and bedrooms open towards the south. The contrasting wall surfaces of stone, wood, and glass and the wide roof overhangs form an interesting pattern. Note sunshade



Detail of simple built-in wardrobe unit forming one wall of the master bedroom.

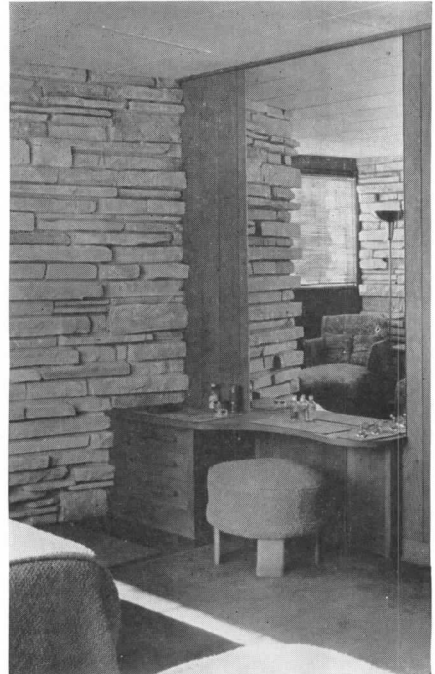

Built-in dressing table in master bedroom.

# LOUVERS FOR HOUSE CONSTRUCTION

by Carl T. Sigman and Wm. J. Ward, Jr.

The term "louver" usually means a series of parallel, horizontal vanes fixed at an angle of 45° set high in the gable end of a dwelling. Of course, other forms may be equally effective and be more appropriate to the general design of the building—there are those that form a kind of dormer used on hip roofs; and the decorative cupola louver set atop the ridge of so many of our early American buildings, both public and private. And many others.

The chief use and purpose of louvers is to ventilate attic spaces for the purpose of summer cooling and drying to avoid excessive heat and humidity, and at the same time to keep out rain, snow and pests. They are necessary also because lack of ventilation encourages the dry rot.

In these Time Saver Standards are shown, in addition to those mentioned above: louvers between rooms; jalousies, or the louvered doors and porches of the South; a louvered door for a dark room; louvers under porch-

es and between basements and unexcavated areas; louvered cabinets; louvered vents for fixed windows; and louvered fences.

## DESIGN PRINCIPLES

Only a few rules govern the design and placing of louvers. They must, of course, admit no precipitation while inhaling or exhaling air. Birds, squirrels, mice, and insects must be barred with rust-proof screening. Louvers in attics should be placed as high in the attic space as they conveniently can be to avoid pockets of hot and humid air forming above the louvered openings; and since ventilation is only possible with circulation of air, means must be provided to bring in cool or dry air to replace warm or moist air. The need for dual venting is particularly important wherever dead air space occurs, as in the space between porch ceiling and roof.

Since insulation in all buildings has

become the rule rather than the exception, it is proper to quote here a paragraph of the findings of the National Mineral Wool Association, "An important point to remember is that vents or louvers form a necessary safety valve for the natural elimination of moisture vapor, and should always be installed above insulation. Louvers should have a minimum free opening of 25 sq. in. per 100 sq. ft. of ceiling for each of two vents located at opposite ends of the attic, as close to the roof peak as possible."

For louvers covered inside with 1/2" mesh hardware cloth, add 20% to the required opening, which is simply the space between the louver slats; and when 16 mesh screen is used, add 100%.

It's interesting to note here that metal louvers offer less obstruction to air flow, and consequently their overall size may be less than other types. In some design problems, this may be a controlling factor in the choice of louvers.

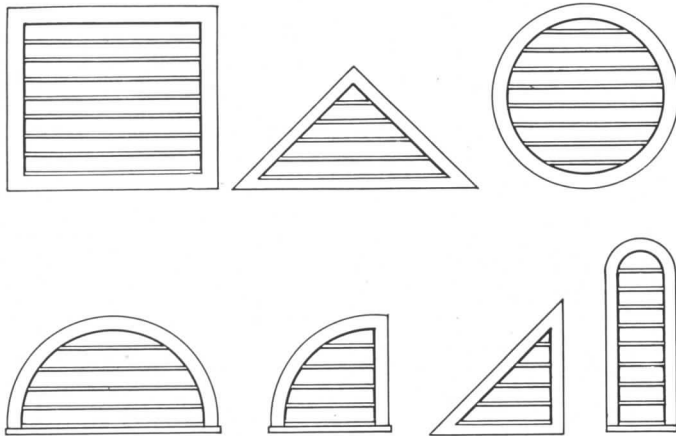

GABLE OR ATTIC WALL LOUVERS

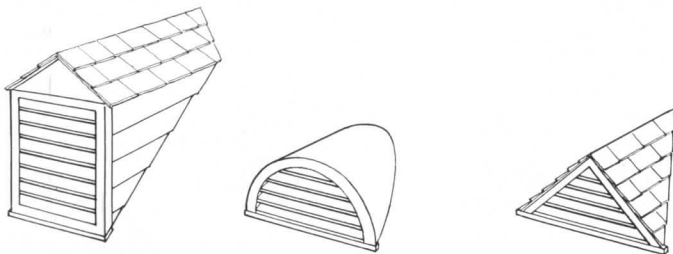

DORMER LOUVERS FOR HIP ROOFS

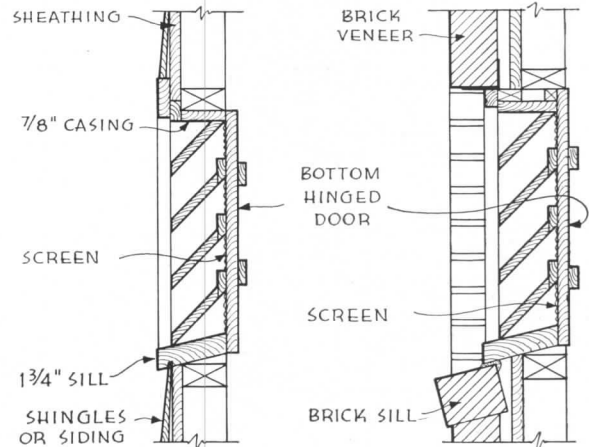

TYPICAL SECTIONS  
 FRAME BRICK VENEER  
 SCALE - 3/4" = 1'-0"

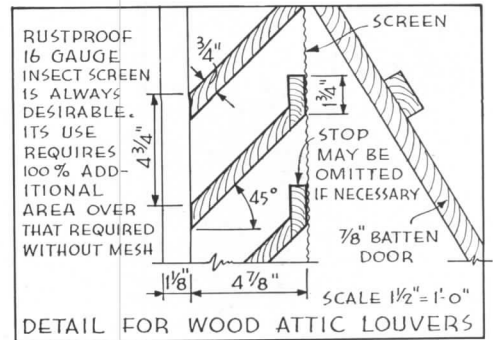

DETAIL FOR WOOD ATTIC LOUVERS

# LOUVERS FOR HOUSE CONSTRUCTION—2

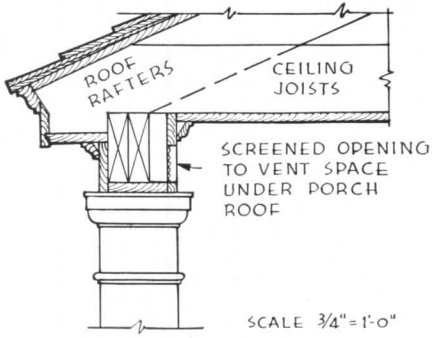

SCALE 3/4"=1'-0"  
 PORCH ROOF VENTS

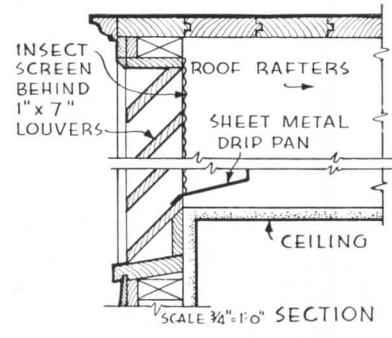
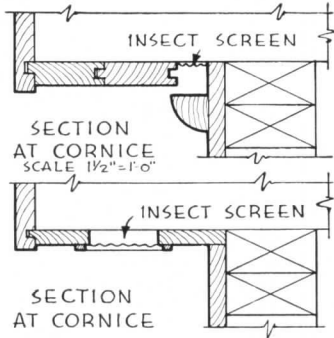

SCALE 3/4"=1'-0" SECTION  
 VENT FOR FLAT ROOF SPACE

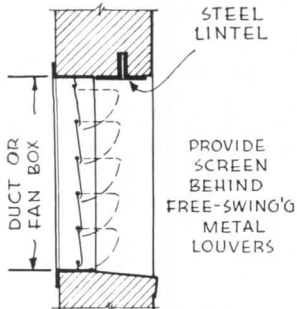

AUTOMATIC EXHAUST LOUVERS FOR FAN

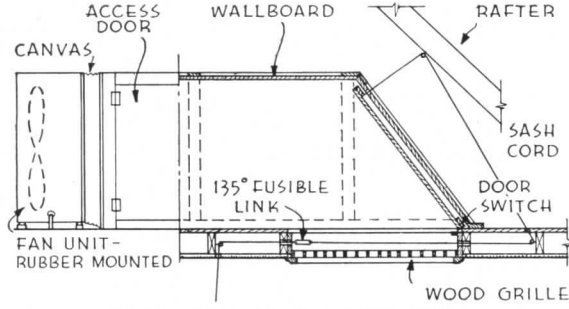

ATTIC FAN IN SUCTION BOX WITH CEILING GRILLE  
 NO SCALE

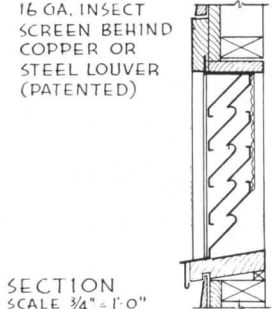

SECTION SCALE 3/4"=1'-0"  
 HOAL'S LEAKPROOF METAL LOUVER

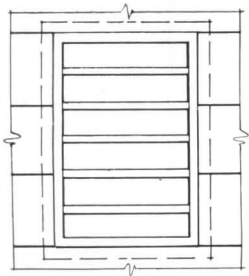

ELEVATION

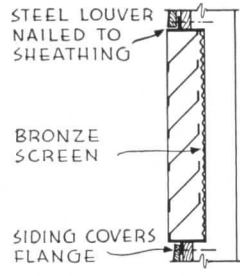

SECTION SCALE 3/4"=1'-0"

TYPICAL FACTORY-MADE METAL LOUVER

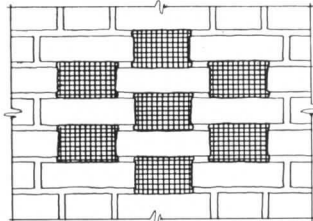

ELEVATION

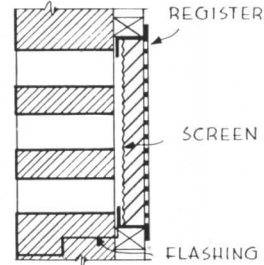

SECTION SCALE 3/4"=1'-0"

OPEN BRICKWORK VENT

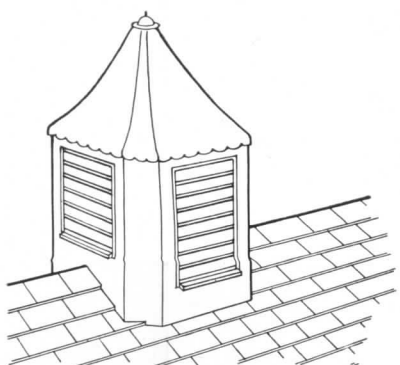

LOUVERED CUPOLA AT ROOF PEAK FOR GARAGE OR HOUSE ATTIC

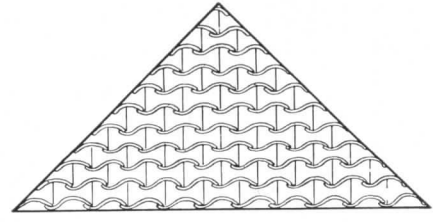

ELEVATION

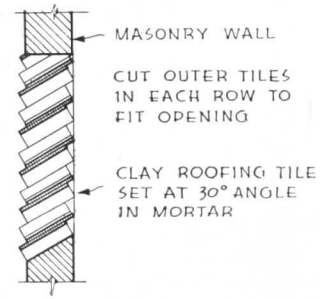

SECTION NO SCALE

GABLE LOUVER OF CLAY ROOFING TILE



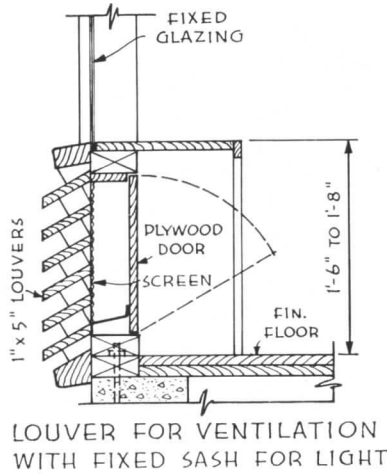

LOUVER FOR VENTILATION WITH FIXED SASH FOR LIGHT

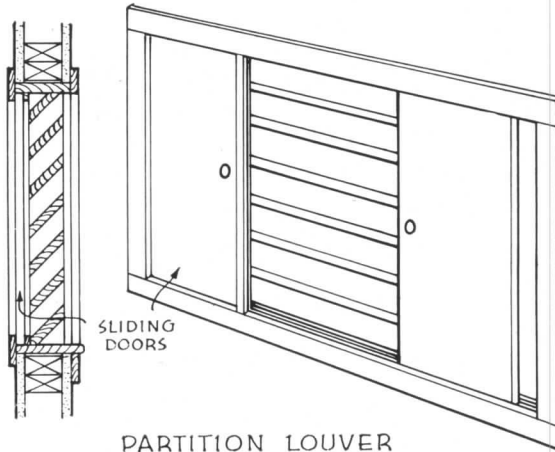

PARTITION LOUVER

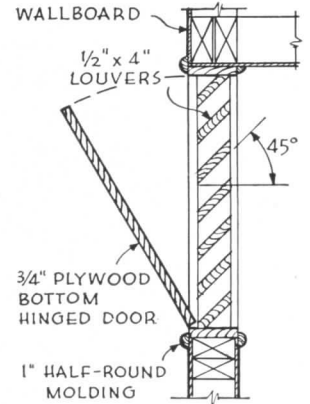

LOUVER IN PARTITION BETWEEN MINOR ROOMS

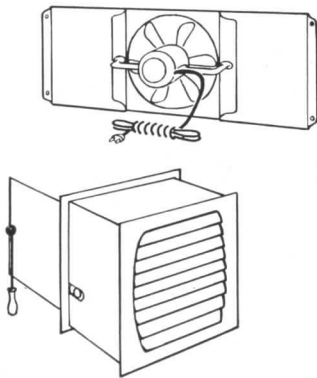

KITCHEN VENTILATING FANS

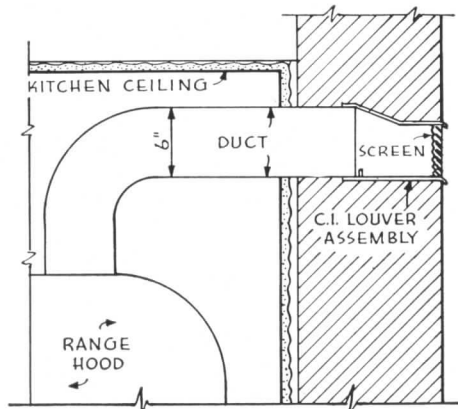

RANGE HOOD DUCT WITH LOUVER

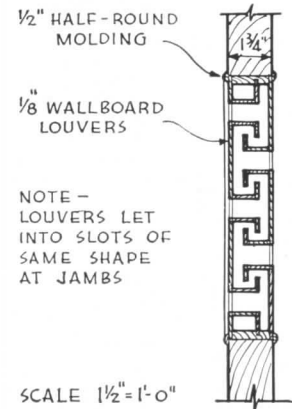

NOTE - LOUVERS LET INTO SLOTS OF SAME SHAPE AT JAMBS

SCALE 1/2" = 1'-0"

MAZE LOUVER FOR DARKROOM DOOR

## LOUVERS FOR FIRST AND SECOND STORY USES

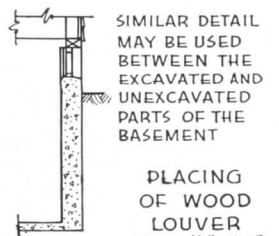
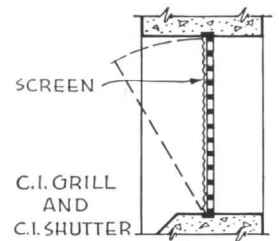
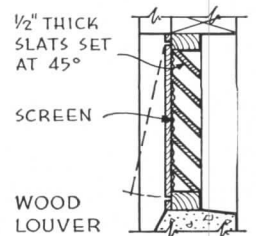
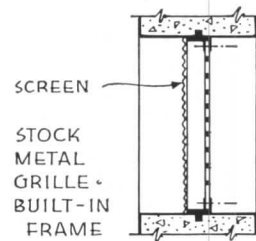
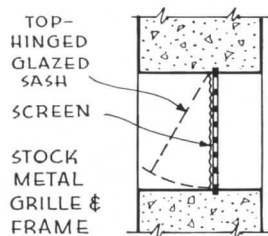
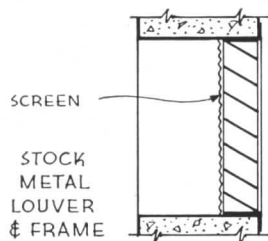
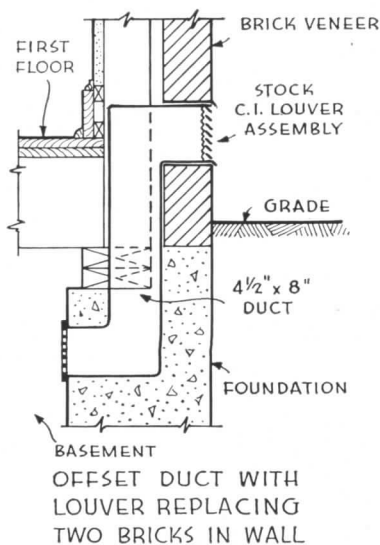

## VENTS ABOVE GRADE

## LOUVERS FOR BASEMENTS

EXCEPT WHERE NOTED SCALE OF ALL SECTIONS ON THIS PAGE - 3/4" = 1'-0"

# LOUVERS FOR HOUSE CONSTRUCTION—4

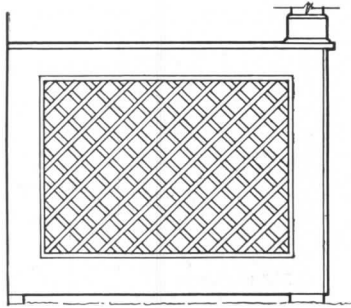

LATTICE  
 BENEATH PORCH

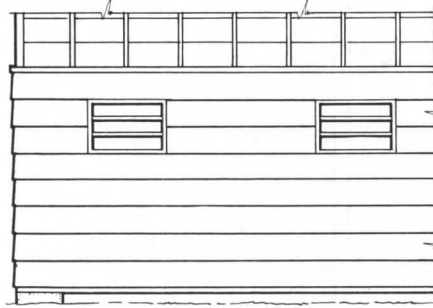

LOUVERS FOR ENCLOSED SPACE UNDER PORCH  
 SCALE  $\frac{3}{8}'' = 1'-0''$

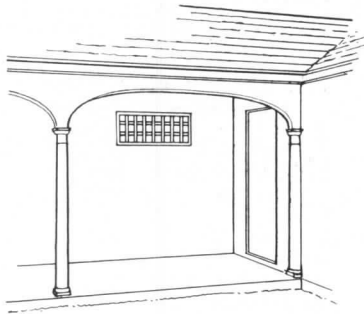
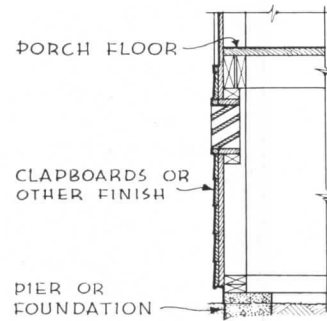

LATTICE IN LOGGIA WALL

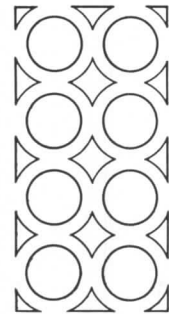
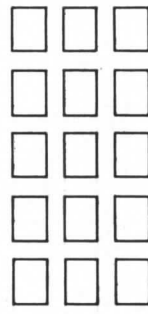

PRE-CAST MASONRY GRILLES

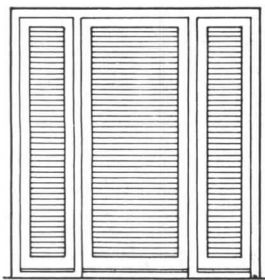

JALOUSIE FOR ENTRANCE DOOR

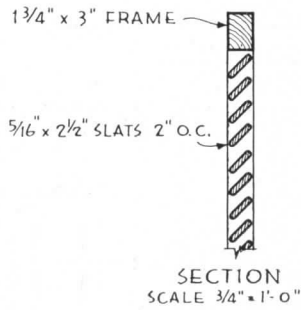

SECTION  
 SCALE  $\frac{3}{4}'' = 1'-0''$

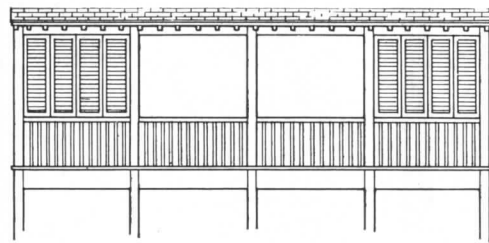

ELEVATION

JALOUSIES PARTIALLY ENCLOSED  
 BALCONY OR PORCH

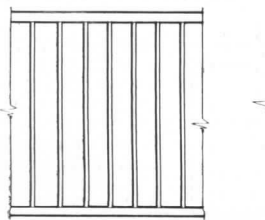

PLAN & ELEVATION  
 SCALE  $\frac{3}{8}'' = 1'-0''$

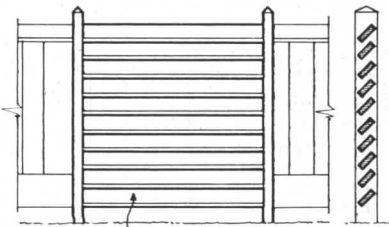

1" x 3" SLATS 3" O.C.  
 ELEVATION SECTION

LOUVERED FENCES  
 LOUVERS FOR MISCELLANEOUS PURPOSES  
 SCALE AS NOTED



FACTORY-MADE LOUVERS  
 FOR WOOD OR METAL DOORS



METAL WITH  
 SLIDING  
 DAMPER  
 METAL  
 GRILLE

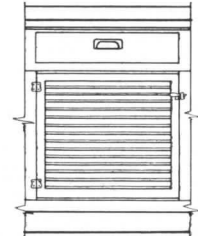

ELEVATION  
 FOR SINK CABINETS  
 SCALE  $\frac{3}{8}'' = 1'-0''$



SECTION

LOUVERED DOORS

# Carey PRODUCTS

ASPHALT · ASBESTOS · MAGNESIA

## *Saving* Vital Materials

Helping Speed VICTORY  
for America at War!

On many home fronts and on ships that range the seven seas, the CAREY Family of Products is serving America at war—helping industry win the battle of production—contributing to essential civilian requirements.

Some Carey Products are saving vital materials—steel, fuel oil, coal . . . others are providing invaluable fire-and-weather protection . . . speeding erection of buildings . . . increasing efficiency of workers . . . lessening accidents. In hundreds of important government, industrial and private projects, Carey Products are rendering dependable service and effectively reducing overhead costs.

Meanwhile, the light of scientific research continues to burn brightly in the Carey research laboratories—checking, testing, improving, pioneering—to the end that the building industry may have more and better materials with which to build post war America.

### THE PHILIP CAREY MFG. COMPANY

*Dependable Products Since 1873*

Lockland, Cincinnati, Ohio

In Canada: The Phillip Carey Company, Ltd.  
Office and Factory: Lennoxville, P. Q.

Asbestos Duct conserving steel in air conditioning systems (over 1,500,000 lbs. saved in the new War Department Building alone) . . .

Heat Insulations saving fuel in tankers and other ships . . . in mammoth powder works . . . in new electric power plants . . .

Rock Wool Insulation reducing fuel waste and contributing to comfort in multiple housing projects, public buildings . . .

Built-Up Roofs protecting airplane engine plants, machine tool works . . .

Industrial Flooring increasing efficiency of workmen—cutting floor upkeep—in new metal-working plants, power houses, etc. . . .

Corrugated Asbestos-Cement Siding and Roofing protecting chemical plants, oil refineries boiler houses, etc., against fire, corrosion, weather and wear . . .

Expansion Joints solving difficult problems in airport runways, pavements, roads, etc. . . .

Other Carey Products include:  
Asbestos-Cement Siding, Shingles and Wallboard . . . Asphalt Roll Roofing and Shingles . . . Hot Water Tank Jackets . . . Boiler and Pipe Coverings . . . Metal Bathroom Cabinets and Accessories . . . Roof Coatings and Cements . . .

#### Illustrations:

1—Housing Project, Asbestos-Cement Shingles. 2—Tanker, Heat Insulations. 3—Public Building, Asbestos Duct. 4—Oil Refinery, Asbestos-Cement Roofing and Siding. 5—Armory, Rock Wool Insulation. 6—Ordnance Warehouses, Built-Up Roofing. 7—Machine Tool Plant, Built-Up Roofing. 8—Metal Working Plant, Industrial Flooring. 9—Airport Runways, Expansion Joint. 10—Powder Plant, Heat Insulations. 11—Power Plant, Heat Insulations.

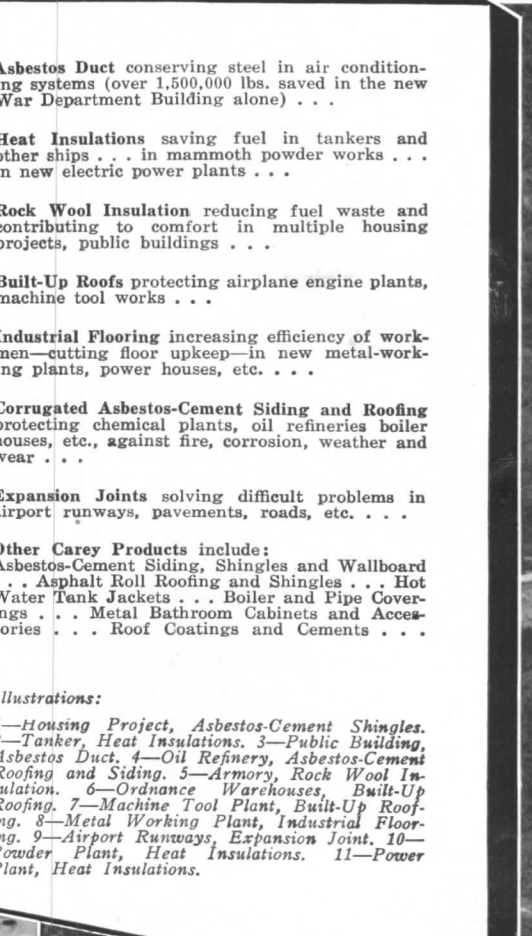
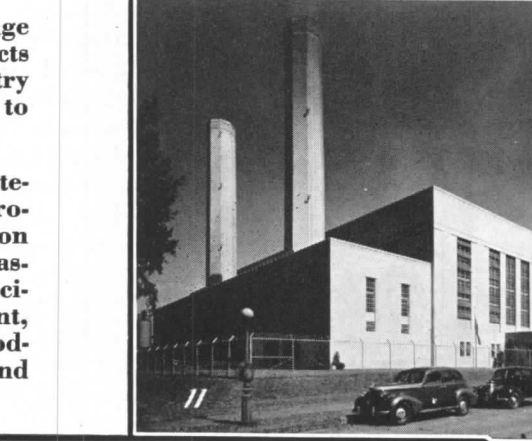
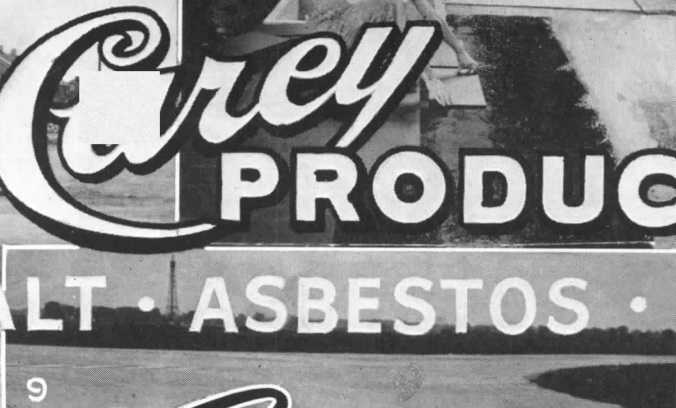
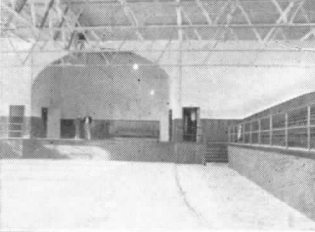
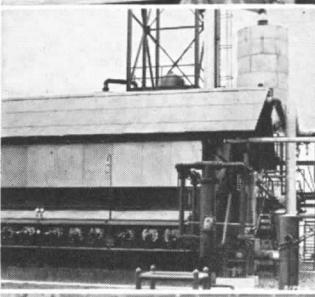
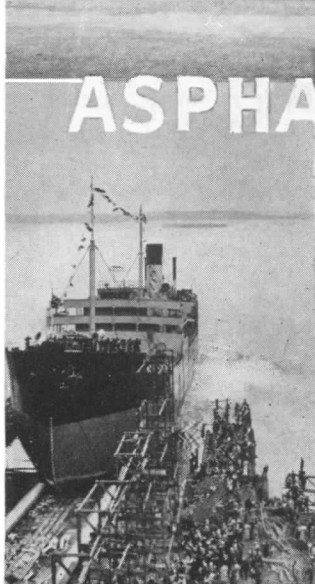





Figure 1

## INDUSTRIAL LIGHTING

A NEW METHOD of indirect mercury lighting, designed by a Westinghouse Lighting Division engineer, makes it possible to eliminate localized lighting, direct and indirect glare, and shadows. The system was worked out by using a tunnel-shaped plant model representing part of an airplane plant. With 35 foot candles of illumination provided under the wings of model planes placed inside, Westinghouse reports no localized lighting for underwing assembly work is necessary. (See Figure 1). Westinghouse Electric & Manufacturing Company, East Pittsburgh, Penna.

## SEALING ASPHALT COATINGS

AN EMULSION type of coating is now being manufactured for the sealing of asphalt or bituminous coatings used for water-proofing. This product, called Carbo Seal Coat, makes possible the application of light colored coatings over an asphalt or bituminous coating without bleeding-through by the asphalt. It was developed as a substitute for the aluminum heretofore used for this purpose, and now made unavailable by the war. Carbozite Corporation, First National Bank Building, Pittsburgh, Penna.

## VICTORY LOCKER

THIS "all purpose" locker now being manufactured makes use of no critical materials. Pre-fabricated and made of wood, it may be quickly assembled and is light, durable and strong. Curtis Companies, Inc., Clinton, Iowa.

## ADJUSTABLE WOODEN SHELVING

LYON METAL Products, Inc., is offering for the duration a quickly adjustable wooden shelving as a substitute for the metal shelving eliminated by steel priority. Lyon Wood Shelving comes in open and closed types. Sections are 36" wide and 84" and 96" high. They may be had in 12", 18" or 24" depths. Top, base, shelves, braces, arms and uprights are made of solid hard wood. Side panels, back panels on closed type are 1/4" plywood. Lyon Metal Products, Inc., 2016 Clark Street, Aurora, Ill.

## CHEVRON BOARD

A NEW, low-cost, plastic-coated wall board, available in large wall size sheets and requiring no on-the-site finishing, has just been introduced by the Barclay Manufacturing Company, Inc. The panels, in sizes up to 4 x 8 feet come in three designs—tile board, unscored sheets, and streamlined—and in a wide range of pastel tones. According to the manufacturer, the special plastic finish will not warp, chip, craze, crack, or peel, and the panels already are being used by the Government for ship construction, war housing, and military bases and installations. The panels are quickly and easily installed. (See Figure 2). Barclay Manufacturing Company, Inc., 385 Gerard Avenue, New York City.



Figure 2

## WOOD ROLLING DOOR

BECAUSE of the wartime metal shortage, an upward-acting wood rolling door is now being produced that offers many of the advantages of the steel rolling door formerly manufactured by the same company. The curtain proper is composed of wood slats shaped to permit easy articulation, and jointed together by means of metal tapes or cables. Coiling upon a barrel above the lintel, this door requires no floor or wall storage space. Depending upon the size of the door, and the owner's preference, its operation can be manual, by chain and reduction gearing, or by motor. The

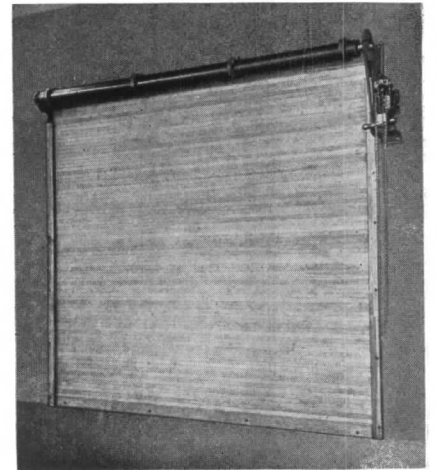

Figure 3

manufacturers report it to be in every detail a heavy-duty door providing a high degree of operating efficiency. (See Figure 3). The Kinnear Manufacturing Company, Columbus, Ohio.

ANOTHER COMPANY also is stressing the use of rolling wood doors in place of those of steel. Coiling overhead, these doors are made up of such woods as spruce, cypress, redwood, and cedar. All parts are immersed in wood preservative before assembly, or will be given a priming coat of lead and oil if preferred. Standard operation is through endless chain and gearing of suitable ratio to insure ease of operation. Crank or motor operation can be furnished if desired. Doors can be had in all sizes up to eighteen by twenty feet. J. G. Wilson Corporation, 370 Lexington Avenue, New York City.

(continued on page 76)

HERE'S THE "V" ANSWER TO YOUR LOCKER NEEDS  
**-NEW CURTIS VICTORY LOCKER**

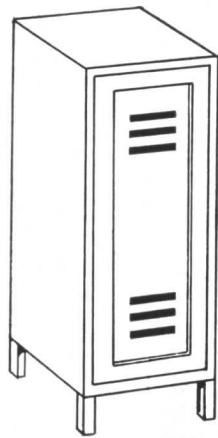

You need lockers today—lockers for factories, schools, military establishments, industrial and commercial buildings of all types. You need those lockers quickly—and with the complete assurance of quality and lasting satisfaction. And so Curtis offers their NEW Victory Locker, with all the quality, all the superior features you would expect in a Curtis product.

**Check These Advantages  
of the  
CURTIS VICTORY WOOD LOCKER:**

1. An all-purpose locker to fit every locker need.
2. Uses no critical materials—made of plywood panels dovetailed into Ponderosa Pine framework.
3. Standardized design and size—  
15" wide, 18" deep, 65" high, with legs.  
15" wide, 18" deep, 60" high, legs removed.
4. Shipped KD with complete installation instructions.
5. All parts pre-fit for quick, easy installation.
6. Low installation cost due to Curtis Lock-tite joint used to assemble batteries of lockers.
7. Each locker consists of paneled ends, back panel, front panel including door, bottom shelf, hat shelf, top, and divider partition.
8. Painted two coats—olive green.
9. Light—durable—strong.
10. Available as individual units or in batteries of any desired number.
11. Backed by 76 years of experience in woodworking and cabinetry—made by the makers of *Curtis Woodwork* and *Silentite Windows*.
12. Quick delivery, due to Curtis high speed mass production.

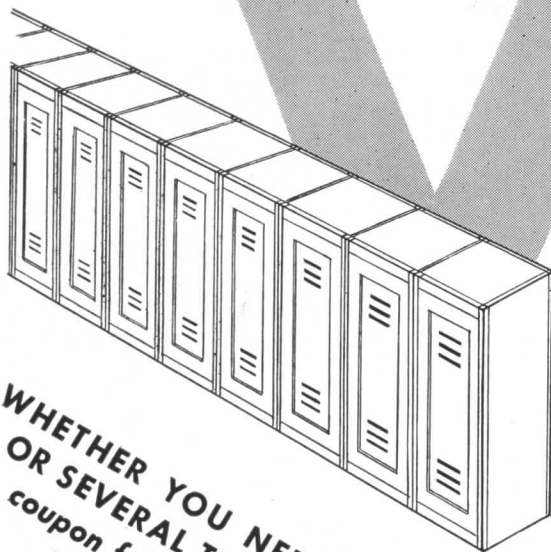

WHETHER YOU NEED ONE LOCKER  
OR SEVERAL THOUSAND, send the  
coupon for full information about  
the Curtis Victory Locker

1866  
**CURTIS**  
**WOODWORK**

MAKERS OF FINE WOODWORK FOR 76 YEARS  
SOLD BY LEADING LUMBER DEALERS EVERYWHERE

CURTIS COMPANIES SERVICE BUREAU  
Dept. AR-11L, Curtis Building, Clinton, Iowa  
Gentlemen: Please send me complete information about the  
new Curtis Wood Victory Locker.

Name.....

Address.....

City..... State.....

(continued from page 74)

## INTERIOR PARTITIONS

A NEW, completely packaged, demountable interior partition consists of glass blocks held in place by strips of wood painted or stained to match the surroundings. Walls of almost any size can be constructed: they can extend from floor to ceiling, or be waist or head high; they may reach from

wall to wall, or have one end free. Doors and windows can be inserted readily. The new wall need not be entirely of glass block construction but may be combined with existing solid or frame construction. After framing the opening, only three slim plywood members are required to erect the panel. These consist of horizontal and vertical separating strips for use be-

tween the blocks and wood wedges for holding sides and top of the partition firmly in position. Insulux Division, Owens-Illinois Glass Co., Toledo, Ohio.

## STRENGTHENING CONCRETE

A NEW product, making concrete more resistant to weather and abrasion in dams, fortifications and construction projects of all types, is an absorptive lining for forms in which concrete is poured. These linings consist of an absorptive material faced with a fabric, and are easily applied to the forms by stapling. After the concrete has been cast, the forms are removed and the fabric peeled from the concrete. (See Figure 4). United States Rubber Co., Rockefeller Center, New York City.

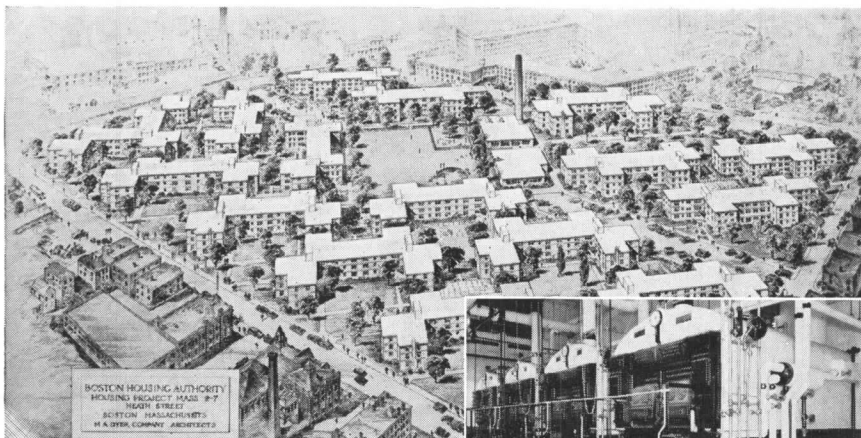

### Heating Heath Street Housing

How four No. 60 H. B. SMITH Boilers are heating the eighteen buildings of Boston's newest U. S. H. A. project.



18 buildings—420 apartments—a total E. D. R. load of 75,000 sq. ft. steam radiation... that is the size of the Heath Street Housing job, U. S. H. A.'s latest project in greater Boston.

Convinced by their past experience with H. B. SMITH BOILERS on large central plant installations, Stone-Underhill Company, the consulting engineers, approved 4-25 section No. 60 SMITH BOILERS for the job.

This boiler plant delivers steam at a pressure of 8 pounds through underground mains to the various buildings which are individually zoned. The heating load includes 60,000 sq. ft. of direct cast-iron radiation and a domestic hot water tank equivalent to 15,000 sq. ft. E. D. R.

Both tenants and management of the Heath Street Project will have reason to be thankful in winters to come for not only will this heating system provide comfort in the coldest of weather, but low fuel bills and negligible maintenance costs will be assured by the dependable operation of these four H. B. SMITH CAST-IRON BOILERS.

**SMITH HEADER TYPE BOILERS FOR ECONOMY—COST LESS TO OPERATE—COST LESS TO MAINTAIN**

More prime heating surface than any other boiler of equivalent size — ensures maximum heat absorption.  
 Independent Header Construction — each section an independent boiler. Possibility of mid-season breakdown minimized.  
 Vertical Water Tube Construction — for rapid water circulation — fast steaming.  
 Cast Iron Construction — for lowest maintenance costs... longest life.

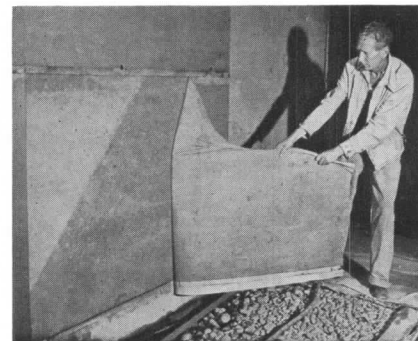

Figure 4

## PLASTIC SEATS

OFFERED in place of black hard rubber and rubber composition closet seats which by Government order no longer are manufactured, is a black plastic covered seat called the Onyx. The Onyx is constructed with a laminated hard wood core covered with a thick, molded, cellulose acetate plastic. The laminated core provides extra strength and prevents warping or cracking, it is said, and the plastic covering is moisture proof and acid resistant. The seat is easily cleaned with soap and water. The Onyx may be equipped with check hinges, spring hinges or self-sustaining hinges, according to Government specifications. It is available in four models including the Navy trough type. Brunswick-Balke-Collender Company, 623 South Wabash Avenue, Chicago.

(continued on page 78)

**THE H. B. SMITH CO., INC., WESTFIELD, MASS.**  
 BOSTON NEW YORK PHILADELPHIA



# HURRYING FOR UNCLE SAM?

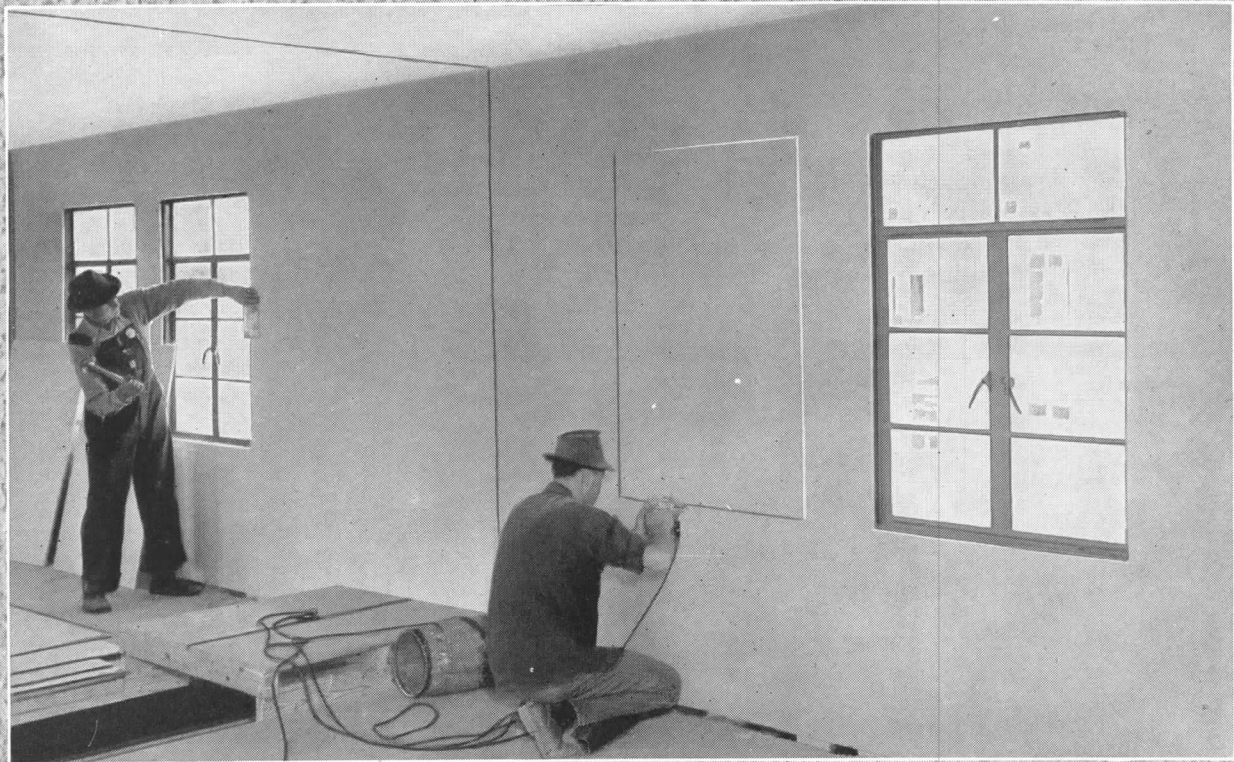

*Don't let outmoded methods of applying interior walls and ceilings bottleneck your schedule. Full wall construction with Upson Strong-Bilt Panels will save you two to three precious weeks of construction time—conserve critical materials and spread available manpower over a greater number of units.*

If you are building 100 units or more, *giant panels*—big enough to cover an entire wall—can be delivered, pre-cut to size and numbered for immediate application.

For smaller projects we have speed systems for handling and cutting at the site to save you time and money.

Field Supervisors, trained in the elimination of non-essential operations, and with “know-how” gained on scores of big projects, can be supplied. Phone, wire or write us. The Upson Company, Lockport, New York.

▶ **NO BOTTLENECKS:** 40 to 50 man-hours application time for average family unit. Ideally adapted for line assembly.

▶ **NO WATER:** No moisture. No drying out period. Dry-build any month of the year.

▶ **NO TAPING:** No cutting or filling of joints.

▶ **NO NAILS TO COUNTERSINK:** No filling of holes or spots to mar finished surface, when Upson Floating Fasteners are used.

▶ **NO REPEATED PAINTINGS:** Single coat usually sufficient for pre-sized panels. Painting begins immediately following application of trim.

▶ **CRACKPROOF:** Assures lasting beauty with low maintenance cost.

▶ **INSULATION VALUE:** Up to 3½ times that of plaster. High resistance to transmission of sound.

▶ **FHA ACCEPTED:** Liberal terms “streamlined” for the duration.

*Upson Quality Products Are Easily Identified by the Famous Blue-Center*

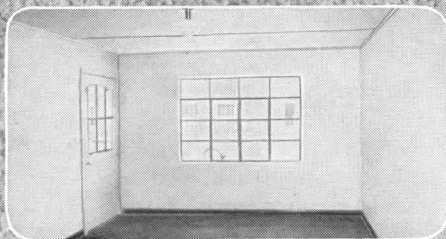

*Walls and ceilings of enduring beauty which remain forever free from ugly creeping cracks.*

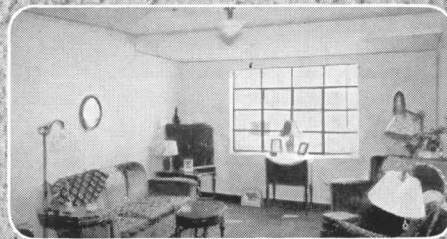

*Occupants invariably prefer the crisp, fresh beauty of walls and ceilings made with Upson Strong-Bilt Panels.*



**UPSON  
STRONG-BILT  
PANELS**

**THE BEAUTY SURFACE FOR WALLS  
AND CEILINGS**

(continued from page 76)

## DEHYDRATED PAINT

DEVOE and Reynolds Co., Inc., recently has perfected, and is now producing, a new type of paint called "Dehydray." Completely dehydrated, this new product weighs about half as much as liquid paint and bulks considerably less. It was developed in line with the Government's effort to cut

down on freight space to make more room for shipment of vital war materials. The manufacturers point out several important advantages:

1. Packed in cardboard cartons, it avoids priorities on cans and other containers, and cannot freeze.
2. Its excellent washability means easy cleaning of walls.
3. Usually only one coat is needed

to cover almost any kind of interior wall surface, including wallpaper, cement, wallboard, paint, brick, and plaster.

"Dehydray" is available in twelve standard colors, blended to harmonize with the newest fabrics and accessories. Devoe and Reynolds Co., Inc., 44th Street and First Avenue, New York City.

## HEAT CIRCULATOR

VERY MUCH in line with the wartime necessity of reducing fuel consumption is the new Reco Heat Circulator. Because hot air rises, the manufacturers of this device point out, in order to keep the temperature in the lower part of a room at 70° F, it is usually necessary to maintain a temperature of approximately 90° F at the ceiling. By forcing the hot air at the ceiling downwards, and creating a uniform temperature throughout the room, the Reco, it is claimed, substantially reduces fuel consumption, increases humidity in the lower part of the room, eliminates cold floors, and makes hard-to-heat rooms more easily and quickly heated. Reynolds Electric Company, 2650 West Congress Street, Chicago.

## PLYWOOD BATHTUB

A PLYWOOD BATHTUB, five feet in length and of the recessed-type, has been developed as a wartime substitute for cast iron and steel tubs, and is being considered by the NHA for use in its program of temporary housing and dormitories for war workers. The new type of tub was given a thirty-day test by the Bureau of Standards to determine its serviceability, and is being tested also for the wearing qualities of its enamel coating. Although plywood is a critical material, it is pointed out, it is not so critical as cast iron and steel. M. & M. Ply Tub Company, Aberdeen, Washington.

## SWINGING GRILLE

DEVICE for barricading doorways without obstructing air, light or vision is a new swinging type grille assembled in a steel frame and equipped with steel-encased cylinder lock. Kinnear Mfg. Company, Columbus, Ohio.

**17,000 ARCHITECTS & ENGINEERS SENT FOR THIS FREE BOOK**

*.. Have You?*

If not, you still can get your copy of *Typical Designs of Timber Structures* by writing us on your professional letterhead.

Plans of 45 representative types of timber structures are included. You will be interested in the wide range of structural possibilities featured, as created under the TECO System of timber construction; also in TECO's savings of time, materials, and money.

Write us now . . . before the present supply is distributed.

The TECO Ring Connector spreads the load on a timber joint over practically the entire cross-section of the wood.

**TYPICAL DESIGNS of TIMBER STRUCTURES**

A Reference for Use of Architects and Engineers

Timber Engineering Company  
1227 Commercial Ave., N. W.  
Washington, D. C.

Book No. 374

**Timber ENGINEERING COMPANY**  
WASHINGTON, D. C. PORTLAND, OREGON



## START PLANNING NOW FOR SLOAN-EQUIPPED HOMES



FOR 36 years Sloan engineering has made and kept Sloan Flush Valves the world's standard of excellence. You will find them today in luxury homes, apartments, clubs, hotels, hospitals, schools, and all types of large buildings everywhere. During all these years Sloan Flush Valves have protected health by preventing back-syphonage. They have saved both water and the power cost necessary to pump it. They have always been amazingly low in maintenance cost.

Now, thanks to Sloan engineers, we are able to make this promise:—*after the war Sloan Flush Valves, with all their inherent advantages, will be available to even the modest homes.*

Sloan-equipped homes are the ultimate in convenience, health and economy. Start planning now for Sloan-equipped residences. Remember: there are more Sloan Flush Valves sold than all other makes combined.

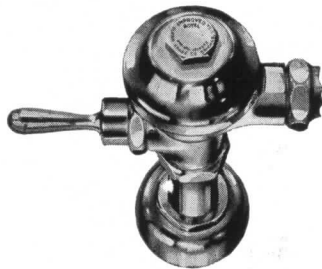

### SLOAN VALVE COMPANY

4300 WEST LAKE STREET • CHICAGO



# REQUIRED READING

(continued from page 20)

materials, etc., and there are numerous photographs and diagrams. Some of the definitions seem unduly scanty; a cross reference such as "Plumbago, see black lead," "Black Lead, see plumbago" is no help; in the index to a supplement consisting mainly of charts and tables "table for" and "chart showing" are useless words, especially in those few cases where

there is no entry to the subject of the table or chart; likewise "information regarding," "method of" and "properties of" serve little better, even though the subject *is* entered; while inclusion of Webster's Collegiate Dictionary among the thirteen most important reference books used is reassuring, perhaps, but only in a negative way.

**FIRST AID FOR THE AILING HOUSE.** By Roger B. Whitman. 3rd ed. New York, Whittelsey House (330 West 42nd Street) 1942. 359 pp., 5½ by 8¼ in., illus. \$2.50.

**TINKERING WITH TOOLS.** By Henry H. Saylor. New revised edition. New York, Grosset and Dunlap (1107 Broadway) 1942. 260 pp., 5½ by 8¼ in., illus. \$1.00.

To CLIENTS seeking advice on repairs or overhauling of houses beginning to feel their age, architects may recommend the best local contractor and these two books.

Mr. Whitman's third is to his second roughly what his second was to his first, except that the relative domestication of the engineer shown in the second edition is corrected in this one by the emphasis on materials, and especially on substitutes for those unavailable for gutters and flashings, and on how to extend the life of plumbing and heating systems, albeit without cutting down the useful sections on repairing damage by bat, squirrel, mole, mouse, weeds, and tree stumps.

Mr. Saylor, a practicing architect, associate editor or editor in chief successively of five or six architectural journals and of two top-ranking home journals, and contributor to many others, has now joined the best-seller class with his slightly revised edition of "Tinkering with Tools," a little masterwork of practical information strongly flavored with the idea that home repairs and fixing things are stimulating and satisfying in themselves as well as immediately useful.

## PERIODICAL LITERATURE

### EPIDEMIOLOGIC IMPLICATIONS OF WARTIME POPULATION SHIFTS.

By Kenneth F. Maxcy. American Journal of Public Health, New York (1790 Broadway), Oct., 1942. pp. 1089 to 1096.

CONCERNED less with meager reports of the pestilential diseases in devastated and impoverished countries than with dangers of infectious diseases in the U.S.A. as a result of war migration of workers and their families into boom towns. The housing shortage, "changing immunity status," mixing of transient and native populations have as yet shown no significant increase in infectious diseases reported,

(continued on page 82)

## FOR ARMY-NAVY PROJECTS and War Industries

At this time The Herman Nelson Corporation is busy furnishing Heating, Ventilating and Air Conditioning Equipment for use everywhere in connection with work vital to our National War Effort. However, The Herman Nelson Corporation is maintaining Sales and Service Offices in all Principal Cities in order to help facilitate war work. Each office is equipped to quote and aid in working out details for your war project.

### HERMAN NELSON **hijet** HEATERS

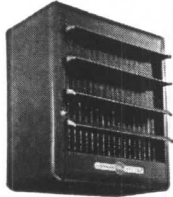

**Horizontal Shaft Propeller-Fan Type hijet Heater** projects warm air downward in the desired direction. Eliminates waste fuel and space. Available in 48 models, sizes and arrangements.

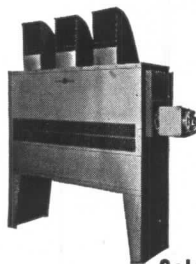

**Herman Nelson Blower-Fan Type hijet Heater** provides efficient heating of large areas. Streamline discharge outlets maintain large air delivery with high velocity. For floor, wall, ceiling, or inverted wall mounting. Available in 150 models, sizes and arrangements with a wide range of capacities.

### AUTOVENT FANS AND BLOWERS

**Autovent Propeller Fan** Exclusive Autovent design—direct or belt driven. Ruggedly constructed for economical operation under severe conditions. Available in wheel diameters from 9 to 72 inches; capacities 450 to 45,000 cfm.



**Autovent Blower** for heavy duty ventilating and air conditioning installations. This Blower can be furnished to any speed or discharge requirements, in a wide range of sizes.

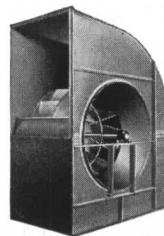

### Sales and Service Offices in Following Principal Cities

Albuquerque, N. Mex.  
Appleton, Wis.  
Atlanta, Ga.  
Baltimore, Md.  
Birmingham, Ala.  
Boston, Mass.  
Buffalo, N. Y.  
Charlotte, N. C.  
Chicago, Ill.  
Cincinnati, Ohio  
Cleveland, Ohio  
Columbus, Ohio  
Dallas, Texas  
Denver, Colo.  
El Paso, Texas  
Emporia, Kans.  
Fort Wayne, Ind.  
Grand Rapids, Mich.

Harrisburg, Pa.  
Houston, Texas  
Indianapolis, Ind.  
Jackson, Miss.  
Johnstown, Pa.  
Kansas City, Mo.  
Los Angeles, Calif.  
Louisville, Ky.  
Madison, Wis.  
Memphis, Tenn.  
Miami, Fla.  
Milwaukee, Wis.  
Minneapolis, Minn.  
Missoula, Mont.  
Moline, Ill.  
Nashville, Tenn.  
New Orleans, La.  
New York City, N. Y.  
Norfolk, Va.

Omaha, Neb.  
Philadelphia, Pa.  
Pittsburgh, Pa.  
Portland, Maine  
Richmond, Va.  
Saginaw, Mich.  
Salt Lake City, Utah  
San Antonio, Texas  
San Francisco, Calif.  
Scranton, Pa.  
Seattle, Wash.  
Spokane, Wash.  
St. Louis, Mo.  
Syracuse, N. Y.  
Tucson, Ariz.  
Tulsa, Okla.  
Washington, D. C.  
Watervliet, N. Y.  
Westfield, Mass.



**THE HERMAN NELSON CORPORATION**  
MOLINE, ILLINOIS

MANUFACTURERS OF QUALITY HEATING, VENTILATING AND AIR CONDITIONING PRODUCTS

# MEMO

Fred — please handle!

Westinghouse has prepared a new 28-page handbook that tells how to service fluorescent fixtures. Let's get a copy and see what we can do to maintain the efficiency of our own lighting.

Just send your name and address to Cleveland.



## FLUORESCENT



SERVICE AND MAINTENANCE  
H A N D B O O K

*by* WESTINGHOUSE

### READY NOW...WITH THE COMPLIMENTS OF WESTINGHOUSE

Westinghouse Electric & Mfg. Co.,  
Lighting Division, Department F,  
Edgewater Park, Cleveland, Ohio

Please send me a copy of the new Fluorescent Service  
and Maintenance Handbook — B-3155.

Name and Title \_\_\_\_\_

Company \_\_\_\_\_

Street and Number \_\_\_\_\_

City \_\_\_\_\_ State \_\_\_\_\_



# Westinghouse

## LIGHTING EQUIPMENT

# REQUIRED READING

(continued from page 80)

but the boom town communities should be watched carefully for new indications.

**REPORT ON SCOTT COMMITTEE.** By "Questor." Architect and Building News, London (2 Breems Building), Sept. 4, 1942, pp. 139, 140.

THE TASK set for the Scott Committee was to report on the development

of rural communities. Although well written and informative, the Scott report offers rather grandiose ideas for bringing utility services (gas, electricity, water) to rural regions. "Questor" regrets that it does not raise the issue of the preservation of natural beauty spots, and that it warns against the bringing into agricultural communities

of industries "even if not unsuitable," which might well work in with the seasonal nature of farming work.

**PROYECTO PARA LA EMBAJADA AMERICANA.** Arquitecto Pervano, Lima, Peru (Edeficio San Pedro), July, 1942, n.p.

NINE perspectives and a first floor plan of the projected U. S. Embassy for Lima from the Foreign Buildings Office of the U. S. State Department. Perspectives of the patio, the grand reception hall, and "el living," in particular, show a pleasant adaptation of ambassadorial space needs to the South American idiom.

**STOCKHOLMS PARKANLAGEN.** Das Werk, Zurich, Switzerland. May, 1942, pp. 103-114, illus.

WHILE summer travelers from Finland or Russia might judge Stockholm's sports areas to extend from sailing or bathing centers on the outermost skerries three hours east of the city dock to sixty miles west on Lake Maelar and beyond, the actual winter and summer spots areas in the immediate city vicinity extend over a paltry nine miles square; and on this great cloak the Berzelius Park with its music, sports, dance, plant and bird life is merely the jeweled clasp on which attention centers.

**THE MAN WITH THE BIG GENERAL NOTIONS.** By Robert Lax. New Yorker, New York (25 West 43rd Street), Oct. 10, 1942, p. 19.

"WHY GET brick when all you want is hardness? So he got a big rough stone . . . Why . . . cement when all I want is stickiness? . . . and on the top . . . molasses. Why a roof when all I want is shelter? So he . . . put a hat . . . umbrella . . . manhole cover . . . tree . . . turtle shell. . . Some man. Some house."

**A GREAT ARCHITECT.** R. A. Cram. The Churchman, New York (425 Fourth Avenue), Oct. 1, 1942, p. 5.

"WITHOUT a peer in the field of ecclesiastical architecture" and consistent in that he was "not only a thoroughgoing traditionalist in architecture; he was equally such in theology and in his political views."

## PAGE FENCE

*America's First Wire Fence - Since 1883*

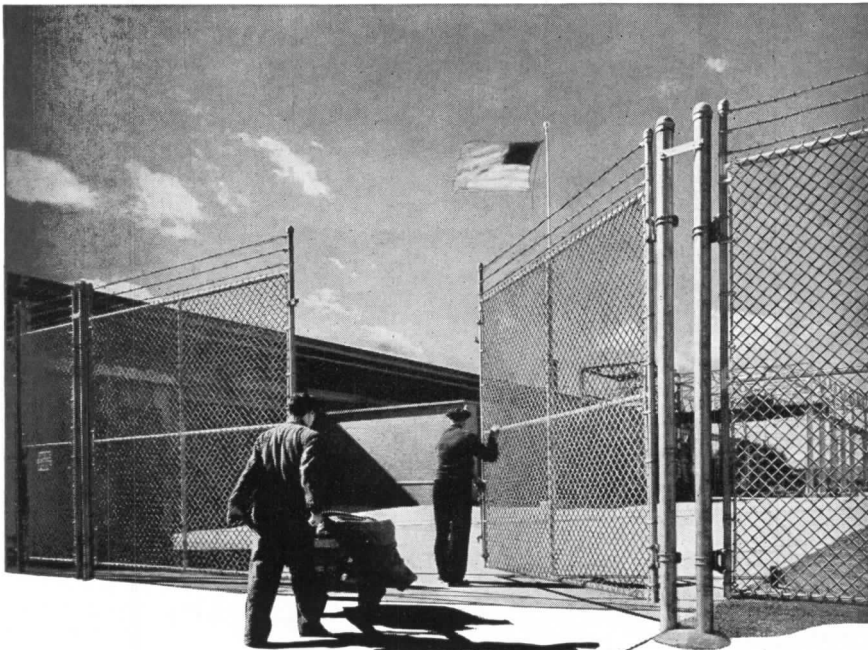

### GUARDIAN

**OF TOP-SPEED PRODUCTION  
TO DEFEAT ENEMIES OF LIBERTY!**

● Production time is now more precious than ever before. Plants must be protected against dangerous delays caused by hostile trespassers. ● Safeguarding industrial property has been a major function of sturdy Page Fence since J. Wallace Page originated woven wire fence in 1883, and founded the company which has been a leader in important fence developments. Safeguarding the fence investment through localized, responsible engineering and erecting service is also a Page achievement. More than 100 factory-trained, long-experienced local firms which own their own plants, make up the **PAGE FENCE ASSOCIATION**, Headquarters: Monessen, Penn.

**VICTORY FIRST**  
At the Page mills, men, machines and materials are on an all-out schedule for production of fence to protect plants working on Government orders

PRODUCT OF PAGE STEEL & WIRE DIVISION—AMERICAN CHAIN & CABLE COMPANY, INC., BRIDGEPORT, CONN.





ONE HUNDRED PER CENT  
SMALL PARTS PRODUCTION  
FOR



**VICTORY**

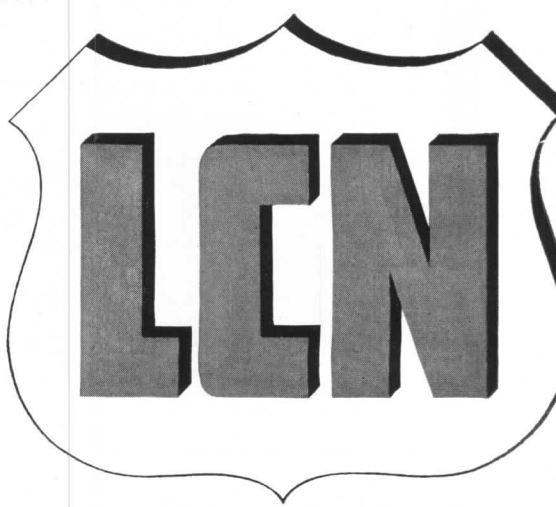

**DOOR CLOSERS**

# THE RECORD REPORTS

(continued from page 14)

WHO + WHAT + WHEN  
WHERE + WHY + HOW

and new, will come almost as a shock. Richness and variety are combined in the baroque of the XVIII century and, in the modern buildings, the purity and taste which we have usually thought belonged to ourselves alone, the exhibition will show exists in other parts of the Americas, sometimes to a superior degree.

## CAMOUFLAGE RESEARCH CENTER

The College of Engineering of New York University proposes to establish a Research Center for the study of protective concealment or camouflage of industrial structures. A Camouflage Laboratory will be provided with the most modern apparatus for

study of materials, methods and techniques, and the various University laboratories will be used for the testing of materials. The Camouflage Research Center is being set up as a cooperative project in which the large manufacturers of materials suitable for camouflage use are being invited to participate.

## TODAY - Specify

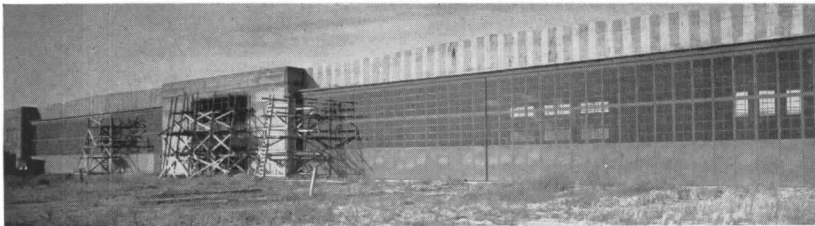

### Tomorrow's Hangar Door

Now—today—you are designing hangars that will be in use long after the present emergency is over. So why not specify hangar doors that will be NEW tomorrow—as well as today.

Horn Accordion Folding Doors meet today's needs with tomorrow's efficiency. Pictured above is a steel\* and glass installation—two 150 foot doors which open automatically to a full width opening.

Most of the doors we're building now, however, are the NEW Horn All-Wood Construction—the door that saves 70,000 pounds of steel for every 120 x 28 foot opening.

Can't we tell you more about it? Call your Horn representative (listed in Sweet's) or write direct.

*\*Steel takes Uncle Sam's "O.K."*

# HORN

## MANUFACTURING COMPANY

DEPT. A-112

FT. DODGE, IOWA

World's Largest Manufacturers of Automatic Folding Doors and Partitions

## CAMOUFLAGE COURSES

The third in a series of evening courses in Industrial Camouflage, given under the auspices of the U. S. Office of Civilian Defense, will begin at Pratt Institute, Brooklyn, New York, on November 2, the Department of Architecture of the Pratt Art School has announced.

Open to architects, engineers, landscape architects, industrial designers and other persons professionally qualified, the course will consist of three lectures per week for a period of five weeks, and will cover basic principles of protective concealment for manufacturing plants and public utilities.

## RALPH ADAMS CRAM 1863-1942

With the passing of Ralph Adams Cram, America lost its leading proponent and protagonist of Gothic architecture. He thought, designed, built and lived in the Gothic spirit.

The firm of Cram, Goodhue and Ferguson was, at the time of its greatest activity, probably the best-known designer of Gothic churches in the country. Among innumerable buildings attributable to Mr. Cram or his firm are the Princeton chapel and buildings of the Graduate School, the buildings at West Point and the redesigned Cathedral of St. John the Divine in New York.

He was a prolific philosophical writer and an enthusiastic speaker, Active in civic and church work and the recipient of many honorary degrees from colleges and universities.

He was a member of the National Institute of Arts and Letters, a fellow of the American Academy of Arts and Sciences, the American Institute of Architects, the North British Academy of Art and the Royal Geographical Society, as well as a former president of the Boston Society of Architects.

500 DINE WHERE THE  
"WEATHER'S FINE"

*Novel "windowless" lunch room helps  
keep employees up to par at Chicago  
Bridge & Iron Company*

IF highly economical tanks for liquids and gases can be built from curved tension sheets, then it ought to be practical to construct a building from curved compression sheets. At least that was the reasoning of officials of Chicago Bridge and Iron Company. And when one of their plants needed a new lunch room for its office staff they decided to put the theory to the test.

The result is the unique, windowless, air conditioned building shown here. The lunch room proper occupies the central portion, a dome 80 feet in diameter and 28½ feet high at the center. A concentric bulge around the edge of the dining area, measuring 14 feet in width,

houses the kitchen, lavatories, storage space and mechanical equipment.

Cooling in summer is provided by direct expansion evaporators, and a 40-ton "Freon"-charged refrigerating system. This equipment and the entire air conditioning system were given a rigid trial right at the outset when 500 guests were entertained at the opening luncheon. Ventilation, temperature, and humidity were found to be ideal. Now, day in and day out, the lunch room and its air conditioning equipment provide attractive, comfortable surroundings for employees during meal hours and are making a real contribution to raising the efficiency and morale of those who dine there.

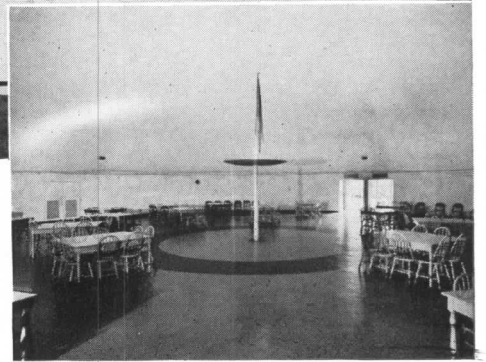

As in all buildings of the windowless type, omission of windows reduced the initial investment and will mean lower maintenance costs. Furthermore, absence of windows decreases heating and cooling costs and makes possible better control of temperature and humidity in both winter and summer.

Architect Winston Elting is responsible for the architectural design and Clifford Orr, of the owner's organization, was in charge of detailed steel design and fabrication. Mechanical equipment was designed by Roy W. Shields of the staff of Samuel R. Lewis, consulting mechanical engineer, and Advance Heating and Air Conditioning Corporation was the installing contractor.

**FACTS ABOUT "FREON"**

"Freon" refrigerants are used in this building, as they have been used almost exclusively for new air conditioning installations in recent years. Because of "Freon's" unique proper-

ties, its use avoids any possibility of penalty to your client in insurance rates, and promotes safety of life and property. Kinetic Chemicals, Inc., Tenth & Market Sts., Wilmington, Del.



**FREON**  
REG. U. S. PAT. OFF.

*safe refrigerants*

*"Freon" is Kinetic's registered trade mark for its fluorine refrigerants*



# Lasting Maple Makes Lasting Friends



For this completely remodeled job, Hove's progressive Minneapolis grocery wisely chose Northern Hard Maple floors—for beauty, comfort, low up-keep. —Larson and McLaren, Architects.

An owner's solid satisfaction, after you furnish a Hard Maple floor for him, paves the way for you to land the bigger jobs that are bound to follow the war. He can't forget the bright, clean beauty of Maple—its resistance to hard wear and its low maintenance cost—or the good judgment that prompted you to suggest it.

Those flooring qualities—plus its smooth, warm comfort underfoot and ease of cleaning—make Northern Hard Maple the ideal floor for war projects, defense housing, factory rehabilitation, food plants, stores, schools, and homes.

For today's many repair, maintenance and remodeling jobs as well as new construction, sell MFMA Northern Hard Maple—for permanent satisfaction! MFMA trade-marked and guaranteed! In strips  $\frac{3}{8}$ " to  $\frac{53}{32}$ " thick, widths  $1\frac{1}{2}$ " to  $3\frac{1}{2}$ ", to suit perfectly every flooring requirement. Also a wide range of sizes in blocks. Write for Grading Rules booklet and photo-descriptive folder.

**MAPLE FLOORING MANUFACTURERS ASSOCIATION**  
1782 McCormick Building, Chicago, Illinois



## OUTLINES OF POSTWAR PATTERNS

(continued from page 46)

program can be started for redeveloping the city's rundown districts, winning back some of its taxpayers from the distant suburbs, rehabilitating its remaining property owners, the city's financial difficulties would soon disappear. It might be added that until such a process is set in operation, the large city will continue to struggle with make-shifts, always one jump ahead of the sheriff.

### 7. Public vs. Private Enterprise

Through any discussion of postwar building runs the thread of argument between private and government interests. For this quick summary of postwar problems that argument is quickly resolved. The job of planning and coordination is too big and too complicated to be solved by private interests working alone. And the work of execution is too big to be done by government. On any given detail of the job there is room for argument as to whose responsibility it might be. But there can be little doubt that the overall job will call for full cooperation of all government divisions and all private interests. Government can supply research and the legislative controls that might finally be considered essential, and it can stimulate and coordinate local efforts. But the job will never be done by the bureaucratic approach which seeks to supplant private initiative.

Such, in brief outline, is the task ahead. If it begins to sound a bit on the impossible side, well, so does winning the war. And we have already seen that the very word "impossible" is one of the war casualties. The war is being fought for the opportunity to tackle just such problems as here outlined, and to solve them in our own democratic way.

---

*If the objective of postwar economic adjustment is to be achieved, tremendous sums of private capital must be attracted to the task. In order not to seem to compete with private enterprise, we have heretofore limited the provision of public funds or subsidies for housing to accommodations for the lowest income group. The stimulus which we have sought to give private enterprise through governmentally guaranteed insurance of mortgages has not attracted capital to central large-scale rebuilding of cities; it has rather emphasized the centrifugal trend by promoting new subdivisions on what seemed the comparatively cheap land of the periphery (the private developer not having to count the full cost of the public services which his colony would entail to the municipality).*

*We must reshape our programs of Federal stimulation of home building, both public and private. First, so that public and private enterprise together may give us the desired community pattern. Secondly, so that, between them, they may provide proper homes for all income levels.*

—Charles S. Ascher

*Inventive genius, productive power, immense natural resources, and financial stability are so characteristic of the United States that only a defeatist would venture to suggest that we cannot build a postwar economy which will in time outlaw poverty by the elimination of unemployment, and create a nation destined to play a large part in the maintenance of peace in this world, with satisfactory living standards gained by the creation of opportunities to work, and not by forms of government charity.*

—Walter R. MacCormack

# 500 DIFFERENT SHAPES OF ARCHITECTURAL CONCRETE SLABS

## face buildings of U. S. Naval Medical Center

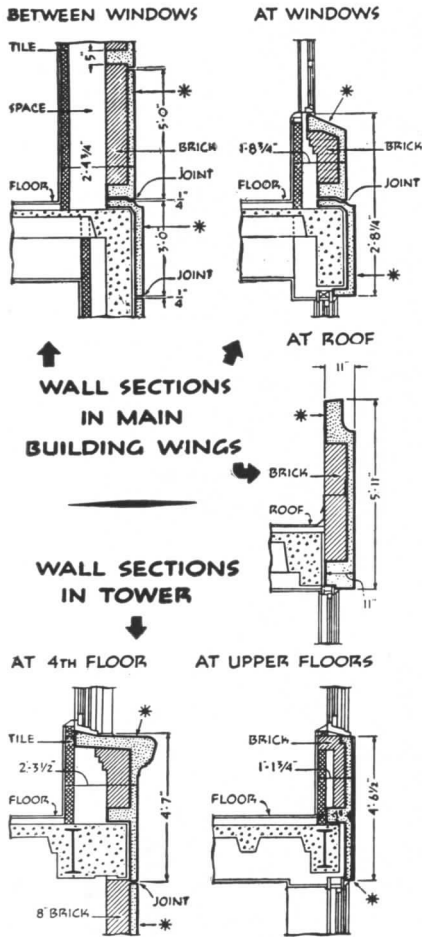

OVER 400,000 square feet of thin, pre-cast, exposed-aggregate, Architectural Concrete Slabs, 2 1/2" thick, provide exterior walls for the various buildings comprising the Navy's new medical center. The use of thin Slabs in some 500 different shapes shows the versatility and adaptability of this new material and the almost unlimited opportunity for architectural and structural design.

Architectural Concrete Slabs are "wrapped around" corners, window reveals, sills and parapet copings. Lugs are formed to anchor and interlock the slabs to the backup material, and to receive steel windows, door bucks and other materials. In multi-storied buildings, spandrels extending from and including window head below to sill above may be

made in one piece, thus reducing joints, flashing and danger of leakage. With thin, pre-cast, Architectural Concrete Slabs you get the dignity, character and permanence of large-scale units and control the size, shape, strength, color, pattern, and texture. In modernization, the thinness of precast Slabs provides unusual advantages.

For details of the Naval Medical Center job and other typical installations, write for the new book, "Architectural Concrete Slabs." **USE THE COUPON.** Universal Atlas Cement Company (United States Steel Corporation Subsidiary), Chrysler Bldg. N. Y. C.

**OFFICES:** New York, Chicago, Philadelphia, Boston, Albany, Pittsburgh, Cleveland, Minneapolis, Duluth, St. Louis, Kansas City, Des Moines, Birmingham, Waco.

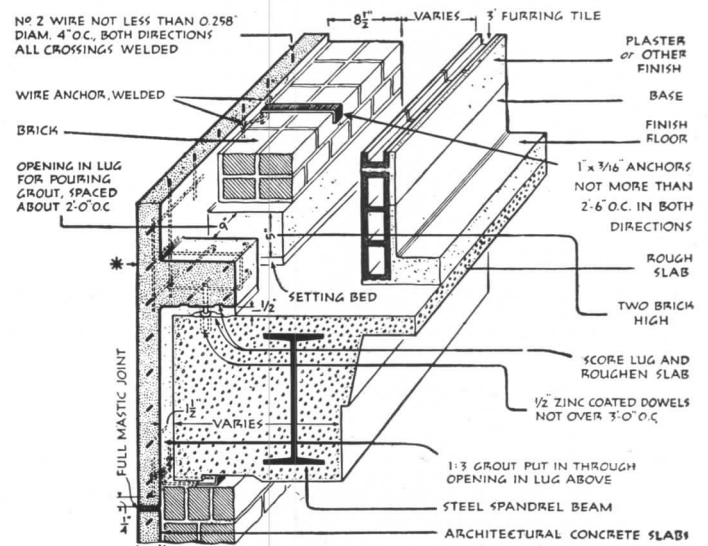

\* Indicates ARCHITECTURAL CONCRETE SLABS

● 20-story Administration Building is the central unit of the U. S. Naval Medical Center. This and all the service buildings are faced with Architectural Concrete Slabs. Consulting Architect, Paul P. Cret, Philadelphia; Contractor, John McShain, Inc., Philadelphia; Slabs by Federal Seaboard Terra Cotta Corporation, New York.

# ARCHITECTURAL CONCRETE SLABS

MADE WITH ATLAS WHITE CEMENT



Universal Atlas Cement Company  
Chrysler Bldg., New York City

Please send me a free copy of your new booklet showing uses, detailed drawings and typical installations of thin, pre-cast, "Architectural Concrete Slabs."

Name \_\_\_\_\_

Address \_\_\_\_\_

City \_\_\_\_\_ State \_\_\_\_\_



# Sunlight floods every part of submarine engine plant



**Far out of practical range** of enemy bombers, a new Midwestern plant for the construction of submarine diesel engines is now in full operation. Noteworthy in this 300,720-sq. ft. plant is the provision made for daytime workers to work in clear, natural light. Over 60 per cent of the entire outer surface of the building, including the roof, is glass. Abundant sunlight floods the interior, making every department "clear as day," and thus stepping up production efficiency.

**Clean, simple interior design** heightens the effect of brightness. All piping and wiring are close to columns. All conduits run underground. Crane runways are painted Chinese red; pipes are red and blue. Remainder of interior is painted dead white. The illustration at right shows a multiple flame-cutting operation in the new plant.

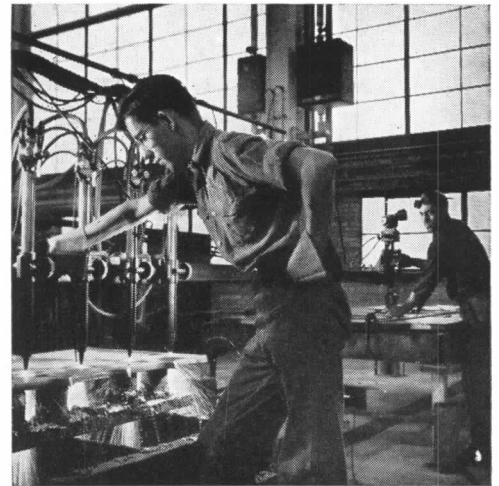

*Architect and Engineer: W. Fred Dolke  
Structural Engineers: Westcott Engineering Co.  
Mechanical and Electrical Engineer: Irving S. Brooke  
Contractors: Cunningham Bros.*

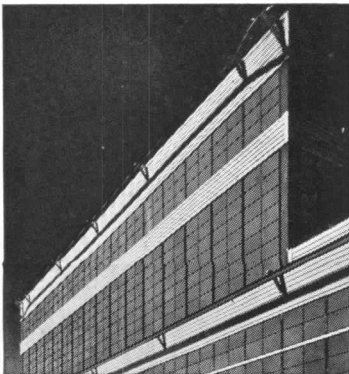

**Rails for outside window-washing equipment** are provided on every side of the plant. Another feature is a special test-block for the submarine engines, consisting of a platform of steel and concrete, 4 ft. below the floor. The steel rails on top of this platform had to be set dead level in the concrete.

Bethlehem Steel Company supplied the structural shapes, and bolts, nuts and rivets used in constructing this plant. The 4330 tons of structural steel were fabricated and erected by Bethlehem's Fabricated Steel Construction Division.

## BETHLEHEM STEEL COMPANY





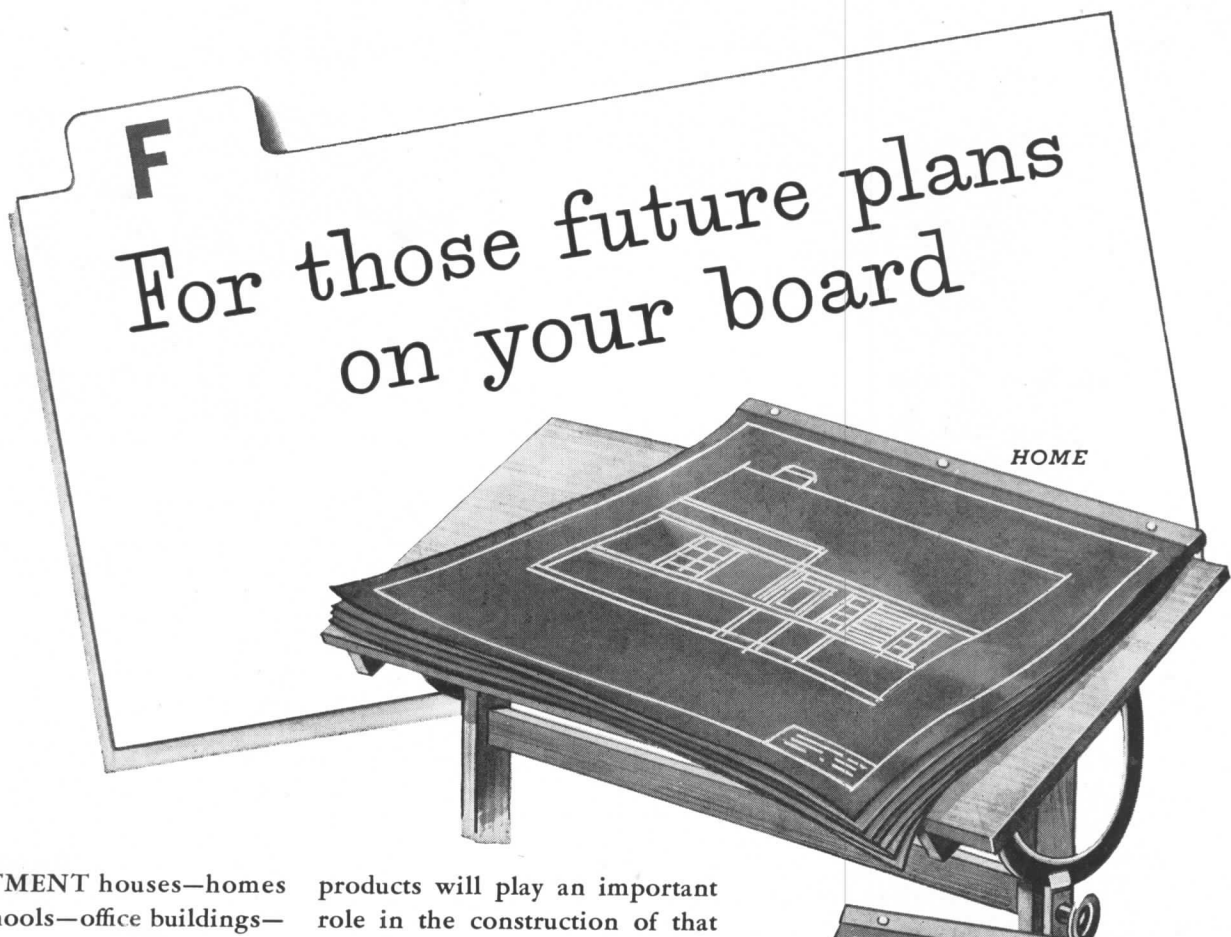

**F**  
For those future plans  
on your board

HOME

**A**PARTMENT houses—homes—schools—office buildings—much of this construction must wait. But architects are today busy with post-war planning and the future looks bright for building after the war is won.

And when these plans for the future become realities, Crane plumbing, heating and piping

products will play an important role in the construction of that period. For in the future, the name Crane will continue to identify, as it has in the past, the latest in design and the utmost in quality.

In your specifications for post-war construction, be sure that the name Crane appears where plumbing and heating is considered.

FACTORY

HOSPITAL

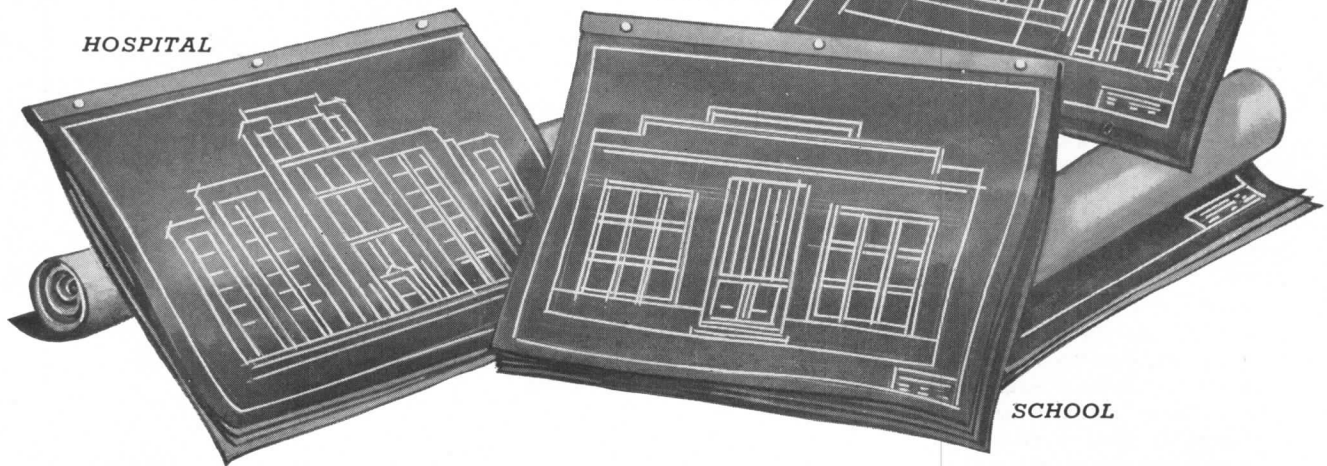

SCHOOL

# CRANE

CRANE CO., GENERAL OFFICES:  
836 S. MICHIGAN AVENUE, CHICAGO

PLUMBING • HEATING • PUMPS  
VALVES • FITTINGS • PIPE

NATION-WIDE SERVICE THROUGH BRANCHES, WHOLESALERS, PLUMBING AND HEATING CONTRACTORS

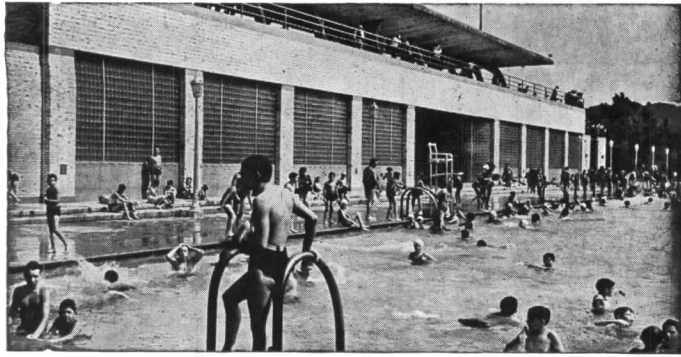

# W&T

nationwide  
organization services  
installations . . .

"Swim  
in  
Drinking  
Water"

IN these days of priorities it is reassuring to architects and engineers to know that the Wallace & Tiernan organization is available for servicing present installations, thereby keeping them at peak efficiency during this emergency period. Health is more important now than ever before, and chlorination in swimming pools insures the health of the swimmers. Hundreds of architects and engineers rely on the Wallace & Tiernan nationwide service organization to keep W & T equipment in top working condition. ASK FOR THE W & T SWIMMING POOL TECHNICAL PUBLICATIONS REVIEWING WATER TREATMENT ON SEVERAL DIFFERENT TYPES OF POOLS.

**WALLACE & TIERNAN, CO., INC.**

Manufacturers of Chlorine and Ammonia Control Apparatus  
**NEWARK, NEW JERSEY**  
REPRESENTED IN PRINCIPAL CITIES



# BURT MONOVENT

Continuous Ridge  
VENTILATOR

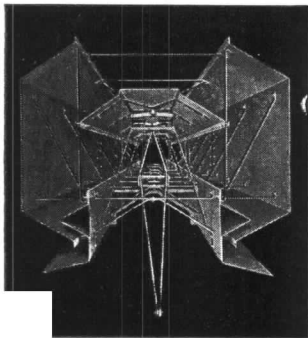

Particularly Fitted  
for  
War Production  
Plants

The proved efficiency,  
ease of installing, and  
trouble-free operation of  
Monovent make it a preferred ventilator for steel

mills and other production plants, warehouses, commercial buildings. Efficiency equals that of gravity ventilators, costs less. Installed on the ridge or apex of the roof, it harmonizes with the lines of the building. Takes fullest advantage of wind action. No mechanical parts to get out of order. Easy to install on any type or pitch of roof.

**THE BURT MFG. CO.**  
ROOF VENTILATORS • OIL FILTERS  
EXHAUST HEADS

177 MAIN ST., AKRON, OHIO

SEND  
FOR CATALOGS  
Burt Engineers  
are glad to  
help on plans

# Protection First



DOUBLE-WHITE house with Gloss Collopakes on blinds.  
Architect: E. L. Baker, Lima, Ohio.

More protection per gallon—that's what you get with Cabot's DOUBLE-WHITE and Gloss Collopakes, the colloidal paints made by our patented Colloppaking process which results in greater hiding power and longer life.

FREE—The White Book. Write today for color card and your copy of The White Book, Samuel Cabot, Inc., 1288 Oliver Building, Boston, Massachusetts.

## Cabot's DOUBLE-WHITE

and GLOSS COLLOPAKES  
(The Colloidal Paints)

### STATEMENT OF THE OWNERSHIP, MANAGEMENT, CIRCULATION, ETC., REQUIRED BY THE ACTS OF CONGRESS OF AUGUST 24, 1912, AND MARCH 3, 1933

Of ARCHITECTURAL RECORD, combined with American Architect and Architecture, published monthly at East Stroudsburg, Pa., for November 9, 1942. State of New York } ss. County of New York }

Before me, a Notary Public in and for the State and county aforesaid, personally appeared H. Judd Payne, who, having been duly sworn according to law, deposes and says that he is the Vice President & Genl. Mgr. of the ARCHITECTURAL RECORD combined with American Architect and Architecture and that the following is, to the best of his knowledge and belief, a true statement of the ownership, management, etc., of the aforesaid publication for the date shown in the above caption, required by the Act of August 24, 1912, as amended by the Act of March 3, 1933, embodied in section 537, Postal Laws and Regulations, printed on the reverse of this form, to wit:

1. That the names and addresses of the publisher, editor, managing editor, and business managers are:  
Publisher, F. W. Dodge Corporation, 119 West 40th Street, New York, N. Y.; Editor, Kenneth K. Stowell, 119 West 40th Street, New York, N. Y.; Managing Editor, None; Business Managers, None.

2. That the owner is: (If owned by a corporation, its name and address must be stated and also immediately thereunder the names and addresses of stockholders owning or holding one per cent or more of total amount of stock. If not owned by a corporation, the names and addresses of the individual owners must be given. If owned by a firm, company, or other unincorporated concern, its name and address, as well as those of each individual member, must be given.)

F. W. Dodge Corporation, 119 West 40th Street, New York, N. Y., whose stockholders, owning 1% or more of the total amount of its stock are: Paul Abbott, 1 Wall Street, New York, N. Y.; Dana T. Ackerly, 15 Broad Street, New York, N. Y.; May Gibson Baker, care of Mrs. L. G. Collins, Apt. 5J, 78-12 35th Avenue, Jackson Heights, Long Island, N. Y.; Howard J. Barringer, Box 736, Brightwaters, New York; James McV. Breed, 15 Broad Street, New York, N. Y.; Jane Curtis Breed, 550 Park Avenue, New York, N. Y.; William C. Breed, 15 Broad Street, New York, N. Y.; Mary F. Broadwell, 423 West 120th Street, New York, N. Y.; Eddy and Company, P. O. Box 706, Church St. Annex, New York, N. Y.; Sumner Ford, 15 Broad Street, New York, N. Y.; Sumner Ford & Underwriters Trust Co., Trustees, 111 John Street, New York, N. Y.; Irving W. Hadsell, 119 West 40th Street, New York, N. Y.; Thomas S. Holden, 119 West 40th Street, New York, N. Y.; Laura Morgan Jackson, R. F. D. 1, Ridgefield, Conn.; Frances M. McIntosh, 194 Brewster Road, Scarsdale, N. Y.; Helen D. Morgan, 563 Park Avenue, New York, N. Y.; Laura O. Morgan, 1011 Bluff Road, Glencoe, Ill.; T. Oliver Morgan, 1011 Bluff Road, Glencoe, Ill.; T. Oliver Morgan, Trustee, 700 Merchandise Mart, Chicago, Ill.; Cordelia Dana Nash, 1165 Fifth Avenue, New York, N. Y.; Mimie C. Ort, Port Murray, R. D., New Jersey; George H. Partridge, 9 Towers East, Bronxville, N. Y.; Jane A. Pratt, care of Manufacturers Trust Co., 707 Fifth Ave., Cor. 55th St., New York, N. Y.; William J. Quinn, 15 Broad Street, New York, N. Y.; Marcus Wayne, 2489 Overlook Road, Cleveland Heights, Ohio; Chauncey L. Williams, 119 West 40th Street, New York, N. Y.; George A. Wilson, Trustee, 15 Broad Street, New York, N. Y.; Helen Morgan Young, 2 Primrose Street, Colonial Heights, Tuckahoe, New York.

3. That the known bondholders, mortgagees, and other security holders owning or holding 1 per cent or more of total amount of bonds, mortgages, or other securities are: (If there are none, so state.) None.

4. That the two paragraphs next above, giving the names of the owners, stockholders, and security holders, if any, contain not only the list of stockholders and security holders as they appear upon the books of the company but also, in cases where the stockholder or security holder appears upon the books of the company as trustee or in any other fiduciary relation, the name of the person or corporation for whom such trustee is acting, is given; also that the said two paragraphs contain statements embracing affiant's full knowledge and belief as to the circumstances and conditions under which stockholders and security holders who do not appear upon the books of the company as trustees, hold stock and securities in a capacity other than that of a bona fide owner; and this affiant has no reason to believe that any other person, association, or corporation has any interest direct or indirect in the said stock, bonds, or other securities than as so stated by him.

H. JUDD PAYNE, Genl. Mgr.  
Sworn to and subscribed before me this 9th day of November, 1942.  
(Seal) IDA A. PETERSON,  
Notary Public, Westchester County, N. Y. County Clerk No. 501. Commission expires March 30, 1943.

You can count on

*"Pittsburgh" Glass!*



**PENNVERNON WINDOW GLASS**

This quality window glass is being widely used today for glazing homes, both multiple and single unit dwellings. It is also a favorite for war-factory glazing. Pennvernon is famous for its looks, its flatness, and the good vision it affords.

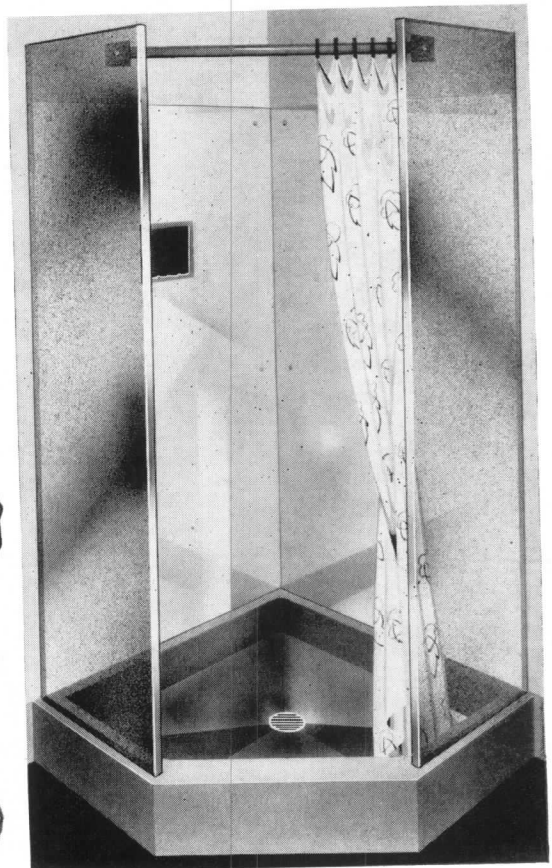

**CARRARA STRUCTURAL GLASS**

In designing Victory homes, new, prefabricated shower enclosures of Tempered Carrara Glass save time, space, money and metal. Shipped to the job in one package, ready for immediate assembly. Several styles available for various plumbing layouts. Eight colors.



**PITTCO STORE FRONT PRODUCTS**

First in their field for years, these products can be depended upon by the architect to execute his ideas faithfully and effectively. They provide him with wide possibilities for striking design. Research and development work will make Pittco Products even more useful after the war.

THE "Pittsburgh" Products mentioned here represent but a few of those which are ready to serve the architect in both war-time and peacetime work. Complete information on any Pittsburgh Product will be sent you upon request. And we urge you to call upon us if there is any problem concerned with glass which we can help you solve. Pittsburgh Plate Glass Company, 2130-2 Grant Building, Pittsburgh, Pa.

**"PITTSBURGH"**

*stands for Quality Glass and Paint*

**PITTSBURGH PLATE GLASS COMPANY**





REG. U. S. PAT. OFF.

## Samson Spot Sash Cord

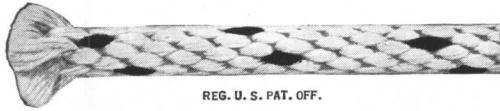

REG. U. S. PAT. OFF.

By specifying and using Samson Spot Cord for hanging windows, with suitable weights and pulleys, you obtain perfect balance by a time-tested method. You also guard against the use of inferior unidentified cord.

Samson Cordage Works, Boston, Mass.

\*\*\*\*\*  
 ★ When you buy War Stamps and ★  
 ★ War Bonds, you do two good things ★  
 ★ at the same time — you save for ★  
 ★ a rainy day, and you help ★  
 ★ to win the war. ★  
 \*\*\*\*\*

# for Office or Plant ... IN INDUSTRY

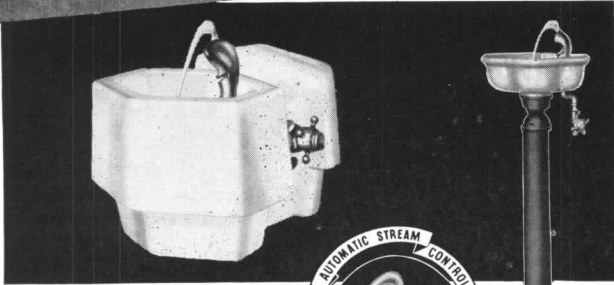

# For Sanitation IN SCHOOLS

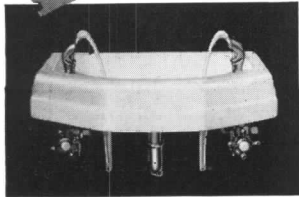

Architects, today faced with the problem of specifying drinking fountains and coolers for fast expanding industrial plants, can make no happier choice than Halsey Taylor Drinking Fountains.

For school repairs and replacements, Halsey Taylor is also the accepted and approved fountain for health-protection. Sanitary features make them the leading contamination-proof fountains on the market.

THE HALSEY W. TAYLOR CO., INC., WARREN, OHIO

## Halsey Taylor

### DRINKING FOUNTAINS

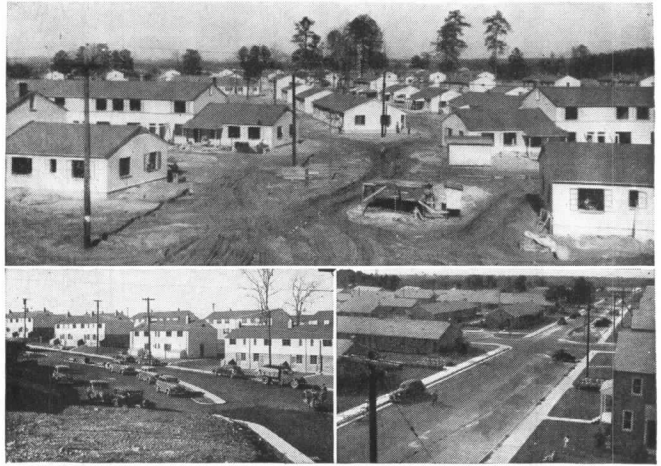

## BUILDINGS to house War Workers

The workers who move to busy war plant areas must be properly housed, if health and morale are to be preserved. In most localities, new construction is the only answer. The hundreds of thousands of these homes take a vast amount of Stanley Hardware for doors, windows, cabinets, garages.

Because manufacture of hardware has been restricted to release metals for vital war needs, and because existing stocks are of necessity earmarked for defense housing and other government approved projects, the supply available for normal needs is severely limited. The **STANLEY** Stanley Works, New Britain, Connecticut. Trade Mark

# STANLEY HARDWARE

## Ric-wiL INSULATED PIPE UNITS — PRE-FABRICATED



### — for top SPEED on the Job!

Ric-wiL Underground Piping Systems cut installation time to the bone! In Ric-wiL's large modern plant at Barberton, Ohio, are unique facilities for the streamlined production of unit piping systems for underground or outside overhead steam, hot water or oil lines. These units (in approximately 20 foot lengths) are totally factory pre-fabricated and delivered to the job ready for quick and economical installation. Note in cut above how every construction detail is engineered and built-in. Also, all necessary accessories—expansion loops, conduit fittings, anchors, water-tight glands, etc.—are factory pre-built to your specifications and shipped ready to install, saving not only field labor and expense, but valuable time, which is not lost in waiting for missing parts. Send for Bulletin 4208.

Engineers on Defense Projects ONLY! Write on your letterhead for Engineering Manual 420A.

# Ric-wiL CONDUIT SYSTEMS

THE RIC-WIL CO., CLEVELAND  
Agents in Principal Cities

# Concrete saves steel, transportation, time

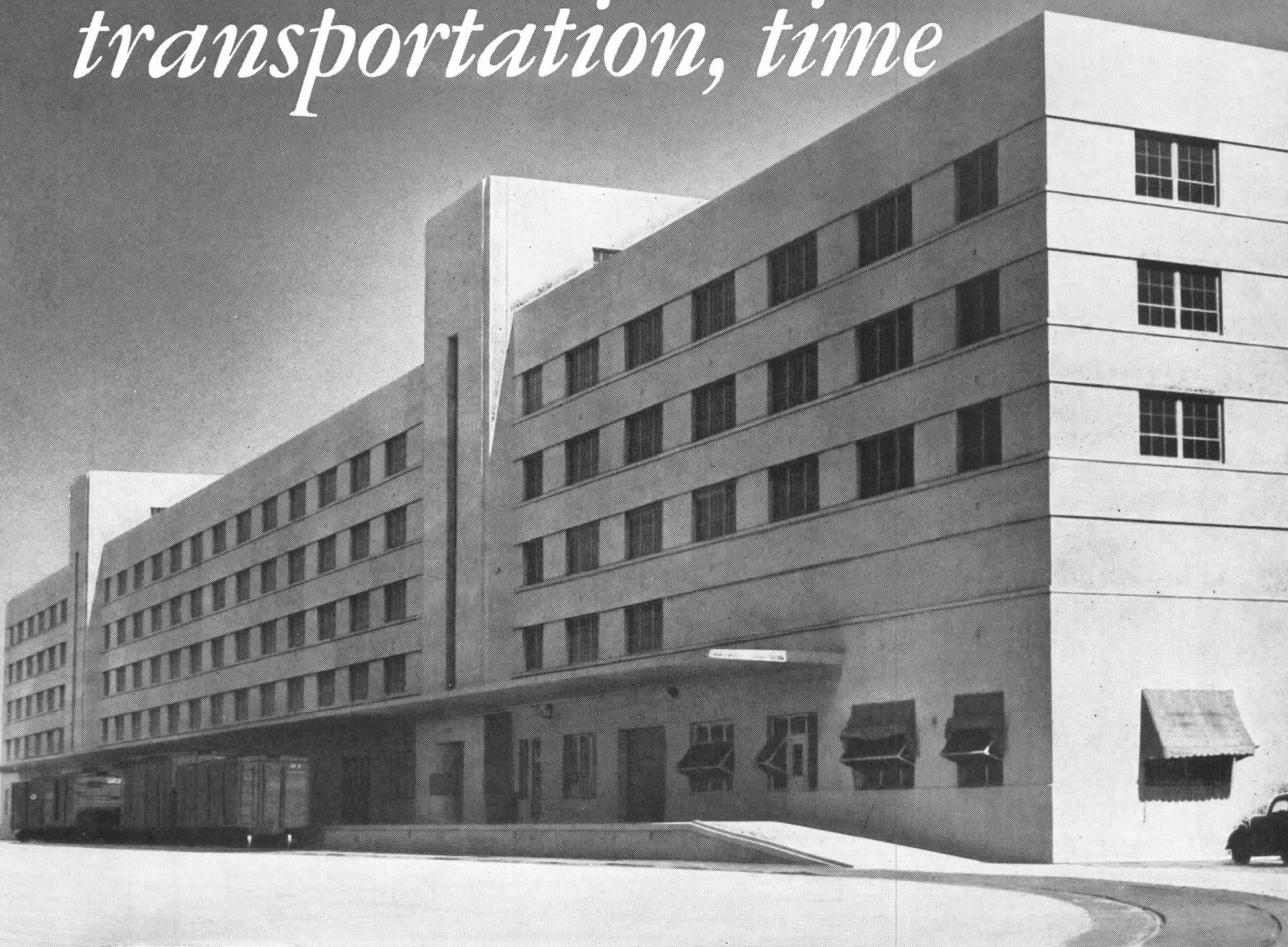

Warehouse for large eastern naval air station. Designed by Bureau of Yards and Docks, Washington, D. C. Virginia Engineering Company, contractor.

The peace-time developments that brought concrete from a purely structural to a highly regarded architectural material, are helping to build rugged, hazard-resistant war buildings with a minimum of steel and transportation. The bulk of concrete material is usually found locally. Simple construction methods and local labor speed the job.

To help get the maximum service which Architectural Concrete can render, the Portland Cement Association's technical staff is available to assist designers and builders of major war structures. Do not hesitate to call on us. See Sweets 4/45.

●  
**PORTLAND CEMENT ASSOCIATION**  
Dept. 11-8, 33 W. Grand Ave., Chicago, Ill.

★ BUY WAR SAVINGS STAMPS AND BONDS ★



# You can be sixteen again ... tonight!



Mr. and Mrs., shed those cares of office and home. Drive to a nearby hotel for a leisurely dinner. Dance again. Stay overnight. Let us send up your breakfast. Enjoy having others wait upon you for once. Sounds a little crazy—but it isn't. It's an idea worth trying if you have a spark of adventure smoldering within you. Be sixteen tonight! What do you say?

**AMERICAN HOTEL ASSOCIATION**



**EVERY DAY IS FATHER'S DAY—**Traveling doesn't tire when you stop at a hotel. Hotel conveniences add hours to leisure time, give you a chance to rest and relax in comfort.



**STOP TO SHOP—**Some day, Mother, when you have a lot of shopping to do, stop at a hotel. Break up your shopping hours, rest your feet between times. Dine at the hotel.



**HAIL TO THE CHIEF—**Little dinners or big ones—for the boss, an honored guest or friend—"go off" much better in the atmosphere and service of a hotel. Hotels give food a lift.



The Sign of a  
Recognized Hotel

for a fresh **START**  
**STOP** at a **HOTEL**

## A Short Cut to Your **CONSTRUCTION COST PROBLEMS**

### FOR PRELIMINARY ESTIMATES

Boeckh's Manual contains cubic and square foot costs on approximately 500 types of buildings with a total of over 7,000 specific base cost figures and, in addition, thousands of specific cost variations.

All costs are keyed to local construction cost conditions through exclusive index conversion formulas—Boeckh's Manual never gets out of date if used with the conversion index.

Boeckh's Manual of Appraisal is now used by over 8,500 firms, among which are hundreds of architects and builders. This Manual is nationally recognized by Fire Insurance Companies and Mortgage Loan Agencies as a standard of Building Construction Costs.

**Boeckh's Manual of Appraisals and Pad of Work Sheets.** Price shipping prepaid ..... **\$6**

**Local Current Index Conversion Factors (each location).** Price shipping prepaid ..... **\$1**

Order now, examine it for 10 days, then if you are not completely satisfied return the Manual and your money will be refunded.

**E. H. BOECKH & ASSOCIATES**  
Consulting Valuation Engineers

903 TIMES-STAR BUILDING,  
CINCINNATI, OHIO



# ANNOUNCING a new non-metallic cabinet convector by TRANE

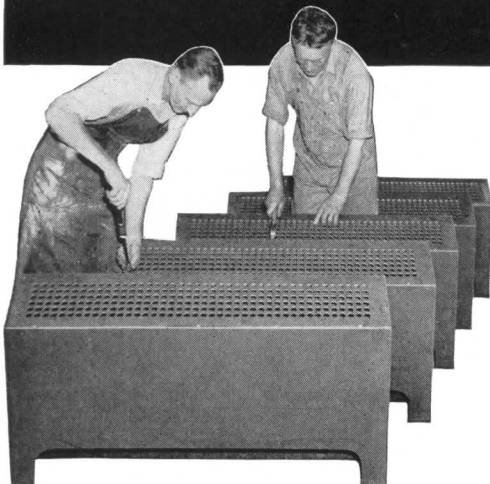
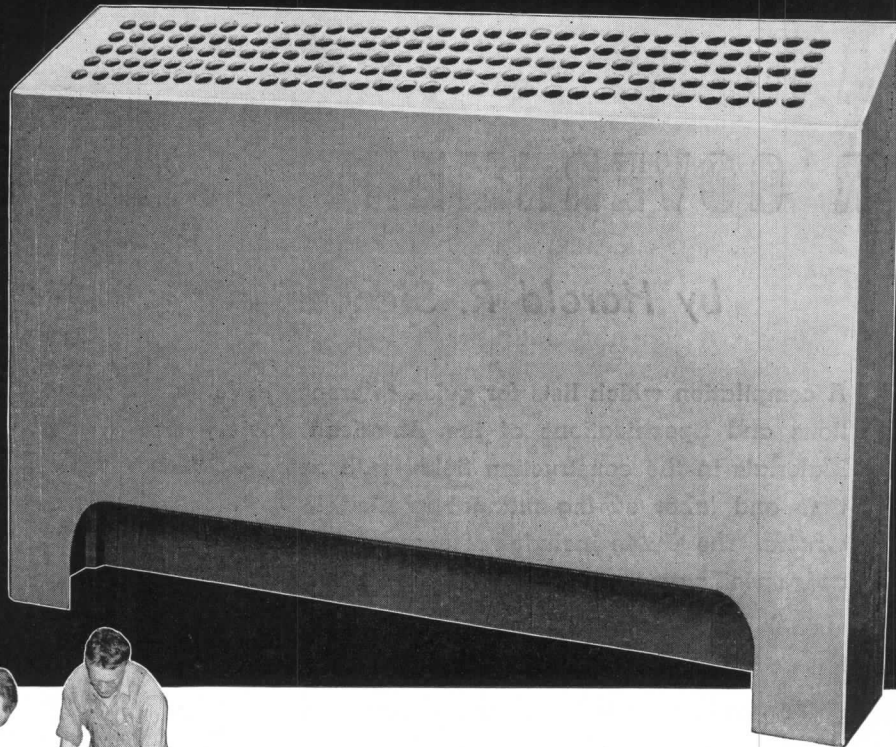

*Skilled cabinet makers fabricate the casing of the new Trane Non-Metallic Cabinet Convectors. Note the round grille design that permits positive air circulation without sacrificing cabinet strength.*

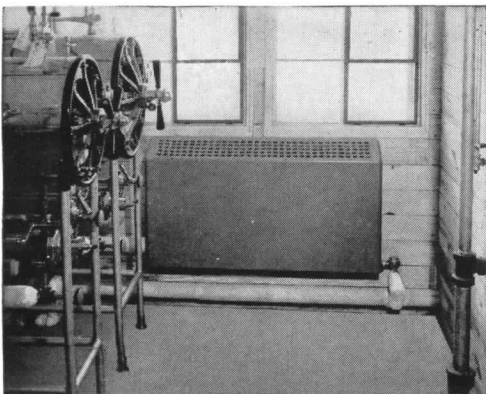

*Ideal for Army Hospitals, the Trane Non-Metallic Cabinet Convectors will save thousands of tons of precious metals in jobs similar to this one.*

**Saves 80% of critical war metals yet is smartly designed, ruggedly constructed**

Now a new convector that saves 80% of the precious metal used in the conventional radiator. Trane, at War Production Board suggestion, has developed a convector cabinet that utilizes non-critical substitutes. Yet many of the features that have made Trane Convectors the leaders in the field have been retained. There is the same even heat, fuel saving, attractive appearance, and cleanliness. The same mechanical bonded fin and tube coil construction. The same Trane Sloping Top feature.

The cabinet is fabricated of a durable non-metallic material, carefully reinforced by hardwood supporting members. Only metal used is a minimum of screws and brads. The easy-to-paint cabinets may be finished as desired when installed.

The steel heating element is carefully supported by means of hardwood corner posts eliminating any strain on the cabinet.

Two cabinet arrangements are available—one for wall suspension and the other of free standing floor type.

Available for war factories, army camps, hospitals, and similar military establishments, this new unit has already saved as much as 300 tons of precious metal on a single job. For further information call the nearest Trane representative or write The Trane Company, La Crosse, Wisconsin.

## THE TRANE COMPANY

LA CROSSE, AIR<sup>7</sup> W I S C O N S I N

Also TRANE COMPANY OF CANADA LTD., TORONTO, ONTARIO  
HEATING • COOLING • AIR CONDITIONING EQUIPMENT FROM 85 OFFICES

# GUIDE TO STANDARD SPECIFICATIONS FOR GOVERNMENT BUILDING

*by Harold R. Sleeper, AIA*

A compilation which lists for quick reference Federal Specifications and Specifications of the American Society for Testing Materials in the construction field—with notes on their use. A time and labor saving manual invaluable to all specification writers. The Guide includes references to other pertinent standard specifications, is arranged by trades and includes the following subjects:

- |                                 |                                     |                                      |
|---------------------------------|-------------------------------------|--------------------------------------|
| 1. MASONRY MATERIALS            | 9. LATHING & PLASTERING             | 17. INSULATION & ACOUSTICAL MATERIAL |
| 2. STONE, SLATE & CAST STONE    | 10. TILE & TERRAZZO                 | 18. EQUIPMENT & FURNISHINGS          |
| 3. WATERPROOFING & DAMPPROOFING | 11. FLOOR COVERINGS                 | 19. PLUMBING, HEATING & VENTILATING  |
| 4. STRUCTURAL STEEL             | 12. GLASS & GLAZING                 | 20. ELECTRIC                         |
| 5. ROOFING & SHEET METAL        | 13. BUILDERS' HARDWARE              | 21. DRAINAGE                         |
| 6. MISCELLANEOUS METALS         | 14. PAINTING                        | 22. ROADS & PAVING                   |
| 7. METAL WINDOWS & DOORS        | 15. SCREENS                         | 23. MISCELLANEOUS SITE WORK          |
| 8. CARPENTRY                    | 16. WINDOW SHADES & VENETIAN BLINDS |                                      |

## PRICES

Single copies, 50 cents each

25 or more copies to the same address, 40 cents each

**Architectural Record**

119 West 40th Street  
New York, N. Y.

Date.....

F. W. Dodge Corporation  
119 West 40th Street, New York, N. Y.

Please send me.....copies of Guide to Standard Specifications for Government Building, by Harold R. Sleeper, AIA. I enclose check, money order, for \$.....

NAME .....

FIRM or DEPT. ....

STREET .....

CITY or TOWN .....STATE .....

OCCUPATION or POSITION .....

AR 11-42

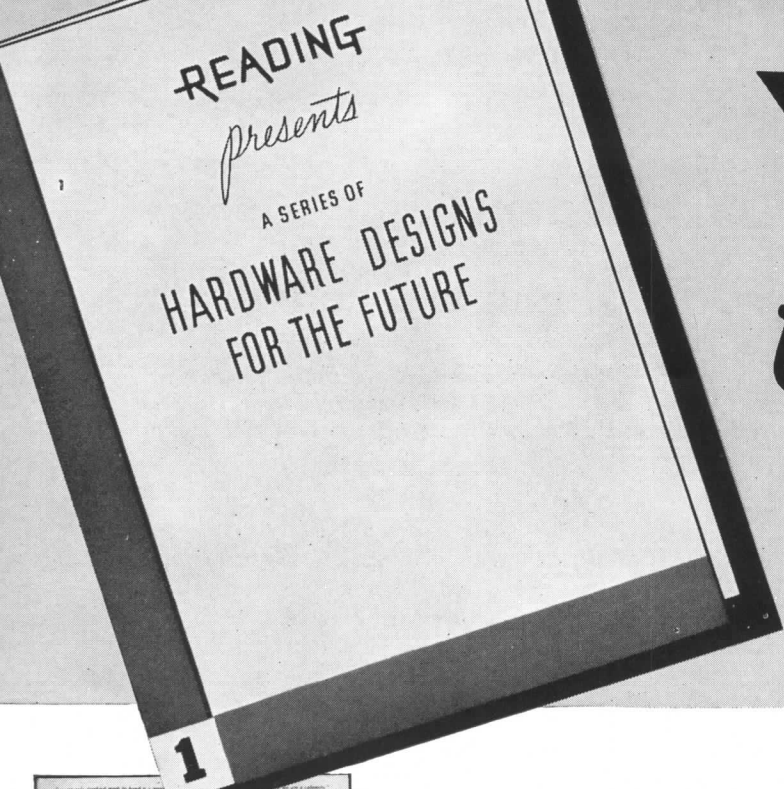

# YOURS *for the asking!*

**This interesting portfolio  
of hardware designs by  
leading architects . . . .**

As a stimulus to better design in hardware for building post-war America, READING has invited members of the profession to submit hypothetical designs embodying their ideas on builders' hardware.

If you have seen any of these designs, as they appeared in print, you know that some highly original and provocative ideas have been presented.

We would like to send you a collection of the first six units of this design series in a practical portfolio indexed for ready reference. Additions to the series will be sent from time to time. For your copy write today to Department R.

**READING HARDWARE CORPORATION  
READING, PENNSYLVANIA**





# Books for Christmas

... the ideal gift for your professional associates

For that partner or employee who is accumulating a library on architecture, engineering and related subjects what gift would be more welcome than one or more of the books listed below? Some are published by *Architectural Record*; others are "best sellers" of leading book publishers whose titles *Architectural Record* is handling as a service to subscribers. For your convenience in sending us your Christmas book order there is a handy form below.

## WAR-TIME REFERENCE

1. PLANNED A.R.P., by Tecton, Architects. 138 pages—extensively illustrated with photographs, diagrams and maps—Price \$2.50.
2. CIVIL AIR DEFENSE, by Lt. Col. Augustin M. Prentiss, U.S.A. A 334-page illustrated treatise on the protection of the civil population against air attack—Price \$2.75.
3. BOMBS AND BOMBING, by Willy Ley. 124 pages. A brisk, popular survey explaining how the several kinds of bombs are made and their probable effect on buildings of different types and on air raid shelters—Price \$1.25.
4. CIVIL DEFENSE, by C. W. Glover. Over 900 pages—fully illustrated, revised and enlarged. The most complete and authoritative book on the subject. This volume discusses in detail the precautions necessary for the protection of the civilian population—Price \$16.50.
5. AERIAL BOMBARDMENT PROTECTION, by Harold E. Wessman and William A. Rose. 372 pages. Considerable material on the action and effect of aerial bombs. Illustrated—Price \$4.00.

## HANDBOOKS ON SPECIFICATIONS

6. ARCHITECTURAL SPECIFICATIONS, by Harold Reeve Sleeper, A.I.A. 822 pages—Price \$10.00.
7. ARCHITECTURAL GRAPHIC STANDARDS, by Charles G. Ramsey and Harold R. Sleeper, 2nd edition—284 pages, 9¼ x 9½ in.—Price \$6.00.
8. ARCHITECTS' AND BUILDERS' HANDBOOK, by Frank E. Kidder and Harry Parker, 18th edition—2,315 pages—4½ x 7 in.—Price \$8.00.
9. SIMPLIFIED ENGINEERING FOR ARCHITECTS AND BUILDERS, by Harry Parker. 214 pages—96 illustrations—5 x 7¾ in.—Price \$2.75.
10. GUIDE TO STANDARD SPECIFICATIONS FOR GOVERNMENT BUILDING, by Harold R. Sleeper, A.I.A. Single copies, 50 cents each.

## BOOKS ON HOUSES

11. DESIGN OF MODERN INTERIORS, by James Ford and Katherine Morrow Ford. 132 pages, 324 illustrations—8½ x 10¾ in.—Price \$5.00.
12. BETTER HOUSES FOR BUDGETEERS, by Royal Barry Wills. 104 pages—9 x 12 in.—Sketches, plans and descriptions—Price \$3.00.
13. HOUSES FOR GOOD LIVING, by Royal Barry Wills. 104 pages, 9 x 12¼ in.—102 illustrations and plans—Price \$4.00.
14. THE MODERN HOUSE IN AMERICA, by James Ford and Katherine Morrow Ford. 134 pages—8½ x 11 in.—193 illustrations, drawings and plans—Price \$5.00.

## OTHER SUBJECTS

15. THE RESTORATION OF COLONIAL WILLIAMSBURG, a cloth-bound reprint of *Architectural Record* for December 1935—104 pages—Price \$1.50.
16. WILLIAMSBURG VIRGINIA IN PHOTOGRAPHS (Official publication of Colonial Williamsburg, Inc.) 2nd edition—35 full page illustrations—Price \$1.00.
17. THE NEW ARCHITECTURE IN MEXICO, by Esther Born. 159 pages—9 x 12 in.—Price \$2.50.

Check on the order form the numbers of the books you want, and mail to *Architectural Record* with your remittance — no extra charge for postage.

ARCHITECTURAL RECORD • 119 West 40th Street, New York, N. Y.

Please send 1.  2.  3.  4.  5.  6.  7.  8.   
9.  10.  11.  12.  13.  14.  15.  16.  17.

Check or money order for.....is enclosed.

Name .....

Address .....

City and State .....

AR 11-42

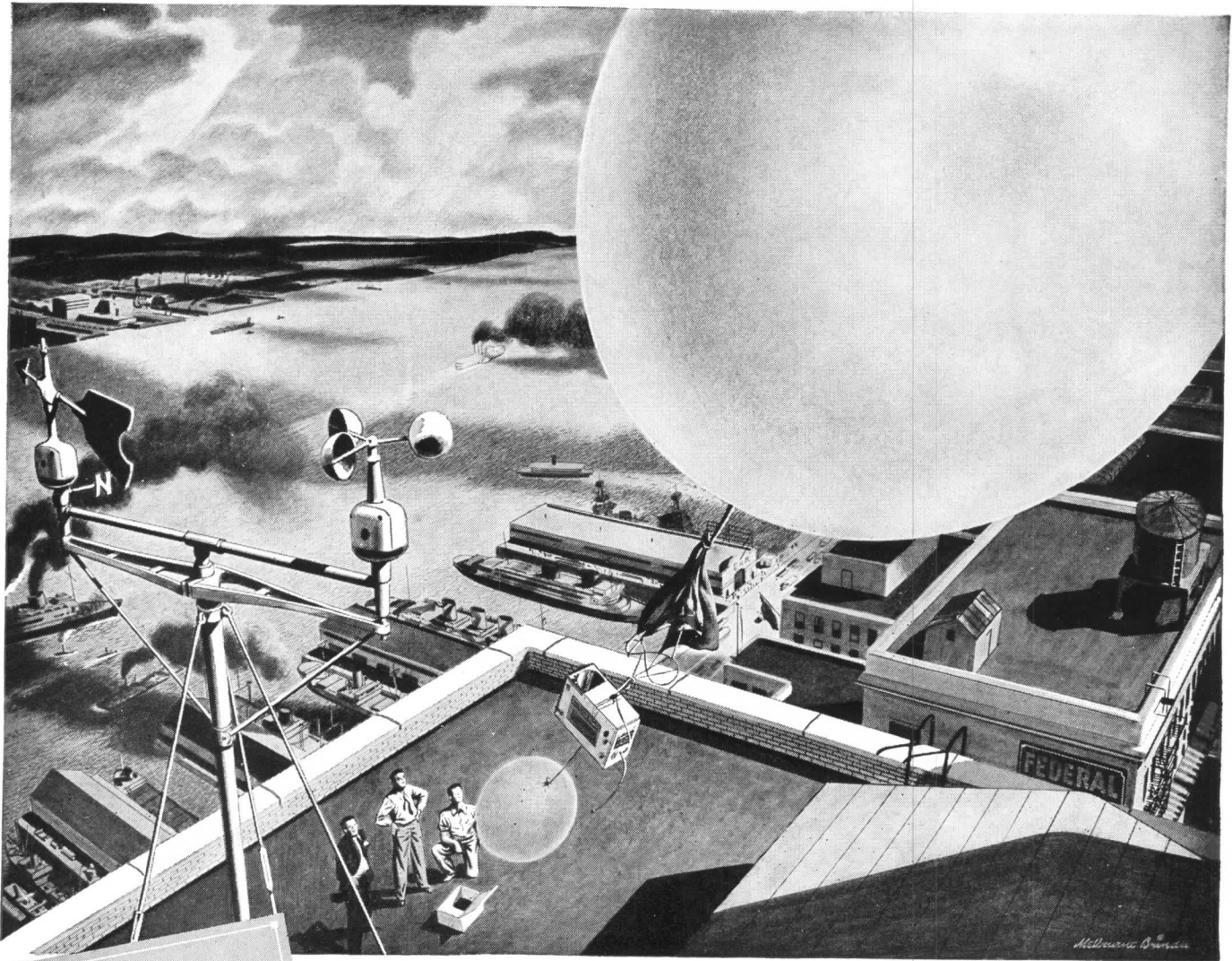

**WEATHER FORECAST:**

**2,000 DAYS WITH RAIN OR SNOW,  
AND 4,000 DAYS OF SUN**

**T**ODAY, the weather man's sounding balloon, carrying instruments ten miles or more into the upper air, makes possible forecasts of tomorrow's weather with an accuracy undreamed of in the past . . . But what of the long-range prospects?

On the basis of weather averages for the past 50 years, the roof on a building in New York City today can expect nearly six years of daily rain or snow, and eleven years of sunshine during the next 20 years. In St. Petersburg, Florida, the sun will shine on all but 100 days of the next 7,305, while in some sections of this country, a plant roof covering an acre in area can expect 454,000 tons of water to fall upon it.

America is a country of weather extremes, yet one roof has been found to give dependable, trouble-free service under all weather conditions. It is the Barrett Specification\* Roof.

These famous roofs offer a degree of

certainty in performance that is almost unparalleled in the building field. They are built up of alternate layers of pitch and felt with a fire-safe gravel or slag wearing surface, applied according to Barrett specifications by Barrett Approved Roofers. They take Fire Underwriters' Class "A" rating, and they are bonded against repair and maintenance expense for periods up to 20 years.



This is no time to gamble with unproved materials or untried methods. Why experiment? Specify Barrett . . . and protect yourself and your clients against costly roof failures.

**THE BARRETT DIVISION**

ALLIED CHEMICAL & DYE CORPORATION

40 RECTOR STREET, NEW YORK

2800 Sacramento Avenue  
Chicago, Illinois

Birmingham,  
Alabama

ONE OF AMERICA'S GREAT BASIC BUSINESSES



- BARRETT SPECIFICATION\* ROOFS
- BUILT-UP ROOFS
- ASPHALT SHINGLES
- ASPHALT AND ASBESTOS SIDINGS
- ROLL ROOFINGS
- PROTECTIVE PRODUCTS
- WATERPROOFING
- ROCK WOOL INSULATION

\*REG. U. S. PAT. OFF.



# 25 YEARS OF PROVIDING THE EAGLE WITH CLAWS!

..... AND TWENTY-FIVE YEARS OF ACCUMULATED  
"KNOW HOW" IN THE MANUFACTURE OF MUNITIONS FOR UNCLE SAM  
AND ..... OF PROVIDING OUR GOOD CUSTOMERS WITH QUALITY  
BRASS AND COPPER PRODUCTS.

TWENTY-FIVE YEARS AGO THIS FACTORY WAS WORKING ENTIRELY FOR  
UNCLE SAM—in fact, our country's need in the first World War was the  
very reason for our birth and existence. TODAY WE ARE AGAIN WORKING  
100% TO SUPPLY WAR MATERIALS FOR OUR ARMED FORCES—AND  
DURING ALL THE YEARS BETWEEN THE FIRST AND SECOND WORLD WAR  
IN WHICH WE WERE BUILDING A LARGE DOMESTIC BUSINESS, WE ALSO  
CONTINUED TO SUPPLY ORDNANCE MATERIAL FOR UNCLE SAM'S NAVY.

STREAMLINE Copper Pipe and Fittings are now in the service of our country  
for many purposes. They are installed in naval vessels of practically all  
types including victory ships, sub chasers, submarines, mine sweepers, etc.  
They are used for plumbing, heating, refrigeration, air conditioning, oil  
lines and a multitude of other services afloat and ashore.

On this our TWENTY-FIFTH ANNIVERSARY, we dedicate ourselves to an all-  
out effort for war . . . knowing that only through the winning of  
it can we gain a lasting peace. When peace returns to the  
world, we can regain those businesses of which we are now  
temporarily deprived, and STREAMLINE Copper Pipe and Fittings  
will once more protect the health of the nation as they are  
now protecting the health and lives of our men in the service.

We Proudly Fly the Army-Navy "E"  
for Excellence and Timely Production  
of Ordnance Materiel.

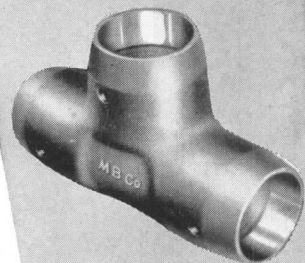
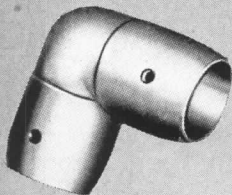
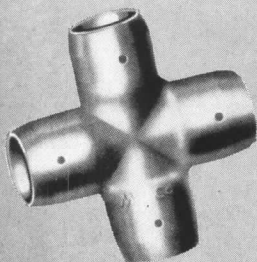

**STREAMLINE**  
PIPE AND FITTINGS DIVISION  
**MUELLER BRASS CO.**  
PORT HURON, MICHIGAN



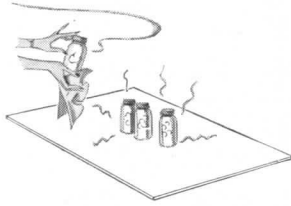

*a Libbey-Owens-Ford Product*

## TEMPERED VITROLITE

**comes to the rescue of work surfaces**

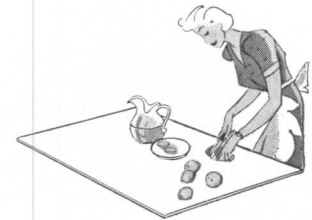

Many of the materials you have used for work surfaces have been sent to war. So now, in their place we have developed a new and better work surface material . . . *Tempered Vitrolite*.

Our engineers recognized the multiplicity of demands that such a material must serve. Vitrolite combined many of the required characteristics. Its surfaces are smooth, sanitary, nonporous and easy to clean. It is stainproof and resistant to all common acids. It is opaque, made in the purest white or in a wide range of other attractive colors.

One step was necessary to make Vitrolite the perfect work surface for industrial use as well as

for kitchen tables, cabinets and shelves. By a special process we tempered it and endowed it with an iron constitution. Through this process it becomes so strong that it will support the weight of an average family. It is amazingly resistant to physical impact. It stands thermal shock so well you can place it on a cake of ice and pour hot molten lead on its top side without causing a crack.

*Tempered Vitrolite* is solid and substantial . . . sanitary and easy to clean. Its surfaces are harder than most metals. Be sure you have complete details. Write Libbey-Owens-Ford Glass Company, 1330-A Nicholas Building, Toledo, Ohio.



**LIBBEY • OWENS • FORD**

QUALITY *Flat Glass* PRODUCTS

Your file should  
contain this  
new handbook!

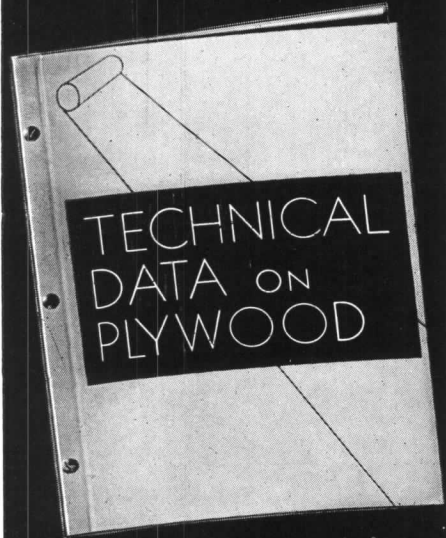

Write for your  
free copy today!

JUST published are the initial chapters of a new engineering handbook on Douglas Fir Plywood. This is the first time that much of the data on the mechanical properties of Douglas Fir Plywood contained in them has been available to the architect and engineer. You will find that this data will make your designing, specifying and working with plywood easier than ever before.

This handbook is in loose-leaf form, and additional chapters will be sent you as they are completed. Write now for your free copy of "Technical Data on Plywood". Douglas Fir Plywood Association, Tacoma, Washington.

**DOUGLAS FIR  
PLYWOOD**

*Real Lumber*  
MADE LARGER, LIGHTER  
SPLIT-PROOF  
STRONGER

"A PRODUCT OF AMERICA'S ETERNALLY  
REPLENISHING FORESTS"

## INDEX TO ADVERTISEMENTS

Catalogs of concerns marked (s) are filed in Sweet's Catalog File (1942)

	Page		Page
AIR REDUCTION SALES .....	26	s L C N. DOOR CLOSERS .....	83
Agency: G. M. Basford Company		Agency: J. D. Hamilton Adv. Agency	
s ALUMINUM COMPANY OF AMERICA .....	13	LEVINSON STEEL SALES CO. ....	28
Agency: Fuller, Smith & Ross, Inc.		Agency: William Cohen	
s ALLIED CHEMICAL & DYE CORP. ....	99	s LIBBEY-OWENS-FORD GLASS COMPANY ...	101
Agency: McCann Erickson, Inc.		Agency: Fuller, Smith & Ross, Inc.	
s AMERICAN BRASS COMPANY .....	22-23	s MAHON, R. C., COMPANY .....	25
Agency: Ivey & Ellington, Inc.		Agency: Anderson, Inc.	
AMERICAN HOTEL ASSOCIATION .....	94	s MAPLE FLOORING MANUFACTURERS ASSOCIATION .....	86
Agency: John Falkner Arndt & Co.		Agency: Aubrey, Moore & Wallace, Inc.	
AMERICAN PENCIL COMPANY .....	21	s MILLER COMPANY .....	2nd Cover
Agency: Al Paul Lefton Company		Agency: J. M. Hickerson, Inc.	
AMERICAN ROLLING MILL COMPANY .....	14	s MINNEAPOLIS-HONEYWELL REGULATOR COMPANY .....	30
Agency: N. W. Ayer & Son, Inc.		Agency: Addison Lewis & Associates	
s ARMSTRONG CORK COMPANY .....	9	s MODINE MANUFACTURING COMPANY ....	104
Agency: Batten, Barton, Durstine & Osborn, Inc.		Agency: Cramer-Krasselt Company	
s ARROW-HART & HEGEMAN ELECTRIC CO. ....	2	s MUELLER BRASS CO. ....	100
Agency: Norris L. Bull		NELSON HERMAN CORPORATION .....	80
s BARRETT DIVISION .....	99	Agency: L. W. Ramsey Co.	
Agency: McCann Erickson, Inc.		OZALID PRODUCTS DIVISION .....	11
s BETHLEHEM STEEL COMPANY .....	88	Agency: D. William Roth Company	
s BLUE RIDGE GLASS CORPORATION .....	24	s PAGE FENCE ASSOCIATION .....	82
Agency: Fuller Smith & Ross, Inc.		Agency: Reincke, Ellis, Younggreen & Finn	
BOECKH, E. H., & ASSOCIATES. ....	94	s PETROLEUM HEAT & POWER COMPANY ..	20
BURGESS BATTERY COMPANY .....	6	s PITTSBURGH PLATE GLASS COMPANY. ....	91
Agency: Fensholt Company		Agency: Batten, Barton, Durstine & Osborn, Inc.	
s BURT MFG. COMPANY .....	90	s PORTLAND CEMENT ASSOCIATION .....	93
Agency: E. D. Wolaver		Agency: Roche, Williams & Cunningham, Inc.	
s BYERS, A. M., COMPANY .....	4	READING HARDWARE CORPORATION .....	97
Agency: Ketchum, MacLeod & Grove, Inc.		Agency: Wildrick & Miller, Inc.	
s CABOT, SAMUEL, INC. ....	90	RIC-WIL CO. ....	92
Agency: Mason L. Ham		Agency: Krichbaum Company	
s CAREY PHILIP MFG. COMPANY .....	73	RILCO LAMINATED PRODUCTS, INC., 3rd Cover	
Agency: S. C. Baer Company		Agency: Alfred Colle Company	
CLEAVER-BROOKS COMPANY .....	16	s SAMSON CORDAGE WORKS .....	92
Agency: Klau Van Pietersom-Dunlap Associates		Agency: Callaway Associates	
CRANE COMPANY .....	89	s SCOTT PAPER COMPANY .....	4th Cover
Agency: Buchen Company		Agency: J. Walter Thompson Co.	
s CURTIS COMPANIES SERVICE BUREAU ...	75	s SLOAN VALVE COMPANY .....	79
Agency: Buchen Company		Agency: Reincke, Ellis, Younggreen & Finn	
s DAY-BRITE LIGHTING, INCORPORATED ....	29	SMITH, H. B., CO., INC. ....	76
Agency: Anfenger Advertising Agency		Agency: Bordeaux Company	
s DIXONS TYPHONITE ELDORADO PENCILS	1	s SQUARE D COMPANY .....	19
Agency: Federal Advertising Agency		Agency: Reincke, Ellis, Younggreen & Finn	
s DOUGLAS FIR PLYWOOD ASSOCIATION ...	102	s STANLEY WORKS .....	92
Agency: McCann-Erickson, Inc.		Agency: Horton-Noyes Company	
s DU PONT, E. I. DE NEMOURS & CO., INC.	10	s STREAMLINE PIPE & FITTINGS DIVISION	100
Agency: Batten, Barton, Durstine & Osborn, Inc.		TAYLOR HALSEY W. CO., INC. ....	92
GENERAL ANILINE & FILM CORPORATION	11	Agency: William Cohen	
Agency: D. William Roth Company		TIMBER ENGINEERING COMPANY .....	78
s GRASSELLI CHEMICALS DEPT. ....	10	Agency: Campbell-Ewald Company	
Agency: Batten, Barton, Durstine & Osborn, Inc.		s TRANE COMPANY .....	95
s HART & HEGEMAN DIVISION .....	17	Agency: Batten, Barton, Durstine & Osborn, Inc.	
Agency: Norris L. Bull		s UNITED STATES STEEL CORPORATION SUBSIDIARIES .....	87
s HOLOPHANE COMPANY, INC. ....	12	Agency: Batten, Barton, Durstine & Osborn, Inc.	
Agency: William G. Seldenbaum		s UNIVERSAL ATLAS CEMENT COMPANY ...	87
s HORN MANUFACTURING COMPANY .....	84	Agency: Batten, Barton, Durstine & Osborn, Inc.	
Agency: Cary Ainsworth, Inc.		UPSON COMPANY .....	77
s JOHNS-MANVILLE .....	15-103	Agency: McCann-Erickson, Inc.	
Agency: J. Walter Thompson Co.		s WALLACE & TIERNAN COMPANY, INC. ....	90
s KAWNEER COMPANY .....	17	Agency: G. M. Basford Company	
Agency: Carter Jones & Taylor		s WEBSTER, WARREN & COMPANY .....	27
s KEASBEY & MATTISON COMPANY .....	3	Agency: William Jenkins Advertising	
Agency: Geare-Marston, Inc.		s WESTINGHOUSE ELECTRIC & MFG. CO. ....	81
KINETIC CHEMICALS, INC. ....	85	Agency: Fuller Smith & Ross, Inc.	
Agency: Batten, Barton, Durstine & Osborn, Inc.			

New York—General Manager: H. Judd Payne, Advertising Manager: Tom Tredwell. B. B. Orwig, 119 West 40th Street. Boston—Robert Marshall, 855 Park Square Bldg.; Chicago—C. B. Riemersma, F. H. Boves, 700 Merchandise Mart; Cleveland—Homer Andrews, 321 Hanna Bldg.; Los Angeles—W. R. McIntyre, 400 East Third St.; Philadelphia—Tom Tredwell, 1321 Arch Street.



Roof-Communicated  
**FIRE**  
 is no menace here!

## Buildings are protected with roofs of ASBESTOS!

**I**NSIDE your plant, you probably take every precaution against fire. But no measure you take is complete if your buildings have inflammable roofs. For fires communicated to such roofs from *nearby* fires reach the staggering total of more than 60,000 a year!\*

The best insurance against roof-communicated fire is a J-M Built-Up *ASBESTOS* Roof. In our files are many cases where J-M Smooth-Surfaced Roofs have saved buildings of every type from almost certain destruction by outside fires. That's because the felts in these roofs are *asbestos* felts. Flaming embers burn out harmlessly on a Johns-Manville Asbestos Roof.

. . .

**But that's not the whole story.** J-M Asbestos Roofs are rotproof as well. They need no periodic coating against the drying-out action of the sun. The proof lies

in hundreds of J-M Roofs that are still giving excellent service after 20, 25, 30 and more years.

You should have all the facts. They are given in the 48-page book, "Things You Should Know About Your Roof." For a free copy, just write Johns-Manville, 22 East 40th Street, New York, N. Y.

**Johns-Manville**  
*Asbestos*  
**Built-Up Roofs**

\*The National Fire Protection Association has estimated that in 1940, 62,000 fires were caused by sparks falling on inflammable roofs.





know  
**HOW**

to save Fuel  
to save Space  
to save Upkeep

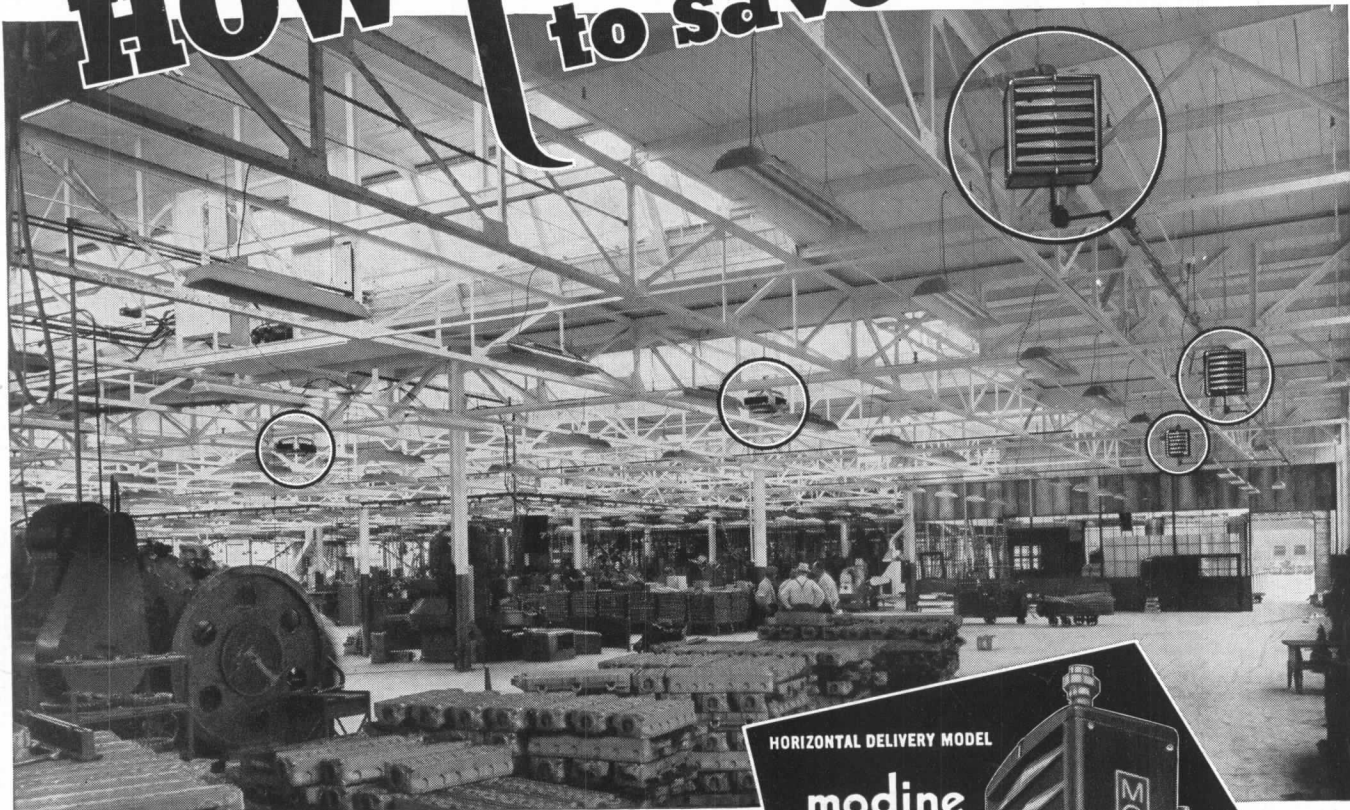

# modine

More heat—and better heating — with less fuel! How?—with Modine Unit Heaters. Why? . . .

A Modine delivers heat only where it's needed, when it's needed—in the right amount. When the area it serves is *comfortable*, off goes the Modine. No wait for warm-up; no over-run when right temperature is reached. Individually controllable—Modine units go on or off, like a light. No heat is wasted.

How much fuel can you save? 20 to 25 percent over cast-iron radiation.

You save space with Modines: Overhead and out of the way, they take up no floor space which can be utilized for production.

"Preventive Maintenance" is a built-in feature—Modines are engineered for 3-shift, round-the-clock operation.

The new *steel* Modine Unit Heaters *now available*, differ only in condenser design; have all proved performance features of copper condenser units.

Get War Edition Catalogs 142-B and 142-C.



Look in your phone book for Modine representative's name —"Where to Buy It" section under Heating Apparatus.

HORIZONTAL DELIVERY MODEL

modine  
STEEL  
unit heaters

VERTICAL DELIVERY  
MODEL

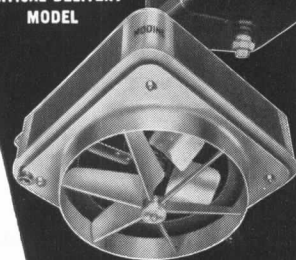

modine COILS

the line is complete—both steel and copper. Used for heating, ventilating, air conditioning and dehydrating systems. Write for Literature.

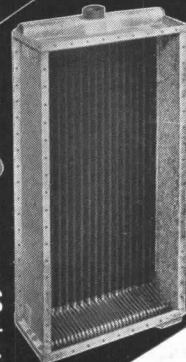

**SCRAP**  
your  
scrap!

MODINE MANUFACTURING COMPANY, 1773 RACINE STREET

RACINE, WISCONSIN