

BUILDING NEWS

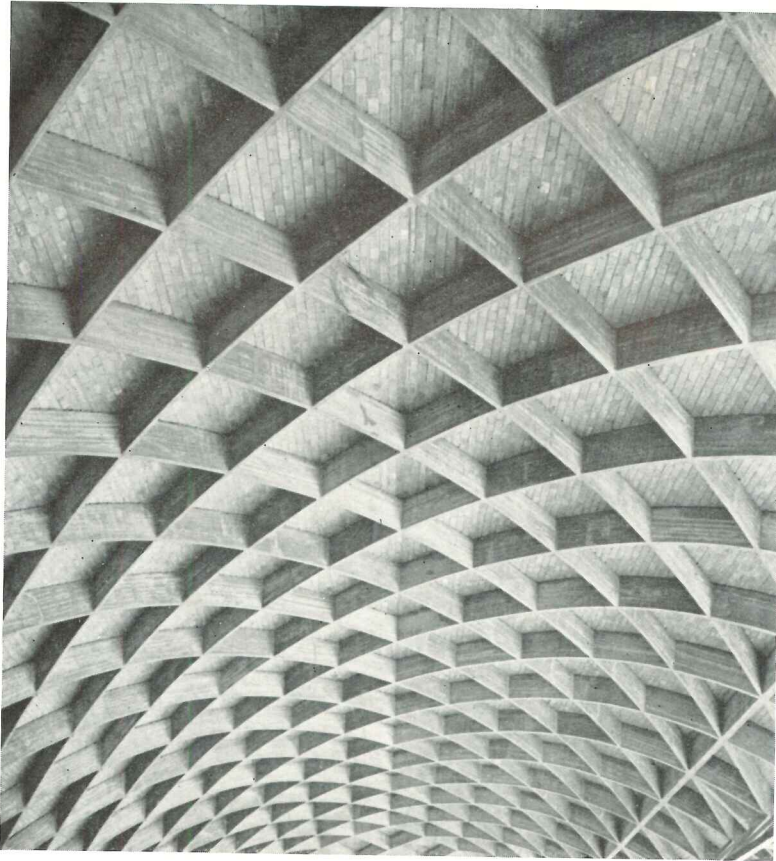

Vasari

Hangar designed for span and bomb resistance... See p. 54

ARCHITECTURAL
RECORD

COMBINED WITH
AMERICAN ARCHITECT AND ARCHITECTURE

Photos by Stuart O'Brien



Coulter Department Store, Los Angeles. Reinforced-concrete walls are "blocked" to simulate Bedford limestone; several brands of Portland cement are used in the brush coat to give the different color tones.

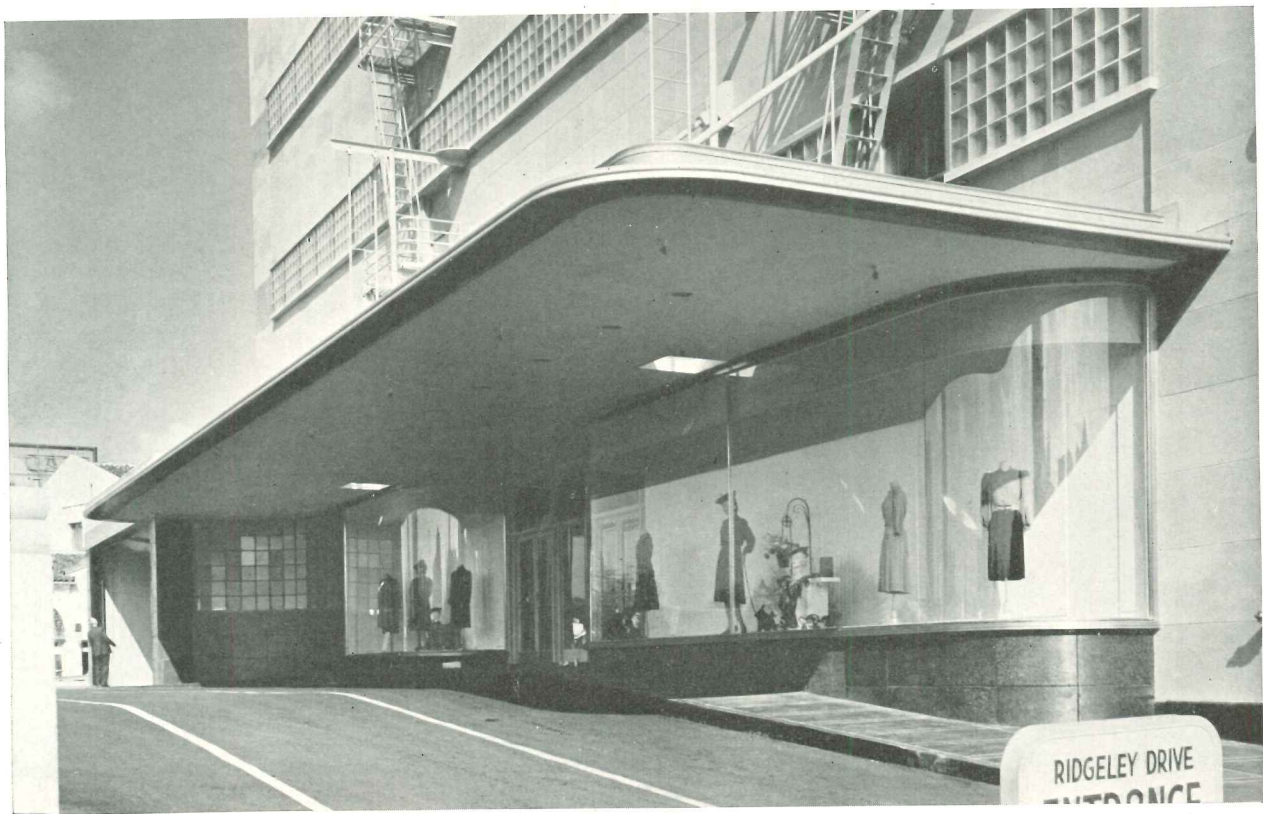

Rear entrance with parking area at left. Sixty percent of store patrons arrive by auto and enter here.

LOS ANGELES: NEW STORE PROVIDES FOR MOTORIZED PATRONS

FILES O. CLEMENT, Architect

LD

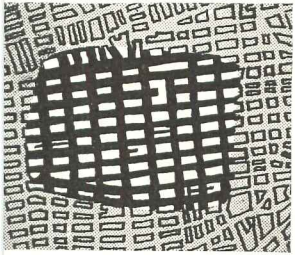

Central shopping area of Los Angeles, shaped by transportation methods

EW



COULTER'S

West shopping district along Wilshire Boulevard, shaped by motor transport

LOS ANGELES is, in population, approximately one-fifth the size of Greater New York, but it is spread over an area about 50% larger. Its widely scattered inhabitants are housed, for the most part, in detached single-family dwellings, on lots usually big enough to permit keeping autos. And the automobile does play an important part in solving the city's transportation problem: per-capita ownership of cars here is the highest in the world.*

Los Angeles' newest shopping district extends several miles along Wilshire Boulevard; the influence of increased human mobility on the plan of the city becomes apparent when this section is compared with the old, central trading area of Los Angeles, relatively centralized and congested. Spread out as they are, the stores along Wilshire Boulevard are generally open to view on several sides: competing electric signs and advertising become less effective in gaining attention than distinction in the design of the building itself.

On this street was recently opened

*According to 1936 registration figures and 1930 population statistics (the latest available), Los Angeles has one automobile for every 2.7 persons; Detroit, the center of the U. S. motor industry, has one auto for every 3 persons; Greater New York has one for every 8 persons.

a reinforced-concrete four-story-and-basement structure, Coulter's Department Store. Sixty percent of the patrons of this store arrive by automobile and enter through the parking area rather than from the street. The rear entrance has therefore been made a prominent part of the design: it opens on a marquee-sheltered sidewalk and is flanked by display windows on both sides. A small lobby is located there, equipped with seating facilities, telephone, and "Will Call Desk."

There are no windows: the building is completely air-conditioned. In the upper floors, long horizontal panels of glass brick provide daylight illumination; these are at a height from the floor sufficient to permit wall cases and fixtures to be placed below them. The glass-brick panels are hung on the outside of the walls, structural columns behind them; reinforcing steel runs both vertically and diagonally through the columns to assume possible earthquake stresses.

The structure has been designed to permit addition of an extra story without any structural alterations below; this proposed fifth floor is to be in the form of a U with the elevator foyer opening onto a garden.

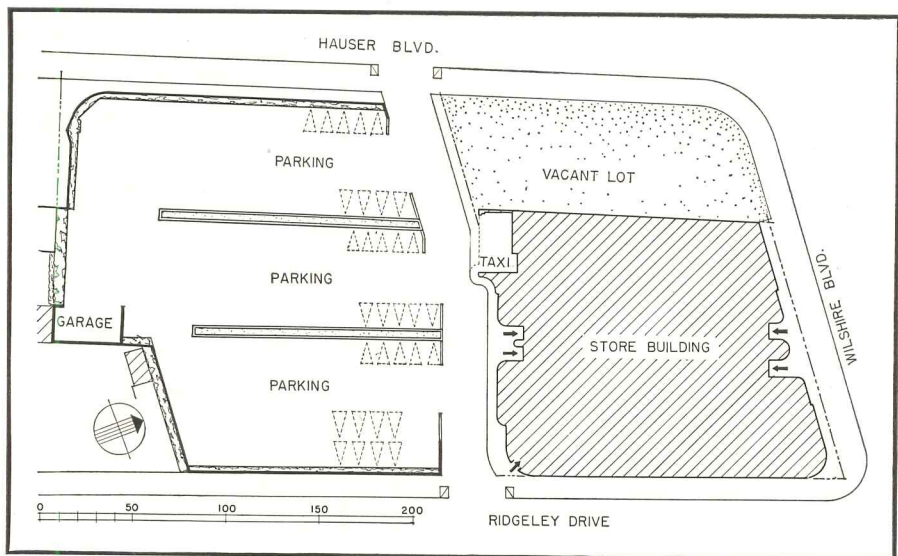

Plot plan

Photos by Stuart O'Brien



Rear view of Coulter Department Store with parking area at left and a freight platform beyond entranc

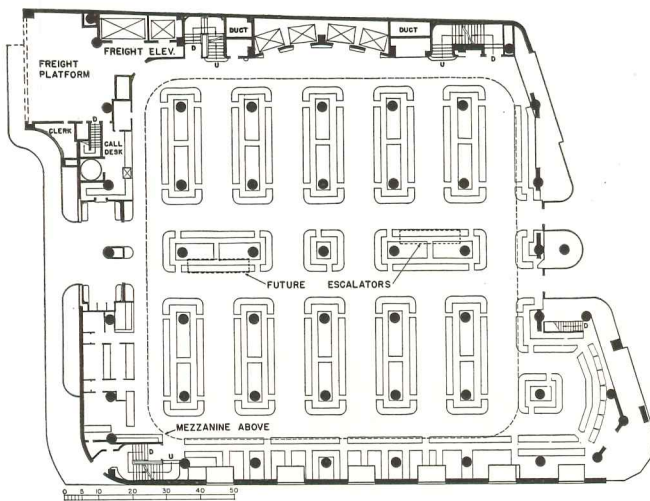

First floor

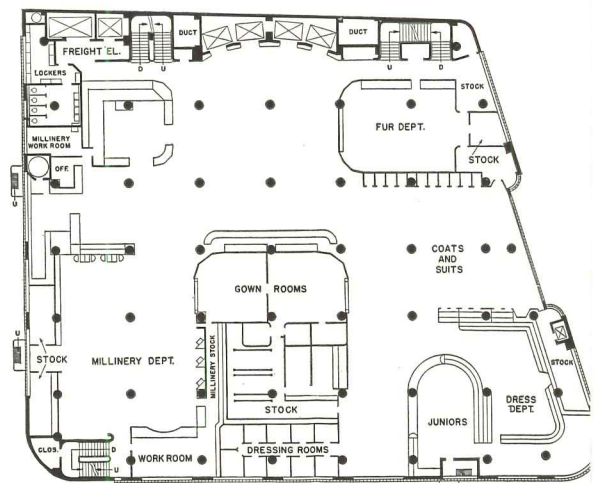

Third floor

DEPARTMENT STORE IN LOS ANGELES

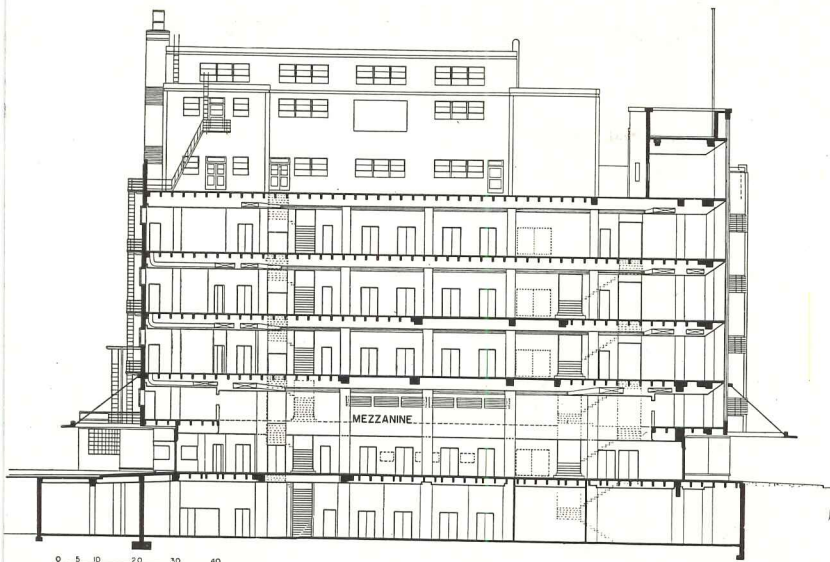

Section

ON THE MAIN FLOOR, circulation is simplified by placing front and rear entrances opposite each other and dividing them by a double main aisle. Elevators and stairways are centrally located against the west wall, equally accessible from either entrance, yet removed from the main flow of traffic. Removable metal-bound panels are set into all floors beneath the counters and cases which adjoin the center aisle; these panels cover openings intended to permit future installation of escalators without the necessity for structural alteration. Above the street floor is an enclosed mezzanine balcony housing the administrative offices; mezzanine walls are broken by long horizontal louver panels, which assist ventilation and provide a means of inspection from the mezzanine level.

The air-conditioning system is extremely flexible. All free space between ceilings and floors above is a continuous air-conditioning plenum chamber. Openings can be cut into the floor to draw air from rooms; at some future time, new rooms can be partitioned off, air-conditioning outlets can be made by cutting openings into floors wherever they are needed.



Wilshire Boulevard entrance . . . A double main aisle leads directly to . . .



automobile entrance at rear . . . Note "Will Call Desk" in lobby.



Photos by Stuart O'Brien

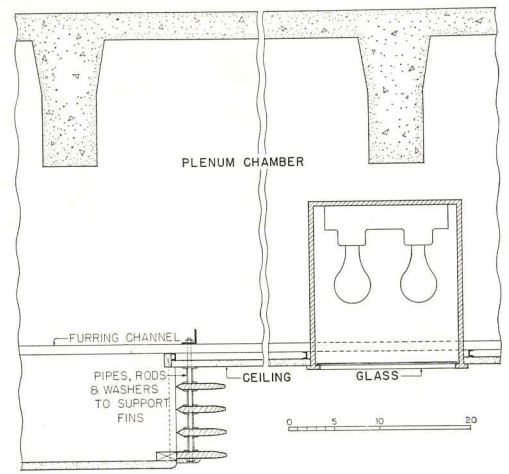

Ceiling lights on the first floor are counter-sunk flush with the surface. About 85% of the heat-radiating surface of these lights is within the plenum chamber; most of the heat generated by the lamps is carried off in the air-conditioning outflow, so that room temperature is not appreciably affected.

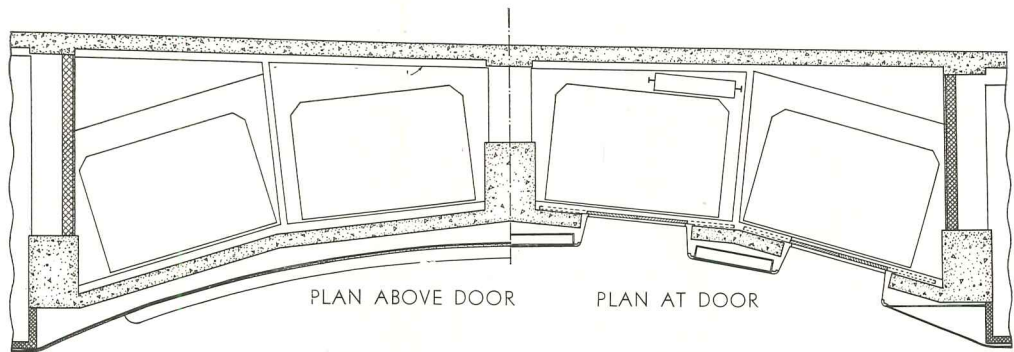

Elevator shafts are set in a shallow arc: this arrangement provides greater floor area in front of the elevators; and all cabs can be seen from any position within the arc at the same time. Shallow display cases are set into the wall between elevator doors.

Photos by Ezra Stoller

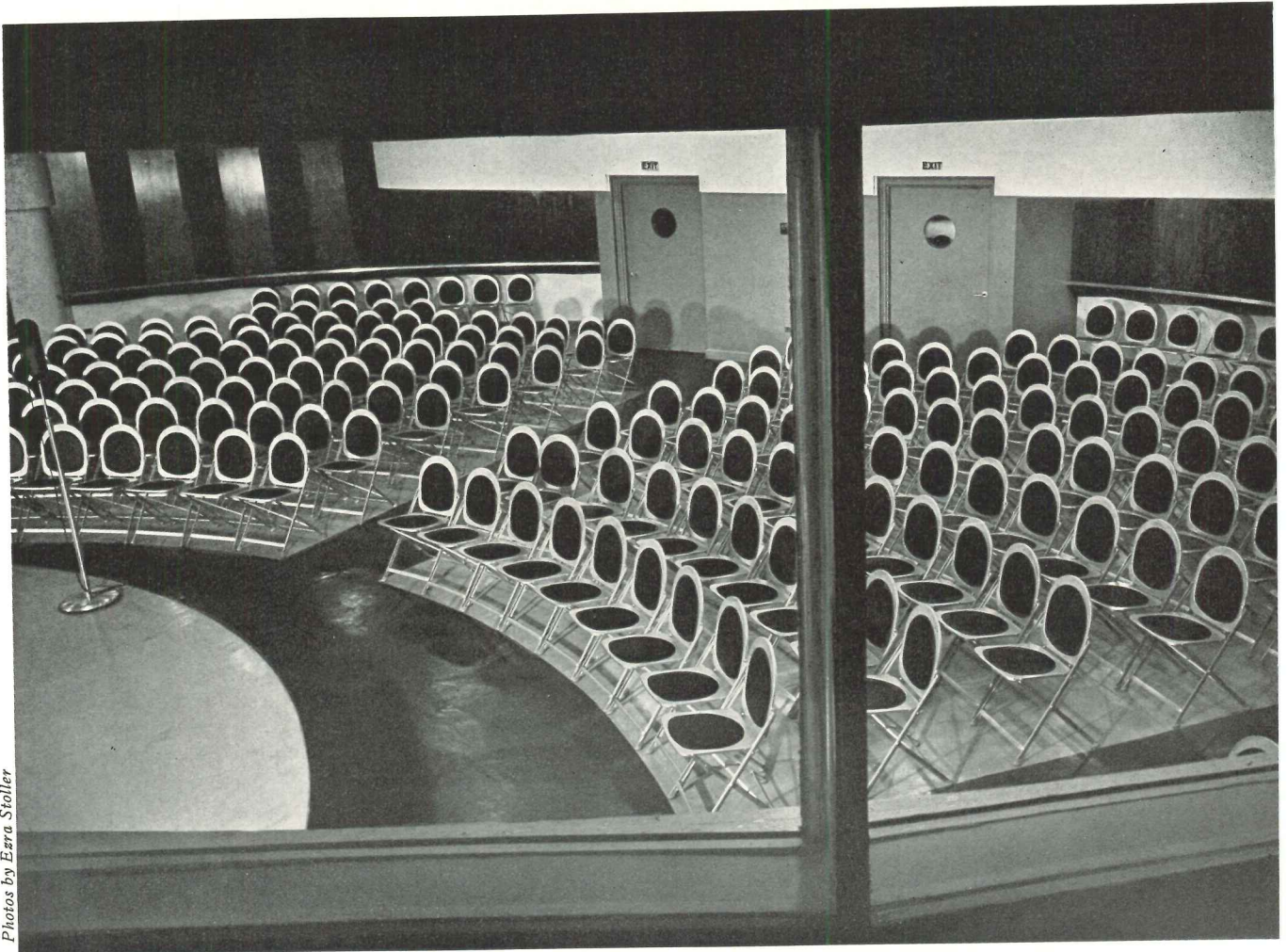

CIRCULAR BROADCASTING STUDIO IS DESIGNED FOR WMCA

LEON BARMACHE, Designer, and RENE BRUGNONI, Architect

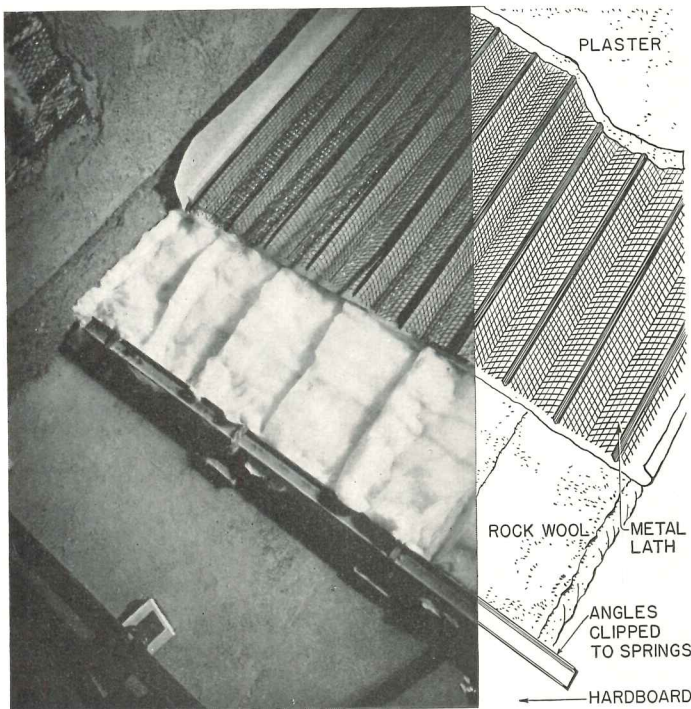

Detail of wall construction

THE MAIN auditorium of the new WMCA studios in New York City is the first circular room to be used as a source of radio programs. It was essential to prevent focusing of sound waves at some point in the room—like light reflected from a concave mirror: this was done by installing a 4-in. blanket of rock wool, covering it with perforated hardboard; the sound is absorbed as soon as it strikes the wall.

The problem of sound transmission was solved by suspending walls, floor, and ceiling from the structure by means of springs. These springs are resilient, and sounds originating inside or outside the studio do not pass through them; the springs are attached to blocks of wood encased in cement and insulated by felt pads.

Breaks in the ceiling and alcoves with acoustical rock-wool paneling aid in preventing echoes.*

*Jacobson & Co., Inc., New York City, were the acoustical engineers.

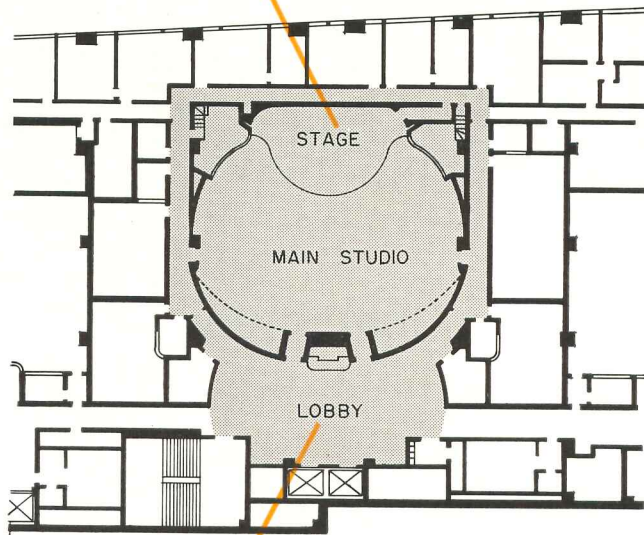

Photos by Hedrich-Blessing

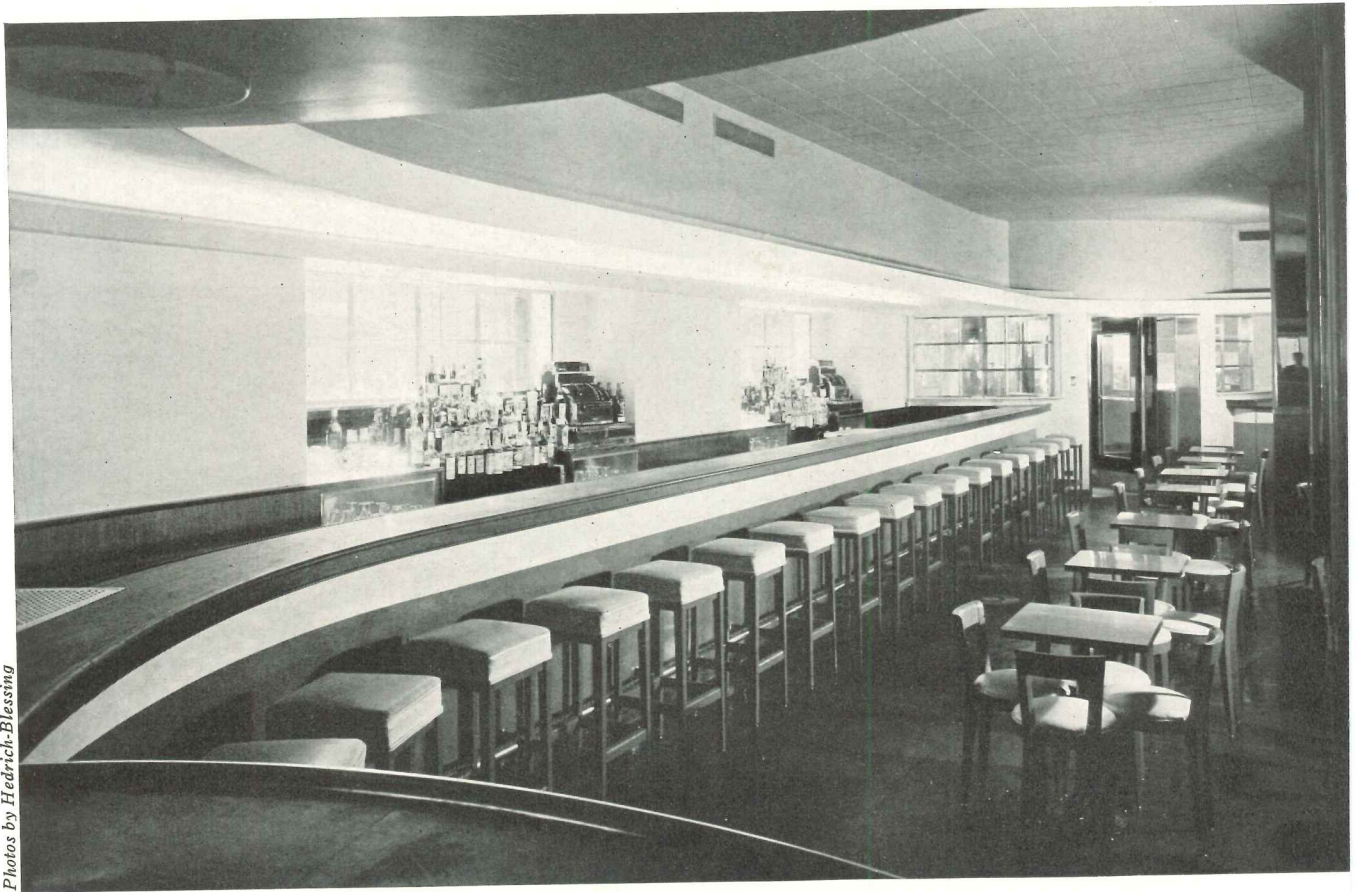

Bar in Sherman Hotel, Chicago. View looking toward street entrance, with stage platform out of picture to right.

STORE GROUP REDESIGNED INTO BAR AND STAGE

HOLABIRD & ROOT, Architects

THE STREET-FLOOR corner of Chicago's Sherman Hotel has been redesigned, with a bar and entertainment center replacing a group of old stores. In making the change it was necessary to provide an entrance with enough physical prominence to compete with other entrances along busy Randolph Street; a circular marquee extending out over the corner, and observable along the intersecting streets,

satisfies this need. Bar is accessible from lobby as well as from street, and lunches prepared in the hotel kitchen can be served conveniently in the barroom. Entertainers perform on a stage which is a little above bar level and observable from all parts of the room. The fixed columns have been a design restriction, but seem to offer little obstruction to circulation or sight lines to the stage.

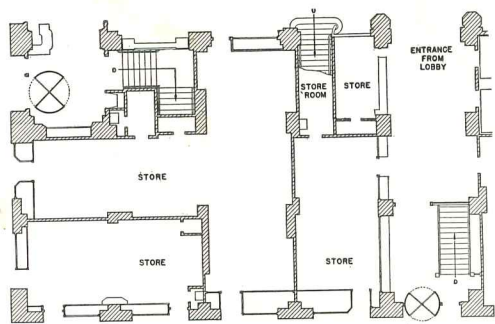

Before

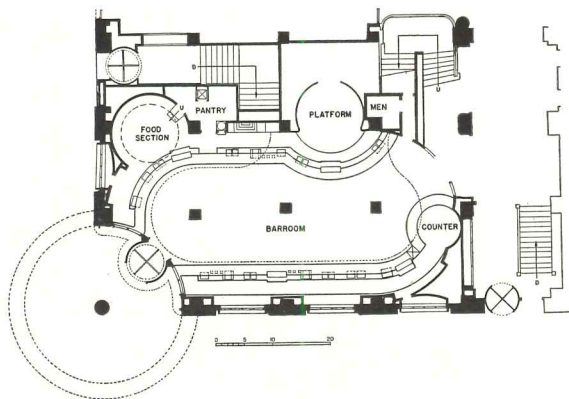

After

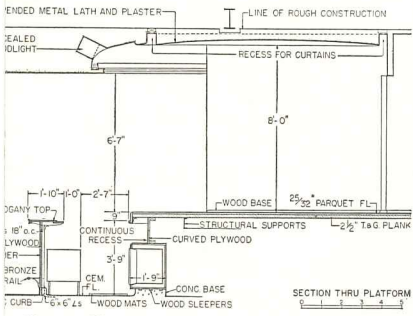
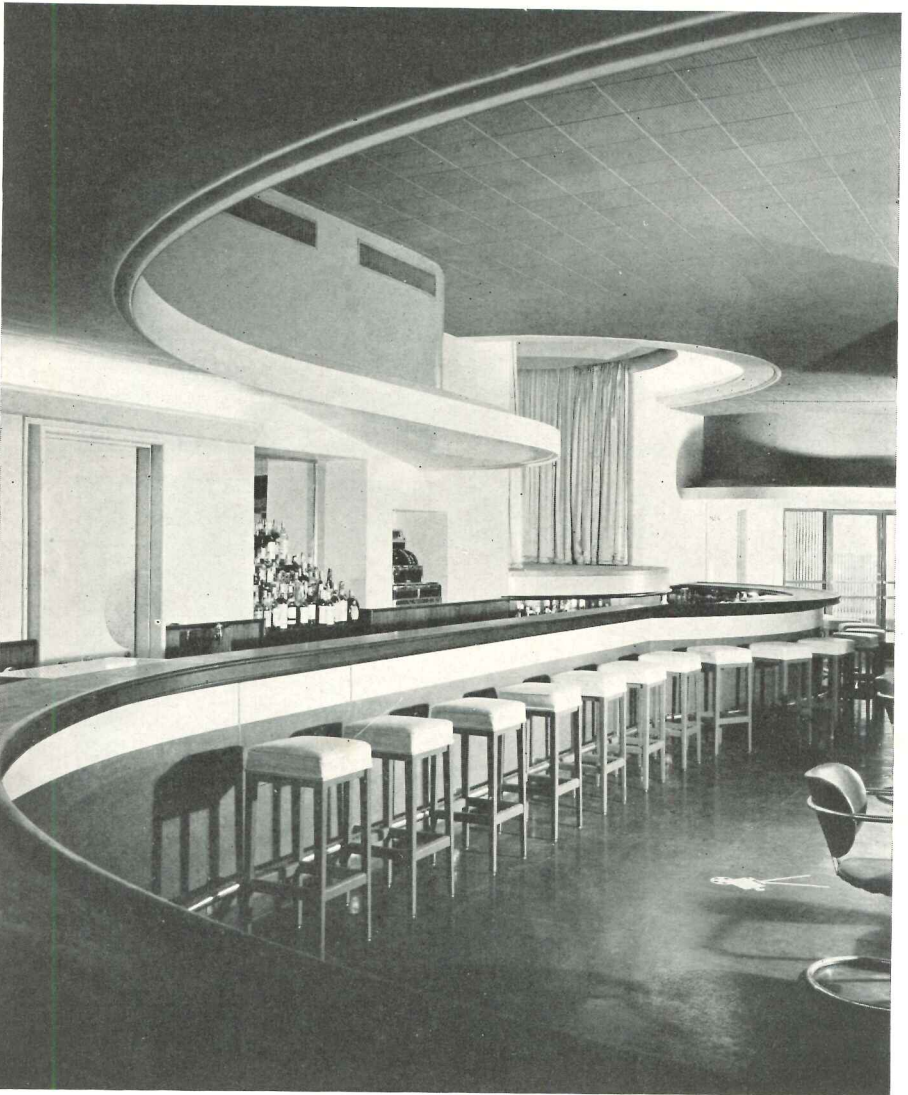
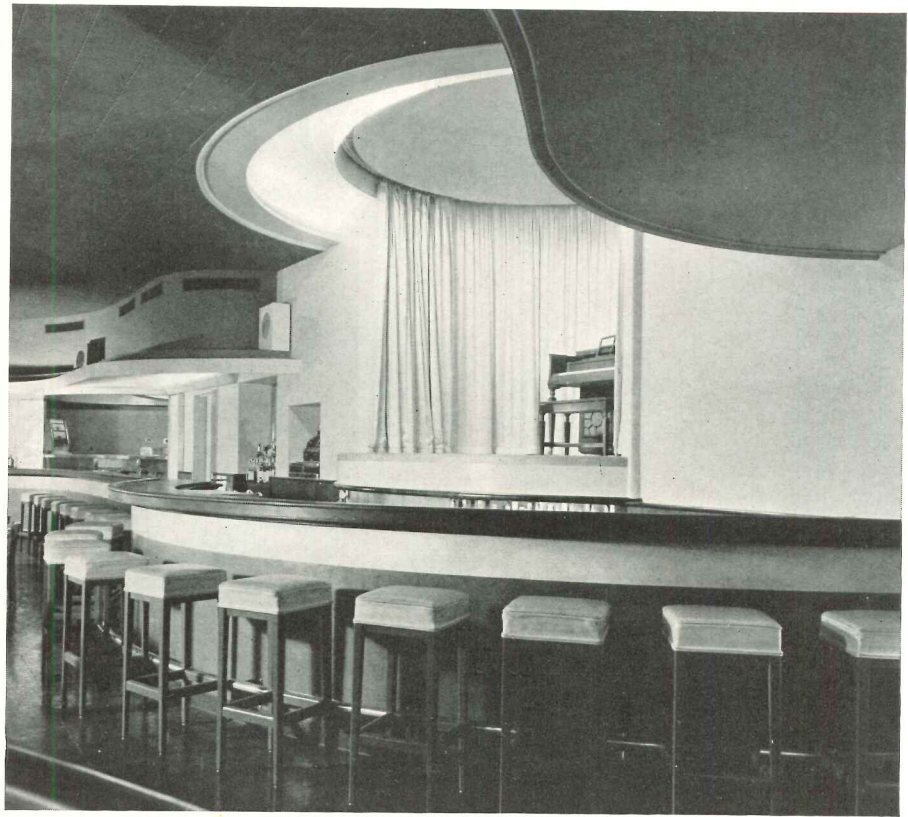

Section of stage

View of the interior, looking toward stage

BAR IN CHICAGO

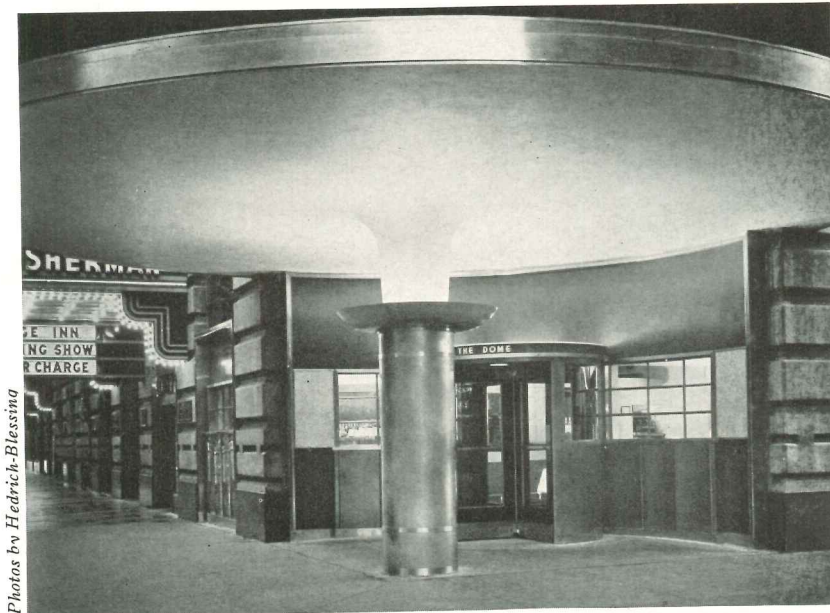

Photos by Hedrich-Blessing

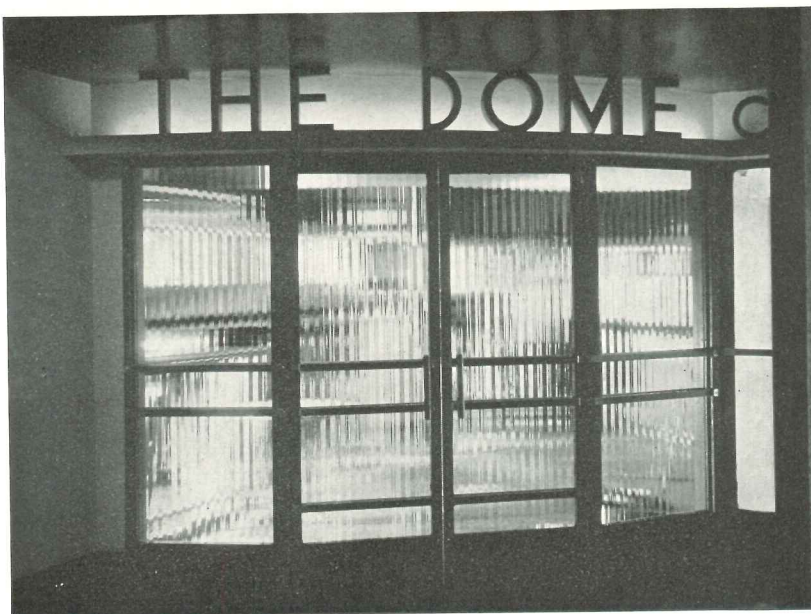

TOP: Entrance from street.
CENTER: View, looking toward
lobby entrance. BOTTOM: En-
trance from lobby of hotel.

GLUED PLYWOOD RIGID-BENT TRUSSES USED IN GYM-AUDITORIUM

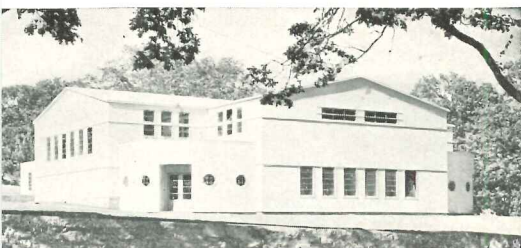
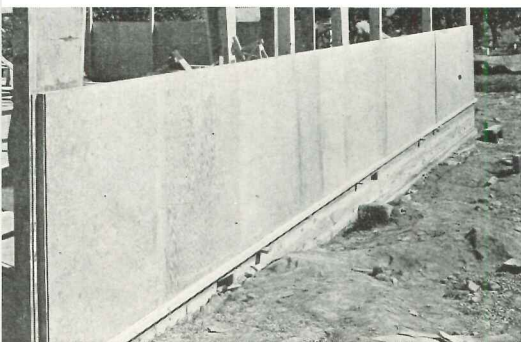
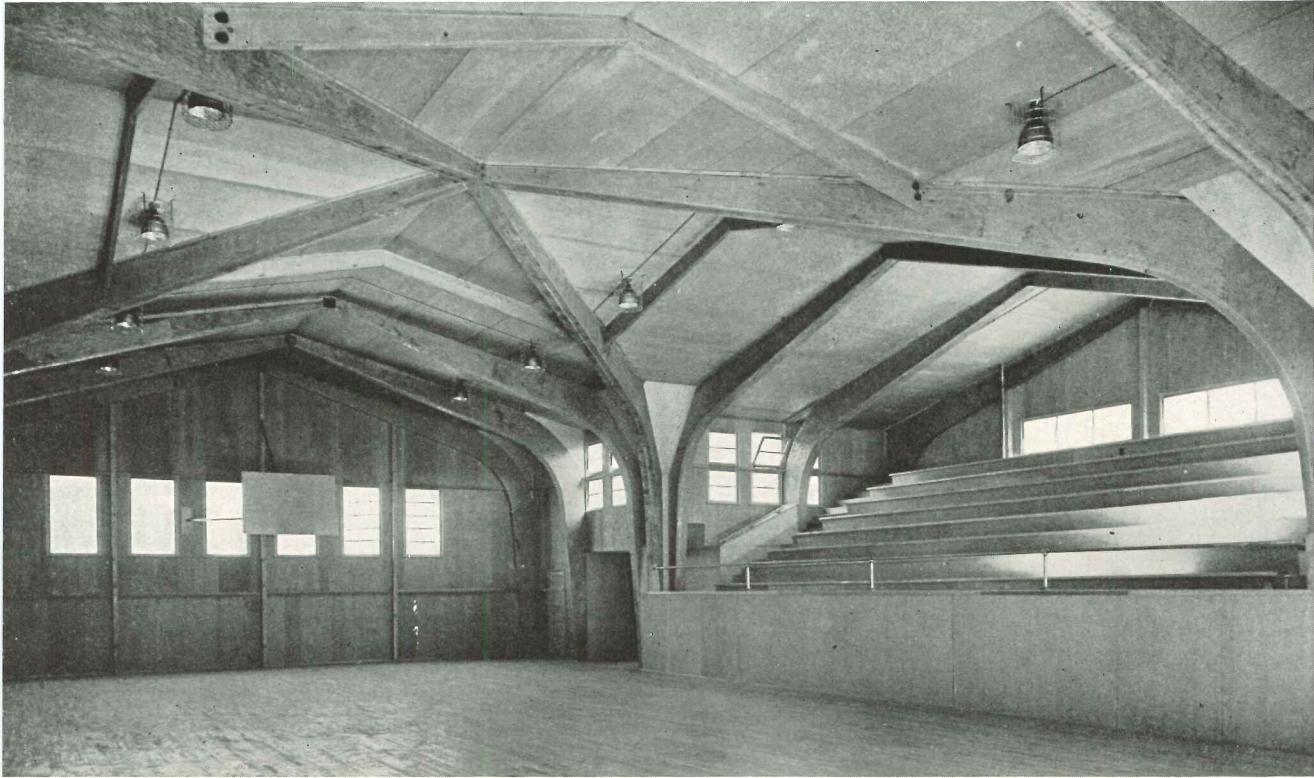

WALTER H. ROTHE, Architect

A GRADE-SCHOOL building combining auditorium and gymnasium was recently completed at White Salmon, Washington. It is a one-story structure composed of a large central unit and four adjoining wings. Its framework of glued, stress-covered, rigid-bent trusses is enclosed, walls and roof, with prefabricated panel units made almost entirely of Douglas fir plywood: 85% of the material used is plywood. Construction follows the principles worked out by the Forest Products Laboratory at Madison, Wisconsin. (See AR, 2/38, p. 48.)

The framework is composed of 12 sets of rigid-bent arches of 43-ft. span and 2 sets of arches of 61-ft. span, all resting on concrete footings. Steel tie rods under the floor bind the arches at the footings to overcome outward thrust. No purlins or structural ties are used: the panel units alone enclose the frame. Trusses were constructed and tested at the site. Closure panels were fabricated in a factory 300 miles away.

Expanded vermiculite or rock-wool batts provide insulation and contribute to fire resistance. (Wall sections, rock-wool insulated, were tested by exposure to fire for 1½ hrs. without failure.) The insulation was placed in the units at the shop. Section joints are flush and invisible; splines have been inserted in the joints, glued in place, and rendered smooth with hand-electric sanders. Although the capacity of the heating plant was reduced by one-third from the specifications originally given, it has been determined that the lowest outside temperature will not require capacity firing.

Because of its glued construction, the building is quite rigid; some nails and bolts were used, but only for the purpose of applying pressure while the glue set. The building is comparable in construction to a stringed instrument; this may account for its acoustics, said to be remarkably efficient.*

*Super-Harbord plywood and self-bonding glue by I. F. Laucks Co. were used.

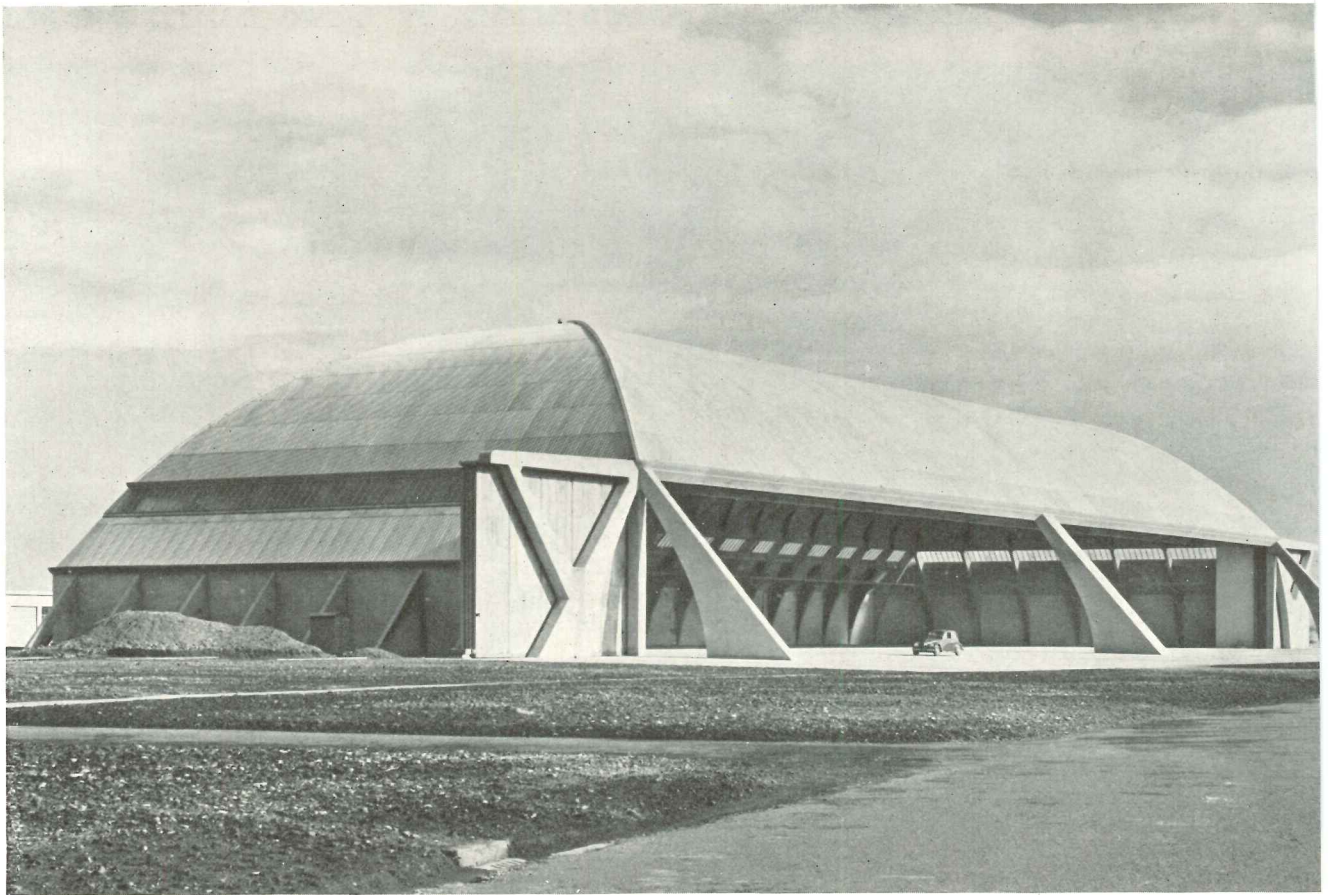

Airplane hangar near Rome, Italy. Width of entrance is 372 ft. Doors slide into a continuation of the girder.

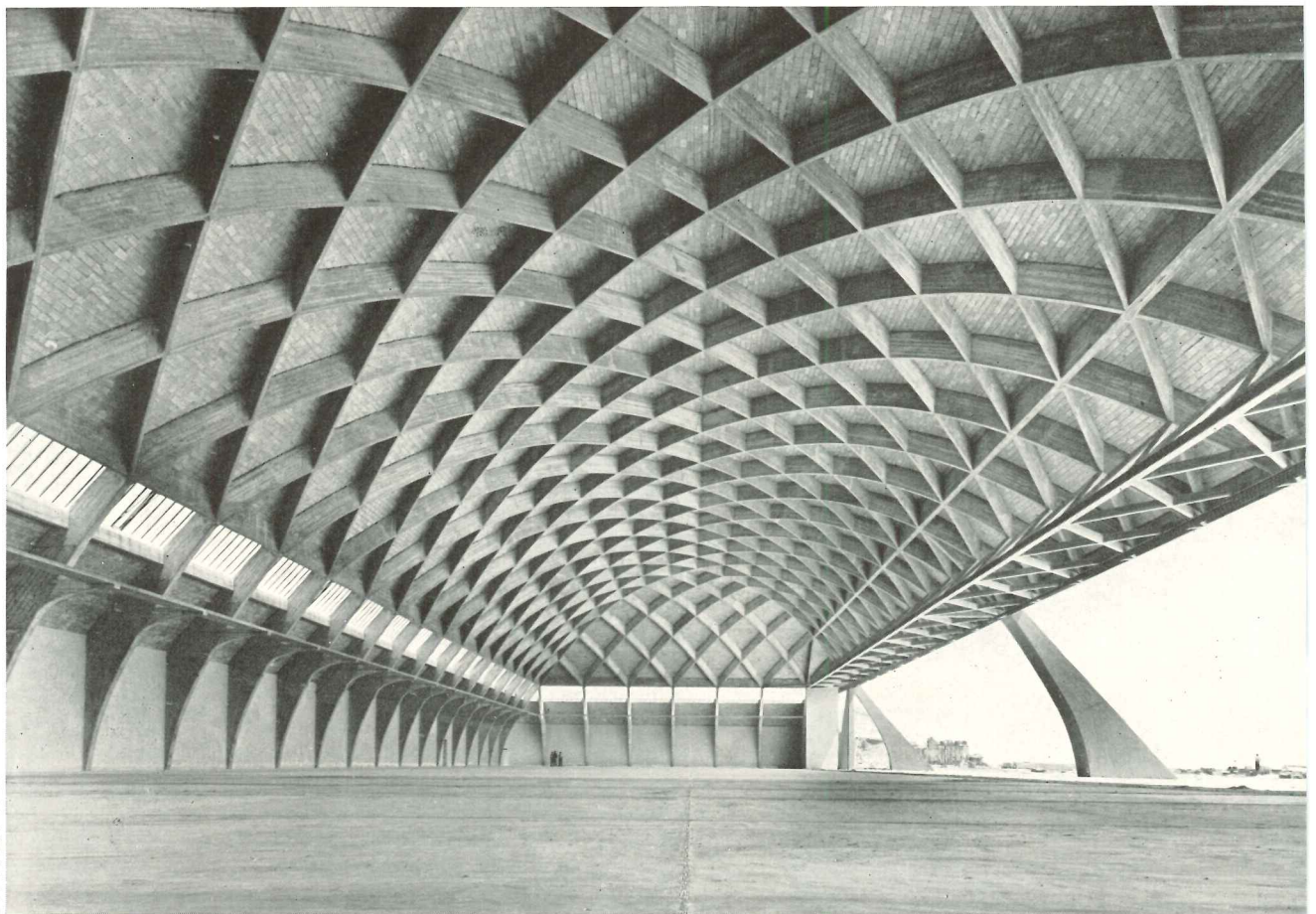

Photos by Vasari

View showing vault ribbing. Horizontal member near open side of hangar forms a lattice girder with the ribs.

HANGAR PROVIDES CLEAR SPACE AND BOMB RESISTANCE

P. L. NERVI, Engineer

THIS STRUCTURE near Rome satisfies the essential requirements of hangar design: width of span for ever-lengthening wingspreads; and bomb-resistance. The entrance, spanning 372 ft., is obstructed only by the central pier; clear area inside the building is about 54,000 sq. ft. Bomb-hits anywhere except on the horizontal girders in front would probably cause only local damage.

The bearing structure consists of a system of segmental ribs running at 45° to the axis of the hangar. At sides and rear the arches are supported on piers inclined at an angle which continues the cross-sectional curve of the roof; these carry the weight of the structure directly to the foundations. In front, the arch system and hori-

zontal girders bring the load to five larger piers at corners and center. The reticulated girder, hung from the structure at a height of 30 ft., supports the possibility of uneven loading as well as horizontal wind stress on the great doors and roof: these reactions are distributed to the frontal buttresses, bringing the system back into equilibrium. When open, the doors are supported on a continuation of the girder, which is, in turn, supported on either side by a strut joining one of the main piers.

The concrete bearing structure is covered with terra cotta, reinforced with asbestos-cement sheeting. "Air cushions" in the squares formed by the vault-ribs aid insulation.

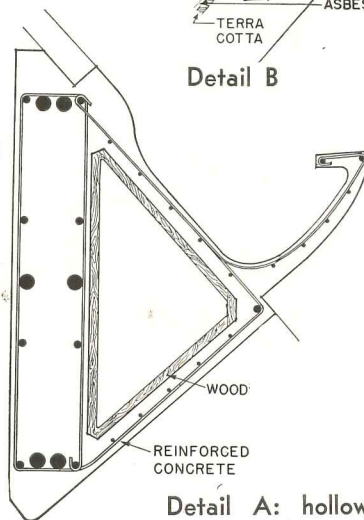
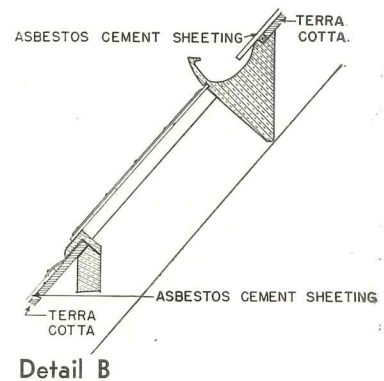
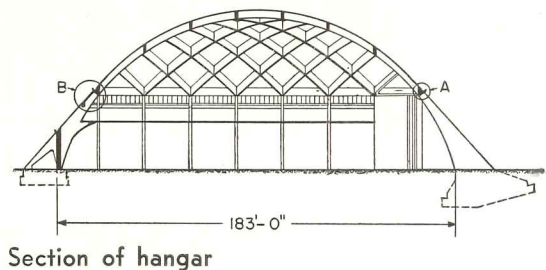
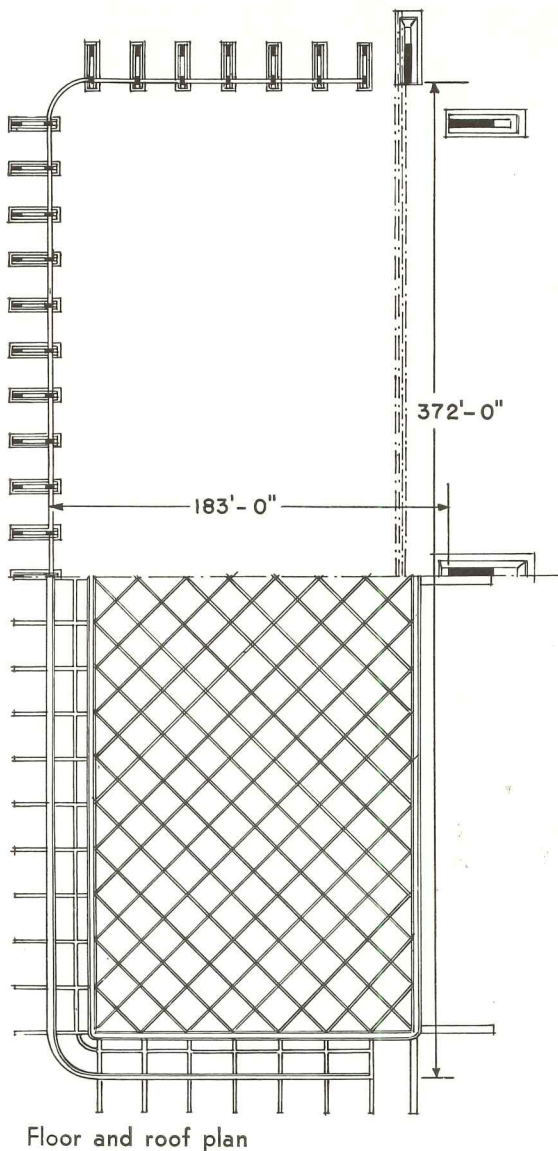

AIRPLANE HANGAR IN ROME

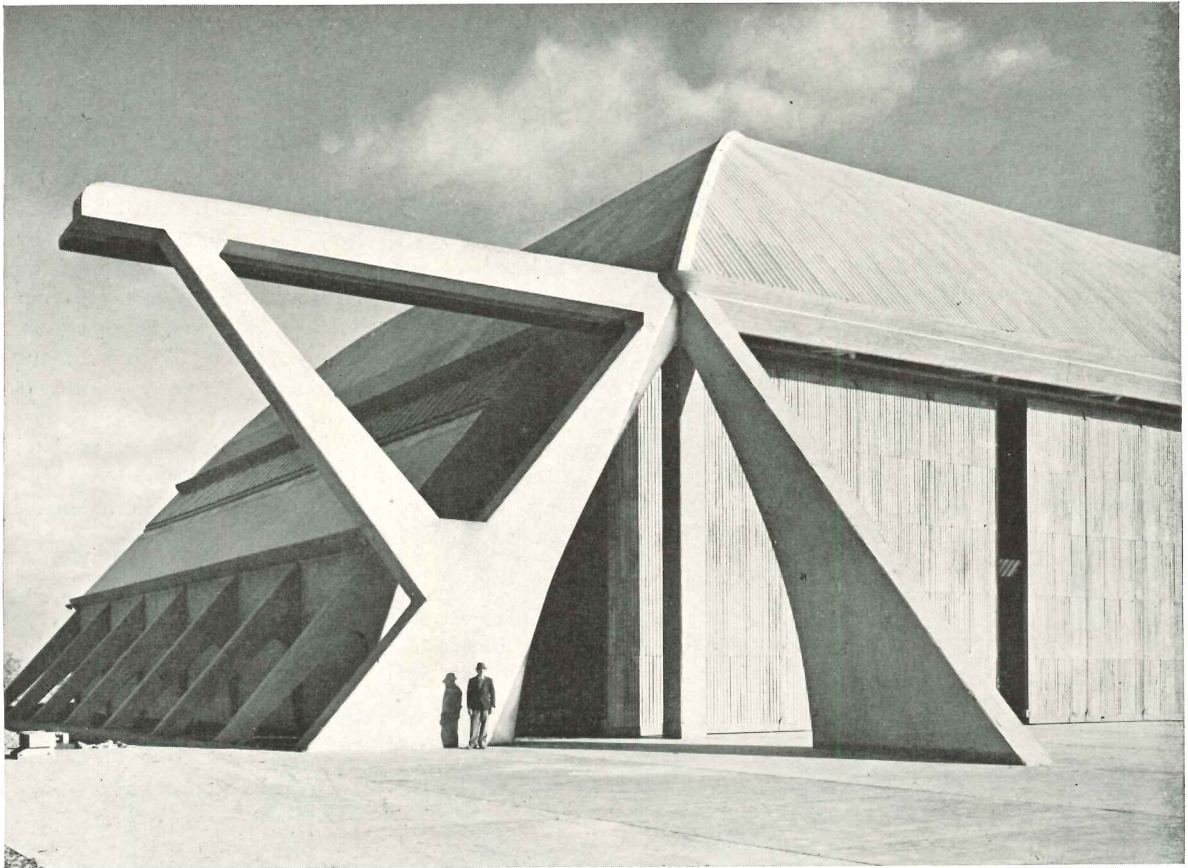

Photos by Vastri

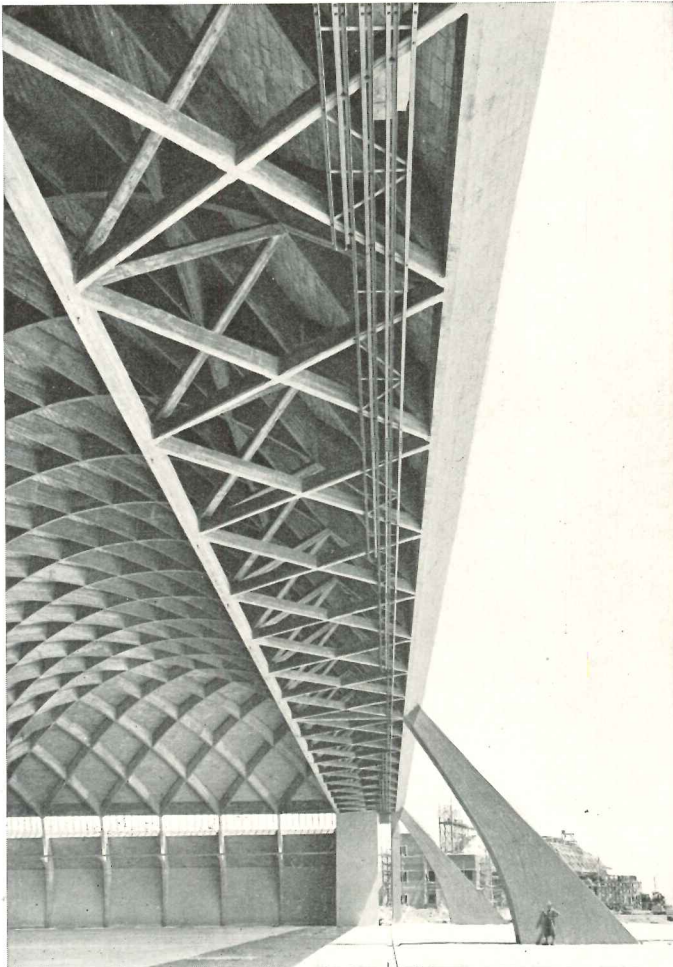

Hangar doors slide into a continuation of the girder, which is supported by a strut joined to one of the main piers.

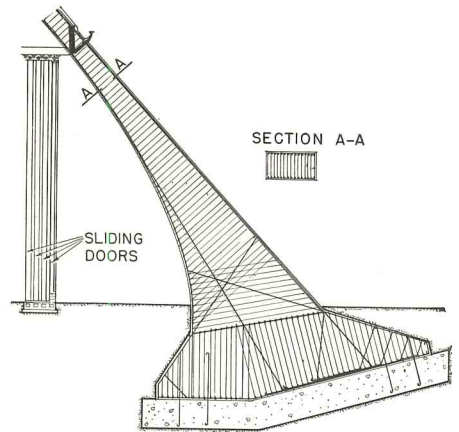

Section of frontal pier

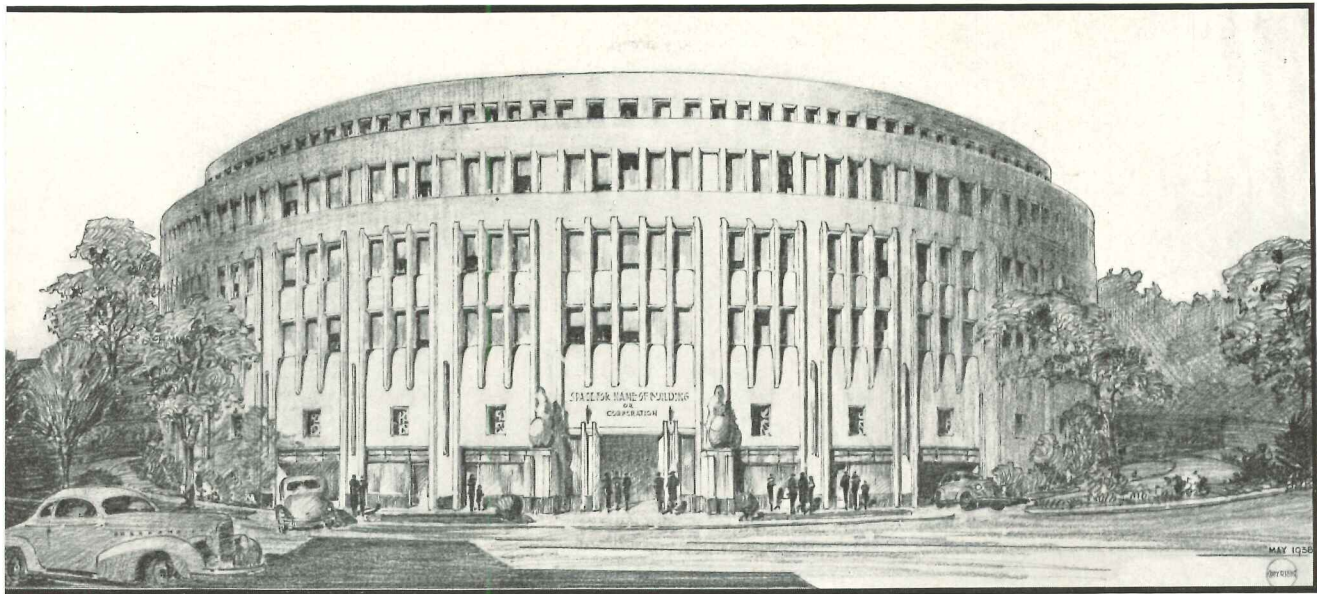

CIRCULAR OFFICE BUILDING PROPOSED FOR LARGE CORPORATION

F. RUCK, Architect, and ZARA WITKIN, Civil Engineer

THIS PROPOSED "office building for a large corporation" is designed for a specific Los Angeles site open to view on all sides. In principle, geometrically, the perimeter of a circle is the most rest, relative to enclosed space, there is a minimum wall and corridor area. It becomes easier to space elevators, stairs, and fire escapes uniformly to give convenient access from all parts of the building. Opera-

tional systems—plumbing, heating, ventilation, lighting, etc.—can be more efficiently laid out: there are no dead ends and waste spaces as in the "L", "U" or "E" types. Further, this is the strongest self-bracing structural shape against wind, earthquake and other lateral stresses. Identical exterior panels may be used all around the building. Construction plans include a scheme for pre-casting entire wall sections.

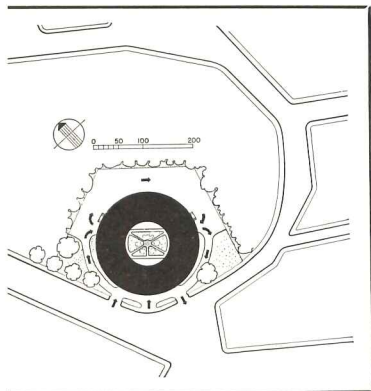

Site plan

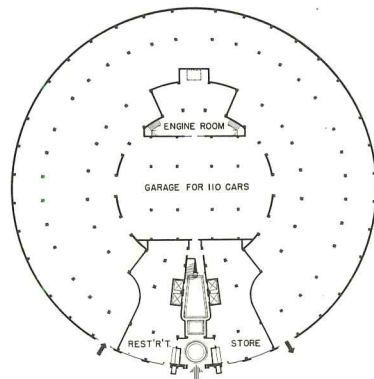

Ground floor

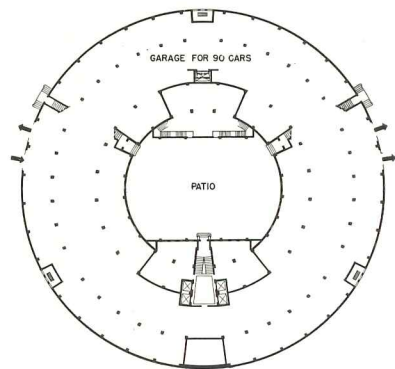

Mezzanine

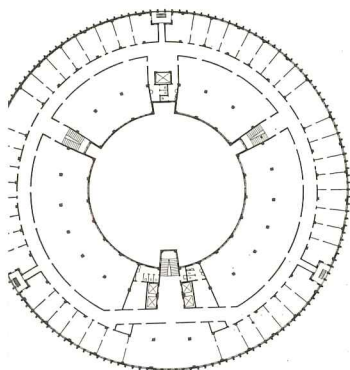

First and second floors

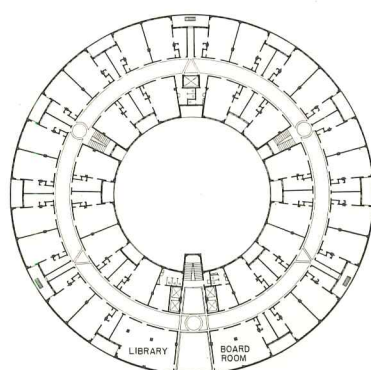

Third floor

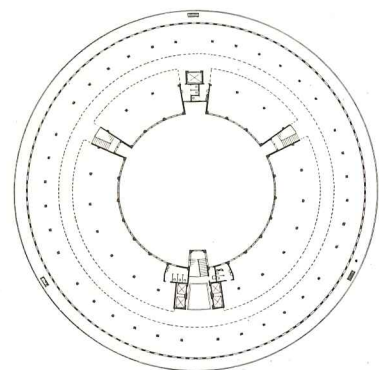

Fourth floor

Illustrations courtesy "The Architect and Building News"

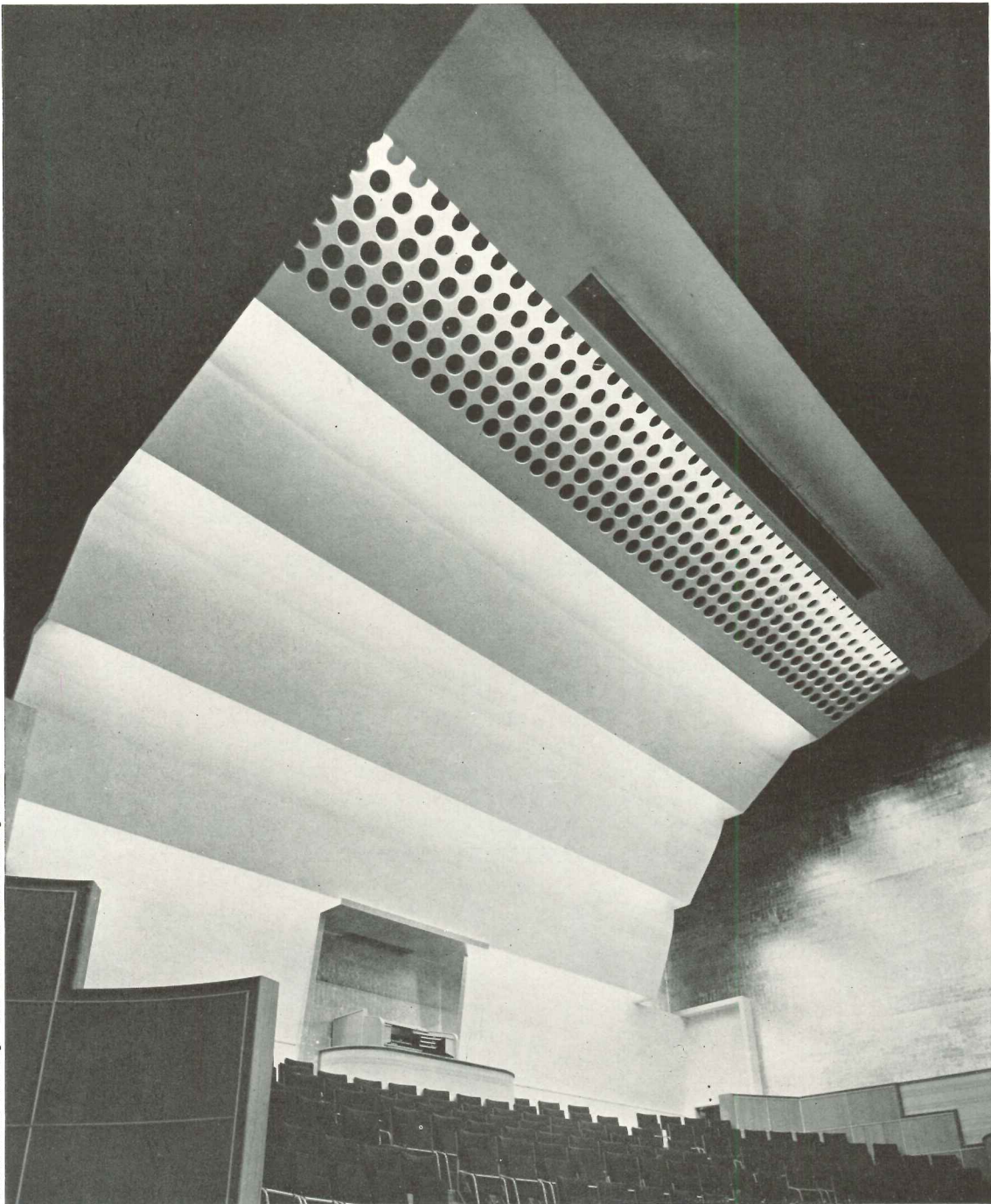

ACOUSTICAL HOOD FOR MULTIPLE-USE AUDITORIUM E. D. LYONS and L. ISRAEL, Architects

A MUNICIPAL AUDITORIUM recently opened in Wolverhampton, England, is to be used for organ, choral, and orchestral work, and by soloists and speakers. An acoustical hood placed over the proscenium has been designed to control the different reverberation-characteristics common to these different uses.

The hood is a light steel frame entirely suspended from the roof steel. It is composed of six planes at various inclined angles, with the upper part of each plane slightly concave

to broaden the sound waves. The openings in the two upper veins carry sound from the organ chamber behind and above the sounding board. In order to amplify the speaker's voice, "soft speaker cones" have been incorporated in the hood as well as in the auditorium ceiling and balcony soffits; these are controlled from a room at the rear of the balcony. The beams over the balconies are used acoustically to prevent "fluttering." There are floodlighting troughs in each plane.

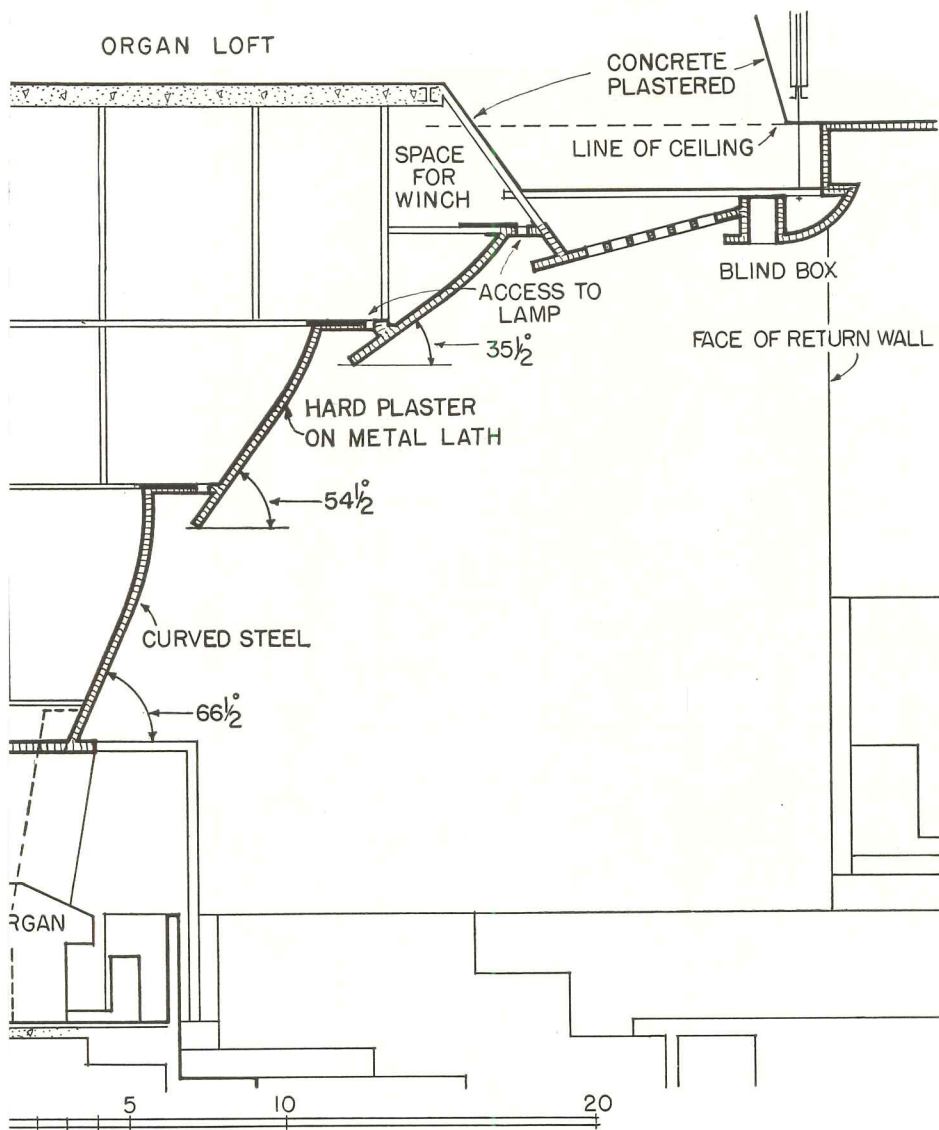

Section of acoustical hood

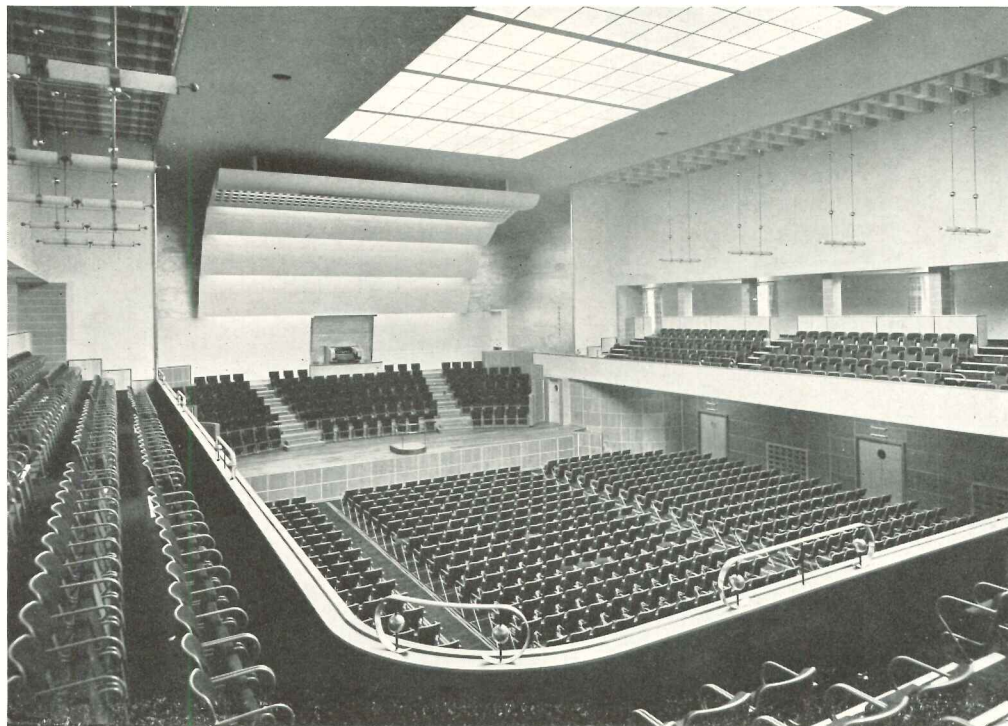

View of auditorium interior. Note ceiling beams and balcony; these aid in preventing fluttering.

Church in Southern California Built of Welded Steel Rods

Photos courtesy McLellan Steel-Frame Construction Co.

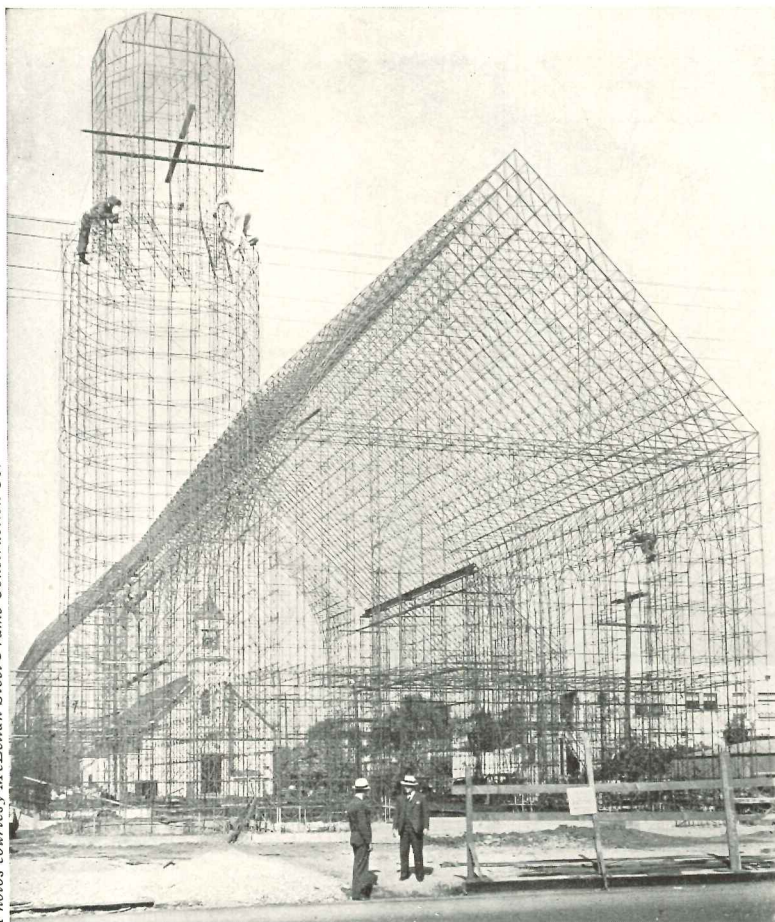

THE McLELLAN steel-frame construct a new system consisting entirely of round, steel rods, one-eighth to five-eighths of an inch in diameter, has recently been developed in Southern California. The structural frame is a network of rods welded—walls, roof, and floor joists—a single unit. All joints are arc-welded and tests are said to prove that these joints are stronger than the members joined.

The completed framework resembles birdcages, one slightly smaller than within the other, the two laced together with trusslike cross-bracing. Air space between exterior and interior wall surfaces acts as heat insulation.

The structure is exceptionally strong and light, its weight only about one-third of a corresponding wooden frame. It is designed as a "compensating" framework in which all loads are widely distributed over the structure, and the design takes advantage of the superior strength of steel in tension.

Sidewalls are prefabricated in panels of single-story height. These panels consist of vertical studs, diagonally braced and held in position by horizontal tie rods.

The studs are composed of two vertical chord members, braced to form a continuous truss and stiffened with horizontal cross rods. Diagonal cross-bracing in any stud is a continuous rod, bent in sawtooth fashion, extending from top to bottom of the stud, and bound, at the junctures with the vertical chords, by horizontal cross rods. Horizontal tie rods between studs are continuous across the panel. The diagonal cross-bracing within panels is continuous from one corner to the other and is bent in sawtooth fashion for stiffening. The truss in each panel, in itself, is a truss.

Floor and ceiling joists are identical and are similar in construction to the wall studs.

Panels are joined together, to form walls, by sleeve connections encircling protruding ends of rods; these sleeve joints are electric-welded after panels have been set in place. Bottoms of wall panels are welded to angle-irons resting on foundation walls; the angle-irons, in turn, are welded to anchor bolts set into the foundation.

When the framework has been completed, both surfaces are covered with masonry lath stitched to the frame. Concrete is pneumatically applied to the exterior surfaces, plaster or other appropriate finish to the interior. Floors are laid over an insulation of fireproof material. The structure is resistant to fires, earthquakes, and term

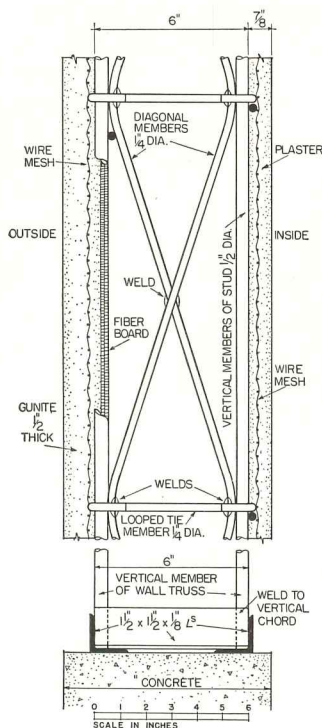
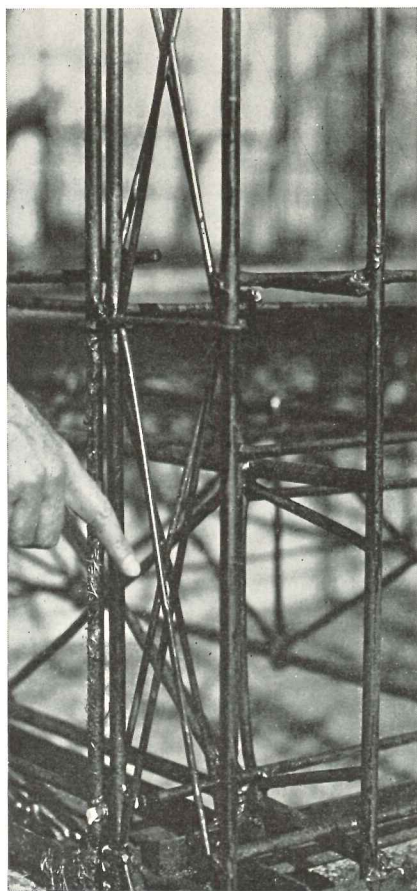

Angle-irons holding wall panels are welded to anchor bolts set into the concrete foundation.

Research Program into Low-Cost Constructions Announced

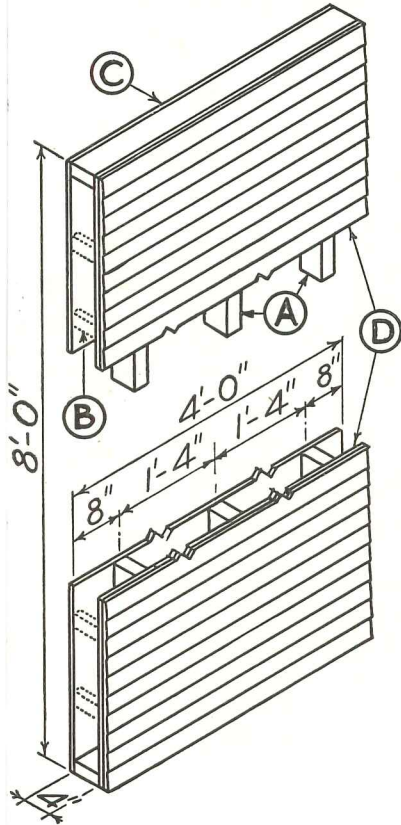

Typical wall specimen

A, three wood studs (2 x 4 in.); B, wood blocks to support the edges of the faces, optional with sponsor; C, inside face (lath and plaster); D, outside face (wood sheathing, paper, and lap siding).

PRICE OF LOW-COST HOUSE CONSTRUCTIONS*

Element	Max. price per sq. ft.
Wall and load-bearing partitions; including weatherproofing on outside face of the wall and the finish on inside face of the wall and on both faces of the partition.....	\$0.60
Partition, nonload-bearing; including finish on both faces.....	.35
Floor; including finish floor on upper face and ceiling (if any) on lower face.....	.75
Roof; including weatherproofing on upper face and ceiling (if any) on lower face.....	.60

Prices as of July 1937 of each element, as used in a house delivered in Washington, D. C.; higher-priced constructions will not be included in the program.

A REPORT recently issued by the Bureau of Standards describes the earliest results of a program of research into the properties of various building materials and their suitability for low-cost housing. This program was undertaken last year, under a grant of Congress, by a staff committee of the Bureau. (See AR, 10/38, p. 34.)

Until quite recently, tests on the structural qualities of houses have been largely of the trial-and-error sort. Inefficient constructions and constructions unnecessarily strong or expensive have been replaced only very gradually. To speed up the industrialization of housing, it has become essential to employ research methods common to the more advanced industries; and here there were several alternatives.

First, house structural systems in actual service might be observed over a period of years; but this would take a long time and the information obtained would be relatively indefinite. More precise results could be obtained by applying known loads to complete houses and then measuring their effect. But this, too, would require much time and would, in addition, be very expensive. Moreover, only the weakest element of a particular house could be tested by this method: for instance, if loads were applied to the second floor of a house to determine its strength, and if the walls crushed before the maximum load for the floor was applied, another house with stronger walls would have to be tested.

To the members of the Bureau committee it has seemed more practicable to test "elements" of a finished house—floors, walls, roofs, etc. Results of such tests will probably approximate more closely to those obtained on a complete house than would the results of tests on the separate materials of which the house was fabricated. This simplification and enlargement of the "building unit", if only for testing, is symptomatic of increasing industrialization in the building industry.

The Bureau has asked for specimens, which it has agreed to test without charge. An attempt will be made, in this way, to coordinate the experience of organizations, archi-

tects, engineers, and other individuals, so that it will be most useful to those concerned with the design or fabrication of houses, particularly low-cost houses.

So that the results of various tests may be as comparable—and hence as useful—as possible, the Bureau has formulated a number of rules for the submission of specimens for testing. Specimens should not be fabricated until the Bureau has agreed to include the construction in the program.*

For any or all of the four elements of a house—wall, partition, floor, and roof—one or more low-cost constructions may be chosen. Dimensioned drawings and a complete description of each element must be submitted; all available information which will identify the materials or units in the construction should be included. Drawings and information will be used to determine whether or not the construction will be used in the research program. (Specimens should not exceed in price the values given in the table in the left-hand margins.)

Specimens should be as large as practicable so that the effect of variations in material and workmanship may be minimized, and so that the results obtained may be representative of constructions in actual houses. Obviously, the size of specimens is limited by the size of testing machines available. The following sizes have been decided upon:

Wall: 15 specimens: height, 8 ft.; nominal width, 4 ft.† (480 sq. ft.).
3 specimens: height, 8 ft.; nominal width, 8 ft. (192 sq. ft.). Total area, 672 sq. ft.

Partition: 3 specimens: height, 8 ft.; nominal width, 4 ft. (480 sq. ft.)

Floor: 6 specimens: length, 12 ft. 6 in.; nominal width, 4 ft. (300 sq. ft.).

Roof: 3 specimens: length, 14 ft. 6 in.; nominal width, 4 ft. (174 sq. ft.).

Further information on this program of research may be found in Report BMS2 by Herbert L. Whittemore and Ambrose H. Stang. It is for sale by the Superintendent of Documents, Washington, D. C., at 10 cents.

*The Bureau of Standards will test only "elements" of completed houses: an element is defined as a "portion of the completed house ready for occupancy having one primary function, for example, a floor or wall." "This Bureau does not test building units or members such as brick, concrete block, open bar joists, etc., for the public, if such tests can be made in the materials-testing laboratories of commercial organizations and technical schools."

†The greatest width which can be tested is 6 ft.

WITH THE PROFESSION

Prize Competition for Design of Theater Announced

FOLLOWING CLOSE on the heels of the recent Wheaton and Goucher College contests, another competition for the design of a college building—"A Festival Theater and Fine Arts Building"—begins with the publication of this notice in ARCHITECTURAL RECORD. The awards will total \$1,500: first prize, \$500; second prize, \$300; third prize, \$200; and five citations of \$100 each. The competition is sponsored by The American National Theater and Fine Arts Academy, assisted by the Museum of Modern Art.

The competition problem is the design of a festival theater, with all the facilities necessary for dramatic productions, opera, motion pictures, etc.; in addition, the building is to house the activities of a college Fine Arts Department. There is no contract to be awarded; but, to make the problem as specific as possible, the site for the project will be considered to be a portion of the campus of the College of William and Mary.

Any architect, designer, engineer, or draftsman residing in the United States, except employees of ARCHITECTURAL RECORD or the Museum of Modern Art, is eligible to compete. The sponsors have invited five architects to enter the competition, guaranteeing them a remuneration of \$400 each. These architects are Goodwin & Stone, New York, N. Y.; Walter Gropius, Cambridge, Mass.; Michael Hare, New York, N. Y.; Harrison & Fouilhoux, New York, N. Y.; Richard Neutra, Los Angeles, Calif. But all designs will be judged at the same time and will remain anonymous until after final judgment.

The competition closes January 31, 1939. The names of the jurors—three architects, a theater expert, and an educator associated with the Fine Arts—will be announced February 14, 1939, at which time the judgments will begin. Prize-winning and other selected designs will be published in ARCHITECTURAL RECORD.

Entry blanks can be obtained from the professional adviser, Kenneth K. Stowell, AIA, care of Architectural Record, 119 West 40 Street, New York, N. Y.



S. Fraser McIntosh



Myron T. Hill

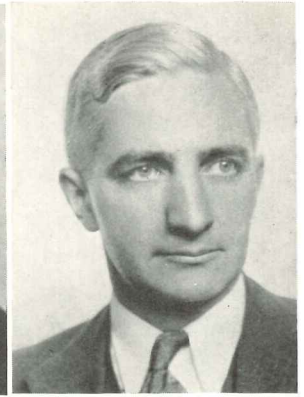

Waldron Faulkner

Winners of \$200,000 Prize Competition Announced

THE WINNERS of the \$200,000 prize competition of the James F. Lincoln Arc Welding Foundation have recently been announced. This competition, begun early in 1937, was judged by 31 engineering authorities from leading universities and colleges throughout the country. Thousands of papers were submitted and subjects of study in the 44 divisions of the Program represented almost every section of industry. The Central Committee of the Jury of Award, after discounting some very enthusiastic claims, found that savings to industry by arc welding, estimated by authors of papers, amounted to \$1,600,000,000.

Awards of \$712, \$508, \$305, \$203, and \$152 were received by designers of steel-framed houses. These, the first five awards in the house division of the Program, went respectively to S. Fraser McIntosh, presi-

dent, Insulated Steelbilt Structures Inc., Amsterdam, N. Y.; Myron T. Hill, architect, Toledo, Ohio; Waldron Faulkner, architect, Washington, D. C.; E. W. Burgess, engineer Milwaukee, Wis.; E. H. McClintock designer, and T. K. O'Connor, fabricator, Springfield, Mass.

The paper by Mr. McIntosh "Steel-Framed Dwellings", features a system of construction using shop fabricated welded steel units. Myron T. Hill describes an attempt to design a logical steel frame. Waldron Faulkner describes and gives detail plans for construction of a welded steel-frame house. Mr. Burgess paper, "Steel Frame Structures", describes a pressed thin steel plate shaped into ribs to be used as floor

In brief form, these and other papers are available from the James F. Lincoln Arc Welding Foundation Cleveland, Ohio.

Exhibition of Post-War Architecture to Travel Through U. S.

THE "NATIONAL EXHIBITION of Representative Post-War Architecture", the first of its kind ever to travel throughout America, will be seen, during the coming year, in more than a score of cities all over the country.

The Special Exhibits Committee and the Committee on Education of the American Institute of Architects have selected and assembled the material, and the American Federation of Arts will exhibit it.

The exhibit consists of photographs, plans, notes, and details of 150 buildings; an attempt was made to choose "representative" buildings, irrespective of style or architect.

All places on the exhibition circuit have not been definitely decided upon, but the following are scheduled: National Collection of Fine Arts, Washington, D. C.; Harvard University; Massachusetts Institute of Technology; Baltimore Museum of Art; New York City; Yale University; Princeton University; University of Pennsylvania; Addison Gallery, Andover; Montclair; Chicago; Memphis; Detroit; Beloit College; Kansas State; University of Minnesota; other Western cities are to be announced later.

Headquarters of the American Federation of Arts are in the Barr Building, Washington, D. C.

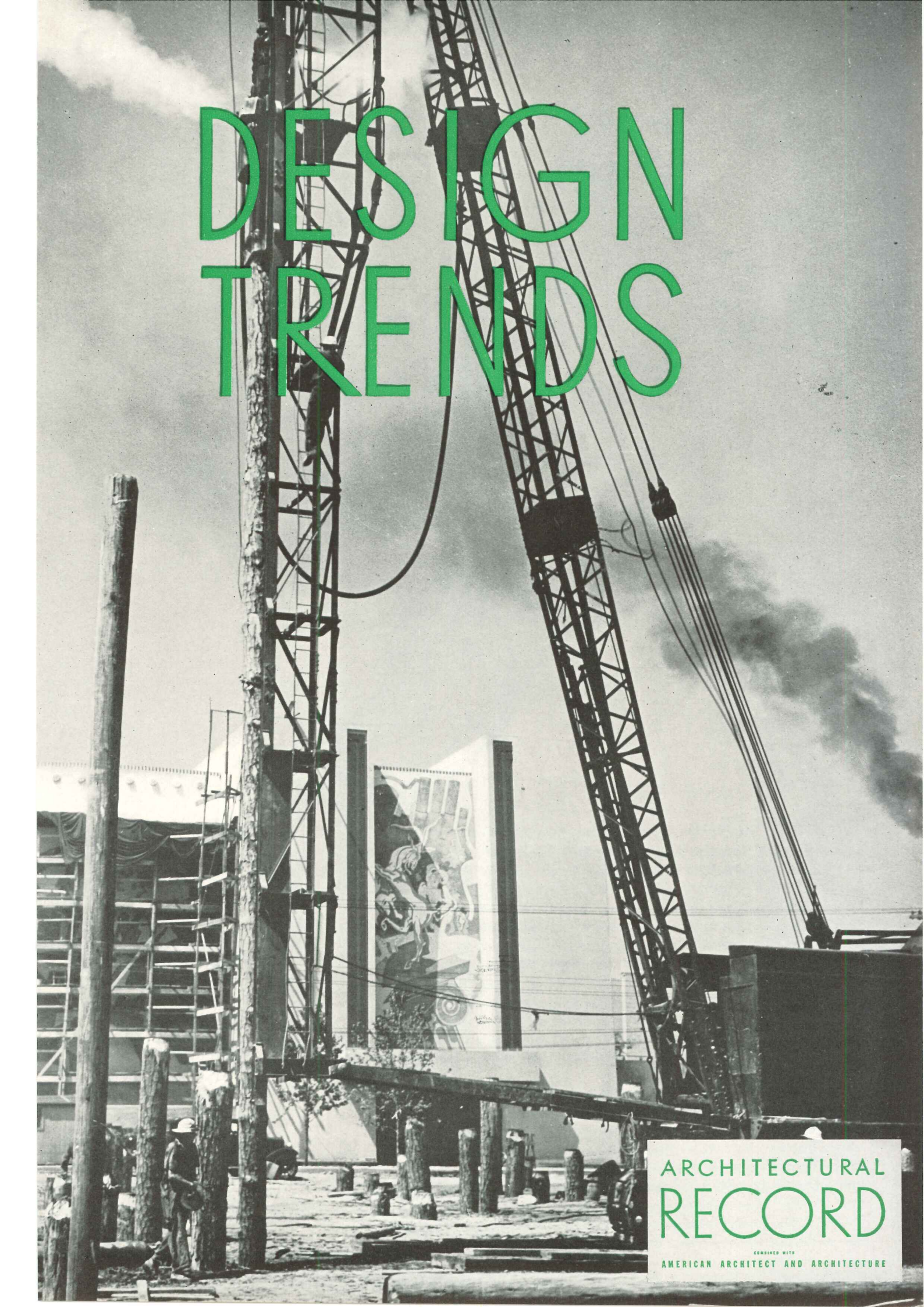

DESIGN TRENDS

ARCHITECTURAL
RECORD

COMBINED WITH
AMERICAN ARCHITECT AND ARCHITECTURE

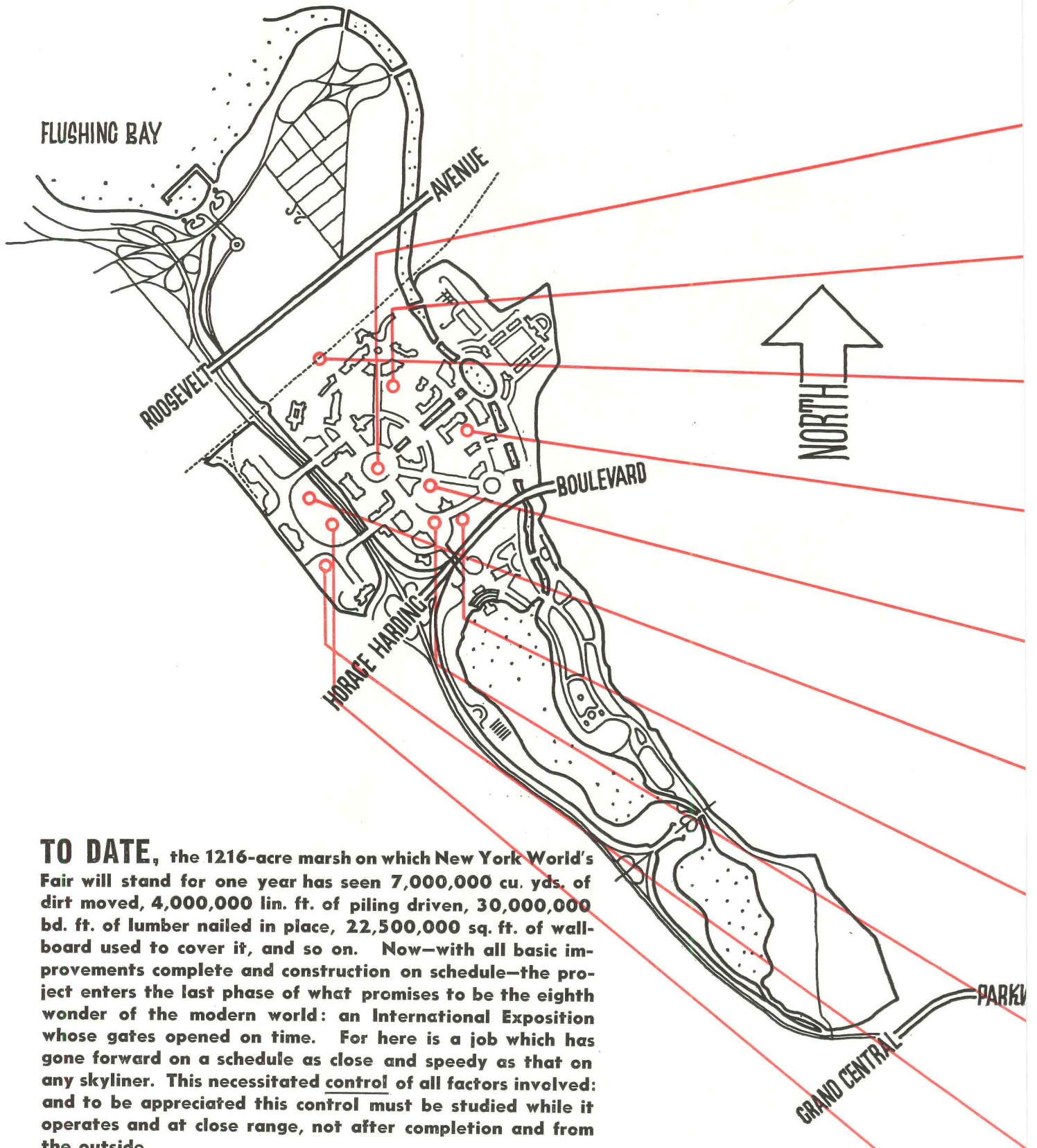

TO DATE, the 1216-acre marsh on which New York World's Fair will stand for one year has seen 7,000,000 cu. yds. of dirt moved, 4,000,000 lin. ft. of piling driven, 30,000,000 bd. ft. of lumber nailed in place, 22,500,000 sq. ft. of wall-board used to cover it, and so on. Now—with all basic improvements complete and construction on schedule—the project enters the last phase of what promises to be the eighth wonder of the modern world: an International Exposition whose gates opened on time. For here is a job which has gone forward on a schedule as close and speedy as that on any skyliner. This necessitated control of all factors involved; and to be appreciated this control must be studied while it operates and at close range, not after completion and from the outside.

But expositions are scarce and—like lightning—seldom strike twice in the same spot; consequently, the average architect seldom designs one. Thus, ARCHITECTURAL RECORD here previews not the Fair as a whole but only some of those buildings, systems, and equipments which point to higher production standards, and which have application to many building types other than exposition structures.

All photographs, except where noted, were specially taken for ARCHITECTURAL RECORD by Jean St. Tomas.

NEW YORK WORLD'S FAIR - - - 1939

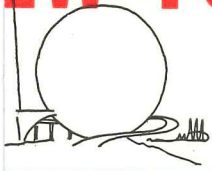

PAGE

1. PERISPHERE AND TRYLON 66



2. GAS EXHIBITS, INC. 69



3. LONG ISLAND RAILROAD STATION 70

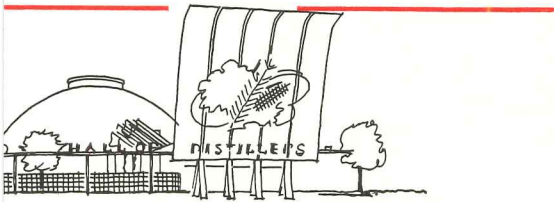

4. DISTILLED SPIRITS, INC. 72

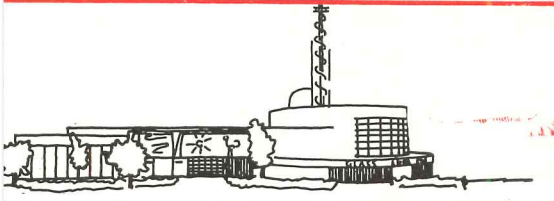

5. GLASS, INC. 75



6. GENERAL MOTORS 76

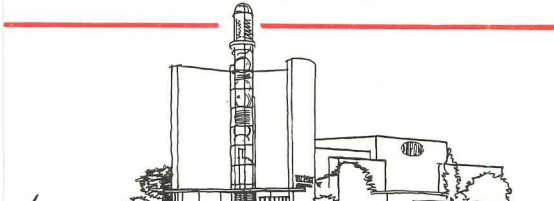

7. E. I. DUPONT DE NEMOURS & CO. 78

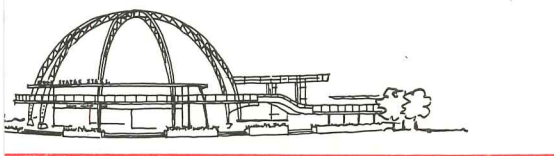

8. UNITED STATES STEEL 80

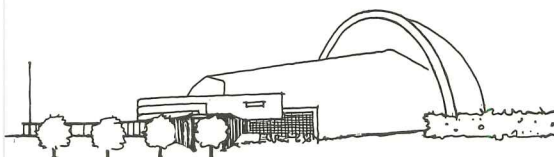

9. AVIATION BUILDING 82

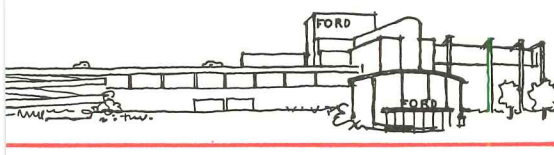

10. FORD MOTOR COMPANY 84

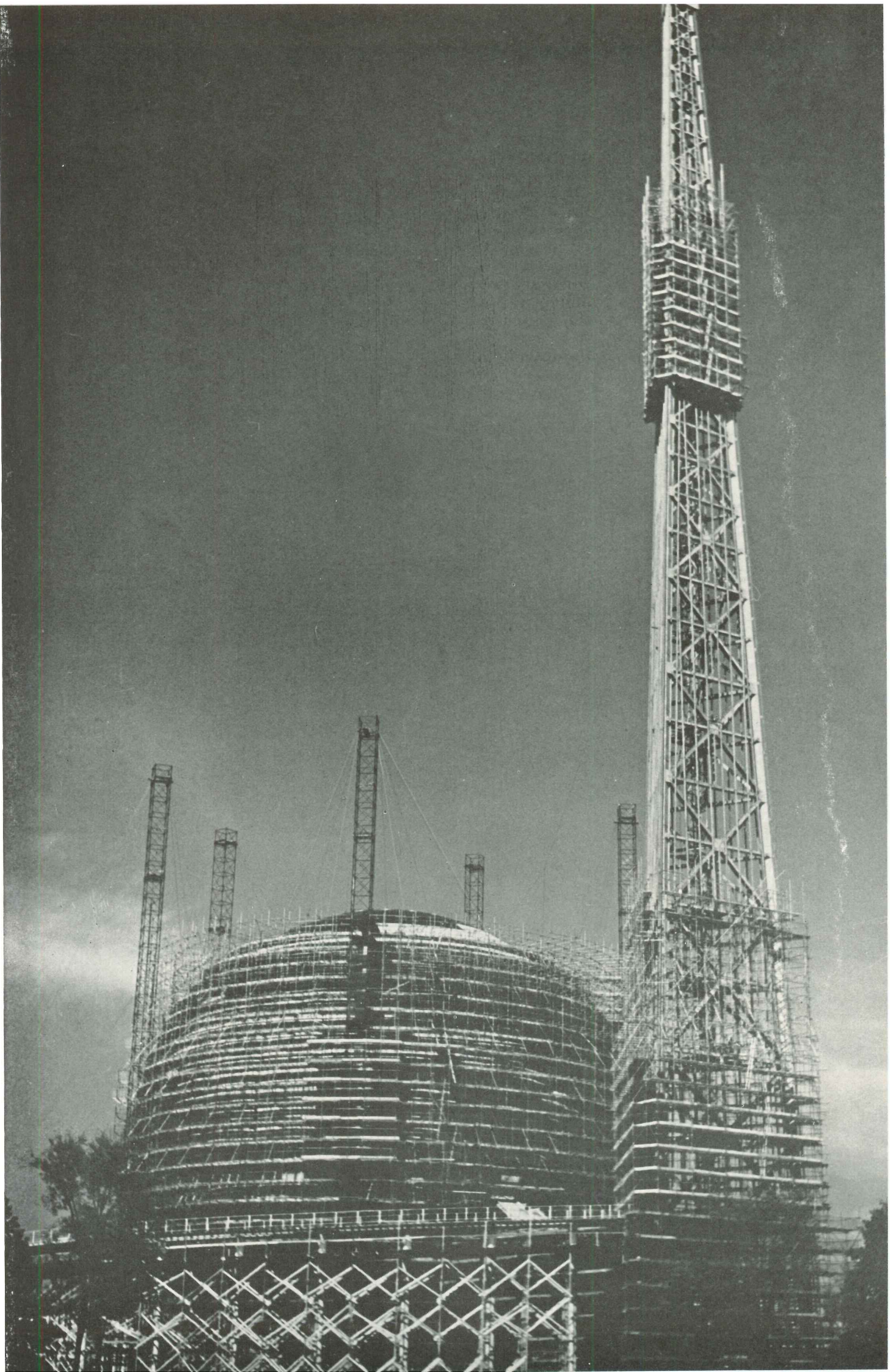

TRYLON, PERISPHERE, HELICLINE

ARRISON and FOUILHOUX, Architects

ENRY DREYFUSS, Designer

DRAN, PROCTOR & FREEMAN, Foundation Engineers

ORTRIDGE HARDESTY, Structural Engineer

135 SKETCHES were discarded before the present design for the Fair's Theme Center was finally accepted; and the problem had just begun. The design process was difficult, since no precedence existed for such structures, and an entire series of tests had to be tried on to determine the characteristics of such structures under loads, wind pressure, etc. Nor were erection and erection problems any simpler; extraordinary standards of precision had to be maintained throughout. This led to the development of a novel rigging set-up; of cantilevered scaffolding outside and rotating scaffolding inside the Perisphere; of a new material to surface the structures; etc. Yet, in spite of its complexity, the entire job is on schedule, with only one minor injury—"a crushed toe-nail".

As finally constructed, the Perisphere rests on a circle of 528 piles driven into sand about 100 ft. below the surface: these piles are capped with a concrete ring. From this foundation eight columns support a large ring girder 72 ft. in diameter; and from this girder spring 32 meridian trusses similar to the lines of longitude on a globe. These in turn are joined together by 15 horizontal trusses. Smaller purlins complete the assemblage. The Trylon and Helicline are more usual design and presented no such problems as the Perisphere.

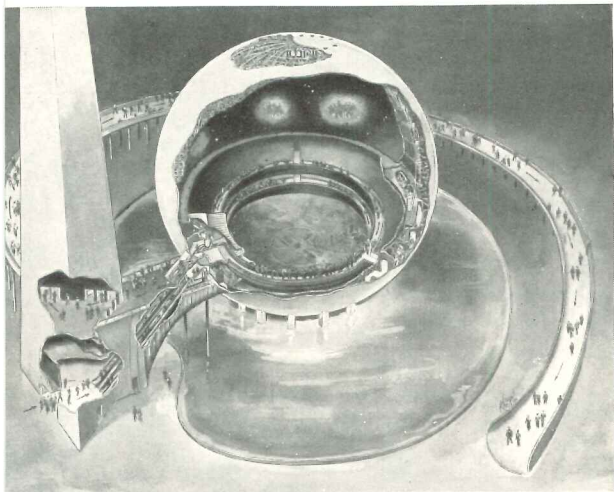

Two giant escalators (lower left) spill 8,000 persons per hour onto two circular platforms (center); moving in opposite directions, these platforms make complete circuit in 5½ min., where barrier deflects traffic onto helicline (left, center).

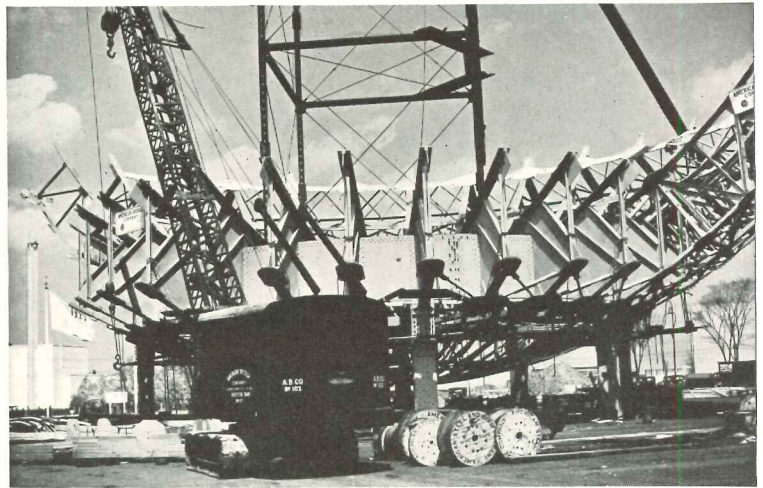

ERECTION required specially-designed rigging system

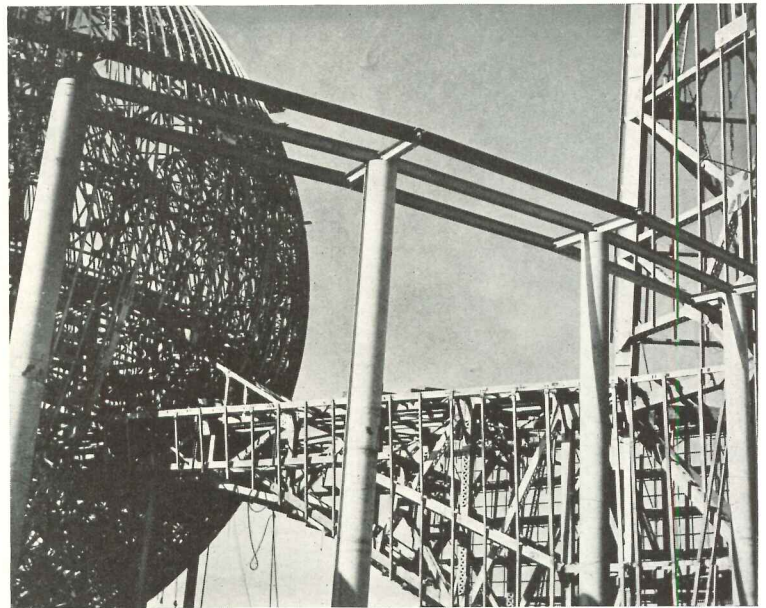

FRAMING: 7,125 pieces of shop-fitted steel in proper place

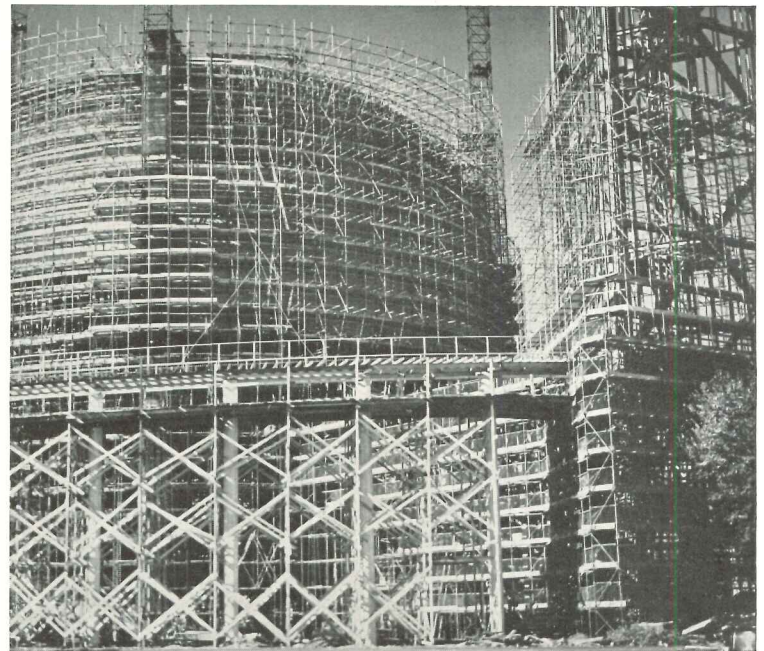

SCAFFOLDING so complex that separate bids were taken on special scaffolding design.

Drawings by Kautsky: photographed by Louis Dreyer

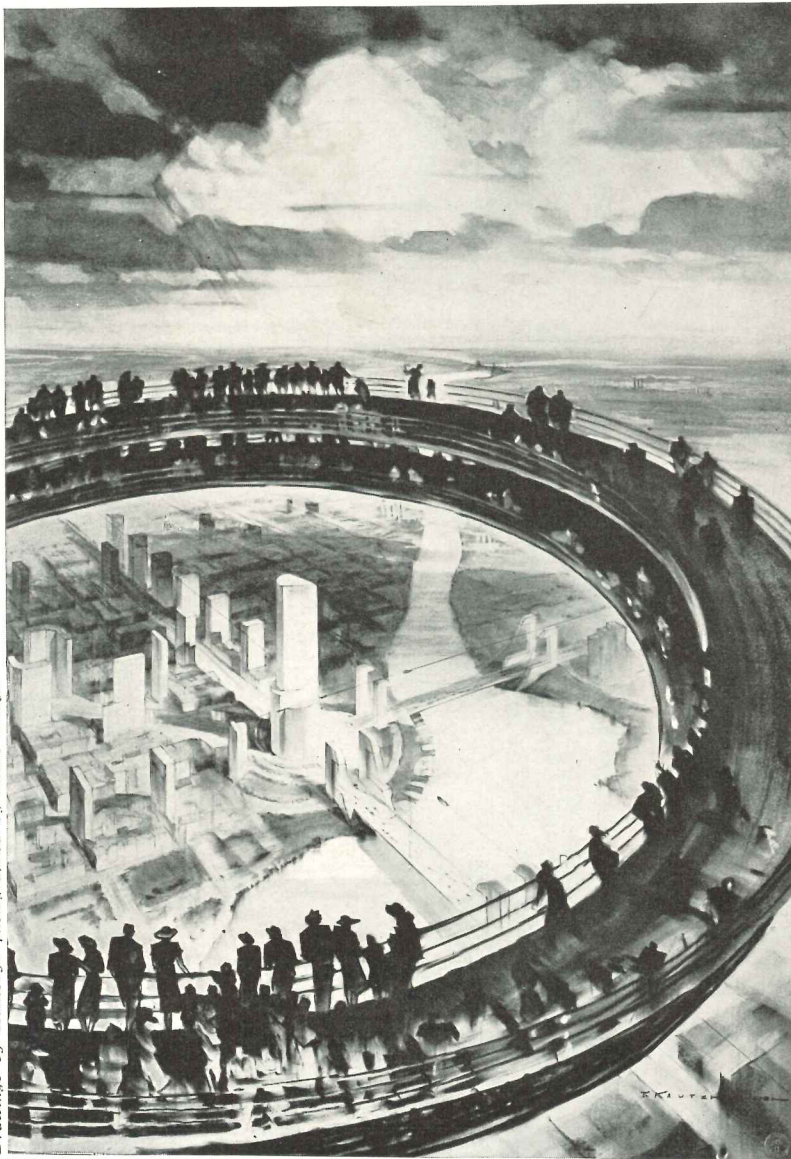

Sketch showing relation of spectator to Perisphere's huge diorama of Town of Tomorrow.

DRAMATIZATION of the Perisphere's thematic display, "Building the World of Tomorrow", was the task of designer Henry Dreyfuss. While the accepted design for the Perisphere is essentially that for a theater—with a slowly moving audience in the center and "show going on above it, below it, and all around it"—the design involves many problems in traffic, display, lighting, acoustics, etc., not found in the usual theater. The central task of the designer was therefore to integrate a number of specialized fields into a theater for which there was no single precedent.

The central display—a scale model of a city which incorporates current standards of town and regional planning—will occupy the bottom of the sphere; by means of the diorama technique, it will merge into the walls of the sphere. Lighting effects—not only in the model itself but on the entire inner surface of the sphere—will then reproduce a 24-hour day—clouds, stars, sunrise, and sunset—compressed into 5½-min. cycles. Spectators on the rotating platforms will thus get the illusion of moving freely through space. Elaborate sound effects are also planned.

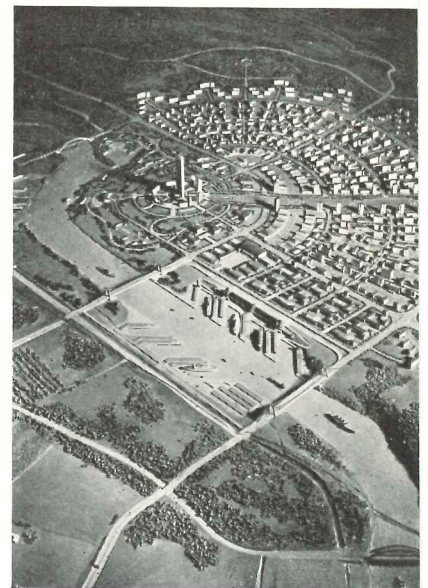

Preliminary model: "Democracy"

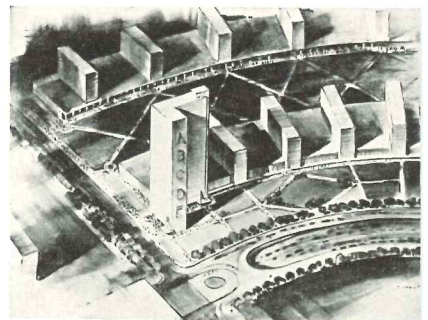

Tomorrow Town's Democracy's retail shops



Democracy's sports center

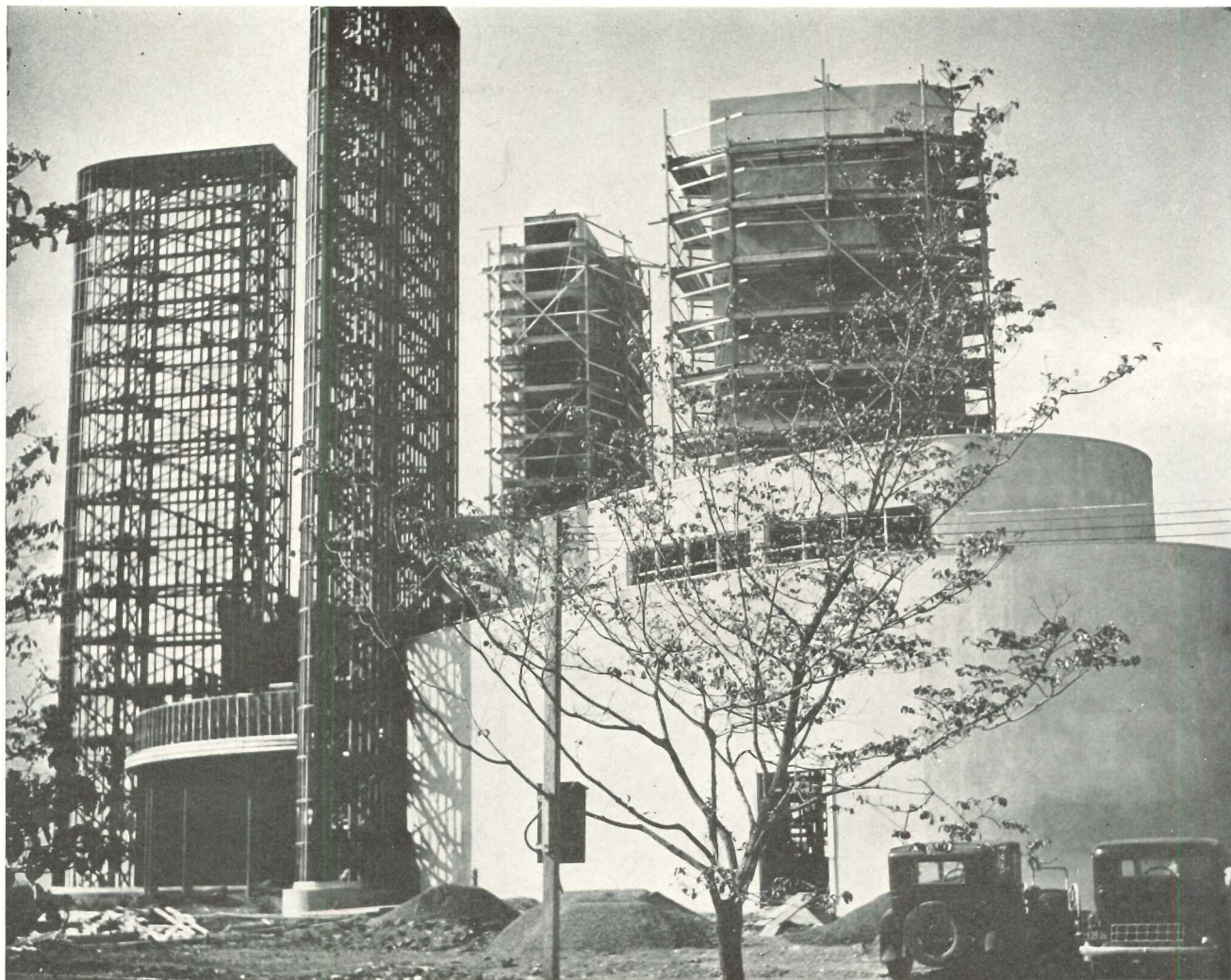

GAS EXHIBITS, INC.

SKIDMORE & OWINGS, Architects
JOHN MOSS, Associate

CONCORDED jointly by 169 gas companies in America and Canada, this is a single-structure for display of gas appliances for cooking, heating, and air conditioning. Chief external feature is the circular "Court of Flame", flanked by pylons, in which a (gas) flame will burn continuously. One end of the structure is occupied by a 350-seat theater for demonstration purposes.

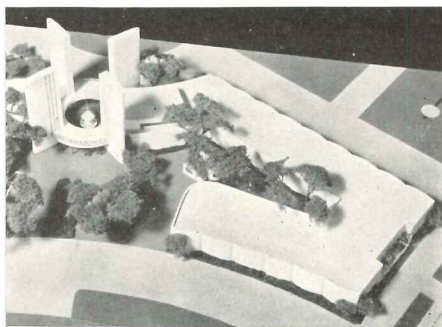

Model

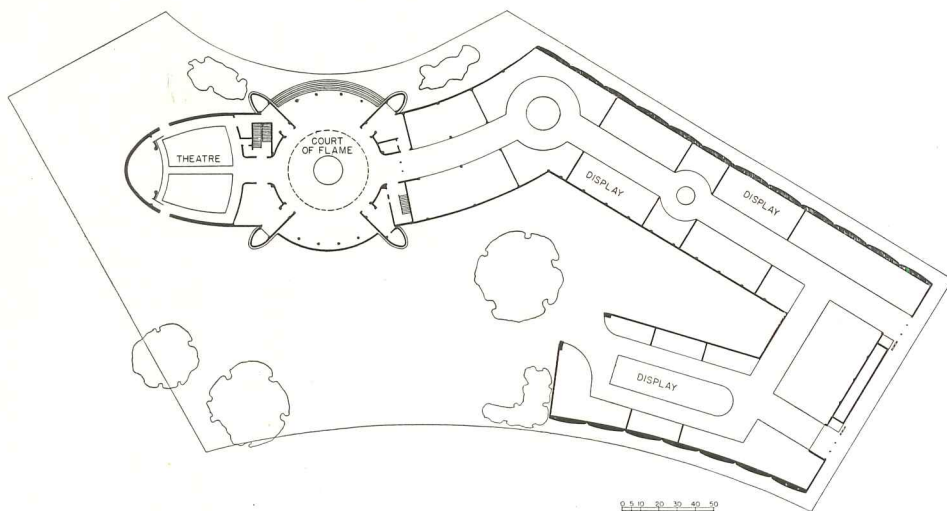

Plan

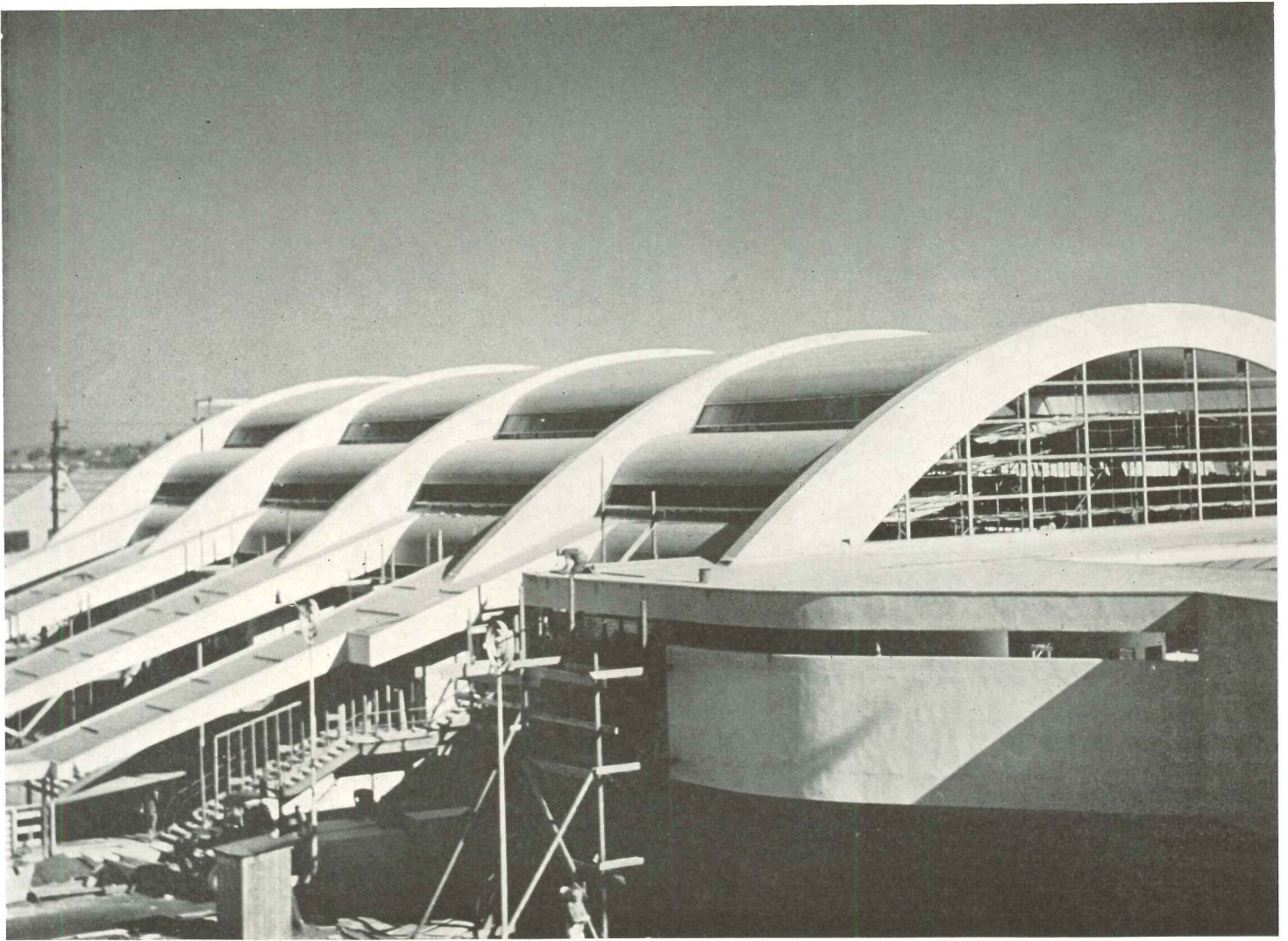

3. LONG ISLAND R. R. STATION

FAIR CONSTRUCTION DEPARTMENT, Designers

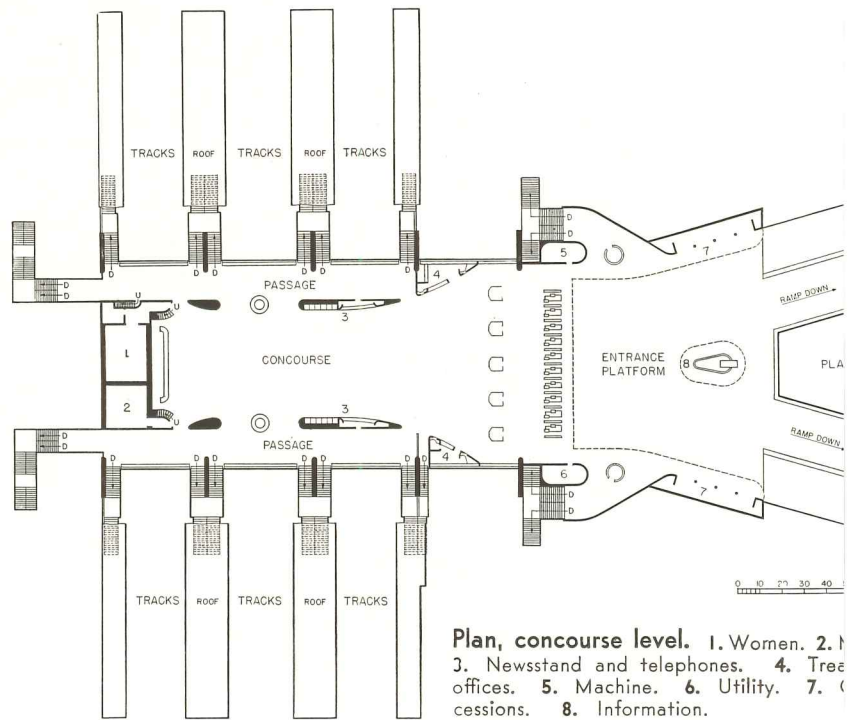

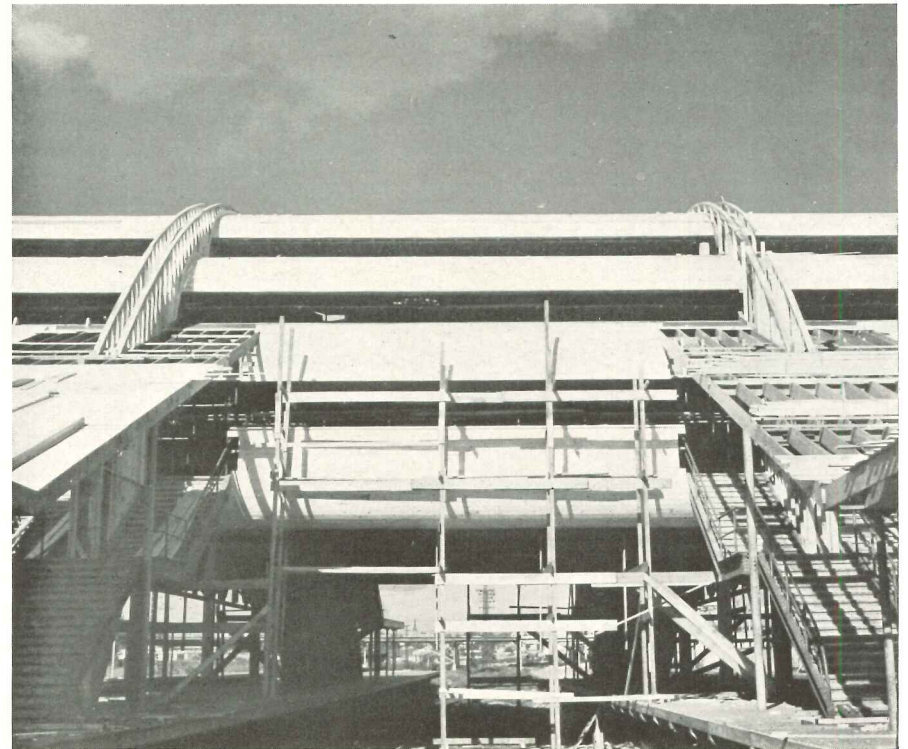
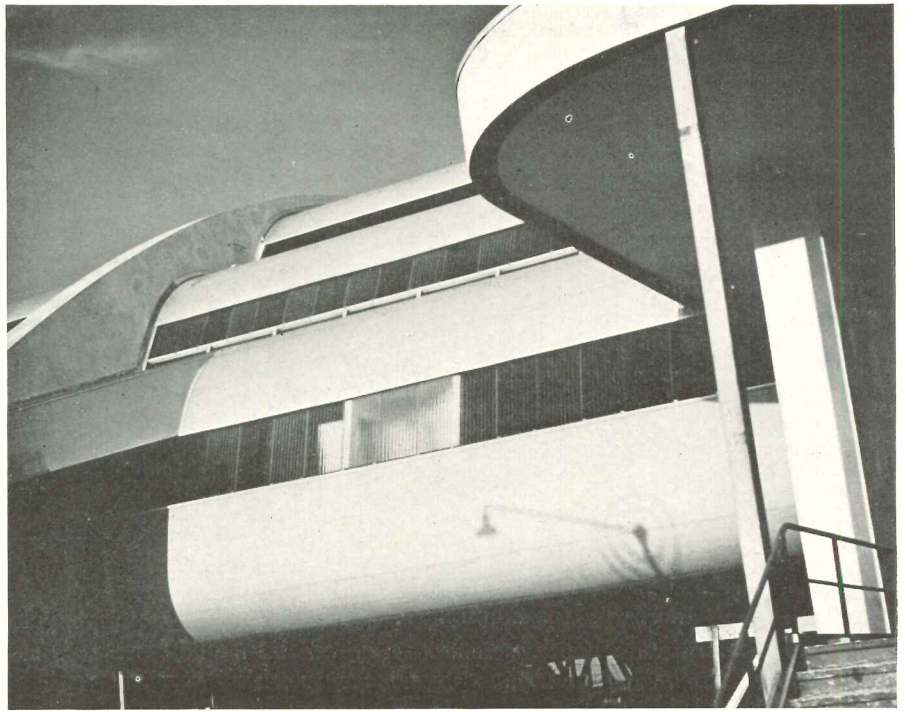

BOTH PLAN and construction, the Long and Railroad Station is one of the Fair's most notable structures. Although frankly temporary in character (and consequently fireproof in construction), it indicates new standards for a common design problem—that of the busy suburban station. A real descendant of the old "covered" bridge, the station is actually a wood-and-steel bridge carried by five transverse (other than lateral) arch trusses. This basic concept yields not only an economical design and construction, but also an appropriate aesthetic quality. Thus certain elements *look like trains* (top, right) without any sense being representational.

Although the station is essentially steel-framed, there is a wide and novel use of wood. With only the trusses and end walls completed, the rest of the shell is wood-plated and canvas covered. In the continuous clerestory fenestration, windows and window frames have been eliminated; the corrugated glass strips thus become an integral part of the envelope. The clerestories are also designed so as to serve as source of both natural and artificial light (section, below).

The location of the station is fortunate, from the standpoint of visitors; ramps from the course level give directly into one of the Fair's secondary plazas; and the station is easily flanked by exhibit buildings so that the visitor finds himself inside the Fair immediately upon leaving the station.

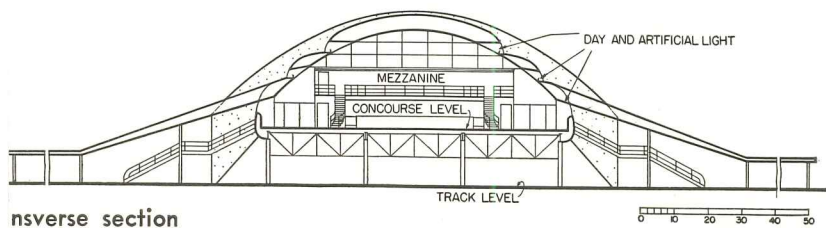

transverse section

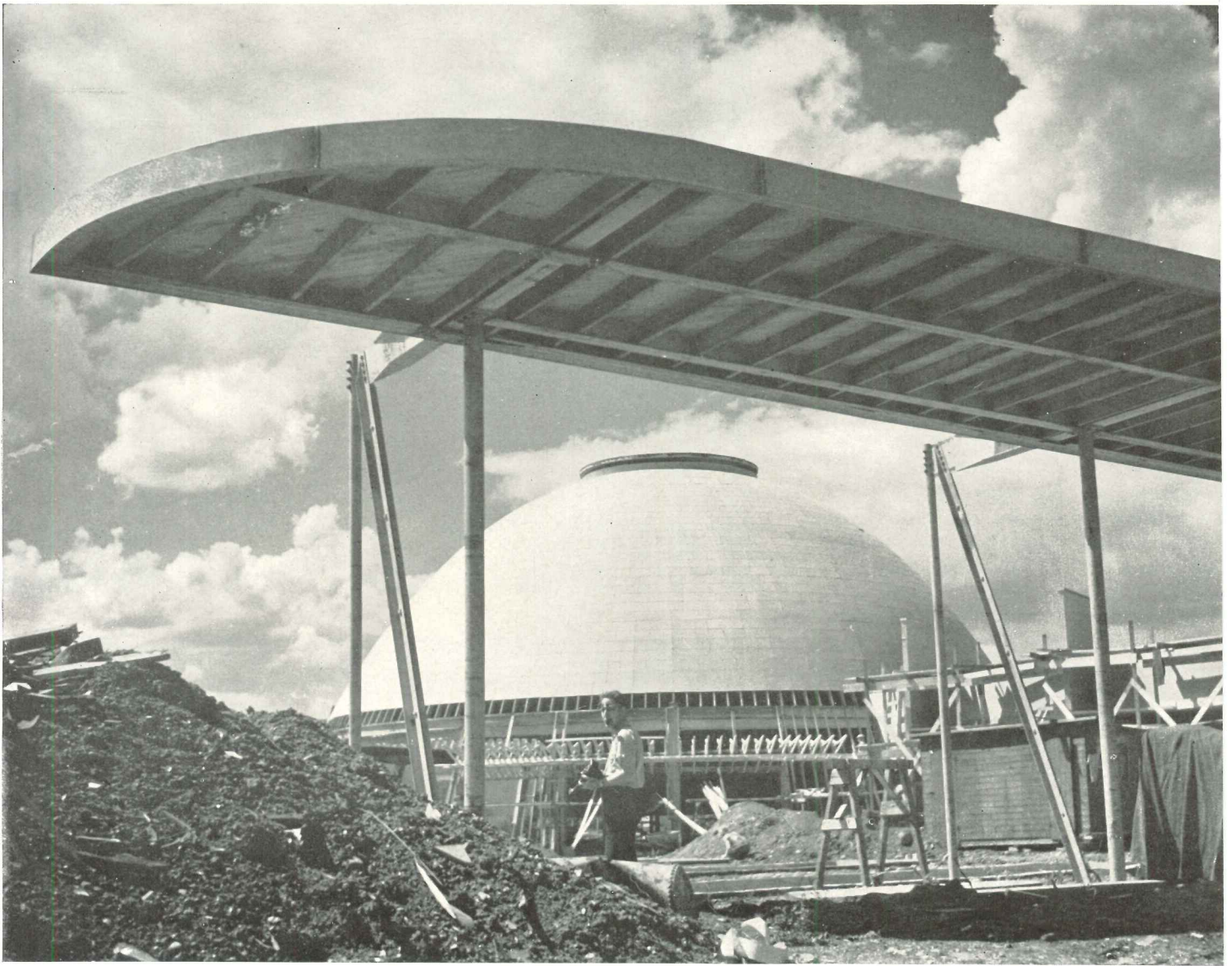

4. DISTILLED SPIRITS, INC.

MORRIS B. SANDERS, Architect
 ROSS-FRANKEL, INC., and
 MORRIS B. SANDERS, Co-designers

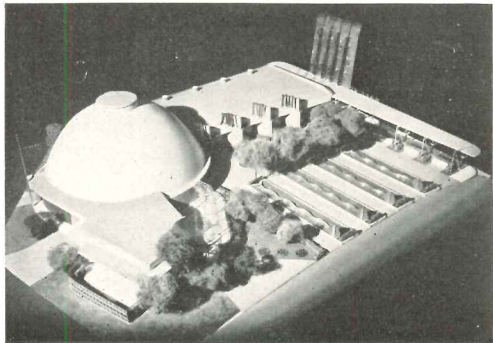

Richard Garrison

Model

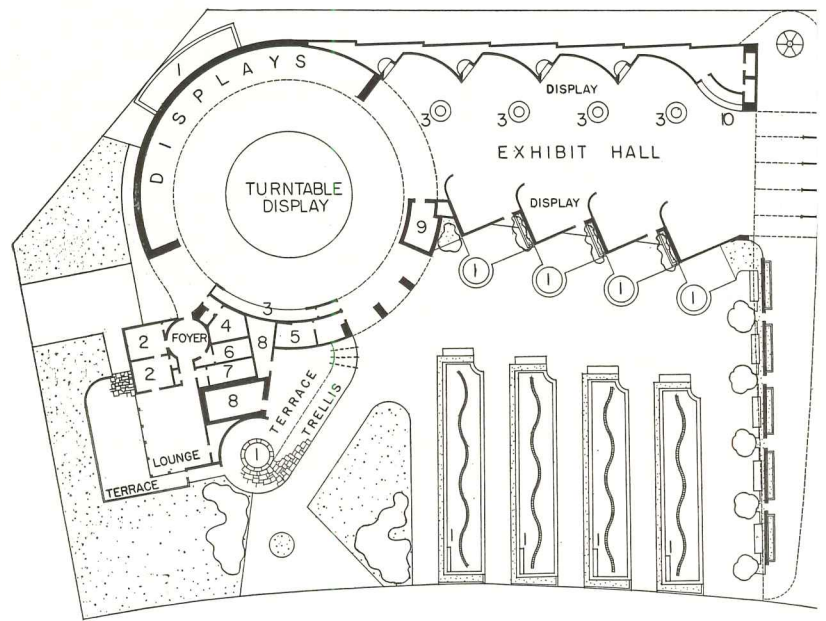

Plan. 1. Fountain. 2. Office. 3. Display. 4. Men. 5. Women. 6. Women employees. 7. Men employees. 8. Electrical room. 9. Utility. 10. Information

THE DISTILLERS' building not only lists an unusually wide range of structural and finish materials—steel, glass, wood, metals—but also various applications of many of them. The steel framing of both canopy (top, left) and marquee (right) is unusual. In the former, a cantilever is achieved by means of diagonal bracing and an anchor-type footing (see Foundations, page 100). In the marquee, the 40 ft. vertical members become a decorative feature of the entrance, their perforated webs lightening the construction actually as well as aesthetically. In its finished form (right, below) this marquee will be faced with corrugated enamel sheets, on which a free-standing sign in sheet metal and composition will be applied. Corrugated and block glass are widely used in the garden, both for decorative (see pools, over page) and utilitarian purposes.

Exhibit material—which is industry-wide and with no brand or company advertising—is organized into two main halls, the second one entered by a revolving turntable. Lounge, terrace, and dressing rooms for exhibit members are grouped along one end, while the garden (bottom, over page) occupies a large proportion of the remaining ground area.

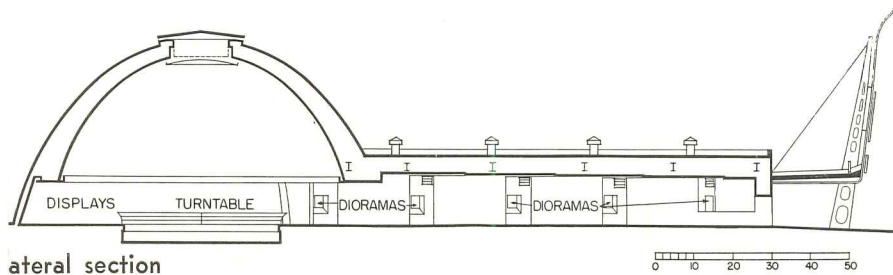
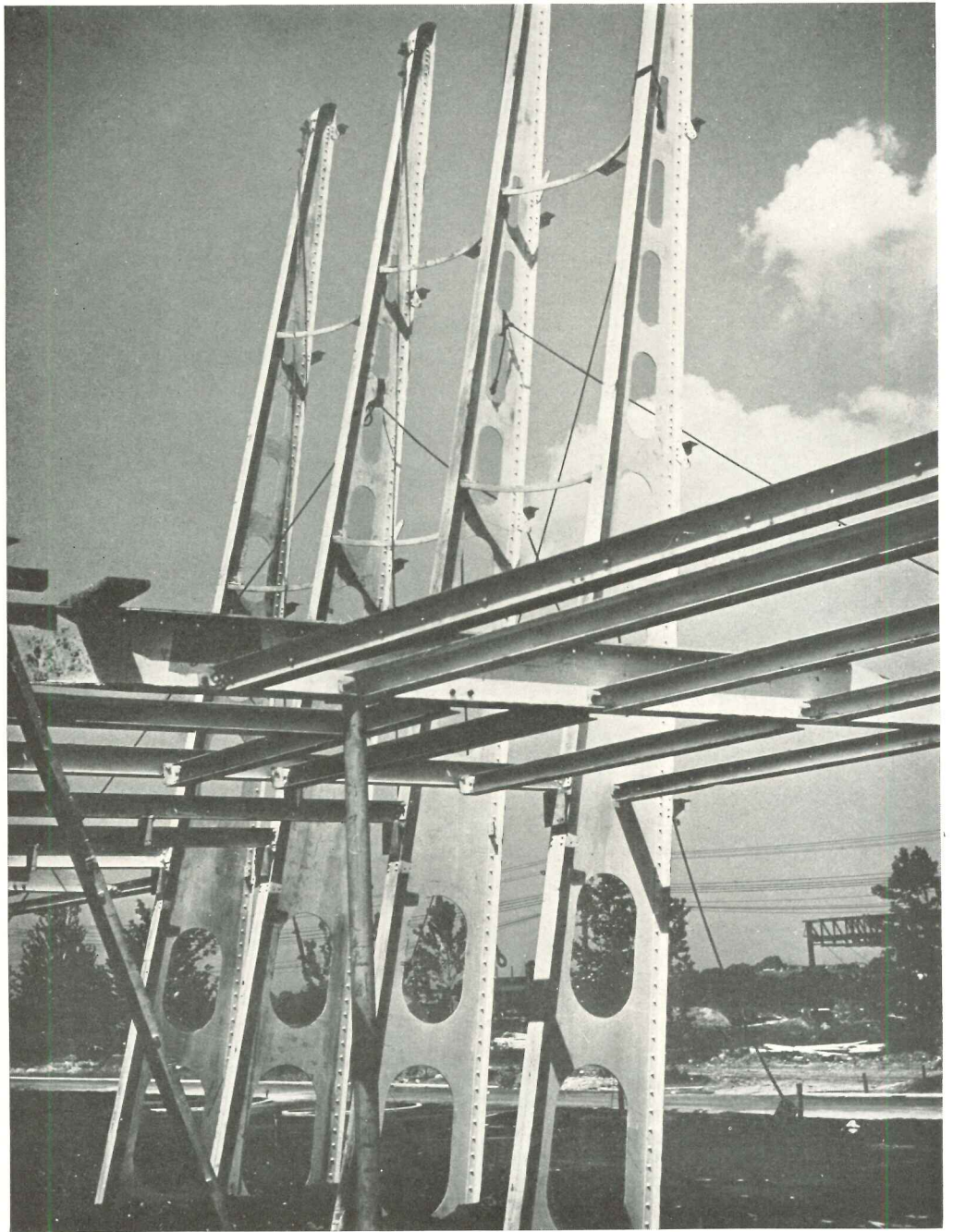

lateral section



Richard Garrison

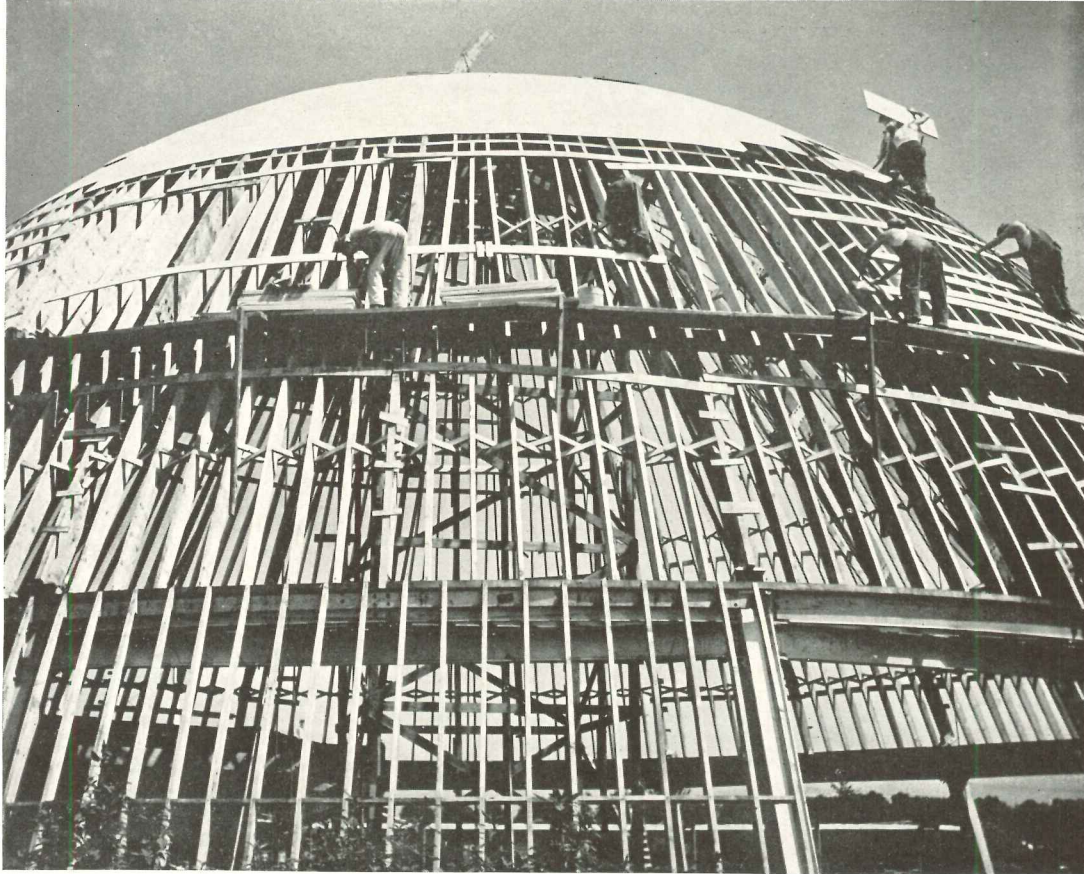

The steel-framed dome is sheathed in wood and insulation board, finished in stucco, painted.

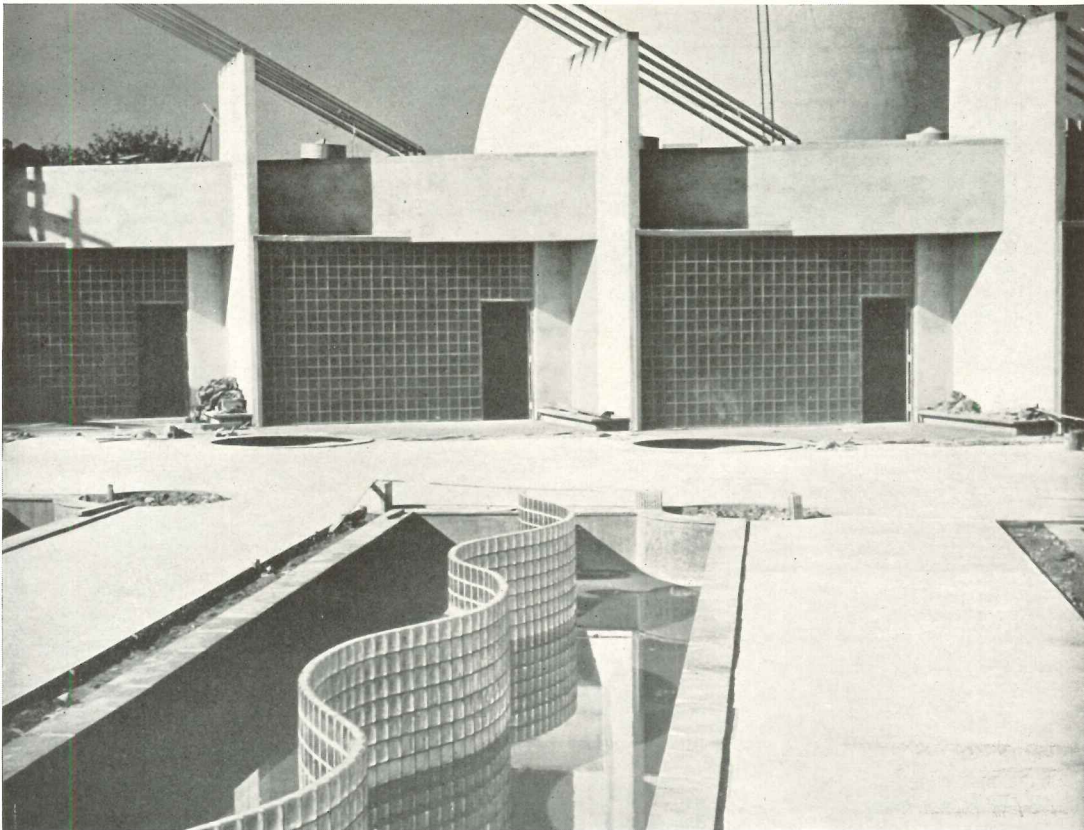

The garden, one of the most elaborate of the Fair's private exhibits, is designed for heavy use. Hence, grass areas are eliminated, planting confined to beds. Full-grown lindens will shade each bench.

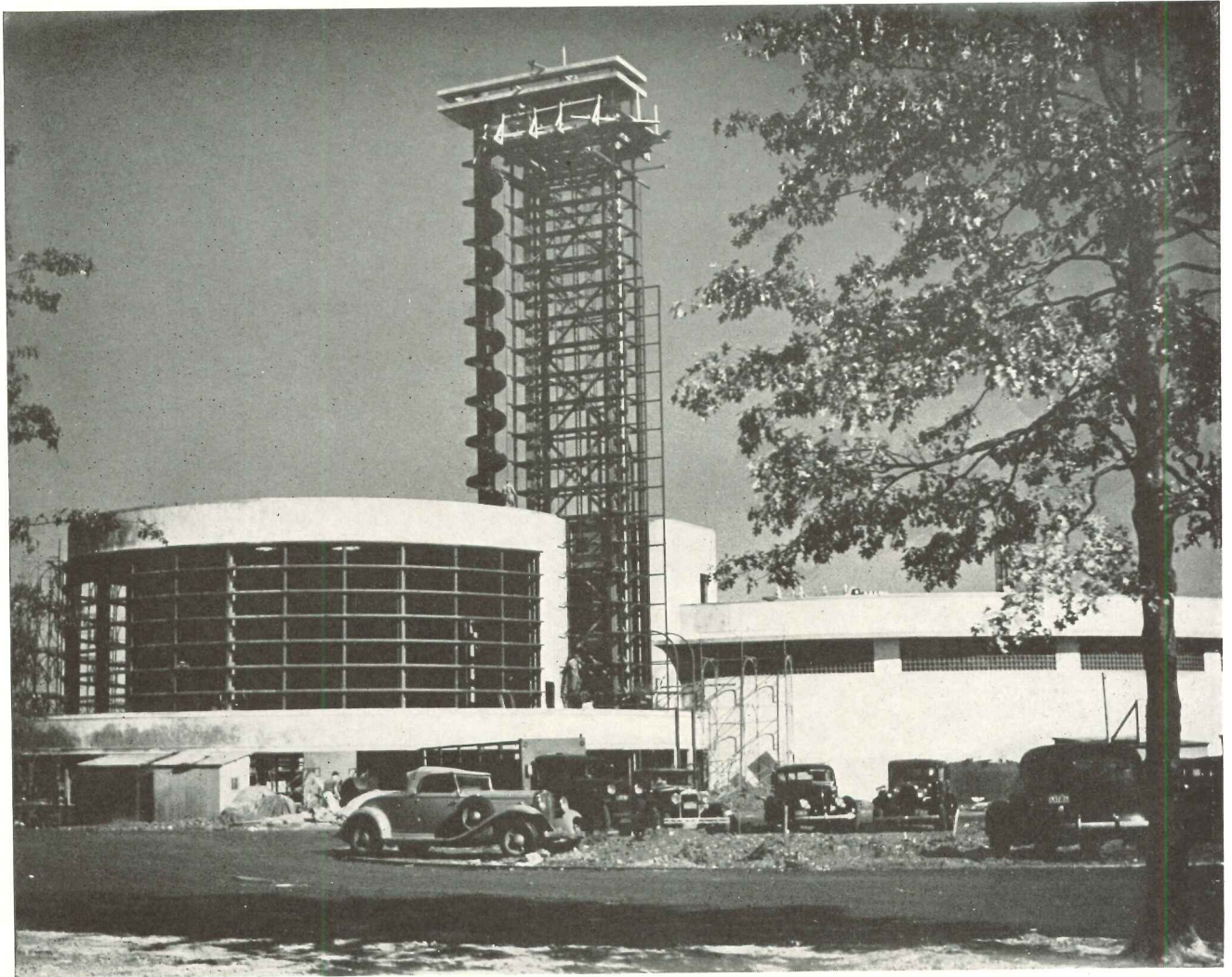

. GLASS, INC.

PREVE, LAMB & HARMON, Architects
 ANDERSON & PORTER, Engineers

NO OTHER industry-wide exhibit, this building makes use of glass in block, plate, and structural forms to demonstrate its properties: strength, transparency, and precision. The structure is a multi-level, designed for one-way traffic (see plan, right). Among its novel features will be a glass-paved terrace, a stairway and ramp of the new use-hardened plate, and a decorative cover of blue plate.



Model

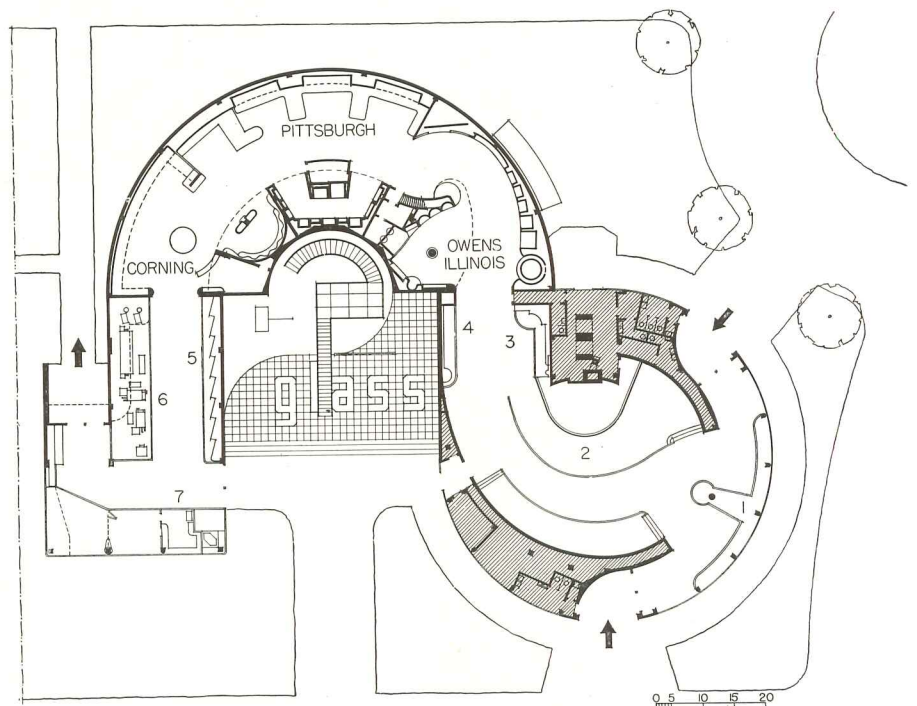

Plan, main floor. 1. History of glass. 2. Hot-glass exhibit. 3. Manufacture. 4. Chart of glass. 5. Properties of glass. 6. Glass-fibre machine. 7. Glass in the home.

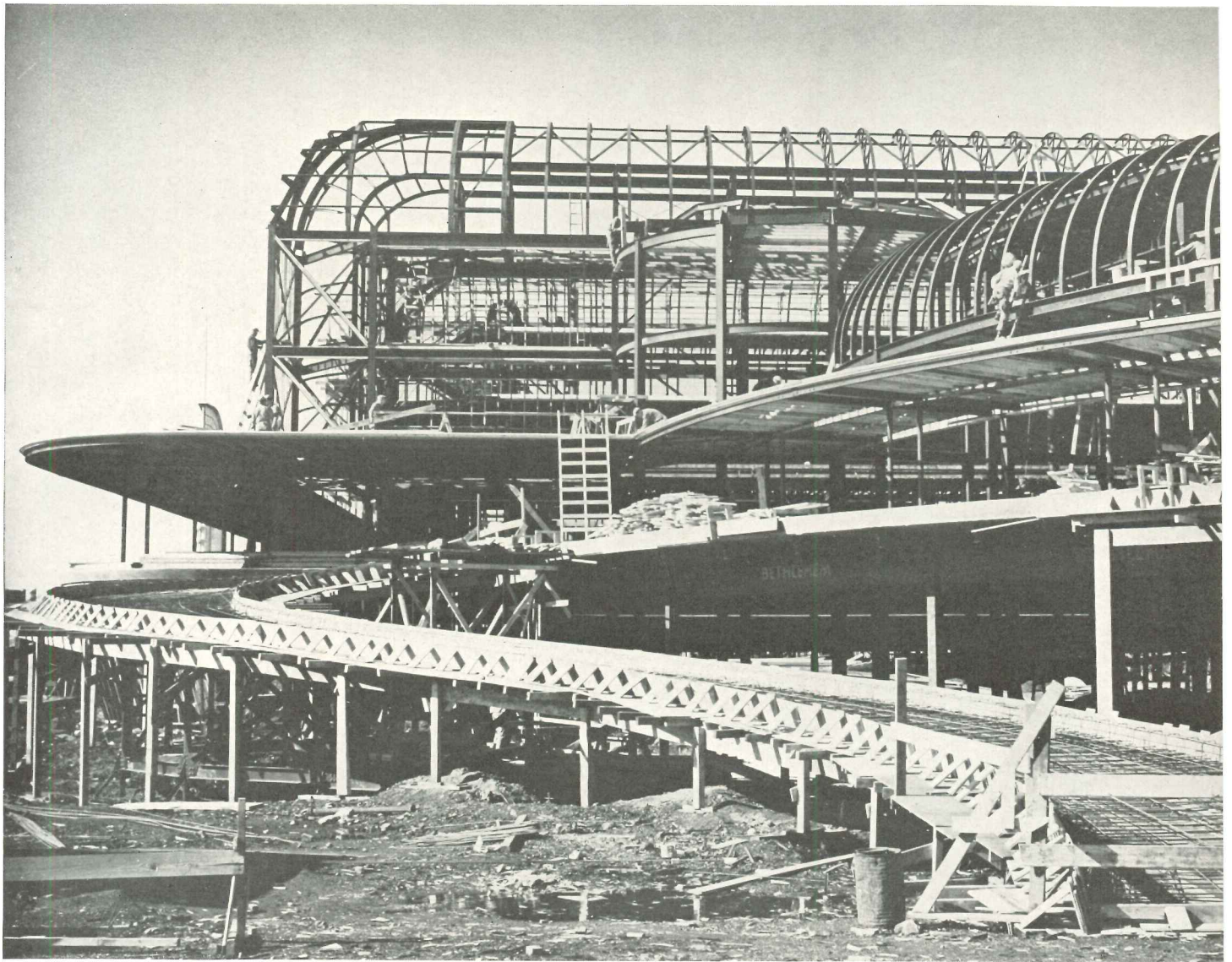

6. GENERAL MOTORS CORP.

NORMAN BEL GEDDES, Designer

ALBERT KAHN, Architect

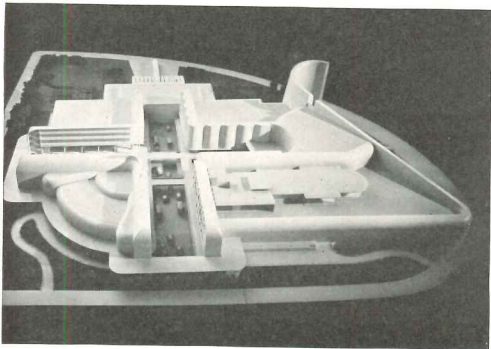

Richard Garrison

Model

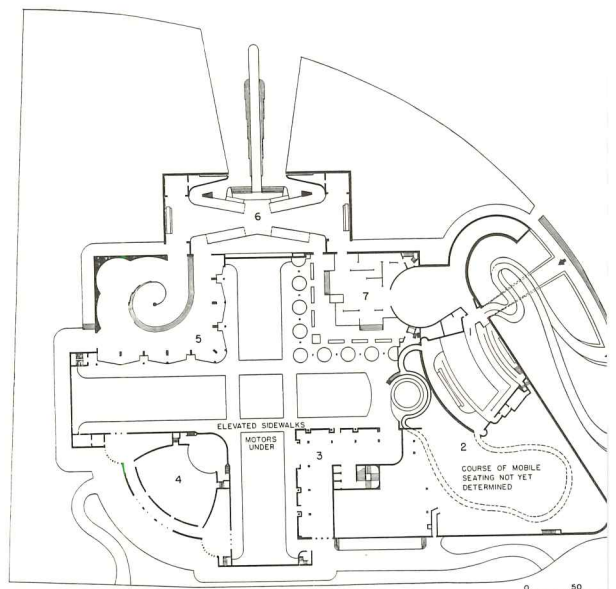

Plan, main floor: 1. Main entrance and loading platform. 2. Display space for model town. Moving chairs on ramp take visitors through exhibit. 3. Apartment and hotel display. 4. Auditorium. 5. Automobile display. 6. Entrance Diesel display. 7. Frigidaire display.

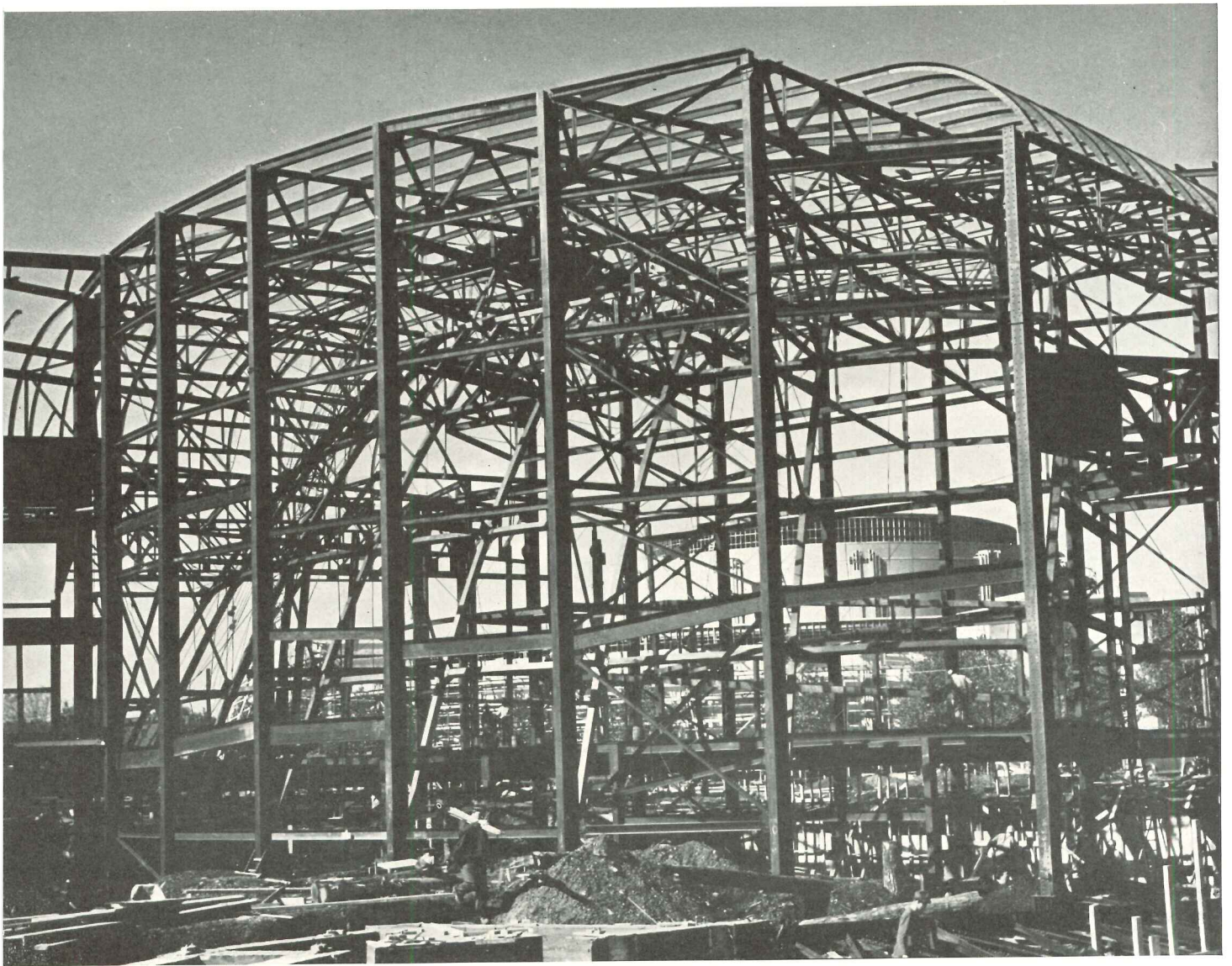

THE LIGHT but elaborate steel framing of the G-M building grows out of the design problem of housing an exhibit which not only focuses on the mobility resulting from the development of the motor car but also attempts to express architecturally the concepts of "streamlining" now current in the automotive field. Thus the full-scale model of an urban street intersection of the future (complete with elevated pedestrian walks, full-sized motor filled streets, and life-size modern buildings) is an expression of the first requirement. The curving walls, rounded parapets and "streamlined" lettering are expressions of the second.

Notable feature of the exhibit will be the street intersection (open cruciform in model, facing page) flanked by four full-size buildings—apartment hotel, theatre, sales and office building, retail store. This last will boast circular showcases which rise as a unit to upper floors for changes in display.

Although the exhibit has three entrances and is multi-level, the main traffic stream will be routed through the major entrance along a series of spectacular ramps into a loading room (1 on plan). From this point visitors will be carried—on an escalator comfortably equipped with paired seats—through a huge introductory diorama (2 on plan) showing potential traffic facilities of the future. In the rest of the exhibit, traffic is not controlled.

Exterior finish will be a new lacquer developed for auto bodies, applied to stucco with air brush.

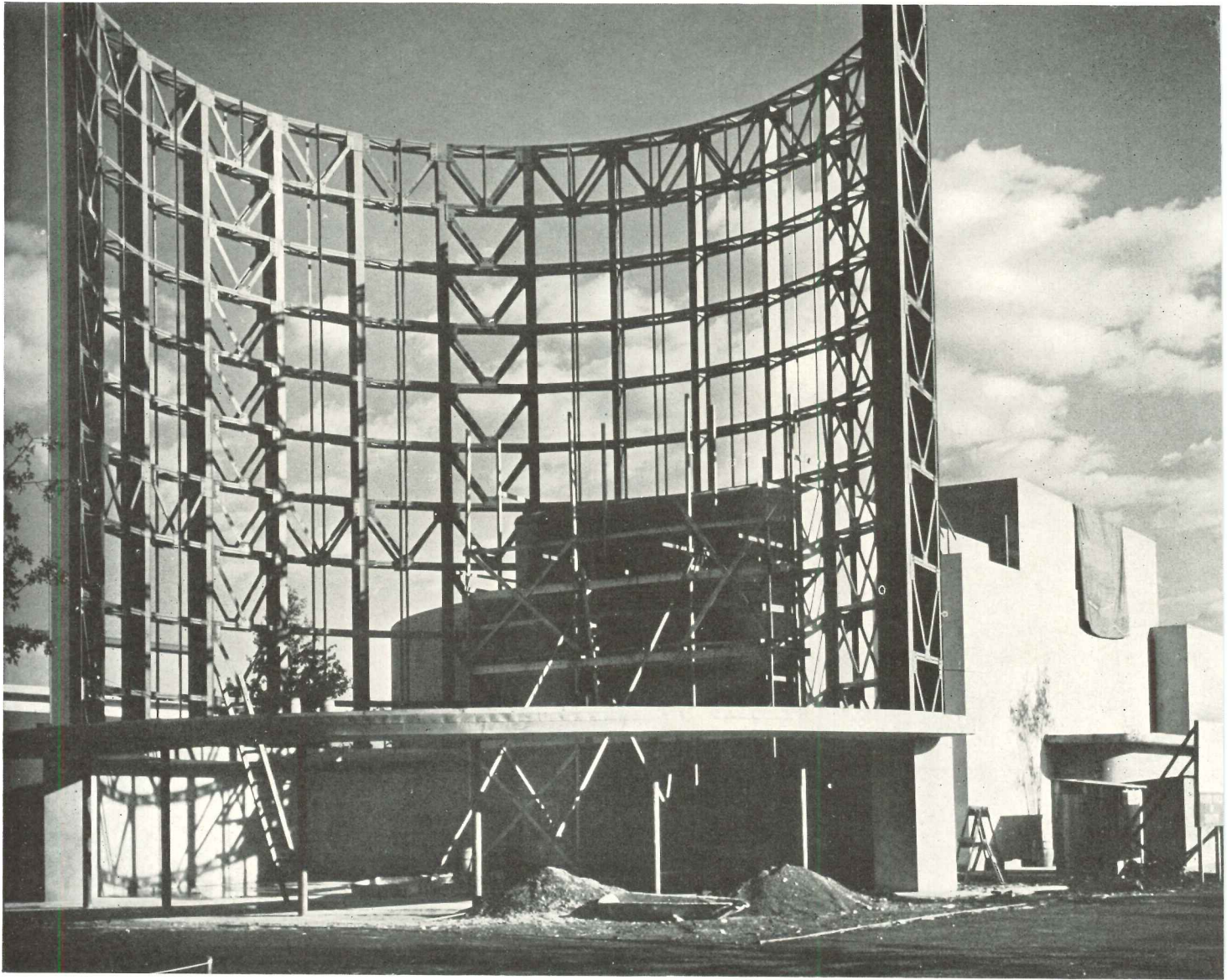

7. E. I. DUPONT DE NEMOURS & CO.

WALTER DORWIN TEAGUE, Designer of Exhibit

ROBERT J. HARPER, Associate

A. M. ERICKSON, Engineer

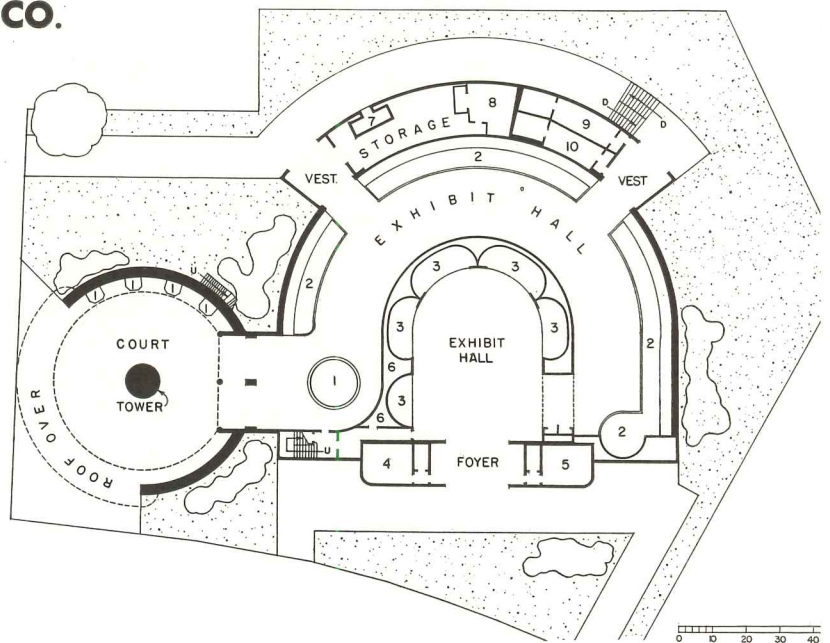

Plan, Main floor. 1. Display cases. 2. Exhibit platform. 3. Dioramas. 4. Men's rest room. 5. Women's rest room. 6. Service. 7. Transformer vault. 8. Air conditioning. 9. Women's lockers. 10. Men's lockers.



Fred. Bradley

Model

AN ARCHITECTURAL emphasis
 the DuPont building was origi-
 y scheduled to have been
 e of the largest murals ever
 uted" on the plastered sur-
 of the semicylindrical en-
 ce court (bottom, facing
 e). As the steel framing—
 gned to withstand wind pres-
 s created by its odd shape—
 t up, its decorative possibili-
 became increasingly apparent
 ht); it has now been decided
 eave it unplastered.

he exhibits are organized in
 ence for one-way traffic. The
 ance court is centered by a
 -ft. tower consisting of lab-
 ory equipment, greatly en-
 ed.

active displays of chemical
 cesses will be arranged in
 outer hall, while in the cen-
 room 5 small stages will be
 l for a marionette production.
 y of the exhibitors' own
 lucts—plastics, enamels, fab-
 —are incorporated in the
 ding itself.

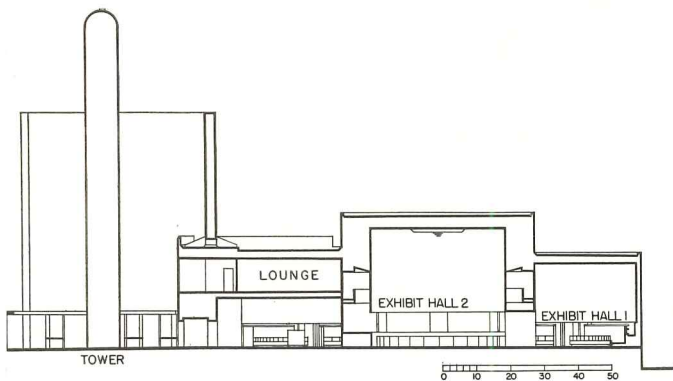
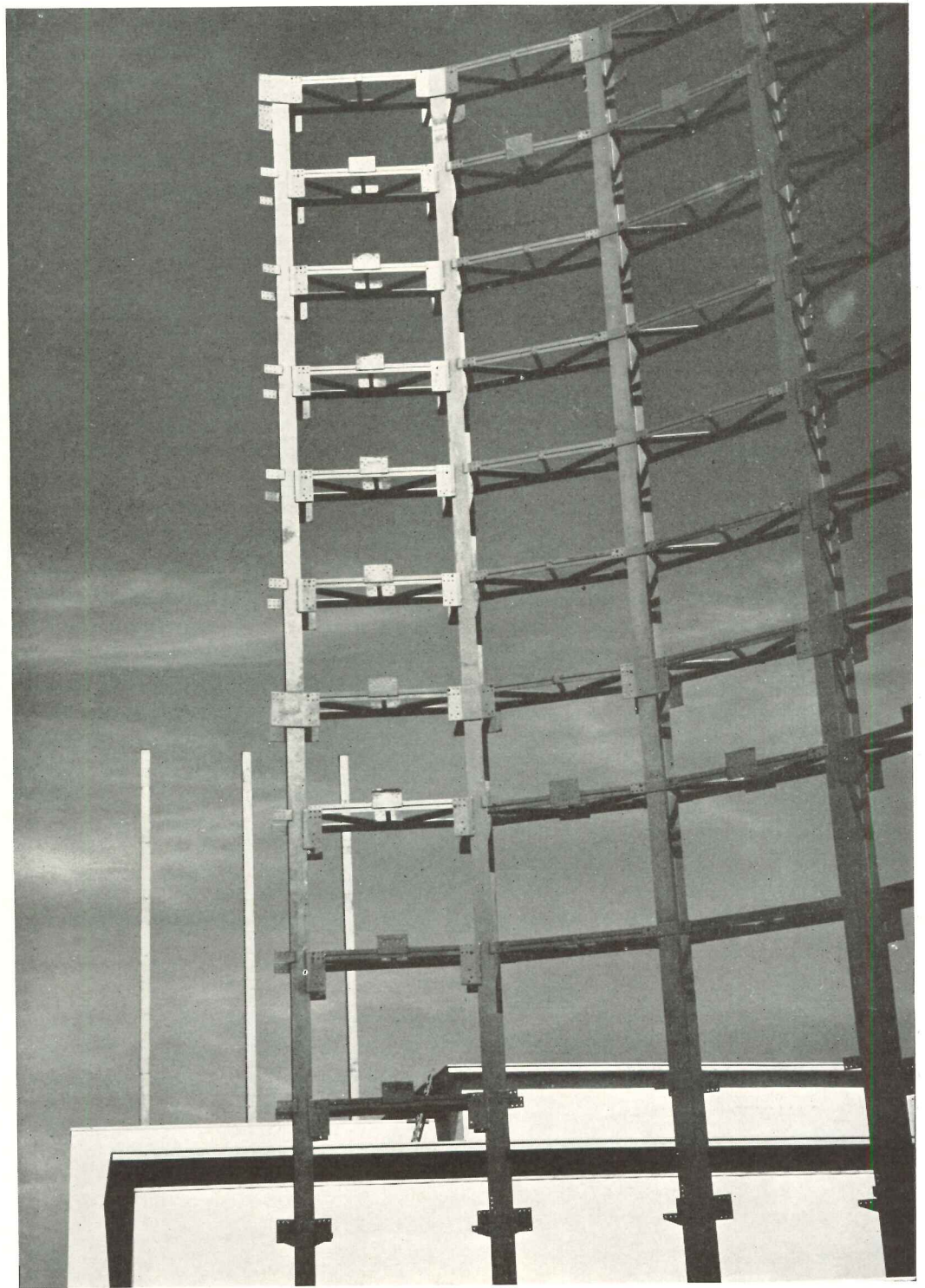

Longitudinal section

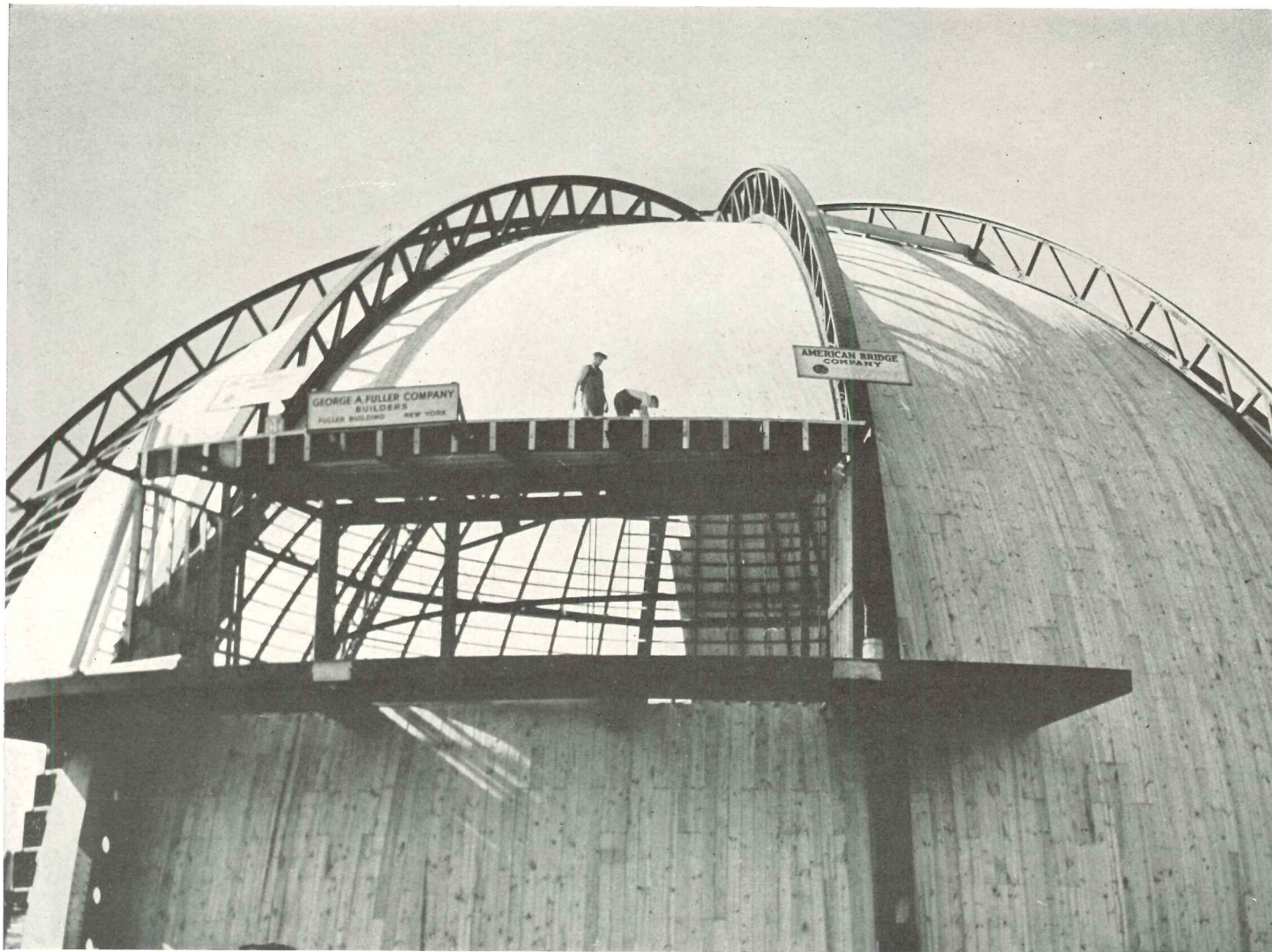

8. UNITED STATES STEEL

WALTER DORWIN TEAGUE, Designer of Exhibit

GEORGE FOSTER HARRELL, Associate

YORK & SAWYER, Architects

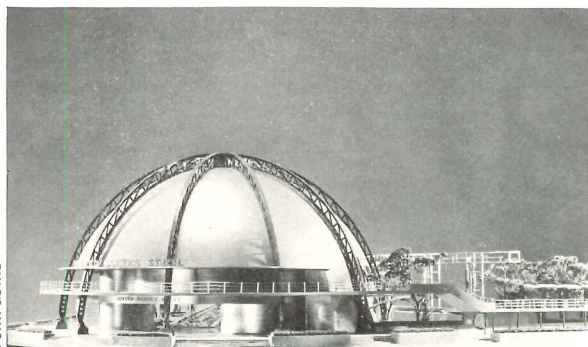

John Mills

Model

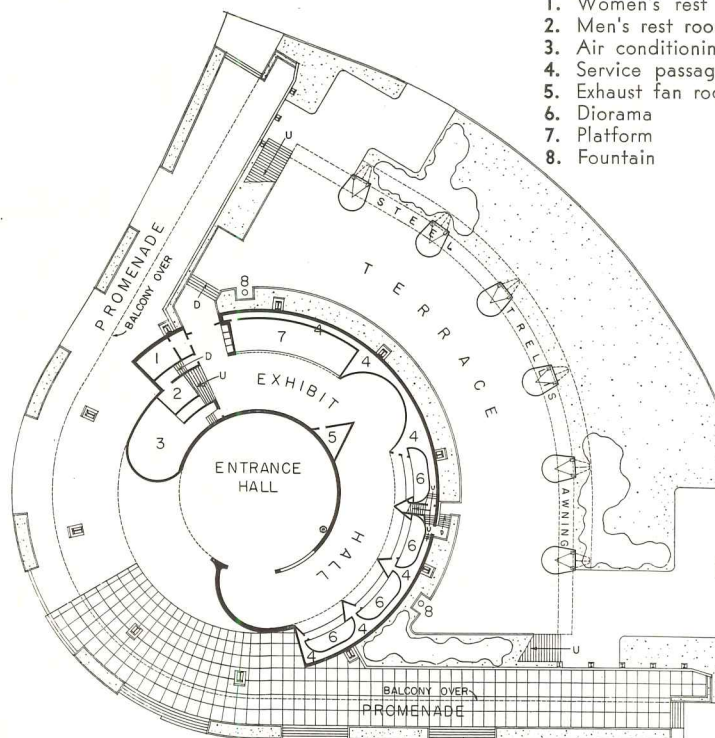

Plan, main floor

0 10 20 3

Steel is one of the few ex-
 tors at the Fair whose building
 itself be largely fabricated of its
 products — steel and concrete.
 In the dome, with its stainless
 shell hung from five intersect-
 open-web arches, to the elab-
 treillage employing various
 members (right), the structure
 demonstrate the multiple uses
 steel in specific design problems.
 A notable structural application
 in the dome itself (right, below)
 which — with a relatively light and
 ple construction — gives an un-
 ken floor area of approximately
 1000 sq. ft. and a maximum height
 of 55 ft. Stainless steel will be used
 a number of forms for surfac-
 — in corrugated panels on some
 the outer walls, in specially fabri-
 curved sheets on the dome, in
 er-thin sheets on interior walls;
 erior flooring on the rear balcony
 of multi-grip steel floor plates.
 Each of the interior trim and finish
 will be of steel in various commer-
 ially available forms.
 The plan is organized to permit
 orderly and easy flow of traffic
 through the exhibit, which occupies
 two floors. Entering the circular
 Entrance Hall (bottom, facing page),
 traffic flows through a semicircular
 corridor (whose outside walls are
 lined with dioramas depicting manu-
 facture of steel products), up the
 stairs into a circular “Hall of the
 Future”, out onto the balconies and
 down the exterior steps.
 Externally, the building will be in
 stainless steel, except for structural
 members, which will be painted blue.

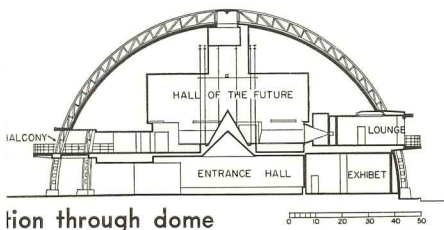
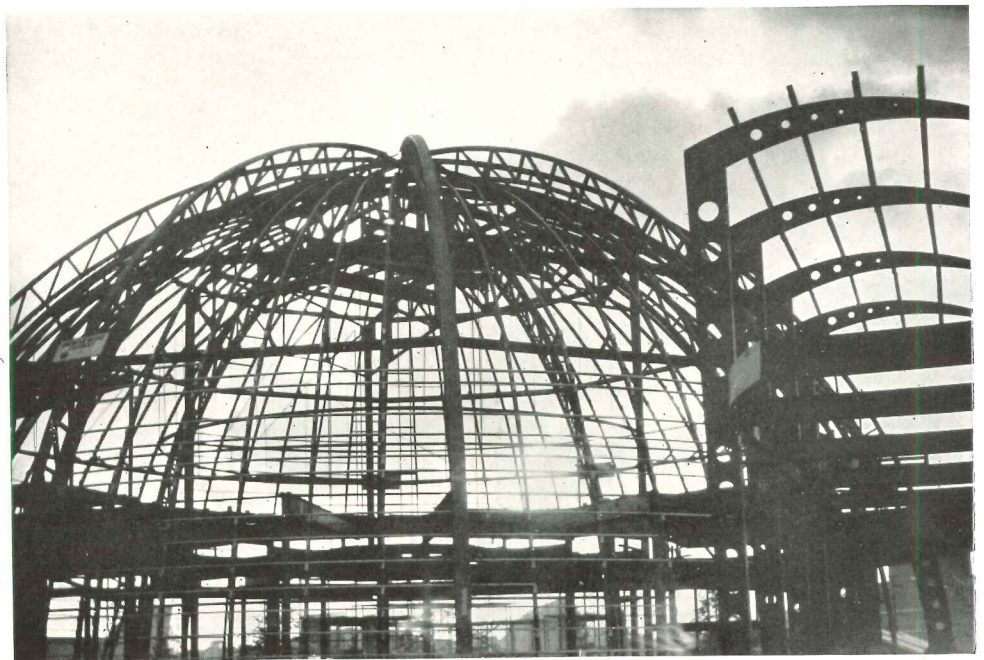

Section through dome

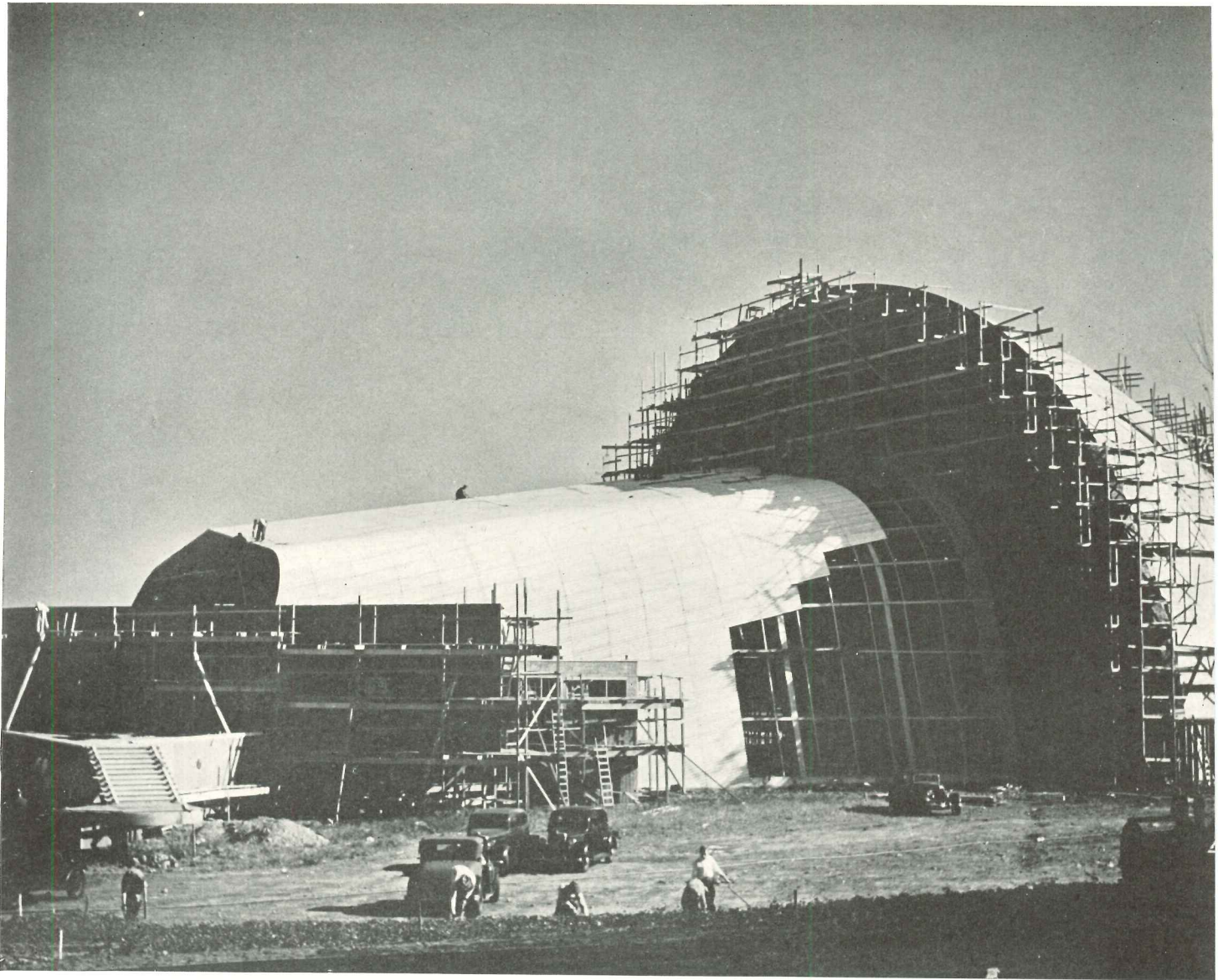

9. AVIATION BUILDING

WILLIAM LESCAZE and GORDON CARR

Associated Architects

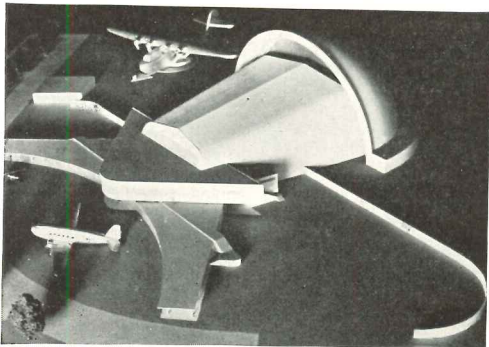

Model

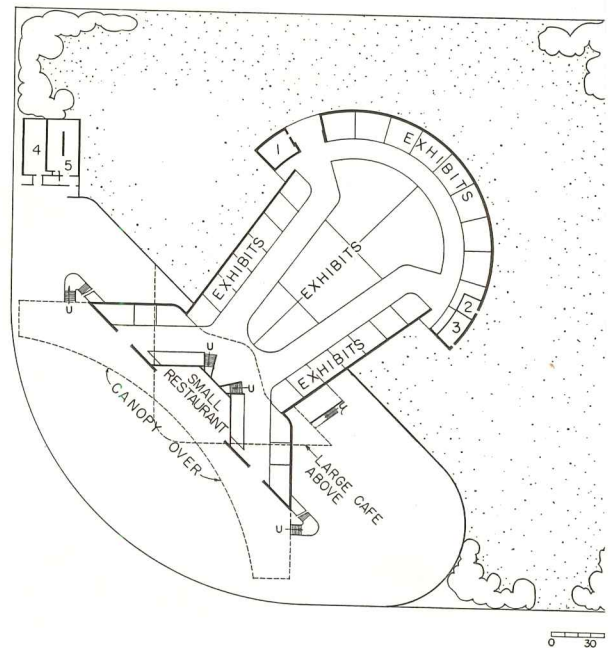

Plan, main floor. 1. Utility. 2. Switch. 3. Transform
4. Men. 5. Women

OTHER OF THE structures notable for steelwork is the Aviation Building. It is one of the few Fair-built structures which departs from the standards of design governing general exhibit buildings (see 89). Although its general form is representational of "flight in space", the Aviation Building actually fills two basic requirements: a large floor area, and sufficient internal height in which to suspend a modern skyliner. The problem of a low, rigid envelope has been solved by the designers in the use of two structural stems — shop fabricated, solid-section, angled arches for the cone (top, right) and open-web arches of more usual design for the semisphere (center, right). The former is sheathed in corrugated asbestos, the latter in canvas. Another feature is the large stressed-canvas canopy across the tire front (see plan, facing page). Laced, ship style, to a system of braced tubular steel columns, the canopy is anchored by means of tie-rods to concrete blocks at each end.

The exhibit space is confined to one floor, with no provisions for traffic control. Focal point of the display will be the plane, suspended in the open semi-spherical dome on whose cement-plastered surface cloud and light effects will be projected to create illusion of movement. The angular "prow" on the second floor will house a large cafe, with auxiliary services.

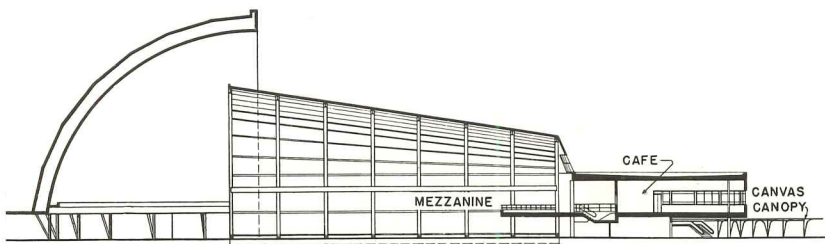
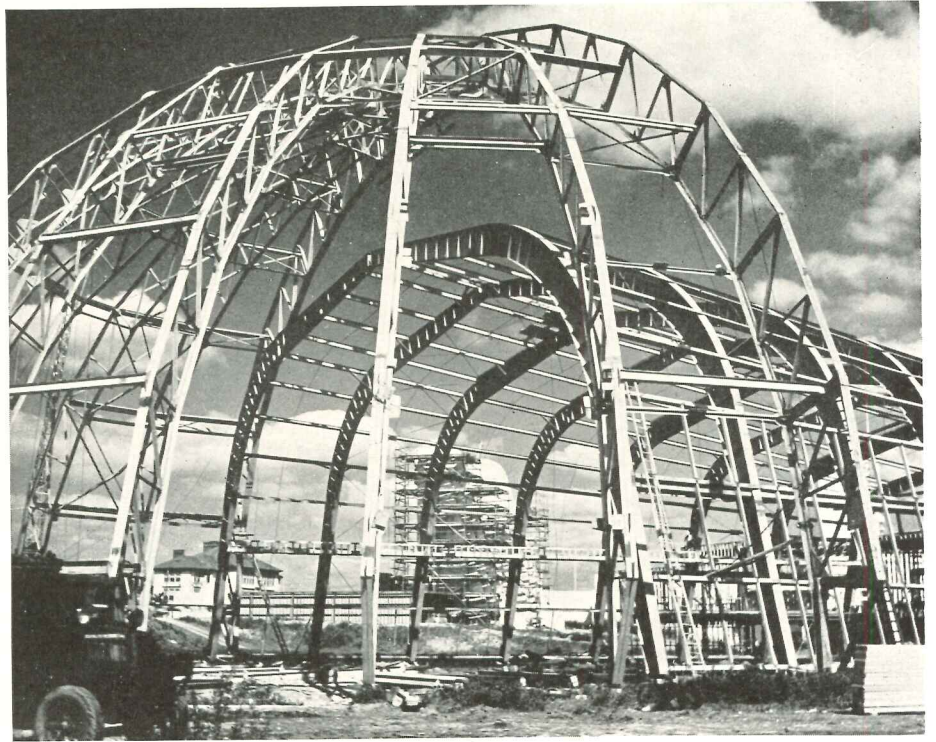
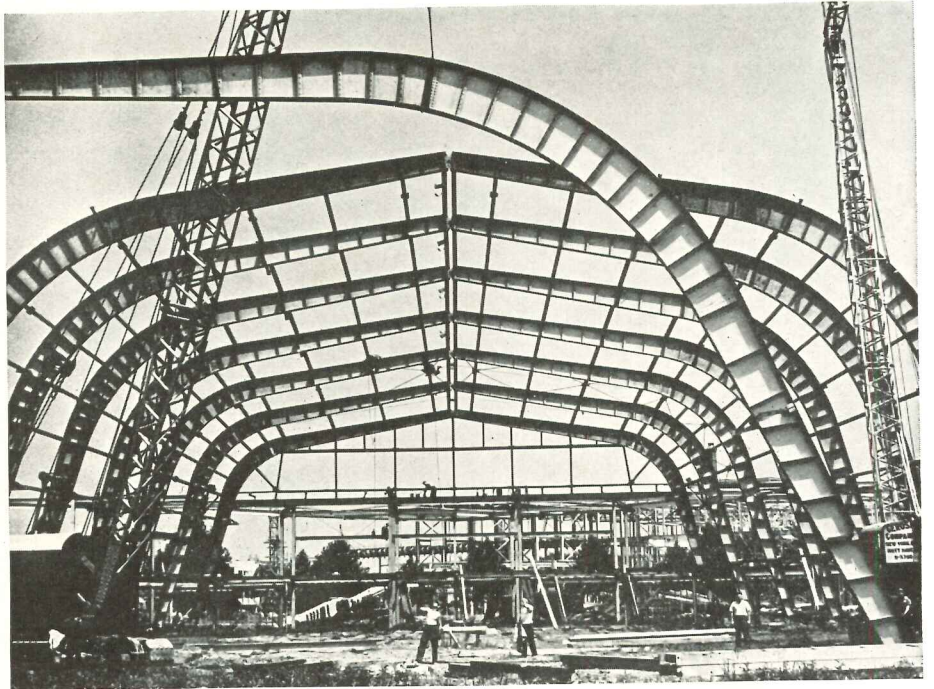

Longitudinal section

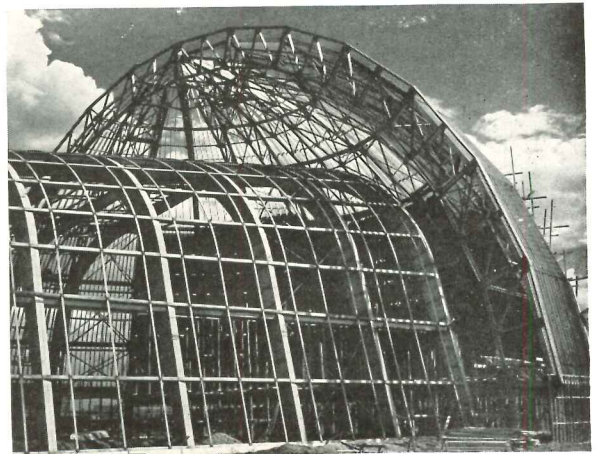

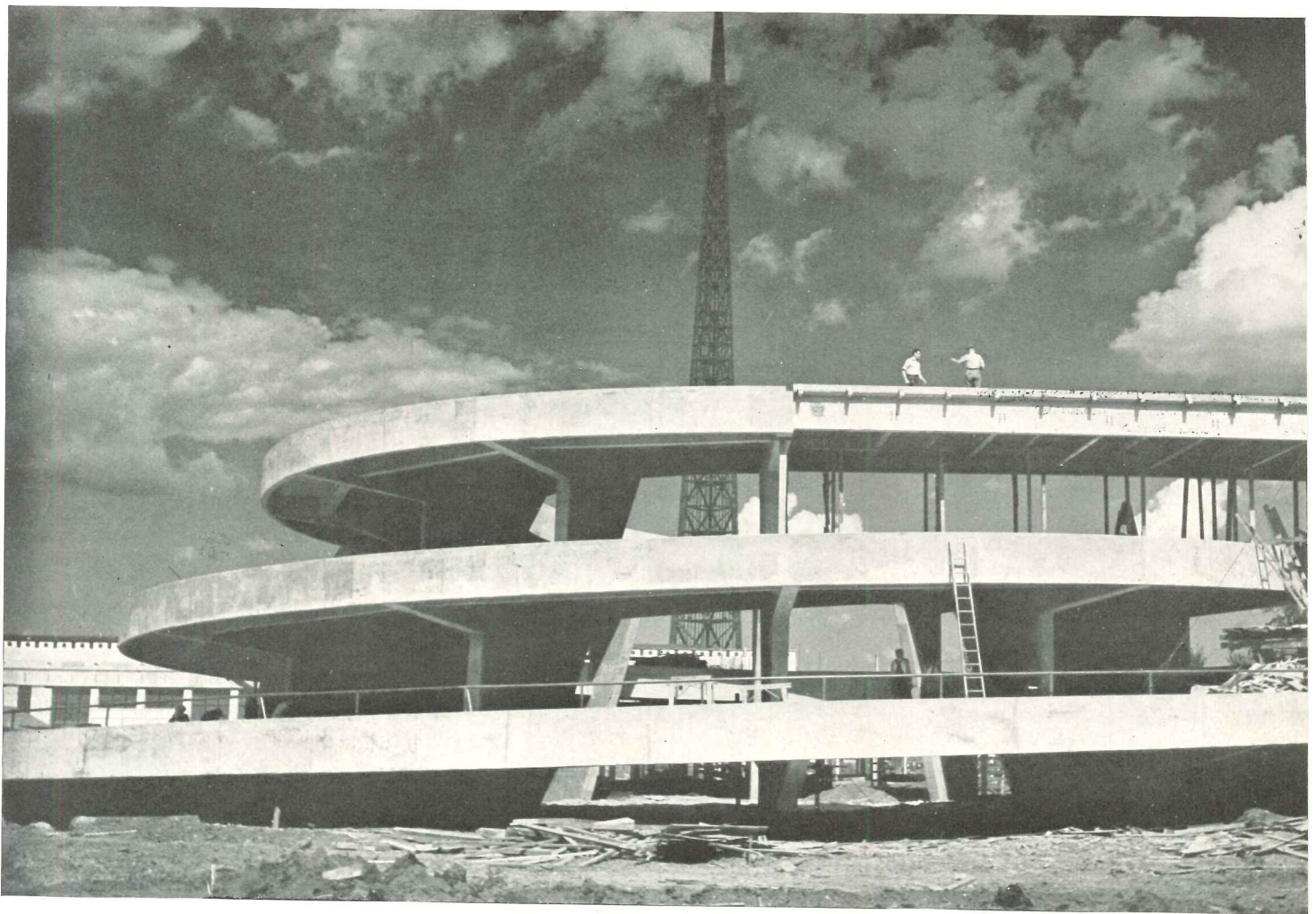

10. FORD MOTOR COMPANY

WALTER DORWIN TEAGUE, Designer of Exhibit
 CHARLES C. COLBY and RUSSELL R. KILBURN,
 Associates
 ALBERT KAHN, Architect

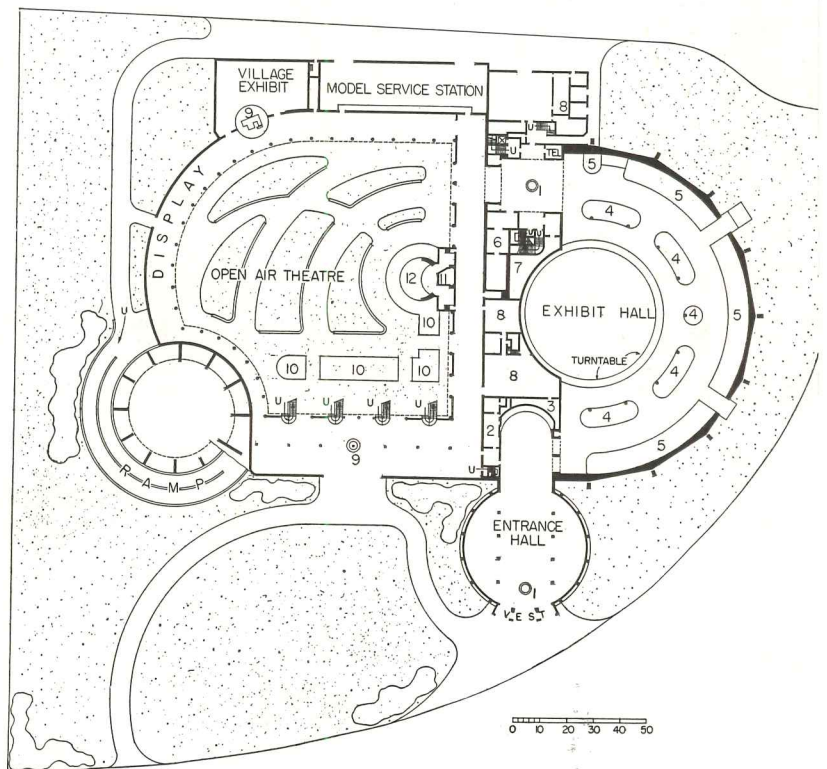

Plan, main floor: 1. Information desk 2. First-aid room 3. Mechanical equipment 4. Island 5. Platform 6. Women's rest room 7. Men's rest room 8. Service 9. Display 10. Pool 11. Broadcasting 12. Orches



Model

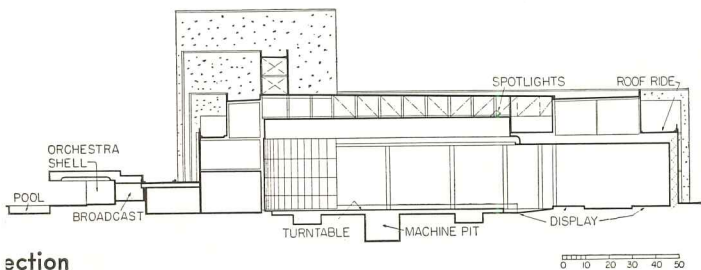
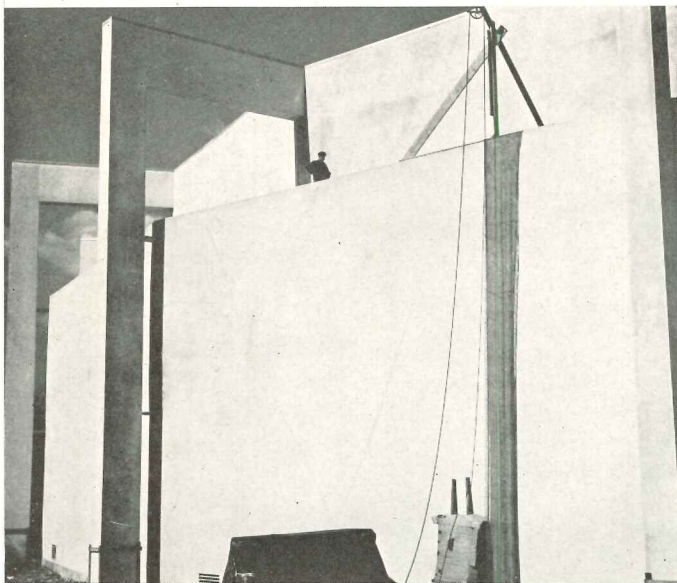
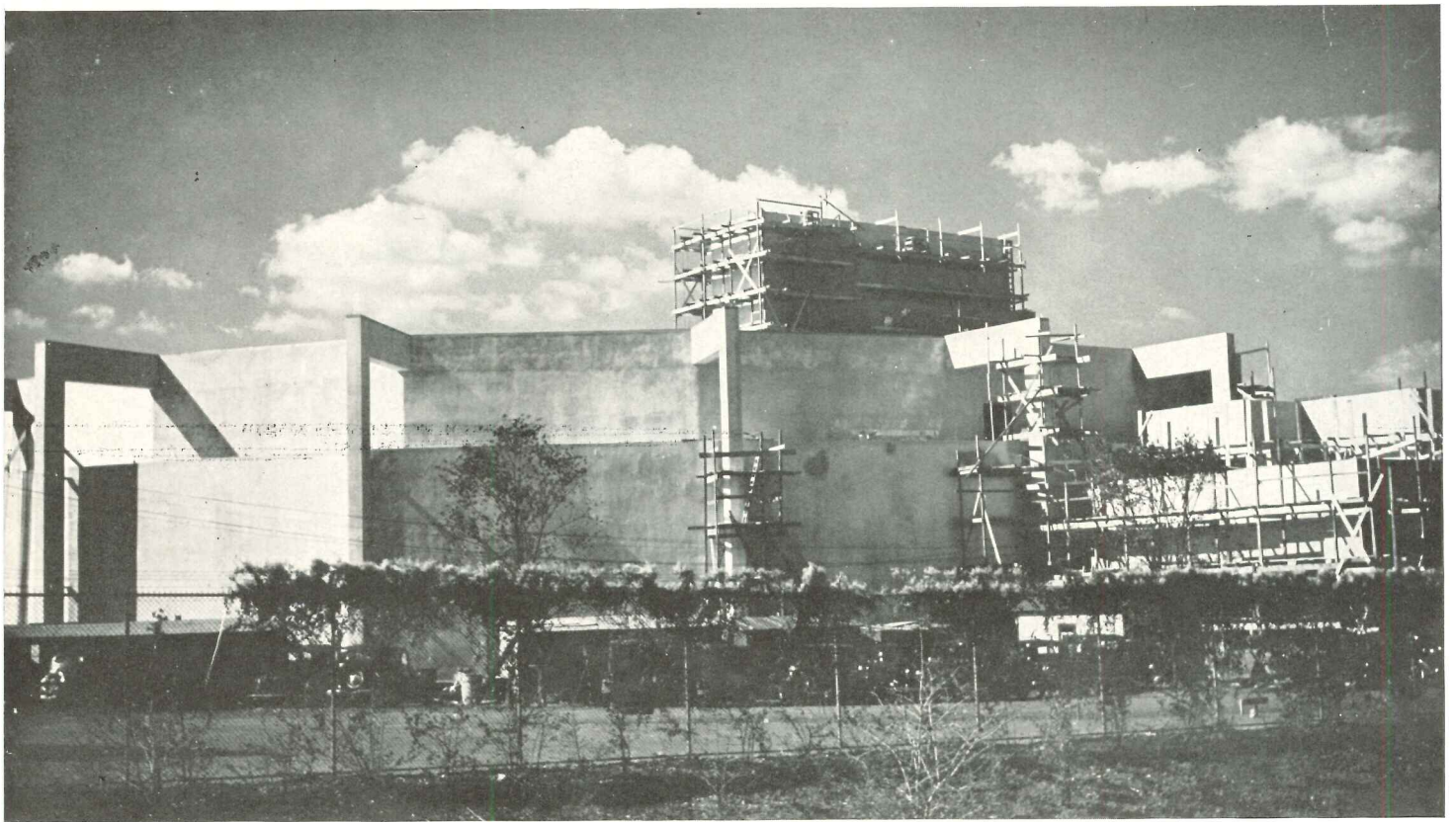

section

BOTH CONSTRUCTION and plan of the Ford building were largely determined by the central requirement of the exhibit—a highway for demonstrating motor-car performance. This “roof ride” led to a much wider and more spectacular use of reinforced concrete than elsewhere at the Fair. In both spiral ramp (facing page) and steps to loading platform (top, over page), concrete has been used in a manner usually confined to permanent structures. Notable is the cantilevered three-tiered spiral ramp; a truncated cone in section, this ramp is carried by a ring of columns around its inner circumference (bottom, over page).

In plan, the exhibit—one of the largest at the Fair—is organized around a 100-foot turntable in the center of the large exhibit hall. Mechanical and other displays are placed across a semi-circular aisle around the turntable. Leaving this part of the exhibit, the visitor passes into a large patio, which is surrounded by the half-mile “Roads of Tomorrow,” an elevated roadway winding over the building and around the garden at various levels. The musical programs, which are an integral part of Ford promotion, had to be provided for in the structure. But exposition audiences differ radically from those of radio: they move on a casual schedule and consequently require not only different music but also different seating facilities. The plan of the Ford patio is designed to meet these needs. The irregular tree-shaded paths roughly circle the orchestra platform; the sides furthest from the platform are lined with benches; thus the audience can move with complete freedom. A studio behind the platform provides complete broadcasting facilities.

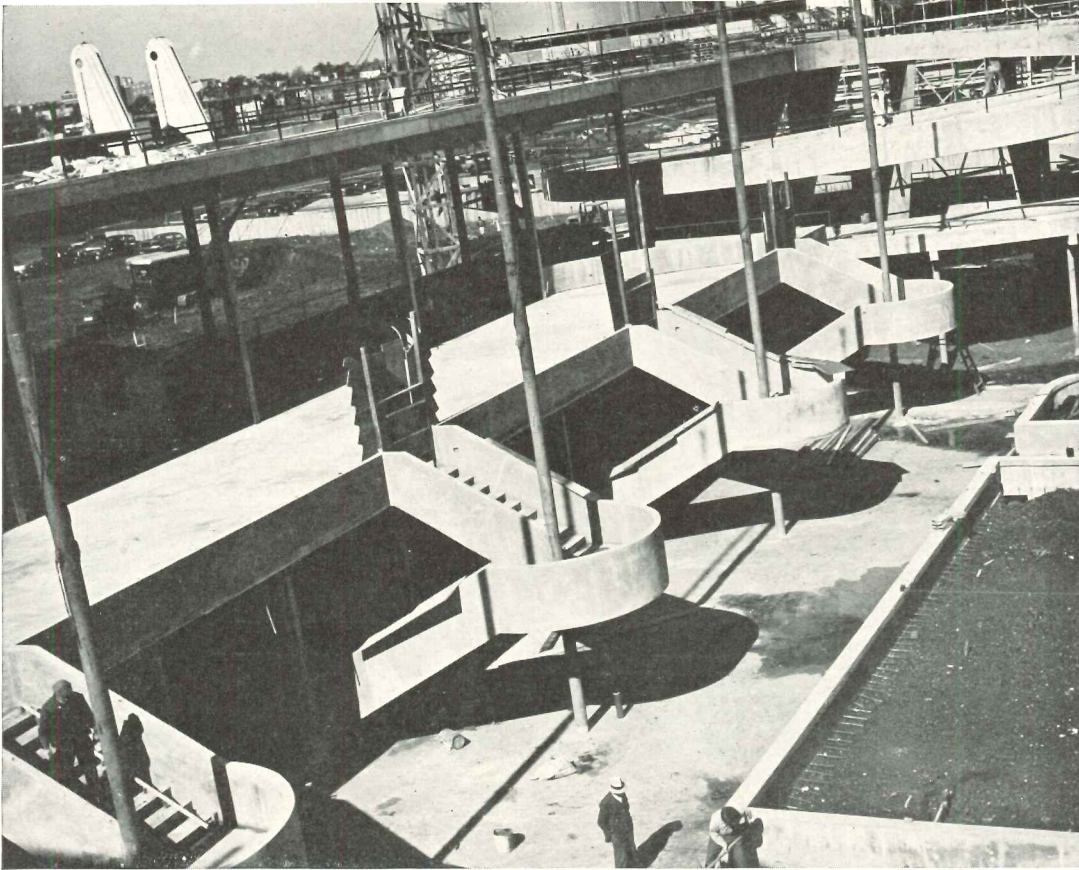

Entrance to loading platform of "roof ride" is by means of cantilevered concrete stairs.

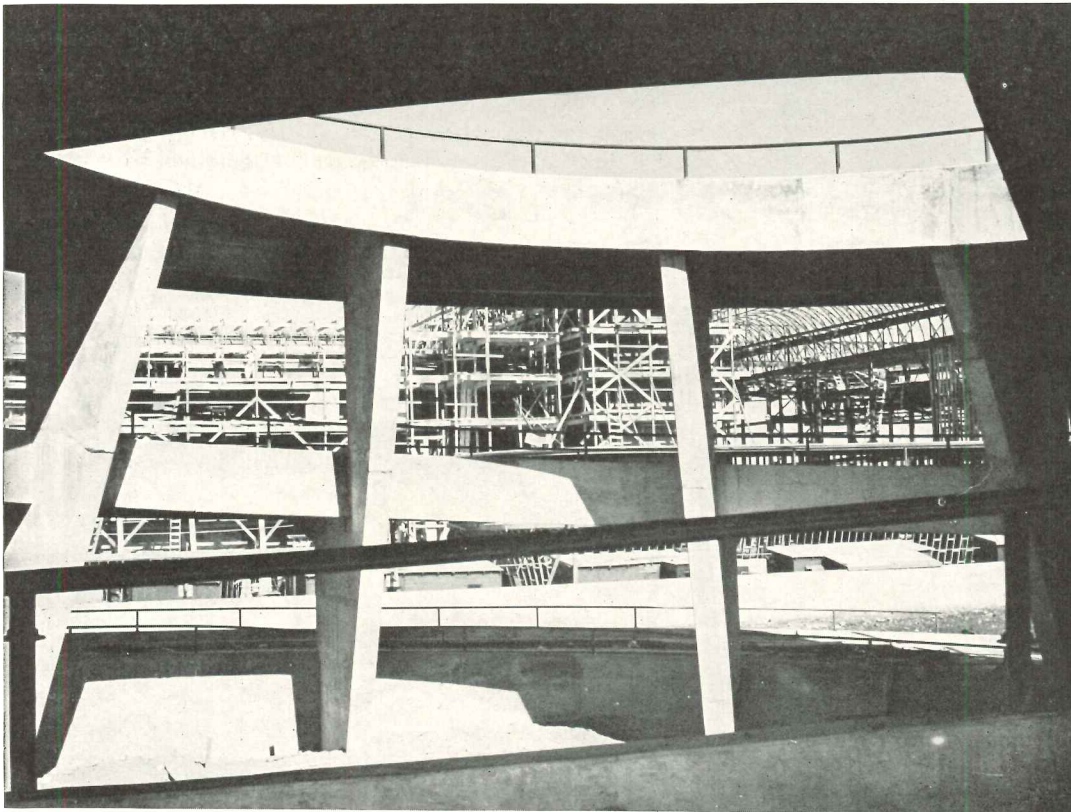

Interior detail of spiral ramp on "roof ride", showing method by which it is supported.

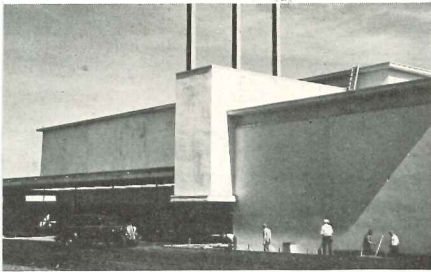

Chemicals and Plastics Building. Joseph Freedlander, Maximilian Bohm, and Charles Beeston, architects.

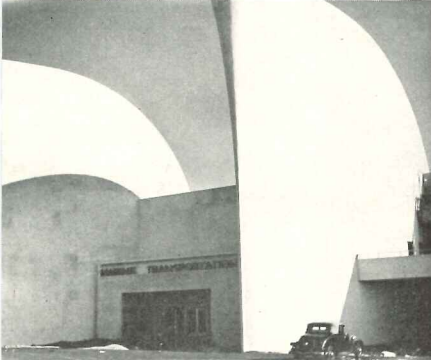

Maritime Building. Ely Jacques Kahn, Louis Schenck, and Broun, architects.

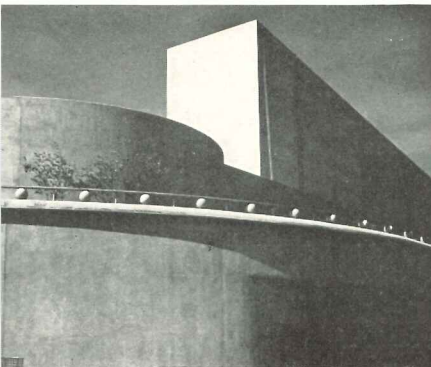

Textiles Building. Frederick G. Frost, Sr., Frederick G. Frost, Jr., and Ward W. Pomeroy, architects.



Decorative pylons, Transportation Building. James Gamble Rogers, architect.

EXHIBIT DESIGN

JOHN P. HOGAN*

HERE WILL BE in all on the Fair Site about 375 structures ranging from information booths and concession stands to shipping stations and exhibit buildings. Of the major structures, 100 will be exhibit buildings and 50 amusement concessions.

Of the 100 or more exhibit buildings, the Fair Corporation will construct only about one-third. Most of the Corporation buildings were completed before the other exhibitors began to build. With

Chief Engineer and Director of Construction, New York World's Fair 1939

some notable exceptions, the general character of the buildings has followed the principles, both in interior arrangement and in details of construction, which were established by the Corporation. As the general plan was completed, Fair buildings were located throughout the exhibit area in strategic places in order that they might serve as a control for the architecture of the buildings to be constructed by exhibitors.

In the Government Area, where a greater variation was to be expected in buildings constructed by foreign nations,

unity was retained by grouping the government buildings and the pavilions to be occupied by foreign nations (who are not erecting their own buildings) around a central court. The Board of Design did not itself design the Fair-owned exhibit buildings, although some of the members in their private capacity were architects for other exhibitors. Architects, or in many instances groups of architects, were selected for the design of the Fair-owned exhibit buildings on a program prepared by the Board of Design. In this way, and through the

EXHIBIT DESIGN

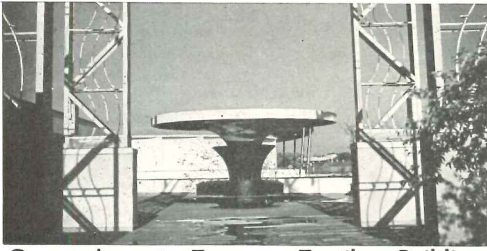

Covered seat, Terrace, Textiles Building

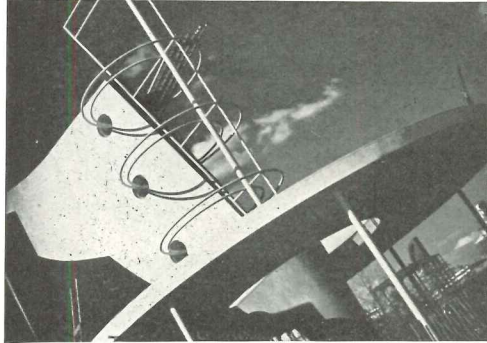

Production and Distribution Building. Corbett and MacMurray, Robert W. Cutler, architects.

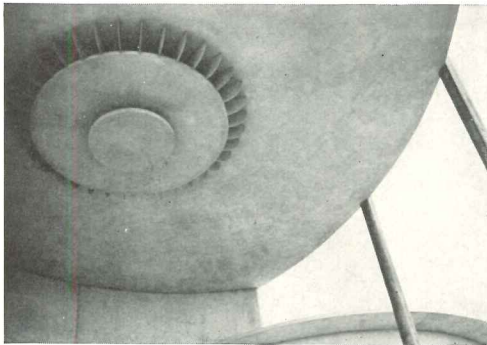

Light fixture, Food #3 Building. Philip L. Goodwin, Eric Kebbon, Edward D. Stone, Richard Snow, and Morris Ketchum, Jr., architects.

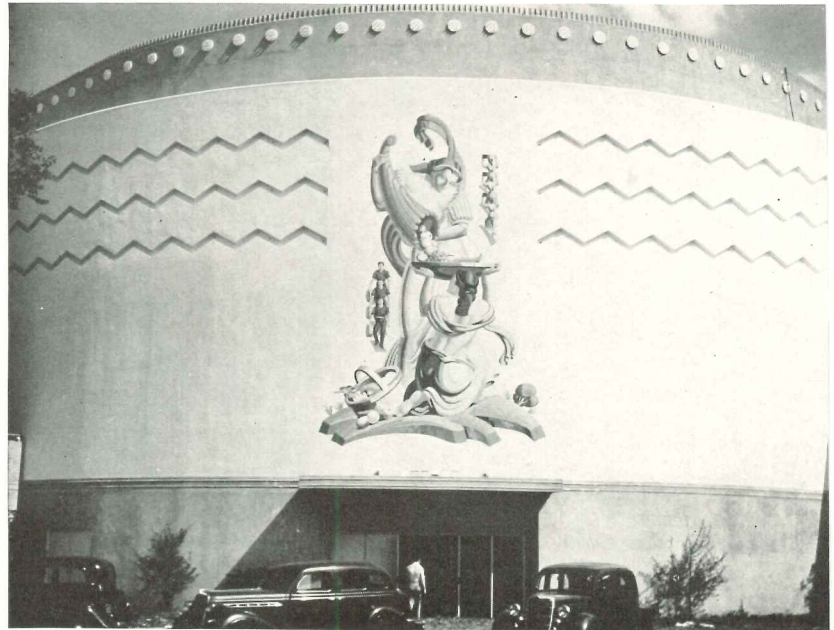
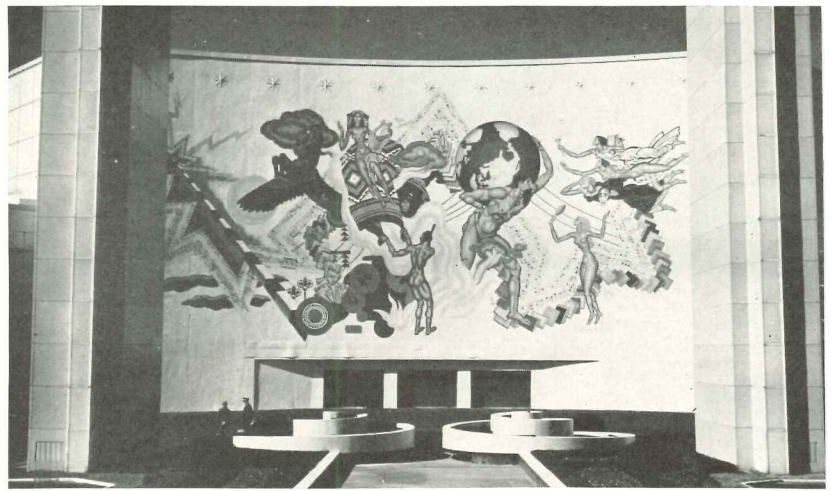

Top: Communications Building. Francis Keally and Leonard Dean, architects; Eugene Savage, muralist. Bottom: Food #2 Building. Aspinwall and Simpson, M. W. del Gaudio, architects; Carlo Ciampaglia, muralist.

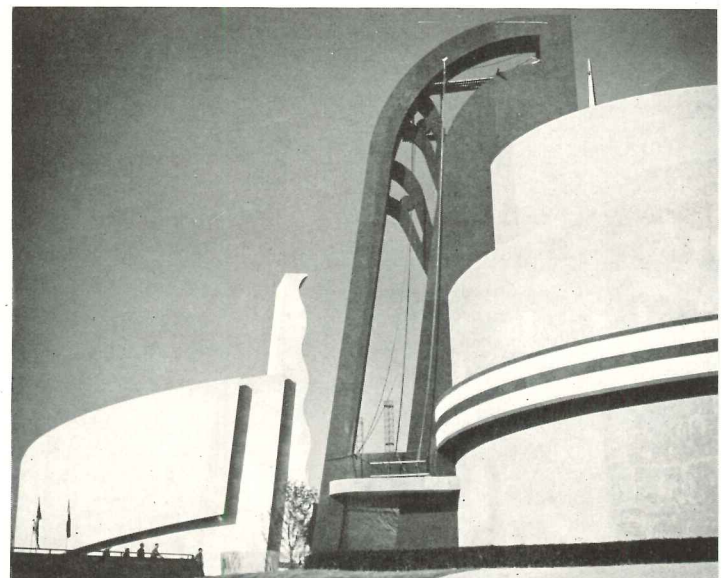
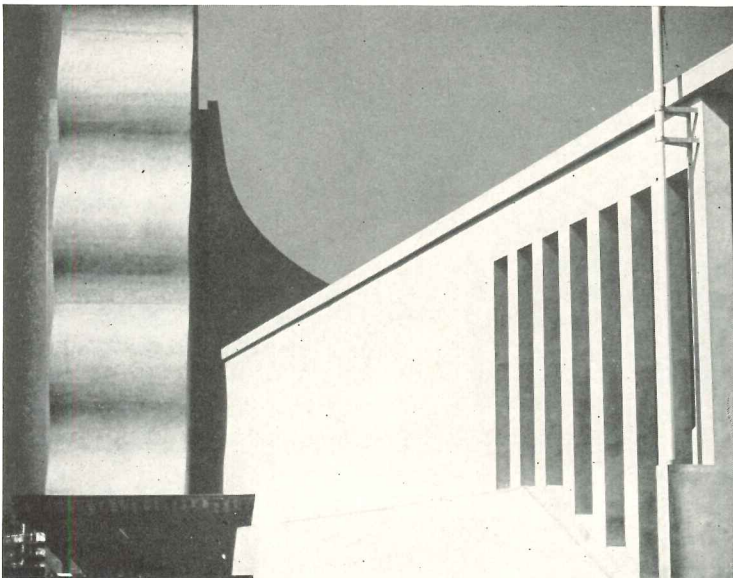

Left, Hall of Pharmacy. Pleasants Pennington, George L. Payne, Jr., I. Woodner-Silverman, architects. Right, Electrical Products Building. Walker and Gillette, architects.

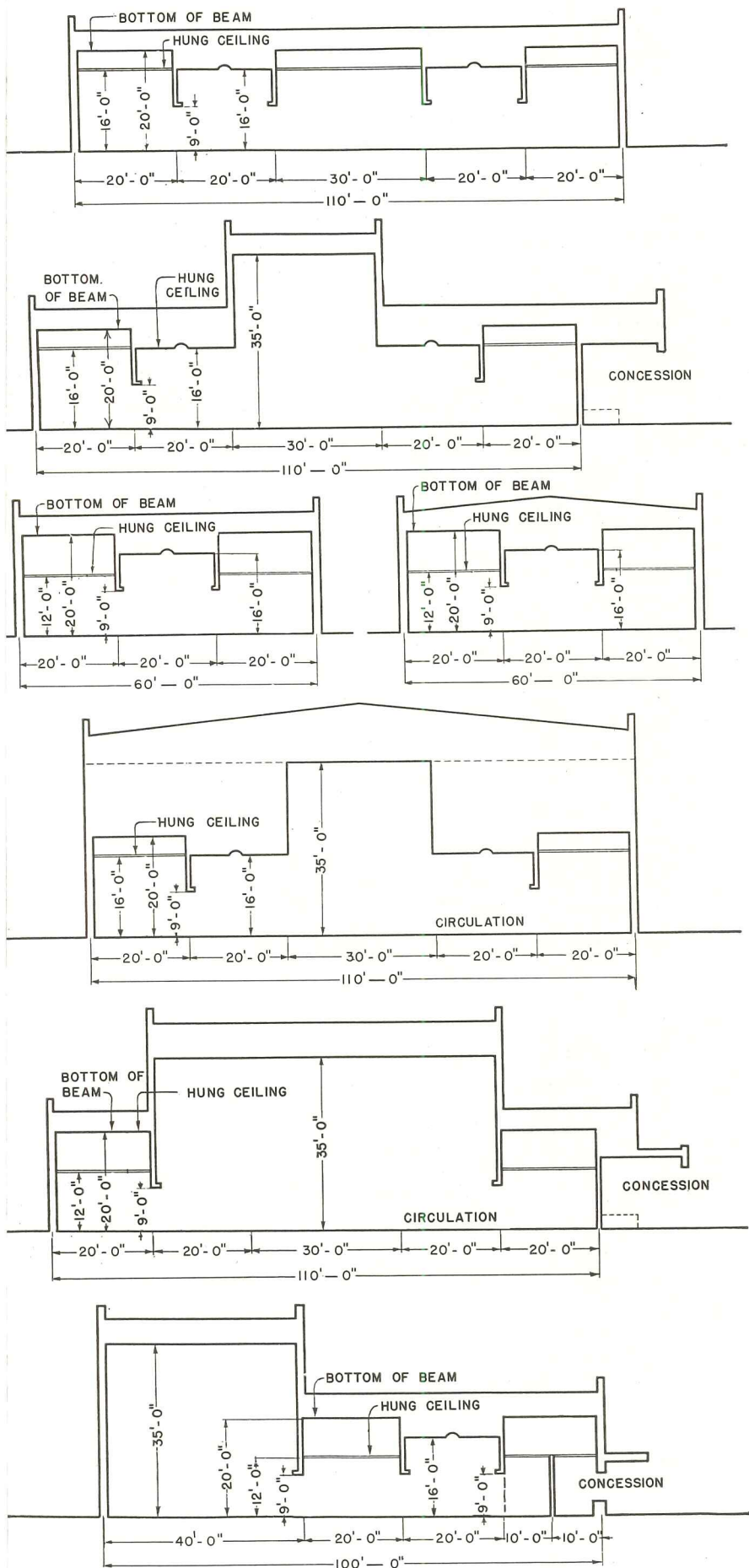

chitects of the 30-odd Corporation buildings were guided by these basic es; evolved by the Fair staff, they embody the standards here described.

freedom of individual exhibitors to select their own architects, literally hundreds of architects, sculptors, and mural painters have participated in the preparation of the Fair. All plans from Fair architects or architects of exhibitors were reviewed by the Board of Design, and in most instances were modified by suggestions from the Board.

The purpose of this control was to create a certain amount of unity without uniformity, and insofar as possible, to avoid a lack of cohesion. For the same reasons, general control of light and color within reasonable bounds was exercised by the Board of Design in uniformity with a general light and color scheme prepared by the consultants of the Board. Proper landscaping was made mandatory and while very considerable latitude was allowed, pressure was brought on all exhibitors to present satisfactory landscape plans.

In determining the program for the World's Fair exhibit buildings, it was necessary for three separate departments of the Fair to cooperate, the Board of Design, the Construction Department, and the Department of Exhibits and Concessions. The Fair had been zoned by the Board of Design into eight main sectors, and it was the duty of Management to determine the amount of space in Fair Buildings which should be assigned to each sector and to determine the size of the Fair buildings which should be located in each sector. Management decided that there should be provided in the Fair-owned exhibit buildings 450,000 net sq. ft. of exhibit space, 100,000 sq. ft. of gross space for stores and restaurants, and 40,000 sq. ft. of net space for concessions. They also made suggestions in regard to the most saleable arrangement of this space based upon the experience of other Fairs.

As the Board of Design is a board of review and not an administrative branch of the Corporation, it was decided that the Construction Department was to prepare all working drawings based on approved definitive designs of contract architects, and to construct all buildings either by contract or with forces employed by it, which placed the important element of cost control in the Construction Department, and also the responsibility of carrying out into detailed design architectural conceptions of the contract architects as approved by the Board of Design. The Construction Department was also charged with the administration of the entire construction budget and preparation of detailed land-

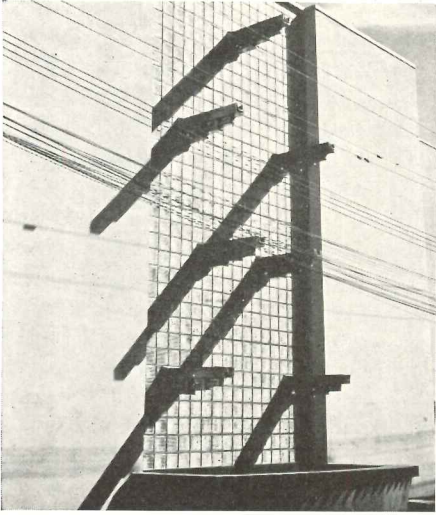

Fountain, Metals Building. William Gehron, Morris & O'Connor, architects.

scape plans, detailed lighting plans, and the enlargements and erection of murals and sculptures from models approved by the Board of Design.

The requirements of both Management and exhibitors were analyzed, and four important determinations were reached: First, that the buildings should be one story, with entrances level from the streets and sidewalks. Second, that since the buildings were to be occupied by a number of exhibitors it would be impossible to secure good results in lighting and decoration unless complete reliance was placed upon interior lighting. This brought about a decision to have no windows. Third, that the interior should be susceptible to division into minimum units 20 by 20 ft. or multiples thereof, wherever the exhibit space was located on the side with a central aisle. Wherever a central exhibit space was provided with an aisle on each side, it was decided to make this central island 30 ft. wide. Fourth, that all aisles were to be 20 ft. wide.

This led to a typical arrangement of buildings either 60 ft. wide with two exhibit spaces and a central aisle, or buildings 110 ft. wide with two aisles, two side exhibit spaces, and a central exhibit. This determined the economical plan of the Fair buildings and was followed generally, although domes and rotundas were provided for points of special interest.

Based upon these determinations, a careful structural study was made on the various possibilities of economical construction. Many types of material were investigated and economics finally dic-

tated the selection of light steel frames and interior columns along the face of the side exhibits. Preliminary cost investigations indicated that required space could be obtained within the limits of cost in stucco, which was the material preferred by the Board of Design. It was therefore possible to build a more substantial Fair within the limits of cost than had been originally anticipated.

With some variation, the general materials of construction were as follows: steel frame with wood purlins, joists and rafters, all covered with one-half inch gypsum board. Over this was placed paper-backed lath and about one inch of cement mortar and stucco. The interiors were finished in gypsum boards, taped and sparkled. Floors were of four inches of fine stone covered with black top. Hung ceilings were generally used and the spaces between the ceiling and roof serves as plenum chambers for exhaust fans with individual motors placed about 50 ft. apart along each side. For insulating material there was placed on the interior of the outer wall and underneath the roof joists either a layer of rock wool or a metal foil insulation. A small fire in one of the buildings indicated that this assembly, being largely composed of non-combustible materials, is very slow burning.

It was estimated that in order to meet the net space requirements it would be necessary to build 1,400,000 sq. ft. of exhibit buildings at an estimated cost per sq. ft. of from \$4 to \$6, depending on the character of the foundation. The lower costs were for buildings on spread footings and the highest cost for buildings supported throughout on piles with supported floors. A survey of the soil conditions throughout the site, assisted by numerous borings, indicated that the average cost would be about \$5 per sq. ft., and a budget was accordingly set up for exhibit buildings of \$7,000,000. Through good design and careful cost control, the space requirements have been more than satisfied by the construction of 1,159,000 gross sq. ft. at an average cost of about \$5.25 per sq. ft. The slight increase in average cost is entirely due to the fact that more Fair buildings were built on piles than was anticipated, due to the tremendous building program of exhibitors.

The temporary character of the buildings and the need for economy dictated a rather plain type of building, but

through the ingenuity of the design architects, many interesting forms and shapes have been worked into the structures without exceeding the cost limitations. The relatively simple character of the buildings also dictated the modern type of architecture, which will be characteristic of the entire Exhibit Area. In the Government Area the buildings by foreign nations will be generally of more substantial construction, and modern trend will not be so pronounced. In the Court of States there will be a group of thirteen buildings which will illustrate different early types of architecture in this country, including a replica of Independence Hall. In the Transportation Area the buildings are equally as substantial as those in the Government area will be.

As far as the Fair-owned exhibit buildings are concerned, it was necessary to rely greatly for effect on color, light and elaborate landscaping, and if the Fair is to teach any architectural lesson it will be emphasis on the necessity of the combination of all these elements in harmony with the design of the buildings themselves. Particularly interesting is the attempt to produce a gay and harmonious color scheme without varying contrasts or incongruity. The success of this effort may also be a lesson for the future.

Finally, in order to complete the decorative features, liberal use has been made throughout the site both by the Fair Corporation and by exhibitors of mural paintings and sculptures. At the schools of artists and sculptors we have given an opportunity to display their skill, and many comparatively recent techniques and materials have been used. Here also a strong effort has been made by the Board of Design to allow for a variety of thought, expression, and material without disturbing the harmonious whole.

In construction, the principle has been followed of finishing areas as fast as the buildings are completed. The planting of trees along all the main avenues started the moment the grading of the site was finished and is practically complete at this time. As soon as the last area of stucco has been completed on any building, the landscape engineers start grading, and planting. A majority of the trees have already been planted and the remainder are going in; two-thirds of the roads and walks have been paved and utilities are all in and operating.

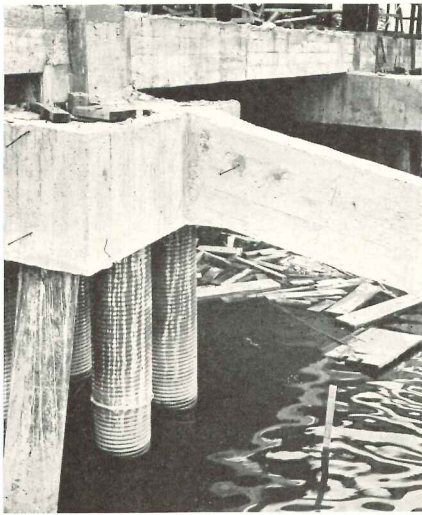

Concrete piling, New York Amphitheater.
 In and Robertson, architects.

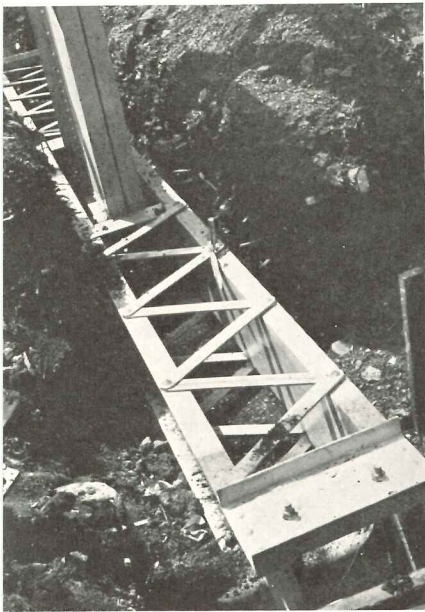

Cofferdam (above), Distilled Spirits Building.
 Piling (right), French Building.
 In and Robertson, architects.

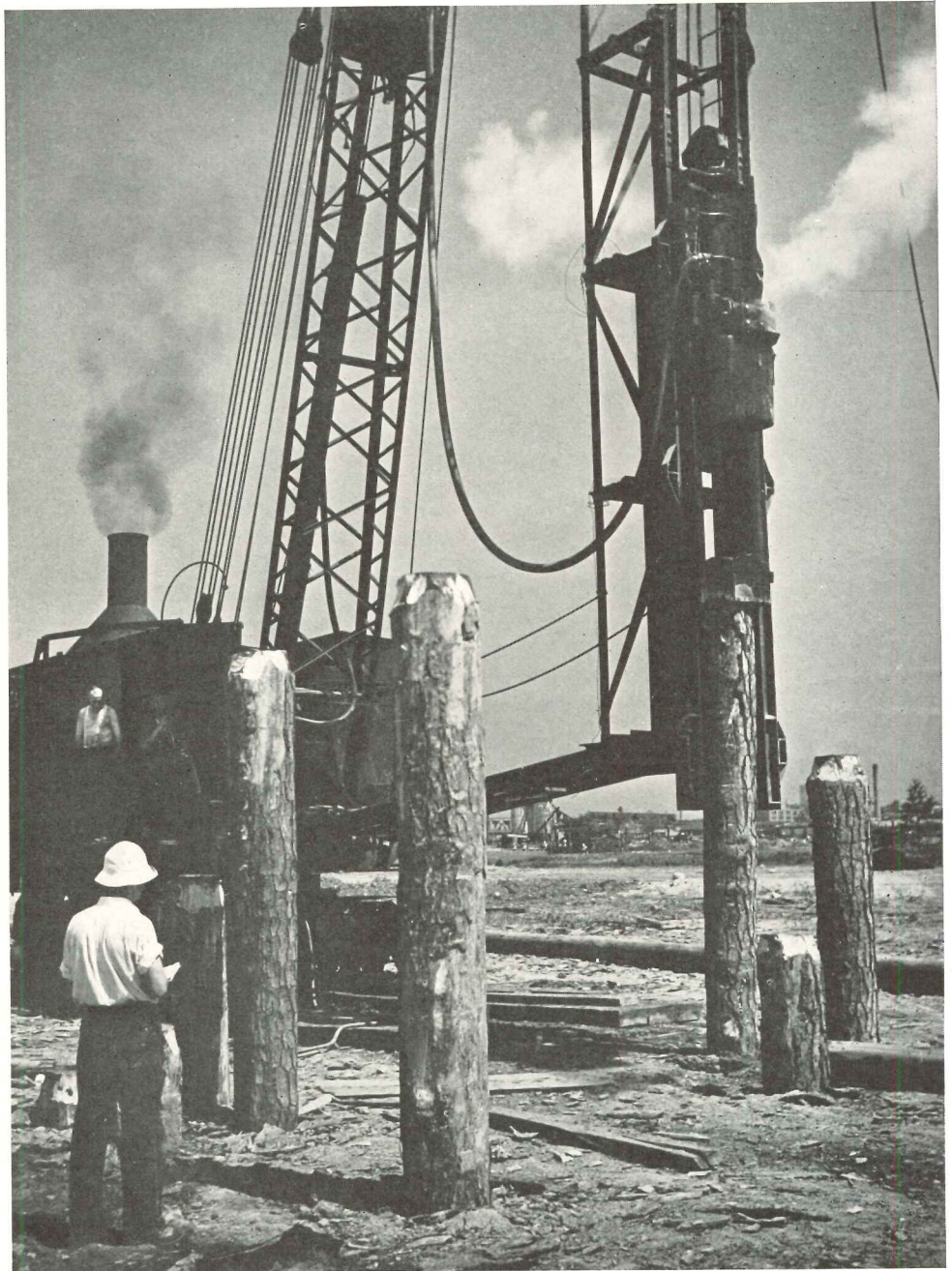

FOUNDATIONS

L. B. ROBERTS*

THE SITE selected for the New York World's Fair 1939 was known as Flushing Meadows—a tidal marsh over three miles long and more than a mile wide in certain places, traversed by a sluggish stream known as Flushing Creek. This location was regarded as ideal for such a purpose, due to its adequate area and its accessibility to high-speed transportation facilities.

The original swamp surface of matted vegetation covered a silt formation containing a high percentage of water which in places is as much as 80 ft. deep below high tide. Underlying this silt is a stratum of firm sand suitable for foundations.

For more than 30 years portions of this swamp had been used as a City dump, and some fifty million cubic yards of ashes and rubbish had been placed on the area. During the years when this material was being dumped, the fill in some places, had a total depth of over

125 ft., and its weight had forced the meadow surface downward 30 to 40 ft. below the original swamp level.

Ownership of the greater part of this swamp had been acquired by the City of New York for development as Flushing Meadow Park. An agreement was entered into between the World's Fair Corporation and the City of New York providing for the temporary use of the site by the World's Fair in return for which the latter would install extensive landscaping and other permanent im-

—

*Assistant Chief Engineer, New York World's Fair 1939

FOUNDATIONS

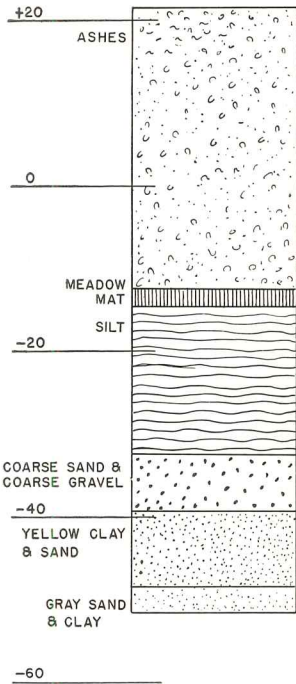

Typical test boring at Fair site, showing soil conditions which building designers faced and overcame with a variety of foundation designs

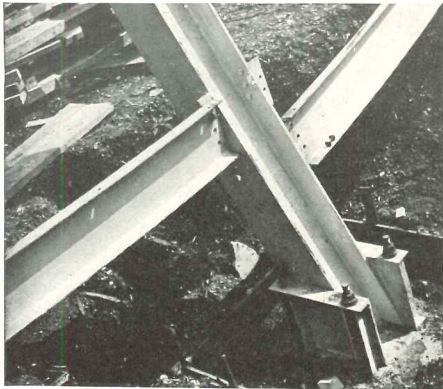

Footing, Distilled Spirits Building

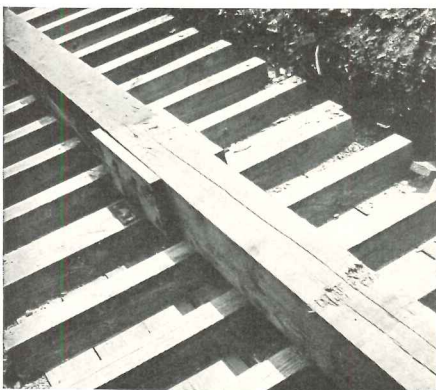

Spread timber footings, Gas Exhibits, Inc.

provements for the future park site.

The site was graded by the City of New York and this operation involved the movement of about 7,000,000 cu. yds. of rubbish material. This was spread over the low land and during the work the course of Flushing Creek was changed, a new channel created and two lakes having an area of 135 acres were developed.

When the grading was complete, soil borings and loading tests were made throughout the entire site. Test piles were driven and loading tests were made to determine the safe loading capacity of both the ash fill and the sand stratum underlying it. From the results of these tests certain general deductions were made for various parts of the site in advance of knowledge of proposed structural loadings. These basic conclusions have been summarized by Messrs. Foster and Glick as follows:*

"(1) That spread foundations for heavier constructions should be confined to the areas previously loaded by large depths of ashes, and where, after final grading, a considerable depth of ashes remained over the underlying silt and clay.

"(2) That where loads were to be placed in recently filled areas, settlements of considerable magnitude could be expected, and where ash fill over the Meadow was shallow, loads should be limited to a maximum of 300 lb. per sq. ft.

"(3) That where structures were to be built, filling should be done prior to the construction of the foundations.

"(4) That grading, or modification of existing grades, should be limited to a 3 per cent slope where the fill of ashes was relatively thin over the original ground."

*Engineering News Record, September 22, 1938.

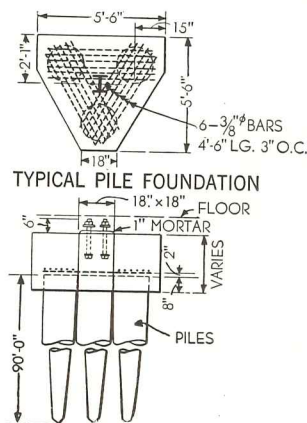

TYPICAL PILE FOUNDATION

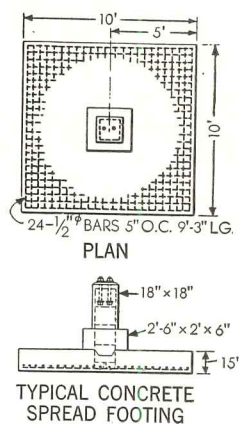

PLAN

TYPICAL CONCRETE SPREAD FOOTING

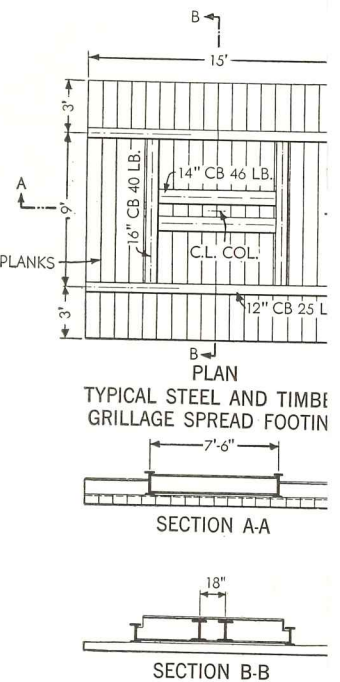

TYPICAL STEEL AND TIMBER GRILLAGE SPREAD FOOTING

SECTION A-A

SECTION B-B

Three of the major types of footings evolved to meet the soil conditions at Fair site. A fourth, entirely of timber, showed wide variations.

The pile driving operations have been on an extremely large scale. At present time over 470 miles of piles have been placed.

The actual driving of the piles under the conditions described—through mud mat surface and semi-liquid silt to firm bearing sand—is very interesting. Where the ash fill is thin, a hole is punched in it by a steel "spud" which is then removed. The pile is lowered in this hole and the steam hammer placed on top of it. Even a light tap will drive the pile and hammer as much as four feet as the pile passes through the silt. The pile meets resistance as it penetrates the underlying sand and this resistance increases until the desired bearing capacity is reached. It is also interesting to note that if the driving of a pile is discontinued at this point for only a limited period of time—often less than an hour—the pile is "frozen" in the silt and driving it again—often fifty blows are producing any increase in penetration. Maximum design loadings for piles average 18 tons. Test piles were loaded high as 36 tons.

Lighter structures are supported by spread footings, particularly in areas of deep ash fill. Building settlements were anticipated and damage has been avoided by providing joints to prevent cracking of stucco and walls. Settlement records of buildings confirm the design assumption cited above and continuing experience on the site indicates that the foundation problems have been satisfactorily solved.

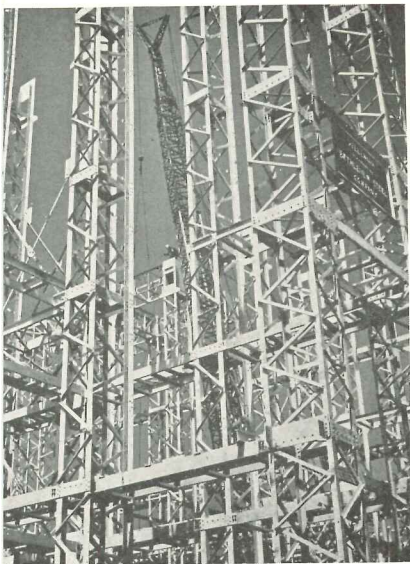

framing, U. S. Government Build-
Howard L. Cheney, architect.

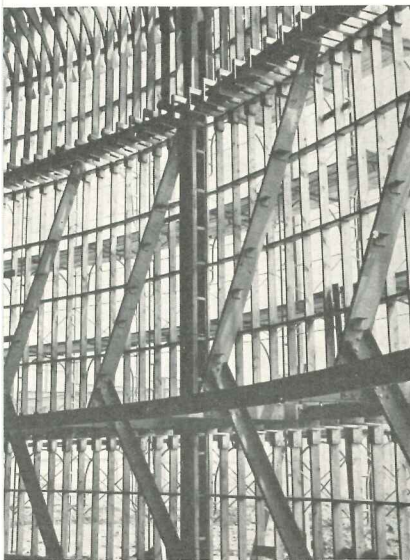

nal bracing, Consolidated Edison
poration Building. Harrison and
houx, architects.

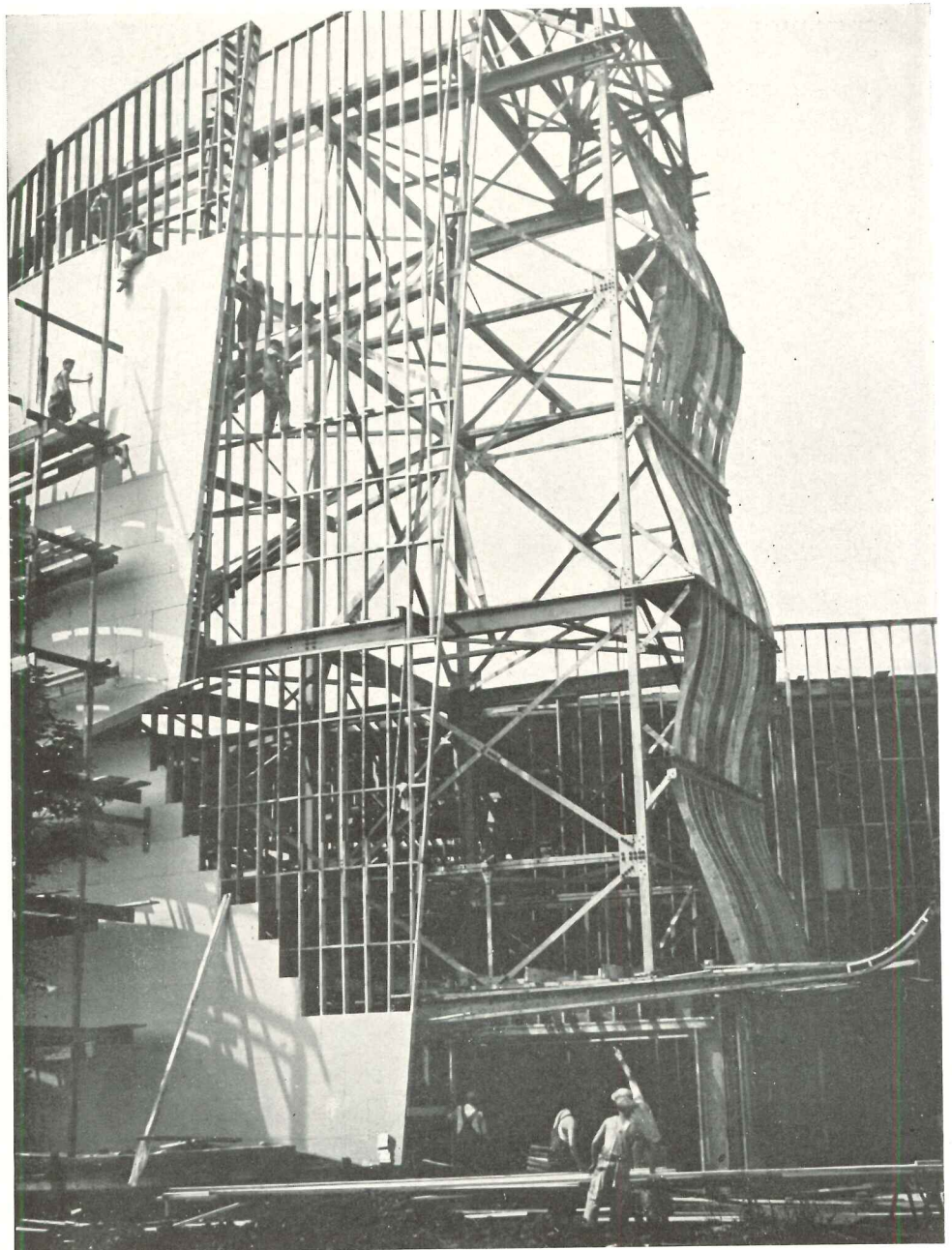

Steel framing, timber studs, and plasterboard. Main entrance, Hall of Pharmacy.

SUPERSTRUCTURE

IRVIN L. SCOTT*



WORLD'S FAIR Exhibit Buildings in general fall into two main categories: (1) Those designed and erected by the Fair Corporation itself for rental to prospective exhibitors, and (2) Those erected by private participants to house their individual exhibits. In the former group it was necessary that the design should be conceived along broad general lines to satisfy the then unknown specific needs of the greatest number

*Chief architect, Construction Department, New York World's Fair 1939

of exhibitors, whereas in the case of the exhibitor who elected to pitch his own tent, he was able to design his building around a pretty well determined type of exhibit. Fair-built buildings are, therefore, more or less standardized in plan as to depth of the exhibit space and circulation, and in elevation as to materials and absence of fenestration, for who could say what exhibitor would want windows and where?

Since the cost of the exhibit buildings has to be amortized, during the life of

SUPERSTRUCTURE



Aviation Building's solid-web arch trusses are swung into place.



Wood templates in place on dome of Distilled Spirits Building, timber studding follows.

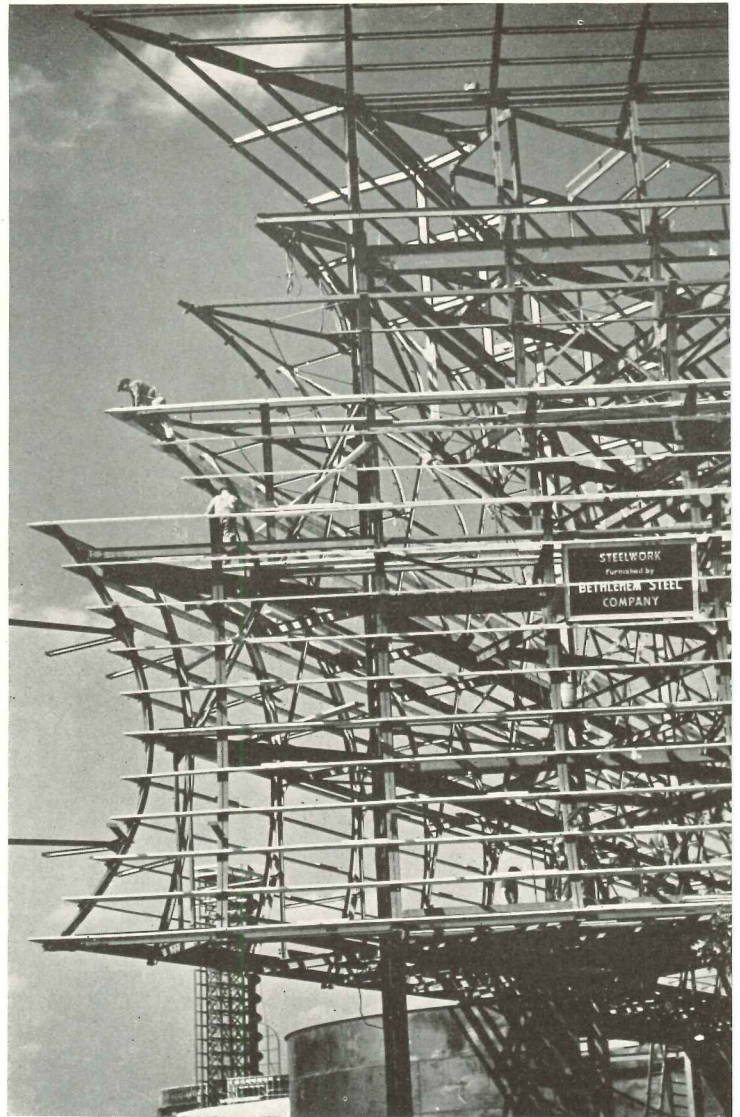

Special light steel framing on Petroleum Industry Building to accommodate exterior lighting design. Voorhees, Gmelin and Wa architects.

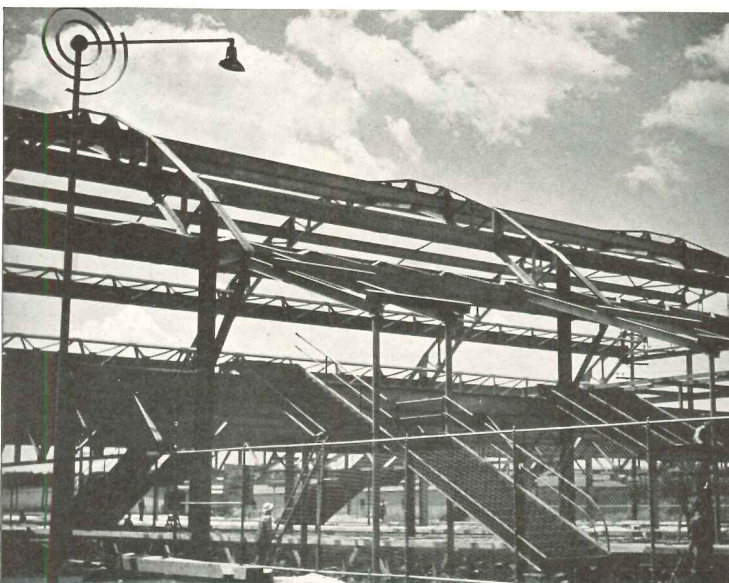

Left: trusses of Long Island Station.

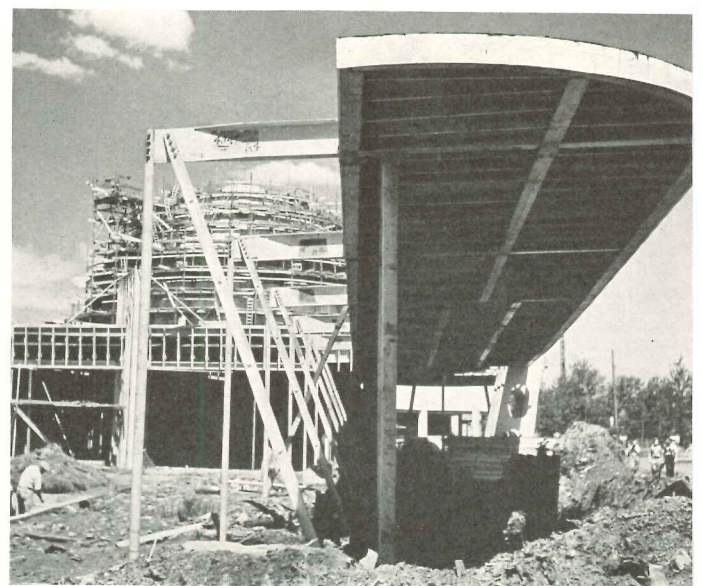

Right: cantilevered canopy, Distilled Spirits Building.

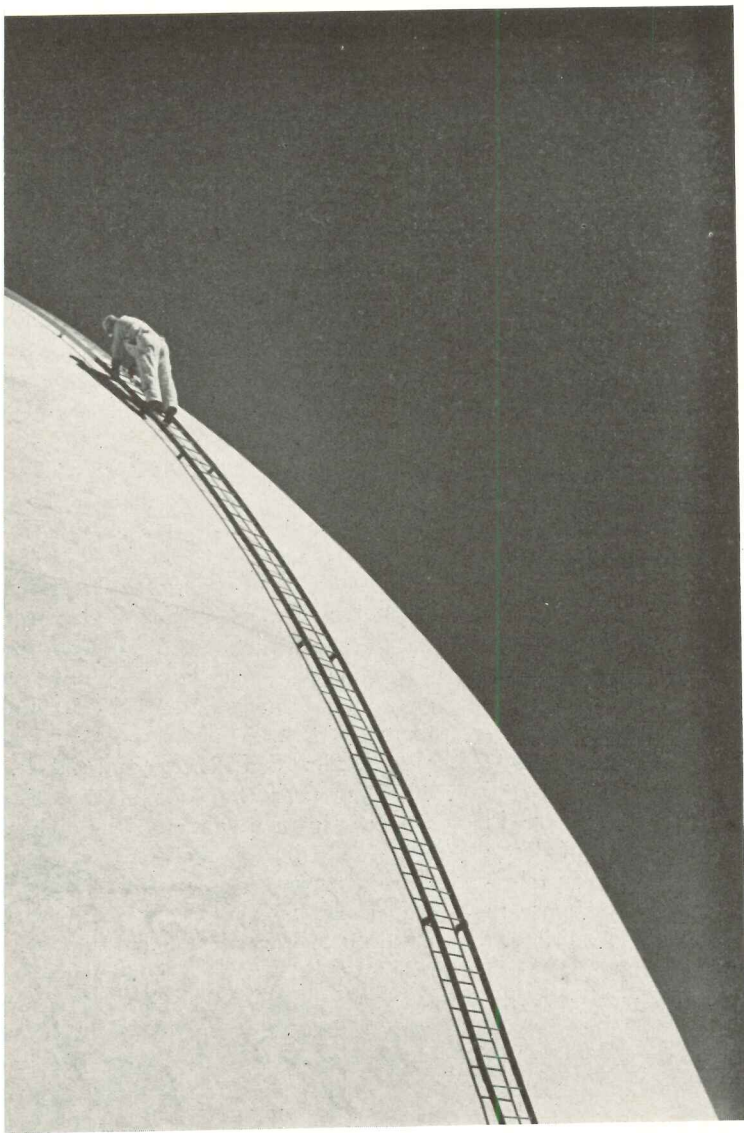

ting the dome, Food Building No. 1. Leonard M. Schultze and
ibald M. Brown, architects.

Fair, by the sale of space to partici-
nts, it was necessary that careful
lysis should be made as to what com-
ation of materials for the super-
ctures should effect the maximum
nomy and produce the best architec-
al effect. Many types of structures
e suggested and investigated, all the
y from precast cellular concrete walls
l roof, forming both the inner and
er "skin" to prefabricated sections of
called "bird cage" construction, with
cco or gypsum board applied to the
er and outer surfaces. None of these,
ever, offered the necessary economy
the one hand, nor the flexibility re-
red of expositional architecture on
other. The type of construction
ally adopted was the light structural
el frame with curtain walls of gypsum
rd, wire lath and stucco on 2 x 6 in.
ds between the supporting columns,
1 wood framing resting on trusses or

girders with sheathing and three-ply
built-up roofing forming the roofs. By
and large, this type of construction has
been followed by the private exhibitor,
either taking his cue from the analysis
made by the Fair Corporation or from
his own independent studies. However,
in the programming of the Fair-con-
structed buildings, the skin covering of
stucco was suggested but not made
mandatory. Where the designing archi-
tect elected, he could suggest other ex-
terior treatments provided they did not
exceed the cost of stucco. As a result,
there are such interesting deviations
from the rule as the sand-blasted verti-
cal red-wood siding on the Community Arts
Building, and the corrugated V-beam
sheets forming the outer skin of the
Cosmetics Building.

Also in the private exhibit building of
the A. T. & T., 3/16-in. asbestos boards
in 4 x 8 ft. sheets have been applied with



Stucco on metal lath, Transportation Building. James
Gamble Rogers, architect.

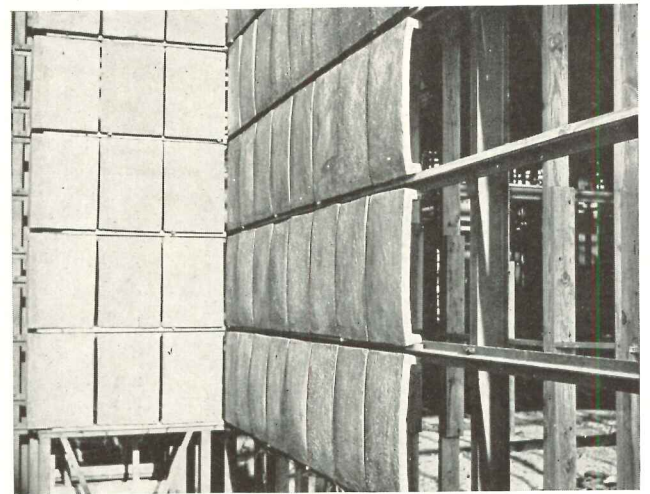

Tile plates, carried by steel angles and with mastic-filled
joints, form external facing of Belgian Building.
Van de Velde, Stynen & Bourgeois, architects.

wide joints to the gypsum board back-
ing, giving an interesting pattern that
lends relief and variety to the general
architectural effect.

It is a requirement of the Fair code
that, in general, structural members be
protected by a material having a fire re-
sistive rating of at least 1/2 hour. This
naturally has ruled out the use of ex-
posed steel as an architectural expression
except in certain cases where a deviation
from the Code could be justified or
where no combustible materials were
used in connection with the steel struc-
ture. An example of this is the main
exhibit hall of the Aviation Building.
Here the architects suggested spanning
the hall with a series of three centered
steel arches of increasing magnitude,
tying these together with connecting
beams and purlins. Quite naturally,
fabrication cost ran high but this was
offset by the fact that the protection

SUPERSTRUCTURE

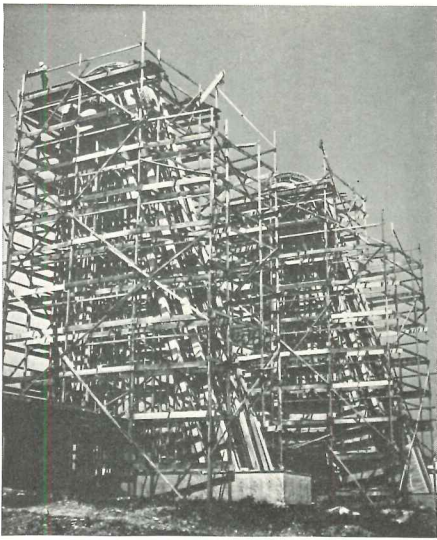

Wood scaffolding on Transportation Building.

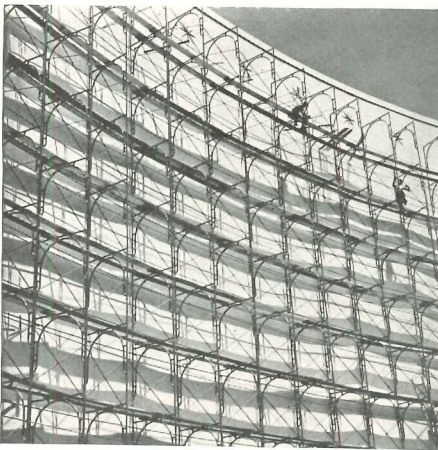

Lightweight, prefabricated steel scaffolding for Communications Building.

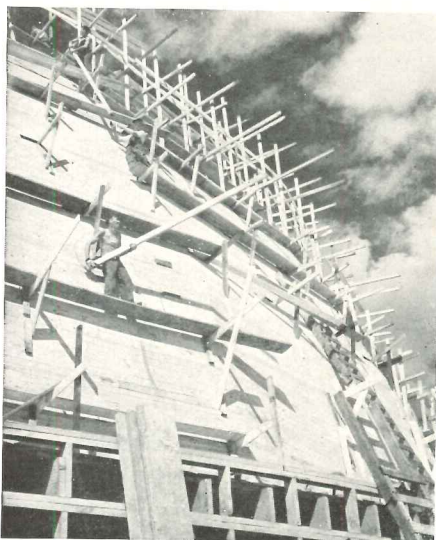

Wood sheathing on semisphere of Aviation Building.

from the weather is afforded by a single skin covering on the exterior of corrugated steel sheets protected with saturated felt and aluminum foil, leaving the well-designed steel arches exposed to view on the interiors.

This treatment exists "in reverse" in the case of the U. S. Steel Building. Here it was natural that the exhibitor would want to attract attention to his own product in the construction of his building. Accordingly, a smooth stainless steel "inner dome" is suspended on the inner chord of the main supporting steel arches which are left entirely exposed to view from the outside. Other lower elements of the building carry out the theme, the whole forming a fine expression of the use and function of steel.

From a point of view of fabrication, it is interesting to note the steel superstructure of the Belgian Building. Having been designed and fabricated abroad, it forms a graphic picture of the relative costs of labor and materials in Belgium as compared to this country. One is immediately struck with the use of small members throughout. Where in this country a steel member of large section would be used to cut down fabrication and erection cost, they choose to use several small members so fabricated as to perform the same function, with a resulting economy in material but with a large increase in man-hours of labor; a practice prohibitive here. Another feature of interest in this building is the skin covering of rough terra cotta tile approximately 2 in. thick, 18 in. wide, and 2 ft. long. These are supported directly on light horizontal steel members and pointed up with mortar after erection. Wood is used only as interior furring.

Perhaps the most novel type of construction to be seen anywhere on the site is that of the dome of one of the Food Buildings built by the Fair Corporation. The diameter exceeds 100 ft. and rises to a height of 90 ft. from grade. Its main structural members consist of vertical studs cut to radius from 3 x 14 in. wood members. Each tier of these was notched to receive a 3-in. pipe ring around the circumference. The next tier of studs were correspondingly notched to fit over this pipe ring and so on upward, the wood members and pipe rings diminishing as they near the top. The outer surface was then sheathed with diagonal wood sheathing after which felt roofing was applied. A broad meshwork of pencil rods was then laid over the dome to which was wired metal lath for the final

stucco skin. The inner surface of dome was sheathed with gypsum board making an entire thickness from inner to outer skin of not over fifteen inches.

Space does not here permit even a hasty reference to all the varied and interesting forms of construction to be seen at the site. No review, however, would be complete without a mention of the dominating architectural feature of the Fair, the Theme Center, composed of the Perisphere, Trylon, and Helicline. Though based on the simplest of geometric forms, the structural difficulties of the Perisphere have seemed to increase as the square of its diameter. Here again, numerous were the suggestions as to how to construct it—"reinforced concrete," welded steel plate "bird-cage", and stucco, all were investigated and somewhere found wanting. In the end, the structural steel framework was adopted. In its final design, it consists of 32 meridian trusses, running from the zenith and connecting to a ring girder 8 ft. deep and 72 ft. diameter near the base of the sphere which is in turn supported by eight columns. Horizontal members connect the meridian trusses at various stages and the whole basic framework is overlaid with curved vertical purlins 4 ft. apart at the equator, on which is applied the wood nailers for the final skin covering. This latter consists of two layers of gypsum board with staggered joints and a coat of waterproofing between each layer. On top of this are applied two layers of burlap successively trowelled into two 1/4-in. coats of a magnesium type of stucco, after which a final finish coat of magnesite plaster is applied and steel trowelled. Two coats of chlorinated rubber base paint will be applied for additional waterproofing and coloring.

The Trylon, rising 700 ft. from the bottom of its foundation, has a structural steel frame to a height of 500 ft. and from this point a self-supporting exterior sheathing of riveted steel plates. A skin covering similar to that of the Perisphere will be applied flush with these steel plates and the whole painted with rubber base paint.

The Helicline, descending from the 50 foot level of the Trylon to grade, encircling the Perisphere is an 18-ft. ramp supported on single tubular columns of varying sizes and spacing about the centre of its run. The soffit curves upward on either side to meet the dome and is covered with brushed stainless steel sheets studded with polished rivets. The balustrade will be of transparent wire glass.

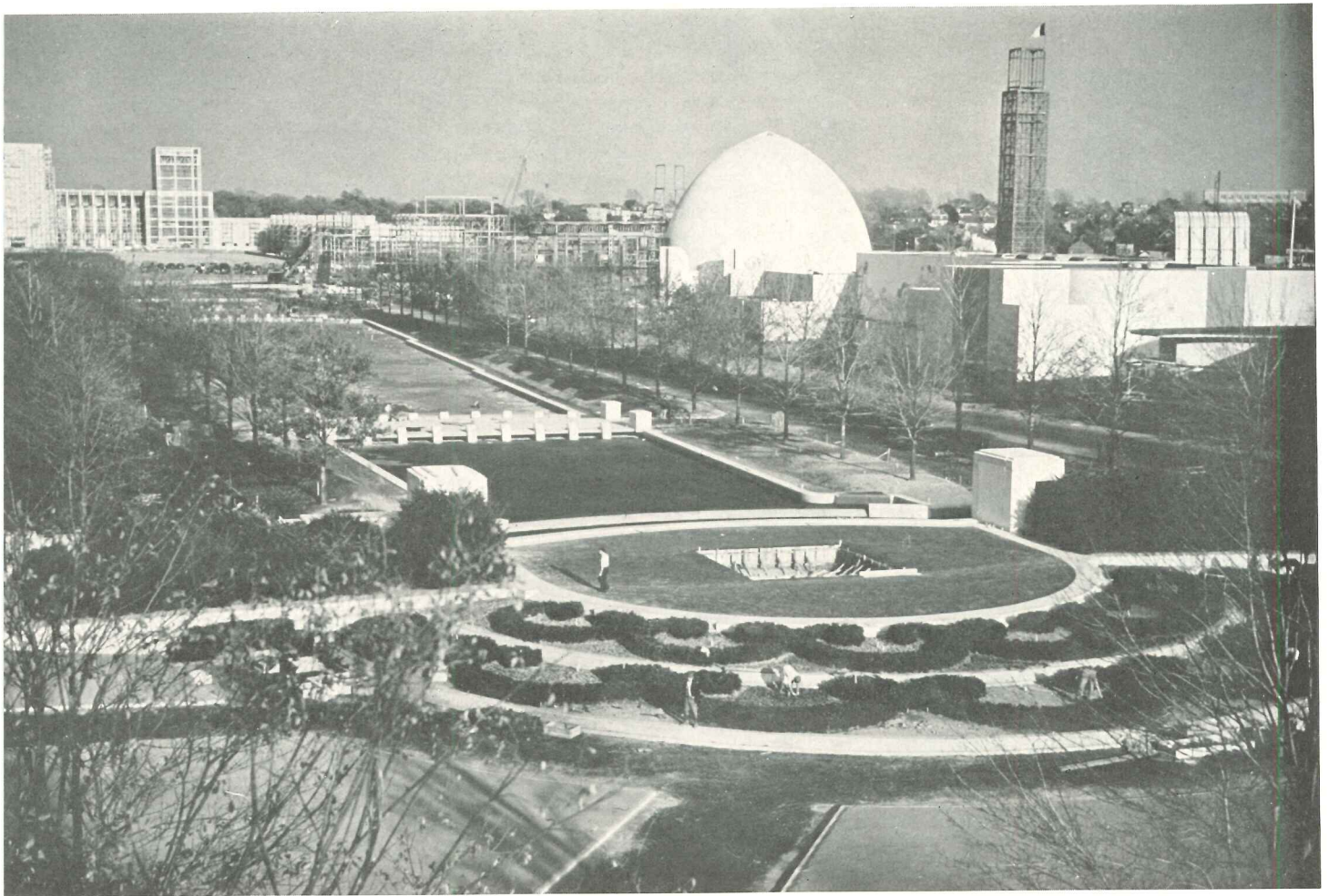

L A N D S C A P I N G

GILMORE D. CLARKE*

THE MEMBERS of the Board of Design met together for the first time late in January, 1936. The task before them was not a simple one, considering the fact that a theme and a general plan for a development were required within a period of three months. The site had been a dump and swamp developed into a great garden; a place where, a short time years later, millions of people would be entertained as guests of the City of New York through the New York World's Fair Corporation headed by Grover Whalen.

The development of the plan was carried on concurrently with the evolution of a Theme, the latter under the guidance of Board Member Robert D. Kohn.

Member, Board of Design, New York World's Fair, 1939

Normally, a World's Fair plan is devised to serve a single purpose, that of a fair: this one, however, had to be designed to serve two purposes—first the Fair, and after the Fair a great park. The land the Fair occupies is owned by the City of New York and is under the jurisdiction of the Park Department. The lease gives the head of that Department, Robert Moses, control over certain factors in the development, among them approval of the general plan to the end that the basic pattern for the Fair would serve adequately for park purposes later.

One might think it impossible to lay out a satisfactory two-purpose pattern on a grand scale covering an area of 1,216½ acres; and that, to accomplish such a purpose would result in a compromise for one scheme to the other. It seems that the axial pattern developed within the first three months by the Board of Design admirably fulfills the

dual purpose for which the plan was devised. In any event, it pleased the Directors of the World's Fair and was approved by the Park Department.

The deep swamp, overlaid with a mat of cinders, presented problems which required much study and necessitated that the special factors relating to soil conditions be kept uppermost in mind throughout the development of the scheme. For example, the transportation sector, requiring the installation of heavy machinery, was located between Grand Central Parkway and 111th Street, the only section providing fairly solid ground with no underlying swamp.

The pattern of the Fair was laid out, having in mind the creation of a central Theme Center—the Perisphere and Trylon—with a number of theme subcenters around which the several major subdivisions of the Fair are being developed. The New York World's Fair was not conceived as a prototype of any other

LANDSCAPING



"American Womanhood", Gaetano Cecere, Sculptor.

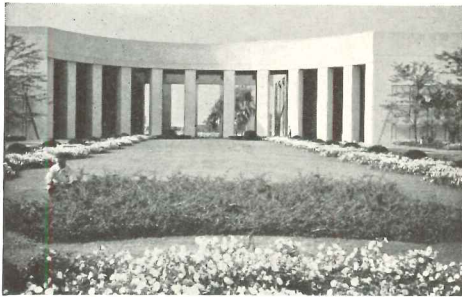

Gardens of New York City Building, looking toward Business Systems and Insurance Building. Eric Cugler, Slee and Bryson, architects.

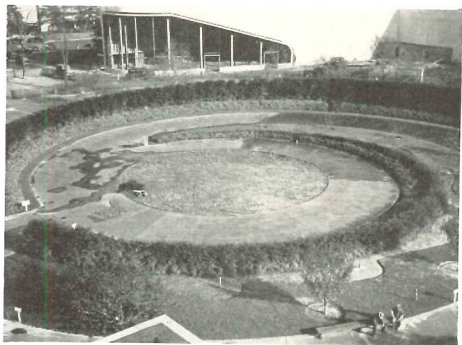

Spiral gardens, Court, Hall of Pharmacy.

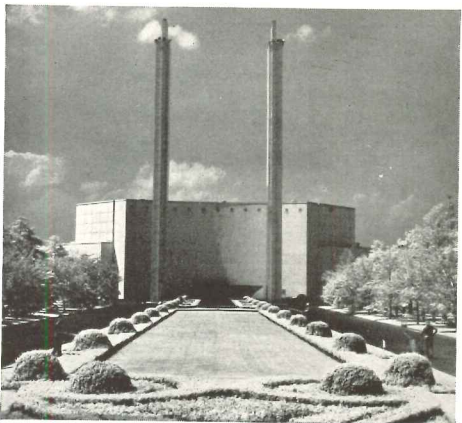

Court of Communications Building.

pattern of a city or garden: true, it has a central axis along which a great mall has been developed. In that respect, it may have some relation to Versailles, or other French monumental compositions. If that is so, the park was evolved as a result of the functions and requirements of the Fair combined with the restrictions and advantages provided by the site. The principal asset is its location almost at the geographic center of the city, providing potentially adequate transportation services by water, rail and road. The visitor will easily find his way around on foot or by means of several types of vehicular transportation. There is no main entrance; rather, there are several entrances of more or less equal importance. Thus, the people are immediately decentralized upon arrival, resulting in a minimum of congestion.

Not a tree or bush was left upon the site when the grading operations had been completed. At the very beginning, when budgets were being discussed, the estimates to provide adequate planting amounted to more than \$1,500,000. A sum greater than that was granted and during the spring and fall of 1937 one of the largest big tree moving programs ever attempted was carried out. For example, elms in the Theme Circle have trunks more than eighteen inches in diameter, and the trees are sixty feet high. (The fact that the trees were planted two years in advance insures that they will be well acclimated before the opening day, April 30, 1939.) These and the thousands of other trees in great variety will supply the necessary shade for the malls and combine to create many delightful compositions with the architecture and its mural decorations, the sculpture, flags, and fountains—both in daylight and nightly splendor. All the large trees are in locations where they will grow on to maturity in the Flushing Meadow Park of tomorrow. They are mature now; they will grow to a ripe old age and give enjoyment to countless millions in years to come. And so these living reminders of the New York World's Fair of 1939 will be perpetuated for those who visit the park in later years.

The Fair will be a great, colorful garden of a magnitude never before realized in America. Almost three quarters of a million bedding plants will be used. The Holland Government has donated over one million flowering bulbs, the large majority, of course, being tulips. The display of these bulbs and bedding plants in carefully designed gardens will

be one of the most noteworthy displays of the Fair. It will demonstrate the old art of bedding may be adapted to the present modern trends in architectural design and result in several dramatic compositions of formal geometric patterns in wide ranges of color in harmony with the gay colors of the architecture and the murals. Once more shall use petunias, lantanas, anemones, phlox, verbenas, tagetes, heliotropes, ageratum, and geraniums by the thousands in mass display for dramatic effects. Hedges of taxus, privet, laurustinus, thuja, hemlock, and other material planted to form varied and fantastic effects.

The gardens and courts about the Theme Center and those along the main arteries of circulation were designed by the offices of the Board of Design. Flower bulb and flower displays were patterned and arranged by Miss M. B. Sprague. The courts and gardens provided by the Fair were designed by Landscape Architects A. F. Brinckerhoff and C. D. I. Mr. C. N. Lowrie is Landscape Architect for the large lake area between Face Harding Boulevard and 69th Road. The several gardens of private exhibition buildings were planned by several landscape architects chosen by the exhibit Plans for these gardens received the approval of the Board of Design before going forward, thus enabling the layout of the minor parts to be coordinated with the general scheme of the Fair.

The co-ordination of the various phases of the work at the Fair is a noteworthy example of co-operation between many men and women of different professional fields of endeavor. The work of the magnitude of the New York World's Fair could not be a success without the closest kind of collaboration between the arts; of the arts with engineering, and of both of these with manifold fields of endeavor which enter into this most complex work.

Enterprises of this sort often go along with the interesting personalities involved in it completely submerged. I do not out of the question to mention here the names of all those who contributed ably in the development of the design of the landscape of the Fair, but the writer cannot end this article without paying tribute to the man who had charge of the preparation of specifications, purchase, inspection, delivery and planting of all the plant material, Mr. Henry Nye. It is the biggest job of its kind ever accomplished within a short period of years.

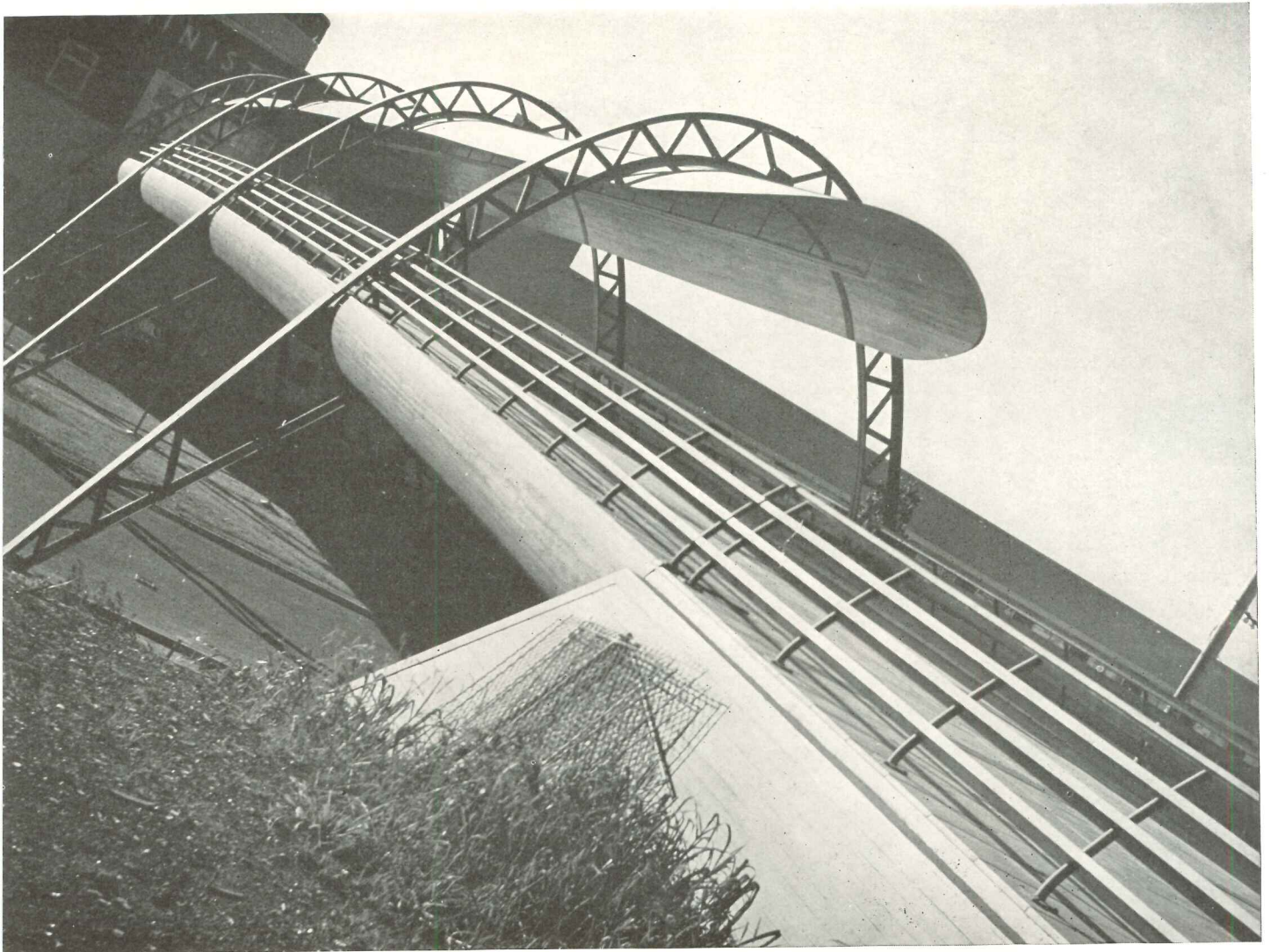

pedestrian overpass. Fair Board of Design: Michael L. Radoslovich and Arthur Barzaghi, designers.

C I R C U L A T I O N

STEPHEN F. VOORHEES*

CONSIDER, first, external circulation, the problem of getting people to the Fair.

The Site is located near the center of the population of Greater New York. It is possible to reach it from any of the five-cent fare subway systems in the city.

This was one of the factors which influenced the choice of the Site for the Fair.

Both the I.R.T. and the B.M.T. elevated tracks running from Queens to Main Street in Flushing. This track cuts the western end of the Fair and additions to the Willetts Point station are being built with an overpass to carry the people directly into the Exhibit Area. It is estimated that a peak of 40,000 visitors per hour can be expected through this gate. On this side of the Fair also is the Long Island

Chairman, Board of Design, New York World's Fair, 1939

Railroad which is also enlarging its facilities. A special station is under construction and it is estimated that some 18,000 passengers per hour will be brought from the Pennsylvania Station.

At the other side of the main exhibit area will be the terminus of a spur being constructed by the Independent Subway System. This station will discharge passengers into one of the principal plazas of the Amusement Area and facilities will be available for handling 40,000 people per hour.

While these three means of transportation will bring the vast majority of visitors to the Fair, a not inconsiderable number will come by bus and private car. In cooperation with the Department of Parks and the Queens police officials carefully calculated routings for automobiles are being worked out. The Tri-

borough Bridge will lessen somewhat the load on the Queensboro Bridge, and the new Whitestone Bridge will be open in time to divide the traffic still more by providing a short cut for cars from New England and the North. On the Fair Site, but outside the turnstiles will be parking fields to accommodate a total of 40,000 cars. Private cars will discharge passengers at the gate on Horace Harding Boulevard and the Corona Gate. The Corona Gate on 111th Street will also be the entrance for passengers arriving by the various bus lines.

While the number of passengers expected is not large, it should be noted that facilities will exist for coming to the Fair by water. A boat basin and landing dock are being prepared on the edge of Flushing Bay adjacent to the Site. Also the North Beach airport is within five

CIRCULATION

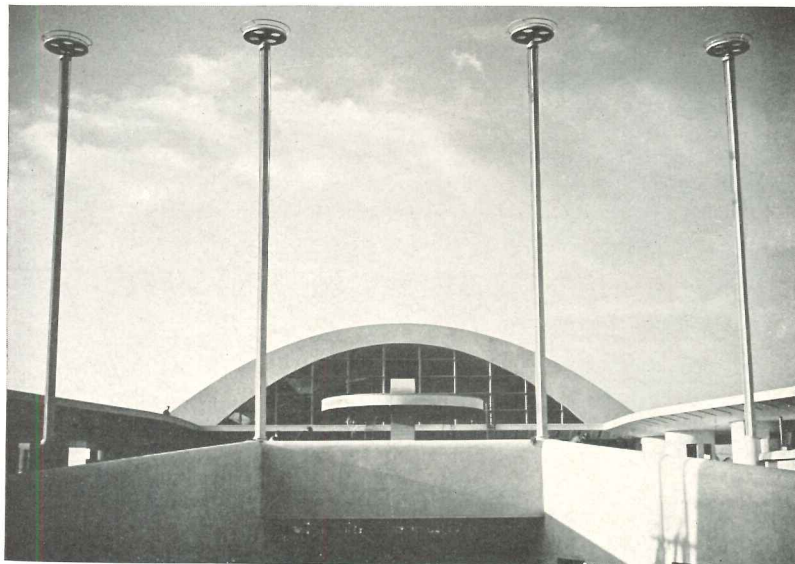

Approach ramps to Long Island Railroad Station. Fair Board of Design: Michael Radoslovich and Irwin L. Scott, designers.

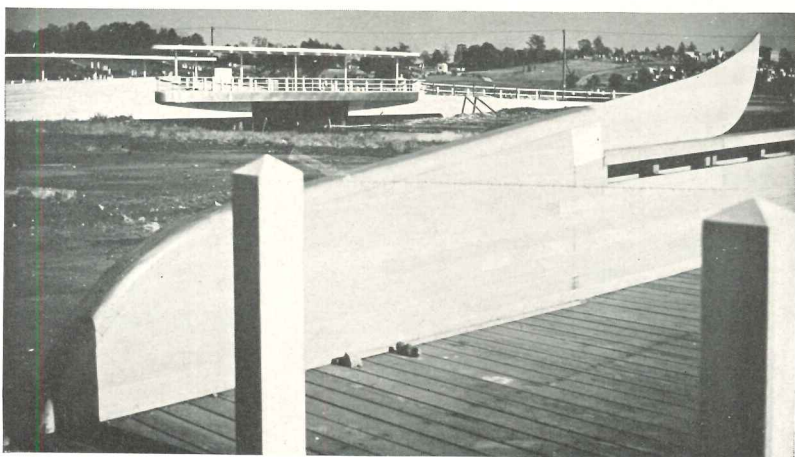

Passenger bridge, Amusement Area. Fair Board of Design, architects.

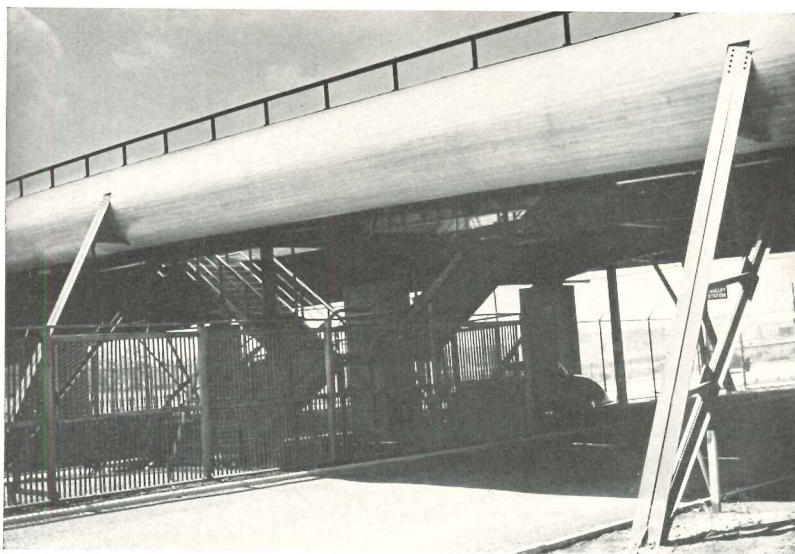

Temporary pedestrian additions to permanent bridge at Horace Harding Blvd. Fair Board of Design: Michael L. Radoslovich and Arthur Barzaghi, designers.

minutes' motor distance from the Grounds.

Within the Fair, circulation has been planned, not to lead visitors through a pre-conceived logical scheme, but to make it as easy as possible for visitors to follow their own whims and interests. The logical arrangement that might be appropriate for a museum cannot be adapted to the purposes of a Fair where the crowds to be handled are much larger and the material to be shown is not subject to logical arrangement. The great objective in handling Fair crowds is to make it easy for visitors to find their way about, and to so arrange various exhibits and attractions to spread the crowds over as large an area as possible. The Fair has been deliberately planned on a large scale. A generous amount of landscaped space is provided around both the Fair Corporation buildings and those of the various exhibitors. The streets are wide and full advantage has been taken of the fact that after the Fair, the Site is to become a Park. Much of the planting for the future park is already done.

Each of the principal gates leads directly into an open plaza and each plaza has several attractive vistas. Thus, entering crowds will be spread throughout adjacent exhibit areas rather than guided along single paths. The visitors will be assisted in orienting themselves by several conspicuous monuments which will help them identify various gates and important buildings. The chief of these, of course, is the Tylon and Periscope which occupy the Theme Center, the highest point on the Fair Site. From standing towers and pylons at various other points combined with available maps will enable people to find their way about the grounds easily.

A concession contract has been awarded to the Greyhound Bus Lines for an intramural bus system covering the whole Fair. Bus routes are planned to avoid pedestrian crossings as much as possible and at no point will pedestrian and bus traffic be routed together. Arrangements are now being discussed for some form of transportation for individuals.

Nearly all of the exhibit space and buildings by the Fair Corporation will be on one level and very few of the exhibitors who are building their own buildings are planning for more than one floor. Thus stairs will be a rarity and changes of level where they do occur will be accomplished by ramps.

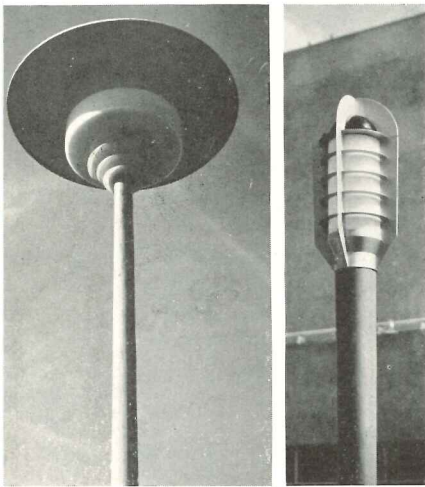
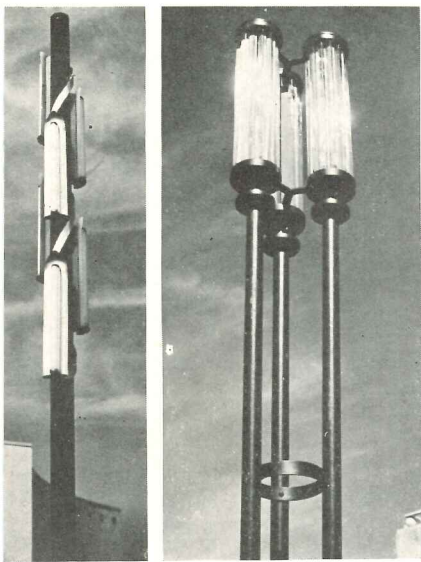

above, four light standards. Fair Board of Design, architects. Right, joint towers, Textiles Building.



light tower, Information Booth. Fair Board of Design, architects.



L I G H T I N G

STEPHEN F. VOORHEES

LIGHT AS WELL as sound will be controlled in the interest of visitors to the Fair. All possible cooperation has been given to the various exhibitors to enable them to make advantageous use of lighting effects but within rules which prevent annoyance to the public and unfairly competitive displays. The use of lighting effects by any exhibitor, for example, which would detract from the effect of neighboring exhibits is forbidden. Decisions on such questions rest with the Fair's Board of Design and its lighting technicians.

The Fair itself, as is the case in the field of sound, is using the most advanced developments to create novel and beautiful effects. An example is the use

of the new source of light, the capillary mercury tube. Light from these tubes is picked up by the green coloring matter in foliage. A dramatic and interesting effect will be created along the main esplanade by illuminating the trees from beneath with this type of light.

The great sphere of the Theme Building, white and opaque by day, will at night seem to lose its solidity. Lighting effects which have been evolved during two years of research by the Fair's technicians will give the sphere the appearance of a huge luminous globe like an iridescent soap bubble filled with moving clouds and color mist. The Perisphere is one focus in the gigantic display of light and color which will animate the



Light fixture. Fair Board of Design, architects.



Aqualon, combination light fixture and fountain. Fair Board of Design, architects.

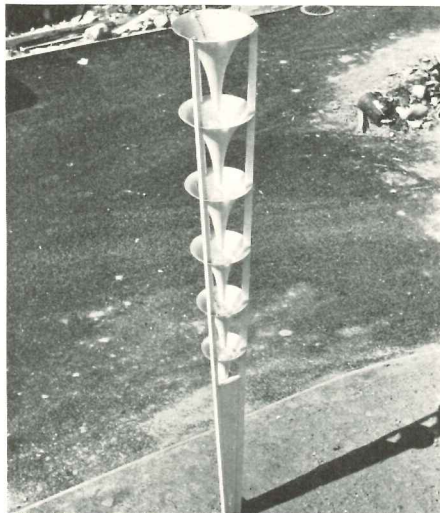

Indirect lighting fixture, using conventional incandescent lamps. Fair Board of Design, architects.



Zeon lighting on Information Booth. Fair Board of Design, architects.

Fair at night. At the other end of the Mall will be the body of water named the Lagoon of Nations, approximately 800 ft. long and 400 ft. wide. The Lagoon will be the scene of displays combining light, sound, and color in a way never before attempted. In the center of the Lagoon is a submerged platform nearly 400 ft. long and 150 ft. wide. On it are mounted over 1,400 water nozzles, 400 gas nozzles, containers for fireworks, and 500 lighting units with various types of lamps and a apparatus for color changes. This equipment is partly submerged; the parts above water are camouflaged in the appearance of water flowers or forms of decorative shapes. Camouflaged to the likeness of huge flowers will be the openings of the sound projectors mentioned above. Each of the elements will be controlled from a single room on the roof of one of the government buildings. Here a board resembling a huge organ console will be operated by three men and a director. A number of compositions for this great instrument are in preparation.

Other dramatic effects are in preparation for Meadow Lake which lies south of the amusement section of the Fair. Here, from barges which can be moved about in the lake to vary the pattern, more compositions using water and light will be created.

Some measure of the effectiveness of these spectacles can be found in the fact that when a model was set up to demonstrate them in miniature, so many showings became necessary that the model finally had to be dismantled.

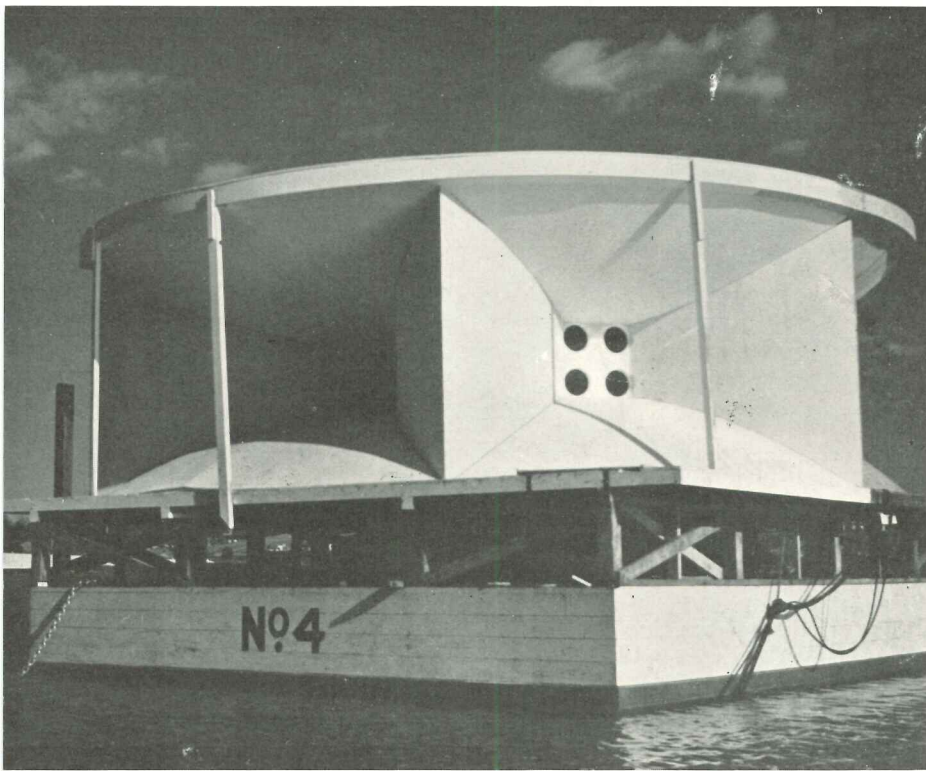

Some of the floating amplifiers "anchored" offshore on Meadow Lake to be used in conjunction with water carnivals.

S O U N D

STEPHEN F. VOORHEES

SOUND WILL be controlled by the Fair to protect the interests of visitors to a greater extent than has been done in most of the recent fairs. The Corporation itself is opposing any use of either light or sound which could conceivably become annoying to visitors and is enforcing the same principle on the private exhibitors. This means first of all that the Fair Grounds will not be dotted with loud speakers as was the case in some of the recent fairs. The visitor will not have the feeling of being able to turn off a neighbor's radio as he walks about among the exhibit buildings; and within the buildings, the use of sound by each exhibitor will be restricted to prevent people in other exhibits from being distracted. In other words, both the Fair Corporation itself and the various exhibitors will use sound only in two ways—first as a background to create atmosphere, and as a part of an artistic presentation to the public. The additional barkers standing before exhibits competing with each other will be entirely absent and even the more mod-

ern version of the same scene in which competing loud speakers blare at passers-by will be absent.

The Fair will have, however, a comprehensive sound system. It will be centered in a specially reserved section of the Communications Building. Here the amplifiers and technical equipment of the sound system will be set up as an exhibit by the Fair Corporation. There will be small studios where speeches and musical programs can originate either for broadcast or for the Fair's Public Address system. Here also will be a Fair sponsored exhibit of sound equipment and provision for explaining to the public the detail operation of a large example of modern sound engineering.

Carried on the wires of the regular telephone system the programs will be sent to sixteen speakers or sound outlets. There will be one inside each of the main entrances to the Fair to give incoming visitors a feeling of the festive spirit that should characterize a Fair. There will be other speakers at strategic

points on the grounds—one on each of the bridges connecting the transportation area with the main exhibit section and one in the main plaza of the amusement section. These will aid in leading crowds from one area to another.

This Public Address system will be built from stock equipment and will be a more or less standard example of modern methods of handling sound. Of more spectacular interest will be the specially designed equipment installed for particular purposes at the Fair. Among the spectacles presented by the Fair Corporation will be the shows combining water, fire, and sound on the Lagoon of Nations. Combined with the dramatic use of gas jets, fountains, and fireworks will be sound effects and especially composed music emanating from sound reproducing equipment especially designed for this purpose. All the equipment, from the records through the various amplifying devices to the loud speakers is being created by the most competent sound engineers especially for this purpose. The speakers will send out sound of a lower frequency than is possible from any standard equipment and will be capable of delivering an enormous volume of sound.

Perhaps the most spectacular of the Fair's special sound equipment is that which is being built under the Perisphere. The engineers in discussing the possibilities of music and sound effects around the Theme Plaza discovered that the curve of the Perisphere constitutes a very rough approximation of the horn of a loud speaker. To make this approximation more complete, a pit roughly fifteen feet deep, is dug under the sphere—its walls are of a shape calculated to simulate a section of a horn. In effect the lower half of the sphere, the surface of the water under it, and the walls of the pit will constitute an enormous annular horn. Sound originating under the sphere will spread out in all directions except into the interior of the sphere which will be protected by sound proofing material. These shapes will form the equivalent of a horn whose mouth is over 100 ft. in diameter and whose length is well over 100 ft. The designers of this sound system are certain that vibrations down to sixteen cycles a second can easily be created. This will give an effect in the open air similar to that caused in cathedrals by the vibrations of sixteen-foot pipes. This will be, in other words, far and away, the largest loud speaker ever created and will assure effects never before attempted.

*The advertising message below
is now being carried to millions of readers
through the pages of The Saturday Evening
Post and Time Magazine.*

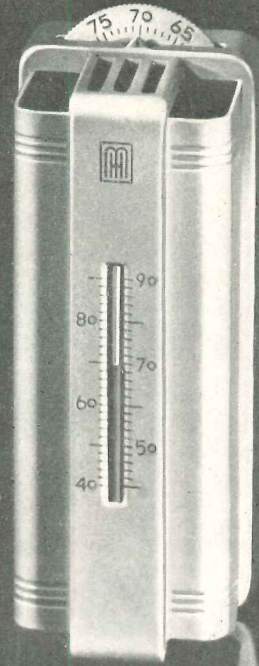
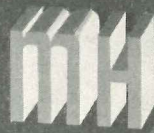

THE *Symbol* OF THE NEW AUTOMATIC HEATING

Comfort Marches On . . . The smartly styled Acratherm and its identifying "M-H" monogram, symbolize improvements in all types of automatic heating which have brought to home owners an experience in winter comfort undreamed of even a few short years ago. More than a thermostat, the Acratherm is

visible evidence of the seldom seen "M-H" control system, which actually makes automatic heating automatic. Your dealer can and will supply complete Minneapolis-Honeywell Controls with his equipment. Look for the "M-H" Symbol . . . It is your assurance of lasting, carefree heating comfort.

MINNEAPOLIS-HONEYWELL

BROWN INDUSTRIAL INSTRUMENTS · NATIONAL PNEUMATIC CONTROLS
MINNEAPOLIS-HONEYWELL REGULATOR COMPANY . . . MINNEAPOLIS, MINN.

Control System

BUILDING TYPES



F. S. Lincoln

HOUSES \$25,000 and up

FORTHCOMING STUDIES: Office Buildings—December; Restaurants—January.
PRECEDING 1938 STUDIES: Houses (\$15,000–\$25,000)—October; Apartments—September; Hospitals—August; Theatres—July; Factories—June; Schools—May; Houses (\$7,500–\$15,000)—April; Houses (\$7,500 and under)—March; Retail Stores—February; Hotels—January.

ARCHITECTURAL
RECORD

COMBINED WITH
AMERICAN ARCHITECT AND ARCHITECTURE

Houses Costing \$25,000 and Up

ILLUSTRATED CASE STUDIES

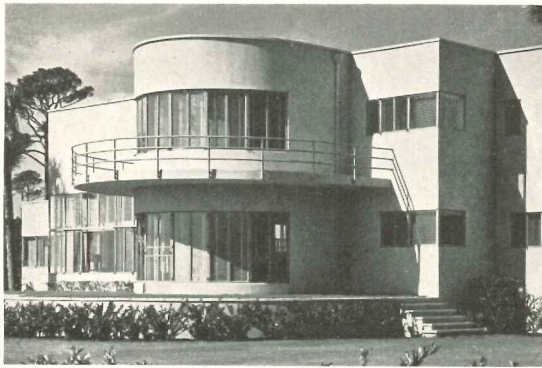

Gottschko



Gottschko

Seven houses, illustrations of which suggest the widely varying influence of climate, site, construction, and personal interests of the owner on residential design. . . . Results of the "modern" and "traditional" approach to specific problems of design are comparatively reported by details of the house at Sea Island, Georgia, designed by Francis Louis Abreu (see opposite page) . . . and those of a house at Oyster Bay, New York, for which Kimball & Husted were architects (see page 113). . . .

The remaining houses include: A residence at Great Neck, New York, (page 119) which makes full use of modern equipment and materials to produce a livable, comfortable home. Hans N. Wormann was the architect. . . . A residence at Los Angeles (page 123), constructed of adobe and concrete, Gardner A. Dailey, architect. . . . A residence near Asheville, N. C., (page 126) situated to take advantage of excellent views, Henry Irven Gaines, architect. . . . An estate near Mentor, Ohio, (page 128), Charles Bacon Rowley, architect. . . . A house in New Canaan, Connecticut (page 130), Robertson Ward, architect. . . .

TIME-SAVER STANDARDS DATA

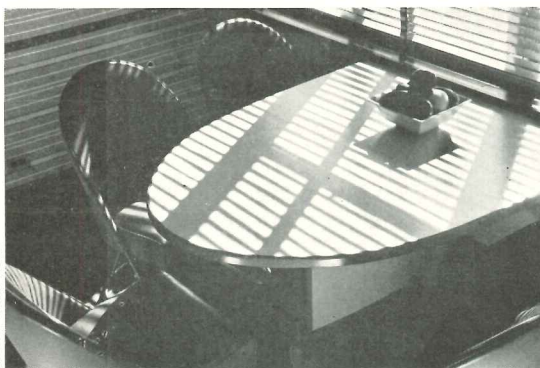

R. B. Churchill

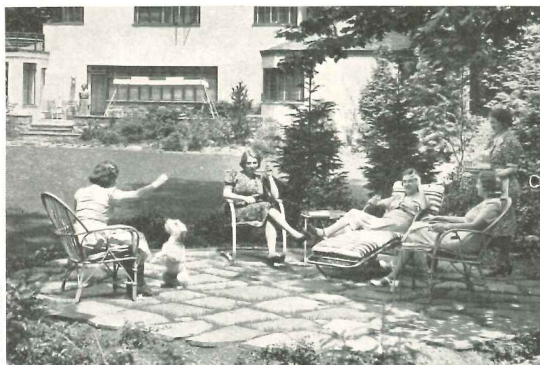

John Cass

"Details for Indoor Living Areas"—drawings, photographs, and descriptive notes—show how designers in different sections of the country have developed units of built-in furniture which are centers of activity within various living areas. Living-room (page 133) in a residence at Great Neck, New York, Hans N. Wormann, architect and interior designer. . . . Breakfast room (page 134) in a residence at Kansas City, Mo., Kem Weber, interior designer. . . . Child's room (page 135) in a residence at Washington, D. C., Eugene Schoen and Sons, architects and interior designers. . . . Two bedrooms (page 136), the first in a residence at Elmsford, N. Y., Joseph Aronson, designer; the second in a residence at Washington, D. C., also by Eugene Schoen and Sons. . . .

"Outdoor Living Areas"—continuing the series on Time-Saver Standards on construction of outdoor units, data for which were furnished by Albert Taylor, Landscape Architect and President of the American Society of Landscape Architects: Walkway Construction (page 137) . . . Pool Construction (page 138) . . . Pool Piping (page 139) . . . Steps and Ramp Construction (page 140). . . .



SEA ISLAND, GEORGIA: Residence for Miss Judy King

FRANCIS LOUIS ABREU
Architect

ACCORDING TO the architect, "The problem in this case was that of adapting a house to a flat lot, facing the Atlantic Ocean, and in doing so to take full advantage of the best views and to locate the rooms in such a manner as to make use of the prevailing eastern and southern breezes—the house to have ample accommodations for the entertainment of guests, who would indulge in many types of sports with the change of seasons.

"The house was to harmonize well with the gray beach sands, to keep the feeling of the horizontal lines of shore and horizon, and to express the idea of the 'outdoors' in each of the rooms.

"The house is painted in two tones of gray, the darker gray on windows and doors—all about a shade or two darker than wet sand."

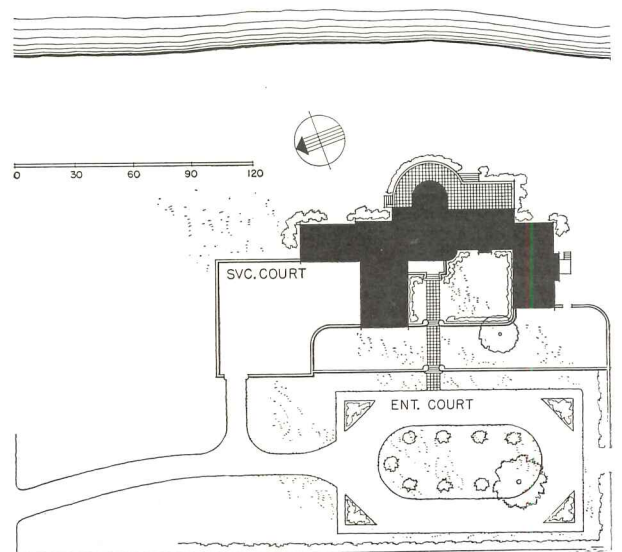

SEA ISLAND, GEORGIA

Residence for Miss Judy King



Detail of front entrance; the grass-patterned walk is typical of all living-terrace surfaces. The landscape architect was T. M. Baumgardner.

MATERIALS AND EQUIPMENT

FOUNDATION

Reinforced concrete walls, 12" thick; reinforced concrete spread footings

STRUCTURE

Reinforced concrete and structural clay tile

EXTERIOR

Walls: Load-bearing clay tile, 12" thick; reinforced concrete lintels, bands, etc.; stucco, Portland cement

Sash: Steel casements, Hope's Windows, Inc.; bronze screens; glazing, Pittsburgh Plate Glass Co.

Roof: Built-up, twenty-year bonded composition and gravel; promenade tile; sheet metal, copper

Insulation: Mineral wool batts, 3" thick, over all ceilings

Painting: Walls sand color; trim darker

INTERIOR

Floors: Structural-steel bar joists; concrete floors; rubber tile finish, Goodyear Tire and Rubber Co., Inc.

Partitions: Clay partition tile, 4", plastered; exterior walls furred, "Simp-L-On" system, Simplon Products Corp., metal lathed and plastered; bathroom, glass tile, "Vitrolite", Libbey-Owens-Ford Glass Co.

Sills and trim: Window sills of slate and local "Coquina" stone; trim, stock metal, "Coquina" stone; metal door bucks, Kalman Steel Corp.

Cost: approx. 55¢ per cu. ft.

EQUIPMENT

Heating: Hot-water system; oil-burning boiler; concealed radiators, "Modine", Modine Manufacturing Co.

Plumbing: Piping, copper tubing, "Streamline" fixtures, "Neuvogue", Crane Co.

Electrical: Wiring, conduit, General Electric lighting fixtures, mostly concealed strip lighting, "Lumiline", Curtis Lighting, Inc.; annunciator stations in all rooms

Kitchen: Cabinets, steel; sinks and counter to Monel metal; refrigerators, Frigidaire Div., General Motors Sales Corp., and Frederick; electric range, General Electric



bove, the ocean front of the house. The semi-circular bay commands wide views up and down the shore line; living and dining rooms are grouped in the southeast end to take advantage of prevailing winds. In the first floor plan on the right, notice particularly the location of the bar; and the outside entrances, which lead bathers, into the guest-room baths.

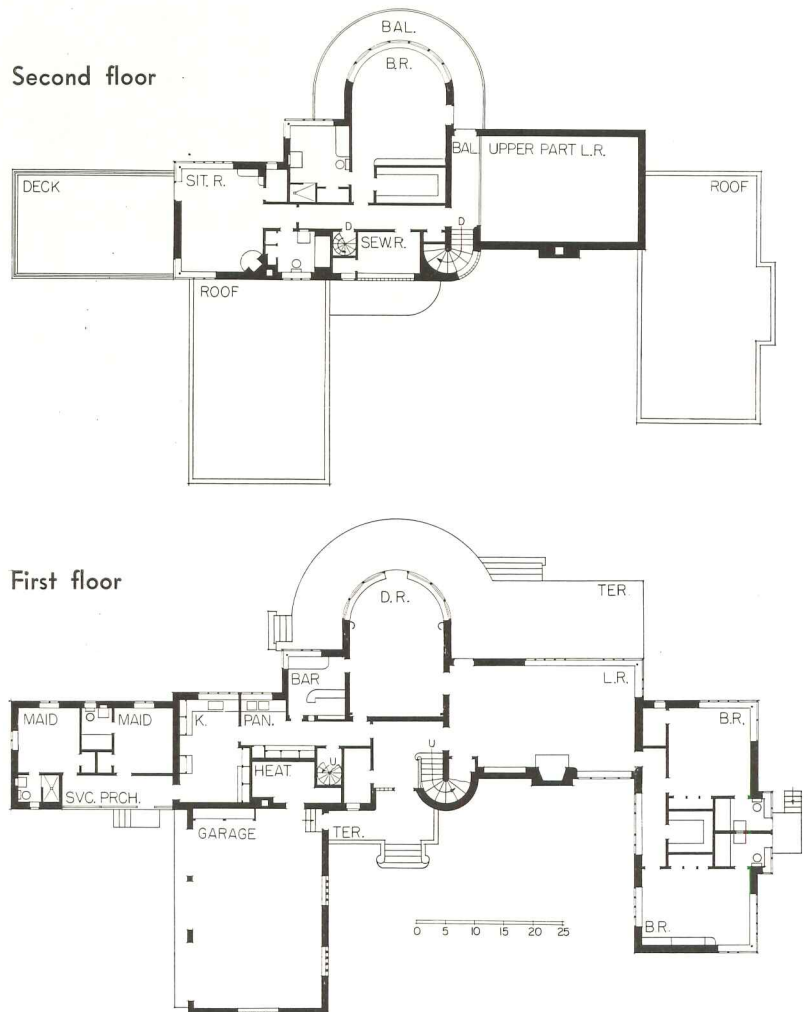

SEA ISLAND, GEORGIA
Residence for Miss Judy King

The living-room faces the beach; the terrace and windows overlooking ocean can be seen reflected in overmantel, which is a tan mirror. Plaster walls are painted warm beige; the floor is deep brown; the rug and upholstery are rough textured. All interiors are by Virginia Conner, Inc. who also designed the furniture. Architectural details of the living room are shown below.



Photos by Gottschalk

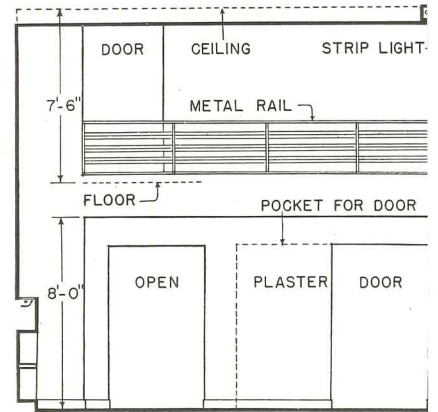

END OF LIVING RM. SCALE $\frac{1}{8}'' = 1'-0''$

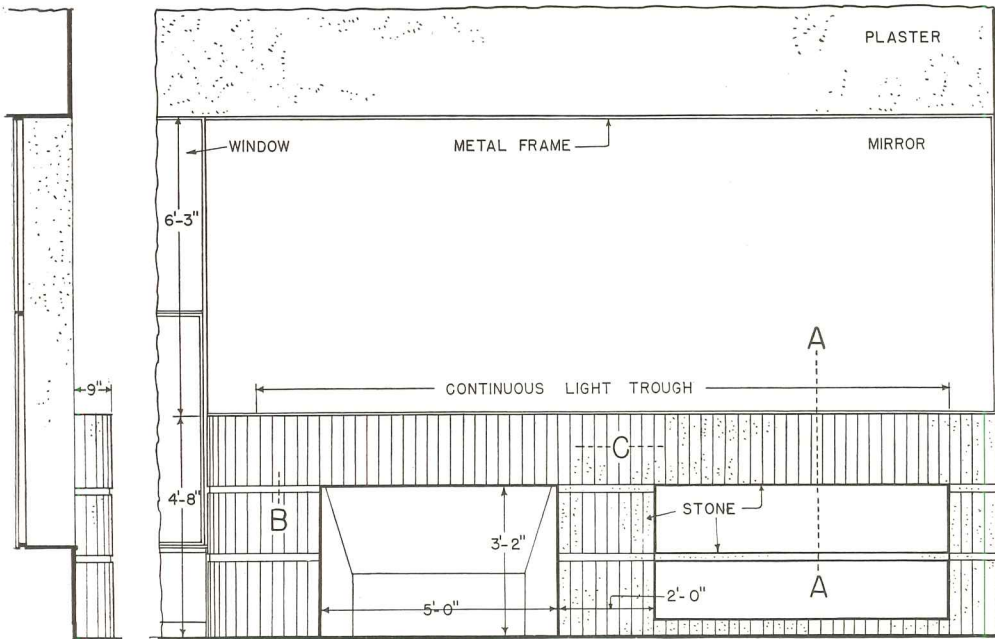

SECTION FIREPLACE ELEVATION SCALE $\frac{1}{4}'' = 1'-0''$

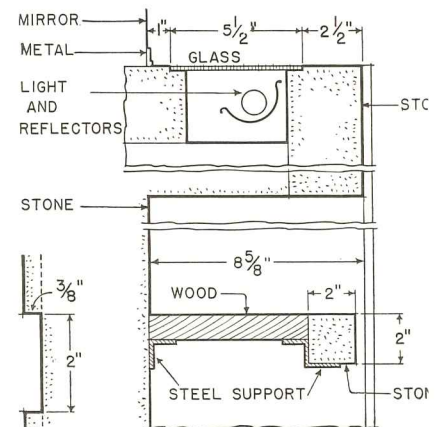

SECTION A A
 SCALE $\frac{1}{2}'' = 1'-0''$

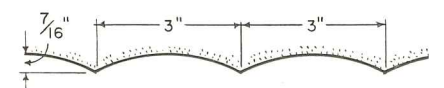

SECTION C SCALE $1\frac{1}{2}'' = 1'-0''$

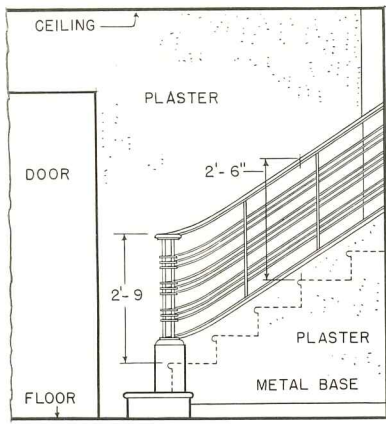

ELEVATION SCALE 1/4" = 1'-0"

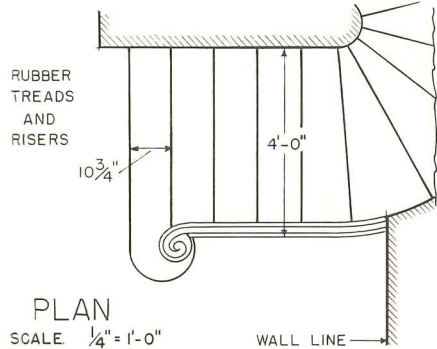

PLAN SCALE 1/4" = 1'-0"

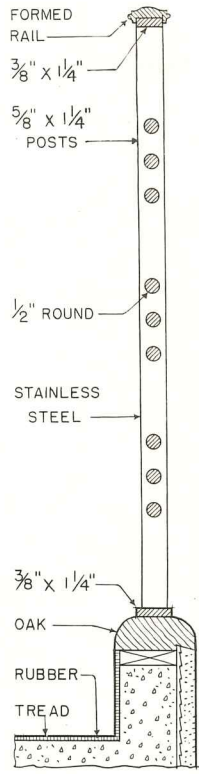

RAIL DETAIL SCALE 1/2" = 1'-0"



Drawings and photograph above show stair details. Two photographs and drawings below show bar details; in addition to the combination air-conditioning and lighting outlets over the bar, coved strip lights, similar to those in other rooms, furnish general illumination.

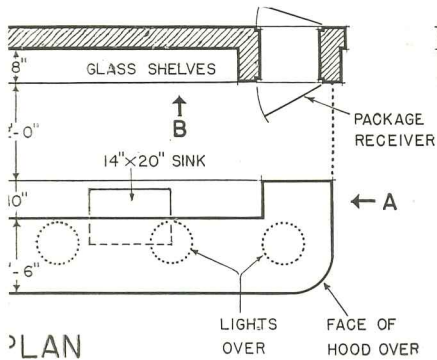
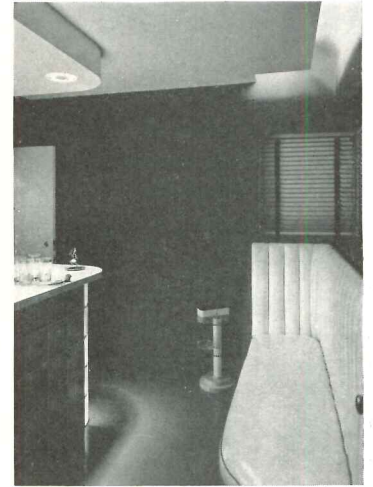

PLAN

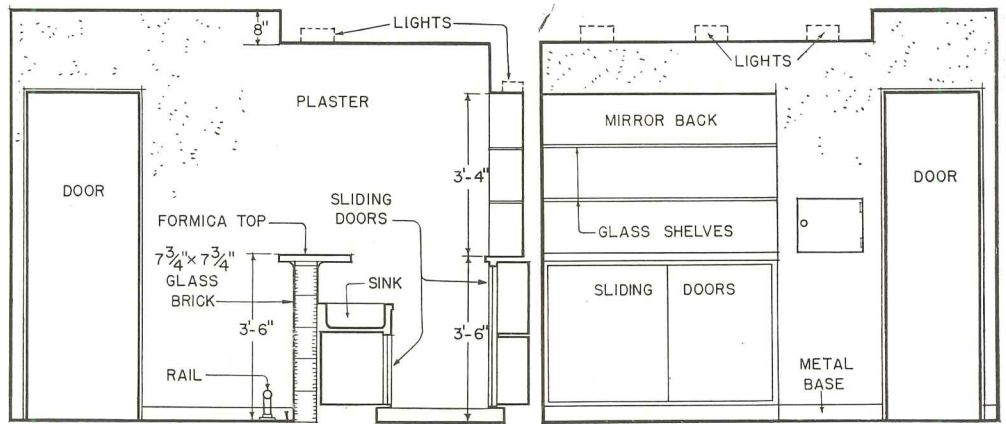

SECTION A

SECTION B

SEA ISLAND, GEORGIA

Residence for Miss Judy King

Second-floor suite: at left, the sitting room, reflected in the overmantel mirror; below, the bedroom. In the latter, the floor is deep blue rubber, the walls painted "bois de rose", tables crystal, and the bed and curved chaise longue are ice-blue damask.

Photos by Gottscho



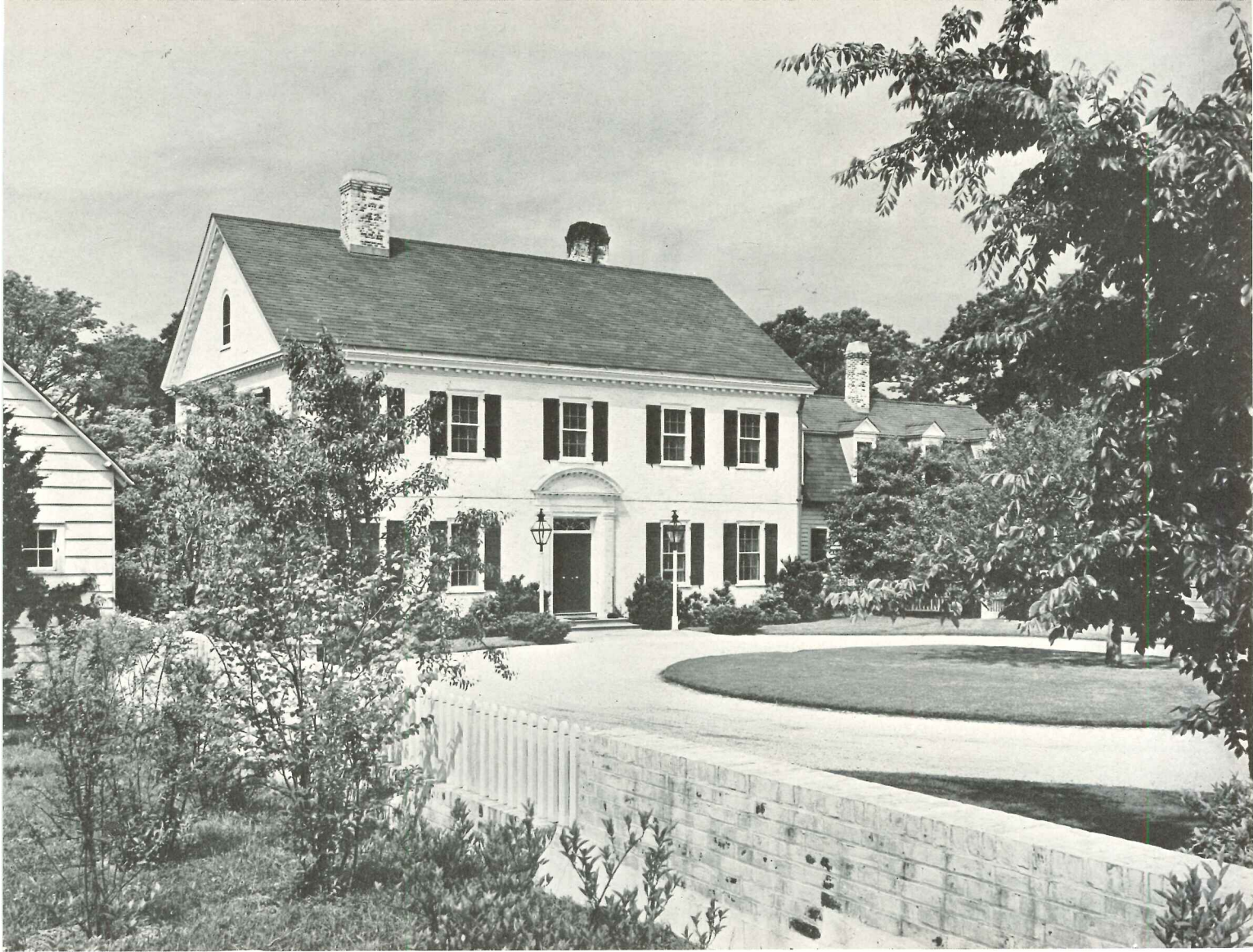

YSTER BAY, NEW YORK: Residence for A. M. White, Jr.

KIMBALL & HUSTED
Architects

CHARD A. KIMBALL, of the firm of Kimball & Husted, states:

"The problem in locating the house was to give a maximum amount of sun to the living portion, and to make use of desirable views from the living room, library, and owner's bedroom.

"Grade conditions enabled us to drop the garage floor and service court out of sight, half a story below the entrance court, and to give the living room more height than the other first-story rooms.

"A small building in which Walt Whitman had at one time taught school was moved to the site by the owner and incorporated in the group, the garage balancing it to form the entrance court.

"Roof and court drainage was very simply disposed of at grade on the wooded slope southwest of the house. The well was so located on this slope that it was possible to conceal the pump house completely in the bank."





First floor

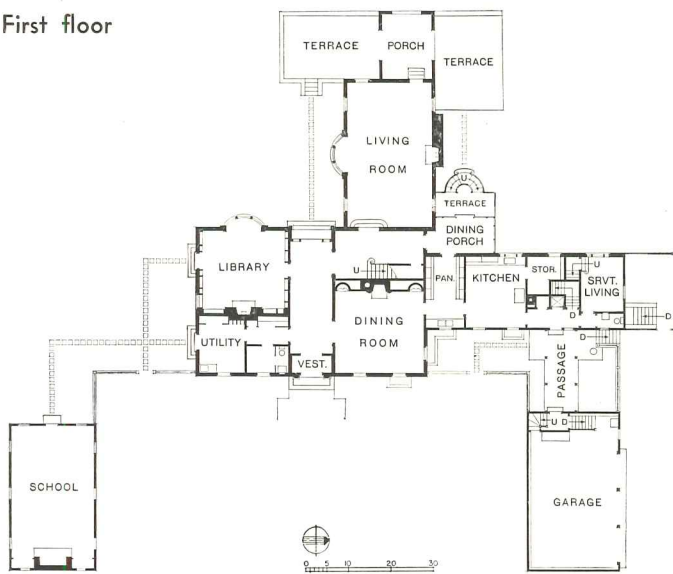

Second floor



Third floor

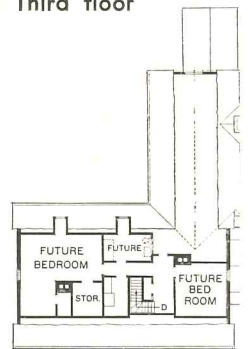



bove, left, library bay window and garden entrance; right, vice portion, showing the covered connection between house l garage, and the service court dropped lower than the ainder of the grounds.

t. KIMBALL further says: "A three-car age, connected to the house, was required. was suggested that space over the garage used for future servants' rooms. It was also desirable to have the possibility in the are of one or two more master bedrooms l bath; these serve at present as a 'rainy ' children's play-room, and master's study. The property was high, partially wooded d, without water or any outside services. general, the T-shaped plan permitted cross-tilation in all important first-story rooms l in the owner's bedroom. A porch off the living-room offers proed outdoor sitting. Its flagstone floor exds out into a sunken terrace for sunny door sitting. The second story of the porch ntended for sleeping and is equipped with ens and rolling shutters."

MATERIALS AND EQUIPMENT

FOUNDATION

Concrete

STRUCTURE

Wood frame, brick veneered

EXTERIOR

Walls: Brick veneer; brick, Post Brick Co.; front entrance, brick specially moulded to detail

Sash: Wood, double hung; bronze screens; special steel sash, dining porch, Lundell-Eckberg Mfg. Co., with bronze operators, H. S. Getty & Co., Inc.

Roof: Wood frame and sheathing; slate surface, "Bangor Medium", Bangor Slate Co.

INTERIOR

Floors: Oak plank in living portion, first floor; linoleum in service portions, first-floor lavatory and second-floor guest

bath, Armstrong's and Sealex; canvas in sleeping porch

Walls: Stud frame, plastered and painted generally

Ceilings: Plaster, painted

Trim: Specially milled, wood; library, knotty pine

Painting: Lead and oil; doors mahogany, walls off-white, trim white

EQUIPMENT

Heating: Boiler, "Capital", United States Radiator Corp.; radiation, "Capital Fin-cast", United States Radiator Corp.; oil burner, Petro-Nokol; humidifier, "Zephyr"; motorized valves and thermostat, Minneapolis-Honeywell Regulator Co.

Plumbing: Fixtures: Crane Co.; pantry sink, Tracy Mfg. Co.; bathroom accessories, Charles Parker Co.

Kitchen: Cabinets, Janes & Kirtland, Inc.; range, American Gas Association

Radio: Remote control, Capehart, Inc.

Cost (construction only, excluding fees): 45¢ per cu. ft.



Photos by Gottscho

OYSTER BAY, NEW YORK
Residence for A. M. White, Jr.

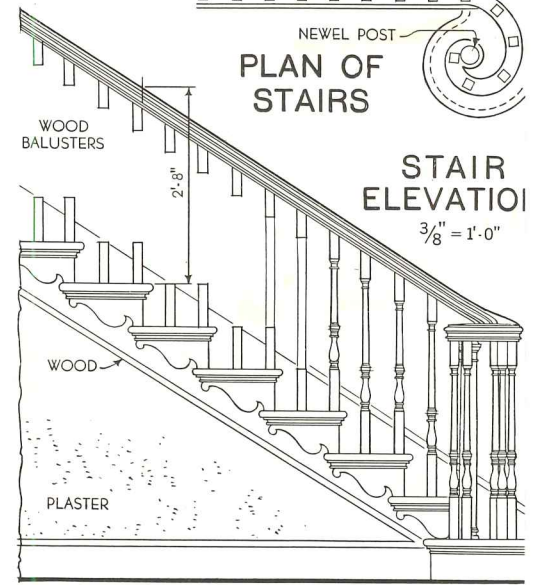
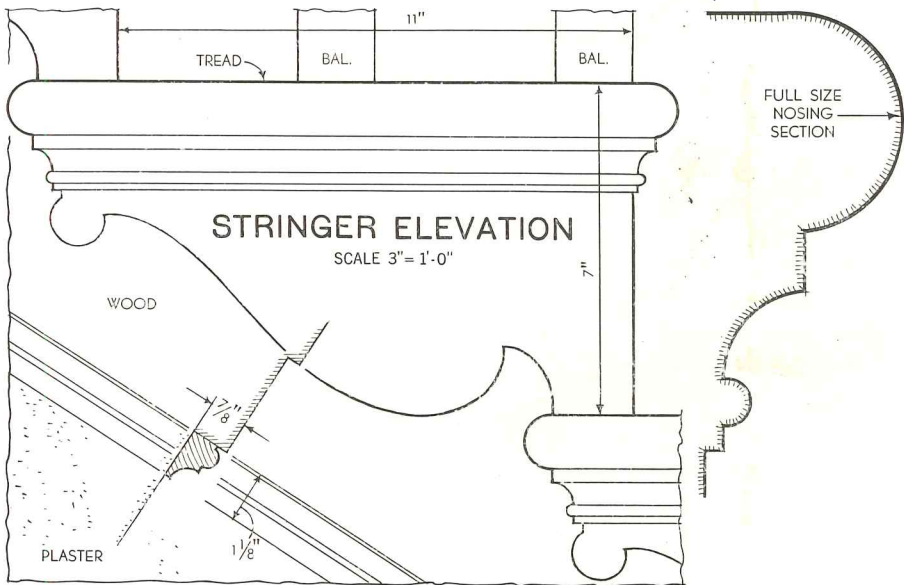
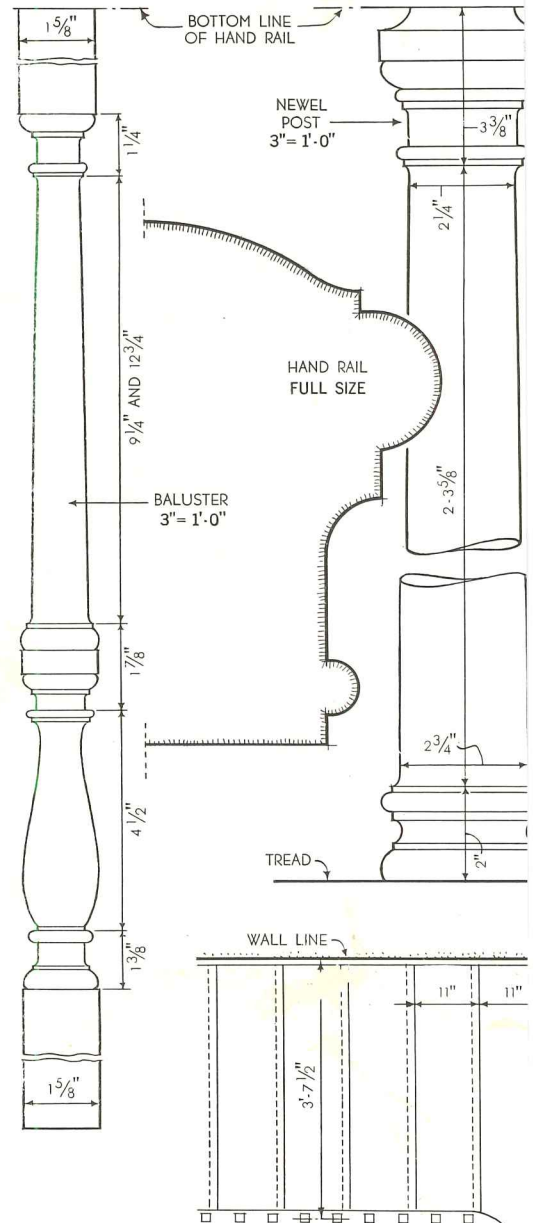

...t, main hall; right (below), living room;
 ...ings, living-room bay. On facing page,
 ... hall looking through to library, and
 ... details.

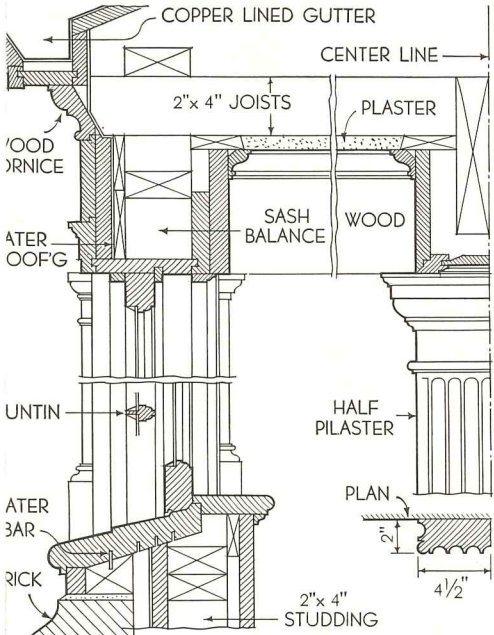

SECTION THRU BAY
 SCALE 1" = 1'-0"

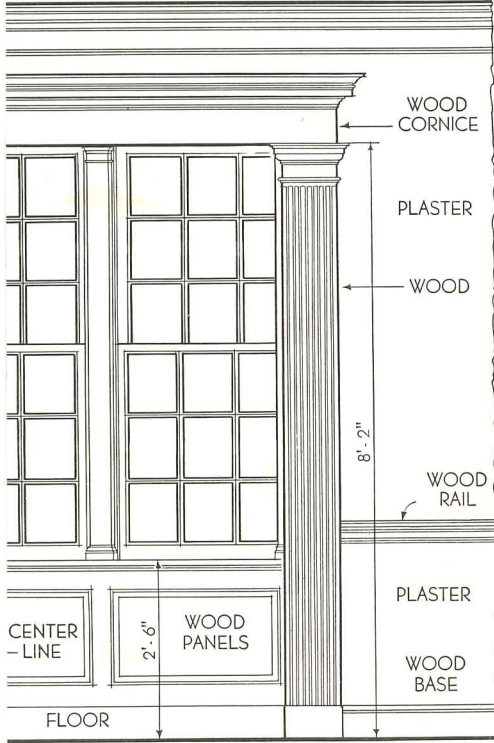
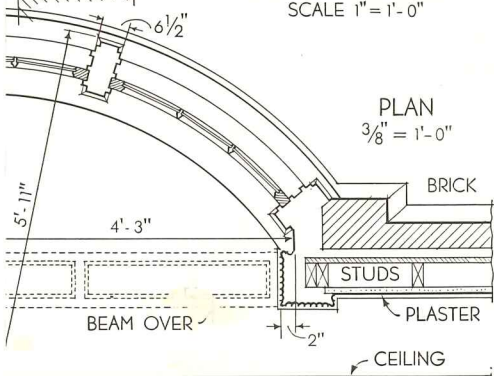

ELEVATION OF BAY
 SCALE 3/8" = 1'-0"

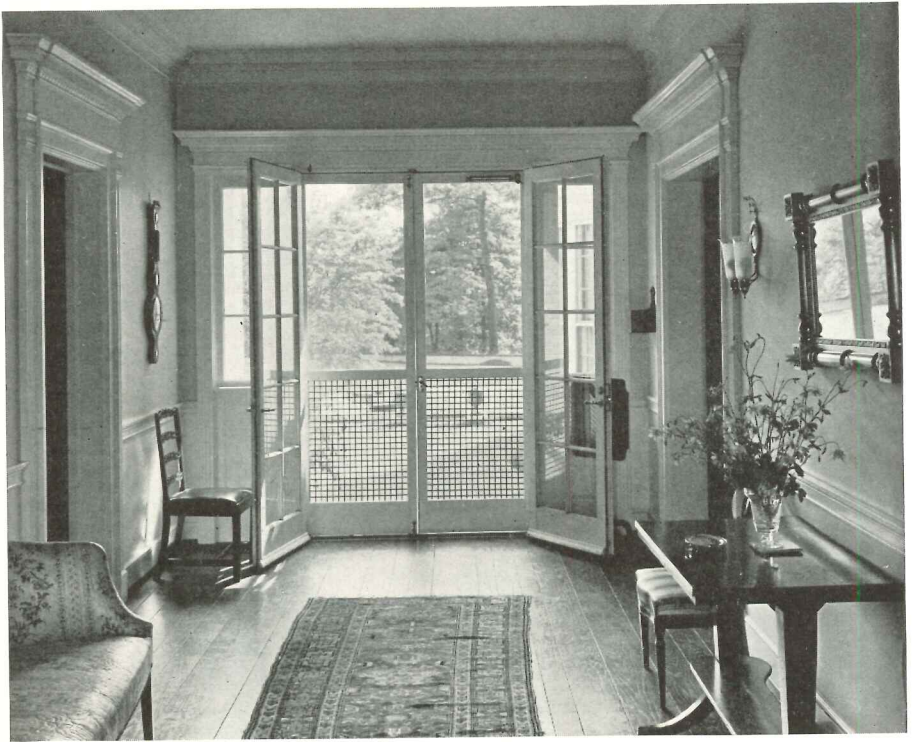

Photos by Gottscho



The dining room mantel, shown at the top, is an original from Williamsburg and has been incorporated in the wall treatment. Paneling and niches are new. The library mantel, shown below, is of pine; mantel, paneling, and bookshelves, designed for the house, are detailed at the right.

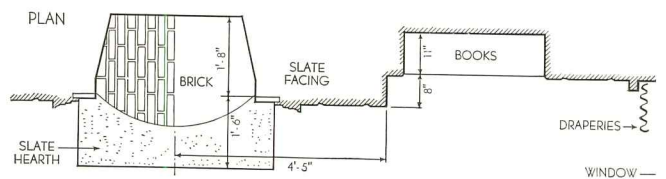
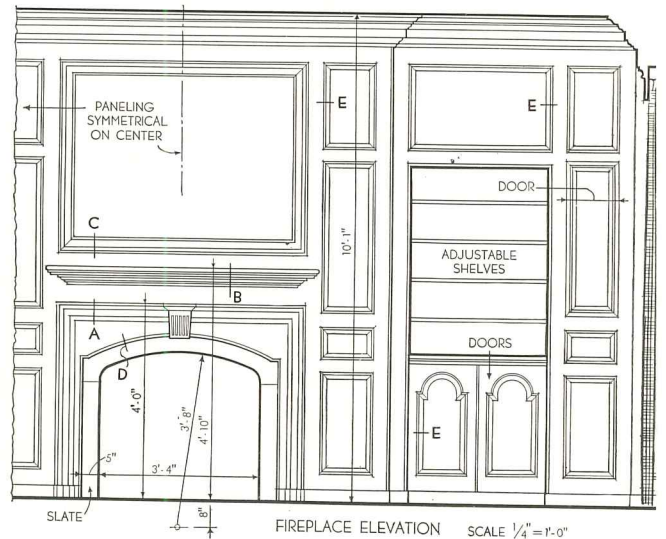
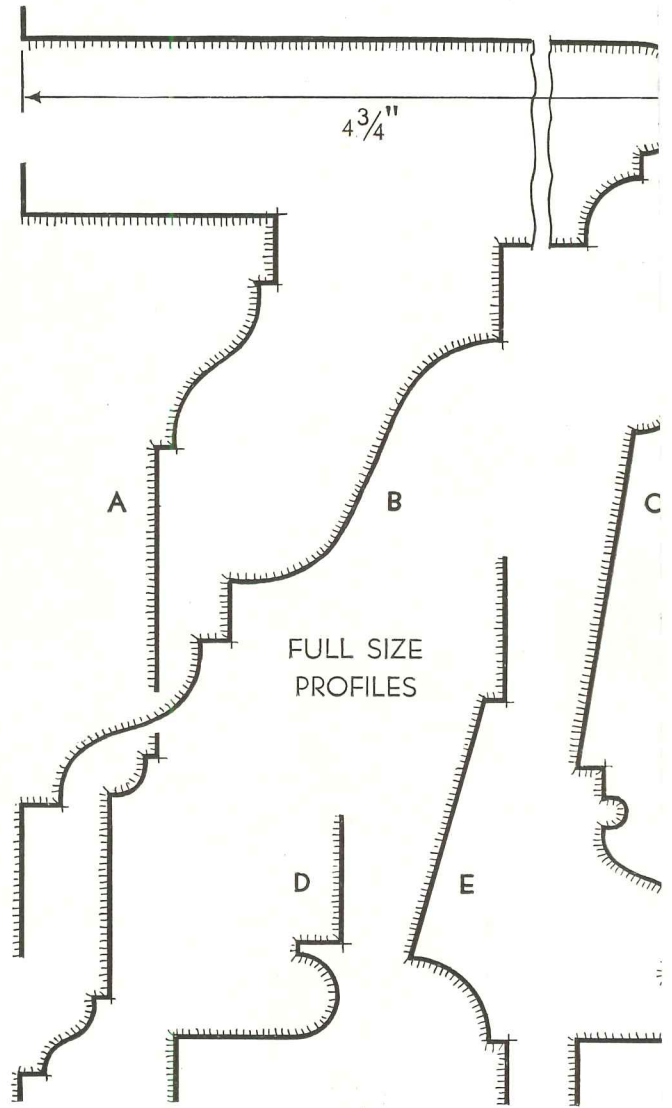



Residence in GREAT NECK, NEW YORK

HANS N. WORMANN
Architect

WHILE THE COST of this house was fairly high, considering its size, it includes many refinements not ordinarily encountered. These range from individual dressing rooms and baths for the owner and his wife, to curtain and venetian blind pockets at all windows.

Many pieces of furniture were designed as integral parts of the structure; all were the architect's responsibility. Heating system is divided into five independently controlled zones, roughly: service, living, master's sleeping, second floor, and baths.

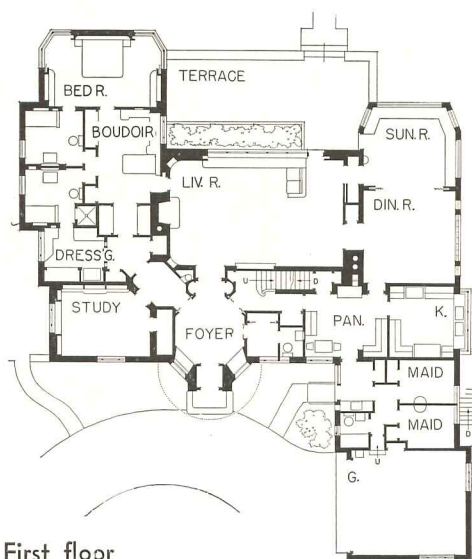

First floor

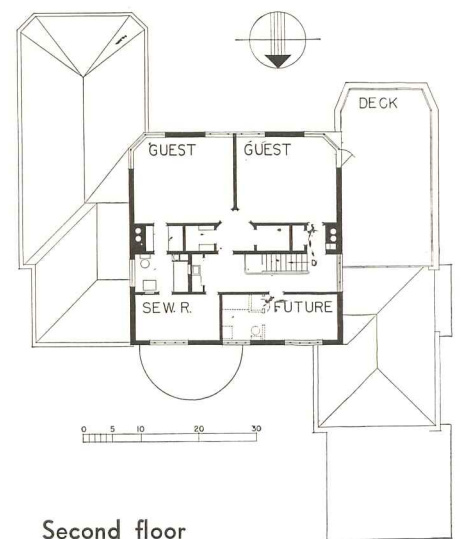

Second floor



Plot plan

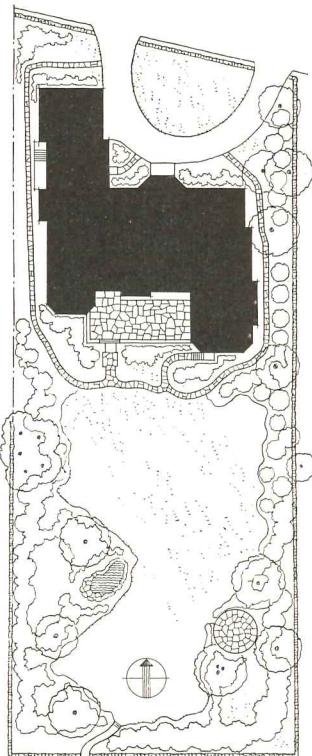

Residence in GREAT NECK, NEW YORK

MATERIALS AND EQUIPMENT

FOUNDATION

Mass concrete with 1" waterproof cement parging; continuous 4-ply waterproofing membrane in basement floor

STRUCTURE

Reinforced concrete, cinder block and fieldstone ashlar

EXTERIOR

Walls: Cinder block, 8" and 12" thick; 3-coat stucco, Artstone Rocor Corp.; some fieldstone ashlar

Sash and doors: Screened "Intermediate" steel casements, J. H. Thorn Co.; special steel window in sun room, Allen Automatic Co.; garage doors, lift type; glass block, dining room, Pittsburgh Corning Corp.; weatherstripping, interlocking zinc members

Roof: Shingle tile, Ludowici-Celadon Co.; sheet metal, 16 oz. copper

Insulation: Aluminum foil, all exterior walls and sundeck, Alfol Insulation Co.; roofs, 4" rock wool

INTERIOR

Floors: Basement, double concrete slabs, waterproofing between, and first floor, "Floform" concrete; precast concrete joists and slabs, Bedford Hills Concrete Prod. Corp.; finish, cement generally; oak block, study, dining room, guest room, E. L. Bruce Co.; Roman travertine, sun room; N. C. pine, asphalt, part of basement; tile, baths

Partitions: Part cinder block, part studding plastered, painted 3 coats, some stippled wallpaper, living, guest, bedrooms, and part of hall; baths, tile

Doors: Flush, 3/4" thick

Stairs: Precast concrete; covered with oak treads and risers, first to second floors

Sound insulation: Between dining room and kitchen, balsam wool

EQUIPMENT

Heating: "Split" system, 2 zones air conditioned, 3 zones, 2-pipe vapor radiation Carrier Corp.; 5 zone thermostats; oil-fired boiler; Petrometer gauge

Plumbing: Water lines, brass; copper hot water tank; fixtures, Crane Co.

Electrical: Motor operators for sunroom window and garage doors; kitchen range exhaust fan; annunciator call bells, all rooms 2 outside alarm bells; radio outlets, all rooms aerial built in second floor ceiling; 32 lighting circuits, 375 outlets; lighting fixtures built-in, Kurt Versen, Inc.

Kitchen and laundry: Gas stove, Magic Chef refrigerator, Norge; cabinets, Excel Meta Cabinet Co.; counters, linoleum; clothes chute, aluminum, Haslett Chute & Conveyor Co.; incinerator, Kerner Incinerator Co.

Cellar: Honeycomb wine bottle racks, Herman Soellner, Inc.

Hardware: Dull chrome, Schlage Lock Co.

Cost, building proper, approx. 50¢ per cu. ft.

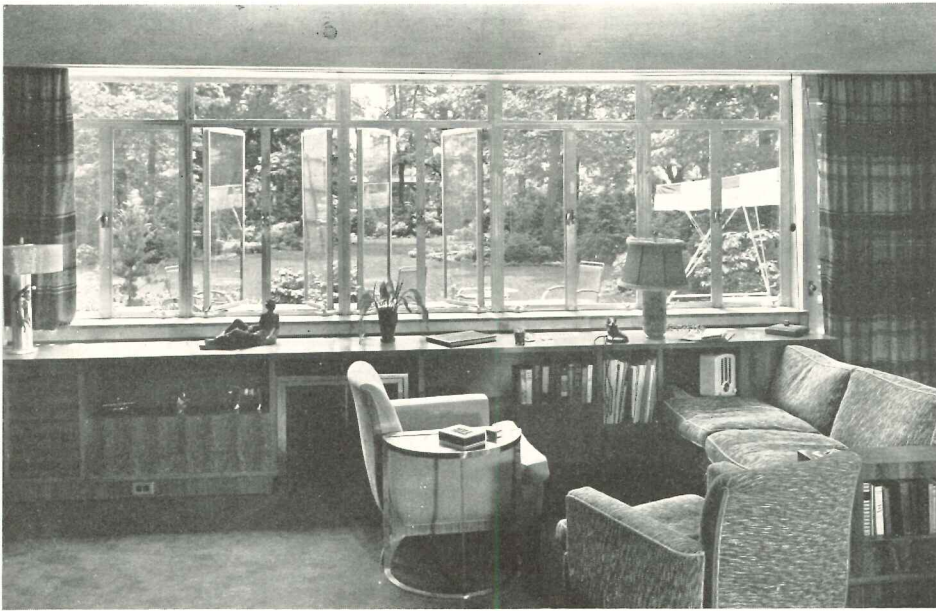

Two views of the living room; walls are of white and silver grass cloth, chenille carpeting is deep blue, draperies of handwoven fabric striped blue, beige, and red. Details of the window cabinet are shown elsewhere in this issue; details of the built-in bar are shown below. Both built-in and portable furniture are of straight-grained and crocheted walnut, with handwoven upholstery.

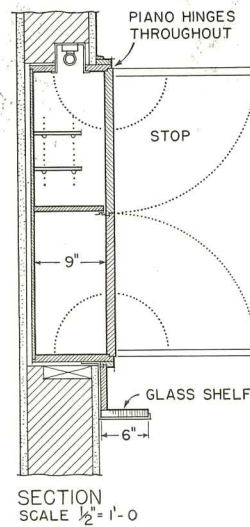
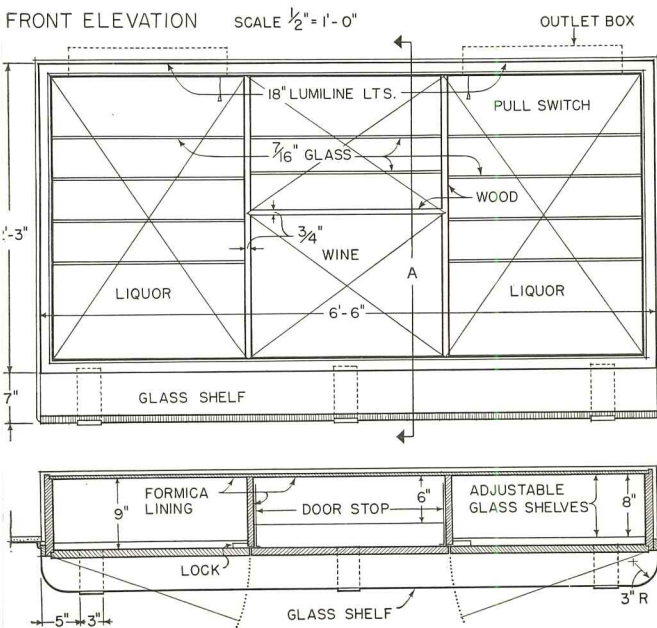

PLAN OF CABINET
 $\frac{1}{2}'' = 1'-0''$

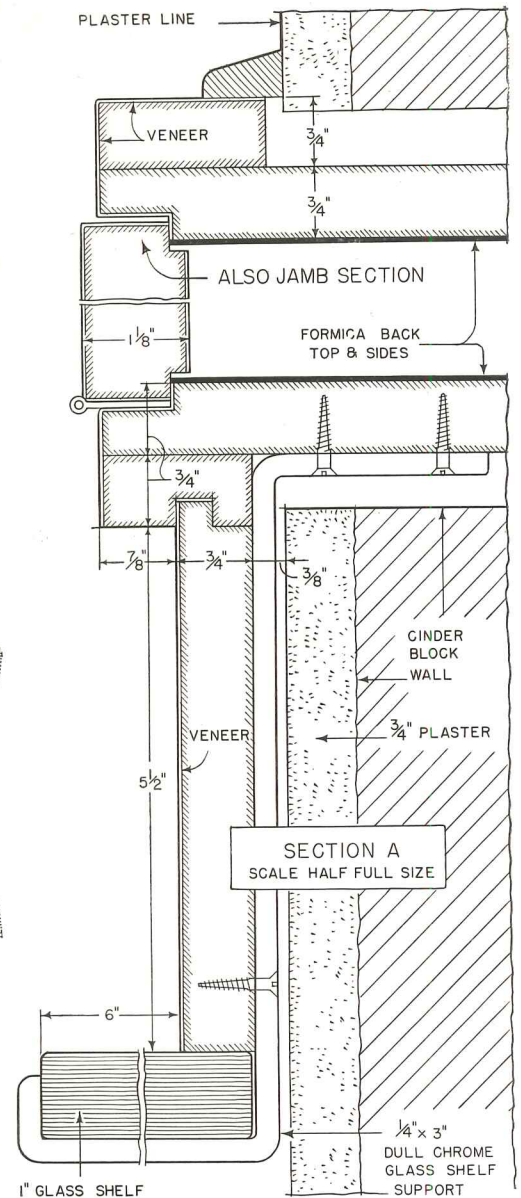



Above, view through dining room into sun room; the window at the far end of the sun room is a single sheet of plate glass which can be lowered by motor into the basement. Continuous light covers in both rooms are red lacquered, and contain 74 lineal feet of tubular lighting, 2,800 watts. Below, boudoir dressing table and desk, with details.

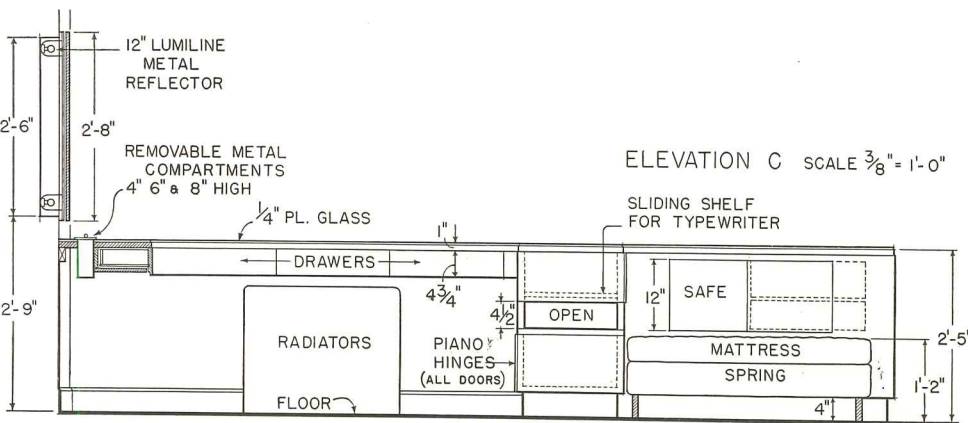

Residence in GREAT NECK, N. Y.

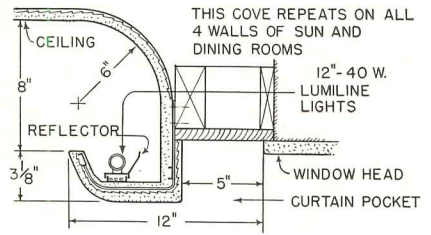

LIGHT COVE & CURTAIN POCKET 1" = 1'-0"

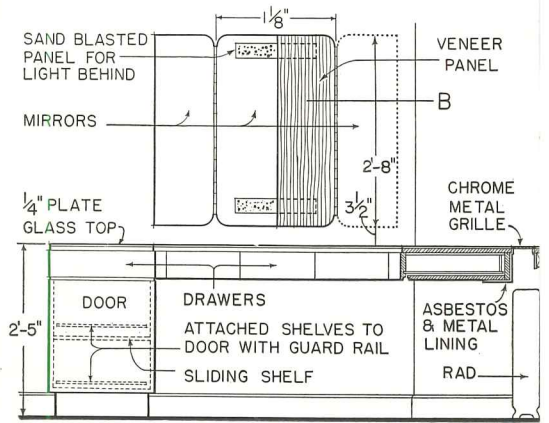

ELEVATION A SCALE 3/8" = 1'-0"

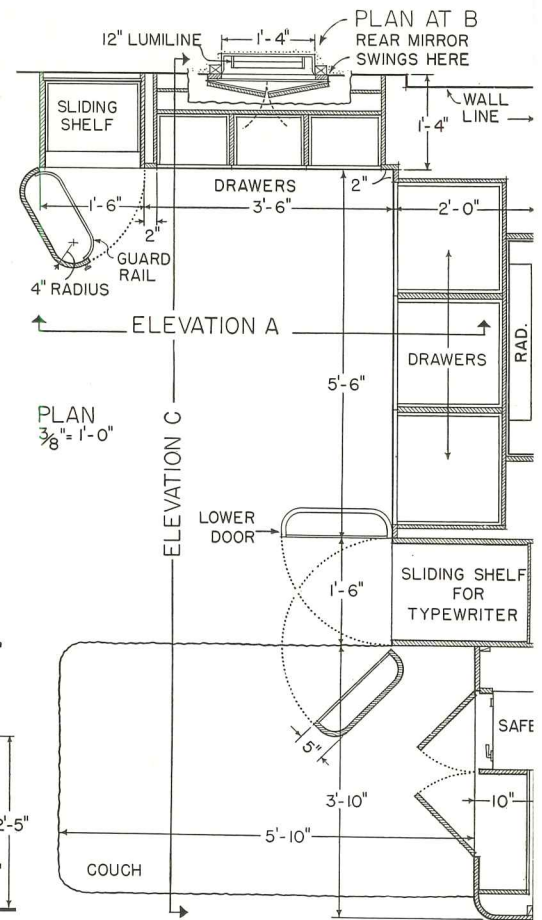

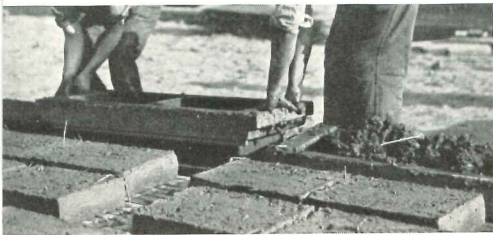
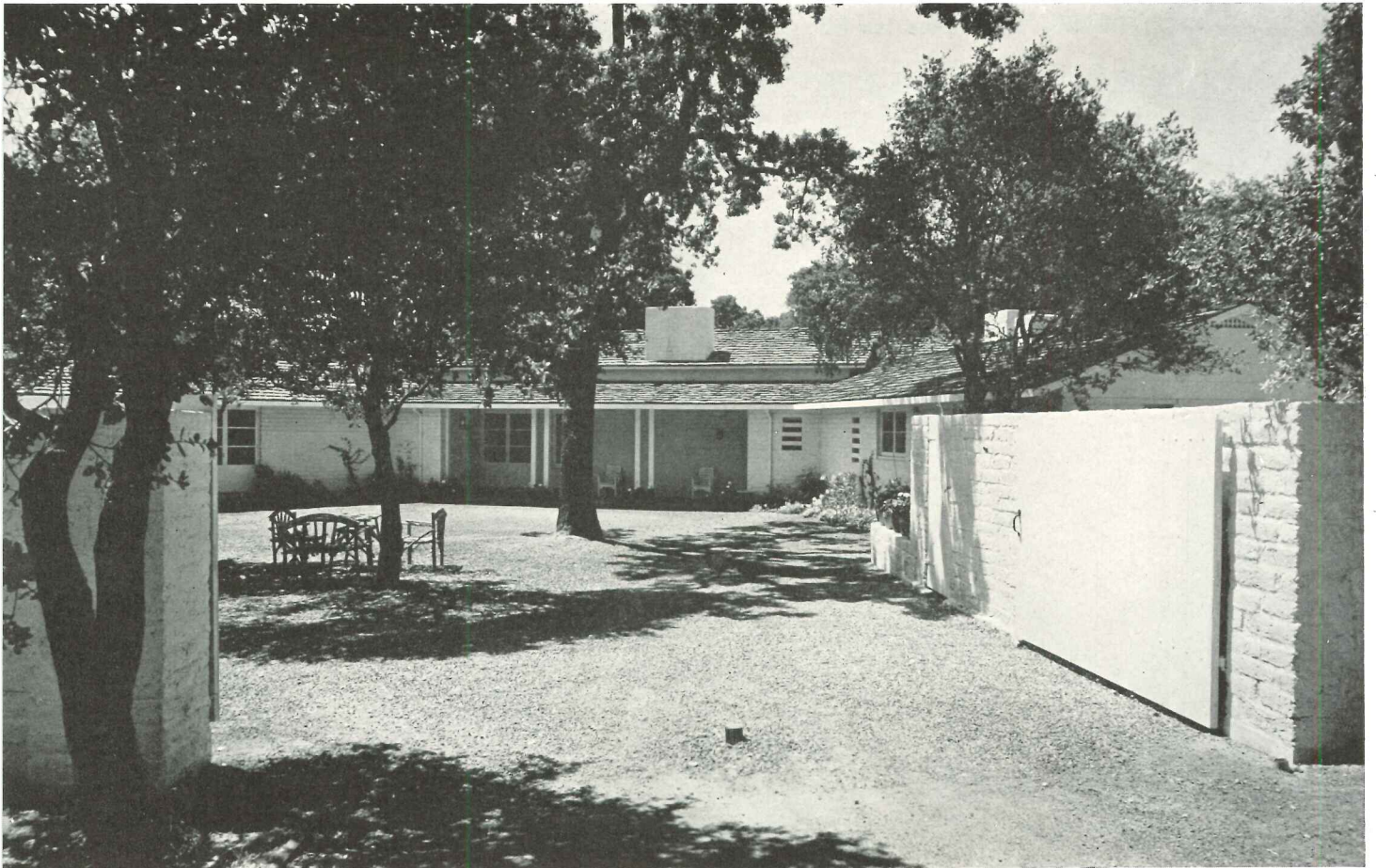

WOODSIDE, CAL.: Residence for Mr. & Mrs. Stewart Elliott
GARDNER A. DAILEY
 Architect

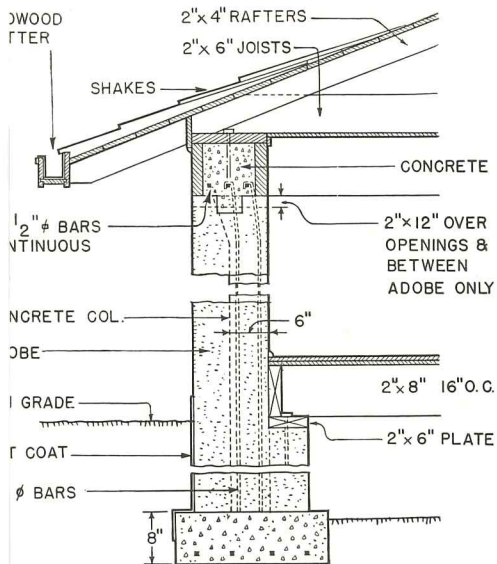

terior and some interior walls are Bitumals
 obe brick, 12" by 18", composed of sur-
 e soil, straw, water, and Bitumals oil. Mor-
 was also Bitumals adobe. Concrete columns
 re poured in recesses left in adobe; red-
 od forms for collar beams remain in walls.

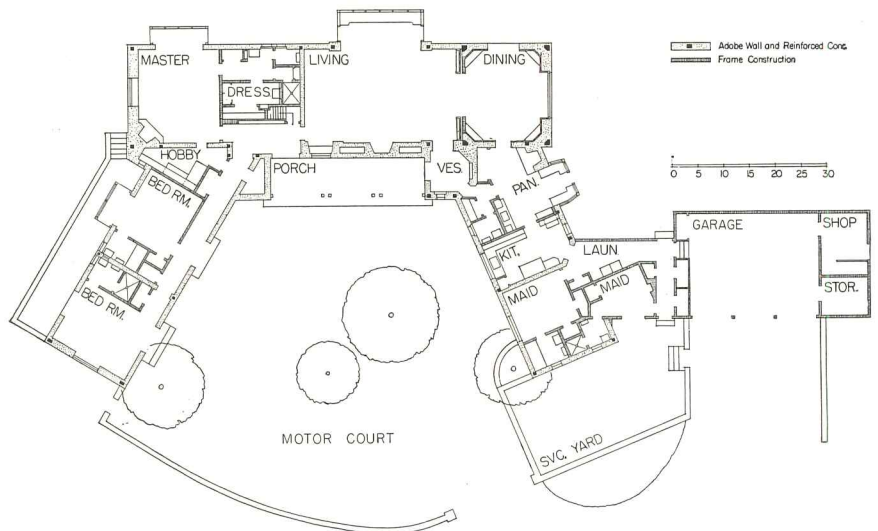

WOODSIDE, CALIFORNIA: Residence for Mr. & Mrs. Stewart Elliott



Above, rear terrace, showing in the foreground the bay from the master bedroom; beyond, the living-room bay. Below are two views of the pantry, which does triple duty. Besides the usual cupboards and sink, it contains a barbecue fireplace and breakfast table with benches.





Above, interior of living-room; below, dining-room. All same walls are finished with knotty red cedar board-and-batten. Wood studs and plates are secured to adobe walls with bent lengths of barbed wire embedded in mortar joints and nailed to framing.



MATERIALS AND EQUIPMENT

FOUNDATION

Continuous reinforced concrete

STRUCTURE

12" adobe walls generally; 24" adobe on gable walls; reinforced concrete columns and collar-beam or plate

EXTERIOR

Walls: Adobe, painted with special preparation, Triangle Paint Co.

Sash and doors: Sugar pine, out-swinging casements, painted; glass, select, A grade, Pittsburgh Plate Glass Co.; sills, quarry tile set in cement mortar

Roof: Douglas fir framing; red cedar shakes; sheet metal, 12 ga. galvanized iron

INTERIOR

Walls: Adobe exposed, painted with Texolite, U. S. Gypsum Co.; non-bearing walls, Douglas fir studs,

knotty red cedar finish and trim, lacquered, E. I. duPont de Nemours & Co., Inc.

Floors: Square-jointed oak plank except baths, lavatories and kitchen finished with Armstrong's linoleum, blue, laid over Insulite "semi-hard" hardboard; entrance porch, quarry tile; hearths, 12" by 12" hollow tile

Ceilings: Red cedar, lacquered

EQUIPMENT

Heating: Hot water; Watrola Heat Generator, gas fired; Young convectors set in Schick enclosures, damper-controlled; 1/2" copper circulating lines; Thrush circulating pump

Plumbing: Piping, Chase copper; fixtures, Crane Co.

Electric wiring: Steel conduit in adobe; otherwise knob and tube

Hardware: Sargent & Co.

Cost: approx. 33¢ per cu. ft.

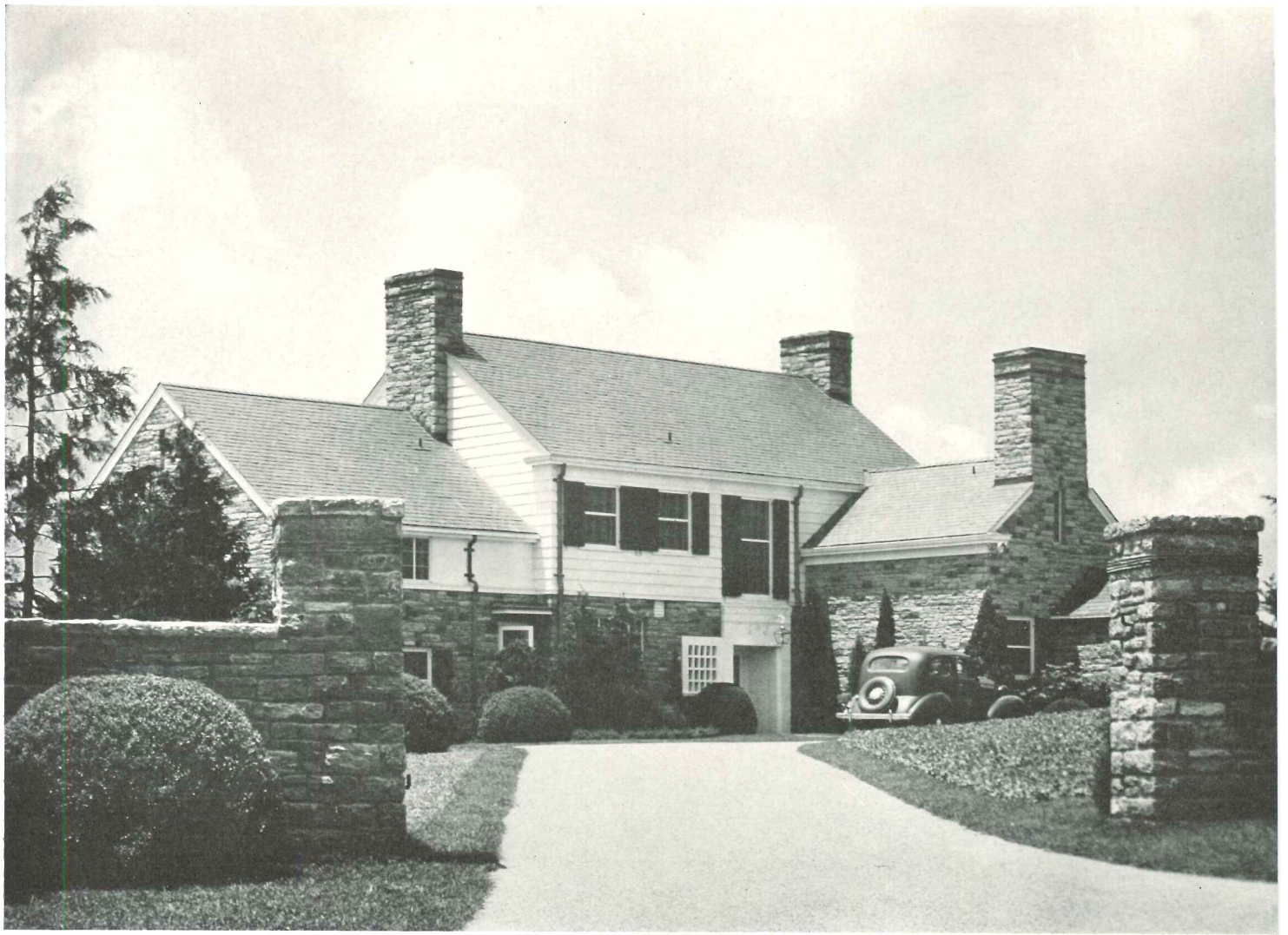

ASHEVILLE, N. C.: Residence for Mr. & Mrs. E. J. Sparks

HENRY IRVEN GAINI
Archite

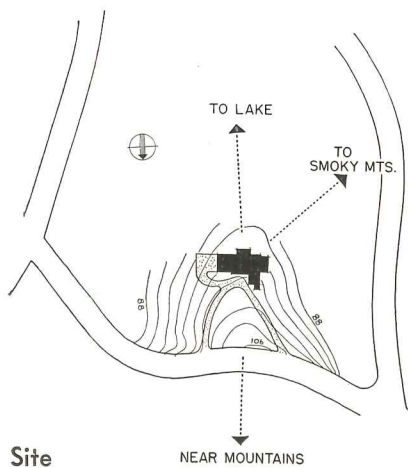

Site

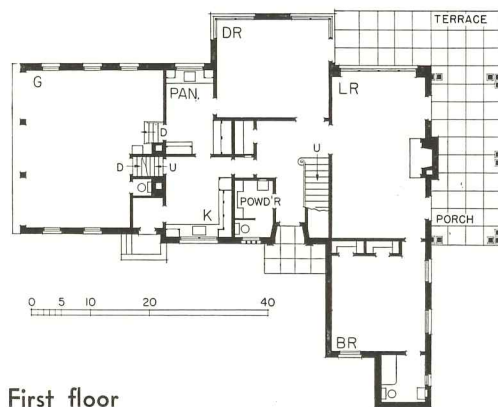

First floor

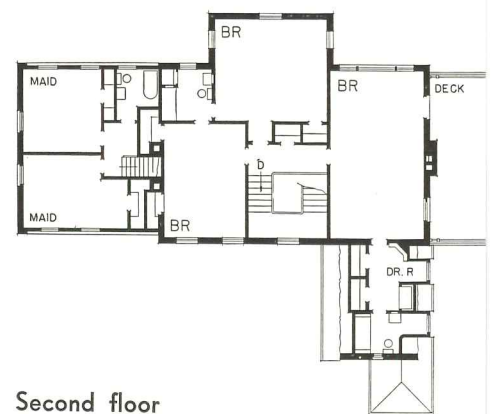

Second floor



...facing page, entrance front; above, south eleva-
 ...; right, south end of living-room; right, below,
 ...ven. In addition to the usual fixtures, a dishwasher
 ...garbage disposal unit are built into the sink.

MATERIALS AND EQUIPMENT

FOUNDATION
 ...red mass concrete footings; common brick

STRUCTURE
 ...wood frame; masonry veneer

EXTERIOR
 ...s: Local stone veneer and redwood sid-

...; Metal, Detroit Steel Products Com-
 ...; wood
 ...s: Metal, Detroit Steel Products Com-
 ...; wood; garage, "Ro-Way" lift type,
 ... Manufacturing Co.
 ...: Slate, "Buckingham", Virginia Slate
 ...; sheet metal, copper
 ...ation: Sidewalls and roof, Red Top Insu-
 ...ing Wool, U. S. Gypsum Co.
 ...ing: Benjamin Moore paint

INTERIOR
 ...s: Plaster, U. S. Gypsum Co.; wallpaper,
 ...mbus Coated Fabric Co.
 ...s: Oak, D. M. Rose Company; baths, tile,
 ...ic Tile Company; kitchens and pantry,
 ...um, Armstrong Cork Products Co.; ter-
 ...; local flagstone
 ... White pine

EQUIPMENT
 ...ware: Sargent & Co.
 ...en: Range, refrigerator, hot-water sup-
 ...dishwasher, garbage disposal, General
 ...ric Co.
 ...ing: Fixtures, Standard Sanitary Manu-
 ...ring Co.
 ...ing: Concealed radiation, C. A. Dunham
 ...stoker, Iron Fireman Mfg. Co.; boiler,
 ... Radiator Corp.
 ...ing: Fixtures, Lightolier Co.
 ...ian blinds: Pella, Rolscreen Company
 ... Cost: 40¢ per cu. ft.

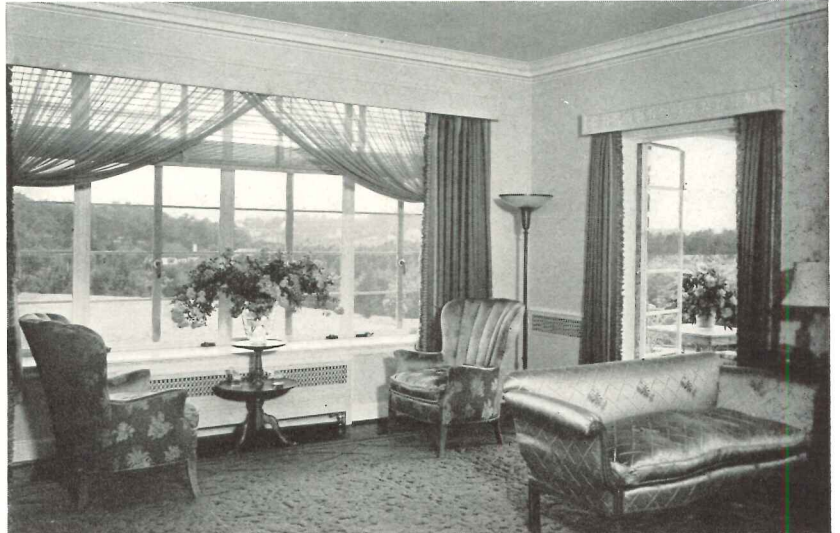

Photos by Ernest Graham

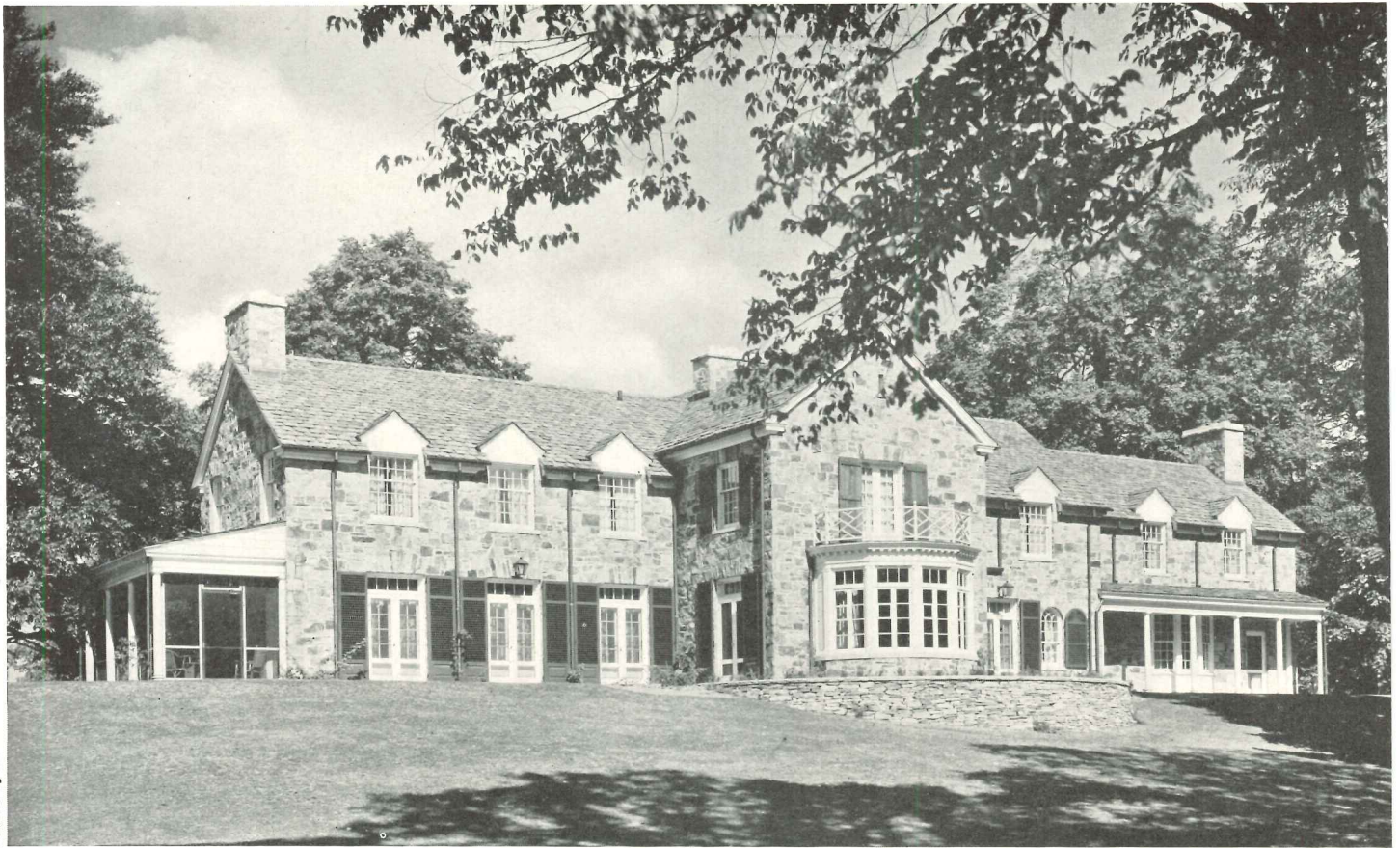

MENTOR, OHIO: Residence for Mr. & Mrs. Newell Bolton **CHARLES B. ROWLEY & ASSOCIATES**
Archit

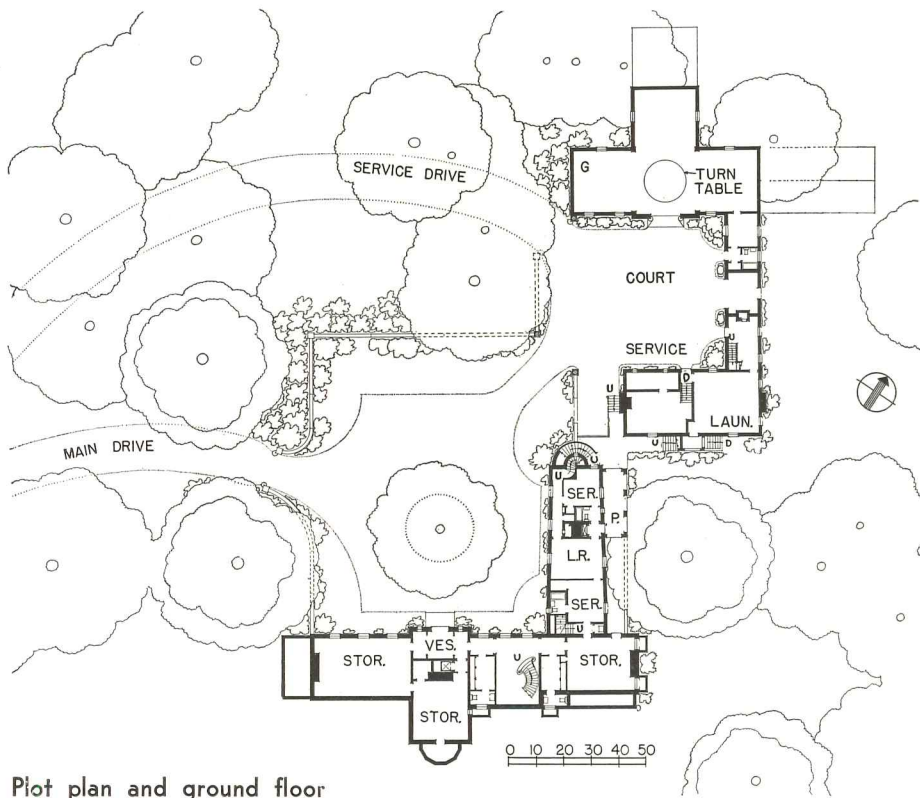

Plot plan and ground floor

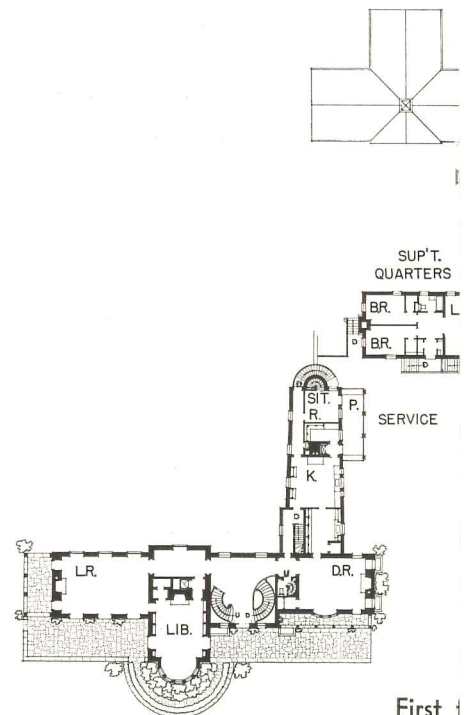

First floor



MATERIALS AND EQUIPMENT

STRUCTURE: masonry and reinforced concrete
EXTERIOR:
Walls: Hard local sandstone facing, "Haydite" backup, Hydraulic-Press Brick plastered inside on insulating fibre board, furred
Roof: Semi - mill construction, heavy ten rafters widely spaced, 2" sheath and graduated slate roof
Windows: Wood, double hung
Trim: Trim, white; shutters: first story, white; second story, brown
 Cost, including service buildings: approx. 60¢ per cu. ft.

INTERIOR:
Walls: Bearing walls, "Haydite" and brick; non-bearing, gypsum block; plastered on both sides; library, panelled cherry
Floors: Bar joists, 3" reinforced concrete slabs, wood sleepers, wood rough and finish floors; library, cherry plank
Ceilings: First story and basement, metal lath and plaster; second story, plaster on fibre board
Stairways: Cherry treads and handrails, white painted risers and balusters

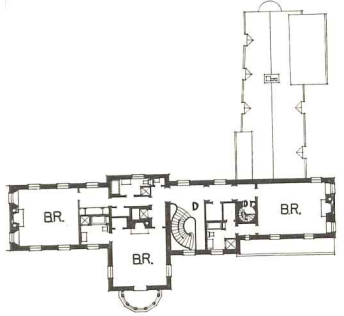
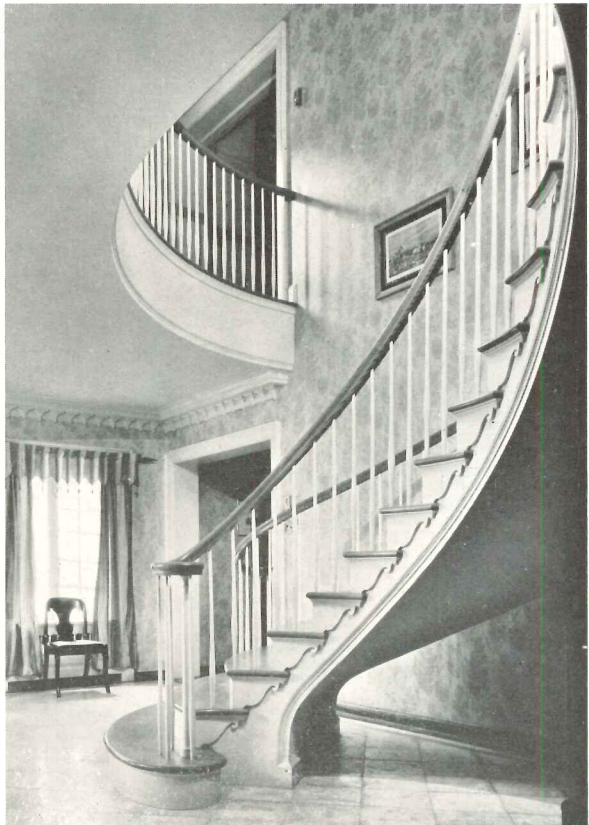

second floor

Sandstone used in exterior walls was obtained from the bed of a nearby stream, and varies in color from warm gray to orange. Tapering service wing (see plan) produced a sloping ridge line which follows site contours. Above, entrance court (residence is named "The Courtyard"); right, main stair

Alfred Cook

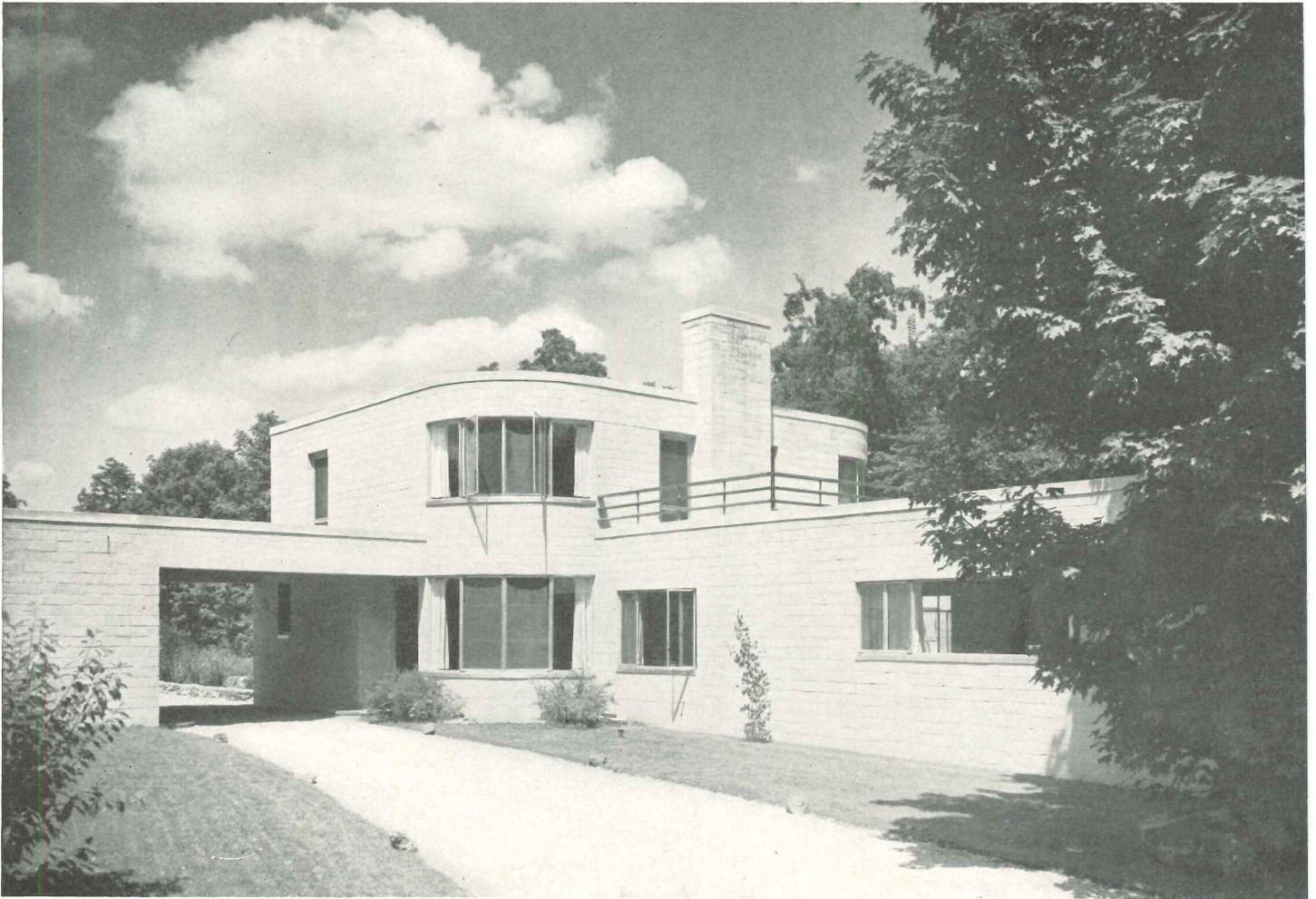

NEW CANAAN, CONN.: Residence for Mr. & Mrs. Franklin B. Kirkbride

ROBERTSON WA
Archit

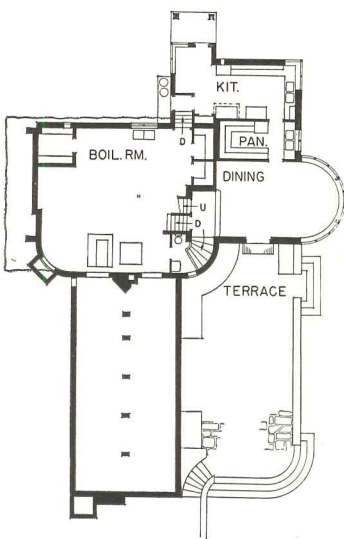

Basement

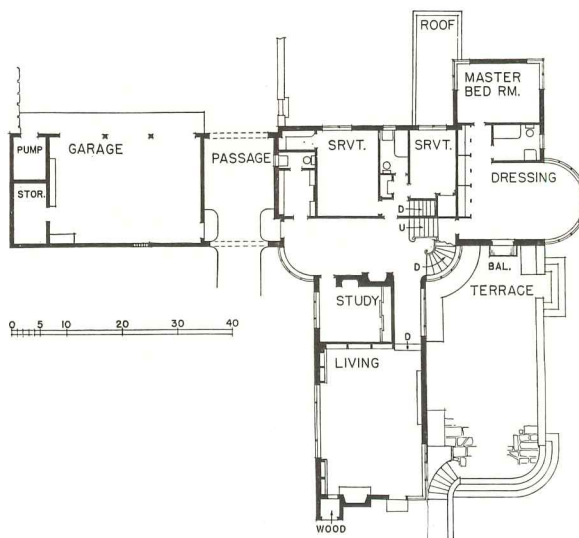

First floor

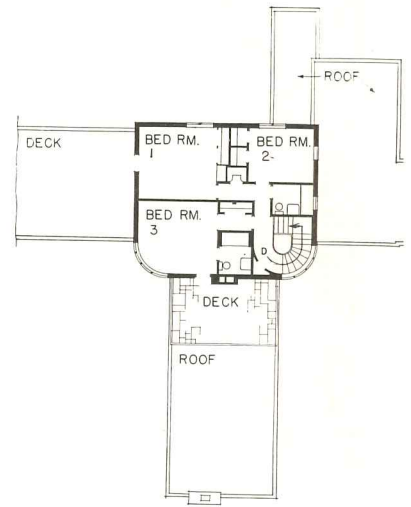

Second floor

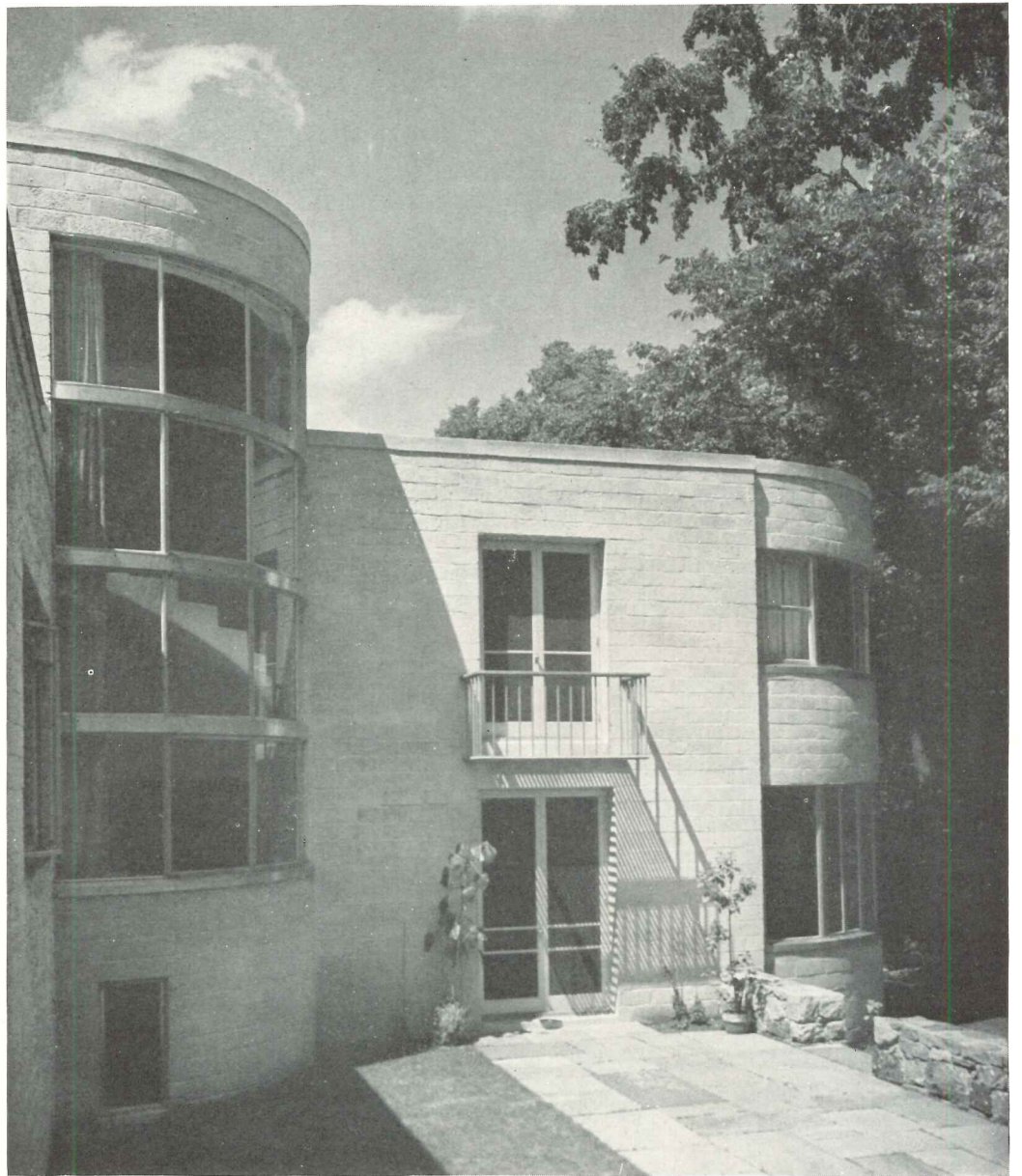

Six floor levels were required to take advantage of the sloping site. On facing page, entrance front; at right, large window in stair hall was built and erected as a unit. Below, left, another view of the terrace; right, the semi-circular bay overlooks a trout stream.

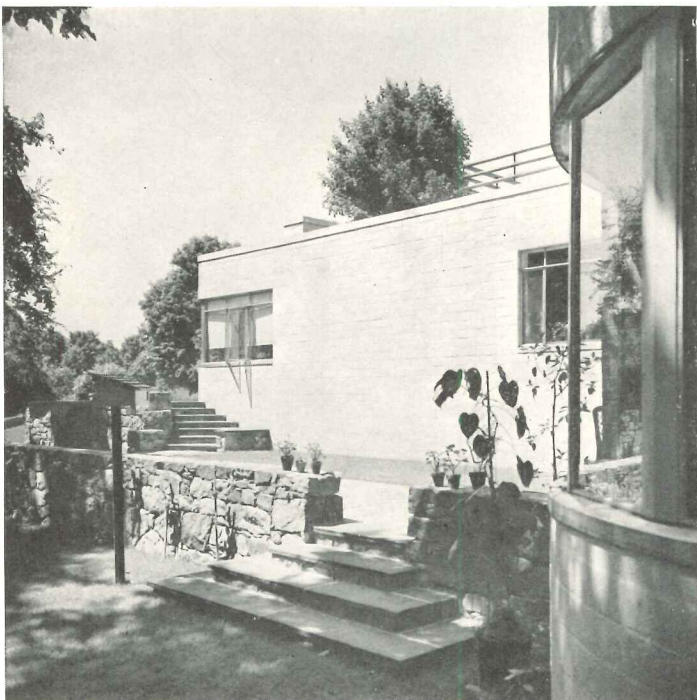

NEW CANAAN, CONN.: Kirkbride residence



Photos by Alfred Cook

Upper photograph, living room interior; lower, dining room

MATERIALS AND EQUIPMENT

FOUNDATION

Concrete

STRUCTURE

Concrete block, reinforced concrete and steel

EXTERIOR

Walls: Concrete block, Bedford Hills Concrete Products Corp.

Roof: Wood framing; built-up roofing, Barrett Co.; Quarry tile deck

Doors: Steel, Hope's Windows, Inc.; garage, Overhead Door Co.

Sash: Metal, General Bronze Corp.; glass brick, Pittsburgh-Corning Corp.; screens, Kane Mfg. Corp.

Paint: Cement paint, Artstone Rocor Corp.

Insulation: Alfol, Alfol Insulation Co., Inc.; rock wool, Eagle-Picher Sales Co.

Iron work: White Plains Iron Works, Inc.

INTERIOR

Partitions: Stud, plastered, painted

Ceilings: Plastered, painted

Floors: Steel joists, concrete; linoleum finish generally, Armstrong Cork Products Co. and Congoleum-Nairn, Inc. (Sealex); oak plank, Bruce Flooring Co.

EQUIPMENT

Heating: Air conditioning, Scott Newcomb

Plumbing: Disposal system, American Sewage Disposal Co., Inc.; fixtures, Standard Sanitary Mfg. Co.

Lighting: Fixtures, Cecil K. White

Kitchen: Cupboards, Bradley Kitchen Cabinet Co.

Cost, including fees: approx. 59¢ per cu. ft.

Details for Indoor Living Areas

Four pages of suggestions for the design of built-in furniture—equipment units which under a variety of conditions may be developed as functional parts of interior living areas . . .

LIVING ROOM — Under-window Cabinet



Residence in Great Neck, New York: Hans N. Wormann, architect and interior designer. Woodwork is straight-grained and crotched walnut; upholstery, handwoven fabrics in brown, beige, and blue; curtains, handwoven, striped blue, beige and red. Curtain and Venetian blind hardware is completely concealed.

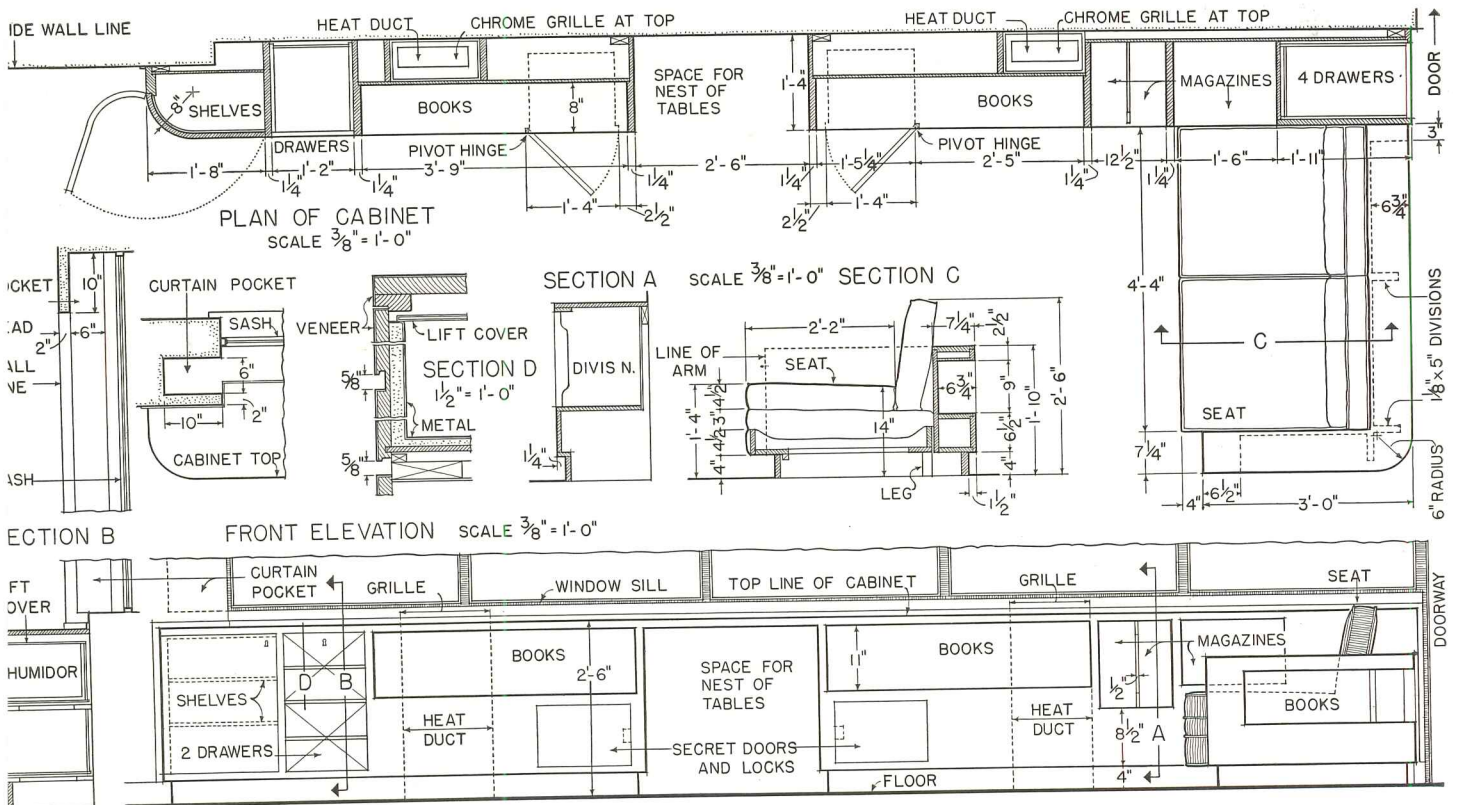
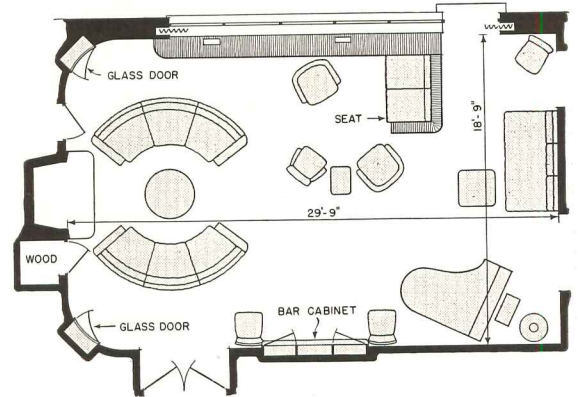

BREAKFAST ROOM

Phot. B. Chiu, Mill

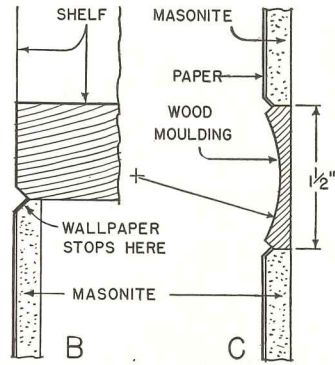
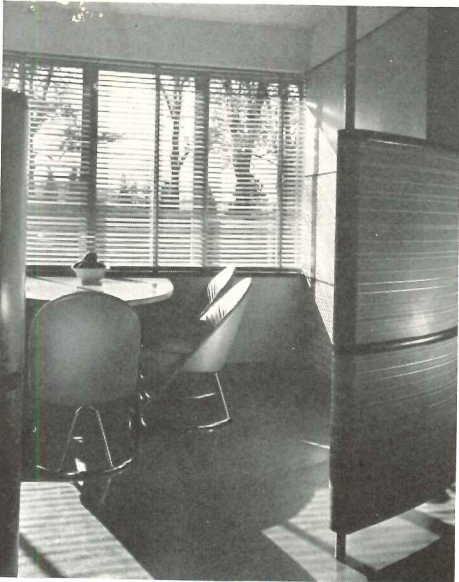

DETAILS SCALE HALF FULL SIZE.

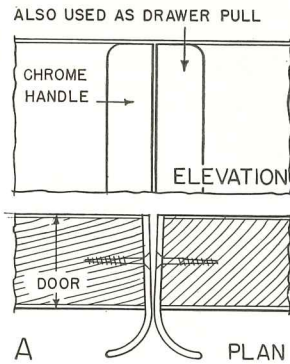

ALSO USED AS DRAWER PULL

Residence in Kansas City, Mo.; alcove designed by Kem Weber; E. W. Tanner, architect. Table standard and top are covered with Armstrong's linoleum, with red lacquered hardwood edges. Cabinets and screen are designed to give privacy to occupants, since the room serves as a passageway from pantry to front door.

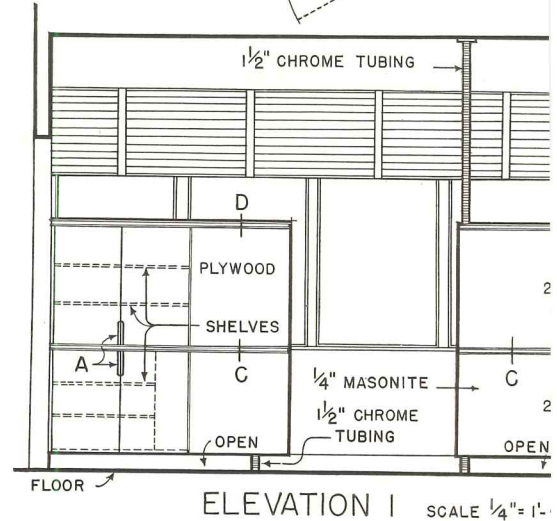
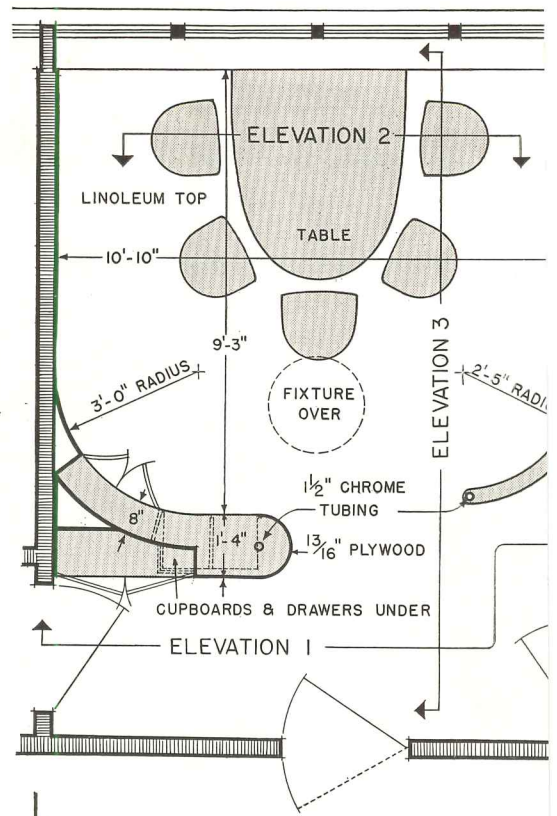

ELEVATION 1 SCALE 1/4" = 1'-0"

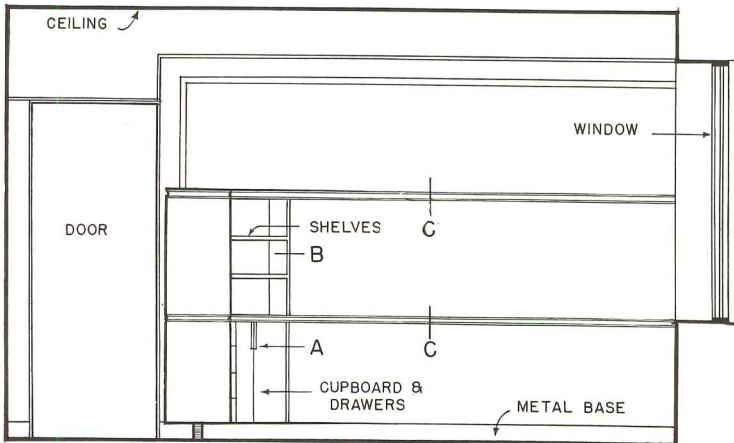

ELEVATION 3 SCALE 1/4" = 1'-0"

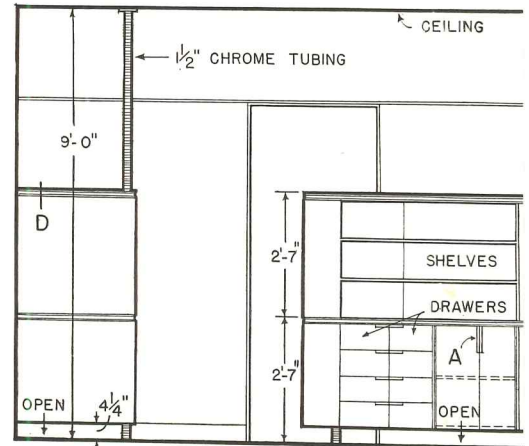
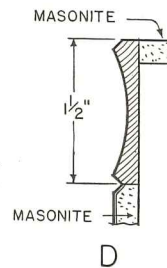

ELEVATION 2 SCALE 1/4" = 1'-0"

HILD'S ROOM – Desk, Bins, and Cupboards

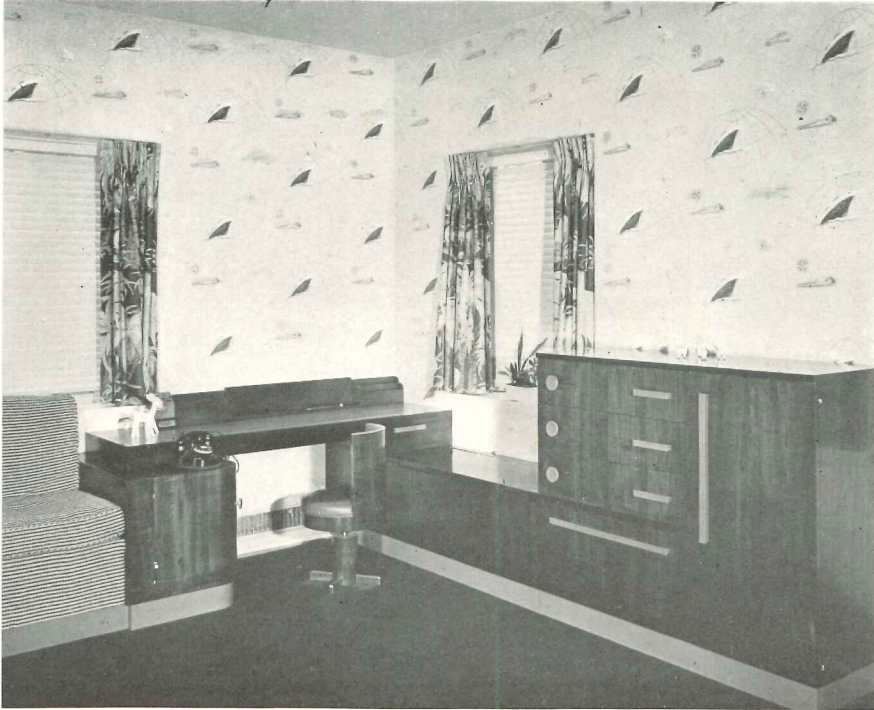

Cafritz residence, Washington, D. C.: Eugene Schoen & Sons, architects and interior designers. The floor is of cork, covered with a rug. The desk and cupboard unit is of brown maple, lacquered, with maroon Catalin knobs and pulls. The base is maroon Formica. The desk has an inset linoleum top surface.

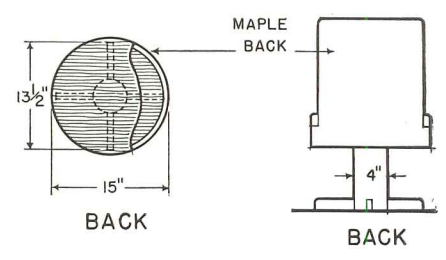
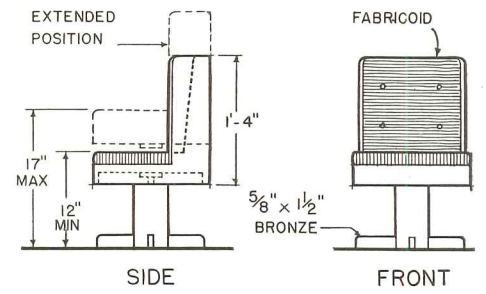
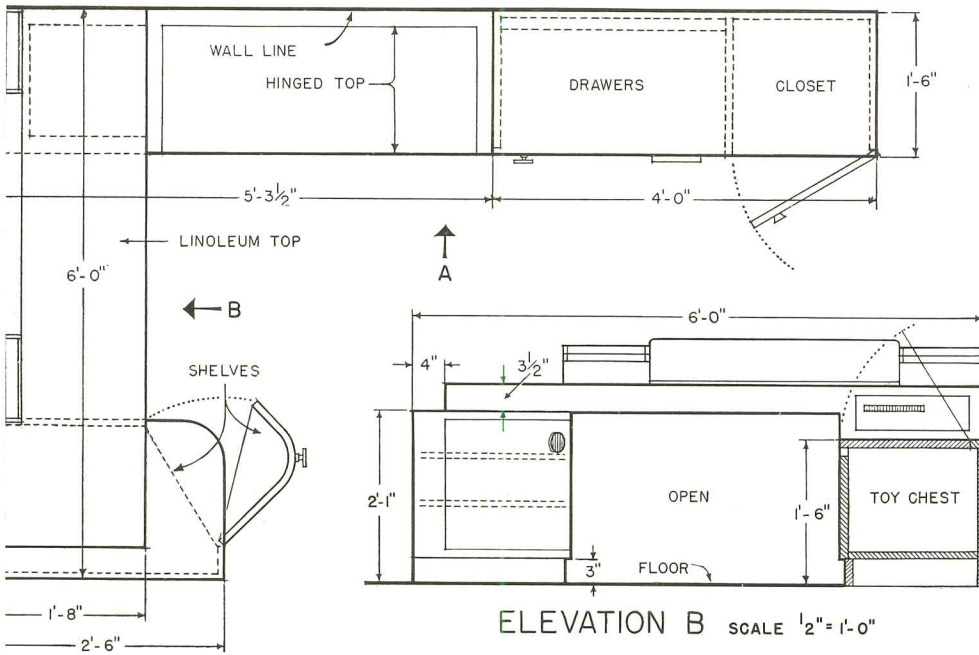
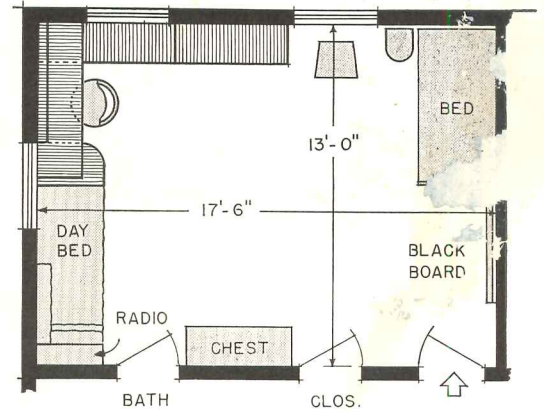

CHAIR DETAIL SCALE $\frac{1}{2}'' = 1'-0''$

LAN SCALE $\frac{1}{2}'' = 1'-0''$

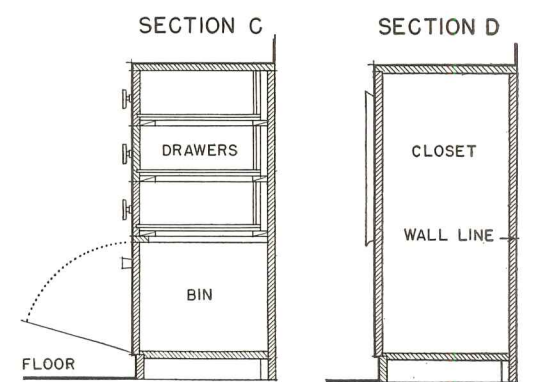
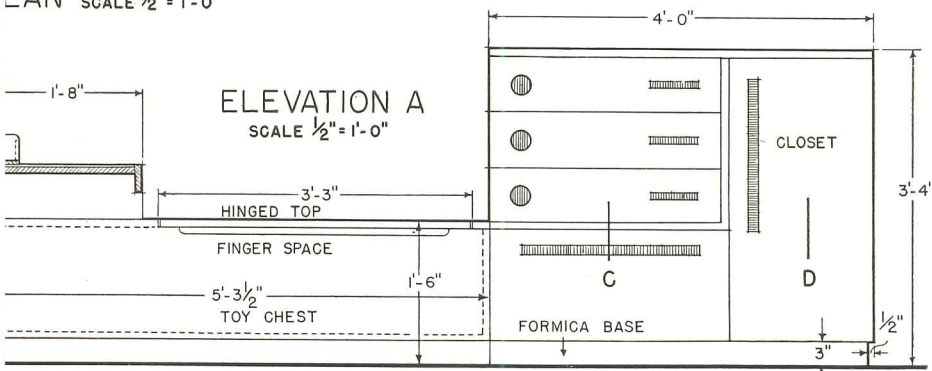

BEDROOMS - Built-in Beds

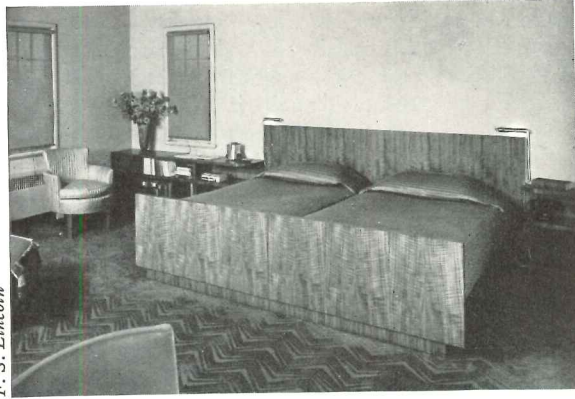

F. S. Lincoln

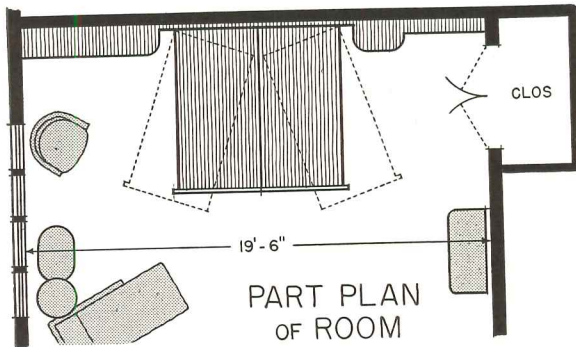

Residence in Elmsford, N. Y.: Joseph Aronson, designer. Notice that the night tables are set far enough away to permit beds to be swung out for ease in making them up.

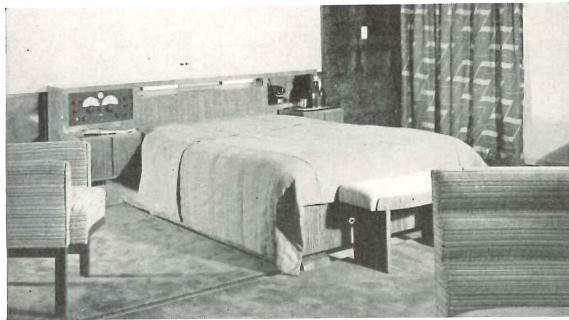
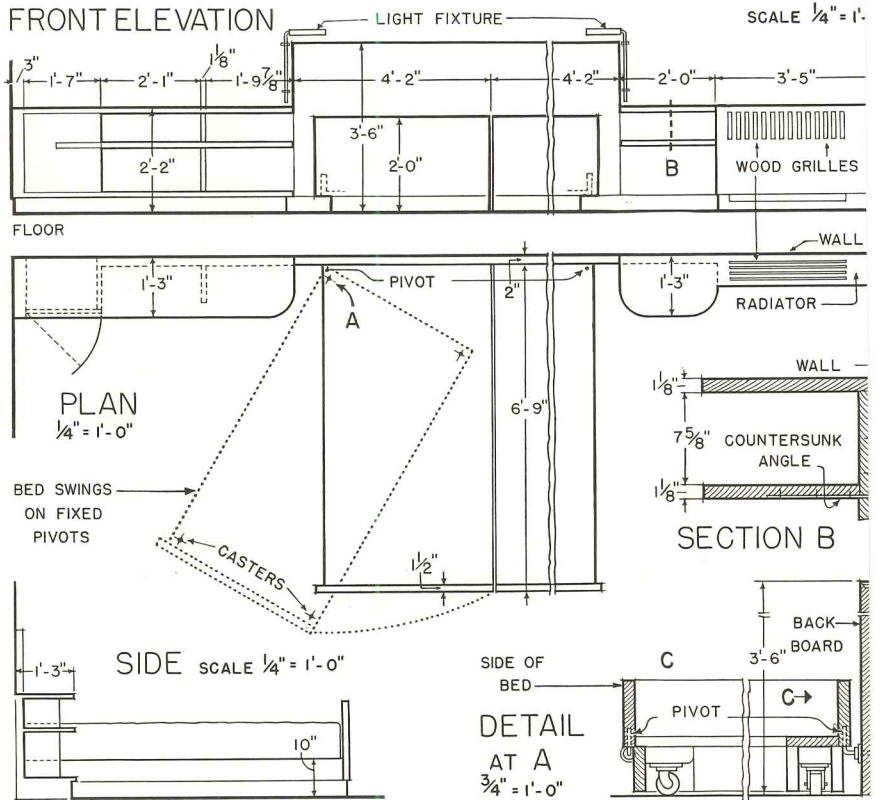

Cafritz residence, Washington, D. C.: Eugene Schoen & Sons, architect and interior designers. The bed is of English brown oak; the night table are hinged to the head cabinet and swing out away from the bed.

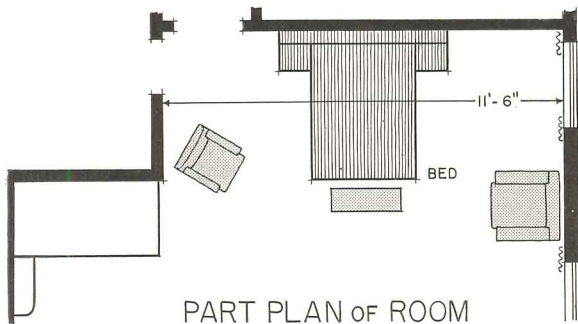
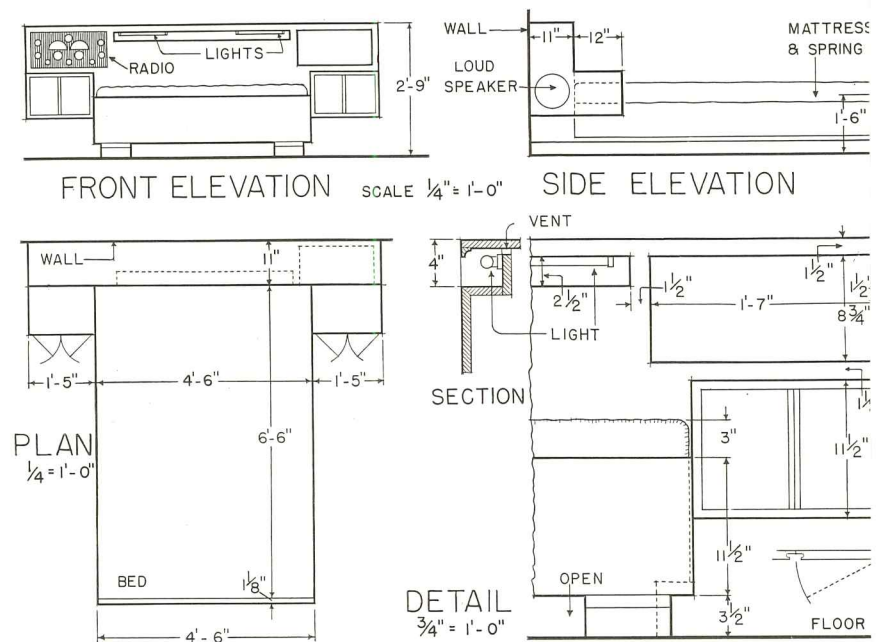

FREE STANDING WALLS

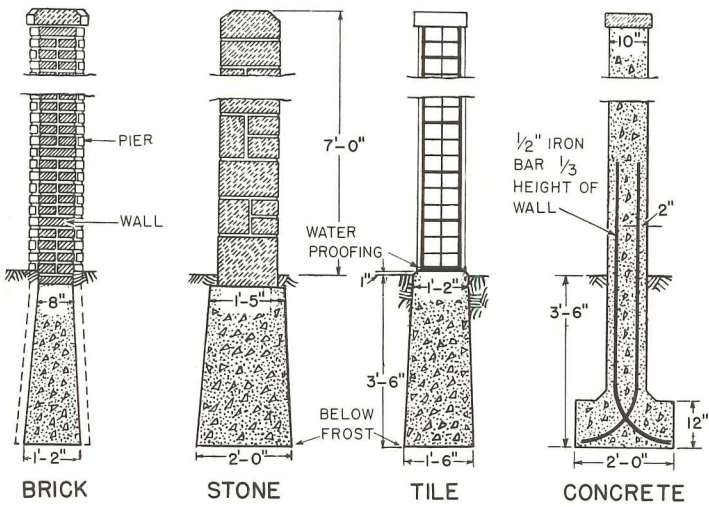

PIER AND WALL BOND

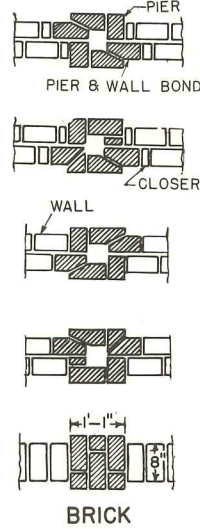

RETAIN'G WALLS, Reinf.

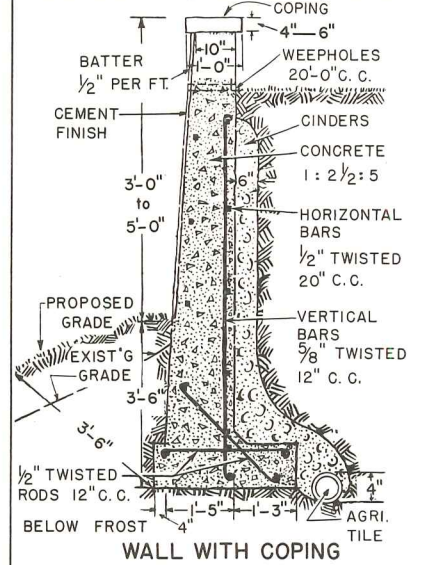

PLANTING POCKETS

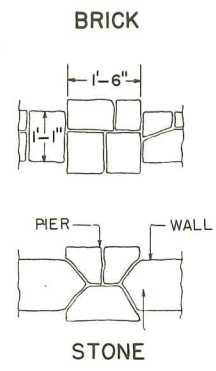
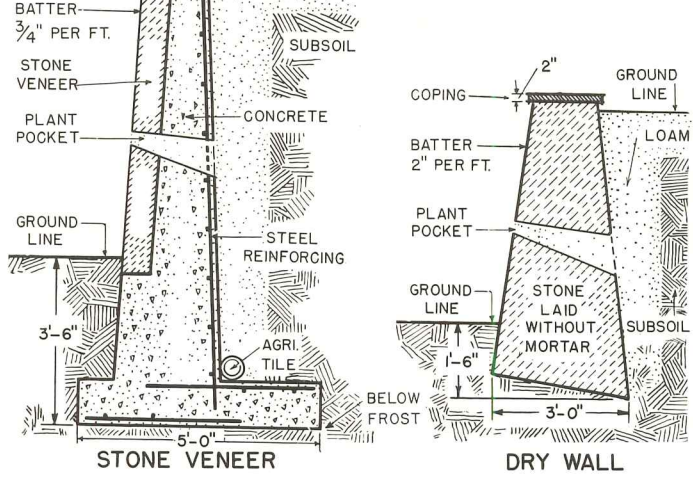

Prepared by
A. D. TAYLOR
LANDSCAPE ARCHITECT

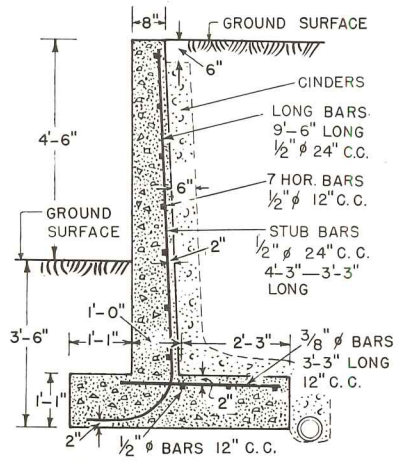

LOW WALL, NO COPING

RETAINING WALLS, Not reinforced

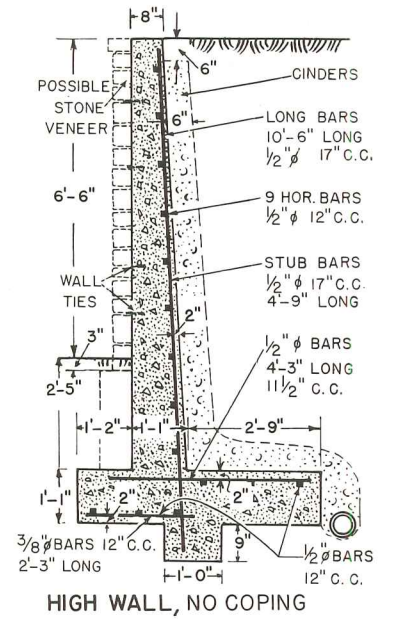
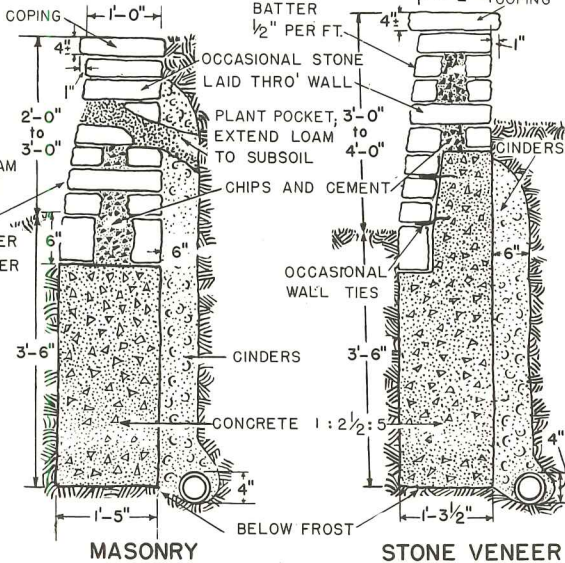
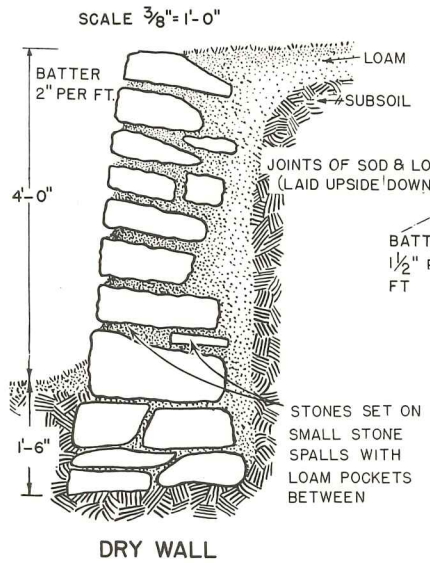

HIGH WALL, NO COPING

SCALE 1/4" = 1'-0" EXCEPT AS NOTED

CONCRETE POOL
(NOT TO SCALE)

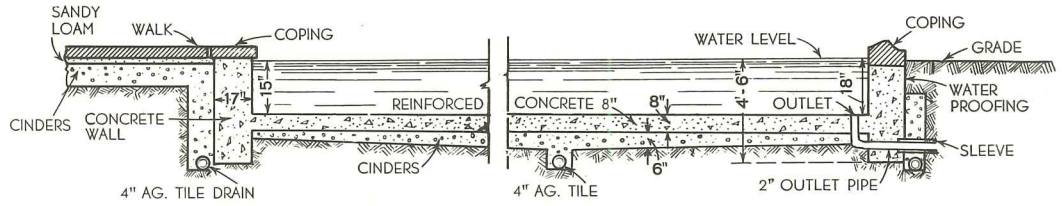

**CONCRETE POOL
STONE OR BRICK VENEERED**
(NOT TO SCALE)

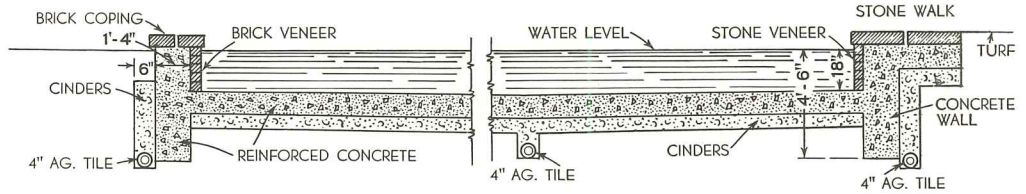

INFORMAL POOL
(NOT TO SCALE)

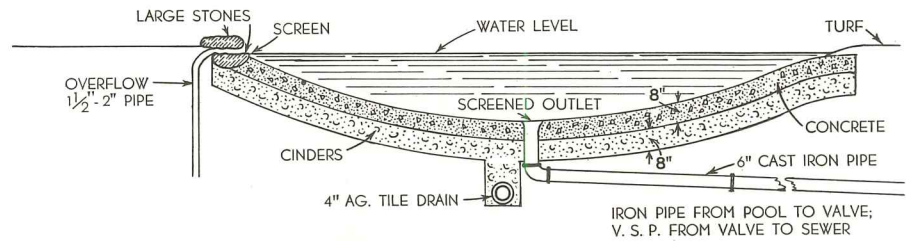

**INFORMAL POOL
ALTERNATE EDGINGS**
(NOT TO SCALE)

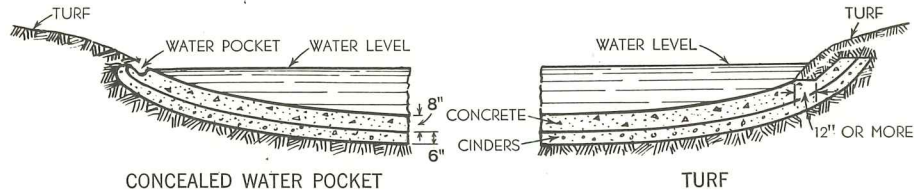

NOTE: All metal piping except lead must be protected from cinder fill. If gravel is used, protection may be omitted.

COMBINED BIRD BATHS AND LILY POOLS

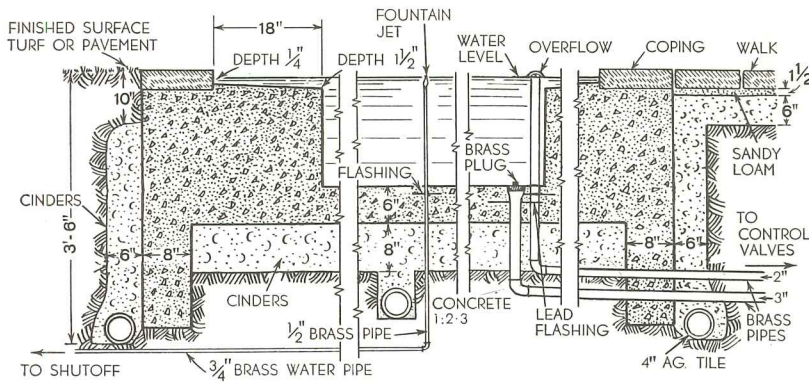

BIRD BATH AT EDGE OF POOL

SCALE: $\frac{3}{8}'' = 1'-0''$

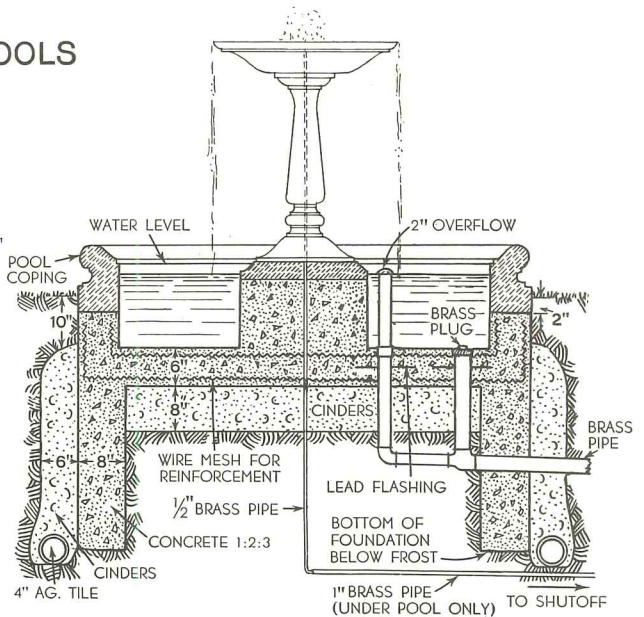

UPRIGHT BIRD BATH

Prepared by A. D. TAYLOR LANDSCAPE ARCHITECT

SIDE OVERFLOW

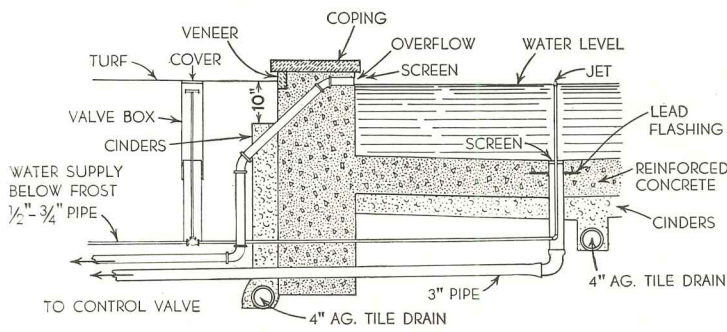

SURFACE OVERFLOW

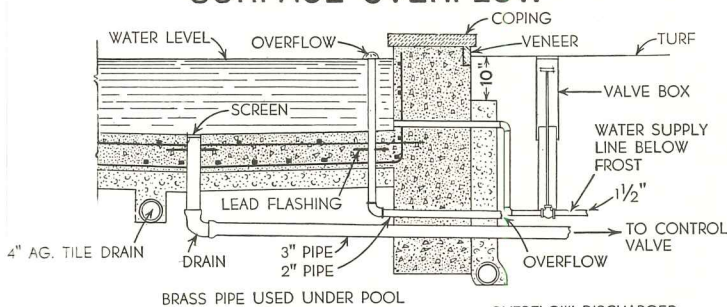

TYPICAL DRAINAGE PIPING

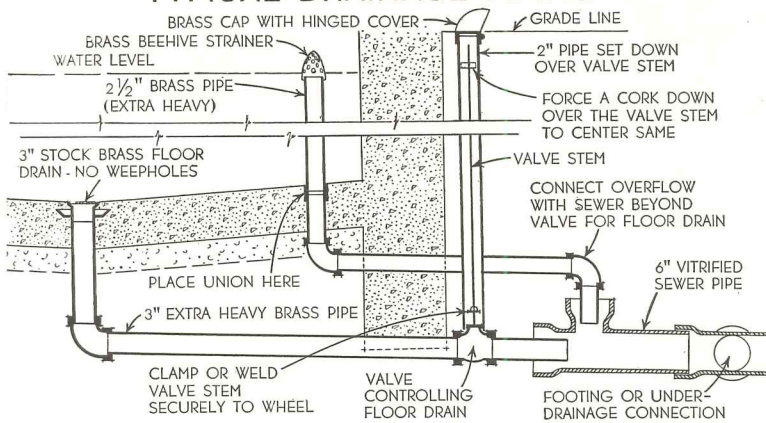

TYPICAL SUPPLY PIPING

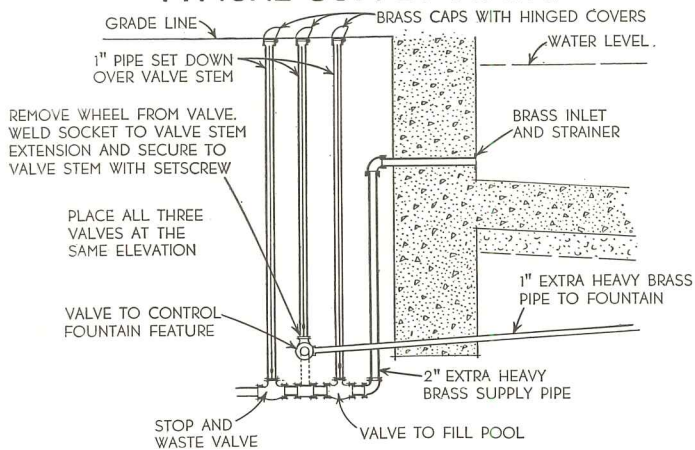

**ALTERNATE TYPES OF
OVERFLOWS**

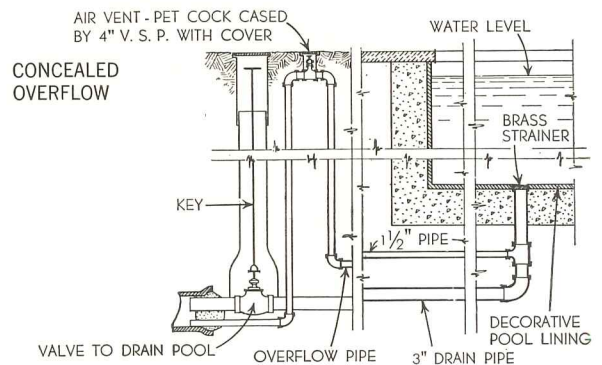
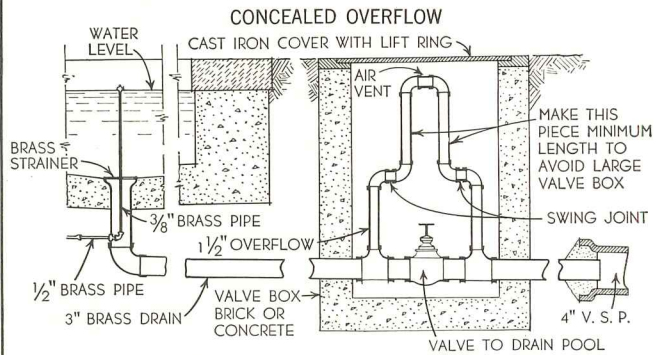

CURB BOX

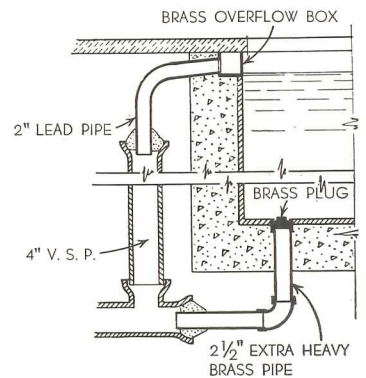

VITRIFIED SEWER PIPE

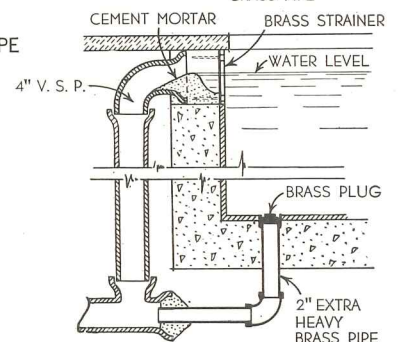

NOTE:— Pool piping may be of either iron, brass or lead. Use of extra heavy brass pipe under concrete eliminates difficulty in replacing pipe. All metal pipe should be protected from cinder fill by embedding it in concrete or by using non-ferrous, waterproof sleeves.

NO SCALE

Prepared by A. D. TAYLOR LANDSCAPE ARCHITECT

STEPS

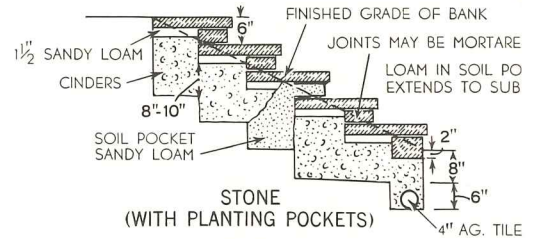
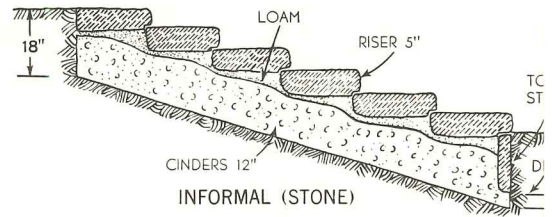
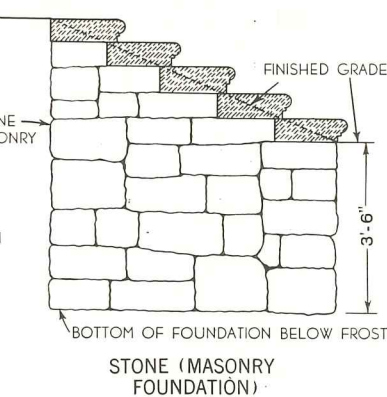
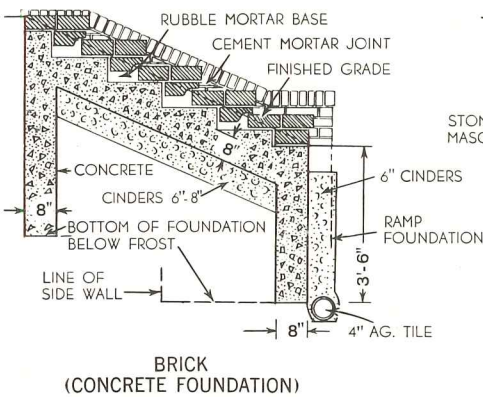
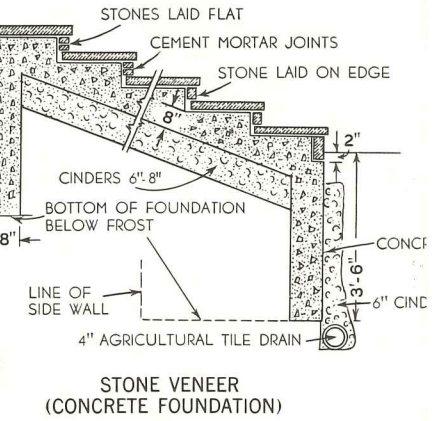
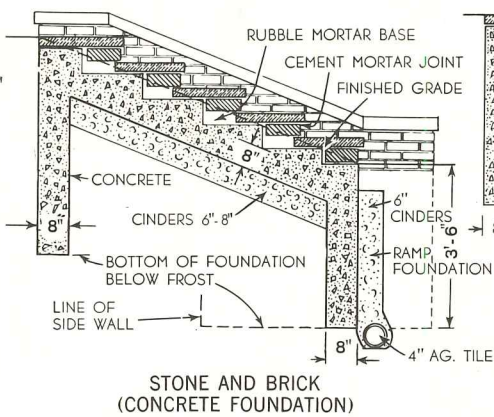
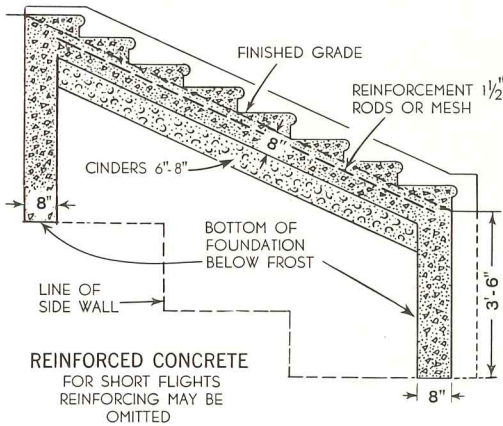

RAMPS

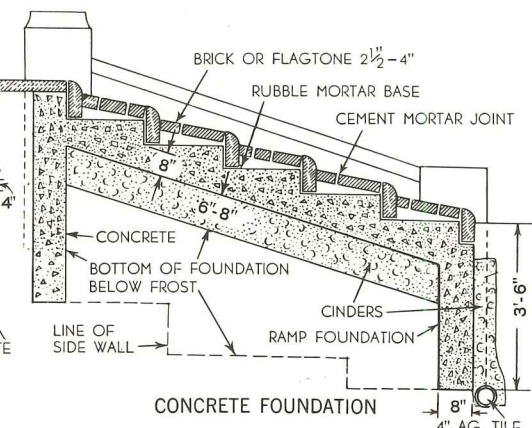
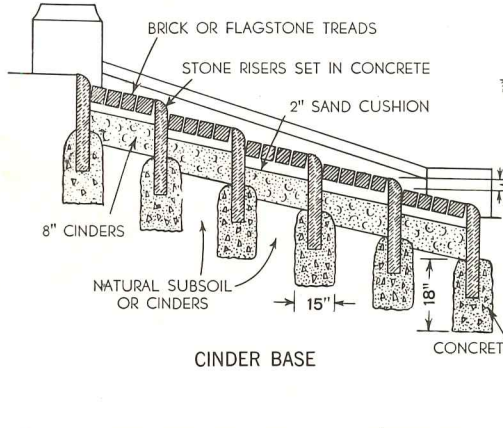

TURF STEPS ALTERNATE METHODS

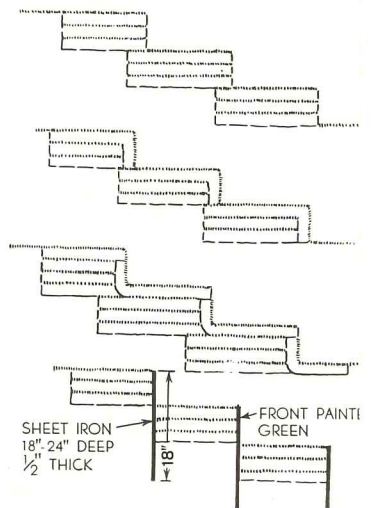

PERRONS

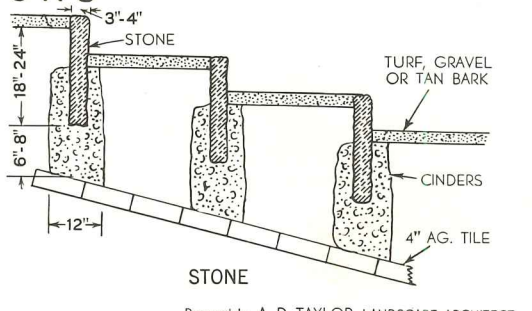
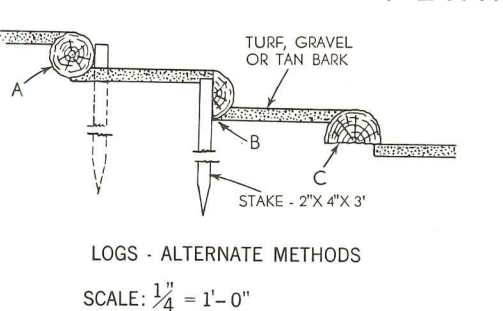

WASH ON STEPS

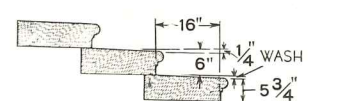

Prepared by A. D. TAYLOR LANDSCAPE ARCHITECT