

# BUILDING NEWS



Saint-Thomas

**Spear's—11,792 pedestrians pass it daily . . . .**

ARCHITECTURAL  
RECORD

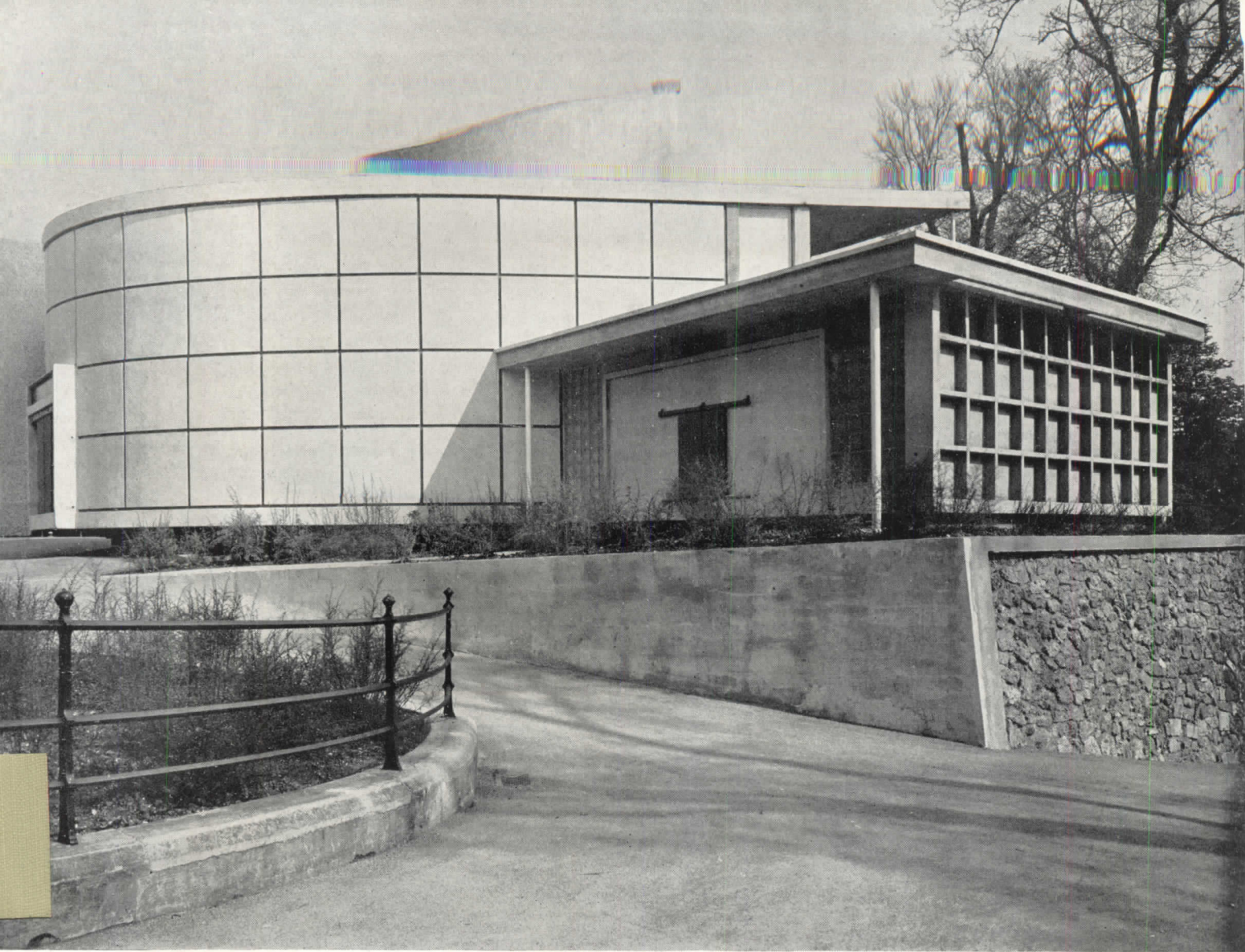

Herbert Felton

## ANIMALS, ARTISTS COMFORTABLE IN NEW LONDON STUDIO

LUBETKIN & TECTON

Architects

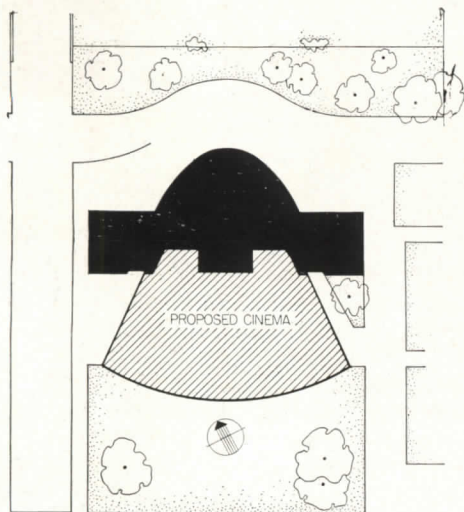

Plot Plan (above) and Section (below)

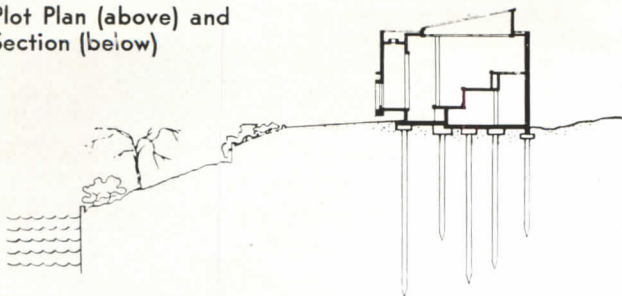

TO PROVIDE THE BEST possible conditions for the drawing from life of wild animals, London's Zoological Society (in conjunction with the London and Middlesex County Councils) recently opened this Studio of Animal Art at the Regent's Park Zoo. Designed by a firm already famous for its zoological architecture (see AR, 2/35, pp. 107-112, for their penguin pool and gorilla houses), the Studio solves a twofold problem: comfort for the artists who hitherto have experienced great difficulty in sketching the animals owing to bad lighting conditions, curious crowds, etc.; comfort for the animals made restless by the crowds, open cages and general confusion. It is in the solution of this problem, even more than those of the site itself—soil conditions, boundaries, orientation, etc.—that the Studio sets new standards of performance.

First unit of a more comprehensive plan—in the near future it is proposed to add a cinema for the showing of moving pictures, microphotographs, slides, etc.—the Studio of Animal Art is in itself complete. It provides one large studio for 25 students, 2 private studios for 1 or 2 persons, storage space, toilets, etc. The *design process* by which the architects arrived at the finished

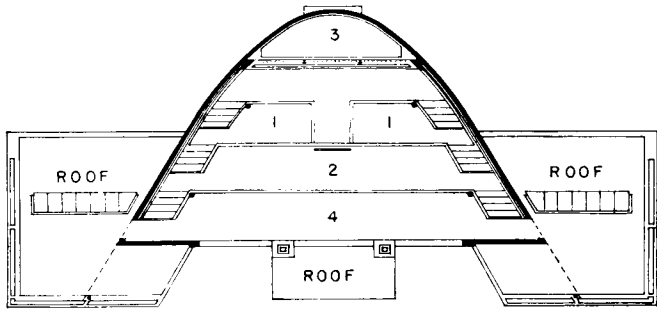

PLAN AT TOP TIER: 1, 2 and 4, tiers; 3, upper part of cage

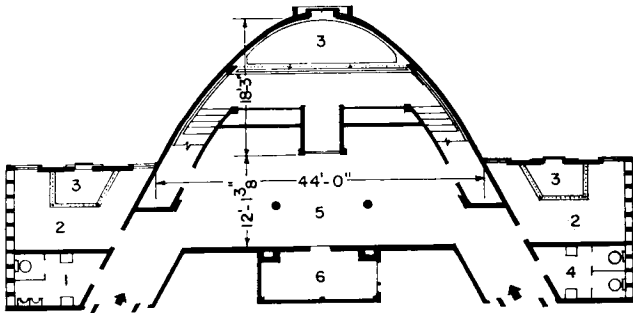

PLAN AT MAIN-FLOOR LEVEL: 1 and 4, toilets; 2, private studios; 3, cages; 5, lobby; 6, air-conditioning equipment



Charles Borup

Detail: One of the private studio wings with latticed walls for bas-relief display

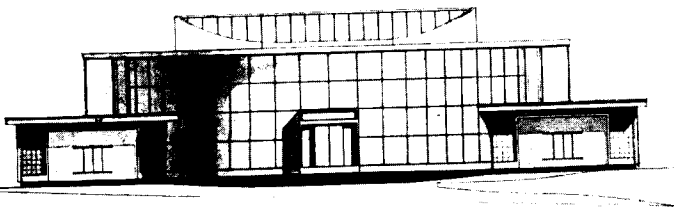

Rear (North) Elevation

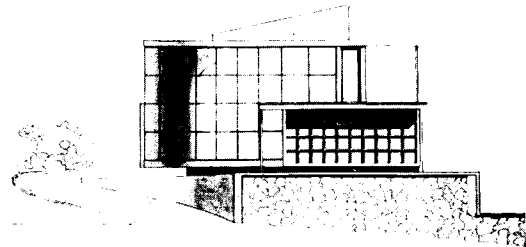

Side (West) Elevation

form—see their sketches on page 66—indicates that the final form of the Studio is by no means the result of whimsey. On the contrary, every element of plan, construction and equipment bears the mark of painstaking research. Thus the parabolic shape and stadium section of the main studio provide maximum visibility for the artists while giving the animals the maximum sense of security. Similarly, lighting, ventilation and sound control have been carefully studied.

Because economy was a controlling factor, construction had to be kept simple: at the same time it was required that it be permanent, fireproof and sanitary: hence the architects used reinforced concrete throughout. Externally, the concrete was left exposed, except on the parabolic surfaces, which were finished in terrazzo panels, and the temporary brick partition along the south

wall of the lobby. The open concrete latticework on both wings (top, facing page) are designed for outdoor semi-permanent displays of students' bas-reliefs. Internally, the floors are a mastic composition, with plastered walls and ceilings; since the roars of the animals would otherwise be objectionable in such a parabolic shape, the side walls are cork-lined. The cages are teak-floored and guttered for easy washing.

Control of light—both natural and artificial—has been handled with extraordinary precision in the main studio (see following pages) while in the private studios flat skylights and glass-block walls, together with artificial lighting, provide for a variety of effects. Control of atmosphere is likewise precise, the ventilation of the cages proper being isolated from that of the building. Air-conditioning equipment is ample for future cinema.

## ANIMAL STUDIO

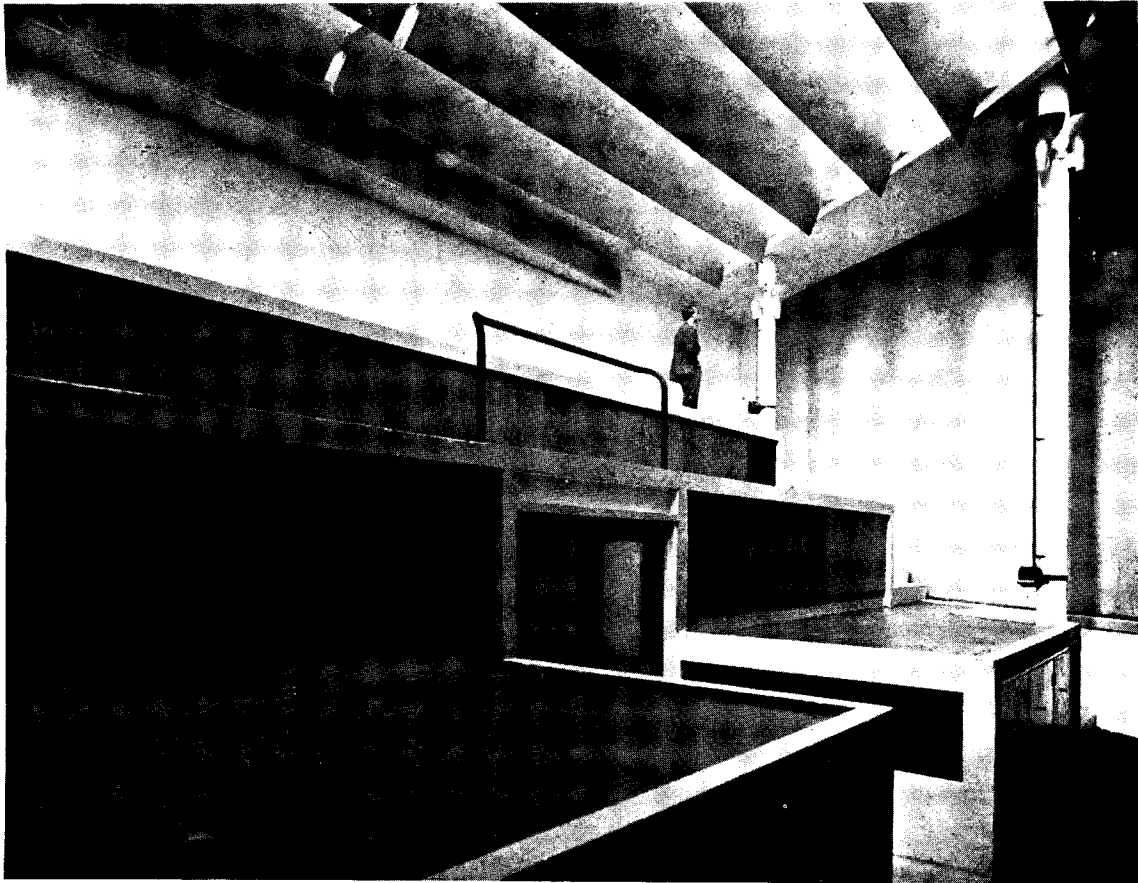

*Herbert Felton*

MAIN STUDIO: 3 tiers give adequate space to 25 students, either sitting or standing; lead-lined clay cupboards are incorporated in the first tier.

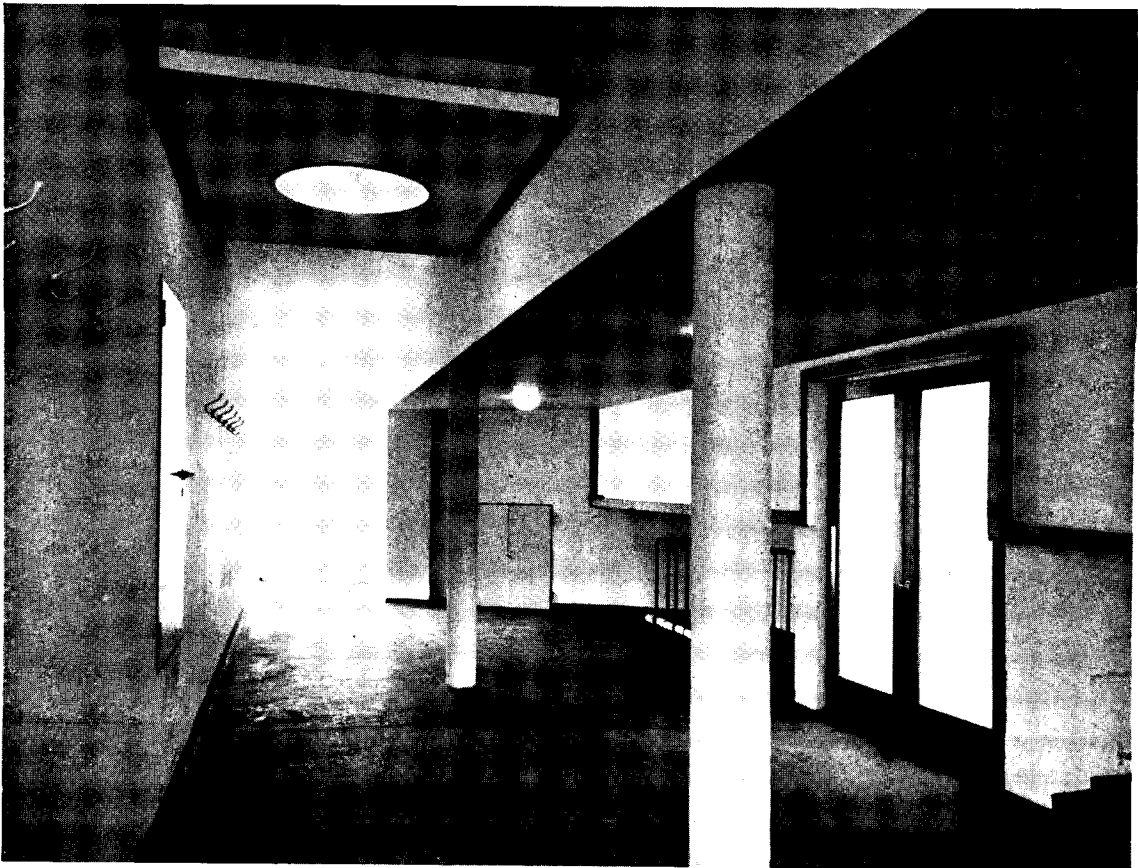

*Charles Borich*

LOBBY: Storage for specially designed easels is provided at right.

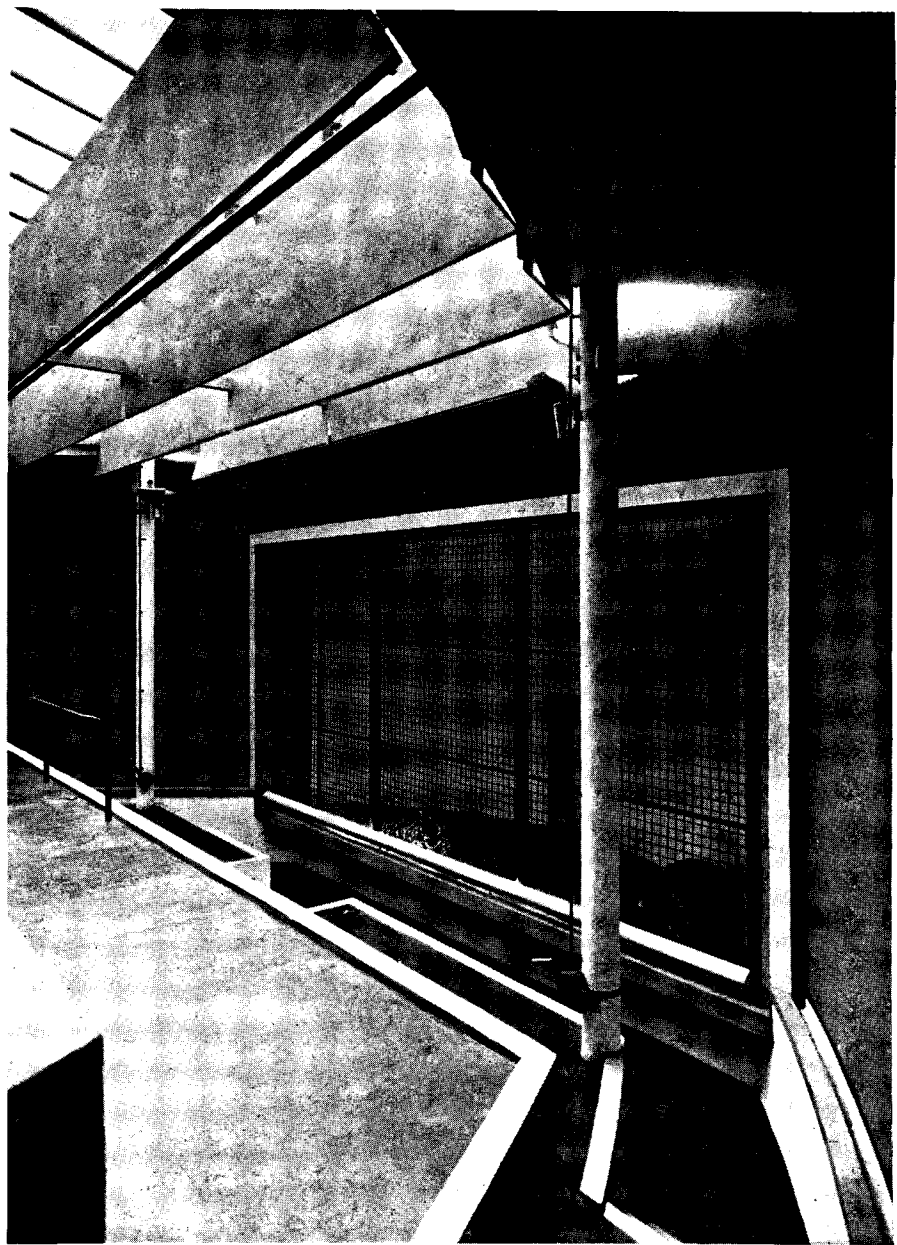

Herbert Felton

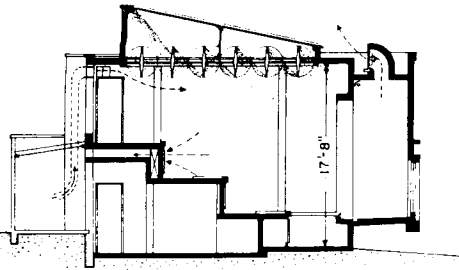

The tigers (right), with their backs safely to the wall, are quieter than in an open cage, while the welded wire mesh—replacing the usual bars—provides both scale and proportion for students who need it. The section (above) shows independent ventilation systems for animals and students.

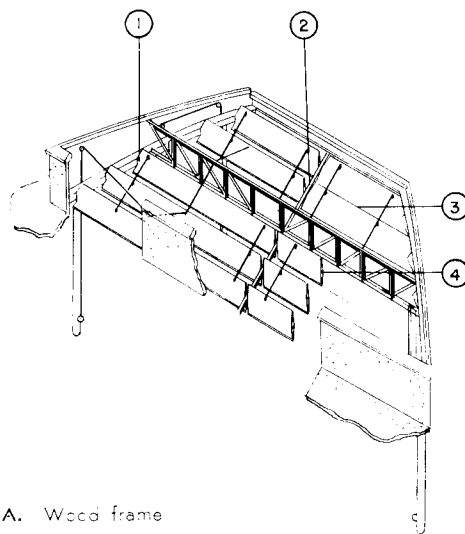

- A. Wood frame
- B. Metal pivots
- C. Hardwood sockets
- D. Plywood sheathing

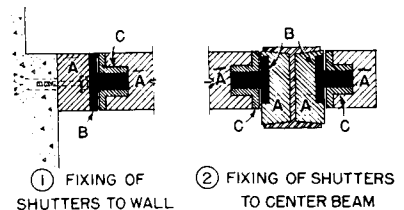

① FIXING OF SHUTTERS TO WALL

② FIXING OF SHUTTERS TO CENTER BEAM



③ MEETING OF SHUTTERS IN CLOSED POSITION

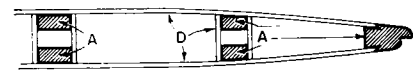

④ CROSS SECTION SHOWING CONSTRUCTION OF SHUTTERS

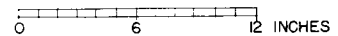

Control of both artificial and natural light is provided by aluminum-coated plywood shutters which are easily controlled by cranks at either side; completely closed, they form a reflecting surface for indirect lighting. In addition, the cage is equipped with spots and foolights for special effects.

# ANIMAL STUDIO

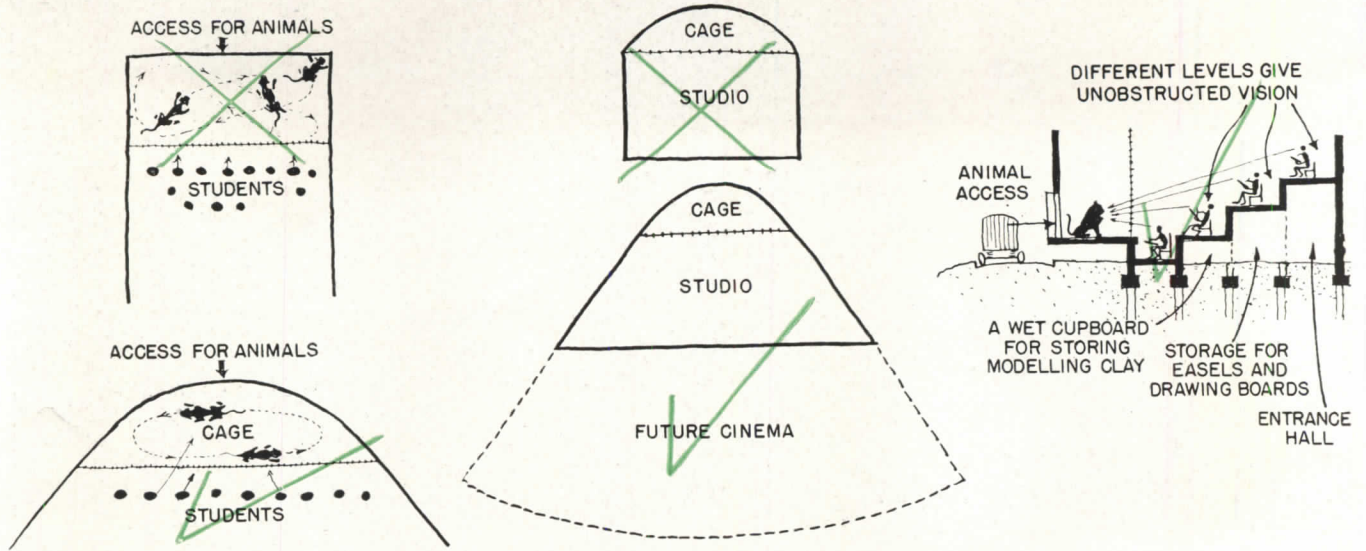

**PLAN AND SECTION:** These sketches by the architects record the design process by which the building was evolved. A square cage was discarded in favor of the parabola because the animal's path is thus controlled,

always returning to the same position. A rectangular studio gave way to a fan-shaped one, both because it was internally better and because it tied in better with proposed cinema. Advantages of tiered floor levels are obvious.

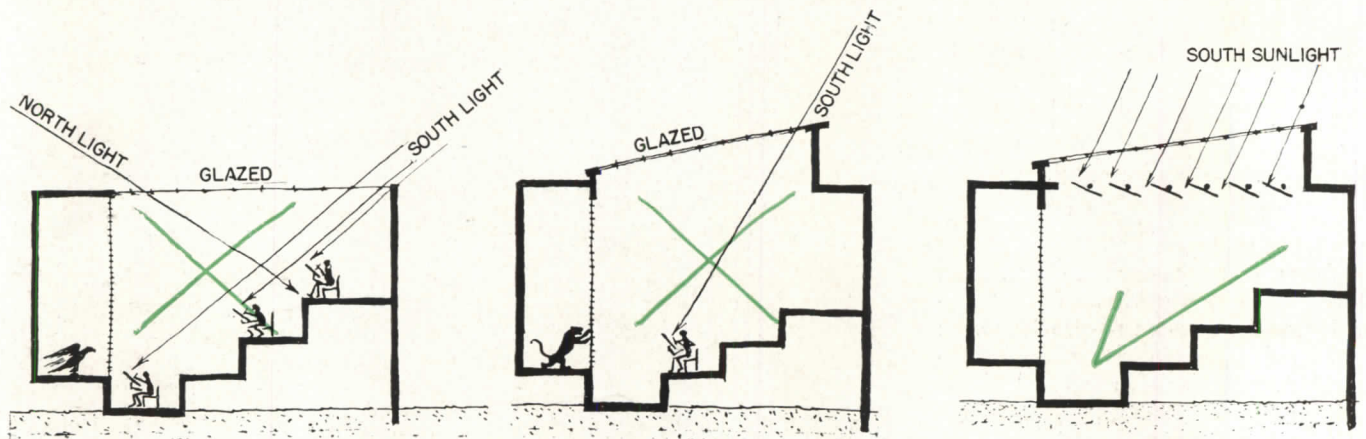

**NATURAL LIGHT:** Exigencies of the plot precluded north light and a flat glazed roof would allow the south sun to shine directly on the drawing boards. To exclude the latter, a tilted skylight was implied. But how much

tilt? With an accurate model and a heliodon, studies were made and an angle determined which excluded all but highest summer sun. Last step was design of shutters to control this and all north light.

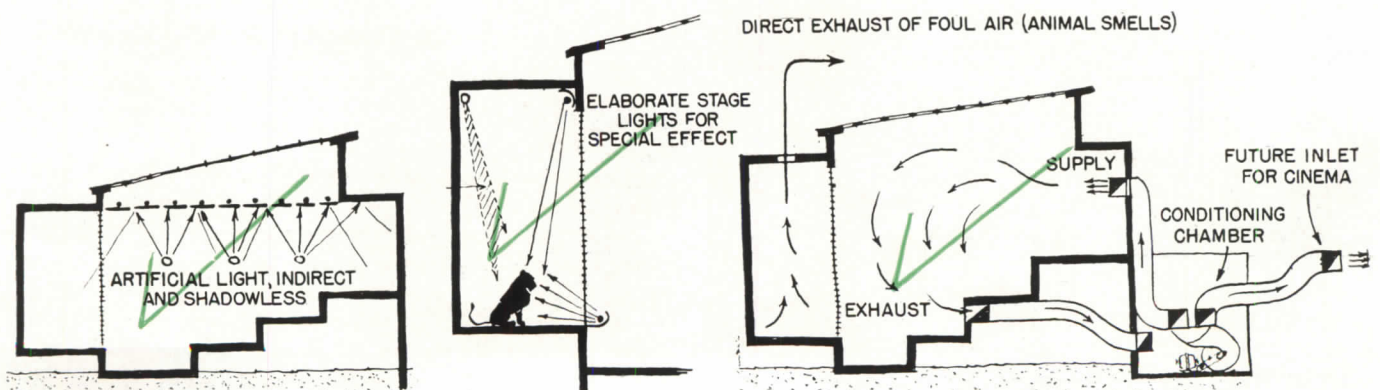

**ARTIFICIAL LIGHT, HEATING AND VENTILATING:** Surfaced with aluminum paint, these shutters then serve as a reflecting surface for indirect lighting. Added finally were lights for special effects and an infrared lamp in

whose rays the animal can "sun" himself (center, above). Although the entire studio is air-conditioned, a special exhaust over the cages removes animal odors before they are picked up by the central conditioner.

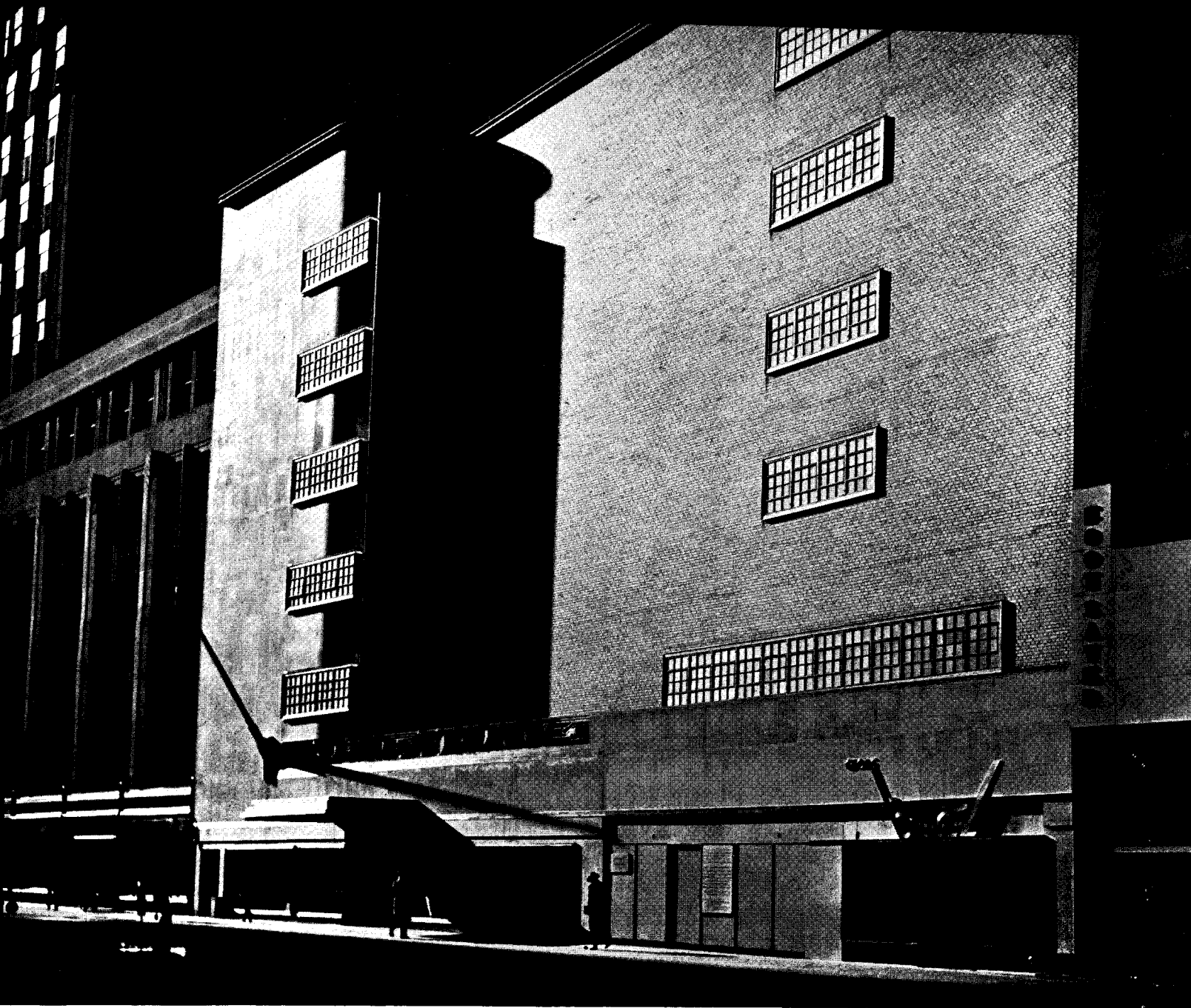

Elevation from west

*Saint-Thomas*

## REDESIGNED FACADE USES RECESSED SIGN TO DRAW CROWD

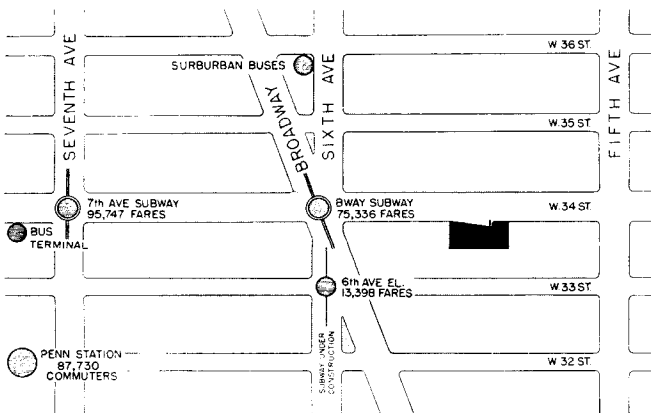

Convenient to almost all the city's rapid transit systems and to rail and bus terminals, the store makes the most of its location by placing the projecting sign in direct line of vision of disembarking passengers. Figures shown above are average daily fares paid during 1937.

DE YOUNG & MOSCOWITZ

Architects

SITUATED on "New York's busiest block", the recently remodeled Spear's Furniture Store features a novel exterior wall treatment, which springs from a building code prohibiting illuminated signs which project beyond the building line. Motivated by the fact that Pennsylvania Station, bus terminals and passenger outlets of rapid transit systems are all west of the store site, the architects decided to face the large neon-lighted sign toward the greatest number of potential customers: hence the eastward direction of the wall splay. The simple surface treatment of the exterior—in contrast to more elaborate fronts nearby—is itself an effective advertising agent; but the well-integrated design of signs and wall surfaces provides an unusually spectacular display.



Photos by Saint-Thomas

Seen from the East, the facade is an "eye catcher" because of the unusual splayed wall.

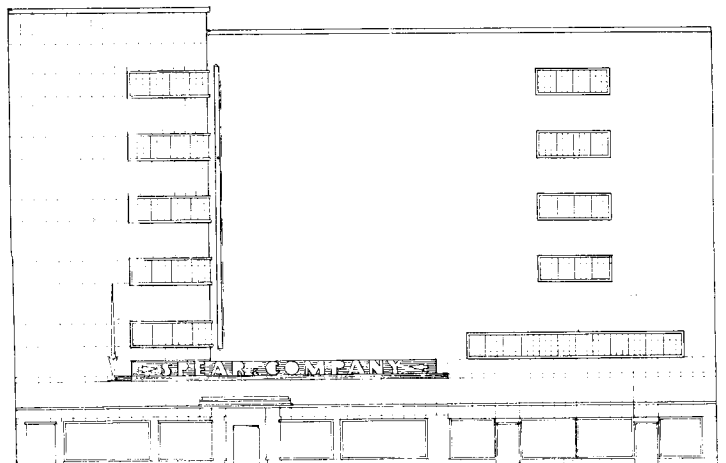

Elevation

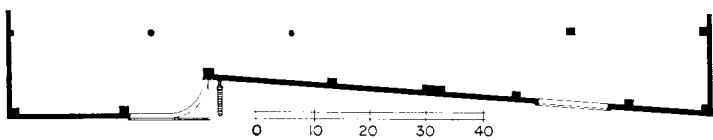

Plan at Second Floor

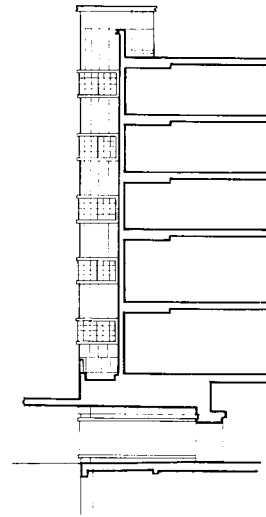

Section

Two materials are used for the building's exterior finish: the splayed wall is of buff brick; the rest is of Rockwood stone. Cornice is likewise of Rockwood stone. The base is granite. All windows have steel sash.



# REDESIGNED FACADE

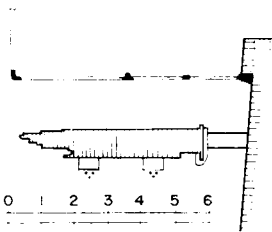
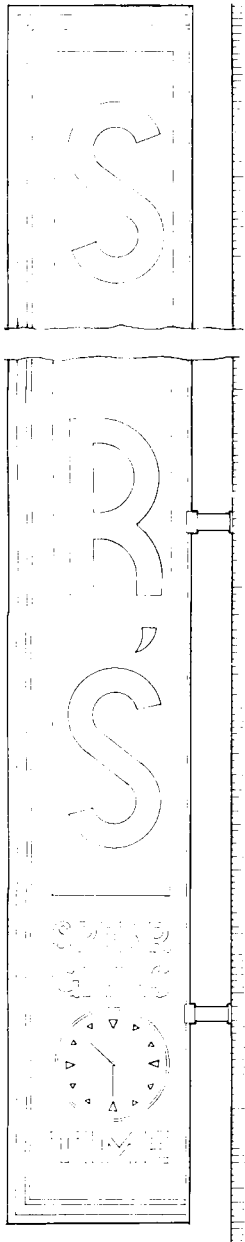

Elevation and Section of Sign

Advertising value derived from the vertical and horizontal signs and the new front to Spear's store compensates for the expense. Contractor's figures on the cost of the wall alone were \$49,000; signs, of porcelain enamel with nickel-bronze trim, cost an additional \$10,500.

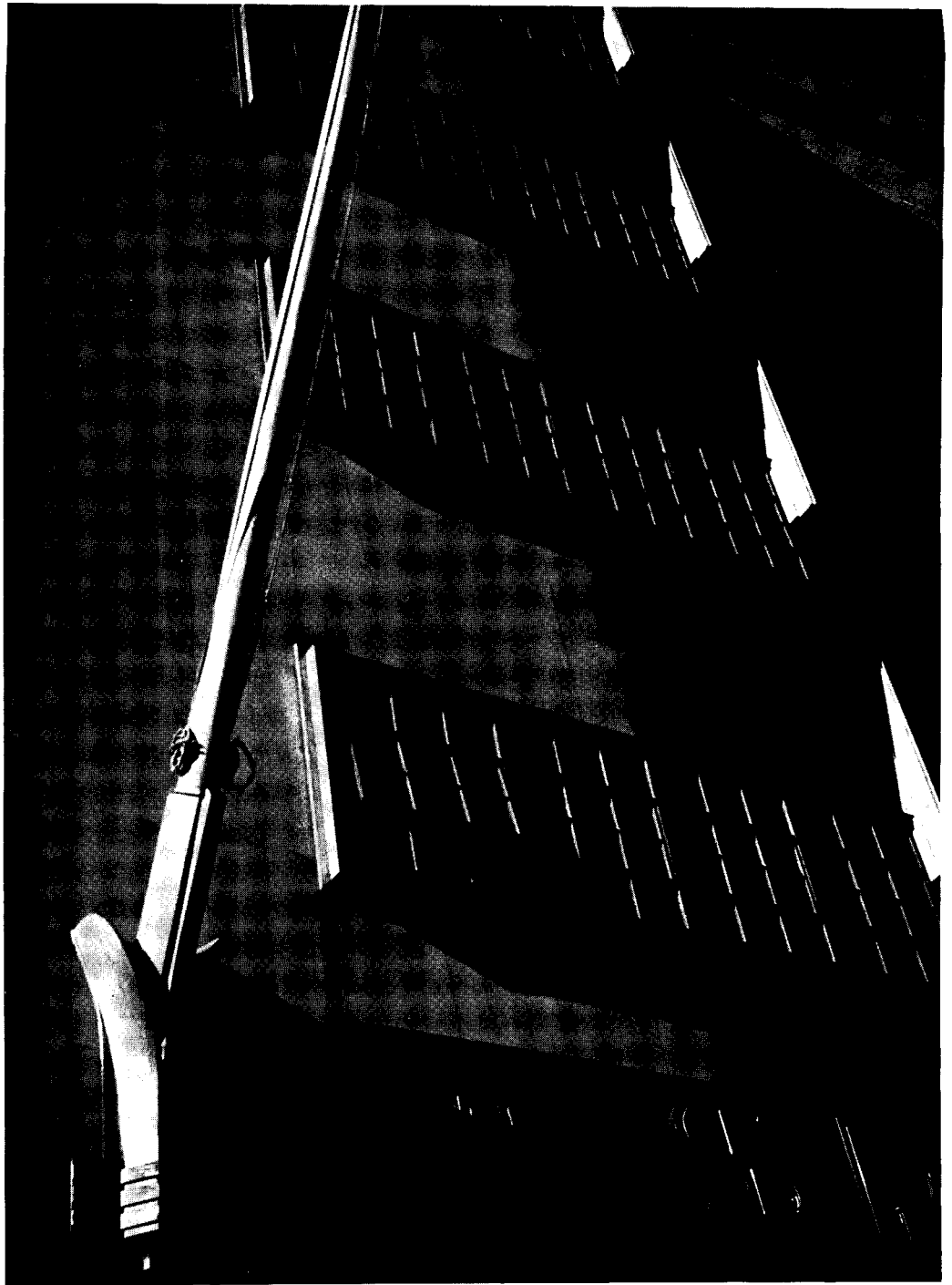

# REDESIGNED FACADE



Saint-Thomas

Marquee

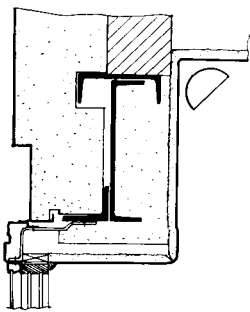

Detail of store front showing lighting fixture concealed above window line instead of behind conventional valance

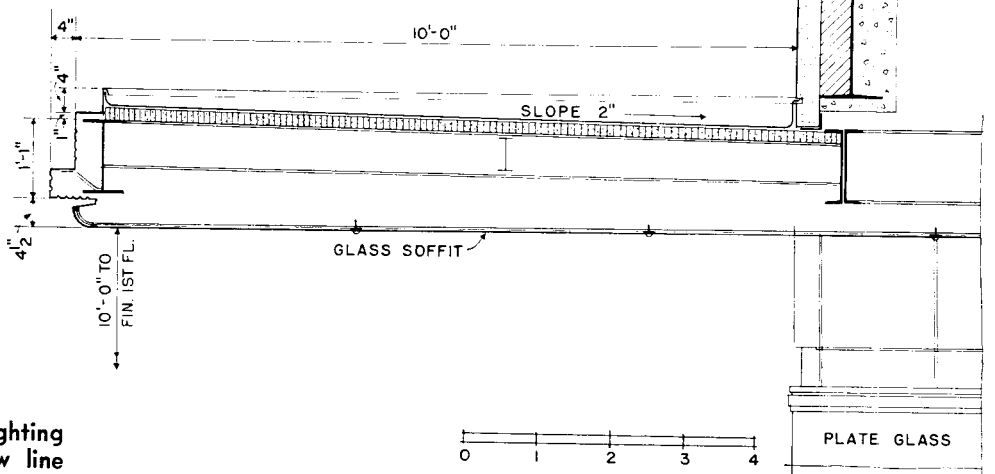

Detail of marquee

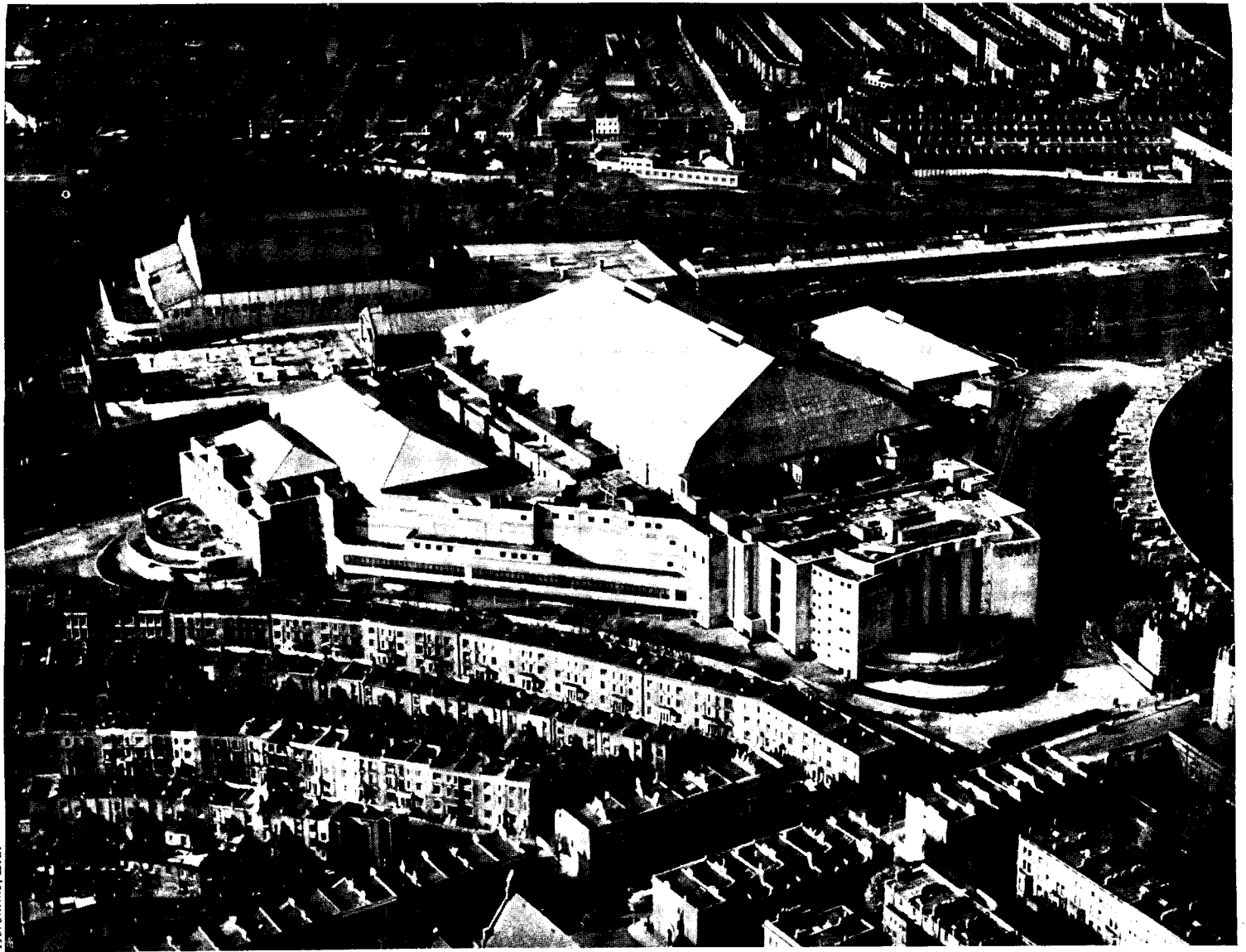

Aerofilms, Ltd.

## EARL'S COURT BOASTS "FLEXIBLE" POOL, MOBILE SEATING

C. HOWARD CRANE  
Architect

BUT FOR THE PERSUASIVE arguments of an American architect, the new Earl's Court exhibition building would have been a conventional exhibition hall. Convinced by C. Howard Crane, who practices in London as well as in Detroit, the developers decided to embody in the plan the latest types of mechanical equipment, including an automatic swimming pool. The new Earl's Court stands on a triangular site near the West London Extension Railway. Three independent exhibitions can be carried on simultaneously, each with its own entrance, restaurant and auxiliary services. In so large a building, problems of circulation, entrance and exit, and air conditioning are of considerable moment; but in this case planning was further complicated by existing railway tracks which could not be removed, and divided the property into two parts. In order to make the two parts function as one, the tracks were covered over and the reclaimed area used for parking. To allow for the tracks which passed through the building lot, the ground-floor level was raised 16 ft. above normal grade. Occupying 9 of the site's 18 acres, the building contains 47,000,000 cu. ft., and cost £1,500,000 (\$7,500,000).

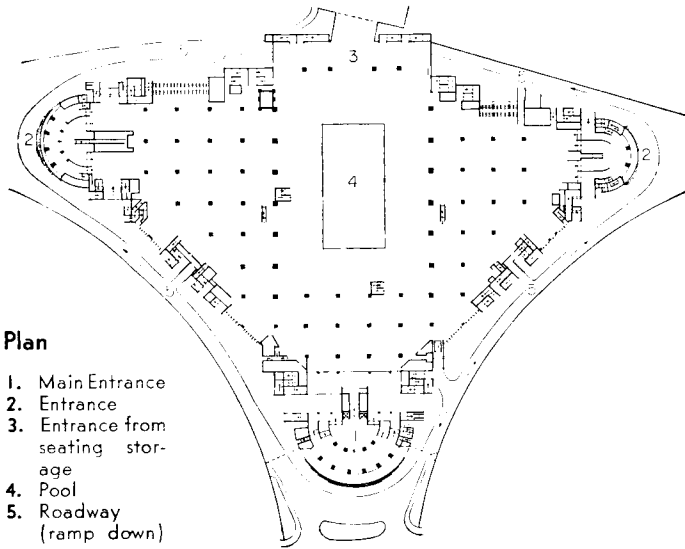

- Plan**
1. Main Entrance
  2. Entrance
  3. Entrance from seating storage
  4. Pool
  5. Roadway (ramp down)

## EARL'S COURT

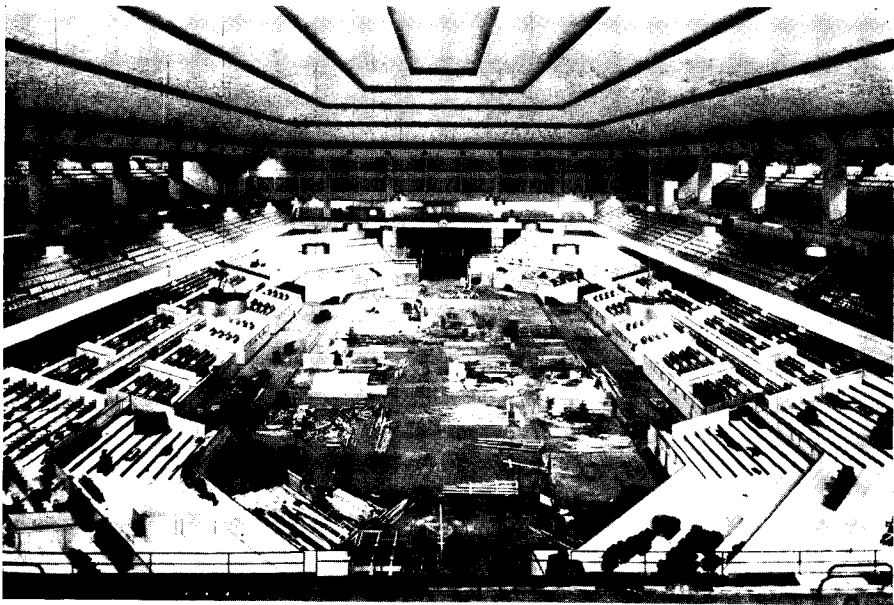
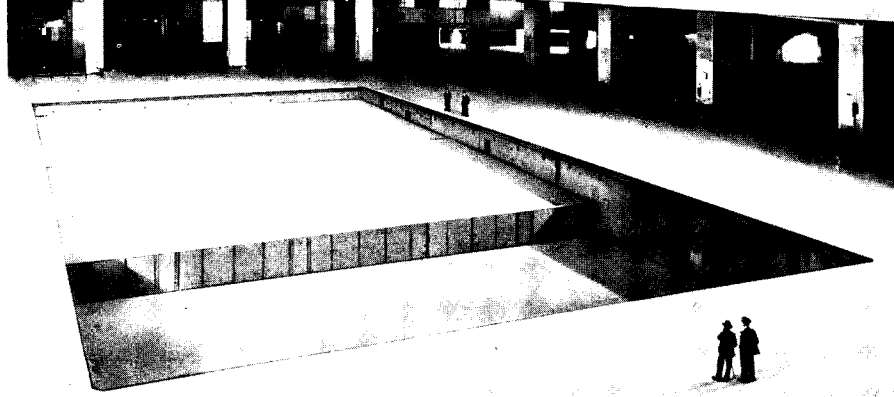
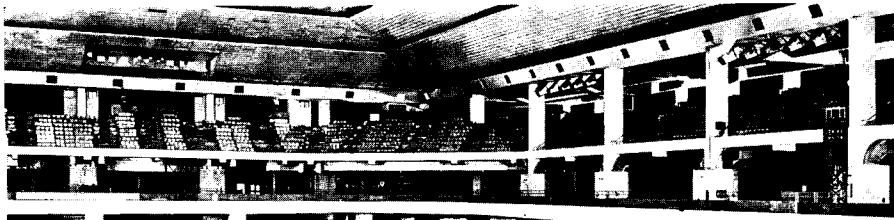

Although multiple use was a primary design factor, economy of time and labor in converting the Main Hall from one purpose to another was of considerable importance. The Main Hall can be changed into a natatorium with a pool, 195 x 95 x 20 ft., in an hour, and into a convention or exhibition hall in a day. The first of these quick changes is made possible by the use of a system of hydraulically operated rams which automatically raise or lower the central portion of the main-hall floor (see details on opposite page).

By means of towable sections of seating tiers, 25,000 extra seats can be provided in a day's time. When not in use, these seats are towed to a large building at the rear for storage. In the balconies are 5,000 permanent seats. Columns, spaced 50 ft. o.c., contain complete utility services for any type of display: electric power, refrigeration, compressed air, gas, hot and cold water, radio, sewage, etc.



For conventions or exhibitions the floor remains at its usual level; for sporting or other events the three sections can be manipulated to form terraces of different heights, or a sunken arena. Each of the four ceiling troughs contains a three-color lighting system; since no daylight reaches the exhibition hall, controlled lighting effects are possible. The expense of lighting and heating by electricity is in part offset, says the architect, by the fact that there is no glass roof to keep in repair.

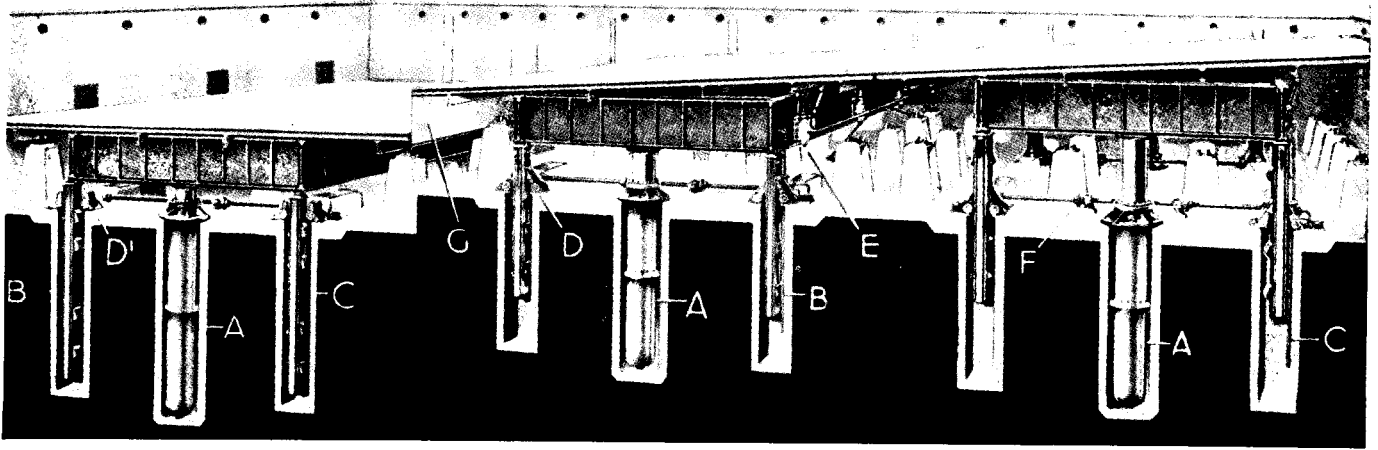

Diagrammatic section through pool

Advantages of the completely automatic pool more than make up for the cost, as a temporary floor would have required time and labor to install or remove, and would have involved provision of storage space. Platform sections are controlled independently by hydraulic rams, and are kept in set positions by the engaging of chocks with brackets on the sides of the stilts. The synchronizing shaft couples these stilts by means of pinions which fit into racks on the stilts. Platforms are tilted off the main girders by small rams and fixed in position by toggle bolts to form sloping pool floor. A special wax treatment on the rams eliminates necessity for grease and makes it possible for platform sections to rise or sink through water, so that the pool is normally not emptied.

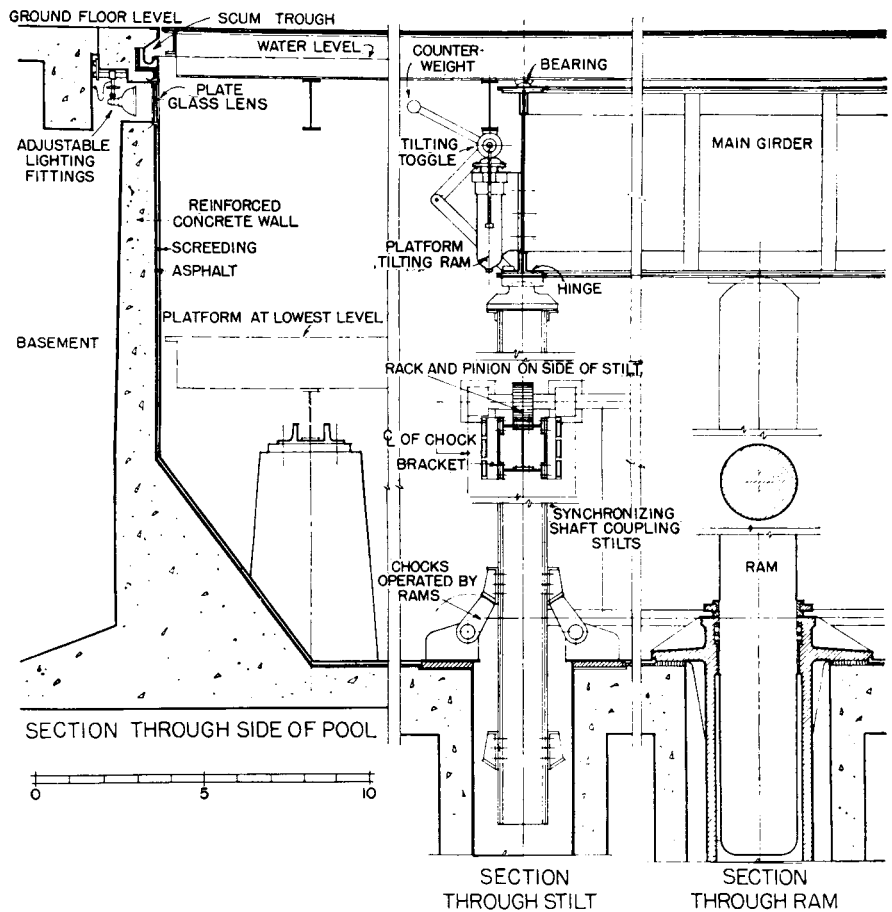

Details of pool courtesy "The Architect's Journal"

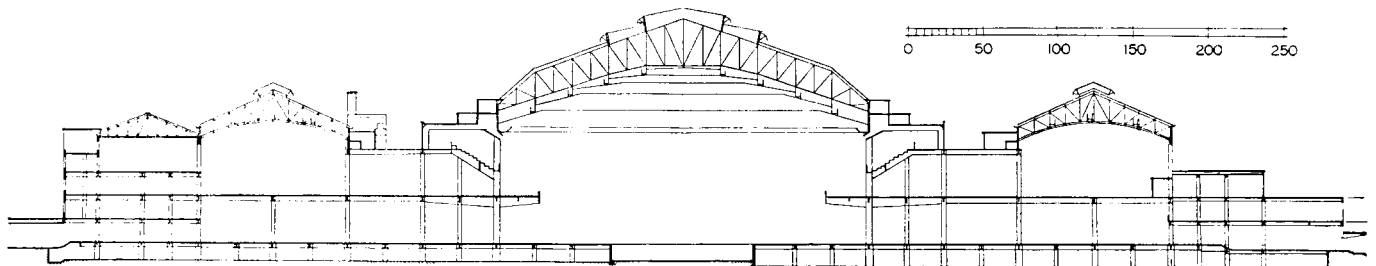

Section through building

# ALL COMMUNITY AGENCIES HOUSED IN HIBBING MEMORIAL

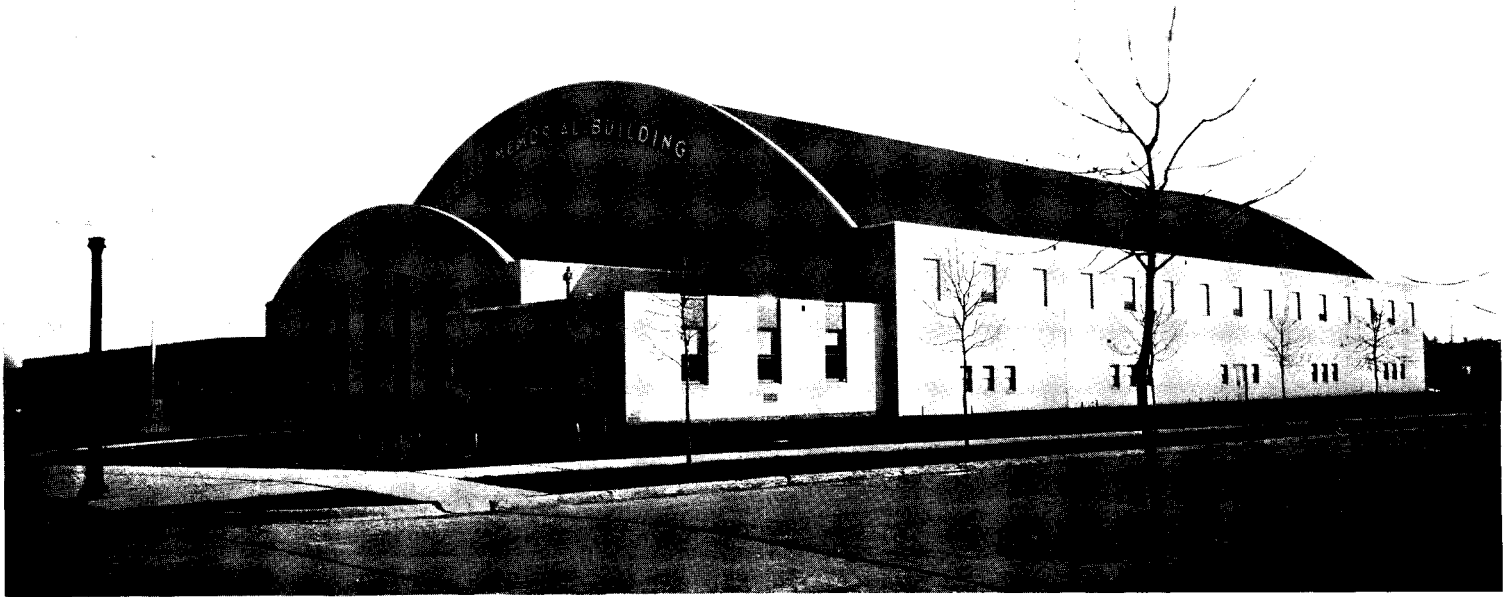

Elevation

ERICKSON & COMPANY

Architects

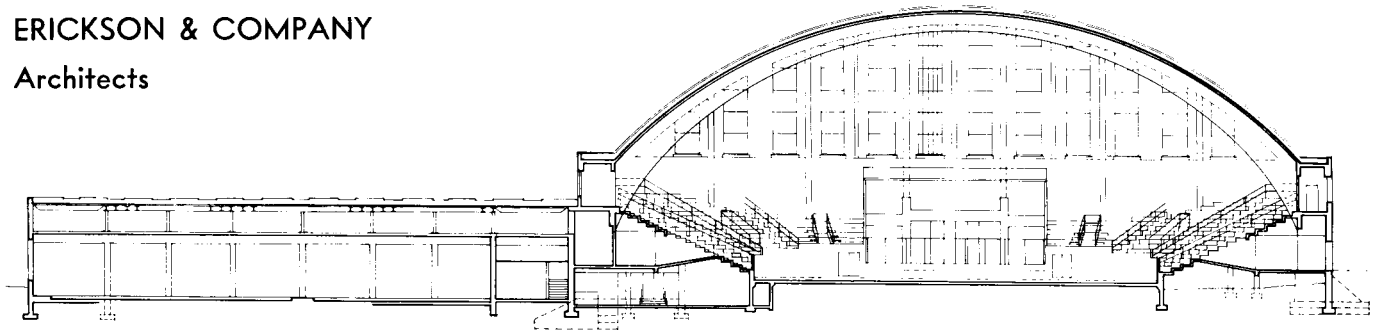

Section

DEVELOPED as a community center for the 15,000 residents of Hibbing, Minnesota, the Hibbing Memorial Building also caters to the 75,000 people in the surrounding country, and provides recreation facilities of all types and headquarters for various organizations. Not the least interesting feature is the roof system, based on the fact that a thin, curved concrete shell can be given load-bearing capacity by providing it with concrete stiffening ribs, monolithically cast with the shell, to which roof loads are transferred by tangential shear. By substituting a structural steel frame which conformed with the concrete plans, the architects obtained a substantial reduction in cost. The arena can be used for ice skating (refrigerating equipment has capacity for making ice in 8 hours, melting it in 4), dancing, public meetings, indoor circuses and sporting events. Maximum seating capacity is 8,000. Building contains 4,000,000 cu. ft., cost \$440,000.

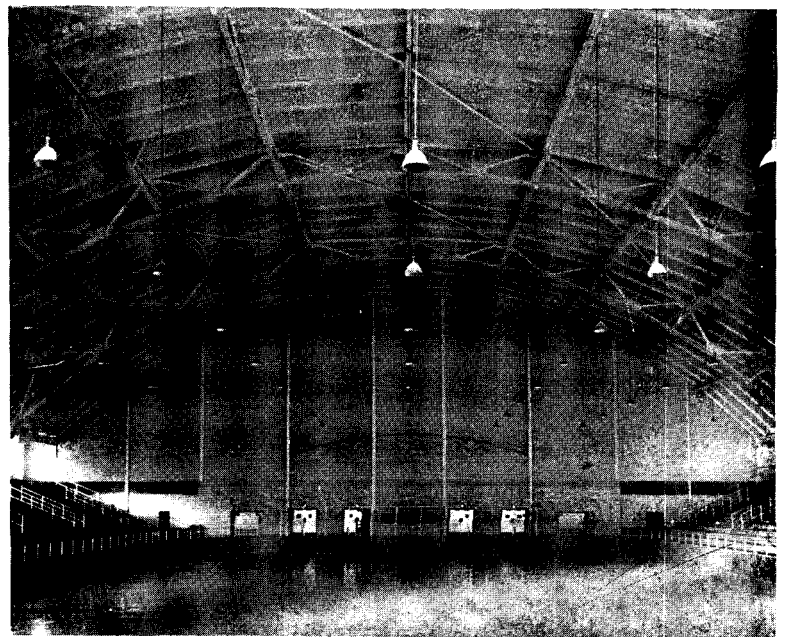

View of Rink looking toward stage end

**First Floor:**

- 1. Memorial Hall
- 2. Lobby
- 3. Checkroom
- 4. Men
- 5. Ventilation Ducts
- 6. Storage
- 7. Women
- 8. Stage
- 9. Band Rehearsal Room
- 10. Boy Scouts' Room
- 11. Meeting Hall
- 12. Clubroom
- 13. Office

The plan was evolved from suggestions received in answer to a questionnaire sent to civic organizations and the residents of the town. At the left of the entrance are quarters for soldiers' organizations; on the right is a meeting hall for organized labor groups. At the rear are clubrooms, offices and band rehearsal room for Boy Scouts.

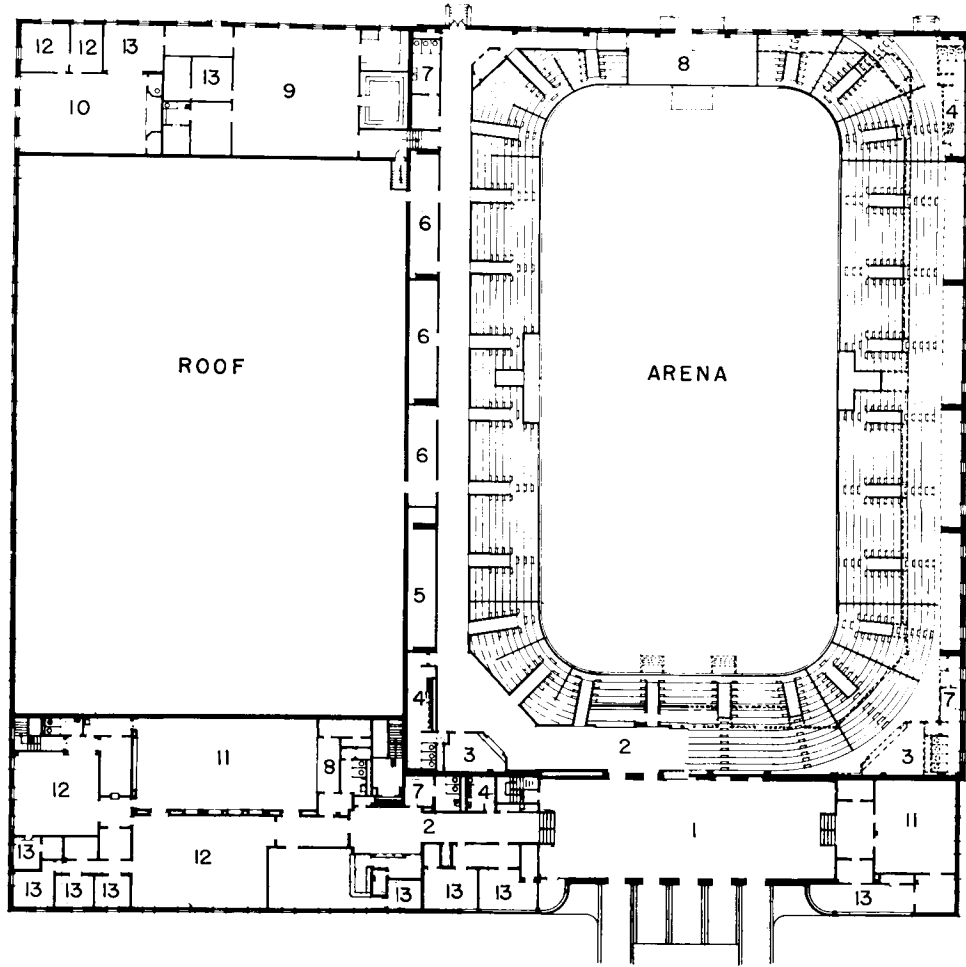

**Ground Floor:**

- 1. Bowling Alleys
- 2. Gallery
- 3. Little Theater
- 4. Committee Room
- 5. Clubroom
- 6. Dining Room
- 7. Kitchen
- 8. Stane Lockers
- 9. Corridor, Gallery Over
- 10. Curling Rinks
- 11. Team Room
- 12. Curlers' Lockers
- 13. Refrigeration Machinery
- 14. Machine Room
- 15. Fan Room
- 16. Workroom
- 17. Storage
- 18. Snow Removal

Open to the public are the various facilities on the ground floor: bowling alleys, curling rinks and Little Theater. Provision is also made for equipment storage, machinery, and disposal of the snow which accumulates when the rink is used for ice skating.

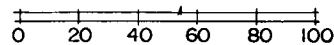
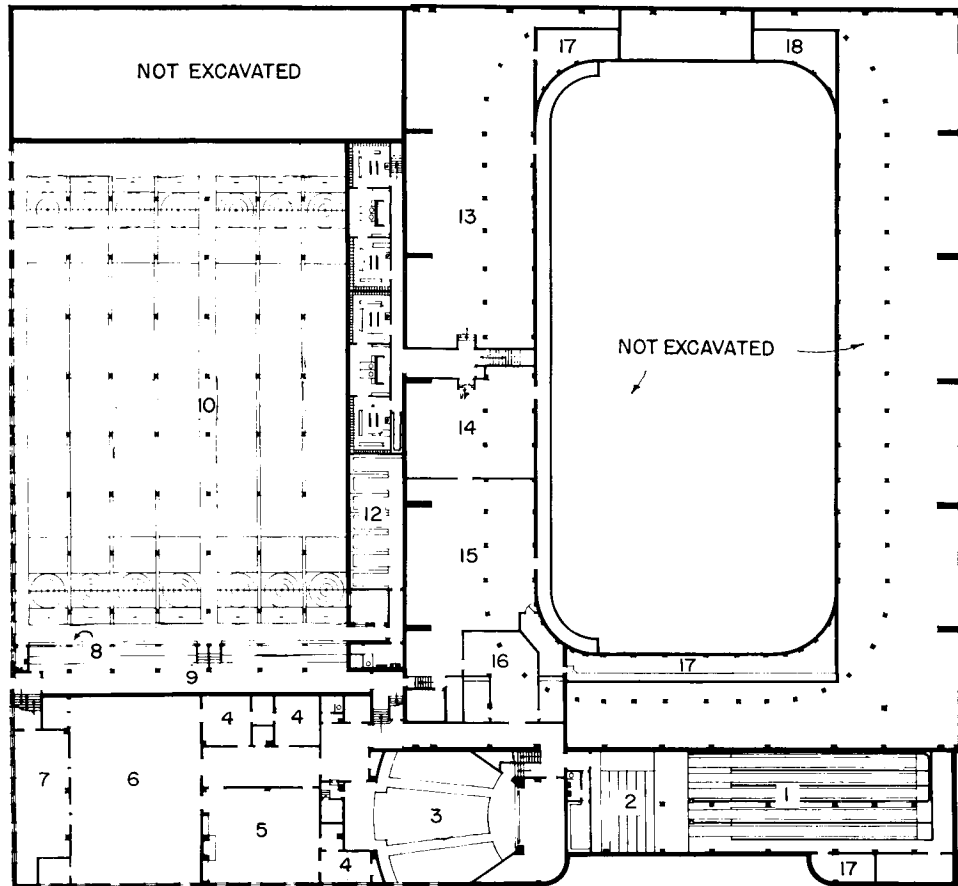



## HIBBING AUDITORIUM

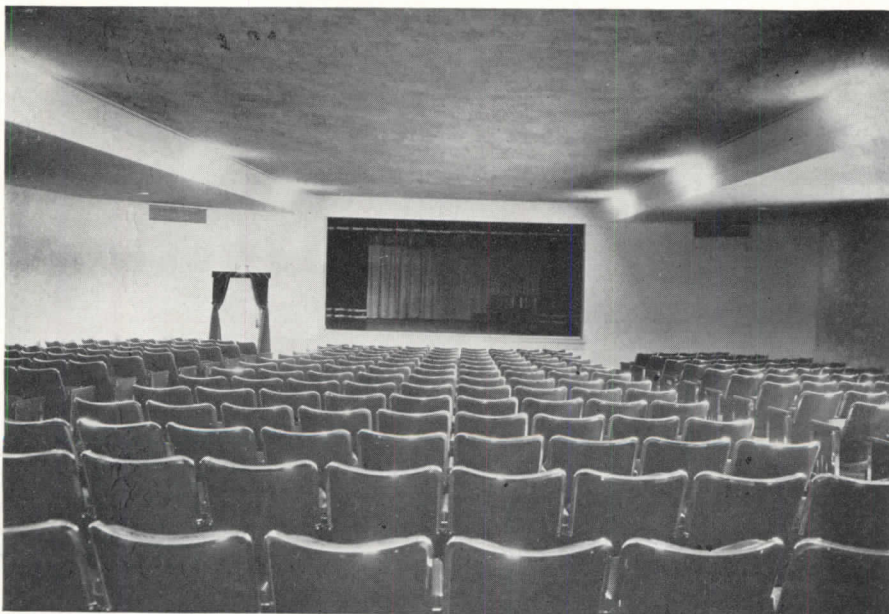

Principal entrance to the building is through this one-story vestibule (top), whose curved ceiling follows the shape of the roof. Ceiling and walls are of ornamental plaster painted in iridescent green. Shadow molds are silver. By an ingenious use of sandblasted sheets of crystal and colored glass on the inner pane of the large windows, the transmitted light varies in color and intensity during the day. At night, concealed lighting units above the doors produce a brilliant amber light. At the far end of the hall are stairs leading to the Veterans' clubroom (center). The Little Theater (bottom), seating 400, is situated on the ground floor.



Carl F. Waite



## CLEVELAND ARENA HAS LARGE ICE RINK, MULTICOLORED SEATS

WARNER & MITCHELL

Architects

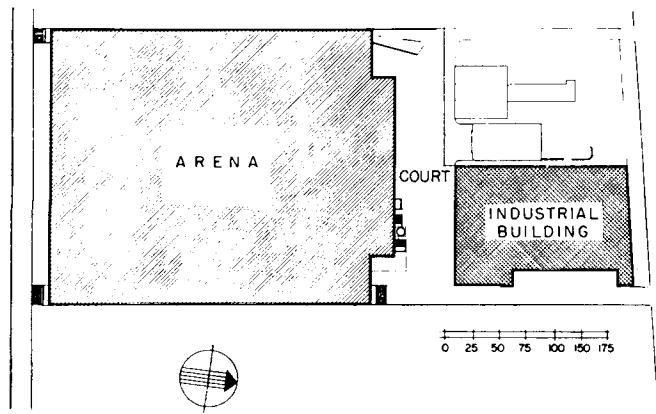

Plot Plan

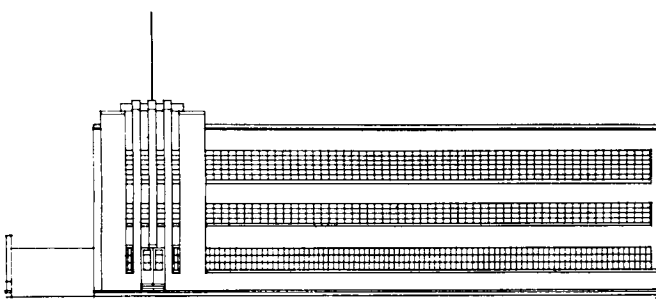

North Elevation of Industrial Building

CLEVELAND'S RECENTLY opened sports arena is actually a stadium under roof with a maximum seating capacity of 12,500 around an 84 x 194 ft. arena, which can easily be converted into one of this country's largest ice rinks. Spectators' comfort in mind, the architects designed the arena so that the top seat benches, 32 ft. 6 in. above grade, require a minimum of climbing. In order to do this and still obtain the necessary number of seats, the rink proper was sunk 11 ft. below grade. Novel feature of this seating is its color; divided horizontally into three classifications, identification is made simple by checking seat color with ticket color. For proper acoustics the walls are lined with Haydite blocks, and a 2-in. wood plank deck was installed to carry the roofing. Lighting equipment, including floods, spots and prize-ring fixtures, is arranged on catwalks above the rink. Location of lobbies on the main axis of the rink permits ease of circulation, and provides ample space for concession stands and displays. Included in the plan are several stores, a cafe and five bars. The building contains 4,833,000 cu. ft., and cost \$884,000. Part of the same project, but separated by a court, is an industrial building leased to several concerns.



Carl F. Waite

Detail of Entrance

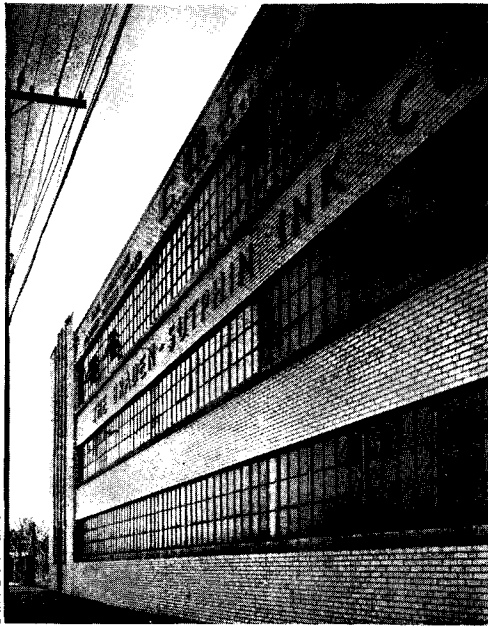

Carl F. Waite

Side Elevation of Industrial Building

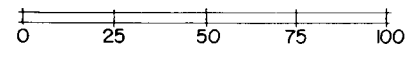
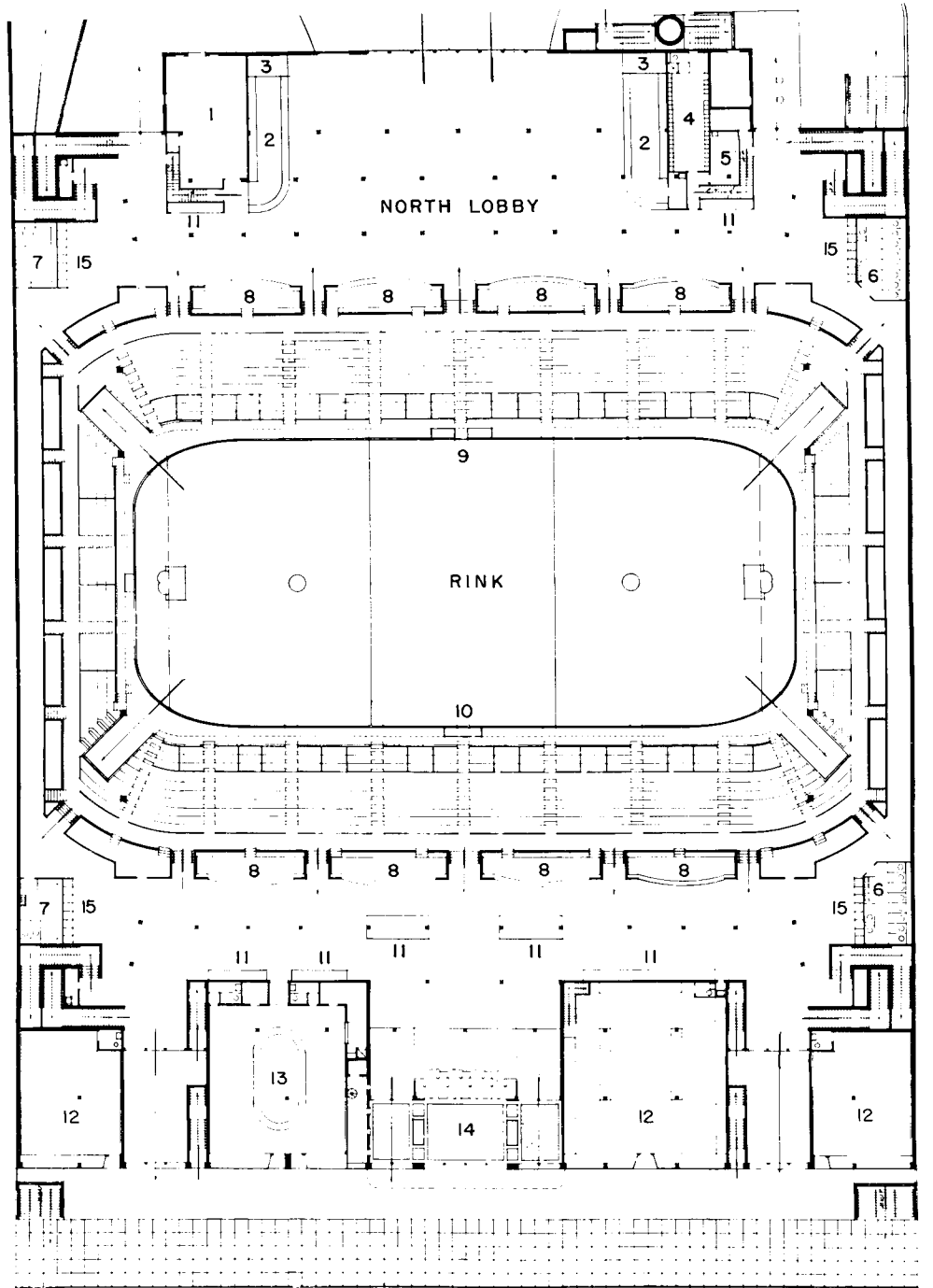

- |               |                   |                  |
|---------------|-------------------|------------------|
| 1. Commissary | 6. Women          | 11. Display      |
| 2. Bar        | 7. Men            | 12. Store        |
| 3. Cooler     | 8. Concessions    | 13. Cafe         |
| 4. Team Room  | 9. Players' Boxes | 14. Ticket Lobby |
| 5. Coach      | 10. Penalty Box   | 15. Telephones   |

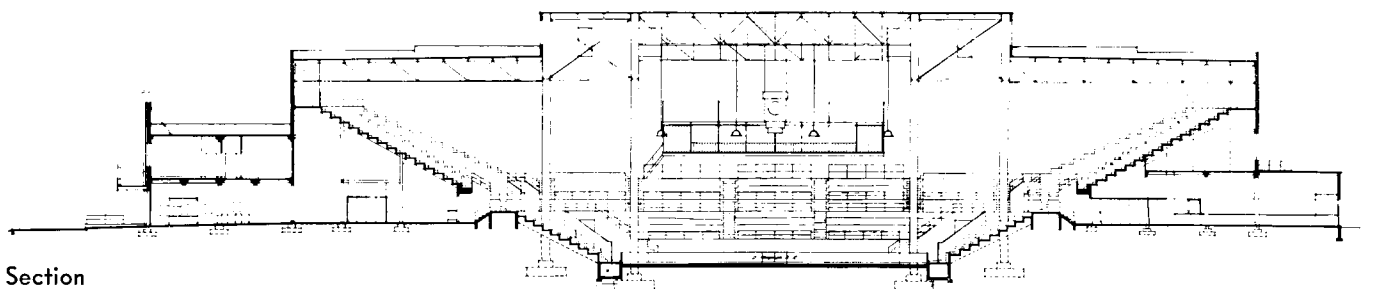

Section

# CLEVELAND ARENA



Herbert Reisman

Laying the arena floor was a complicated process not only because it involved installation of 9.7 miles of refrigerating pipe, but also because the conditions the floor has to meet made imperative a permanent bond between terrazzo finish and concrete base. The latter requirement called for uninterrupted work; in 30 hours the floor, except the finished surface, was complete. Shown above are various stages in the floor's construction: concrete base, rock-cork insulation covered with zinc, and refrigerating pipes. In the center is a close-up of pipes with runways for use during concrete pouring. Below is the rink, which seats 9,700 and provides an unobstructed view of the floor.

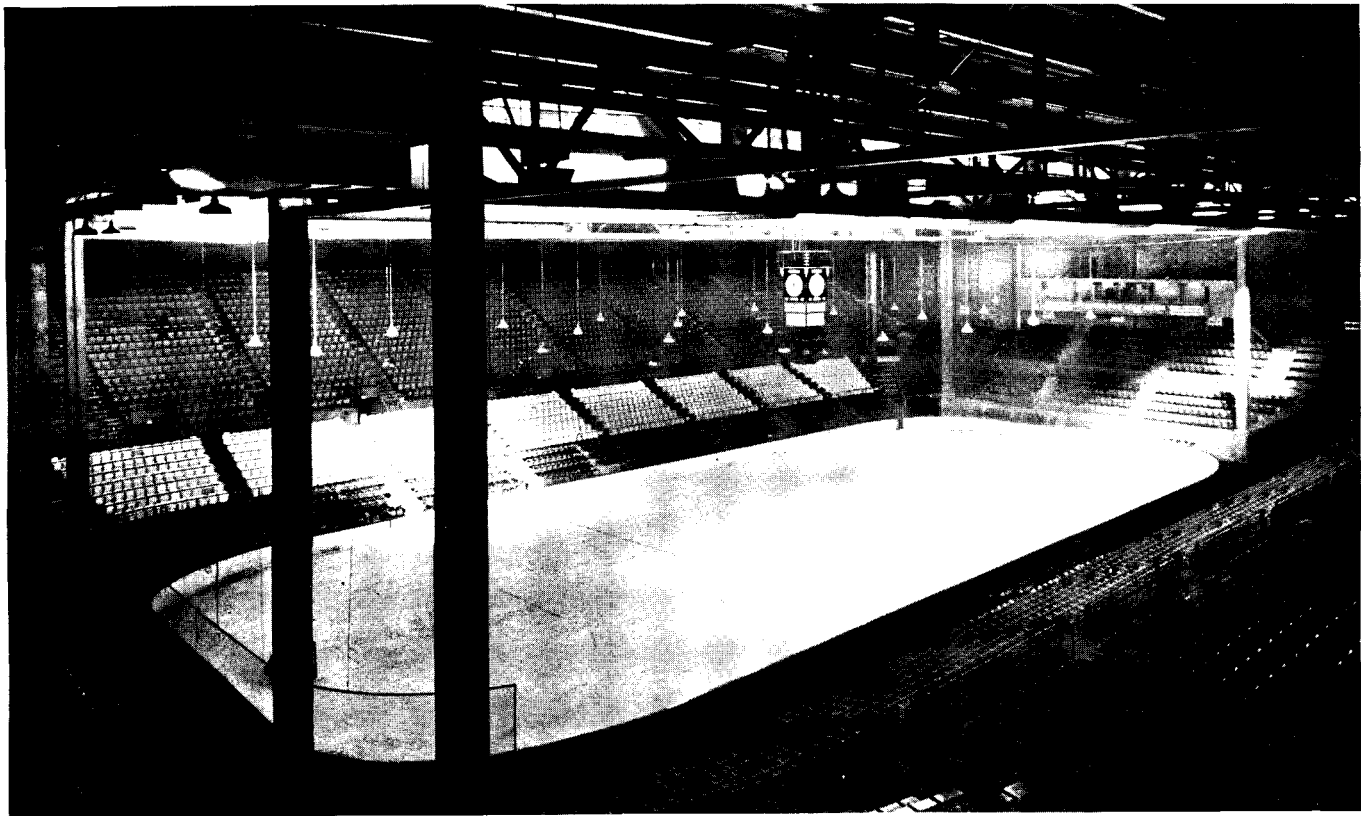
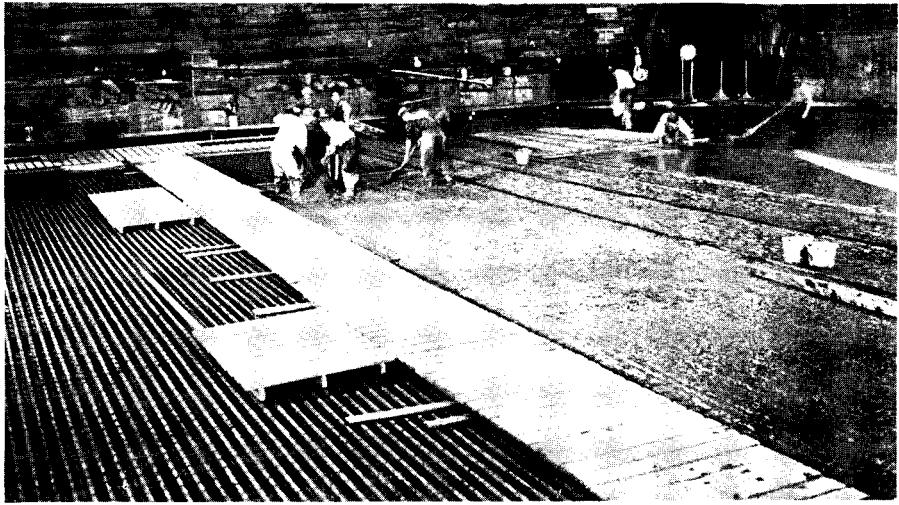

Carl F. Waite



**FENCE PROVIDES OBSERVATION GALLERY FOR SPECTATORS**

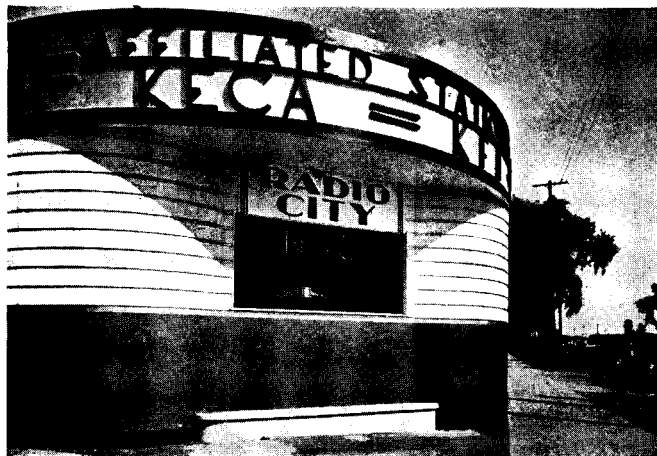

The fence completely surrounds construction work . . .

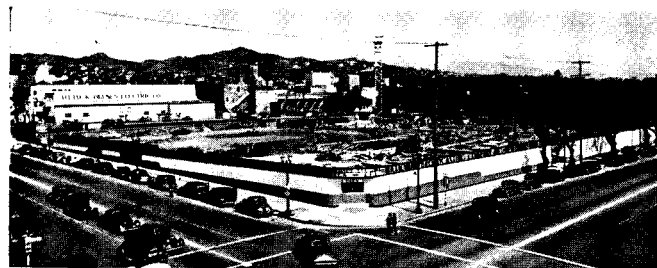

and acts as a testing ground for colors to be used on the future building (see model).

**THE AUSTIN COMPANY**  
Designers and Builders

FOR THE FIRST time provision has been made for the crowds of knothole peekers—usual adjuncts to any construction job—by the erection of this fence around the 5-acre site of the new studios for the National Broadcasting Company in Hollywood, Calif. Cannily the builders have turned the observation gallery into an advertisement for their company and for NBC. Actually a new idea in the construction industry, the fence also serves as a guard against dust. The rounded corners and setbacks at observation platforms simulate the line of the future three-story studio building. The present color scheme of the fence is light brown with light-green striped bands, and a fascia of white on which identifying signs are painted in black.

# PLANNING DETAILS

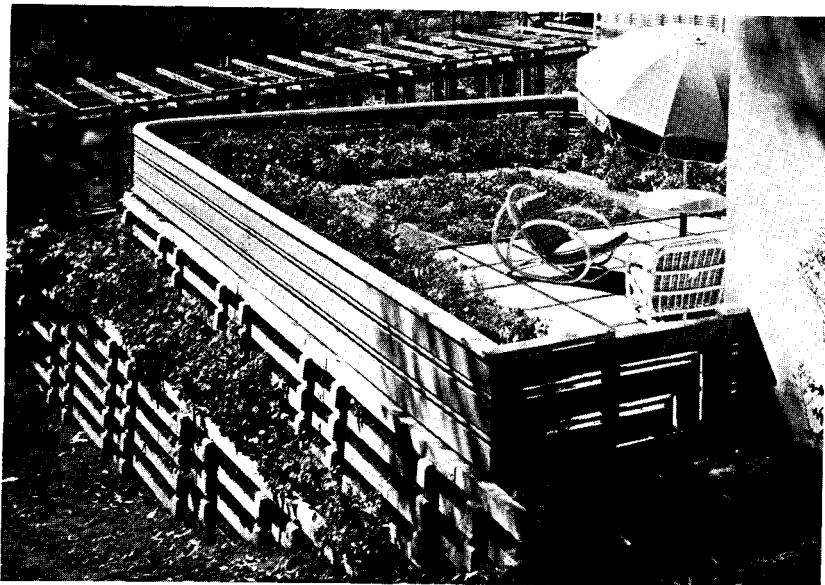

Perspective view of elevated patio and cribbing log retaining wall

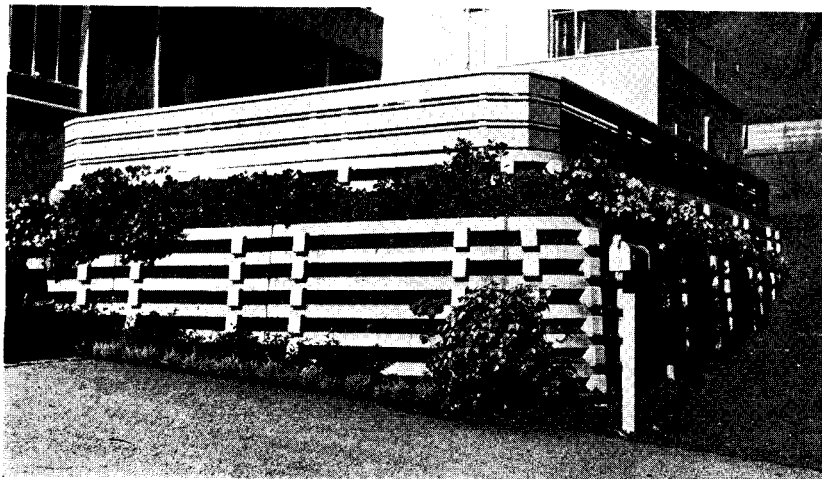

In the exposed soil between logs flowers can be grown.

## Architect Adapts Engineers' Cribbing to Garden Walls

MICHAEL GOODMAN

Architect

CRIBWORK—GENERALLY used to hold railroad embankments in place—was ingeniously applied by this California architect to a garden retaining wall. Instead of creosoted wood logs, however, Mr. Goodman used precast concrete logs, spaced 5 in. apart, with 4-ft. headers or false heads between rows of logs. Initial use of the system was beset with difficulties; the first wall collapsed. By studying soil conditions, and lightening both reinforcing and log sections, a successful solution was finally attained. On this page and the next are shown photographs and details of two adaptations of cribbing to garden use.

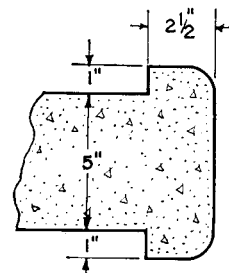

Detail of header or block

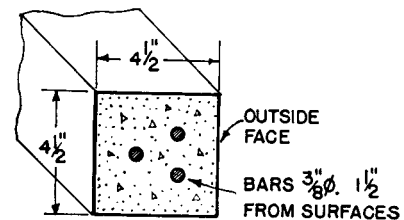

Section through log

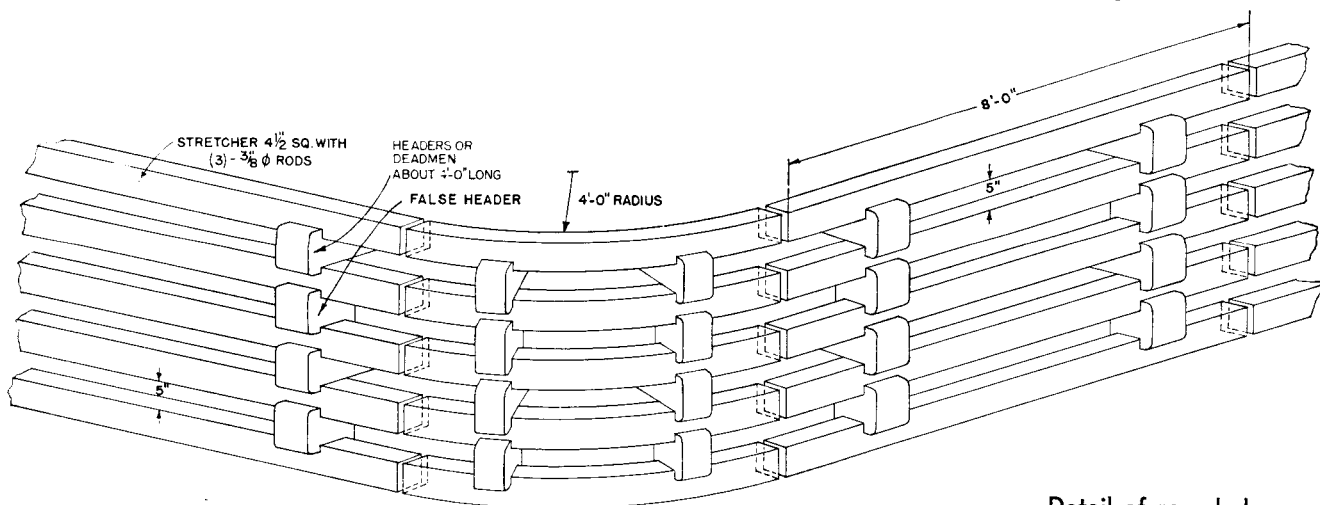

Detail of rounded corner

# PLANNING DETAILS

## Cribbing System



Circular flower boxes, similar in construction and purpose to the retaining wall, are arranged at entrance steps in receding tiers. Below are details of the construction.

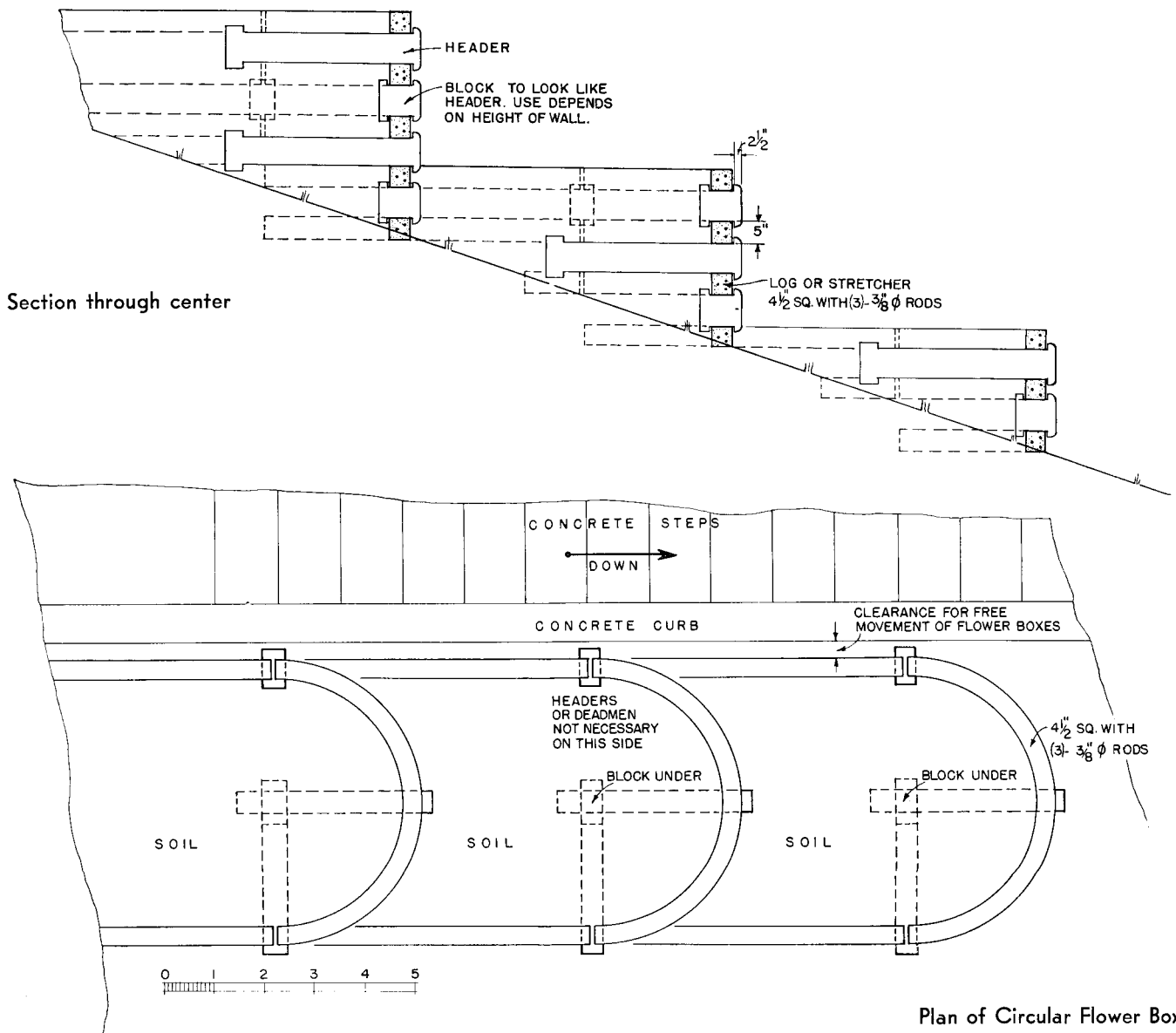

## UNDER CONSTRUCTION

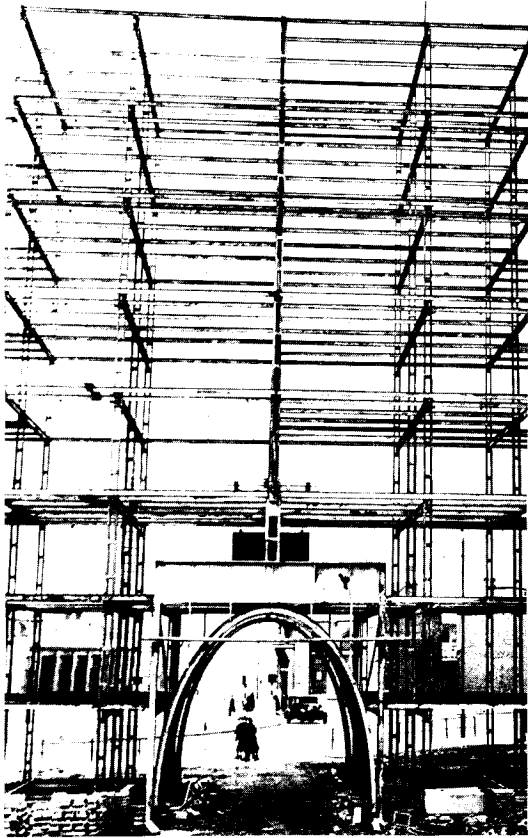

Stage 1: Steel framework



Stage 2: Concrete slabs in place

### New English Flats Based on Novel Construction Design

ONE THOUSAND municipal flats designed for England's working class, are now under construction at Quarry Hill, Leeds. Construction photographs show the novel use of a light steel framework which acts at once as scaffolding during construction and as reinforcing for the concrete columns, so that the building is entirely fireproof. Concrete wall units are precast with grooves on the inside surface which fit onto projecting flanges of columns.

Modern even to acoustical treatment on walls, the flats are to be equipped with a refuse disposal system, and foolproof self-service elevators. In conjunction with the development will be a shopping center, nursery school, central laundry and telegraph station.



Stage 3: Finishing the exterior

Photos by Grieb

## PROPOSED BUILDINGS

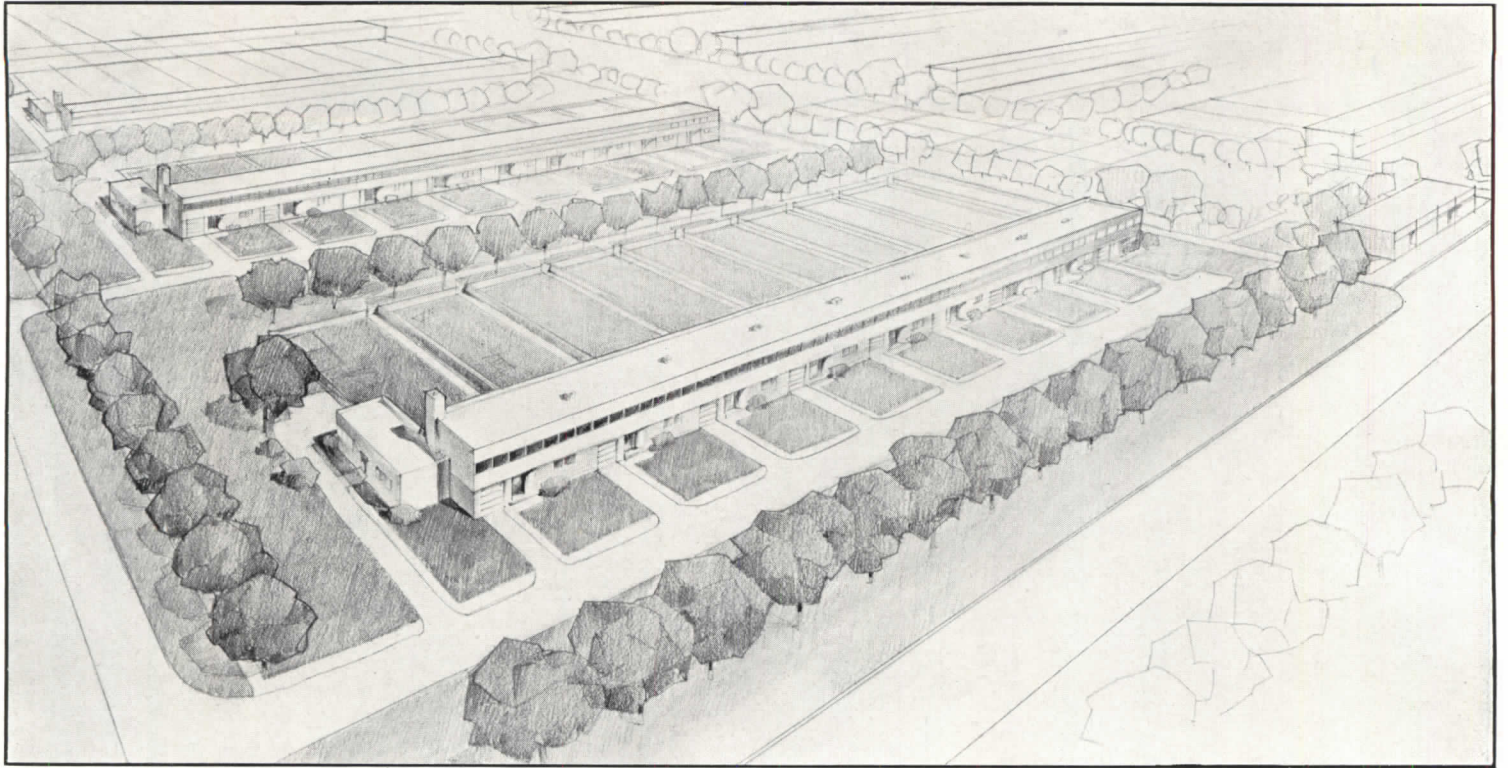

Bird's-eye View of Development

## Detroit Automobile Workers Project Cooperative Housing Development

LYNDON & SMITH  
Architects

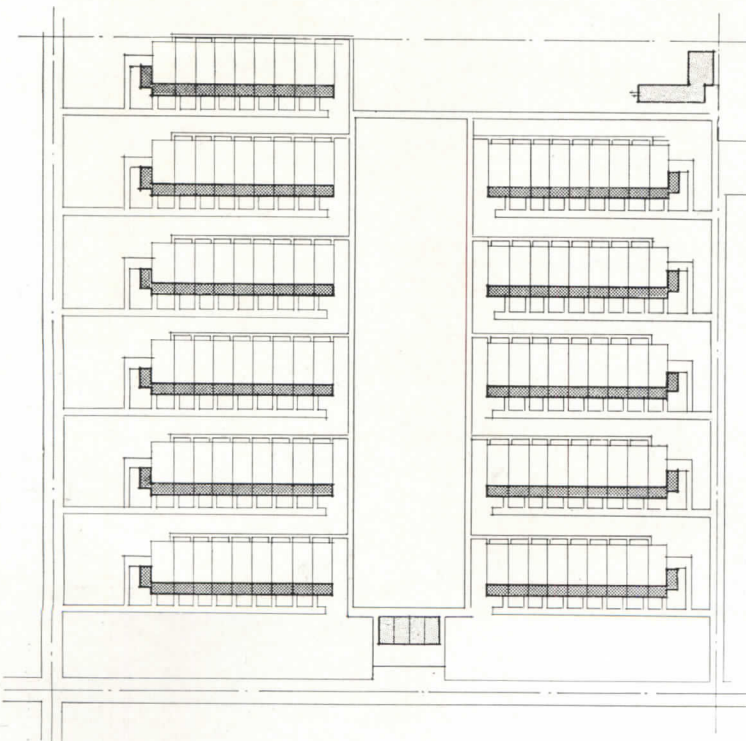

Plot Plan

TO MEET THE NEED for housing among its members, the United Automobile Workers of America proposed this development of 110 dwellings and engaged the Detroit firm of Lyndon & Smith to design it for them. Although planned primarily for Detroit, the development can be modified to suit the needs of similar groups elsewhere. Certain definite requirements, however, are general: besides being economical and fireproof, the housing must provide some kind of enclosure for an automobile as well as adequate quarters for an average family and yard space for each unit. Economy dictates cheap land and row housing; incombustibility demands concrete construction. In this particular case, concrete framing has an exterior facing of brick and an interior finish of stucco.

To give direct access to the private ground area the units are spread out in the long dimension. Each unit, representing a single family dwelling, is 40 ft. long by 22.5 ft. deep; by attaching these units end to end in groups of 10, the designers achieved broad-front planning and provided a large private yard. This arrangement also permits access by automobile



The typical unit acknowledges specific requirements:

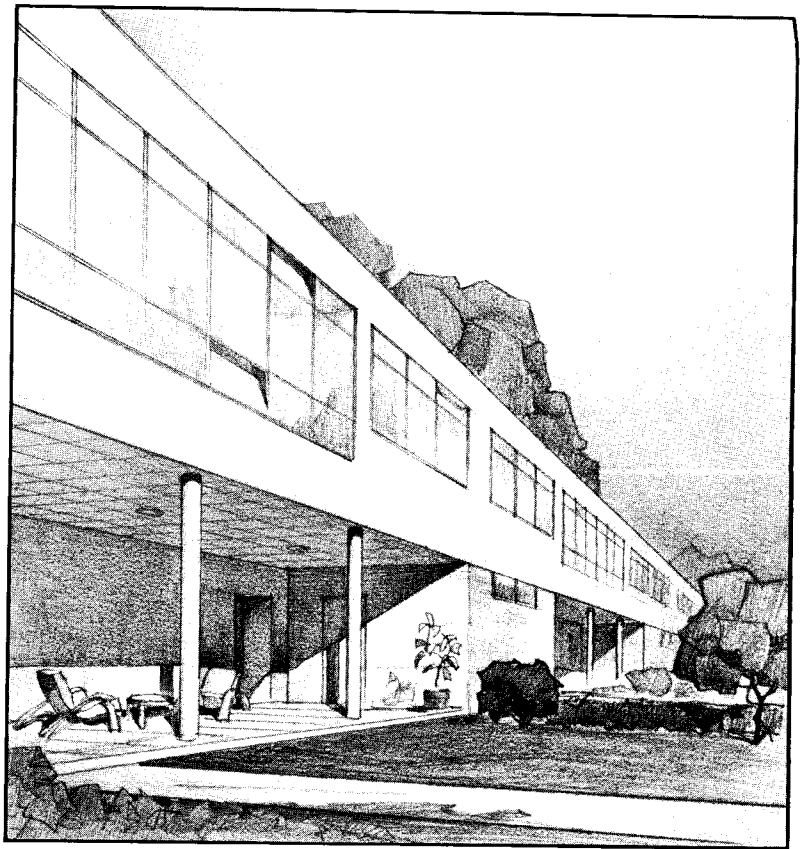
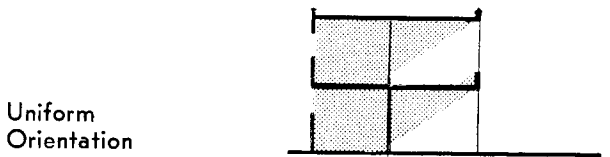
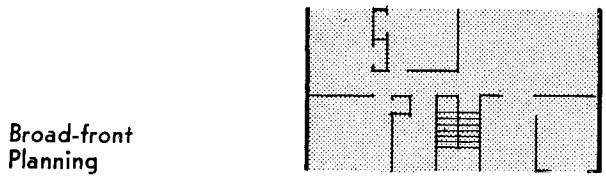
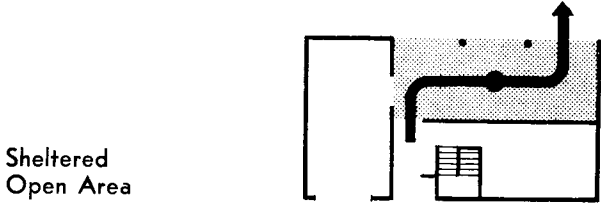
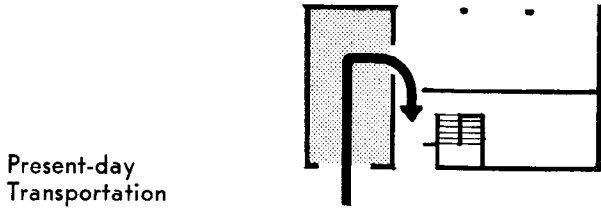

Detail of Rear Elevation

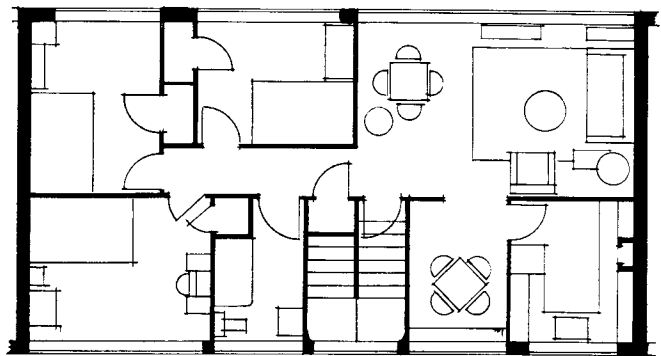

Upper Floor

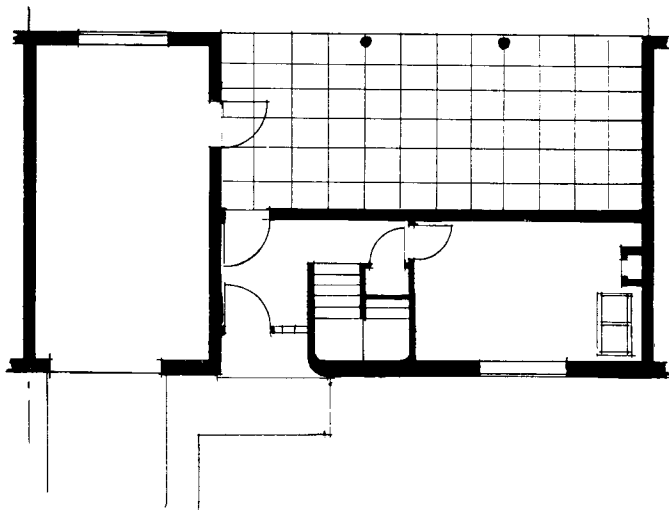

Ground Floor

to each unit from the highway, and to shops (lower center, plot plan), playgrounds (center) and school (upper right) without crossing minor driveways.

To fill all the requirements of the average family it was found that a two-story unit was needed. The ground floor is developed for utilitarian purposes: here are garage, with ample space for a car and storage, laundry and utility room, and entrance hall. The covered terrace leads to the rear garden. All sleeping and living quarters are arranged on the second floor. Location of stairway landing at the center of the upper floor provides direct access to kitchen and living areas and forestalls traffic through the living room. The broadside location of the living room permits window openings the full length of the room.

The estimated total cost of the project is \$648,000, or \$5,891 for each of the 110 units. This figure includes the cost of the 40 acres of land required for the project. The financial basis of the project is that each family will buy its own unit on a 20-year amortization plan, with a down payment of \$200. Monthly rental would be \$28.50, including an average 2% interest payment of \$4.75.

## NEW EQUIPMENT

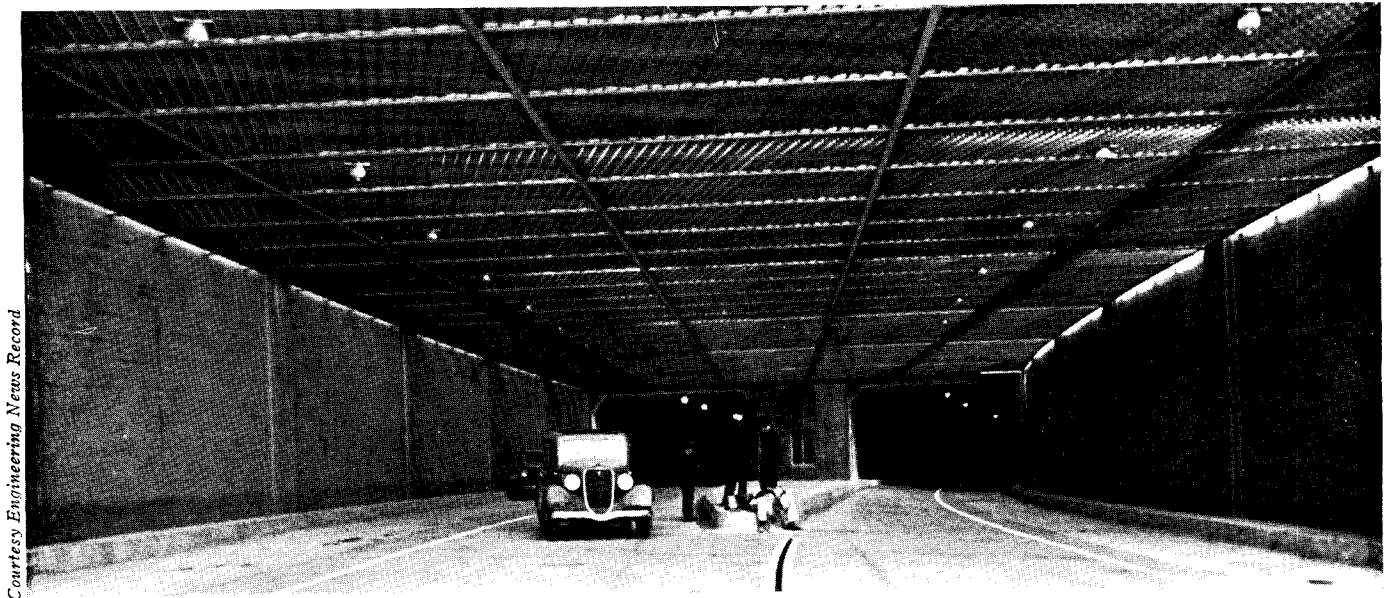

Courtesy Engineering News Record

### Mathematically angled louvers provide light gradation in California tunnel

FOR THE DESIGNER of buildings in which the problem of transition from high to low intensity of light is a major consideration, the louvered canopy designed by Romaine Myers, consulting electrical and mechanical engineer, offers a practical solution. Actually in use in the approach cuts to the vehicular tunnel between Oakland, California and Contra Costa County, the canopy or "transition tunnel" provides a graded variation of light intensity from broad day-

light to the 4 footcandles of artificial light in the tunnel. In the Oakland tunnel, this canopy extends 200 ft. beyond the portal, and is fabricated of sheet aluminum, mat-finished, in small honeycombed vanes. By astronomical calculations, the vanes are so positioned in angle, both to the perpendicular and to the latitude and longitude of the site, that direct sunlight never reaches the roadway. Change in intensity is so gradual that momentary blindness is eliminated.

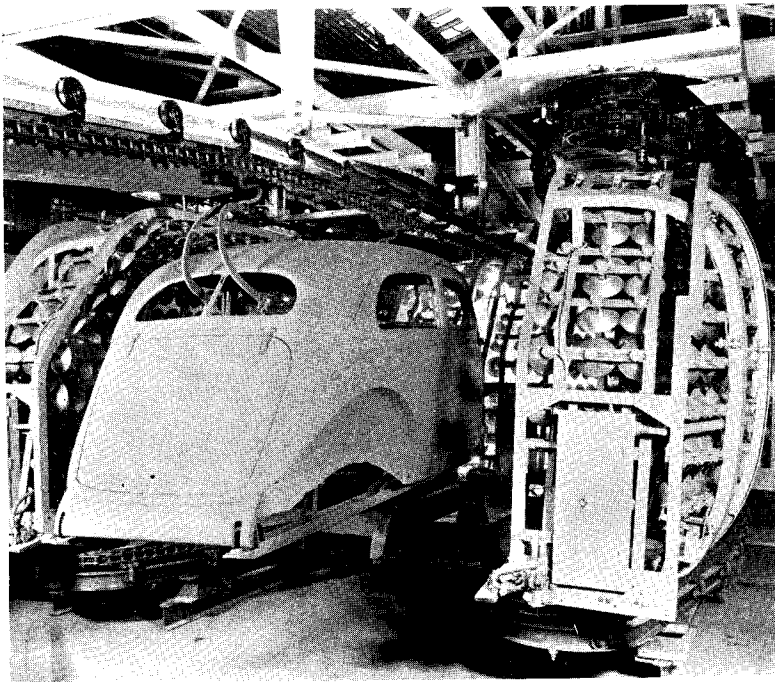

### Infrared heat lamps used for quick drying

APPLICABLE in the building industry wherever quick drying of surfaces is necessary, is the process of enamel baking used in the Ford Motor Company's Dearborn plant. To speed up production, the company installed large frames or "clamshells", studded with heat-emitting infrared lamps similar to those used in therapeutic treatments. (Infrared

lamps give off invisible and nonactinic rays which are detectable by their thermal effect.) These clamshells open to admit the car, then fold themselves around the body. When the heat lamps are turned on, the body and its enfolding shell move slowly down the baking line on conveyors, a much faster process than with conventional baking ovens.

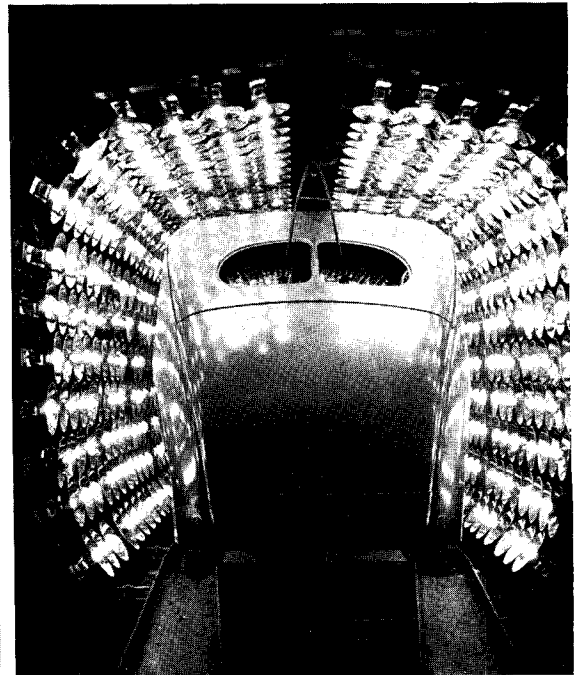

### Device stops under-door drafts

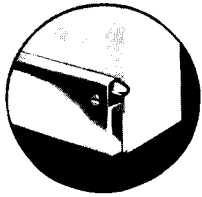

AN INEXPENSIVE automatic air-seal device, the Sentry Stop-a-Draft for use on exterior and interior doors, is designed to stop under-door drafts.

Stop-a-Draft, manufactured by Ray-steel Specialties, Inc., Cleveland, Ohio, is made of metal and fabricated material and comes in a variety of finishes. When the trip lever (inset) is engaged, a concealed air-seal strip is automatically lowered to floor level, shutting off under-door drafts. When the door is opened, the trip lever is disengaged, and the air-seal strip returns to its metal sheath so that it does not rub against the floor. The device is available in special sizes and a number of stock sizes from 30 to 36 in. wide, at prices ranging from \$1.25 to \$1.45 for standard models and from \$2 to \$2.40 for de luxe models.

### Suction motor destroys odors

ATTACHABLE to any toilet, the Air-Vac is a device for cleansing air before it escapes into the bathroom or adjoining rooms. The product is manufactured by the Scott Pump Co., 645-653 Atlantic Ave., Rochester, N. Y. Pressure on the seat at contact buttons (1) engages the switch and starts the suction motor (2); fumes enter the slot above the toilet bowl and are carried along the pipe to the suction motor where they are destroyed by mechanical action. After fumes have passed through blower at (2) they are ejected through a 2-in. opening in wall or partition. In the case of outside walls, a  $\frac{5}{8}$ -in. fresh-air inlet is made in the outer wall opposite the 2-in. opening. Installation consists of removing the two bolts which hold the seat assembly in place and fitting the Air-Vac plate over these bolts. As all joints and connections are of the "slip-fit" type, there is no necessity for cutting or fitting of pipe. Air-Vac can easily be removed for transfer

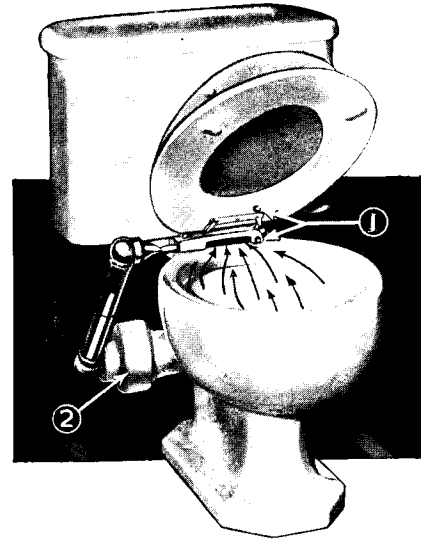

to another location. Although list price of the device is \$25, a dealer's flat price of \$10 is offered to introduce the product.

## NEW STRUCTURAL SYSTEMS

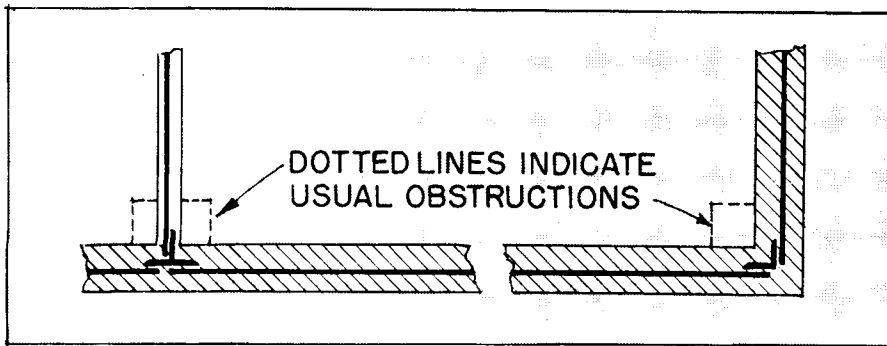

H-columns split in two provide "T and L" columns

### "T & L" column system eliminates waste space at room corners

FOR GREATER flexibility in planning than is possible with H-column construction, a structural design using T- and L-shaped columns has been invented by M. N. C. Weinberger, New York structural engineer. This invention is especially applicable in such buildings as are subdivided by a multiplicity of permanent partitions, as it eliminates the obstructions at corners caused by use of H-columns. Since the T-shaped column is obtained by longitudinally splitting the web of an H-column, the

two resulting T's have parallel surfaces in both web and flange. This permits direct attachment of framing to web of flange, and reduces eccentricities in such columns to a minimum. Framing of this type is particularly well suited to field welding, claims its inventor. Since T- and L-columns can be completely buried in the intermediate fireproof partitions which subdivide the structure as well as the exterior walls, practically no additional fireproofing of such columns is necessary.

### Highway pavement offers solution to concrete-settling problem

IN THE DESIGN of buildings where concrete floors are laid on marshy ground, the problem of keeping the paving to true grade is of concern to architects and engineers. A recently built concrete highway near Pascagoula, Miss., offers a solution to the problem, in that it is so designed that pavement can be leveled as the fill sinks rather than after the subgrade has settled. If settling should occur, each slab can be lifted back into position with relative ease and at considerably less than the usual cost, because mud-jack holes are built into each slab. This was done by setting metal cans of proper height and diameter on the subgrade as molds for the mud-jack holes. The cans were filled with sand to exclude concrete in the pouring, and were held in position by pins. For greater strength at outside of the road, the outer edges of each slab were designed as beams; the thickness increases from 9 in. at transverse joints to 12 in. at the middle. Along center joint the edge is thickened to 9 in. Reinforcing in each slab consists of two bars at bottom of outer edges, and one in each of the beams along center joint.

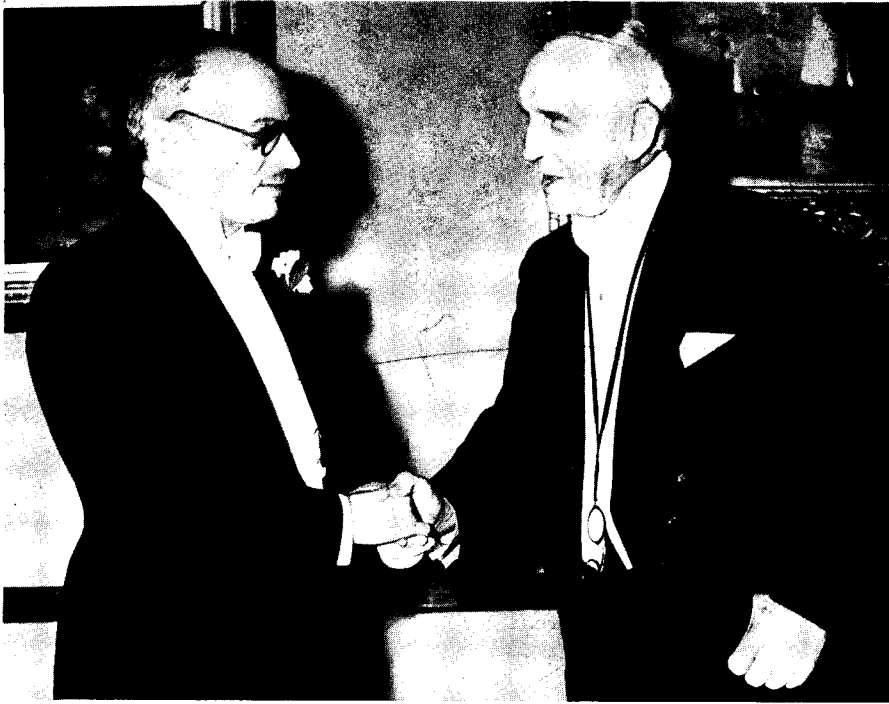

Paul Cret (left) accepts AIA's highest from President Maginnis (right).



Producers' Council lunches with AIA: (left to right) E. O. Shreve, J. G. McNary, Council President, Russel Creviston and President Maginnis

**AIA's Seventieth Anniversary Celebrated in Creole City**

ASSEMBLING IN NEW ORLEANS' rococo Hotel Roosevelt on the morning of April 19th, the seventieth annual convention of the American Institute of Architects got under way with 675 delegates, members and guests—largest turnout in recent years. Although only the nucleus of a whole orbit of secondary professional and social activities—meeting coincidentally were the Producers' Council, the Association of Collegiate Schools of Architecture and the Na-

tional Council of Architectural Registration Boards—the AIA held the center of attention. In a four-day session during which Committee Reports were heard, resolutions passed, medals awarded and officers re-elected, the Convention also heard representatives of Federal agencies, real estate interests and building materials manufacturers.

Following its almost established policy of meeting in "historic" localities (Williamsburg in 1936, Boston in 1937) and

thus lightening the business of convening with the pleasure of sightseeing, AIA members took many a trip through the old quarter of the city and the upriver plantation country. They mildly chided New Orleans in a last minute resolution: "The buildings of the 'Vieux Carré' will soon fall into decay unless protected and carefully preserved, thus losing a feature of great value to the city and nation", the resolution read in part.

Center of Convention discussion was the Report of the Housing Committee. Under the active chairmanship of Cleveland's Walter R. McCornack, the Committee recognized at the outset that at least three broad types of housing are necessary to any realistic housing program—large-scale multiple-family subsidized projects for the lowest income groups, low-cost single houses for individual ownership, and large-scale multiple-family projects built by private capital—and saw no conflict between the three. Pointing out that each type posed separate problems for the architect, it urged the employment of "architects in private practice for the design and supervision of Federal projects rather than the development of public bureau staffs for this purpose."

"The small house problem is the most difficult one facing the architects today. . . . Architecture, like medicine, is a profession. It scarcely seems reasonable to believe that architects can afford to say to the American people, 'We have a fixed price. If you cannot pay it we cannot serve you.'"

The plan proposed by the Housing Committee (but not accepted by the Convention) was: "A cooperative effort



President and Mrs. Maginnis (center) receive at New Orleans' Patio Royal.

by the Housing Committee of The Institute, the Producers' Council and the Government agencies to work out a program for the development of a technique for the design and planning of homes at a low cost and a method of merchandising these plans and specifications to the American people."

Significant were those sections of the Report calling for close cooperation between architects and USHA, HOLC and FHA; for the maintenance of minimum standards in dwelling units as reported by APHA's Committee on Hygiene of Housing; for permanent research into regional and city planning and zoning. On the basis of an analysis of completed PWA housing projects, the Report found that "the common complaint that the costs have been increased either by architects or by labor does not stand up. . . . The wages of labor had little or nothing to do with the increase in cost."

To Paul Cret, famed Philadelphia architect, went the Institute's Gold Medal for his "most distinguished service to the architectural profession." On the recommendations of the Institute's Committee on Allied Arts, the Fine Arts Medal went to Carl Milles, Swedish architectural sculptor, and the Craftsmanship Medal to Joseph H. D. Allen of Philadelphia for "pioneer work in the field of ceramics." Advanced to Fellowships in the Institute were 17 members including Nathaniel C. Curtis and Richard Koch, New Orleans.

Re-elected for the coming year were all officers: Charles D. Maginnis, Boston, president; Frederick H. Meyer, San Francisco, vice president; Charles T. Ingham, Pittsburgh, secretary; Edwin Bergstrom, Los Angeles, treasurer. Next year's convention will be held in Washington, D.C.



Richard Garrison

The "intrinsic beauty and harmony with its surroundings" of the Williamsburg Inn won a silver medal for its designers, the Boston firm of Perry, Shaw & Hepburn at the New York Architectural League's annual exhibition.

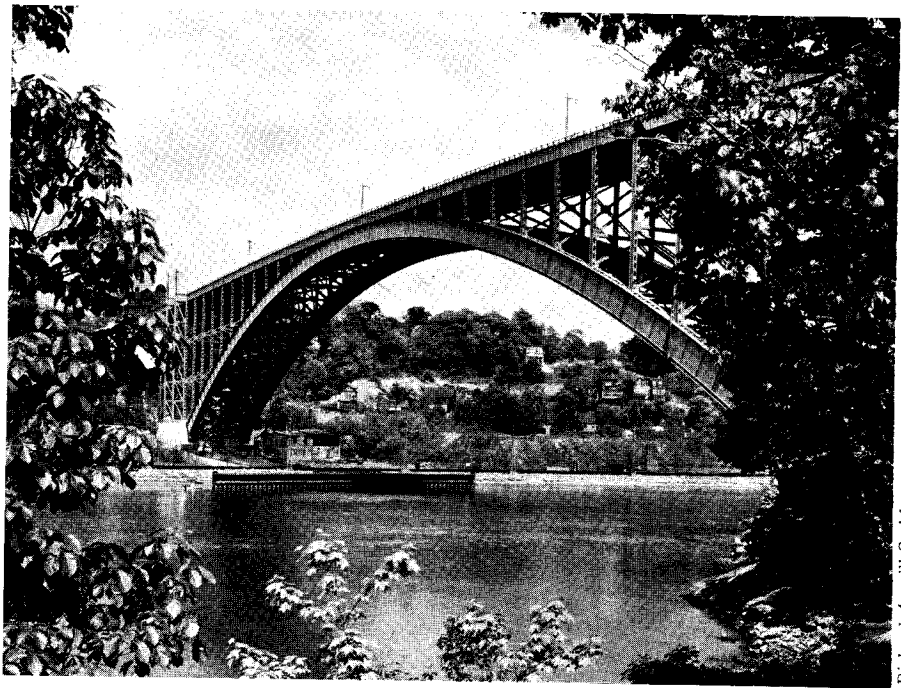

Richard Averill Smith

For his "several carefully designed projects including various bridges and the city zoos, as outstanding examples of the skillful application of architectural design to civic work", Aymar Embury II was also awarded a silver medal.

#### **Architectural League Awards Medals in Annual New York Exhibition**

TO ARCHITECTS and artists went medals and citations for outstanding work during the past year at the Annual League show which opened last month. Besides the awards to Perry, Shaw & Hepburn and Aymar Embury II, the League presented a silver medal to Richard Koch of New Orleans for his "resi-

dences executed in the local tradition, notable for freshness and simplicity." Honorable mentions were given to William P. Henderson, Santa Fe, N. M.; A. E. Doyle & Associates, Portland, Oreg.; Bibb Gould, Seattle, Wash.; Reinhard & Hofmeister, New York; Wyeth & King, New York, N. Y.



FHA's Miles Colean and Howard Vermilya visit Homeland Plantation.



First prize in the All-America Package Competition was awarded to the new design for the Higgins line of products. The packages, each carrying an identifying color circle, were designed by Egmont Arens, New York industrial designer.

### New York exhibit features house models

ON DISPLAY at W. & J. Sloane's, New York City, are photographs, renderings and models of houses designed by New York architects. The exhibit, arranged in collaboration with ARCHITECTURAL RECORD, opened late last month and is expected to continue until about the middle of May. Represented in the show is the work of 50 architects; 18 of these submitted models. The models represent considerable variety of style, and a wide range of geographic location from Connecticut to Sun Valley, Idaho. Among the exhibitors are Victor Civkin, Delano & Aldrich, Perry Duncan, Aymar Embury II, James W. O'Connor, William and Geoffrey Platt, Polhemus & Coffin, Office of John Russell Pope, Verna Cook Salomonsky, Walter Dorwin Teague, and Wyeth & King.

### Competition asks designs for small houses

FOR SMALL house designs suited to the living requirements of the "middle third", the Ladies Home Journal will award prizes totaling \$7,500. The competition, national in scope, is open to all architects and draftsmen. Final date for reception of entries is July 18, 1938. The competition has for its theme the "judicious enclosure of the greatest amount of usably convenient living area within the cubage limitation." Since the "middle third"—those families which pay \$30 to \$50 monthly rentals, or own homes of comparable value—is not confined to any section of the country, solutions to the competition should be based on those types of construction systems familiar to builders of any locality. Details of the program have been worked out in conjunction with the Federal Housing Authority, and can be obtained from John Cushman Fistere, Architectural Editor, Ladies Home Journal, 1270 Sixth Avenue, New York, N. Y.

## NEW INFORMATION FOR THE BUILDING FIELD

### Books General

*Abstract Art.* Architectural Students' Society. Tyson Road, Parkview, Johannesburg, South Africa.

*Colonial Interiors, Federal and Greek Revival, Third series.* By Harold D. Eberlein and Cortlandt Van Dyke Hubbard. William Helburn, Inc., 15 E. 55 St., New York, N. Y. Price, \$15.

*Demonstration Homes for 1938; especially prepared for low-income families.* For the consumer. National Homes Demonstration, 1337 Connecticut Ave., Washington, D. C.

*Historical Color Guide.* By Elizabeth Burris-Meyer. William Helburn, 15 E. 55 St., New York, N. Y. Price, \$6.

*Plan Your Home to Suit Yourself.* By Tyler Stewart Rogers. Charles Scribner's Sons, 597 Fifth Ave., New York, N. Y. Price, \$3.50.

*Secrets of an Art Dealer.* By James Henry Duveen. E. P. Dutton & Co., Inc., 300 Fourth Ave., New York, N. Y. Price, \$3.

*The American School and University.* 470 Fourth Ave., New York, N. Y.

*The Culture of Cities.* By Lewis Mumford. Harcourt, Brace & Co., 383 Madison Ave., New York, N. Y. Price, \$5.

*The Diary of a Housing Official.* By Abraham Goldfeld. National Association of Housing Officials, 850 E. 58 St., Chicago, Ill. Price, \$1.

*Urban Blight and Slums.* By Mabel L. Walker. Harvard University Press, Cambridge, Mass. Price, \$4.

### Manufacturers' Publications

#### Air Conditioning and Heating

*Arco-Thermo Heating System.* American Radiator Co., 40 W. 40 St., New York, N. Y.

*Crane Radiation Assures Home Comfort.* For the consumer. Crane Co., 836 S. Michigan Ave., Chicago, Ill.

*Emerson Electric Exhaust and Ventilating Fans.* The Emerson Electric Manufacturing Co., St. Louis, Mo.

*Fedders All-Season Air Conditioning Units, Bulletin AC-201A.* Fedders Manufacturing Co., Buffalo, N. Y.

*Kompak Air Filters.* Independent Air Filter Co., Inc., 228 N. La Salle St., Chicago, Ill.

*Registers and Grilles.* Register and Grille Manufacturing Co., 70 Berry St., Brooklyn, N. Y.

*Supplementary House Heating with Modine Unit Heaters.* Modine Manufacturing Co., 1776 Racine St., Racine, Wis.

*Young Convectors for Forced Hot Water and Unit Heaters.* Young Radiator Co., Racine, Wis.

### Draftsman's Equipment

*Graph Sheets, Co-ordinate Papers and Cloths.* Keuffel & Esser Co., Hoboken, N. J.

*Chemi-Scald Drawing Pencils.* Eagle Pencil Co., 703 E. 13 St., New York, N. Y.

### Change of Address

The RECORD publishes changes of address only on request, making no attempt to keep a day-to-day account. Only organization in the country with facilities for this is Sweet's Catalog Service, whose painstakingly maintained list undergoes an average of 23 changes per day for every working day in the year.

Arthur R. Smith, Architect, has moved to 309 Norton Building, Louisville, Ky.

Henry G. Markel, formerly associated with James M. Spain in the practice of architecture, has opened his own offices in the Deposit Guarantee Building, Jackson, Miss.

The office of Frederic W. Mellor, Architect, announces removal to 133 East 40 Street on April 18, 1938.

William Abts, Jr., has moved to 3939 N. Teutonia Avenue, Milwaukee, Wis.

S. E. Barnes announces removal of his offices from Platteville, Wis., to 419 Western Avenue, Fond du Lac, Wis.

Theodor Carl Muller announces that he has opened an office at 3 Pinckney street, Boston, for the practice of architecture and industrial design, and will divide his time between that office and his New York office at 9 Rockefeller Plaza, New York, N. Y.

### CALENDAR OF EVENTS

• **May 15**—Closing date, applications for Kate Neal Finley Memorial Fellowship in Art, Music, or Architecture. University of Illinois, Urbana, Ill.

• **May 15**—Closing date, competition for small sculptures in white soap. National Soap Sculpture Committee, 80 E. 11 Street, New York, N. Y.

• **May 23**—Closing date, Architectural competition sponsored by American Gas Association, 420 Lexington Avenue, New York, N. Y.

• **June 1**—Closing date, Lincoln Arc Welding competition. James F. Lincoln Foundation, Box 5728, Cleveland, Ohio.

• **June 1**—Closing date, competition for sculpture on United States Government Building, New York World's Fair.

• **June 20-24**—Summer Convention, American Institute of Electrical Engineers, Washington, D. C.

# DESIGN TRENDS

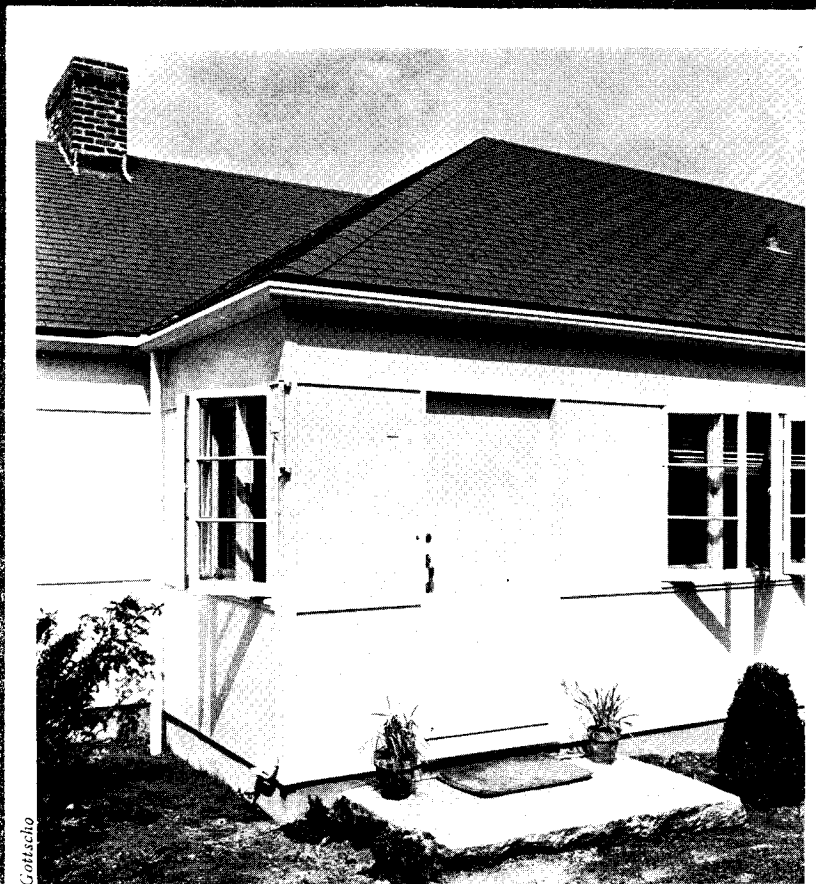

Gottschalk

**RESIDENTIAL CONSTRUCTION WITH PLYWOOD**

ARCHITECTURAL  
RECORD

# Residential Construction With Plywood

## PART I JOB-FABRICATED SYSTEMS

By OSCAR FISHER

THE DEVELOPMENT of new structural systems with plywood may prove to be one which will effect a major change in the design of smaller buildings. Most of the great forward movements in design were given their initial impetus by application of a new structural principle or material.

It is important to recognize, however, that those innovations which were basically structural had a decisive and enduring influence upon design. Today, any new material or method of construction which proves practical and economical for low-cost housing is certain of widespread use. A review of the recently developed structural systems with plywood should indicate useful applications to the designer and suggest further fields for fruitful experiment.

### Plywood a new building material

Examples of plywood made in Egypt 3,500 years ago still exist in good condition; but until recently when the resinous binders were perfected it could not be satisfactorily used on the exterior. The resinous binders make plywood waterproof, shrinkproof, checkproof, verminproof, fire-retardant, and prevent delamination. Plywood is the strongest known material per unit of weight. Combining structural strength with a satisfactory surface for finish, easy to cut, light to handle and adaptable to a

variety of uses, its potentialities are only beginning to be explored. Much has been made of modular design; and suggestions on size range from the two-by-four to the two-room unit. Here is a material which is adapted for use in modules which make fabrication relatively simple, and yet are small enough for erection by one workman. Large, simple surfaces are at the disposal of the designer at a low cost with a workable material. Plywood used in place of other materials, e.g., sheathing, sub-flooring, plaster, etc., in large units, tends to reduce labor costs.

Recent attempts in both laboratory and field to improve all phases of living-shelter design have produced several new types of light-weight constructions. These embody relatively large material units, novel means of assembly, simplicity of installation—all of which may importantly influence residential design . . . Such systems of construction that involve the extensive use of plywood are particularly noteworthy because of the characteristics of this material. In a series of two studies—the second of which will appear in the June RECORD—the essentials of residential plywood construction will be discussed and the trends of its use presented pictorially . . . The accompanying study deals primarily with structural systems of plywood that are fabricated at the building site. The article to follow in June will concern those systems which are wholly, or in large part, fabricated in shops removed from the site.

### Prefabricated structural systems

A method for prefabrication of large structural wall, floor and roof units is the most important recent advance in the use of plywood. These units lend themselves equally well to factory or site fabrication. Various methods have been developed, all of them employing the basic ideas suggested by the Forest Products Laboratory. The units are formed by the application of plywood to both sides of an inner structural frame. A unit of great strength is produced by using plywood in compression and tension in the same members. In floor units this forms a box girder which will deflect only one-fourth as much as the joists acting alone. Wall units have been made with a light structural frame which tested as a beam

to failure at 200 lb. per sq. ft. A 60-mile wind has a pressure of 12 lb. per sq. ft. These units are superior to most other prefabricated systems proposed for residential construction, because they do not create the difficult problem of joining dissimilar materials.

### Job-fabrication

Since they are easily fabricated without a complicated plant, special tools or labor, such plywood units are well suited to fabrication at or near the site. Job-fabrication permits greater flexibility during erection, alignment of walls is easier, and better integration is possible between structural units and mechanical equipment. Transportation costs are lower and the danger of damaging the surface in shipping is lessened. Labor difficulties have doubtless been a major deterrent to the success of factory fabrication on a large scale. Plywood units are easily job-fabricated and erected by one kind of building labor, thus eliminating sectional and jurisdictional disputes.

### Relations to other parts of structure

Many apparently good methods of construction have been abandoned because they were difficult to relate to the other elements in a complete structure. Plywood structural systems do not have those disadvantages.

(Continued on page 97)



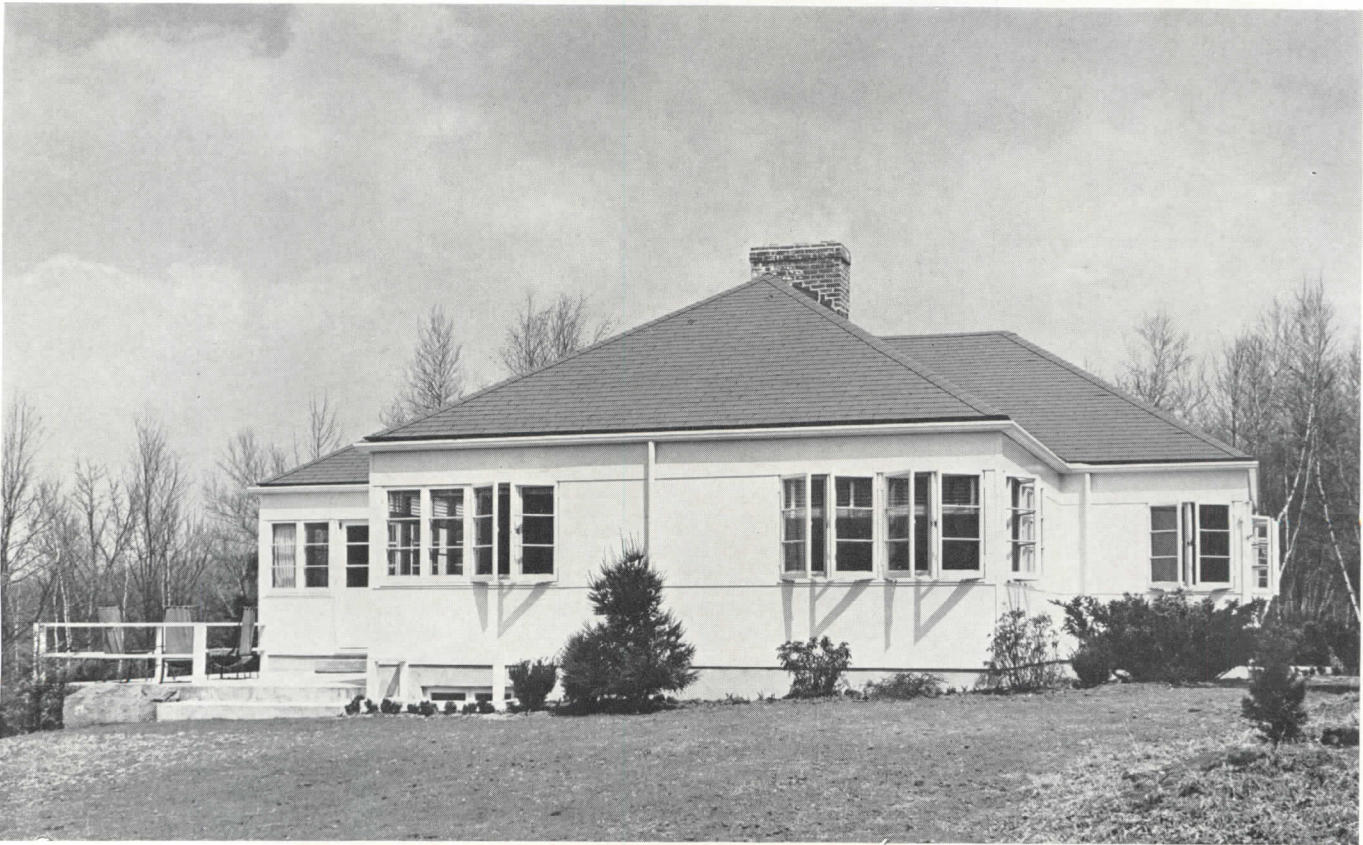

**SHIP-LAP PANEL CONSTRUCTION; MODULAR ASSEMBLY**

HOUSE OF DAVID SWOPE, OSSINING, N. Y.

DAVID SWOPE, Designer

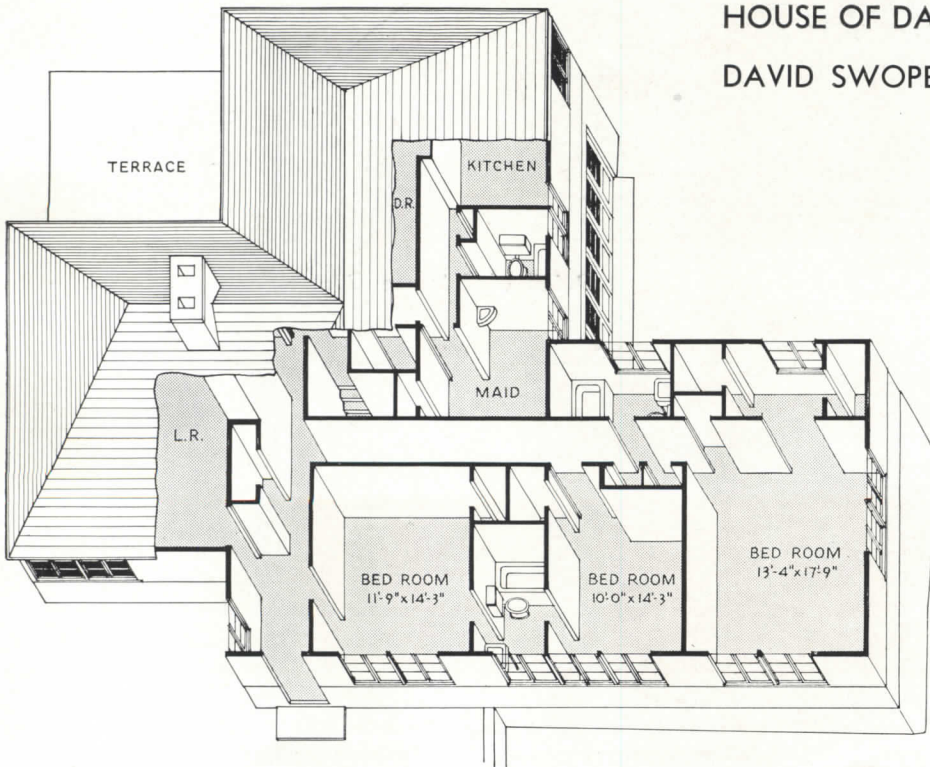

One of the most recent houses to be built almost entirely of dry, large-unit construction, this house employs plywood as an essential part of structure and for both exterior and interior finish. It was designed as an experiment that was successful in solving hitherto difficult problems of assembly. Construction—details of which appear on pages 94 and 95—is ingeniously simple, and proved to be economical.

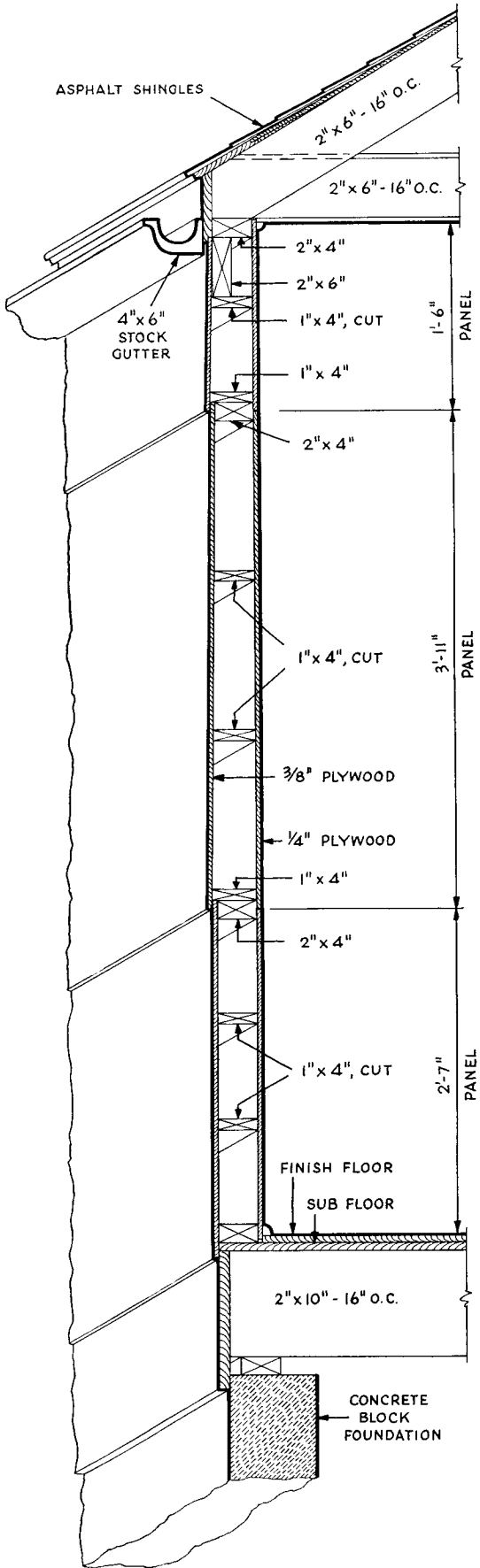

Typical wall section:  
 Scale: 3/4" = 1'-0"



Photos by Samuel H. Gottscho

Detail of Entrance Corner, house of David Swope

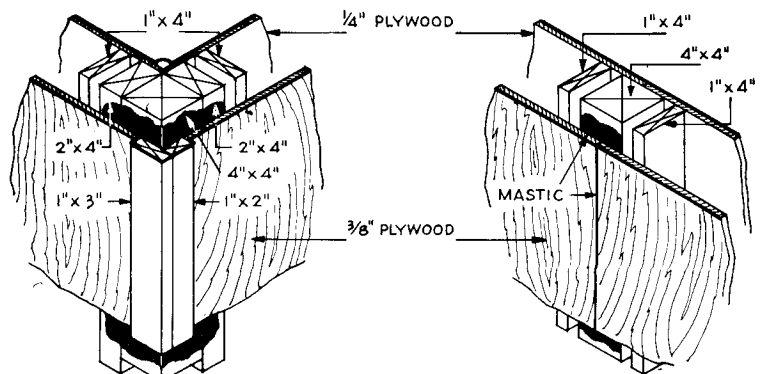

Isometric of typical corner construction

Isometric of construction through typical vertical joint



## HOUSE OF DAVID SWOPE OSSINING, NEW YORK



This is one of the most significant and practical houses yet constructed with plywood. It is a significant house because it demonstrates that large structural units do not necessarily impose limitations upon a capable designer. It is practical because it employs a structural system that fulfills most requirements for an economical type of dry construction adaptable as a simple solution to problems of assembly and erection. The complete house was designed in modules of stock plywood sizes.

Use of horizontal, rather than vertical, stressed-plywood units for exterior walls minimizes the joint problem. The plywood is used as mammoth shingles with a lapped horizontal joint. This is accomplished in a unique manner by taking advantage of stock lumber dimensions in the structural core of the units. (See details on facing page.) The 2 x 4 in. at the top of the unit is actually 3 $\frac{5}{8}$  in. wide, while the 1 x 4 in. piece at the bottom is actually 3 $\frac{7}{8}$  in. wide. This allows for a  $\frac{3}{8}$ -in. lap, which is just the thickness of the exterior plywood. Units were prefabricated at the site by gluing and nailing the plywood to the structural cores. They are admirably suited to shop fabrication as well.

The frame was first constructed of 4 x 4 in. posts, 8 ft. on center. Prefabricated units were then placed between them and wedged at posts. No danger of cumulative error existed because of the allowance made for play between the units and at corners.

All doors, interior partitions and cabinets were specially fabricated of plywood. A successful test of the waterproof qualities of the plywood and the system of joining was made by leaving the house unpainted through the winter.

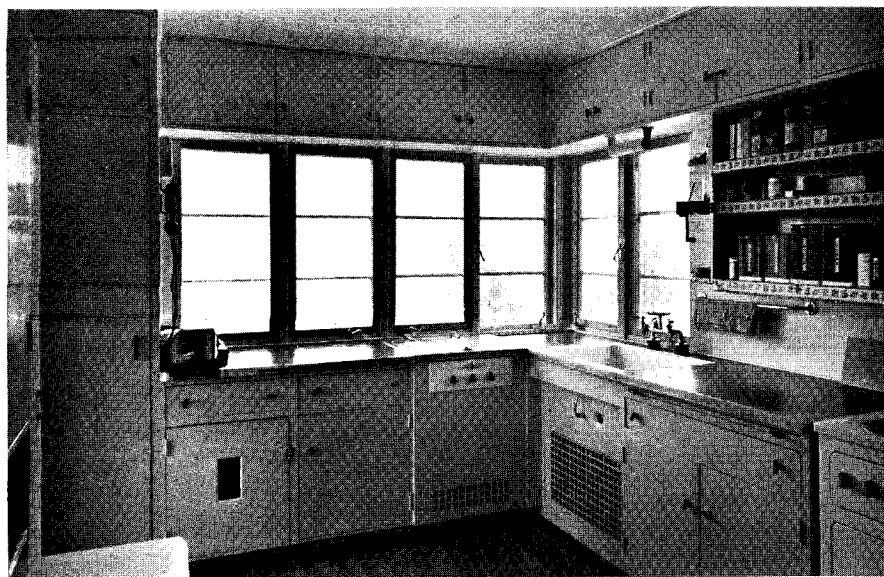

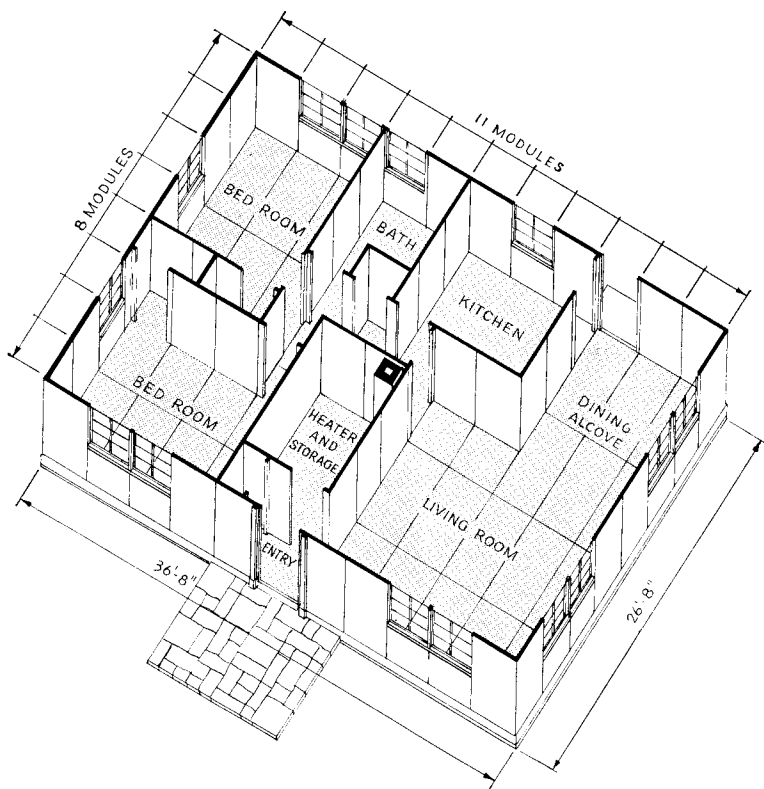
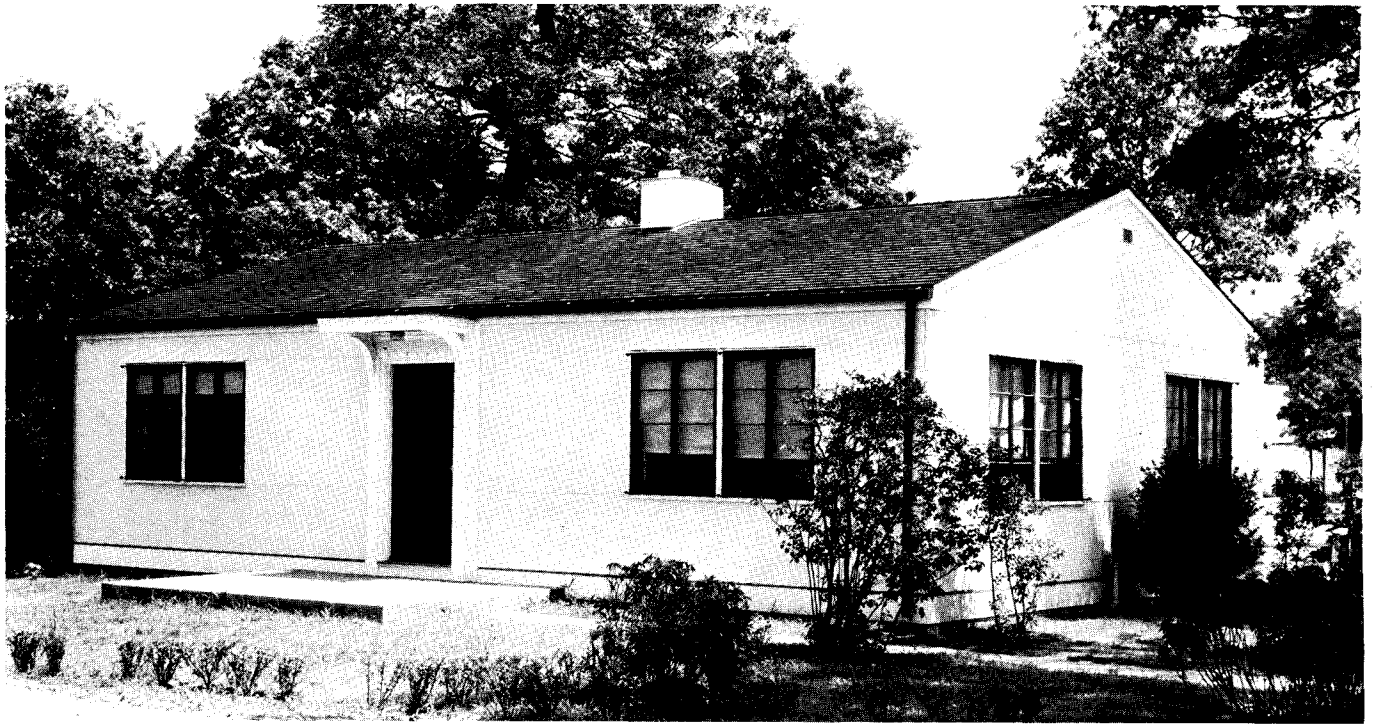

**FLUSH-PANEL CONSTRUCTION;  
MODULAR ASSEMBLY**

EXPERIMENTAL HOUSE AT  
GREENBELT, MARYLAND

Designed and built by the Resettlement Administration, this is one of five houses constructed of resin-bonded plywood units utilizing the "stressed-skin" principle (see AR, 2/37, p. 41-47). Three houses were assembled with shop-fabricated units, the others with units built at the site. No significant differences in structural quality or price were noted. All were designed in modules of stock plywood sizes.

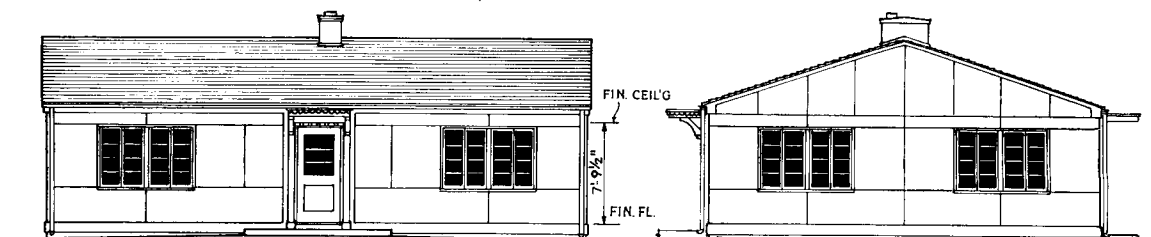

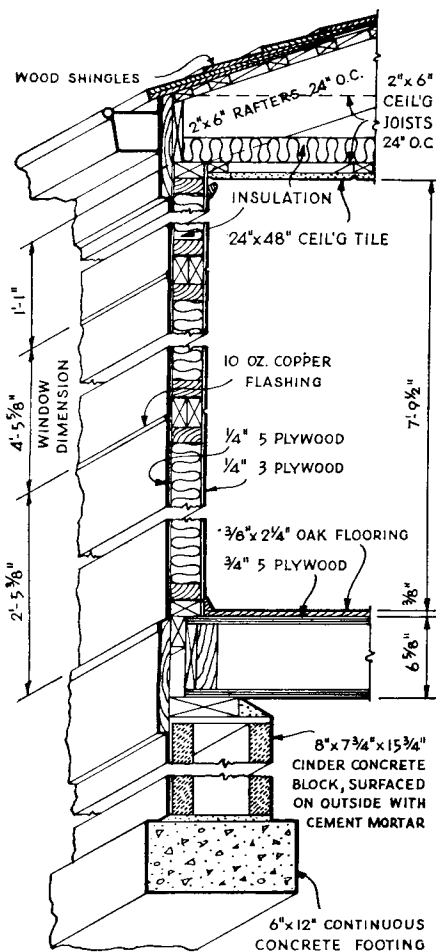

Details of Flush-Panel Construction —  
Experimental Plywood House at Greenbelt, Maryland

(Continued from page 92)  
The few problems yet remaining do not seem to be insurmountable obstacles.

The connection of plywood floor and wall units to foundations need be no different than ordinary frame construction. In fact, because of a reduction in dead load, they may simplify the foundation problem.

Plumbing and heating pipes present a serious problem when stressed-skin plywood floor units are used, because the shallow joists cannot be cut for piping without sacrificing the structural efficiency of the unit. In the one-story houses to which most experiments have been confined this problem does not exist.

For the most part, paint has been used for exterior and interior finish, although wallpaper is just as satisfactory for interiors. Rough-texture paint finishes are more satisfactory on hot-pressed plywood, because the heat process extracts moisture from

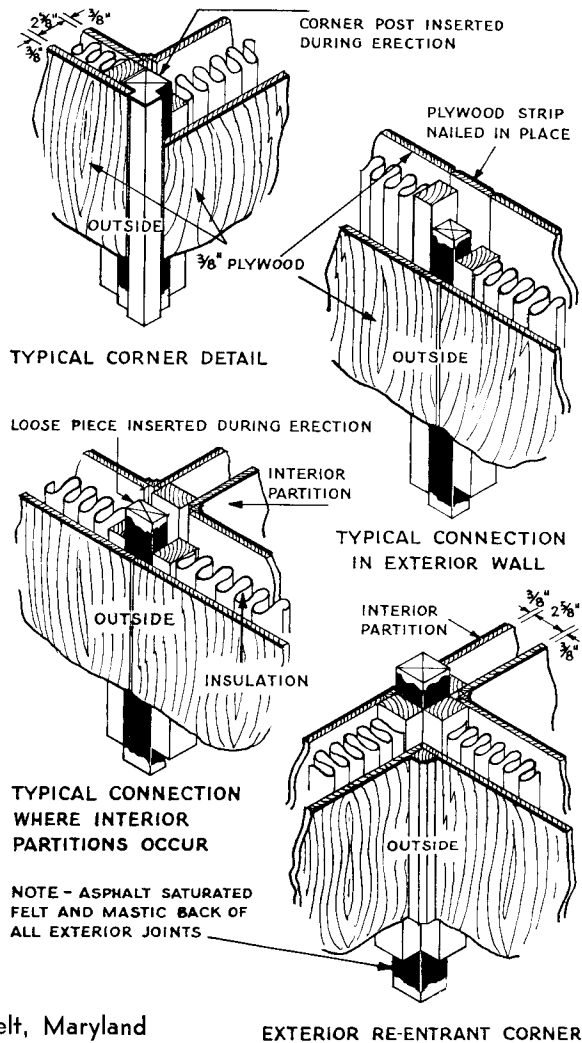

Resin-bonded plywood of 1/4-in. thickness was used on both exterior and interior of panels. Panels were installed both vertically and horizontally. Horizontal joints required copper flashing; and all exterior joints were set in a waterproof adhesive. This type of panel system does not appear to be as generally successful as the overlapping horizontal system employed in the Swope house.

the wood and is inclined to raise the grain. This is overcome in the cold-pressed plywoods.

Objections have been raised to the acoustical qualities of this type of construction, because of the relatively resonant character of the plywood. Much of this objectionable quality is removed by filling the exterior wall units with loose rock wool. Further consideration of this problem is indicated.

**Cost factors**

To attempt any relative cost analysis would be meaningless at this time, with the limited experience at hand. Accurate estimates would have to be made of the effect of the structural system upon the cost of the other elements in the structure. Many factors would have to be weighed, for which there are no accurate experience figures. Fabrication and erection in large units will undoubtedly eventuate in lowered costs.

There is, however, a tendency to be oversanguine regarding the amount of cost reduction that can be made possible through new systems of construction. Most of the proposed fabricating systems are confined to the shell of the house. Many that apply to other parts of the house may improve the quality, but may not reduce the cost. According to a survey conducted by Purdue University, the shell represents only 22% of the total cost of a typical residence. Thus, should there be a saving of 10% in the cost of the shell, it would only result in a saving of 2% of the total.

Any attempts at cost reduction will have to be judged by the quality of the results as well as by their effect upon other elements in the structure: plumbing, heating, foundations, wiring and maintenance costs. In these respects the plywood structural systems seem to have come closer to a solution than any other offered up to the present.

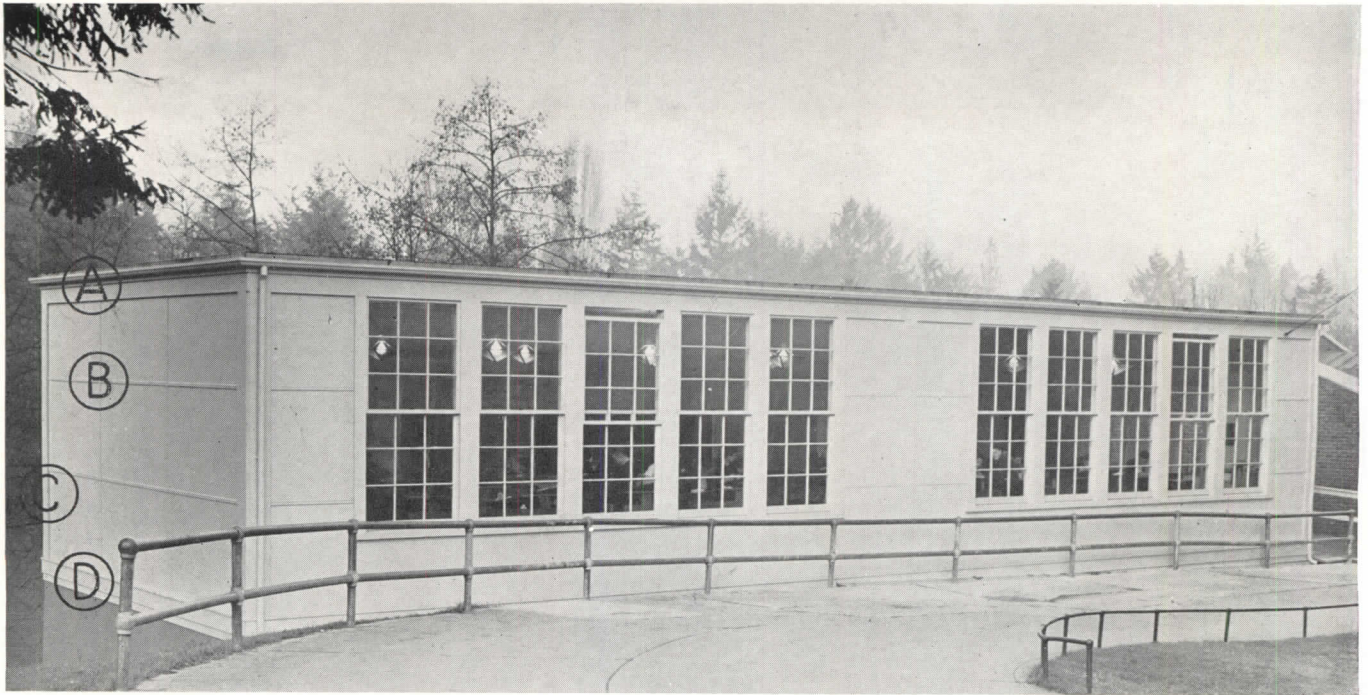

PORTABLE SCHOOL, TACOMA, WASH.  
W. W. DURHAM, Architect

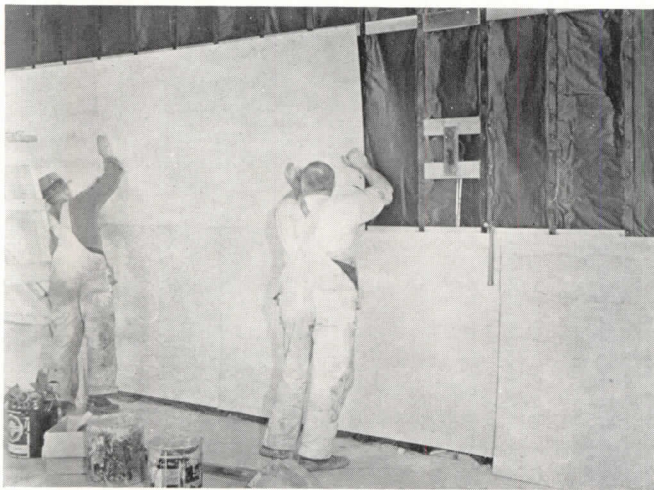

### CONVENTIONAL, NONMODULAR CONSTRUCTION

The need for lightweight, portable, but strong and rigid panels dictated the selection of plywood in this building. Portable units measuring 24 x 32 ft. are framed with conventional lumber studs and joists over a post and girder foundation. The exterior is finished with hot-pressed, resin-bonded plywood of Douglas fir. Joints involve use of a caulking compound. Interior walls are lined with plywood 4 x 8 ft. stock panels applied horizontally over insulation. Interiors are painted a light-tan priming coat; exteriors are painted three coats of lead and oil.

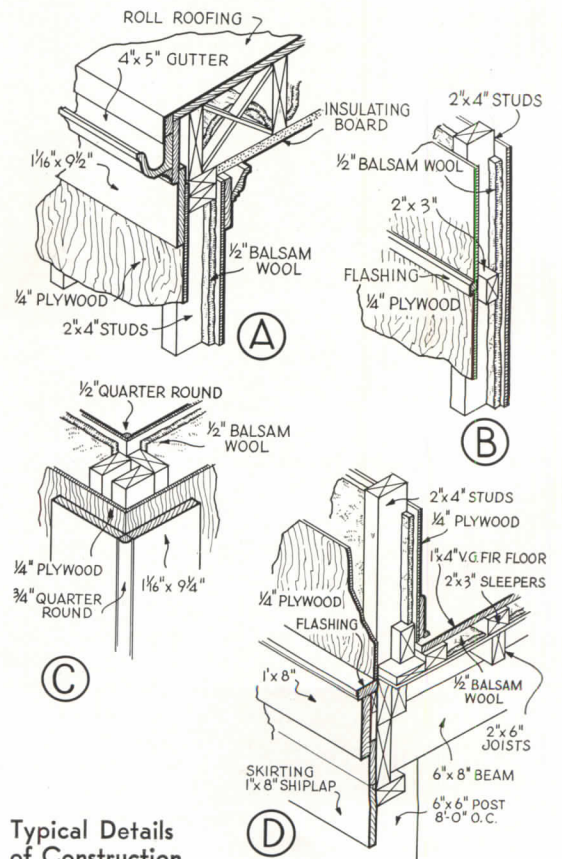

Typical Details  
of Construction

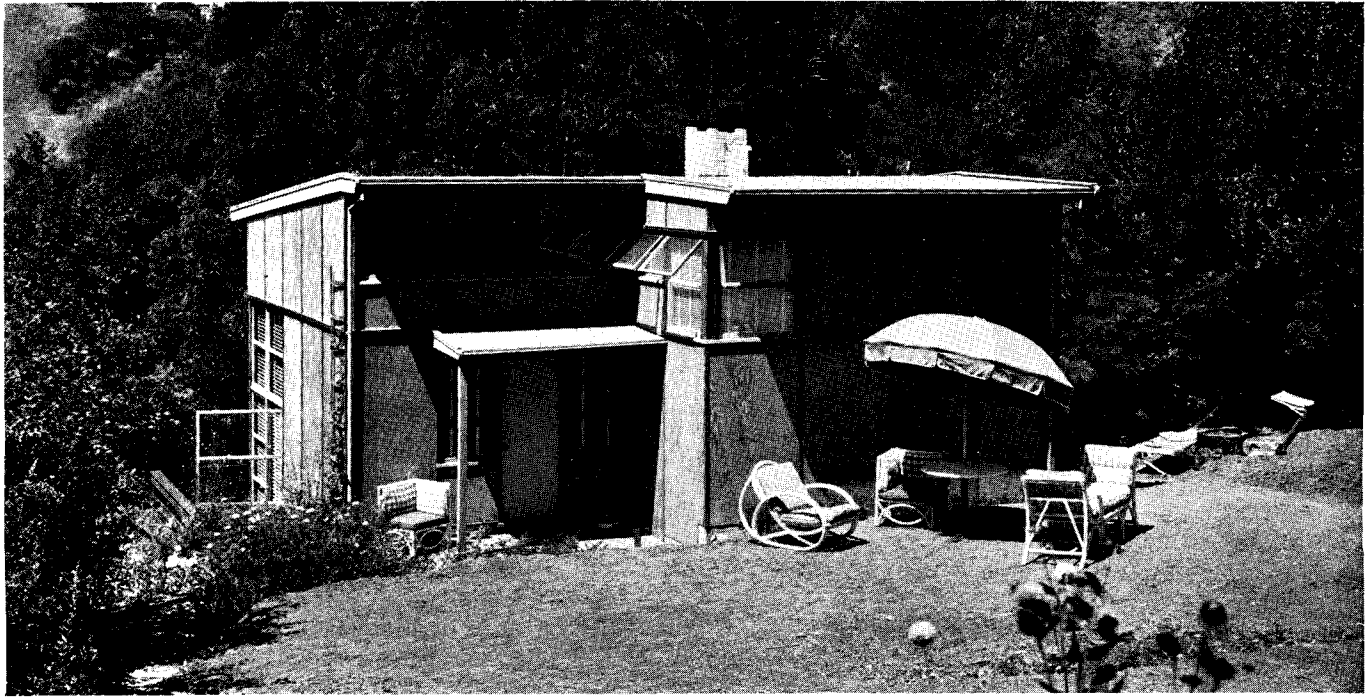

HOUSE OF ROBERT TRYON, BERKELEY, CALIF.  
MICHAEL GOODMAN, Architect

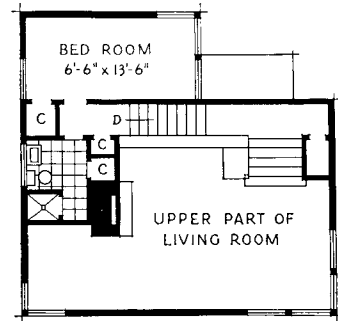
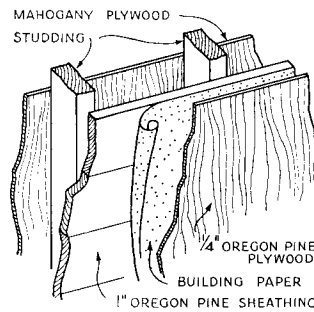

Second Floor

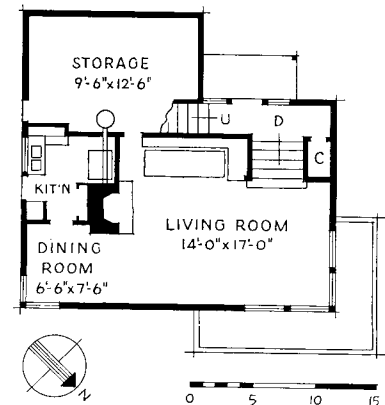

First Floor

**STANDARD CONSTRUCTION;  
MODULAR DESIGN**

The structural system used in this house does not differ basically from the usual type of wood-framing system. Plywood has merely been substituted for other materials; and the result shows how this can be successfully employed in place of siding, shingles, brick veneer or stucco on the exterior. The interior is finished on walls and ceilings with mahogany-faced plywood. Although conventional studding and sheathing were employed in constructing this house, the use of plywood exercised a major influence on the design. Both horizontal and vertical dimensions were based upon sizes of stock plywood panels; and, as shown in the small isometric sketch, the construction was of the dry type—except foundations—thus eliminating much field labor. Cost was approximately \$2,900; cubage is 9,000 cu. ft.

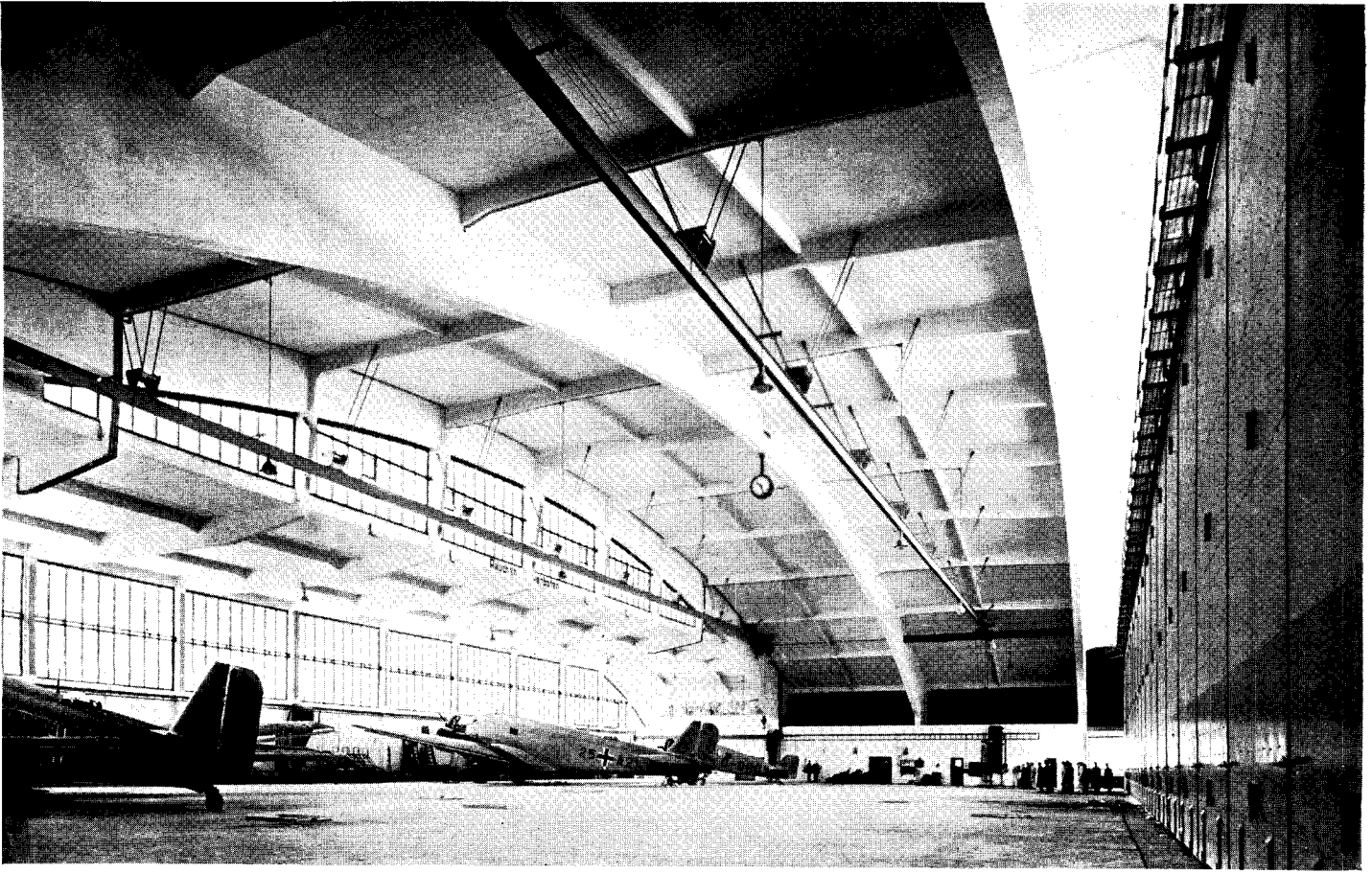

Airplane Hangar, Germany. Construction is monolithic concrete, Z-D system. Concrete shell is  $4\frac{3}{4}$  in. thick. Span is 240 ft.

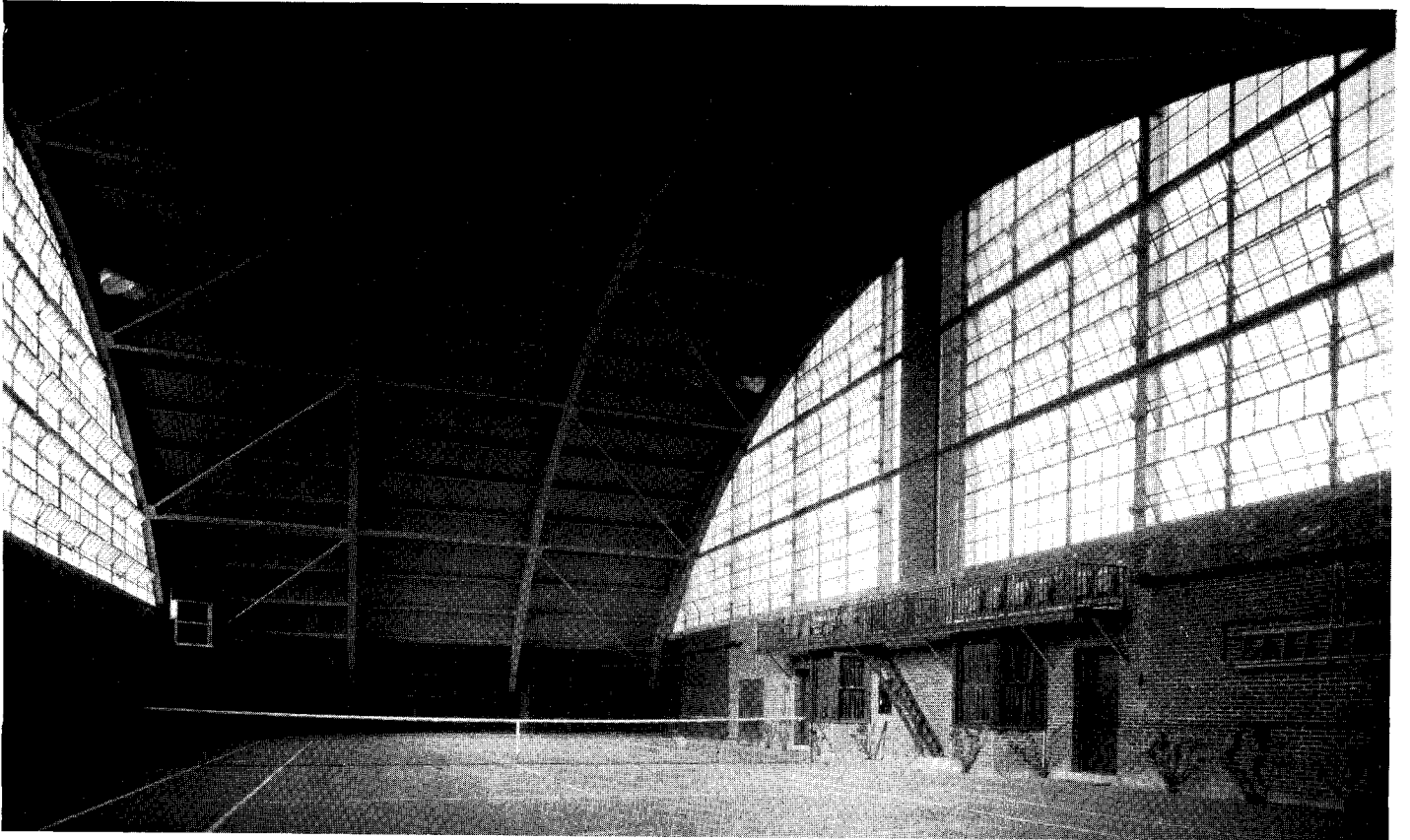

Tennis Court, Beverly, Mass. Gavin Hadden, Designer. The shape of the building, patented by Mr. Hadden, is economically determined by tennis-ball trajectories: balls which strike the roof would have been out of bounds anyway.





Airplane Hangar, Germany. Construction is monolithic concrete, Z-D system. Concrete shell is  $4\frac{3}{4}$  in. thick. Span is 165 ft.

## Longer Spans for Flexibility in Use

In recent years production methods have been changing with increased rapidity. Longer spans in building construction have become essential: first, to permit maximum flexibility in the placement and operation of equipment; and second, to avoid situations in which building structure acts as a brake on the progressive development of the activities within. This trend in the direction of longer spans may be observed throughout the building industry.

Industrialization, as a movement toward increased productivity, is marked by continual redesigning of equipment and buildings: by simplification and enlargement of units, by greater continuity of design. Thus, steel structural members, once built up of plates and angles, are now rolled in all but very large sections; continuous constructions—rigid frames, concrete shell and laminated wooden arches—become increasingly common. On the one hand, improved methods of production require homologous changes in the structures which house them; and on the other hand, they make these changes possible.

Similarly, the materials from which equipment and buildings are fabricated—steel, concrete and wood—become (1) more homogeneous, (2) stronger and lighter, (3) more plastic.

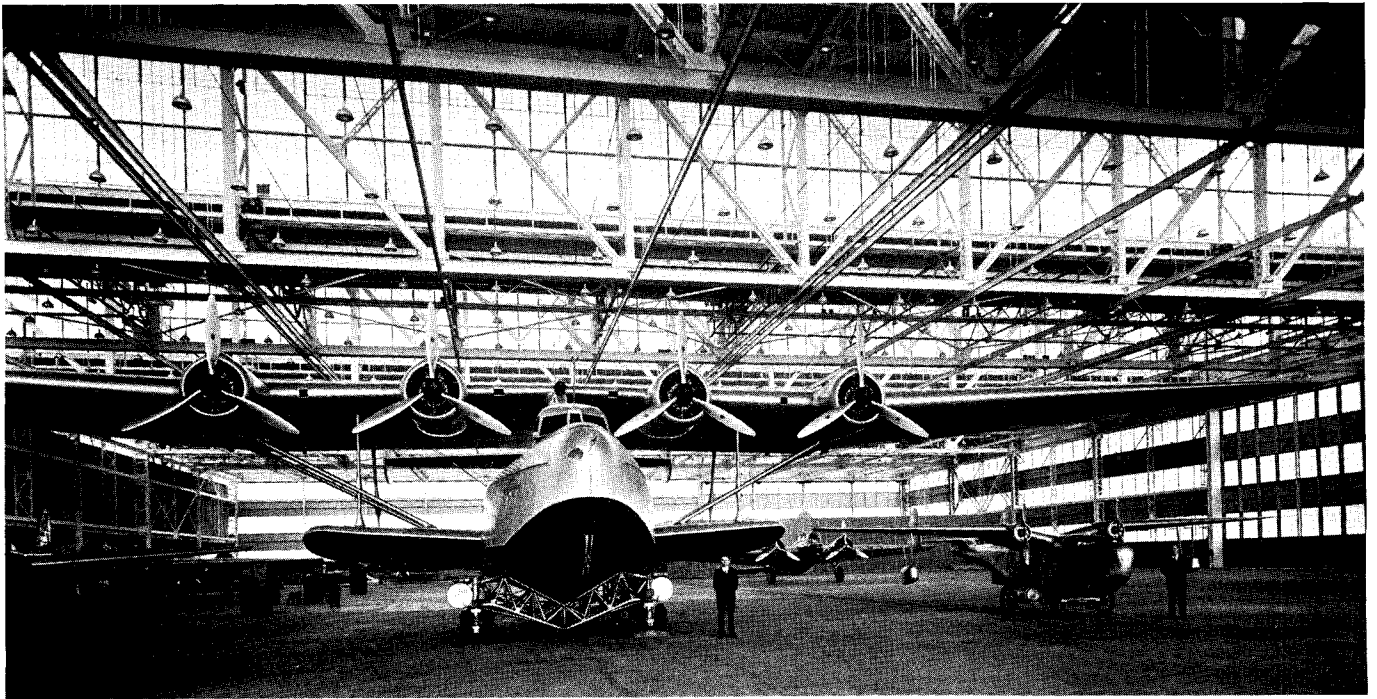

Assembly Plant, Glenn L. Martin Co., Baltimore, Md. Albert Kahn, Inc., Architects. Roof trusses span 303 ft. The building has an area of 135,000 sq. ft. without a single column: lengthening wingspreads are the reason.

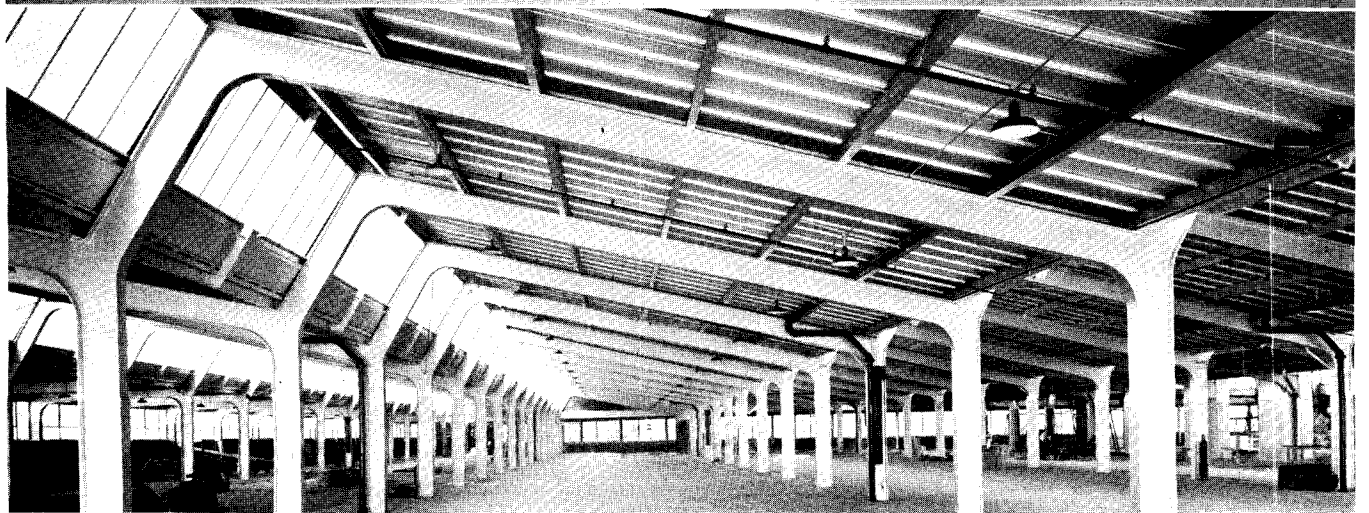
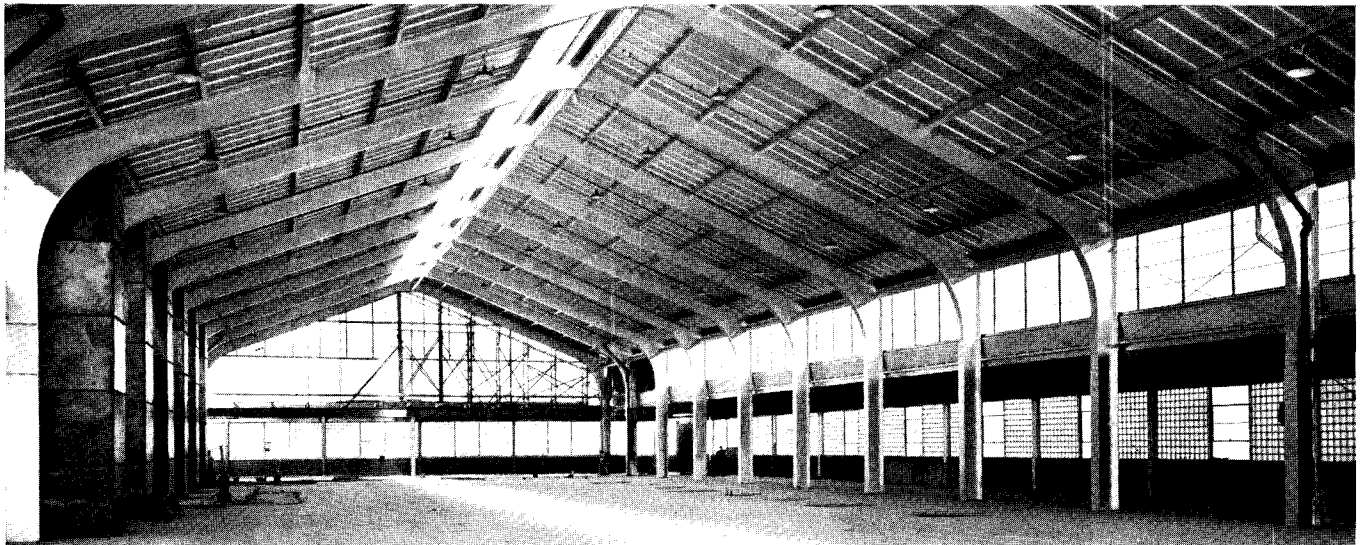

Lincoln Electric Company, Cleveland, Ohio. The Austin Company, Engineers. The main-bay span is 80 ft. The conventional roof truss is eliminated and a welded rigid frame substituted: column and beam are one.

## Steel

THE FABRICATION of steel and its use in the most advanced industries has been increasingly characterized (1) by control of the grain size of the metal by proper temperature and work control; (2) by the employment of steels offering greater tensile capacity and better resistance to corrosion\*; (3) by the use of welding.

These characteristics are, in general, found together: for welded construction permits reduction in weight (no rivets or weakening rivet holes, no overlapping materials); and steel of uniform internal structure is most weldable. Recently, in a report of the American Welding Society, several of these new compositions were called "foolproof welding steels." For in these materials adequate ductility is retained in and around the weld almost irrespective of the welding method employed. Welded connections, too, make continuity of construction over the points of support much easier, so permitting further reductions in dead weight. These steels require smaller allowance for corrosion and admit the use of thinner sections.

Together, these advances have made possible savings in weight of 20 to 30%—as much as 50% in some cases; and spans in building construction have lengthened steadily with the employment of the shallower beams and lighter sections thus made possible.

Improvements in the fabrication and use of steel have made most headway in industries other than building construction; simultaneously, however, advances in these fields require corresponding advances in the design of the buildings which house them. In the field of transportation, for instance: here the advantages of weight-saving are most obvious; reducing the weight of a mobile structure reduces the cost of moving it. The greatest progress along the lines described has probably been made in *aircraft construction*. The use, in planes, of alloys of remarkable lightness, welded construction, longer wing spans, are factors which ultimately determine the design of airplane hangars and assembly plants.

The trend toward longer spans involves not horizontal members

\*This includes not only the "high tensile" steels, but the new carefully controlled carbon steels and "low alloy" steels as well.

alone, but vertical members as well. "Rigid frame" construction has in recent years come into wider use. In steel construction, the use of welding has accelerated this development by permitting the elimination of stiffeners at corners.

## Concrete

The trend in concrete design for buildings is identical with the trend in steel: it is marked by the use of increasingly longer spans made possible by greater constancy, strength, lightness and plasticity in the material itself.

It is a rough index of the range and speed of this development that the compressive strength of concrete has increased some 50% in the last 25 years: this has been accomplished largely (1) by grading and increased homogeneity of aggregate, (2) strengthening of binding materials, (3) more precise control of handling methods and of conditions of the hardening process.

A conspicuous quality of concrete has always been the ease with which it can be formed into monolithic structures. Adequate advantage of this quality has seldom been taken: first, the difficulty of analyzing stresses in continuous concrete construction brought it about that, until fairly recently, most monolithic frames were designed as combinations of isolated members; and second, because of the comparative massiveness of longer structural members—a massiveness necessitated in part by a safety factor which made wide concessions to ignorance.

But the advance of concrete technology, as well as a better understanding of continuous construction (based on photoelastic analysis, the study of models, etc.) has brought corresponding advances in building regulations—those of the American Concrete Institute, for example: these codes now generally require that monolithic frames be designed according to principles of continuity. The more efficient distribution of materials, and the lighter weight of structural members which results, contribute inevitably to the trend to longer spans.

A refinement in concrete rigid-frame design is the hollow girder. An auditorium whose roof is supported by hollow concrete rigid frames was recently built in Placentia, California. Used here in building con-

struction for the first time, these girders span 77 ft.; hollow interiors permit obvious economies in weight.

## Wood

Wood is a natural, organic material and its properties are therefore probably not subject to a comparable precision of control. Nevertheless, within somewhat narrower limits, the use of wood in building construction is another phase of the trend described. Greater constancy in the material itself is increasingly obtained by higher control of silvicultural, nursery and planting methods. Increased strength, lightness and continuity are sought in the adaptation of forms used in steel and concrete construction—the rigid frame, for instance; or in the perfection of plywoods, composition and metal-impregnated boards.

Perhaps the most important of these is the development of plywood. Trees (mostly Douglas fir) used for the manufacture of this product must be highly homogeneous internally: free of knots and with a minimum of sapwood. Subjected to 100 to 200 lbs. of pressure per square inch the glue-joints become stronger than the wood fibers; this and the criss-cross grain of adjacent sheets give plywood a comparatively high factor for tensile strength.

Rigid frames in wood, first used in the Hall of Progress at Cleveland's Great Lakes Exposition last year, were sheathed with stressed coverings of plywood designed to carry a large part of the load. Laminated wooden arches have also been constructed with spans of more than 150 ft. Another construction in wood with potentialities for longer spans is the "lamella" roof.

## References

1. **Design for Environmental Control.** K. Lönberg-Holm and C. Theodore Larson. Architectural Record, Aug. 1936.
2. **Technological Trends and National Policy.** Report to the National Resources Committee. United States Government Printing Office. Washington: 1937. Part III. Sections VIII, IX.
3. **Production in the Modern Order.** Industrial Society. Part II. University of Chicago Press. Chicago, 1929.
4. **Enclosed Acreage.** Engineering News Record, March 5, 1936.
5. **New Products—Manufacturing Methods.** Bror Nardberg. Rock Products. Feb. 1938.
6. **Increasing the Strength of Concrete.** Adalbert Pogany. Concrete. Apr. 1937.



Photos by Fairchild Aerial Surveys, Inc.

The span is the central consideration in the design of bridges. Here the problem of spanning large spaces has received most attention: in 100 years bridge spans have increased in length over seven-fold. High-strength steels with correspondingly lighter weights are essential in this field. Aluminum-alloy floors have been used in bridge reconstruction, replacing heavier metal and permitting greater live loads. Cold-drawn steel

wire with an ultimate strength four times that of the wrought-iron wire once used, makes possible such spans as that of the Golden Gate Bridge—4,200 ft. Top: Ambassador Bridge, Detroit. Jonathan Jones, Engineer. Bottom: The Triborough Bridge, New York City, with the older and relatively massive Hell Gate Bridge behind it. Aymar Embury, II, Architect. O. H. Ammann, Engineer.



H. Bagby

## IN THE TRADITION OF OLD VIRGINIA

Like a strong thread in an intricate pattern, the Colonial period of our historical background is woven inextricably into the customs and events of modern times. It shows to some extent in every phase of activity. In the field of residential design this is particularly evident; so that the Colonial tradition is accepted by many as the only truly "American Style." The recently completed restoration at Williamsburg has re-emphasized the simple, sturdy virtues of that style. It is not surprising, therefore, that Williamsburg should serve as a new inspiration to residential designers; and on the following pages are shown two examples of new houses in the architectural tradition of this old Virginia community.

**HOUSE OF  
DR. WILLIAM T. SANGER**  
HENRICO COUNTY, VIRGINIA

A. G. LAMBERT, Architect

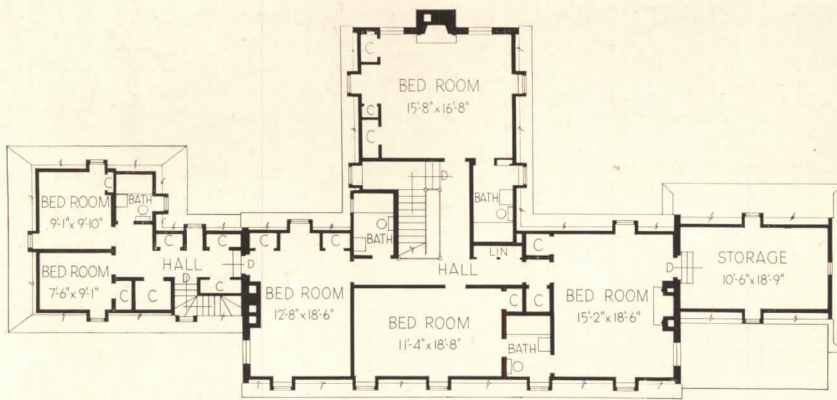

Second Floor

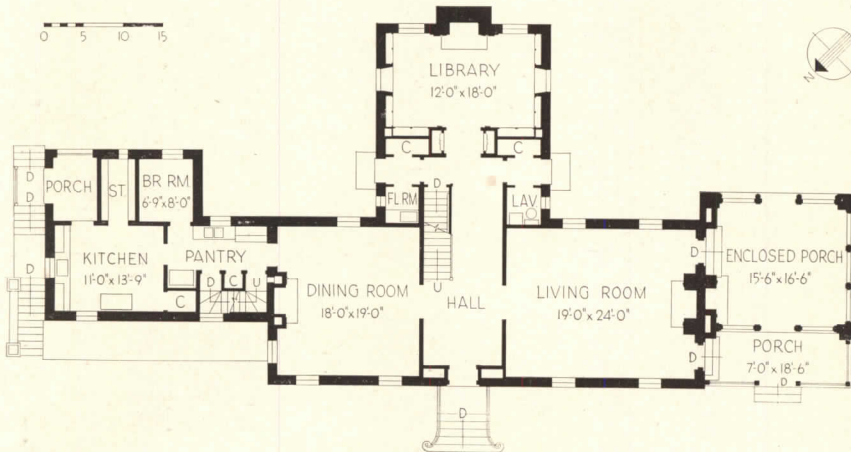

First Floor

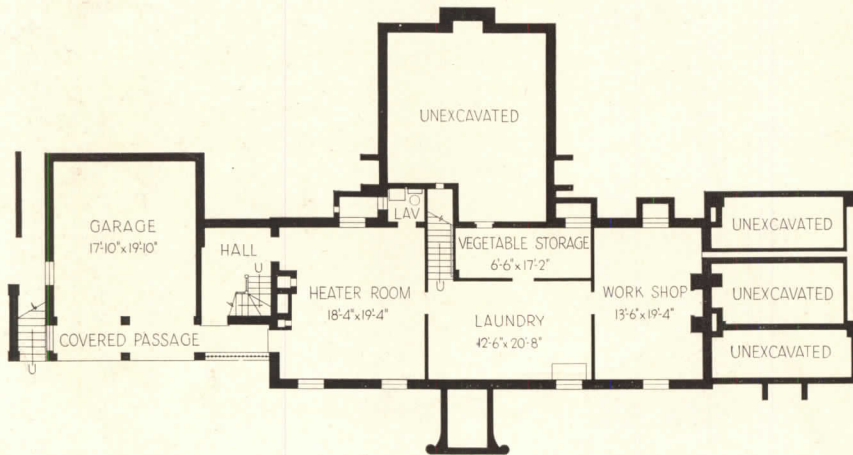

Basement

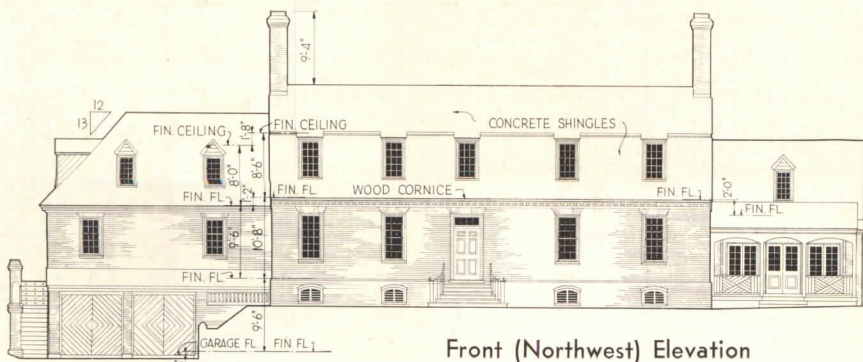

Front (Northwest) Elevation

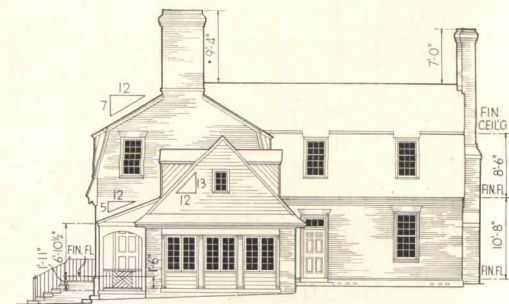

Side (Southwest) Elevation

THE ORIENTATION, the arrangement of rooms and the architectural character of this house resulted from careful attention to details of the owner's requirements. Dr. Sanger's two hobbies are, first, flower gardens and, second, the collection and repair of antique furnishings. Therefore, entrances were placed for particularly easy access to gardens, both formal and informal, all of which have been developed by Dr. and Mrs. Sanger. First-floor rooms were relatively placed to produce a sense of spaciousness and convenience in servicing; second-floor areas were planned relative to space economies, garden outlooks and natural ventilation.

Construction is of solid brick masonry above and below grade. Footings are brick. Walls are faced with antique brick laid in Flemish bond and trimmed with ground brick. Roofs are covered with reinforced concrete shingles with an antique finish.



H. Bogby



Photos by H. Bagby





**HOUSE OF  
DR. WILLIAM T. SANGER**

This page: Above, Southeast End of Library. Left: View into Dining Room from Hall.

Facing page: Porch Wing from the west. The main portion of the house has no gutters or conductors. Brick gutters at grade, shown at lower left in this picture, carry roof water to a storm drain.



**HOUSE OF RAYMOND O. PECK, ARCHITECT, WESTFIELD, NEW JERSEY**

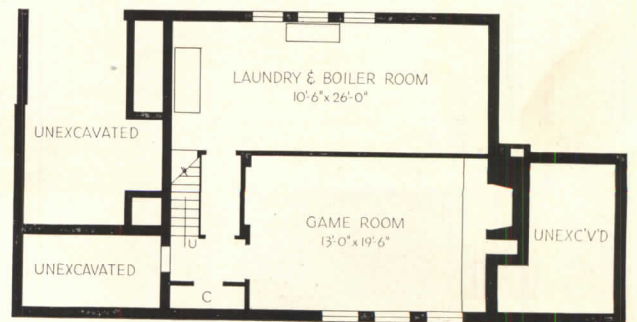
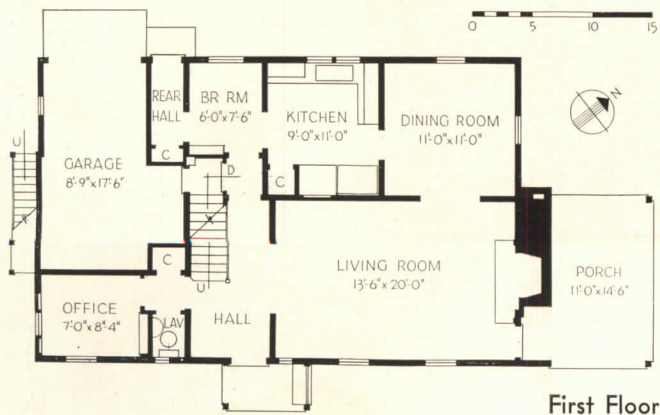
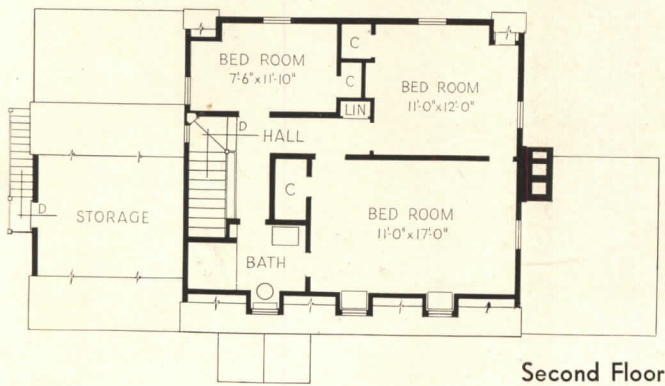

IT IS A COMPARATIVELY rare event when an architect becomes his own client and can develop a house which need satisfy only his own aesthetic and practical requirements. This house reflects an effort "to preserve the tradition and charming simplicity so characteristic of Williamsburg" without sacrificing the necessarily utilitarian requisites for modern living. Cost was also a determining factor of the design; thus in layout and detail the design is necessarily simple. Construction is the conventional type of wood framing on cinder-block foundation walls. Ceilings are insulated with rock wool, walls with reflective metal. Openings are weather-stripped. The house is equipped with an oil burner and winter air-conditioning system.



Detail of Front Entrance from the South

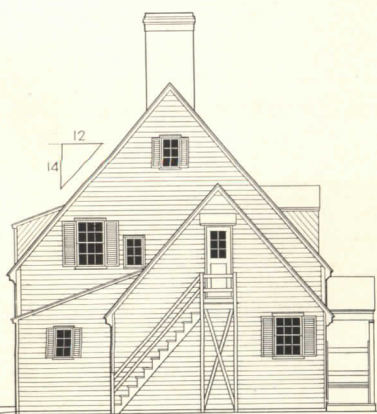

Side (Southwest) Elevation

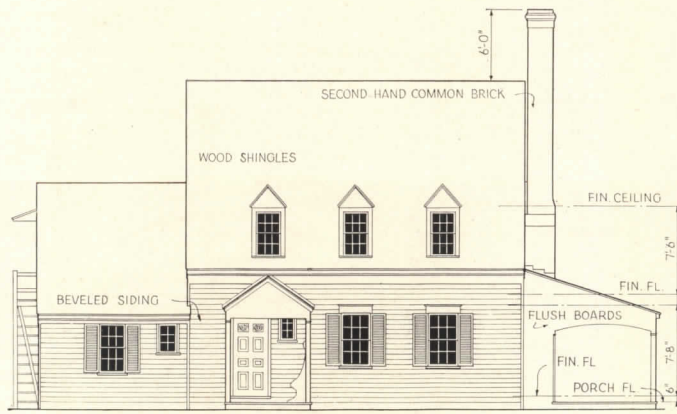

Front (Southeast) Elevation

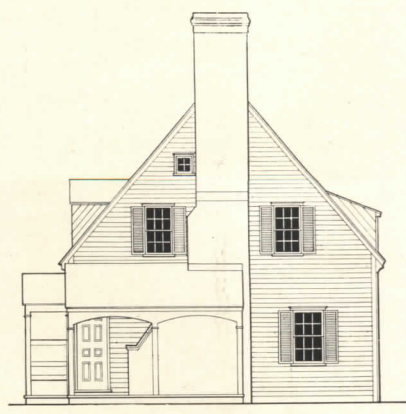

Side (Northeast) Elevation

**HOUSE OF RAYMOND  
O. PECK, ARCHITECT**

Right: Detail of Garage and Office Exterior from the South. The open stair is the only access to the storage space above Garage. Below: Northeast End of Living Room.



*Photos by Samuel H. Gottscho*

# Building Volume Trends for 37 Eastern States

## Architect-Engineer Planned vs. Planned by Others

By **CLYDE SHUTE**, *Manager, Statistical & Research Division, F. W. Dodge Corporation*

### TOTAL BUILDING

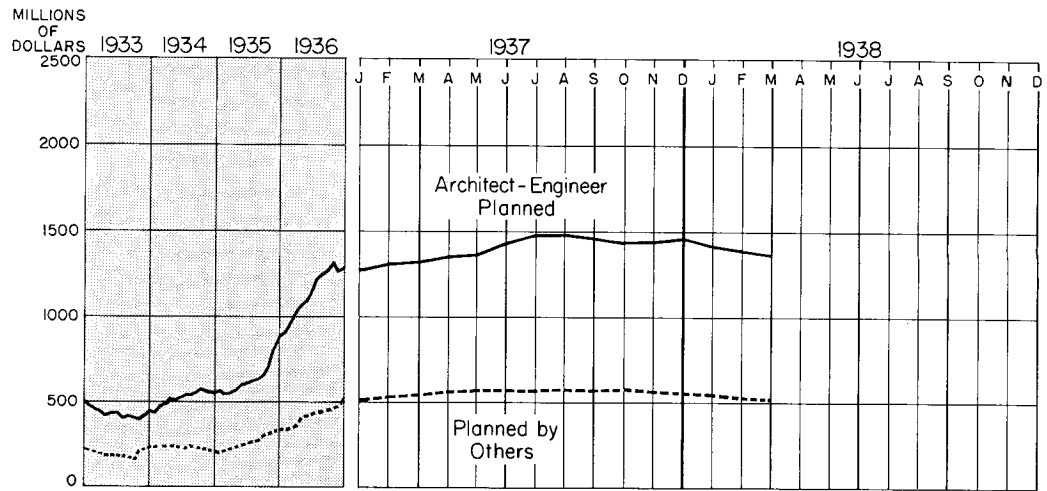

### EDUCATIONAL BUILDING

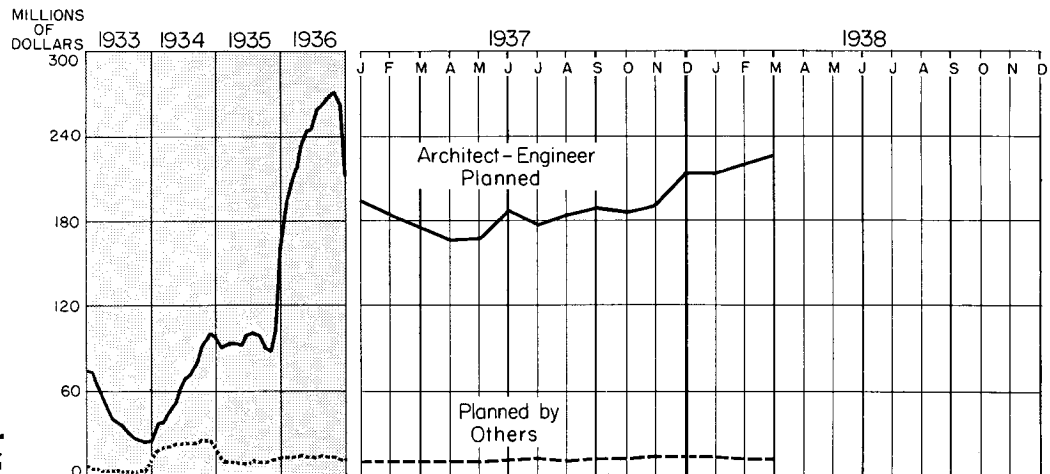

### TOTAL BUILDING 37 EASTERN STATES 3 MONTHS - 1938

Planned by Architects,  
Engineers, and by others

Classification	Architect - Engineer Planned		Planned by Others		Total Thousand Dollars
	Thousand Dollars	%	Thousand Dollars	%	
One- and two-family houses	49,302	43	66,576	57	115,878
All other building	<u>193,091</u>	85	<u>34,103</u>	15	<u>227,194</u>
Commercial	30,804	63	17,826	37	48,630
Industrial	27,197	100	.....	..	27,197
Educational	53,353	96	2,074	4	55,427
Hospitals and Institutions	16,720	88	2,213	12	18,933
Public buildings	13,298	85	2,417	15	15,715
Religious and Memorial	5,538	79	1,459	21	6,997
Social and Recreational	12,881	83	2,704	17	15,585
Apartments and Hotels	33,300	86	5,410	14	38,710
<b>TOTAL BUILDING</b>	<b>242,393</b>	<b>71</b>	<b>100,679</b>	<b>29</b>	<b>343,072</b>

# Building Cost Trends

AN APPROXIMATION to accuracy of construction cost data on materials and labor combined can only be obtained by determination of cost trends.

The basic data for the charts displayed on these two pages have been secured from E. H. Boeckh & Associates, Incorporated.

The United States average for each general type of construction for years 1926-1929 is used as the base period, or 100, because prices of both labor and materials showed greatest stability during these years.

Six general construction types are presented at the rate of two per month, because the quantities of the

different building materials and the amounts of the different classes of labor vary in each type of building. The six types to be shown appear in the following order:

1. Brick (Residence)
2. Steel (Commercial and Factory Buildings)
3. Frame (Residence)

**CONSTRUCTION COST INDEX** U. S. average, including materials and labor, for 1926-1929 equals 100.

## BRICK AND CONCRETE BUILDINGS

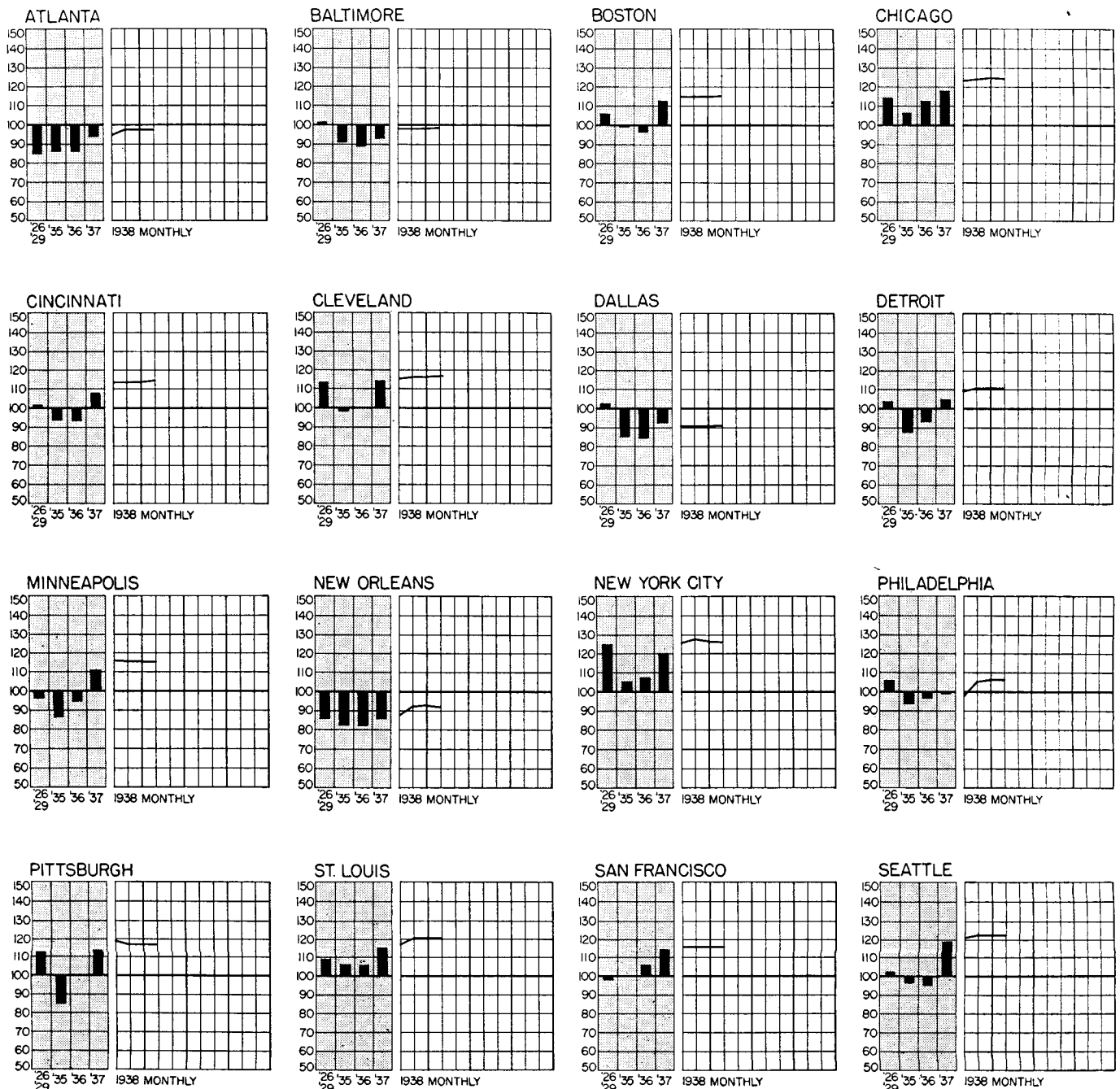

4. Brick and Wood (Apartments, Hotels, Office, Commercial and Factory Buildings)
5. Brick and Concrete (Apartments, Hotels, Office, Commercial and Factory Buildings)
6. Brick and Steel (Apartments, Hotels, Office, Commercial and Factory Buildings)

Sixteen representative but widely scattered cities are shown monthly for each type displayed because material prices and labor rates are different in the various localities and do not change at the same time in

all cities, nor in the same degree.

The index numbers indicate the relationship of the current or reproduction cost of a building at any given time, in any given place, to the 1926-1929 United States average cost for an identical building.

The plotted data provide a quick and efficient method of expressing construction cost comparisons in percentages; or, in other words, the difference between any two index numbers divided by one of the two numbers represents the percentage

difference. For example, if the current month's index number for city "A" is 110 and the corresponding index number for city "B" is 95, it can be said that construction costs in city "A" are approximately 16% higher than in city "B", ( $\frac{110-95}{95} = 16\%$ ). These same index

numbers also permit the statement that construction costs in city "B" are approximately 14% below city "A", ( $\frac{110-95}{110} = 14\%$ ).

### BRICK AND STEEL BUILDINGS

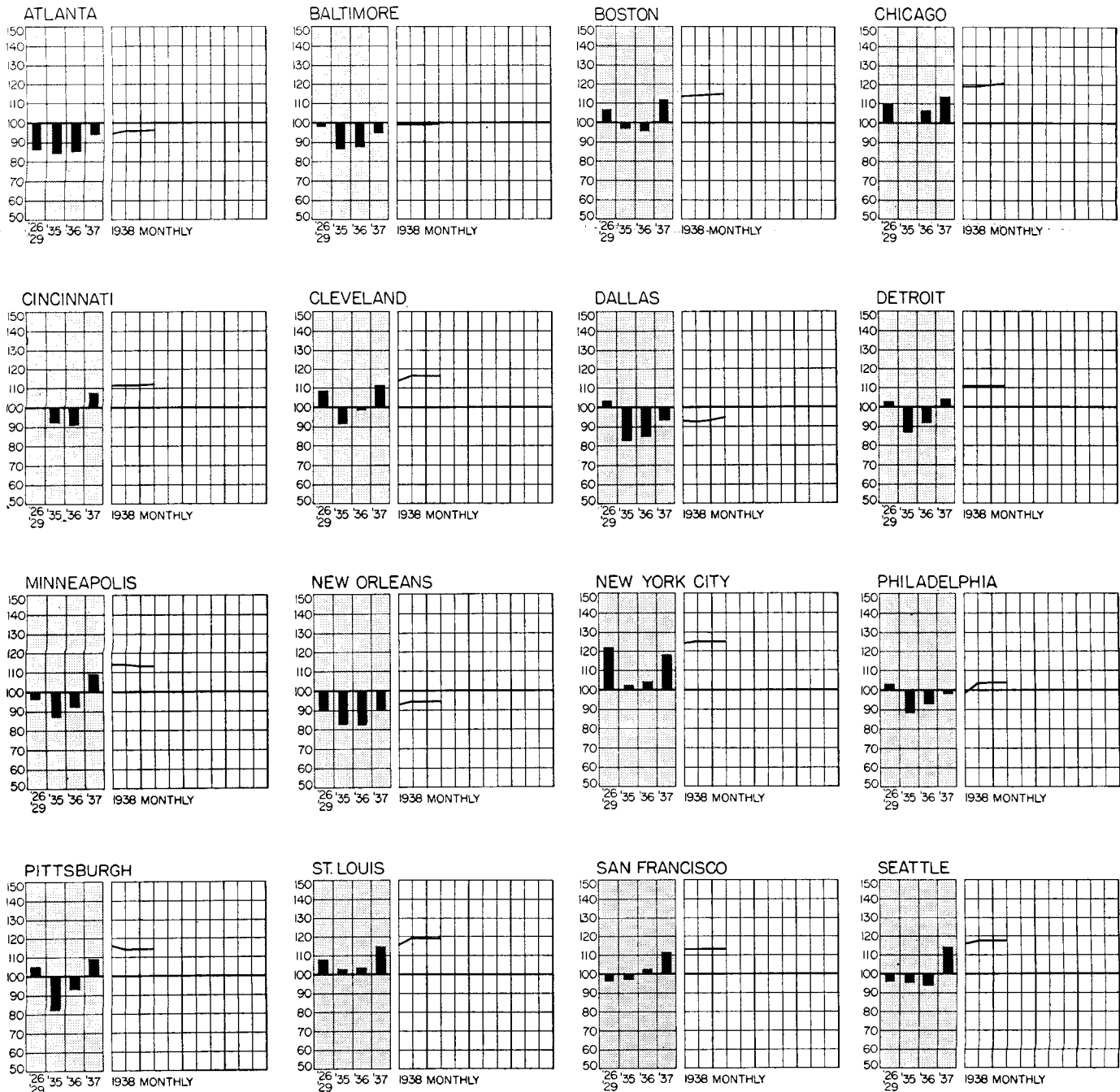

# Reviews of New Books

**THE CULTURE OF CITIES.** By Lewis Mumford. Harcourt, Brace & Company, New York, 1938. Illustrations from photographs. Includes bibliography and index. 6 1/4" x 9 1/2". 596 pages. Price, \$5.

THIS BOOK carries forward the story of the development of the physical patterns evolved in historic societies from medieval times to the present. Historically, these patterns have taken the form of cities. Thus, a city becomes the objective focus of large perspectives in time and space, an index to the social and historic forces which produced it. This interpretation, this description of the relation between motivating forces and their physical consequences (buildings, neighborhoods and regions, as well as cities) makes this book of some value to the designer.

The medieval cities, says Mumford, were first tiny "suburbs", huddled for "protection" in the shadow of the great castles of the warlike barons. With the revival of trade, improvements in technics and craftsmanship, and the increasing centralization of political control, there is a corresponding shift in power from priest and feudal lord to merchant and artisan. The city becomes a stronghold of the rising middle class: at first it is designed primarily for defense; later the new commercial and industrial forces play a decisive part in its development.

For Mumford, this transition from medieval to "baroque" city is a shift from a pattern of relative order, however crude, to one of wide disorder; this because the baroque city is not at one with the changed social and economic activities which take place within it. And with the growing industrialization of urban life from the 10th century onward, this disparity becomes greater. Today, however, Mumford sees a new pattern emerging, based on the advanced technologies of our time: decentralization of industry, reintegration of town and country, the regional plan.

The defects of this book are probably inherent in its virtues: in fitting the facts of city development into a

coherent philosophic and historic structure, Mumford must choose those facts which are congruent with the structure; those which are not, he must ignore or explain away as minor deviations—"dead forms" or "embryonic" new ones, as the situation requires; apparent discrepancies become proof of the continuity and interrelatedness of all history and culture.

The style of the book is lush, "literary", and replete with epigram: sometimes, too, just a little verbose. And the nobility of sentiment sustained throughout may be, for some, a little obtrusive.

But these are relatively small blemishes. The designer will not often find as full or as coherent an explanation of the impulsions which determine ultimately his position in society and his function in production.

## **PROBLEMS AFFECTING HOUSING.**

Prepared by The Land Utilization Committee of The New York Building Congress, Inc. March 1938. 6" x 9 1/4". 39 pages. Price, \$0.25.

TERSE, INCLUSIVE and well presented, this paper-cover booklet is a report of an important committee of the New York Building Congress, of which Arthur C. Holden is chairman. The stated objective of the Land Utilization Committee's work has been "to clarify the attitude of industry toward the obstacles which have appeared to impede housing progress." This report shows progress toward that goal. Though in no sense an answer to the "housing problem", it does constitute a forceful statement of basic considerations which affect housing and indicates, to a degree, the manifold and involved relationships which complicate the "housing problem" and make it so difficult to solve.

Obviously, there is no one method of meeting the need for housing that can be regarded as generally adequate or even applicable to every situation. Mr. Holden's Committee recognizes this fact and contents itself with broad generalities to outline an approach and point a direc-

tion for action. Thus the report is more a check list of problems that bear on housing than it is a statement of how any of them may be solved. And to the extent that this can clarify the designer's thinking on an extremely complicated subject, "Problems Affecting Housing" is a valuable little document.

## **PLAN YOUR HOUSE TO SUIT YOURSELF.**

By Tyler Stewart Rogers. Charles Scribner's Sons, New York, 1938. 7 1/2" x 9 1/2". 282 pages. Illustrated with diagrams and line drawings. Price, \$3.50.

FEW BOOKS exist which give the layman really useful information or practical ideas on residential design. Of these, even fewer offer anything of informative value to the architect. Nor can the majority be recommended by the architect to his client as an aid to each in developing the house that will suit them both.

In view of this, Mr. Rogers' book is an unusual one. For the potential home owner it outlines clearly the more important aspects of good building practice and discusses the various ways by which a house may be acquired. The book also makes available a great deal of specific information regarding space layout, various types of materials and equipment and the general business relationships which must be established and maintained throughout the building project.

One of the most valuable parts of the book deals with the approach to planning and the actual development of the plan. Mr. Rogers emphasizes the fact that houses grow—or should grow—from living needs. He discusses needs in some detail, shows how to provide for them and, for the reader's convenience, includes a series of well-considered check lists so that needs can be charted as a first step toward efficiency in design.

Architects will find this book much above the average of its type, for the author has long been associated with the technicalities of residential planning, equipment and construction. Some readers may resent his some-

*(Continued on page 200)*



# Trend Notes on a Building World

By CORRELATOR

Each month these pages note significant facts and fancies in the realm of design and in the fields of materials, equipment and services. In such brief highlights are reflected the successive advances of the building world.

A NEW METHOD for controlling the operation of gates or garage doors from a moving automobile has been perfected by the Selectron Co. of Los Angeles. The car is fitted with a device that creates a magnetic field at the push of a button. This, in turn, actuates an electrical gadget encased in concrete and buried in the driveway. As the car moves over it, the garage lights go on and a motor-driven gear opens the doors. In the garage another button turns off lights and closes doors. To operate gates in a driveway, units are buried on both sides. As your car passes over, press the button and the gates open. Pass through, press the button again and the gates close securely behind you—it's that simple!

THE SAME SORT OF THING hailed as a "boon to women" is the Magnetic Door Operator manufactured by the Stanley Company of New Britain, Conn. This differs only in mechanical detail from the other; both should be good for an owner's blood pressure in bad weather.

RADIATORS of dark colors emit more heat than the light-colored ones. But color does not affect the consumption of fuel, according to Allen J. Johnson of the Anthracite Industries Laboratory. Reason is that radiator efficiency does not materially influence amount of fuel necessary for adequate heating.

NOTE FOR MODERNIZERS: The Refractories Division of the Babcock & Wilcox Co. of New York is making a precast lightweight combustion chamber for oil burners. It is particularly adaptable to conversion jobs, for it can be passed through boiler doors and easily fitted in place.

RESEARCH MEN at the General Electric air-conditioning laboratory have doped out an oil burner of a new type. It allows the flame to be tailored to fit the combustion chamber, thereby providing greater operating efficiency.

A NEW OIL BURNER has been made available by the Iron Fireman Manufacturing Co.—the first noncoal-firing product sponsored by this company.

A NEW TYPE OF SERVICE LIFT has been designed by John W. Kiesling & Son of New York. It's called "Electric-waiter", has a capacity up to 2,000 lbs., and fills the gap between the dumbwaiter with a maximum load of 500 lbs. and the heavier-duty elevator.

"SNUGGER" is a little gadget that the manufacturers think is a complete answer to the cupboard door-latch problem. The Casement Hardware Co. which produces it declares it makes even warped doors behave—all because of a spring-operated finger and an odd-shaped hook.

IT'S JUST A STEP from cabinet latches to a new heavy-duty steel door that the Kinneer Manufacturing Co. has recently announced. Known as a "vertical sliding All-steel Rol-Top Door", it is designed as a hand-operated unit for industrial and commercial installations.

A DRY TYPE AIR FILTER that is flame-resisting has been announced by the Staynew Filter Corp. Though not completely fireproof, "Wire-Klad", the new unit, meets provisions of Section 150 of the National Board of Fire Underwriters, Pamphlet 90.

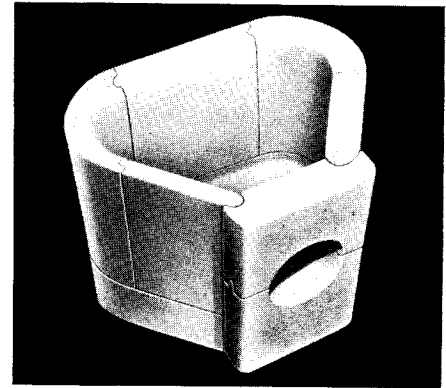

Prefab combustion chamber

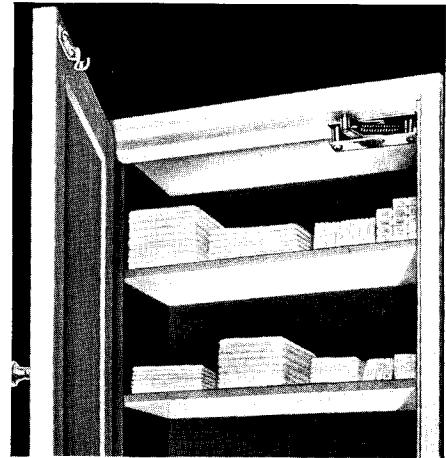

Cupboard door gadget

A HOUSE HEATING system that American Radiator Company hails as new and calls the "Arco Thermo System" has recently been announced. It's a forced-circulation, warm-water arrangement for automatic firing with coal, oil or gas. Newness apparently comes from the room unit—a compact box recessed in the wall and containing a radiator and a fan driven by an air motor. The fan's adjustable and is said to give a positive circulation of both heat and air.



Called "jalousie" in France; curved Venetian blinds of aluminum

## CONTROLLING LIGHT

SEEING STANDARDS set up by research engineers are finally beginning to be taken seriously by building owners and designers—aided and abetted, of course, by progressive manufacturers. Visual comfort implies control of both natural and artificial illumination to avoid various types of eye-strain with resulting loss of working efficiency.

NATURAL LIGHT is being controlled by various types of Venetian blinds. Among these are wood and metal—even mats and curtains. The curved ones of aluminum are particularly efficient, apparently because they reflect and diffuse light, prevent glare. R. T. Griebing of the Aluminum Company of America says that Venetian blinds date back to Marco Polo, were originally bamboo curtains. Blinds of stone, iron and heavy woods have been discovered. And names include *persiane* (Italian), *gelosia* (also Italian), *celogia* (Spanish) and *jalousie* (both French and German). The last three mean *jealousy* in English; and Griebing says that this name for blinds may have come from the desire of people to guard their private lives jealously! Which is probably as good as any other explanation.

ARTIFICIAL ILLUMINATION is said to be most generally efficient when supplied by direct-indirect ceiling fixtures. The two accompanying cuts show what can be done. In the Central National Bank, lighting units—made by Edwin F. Guth Co.—produce about 30 footcandles of light on desk tops. Lighting in the Harvard Law Library is from G-E combination units. These are designed to produce approximately 24 footcandles on the tables and employ incandescent lamps and gas-filled tubes within the same fixture, a combination said to improve the quality of light while providing economy in desirable quantity.

CONTRAST THESE INSTALLATIONS with the lighting situation in the New York City schools as reported by Dr. Isidore Harry Goldberger of the Board of Education. Dr. Goldberger stated that about 65% of the school children work under poor light—in many cases far below the minimum 15-footcandles set by lighting engineers.

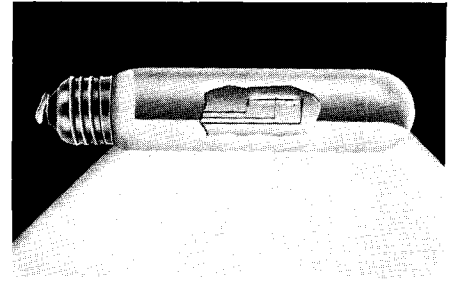

A NEW TUBULAR LAMP made in 25 and 40 watts, inside-silvered and gas-filled, to serve as its own reflector, has been recently perfected by the Birdseye Electric Co. The silvering concentrates the light in a beam and a spring contact base allows adjustment of beam direction.



THE SILVERED-BOWL LAMP, if used with the proper type of fixture, can produce extremely high intensities without glare. Witness the experimental installation at Nela Park, G-E headquarters, in which 500-watt lamps produced more than 1,000 footcandles of glareless light from a battery of 72 luminaires. Reflectors were specially treated polished aluminum.

BURGLAR PROTECTION that takes only 60 seconds to install is now available in the Teletouch Electric Eye Burglar Alarm, made by Teletouch Industries, Inc., of New York. It's a small portable box plugged into an ordinary service outlet. The "eye" faces toward a lamp and produces an invisible beam. Interruption of the beam starts the alarm.

(Continued on page 204)



Harvard University Law Library, Cambridge: 24-footcandles



Central National Bank, Des Moines, Iowa: 30-footcandles

# BUILDING TYPES



*Charles L. Bard*

**SCHOOLS — Elementary and Secondary**

ARCHITECTURAL  
RECORD

# SCHOOLS

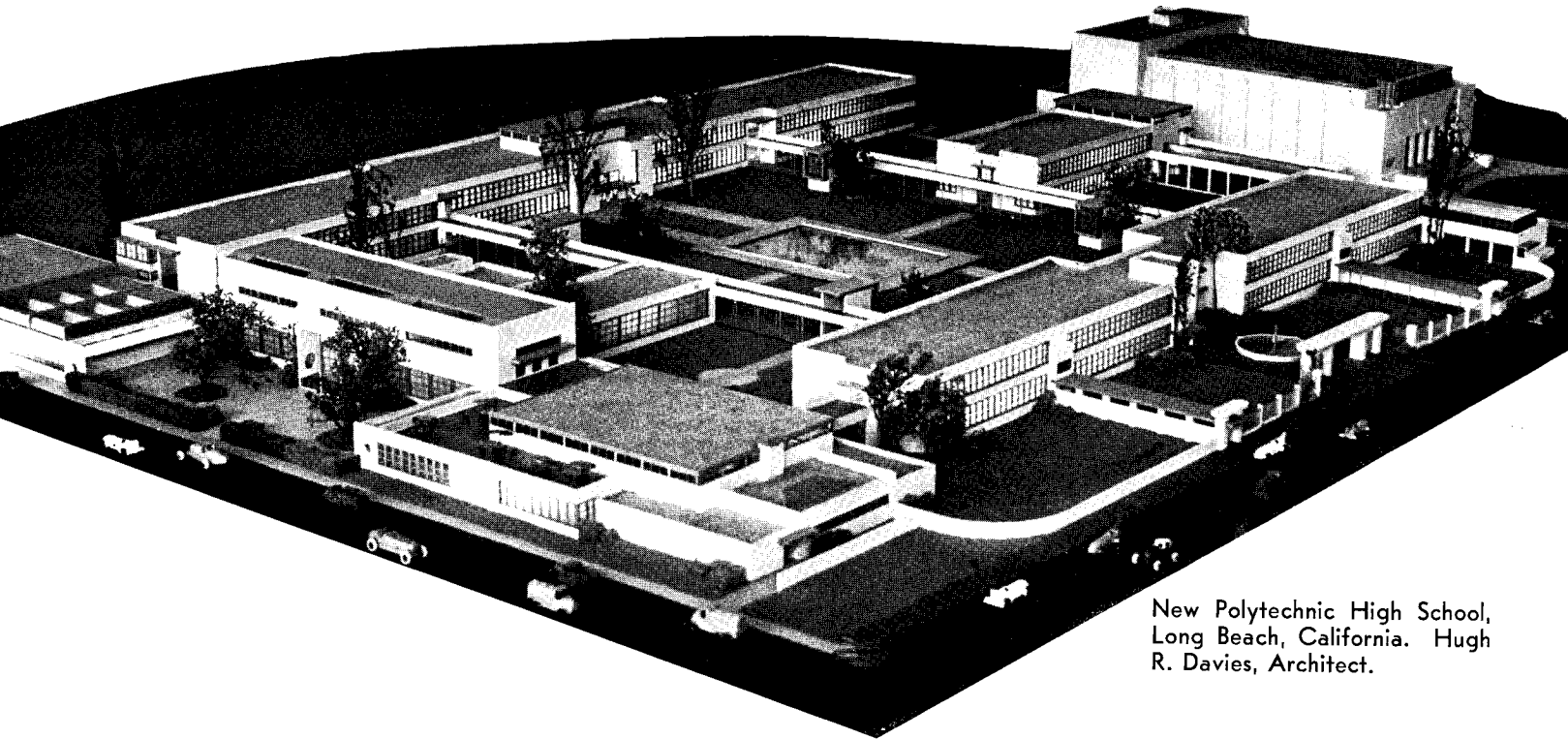

New Polytechnic High School,  
Long Beach, California. Hugh  
R. Davies, Architect.

**FUNCTIONAL PLANNING** of school buildings, during 20 years, has achieved very uneven results. Changing concepts of education, as well as the widely differing beliefs, restrictions, and recommendations of controlling authorities are responsible for this condition. Educators, especially those entrusted with building programs, realizing the state of flux which characterizes their needs, are generally agreed on one necessity—flexibility. The prime importance of this condition becomes even more apparent if one accepts the dictum of Arthur B. Moehlman, of the University of Michigan, that school buildings should be built to serve for fifty years. As an alternative, it is suggested that a policy of regulated obsolescence based on a much shorter useful lifetime would present a more economical and efficient school plant; materials and details of assembly would then be selected precisely for predetermined elimination and replacement.

## REFERENCES

In addition to specific references cited under the several elements of the study the following may be consulted:

*Architectural Record*. June, 1936. (A special school issue including a comprehensive bibliography)

*An Annotated Bibliography of 55 Outstanding Books on School and College Buildings and Allied Topics*. By William J. Lowry. *The American School and University*, Ed. IX, 1937.

*The School Plant*. Review of Educational Research, National Education Association. October, 1935. (Includes a bibliography)

*National Council on Schoolhouse Construction*. Proceedings of 15th annual meeting. October, 1937.

For manufacturers' specifications and details of equipment and materials for school buildings, see Sweet's Catalog Files. Five volumes, 1938.

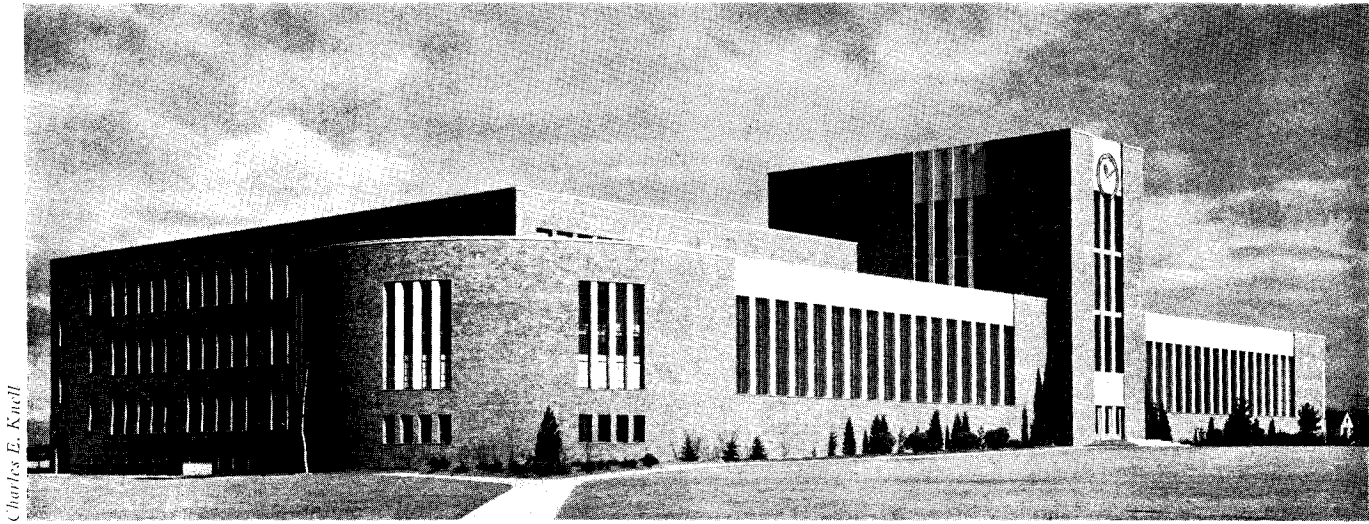

Charles E. Knell

**A SECONDARY SCHOOL—1,200 PUPILS**

WELLINGTON C. MEPHAM HIGH SCHOOL  
 BELLMORE, L. I., NEW YORK

FREDERIC P. WIEDERSUM  
 Architect

Plot Plan with Outdoor  
 Recreational Areas

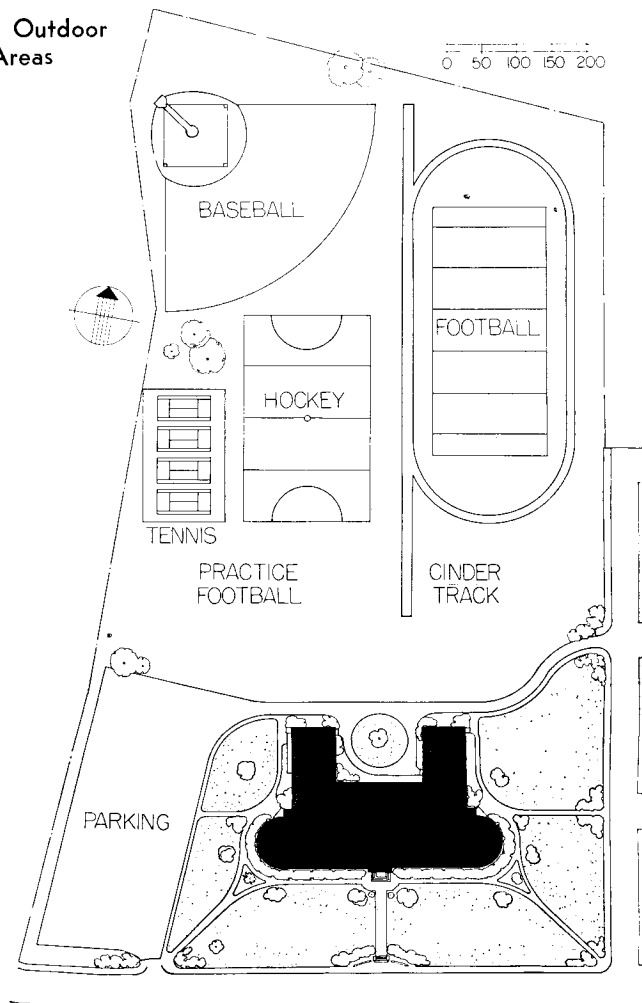

OCCUPYING A SITE of 20 acres, this junior and senior high school emphasizes its provision for community utilization. The auditorium and gymnasium are placed to the fore, either being reached directly from the main lobby separating the two elements.

# SECONDARY SCHOOL 1,200 PUPILS

WELLINGTON C. MEPHAM  
HIGH SCHOOL  
BELLMORE, L. I., NEW YORK

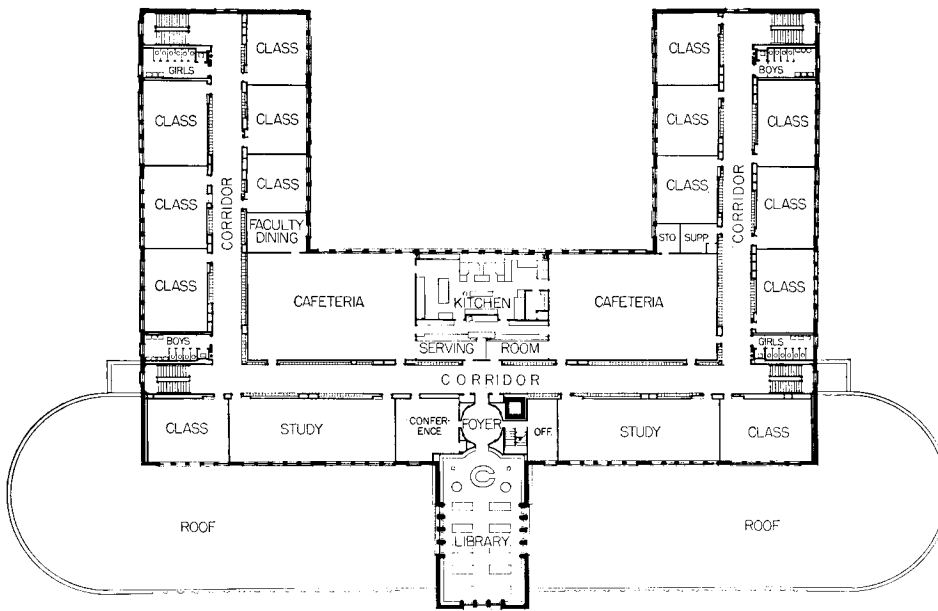

Third Floor

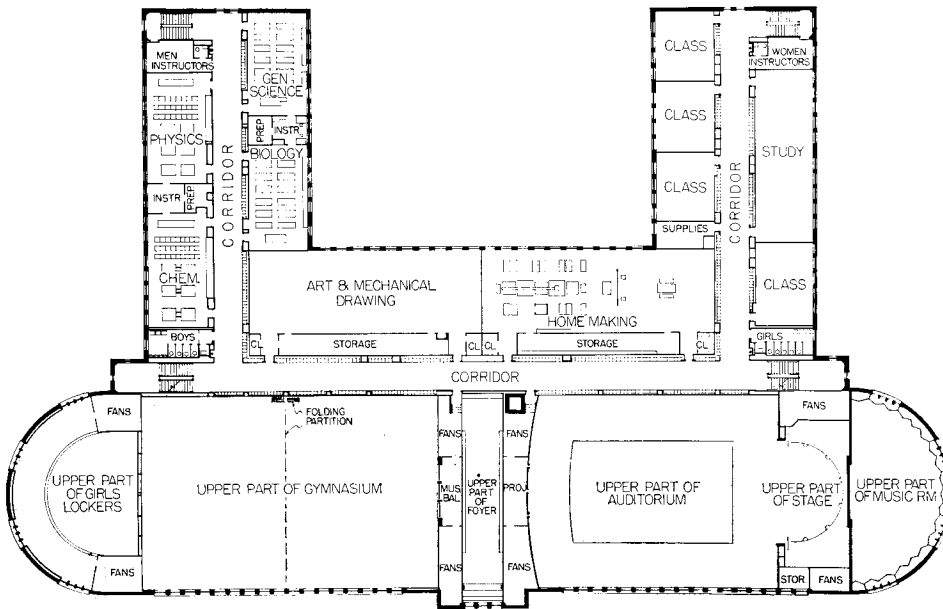

Second Floor

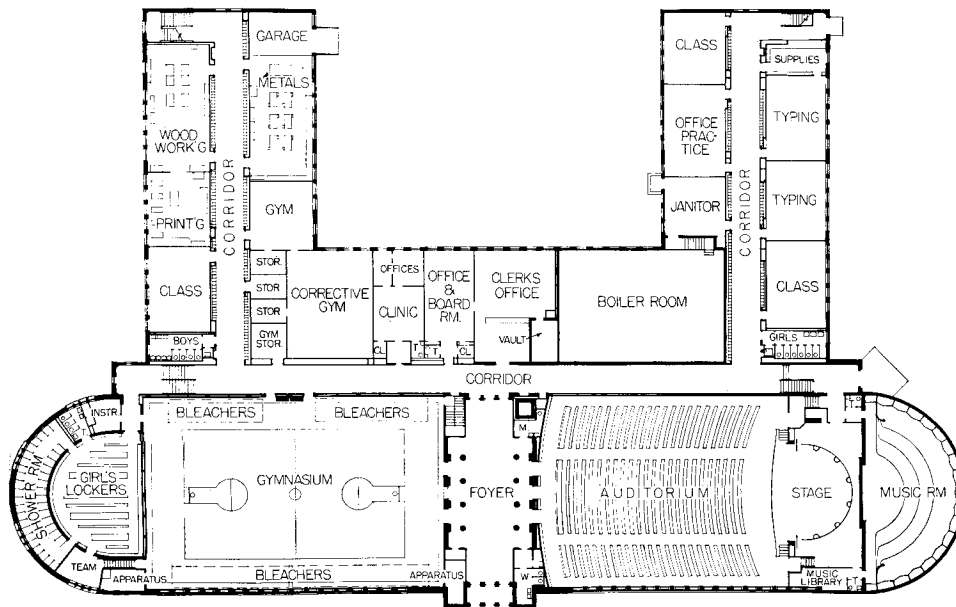

First Floor

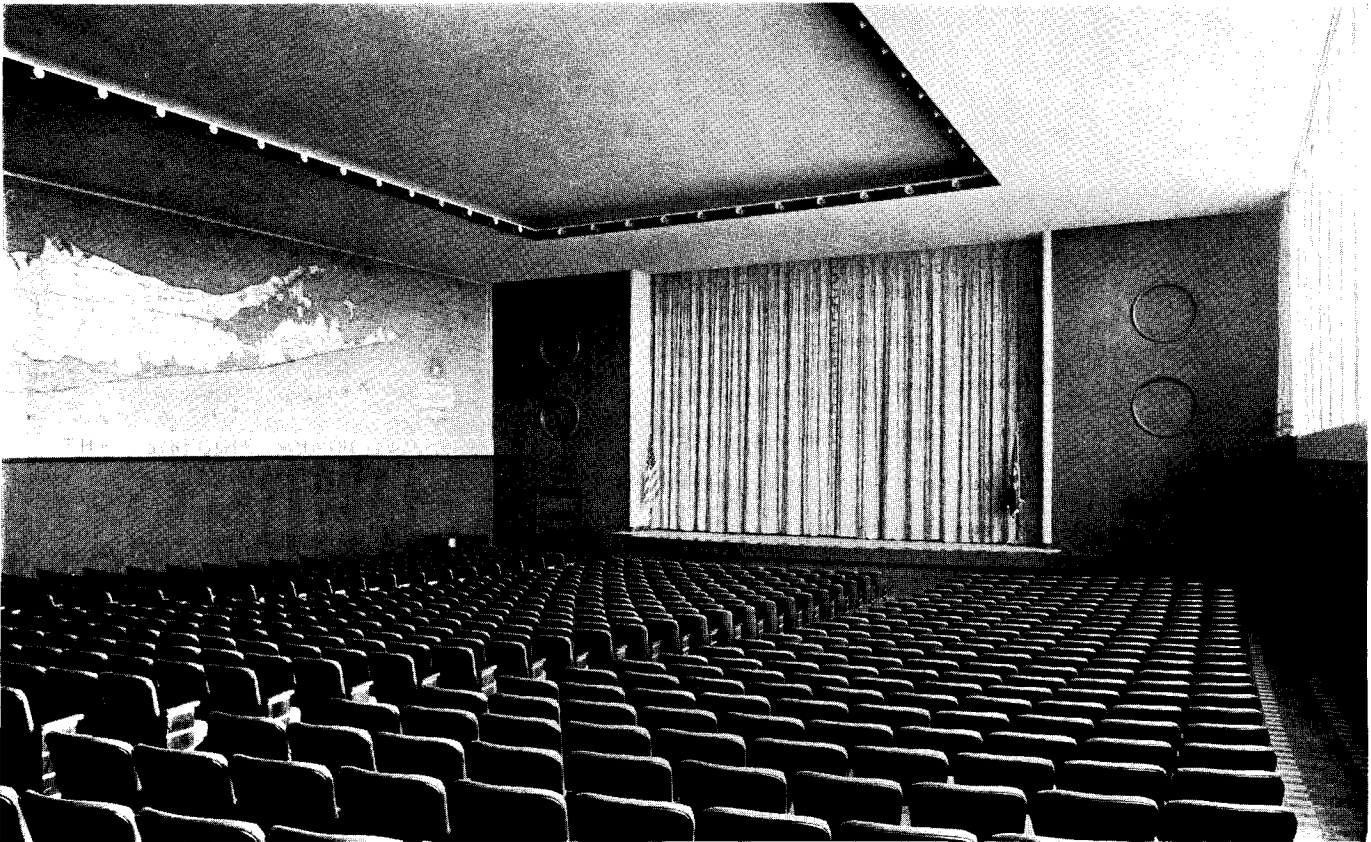
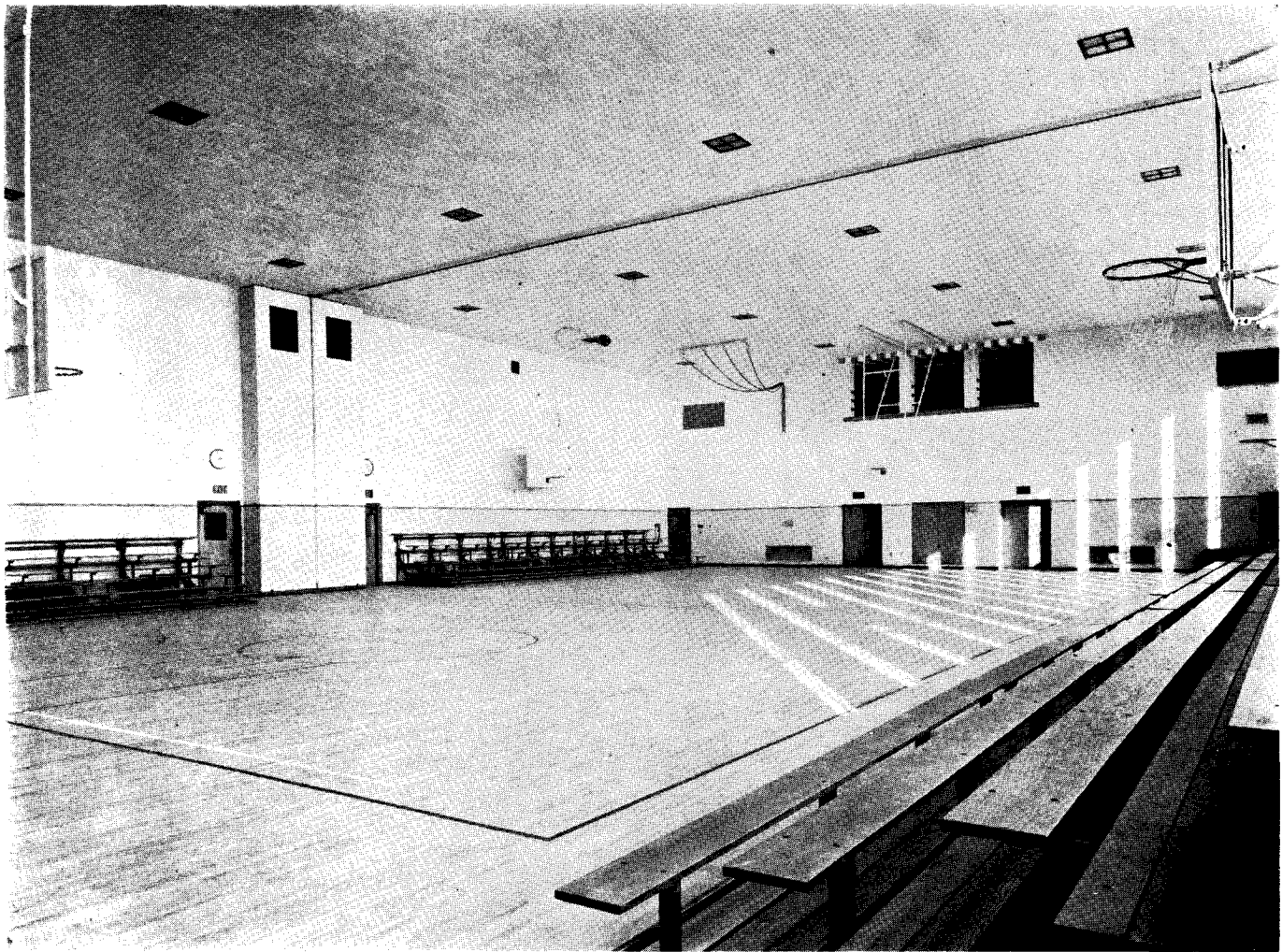

Gymnasium and Auditorium

Photos by Charles E. Kneill



Photos by Charles E. Kneill

**LIBRARY:** The engaged columns and all woodwork are of white oak, including the built-in bookshelves, which are placed in all walls to a height of 7 ft. Above the shelves the plaster walls are painted in four broad bands of light

yellows. Green rubber tile with white inserts is used for the floor, and the base is serpentine marble. Ventilating duct openings and cove lighting are provided in the ceiling centerpiece. The massive furniture is also of oak.



## SECONDARY SCHOOL 1,200 PUPILS

WELLINGTON C. MEPHAM  
HIGH SCHOOL  
BELLMORE, L. I., NEW YORK

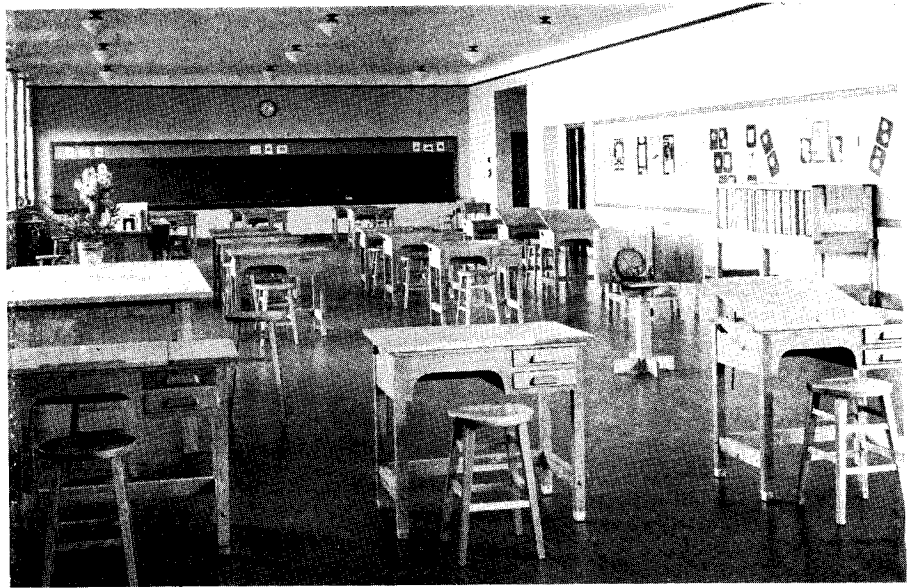

Art Class Area

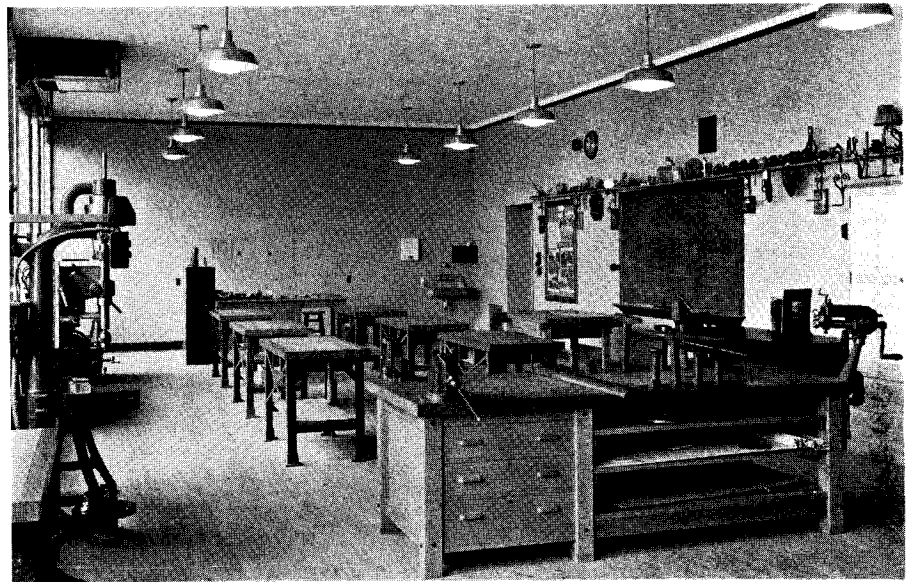

Carpenter Shop Area

### SCHEDULE OF EQUIPMENT AND MATERIALS

#### FOUNDATION

Reinforced concrete

#### STRUCTURE

Structural steel, Lehigh Structural Steel Co.; reinforced concrete slabs

#### EXTERIOR

**Walls:** "Lombard-Romanesque" face brick, Pearson Brick Co.; Indiana limestone span drels, mullions and trim

**Roof:** Built-up slag surface—20-year bonded, Philip Carey Co.

**Sash:** Steel casement, Hope's Windows, Inc.  
**Metalwork:** Aluminum entrance doors and vestibule lining, Progressive Bronze Co.

#### INTERIOR

**Walls:** Stair, corridor, cafeteria and gymnasium wainscot, glazed structural terra cotta, Federal Seaboard Terra Cotta Co.; terra-cotta block partitions

**Floors:** Maple strips in gymnasiums and shops, "Minwax" finish; cement finish in

basement; tile in toilets; terrazzo in corridors, locker and pupil toilet rooms; linoleum in classrooms and offices; rubber tile in library and board room, asphalt tile in laboratories, David E. Kennedy Co.

#### WATERPROOFING

Integral in all concrete below grade—"Dow Flake", Dow Chemical Co.; Larson Preformed Waterproofing Units in all exterior walls, Brisk Waterproofing Co.

#### HEATING

Low-pressure steam system, radiators, U. S. Radiator Corp.; "Kewanee" boilers; oil burners, Todd Combustion Equipment Co.; Sturtevant, unit-heater ventilators in all classrooms

#### VENTILATION

Mechanical air circulation in auditorium and gymnasiums

#### PLUMBING

Crane Co. fixtures; drinking fountains, Halsey W. Taylor Co.

#### ELECTRICAL

Lockers, Lyon Metal Products, Inc.; kitchen lobby, Sun-Ray Reflector Co.; conduit, General Electric Co.; Habshaw Cable & Wire Co.'s "Flame-Stop"

#### HARDWARE

General, Corbin; floor hinges, Oscar Rixson Co., Inc.; exit bolts, Van Duprin

#### EQUIPMENT

Lockers, Lyon Metal Products, Inc.; kitchen and cafeteria equipment, Nathan Straus-Duparquet; auditorium seating, American Seating Co.; other seating, L. I. Institutional Equipment Co.; gymnasium equipment, American Gymnasium Equipment Co.; sound and projection equipment, Commercial Radio Sound Corp.; phone, clock and bell system, International Business Machine Corp.; wood dividing partitions, American Car & Foundry Co.; vault door, Herring-Hall-Marvin Safe Co.

Cost: Structure, \$661,922; furnishings, \$70,338; landscaping, \$14,667

Charles L. Bard

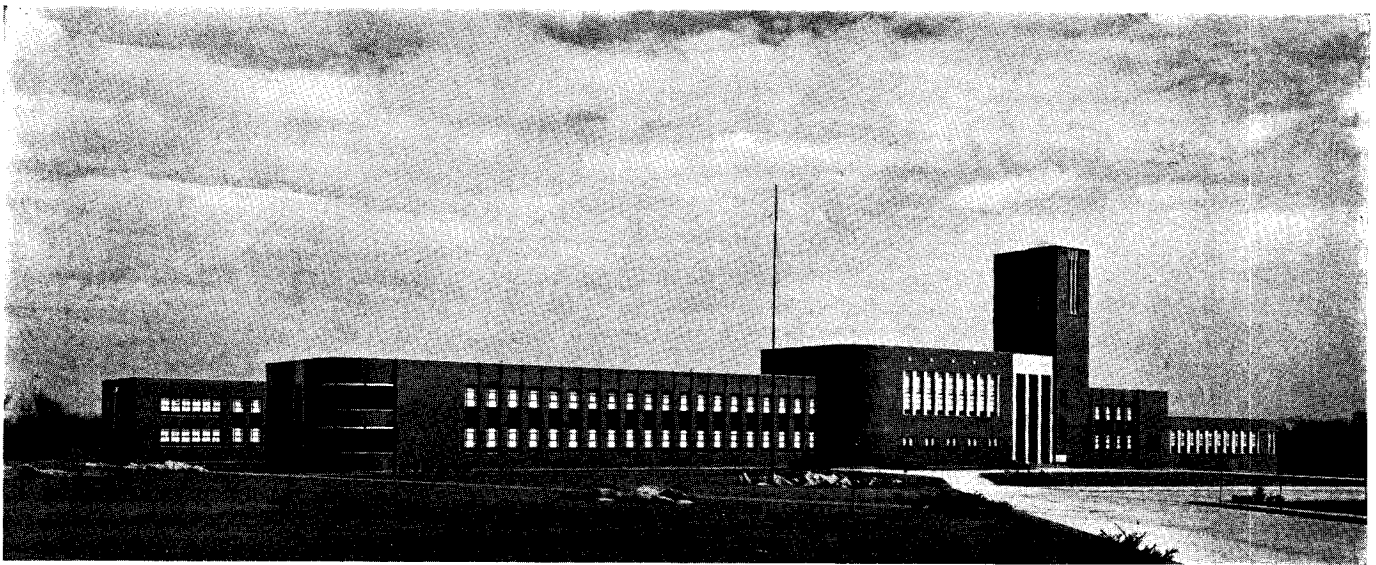

## A SECONDARY SCHOOL—2,500 PUPILS

J. P. McCASKEY HIGH SCHOOL  
LANCASTER, PENNSYLVANIA

HENRY Y. SHAUB  
Architect

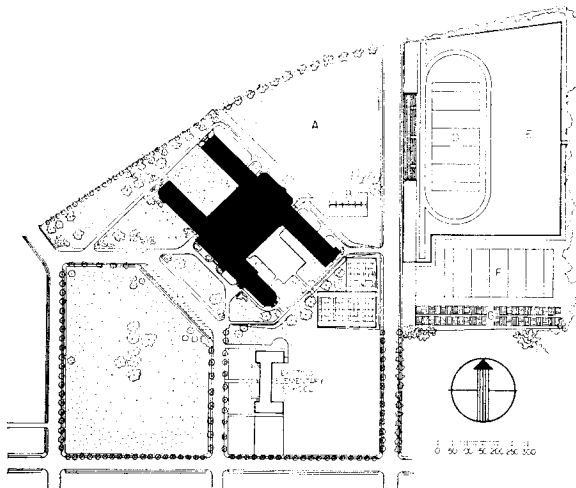

### Plot Plan

- |   |                                |   |                         |
|---|--------------------------------|---|-------------------------|
| A | General Play Area              | E | Intramural Sports Field |
| B | 12 Masonry Handball Courts     | F | Practice Football Field |
| C | 6 Macadam Tennis Courts        | G | Experimental Gardens    |
| D | Football Field; 1/4-Mile Track | H | Parking                 |

LOCATED JUST within the city's corporate limits, the school plant occupies 35 acres, affording large lawn and play areas, used not only by the students but by the community at large. Wherever possible, rock outcroppings were not removed but developed as rock gardens. Frequent entrances provide convenient access to classes from any direction.

The "H" plan adopted was found to be relatively economical; it also made possible a segregation of various activities that might otherwise have interfered with each other. Thus, academic, commercial and science departments have been located in the left wing, shops, domestic science, music, etc., in the right wing, with auditorium and gymnasiums between. Outdoor gym classes use the paved court between shop and music elements. Girls' and boys' shower and locker rooms are in the basement on either side of the center section.

Structurally, the building is separated by expansion joints into six freestanding units: the central portion, the four wings and the tower.

A greater use is made of color in the interior than is customary in schools. All classrooms are designed to lessen eyestrain: walls are painted light green on the window side and front, light buff on the remaining two sides, with both colors darker-toned below the chair rail.

A complete system of communication has been installed, including: telephones in every room, a public address system reaching all rooms through speaker-microphones over which the central control panel in the administration office may broadcast programs from radio, phonograph records or its own microphones. The master clock signal is also transmitted through the speakers. Hook-up facilities for broadcasting from the school are also available.

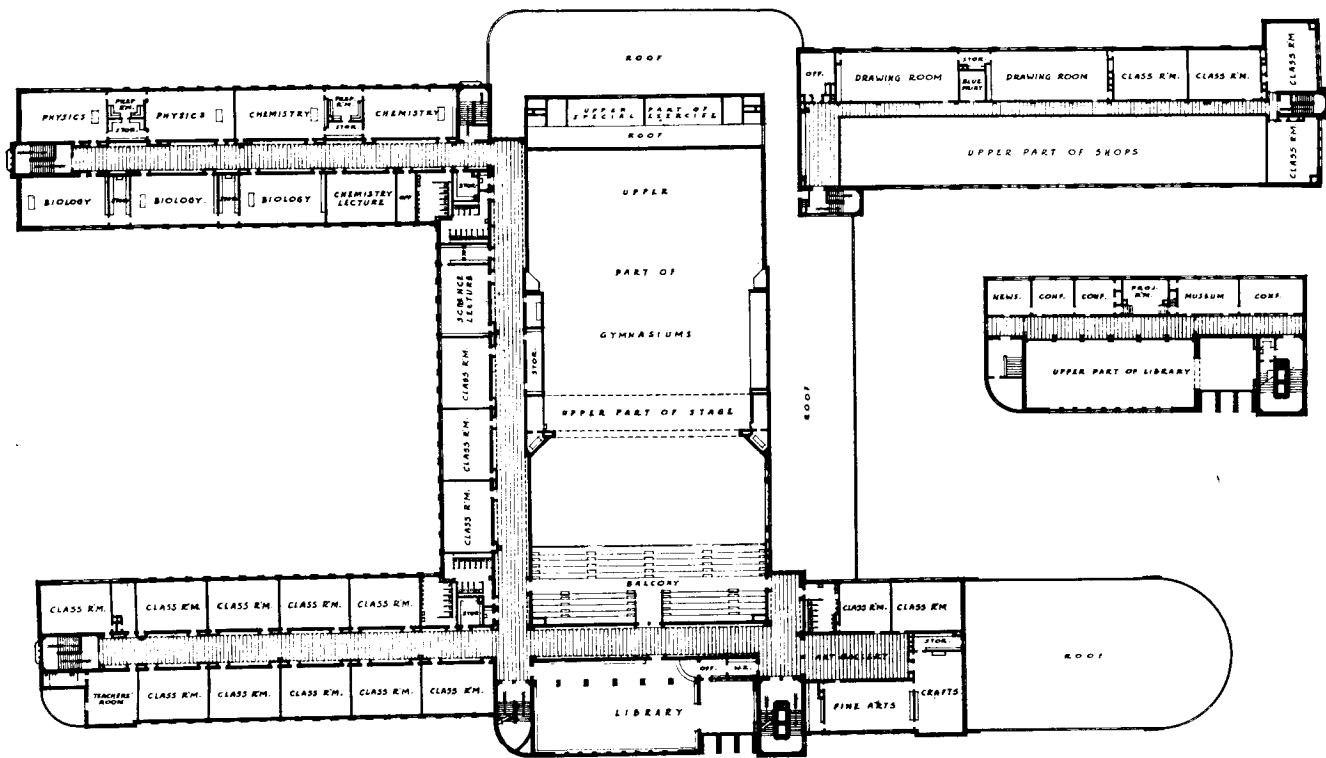

Second Floor

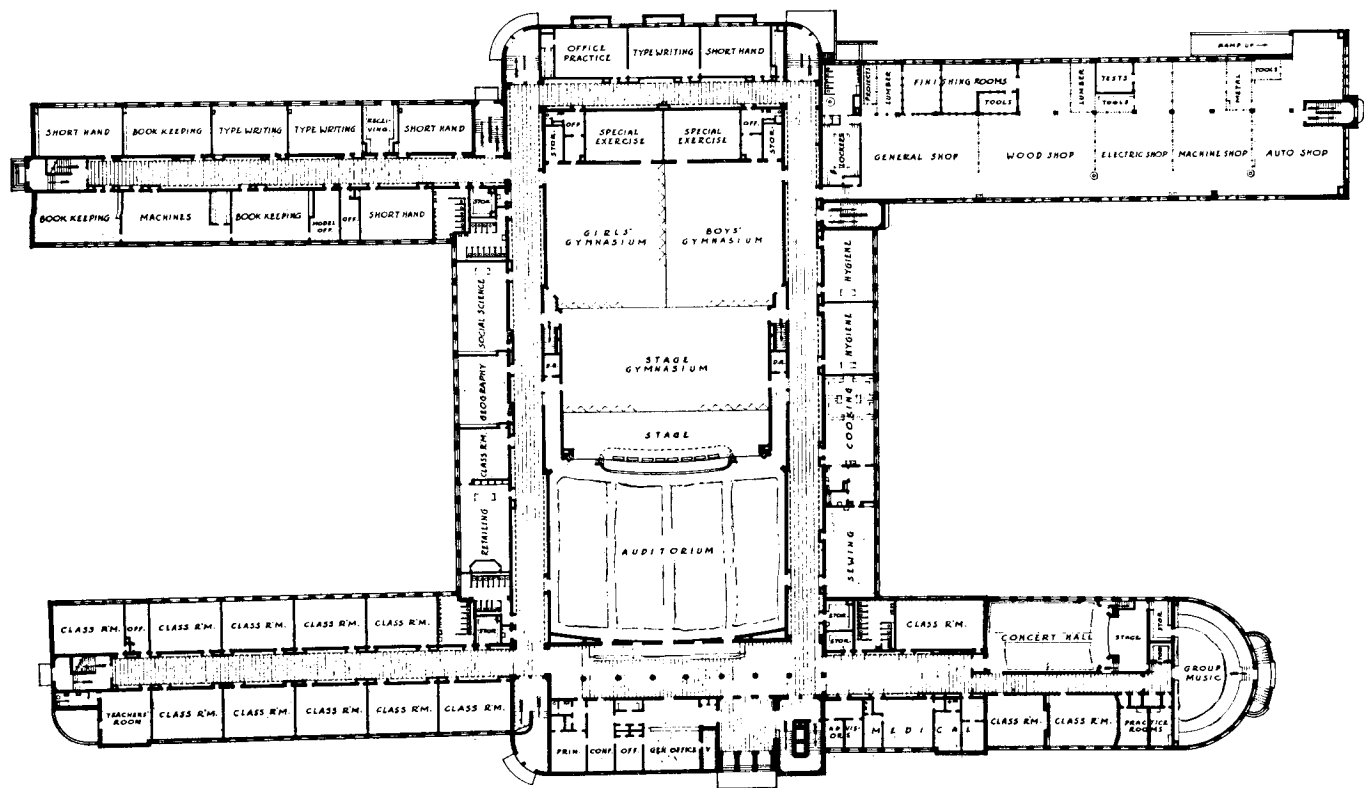

First Floor

**COSTS:** A total cost of \$1,170,753.17 represents building costs of \$981,142.60 for 4,580,500 cu. ft., or a unit cost of less than \$0.22 per cu. ft.—a per-pupil cost of less than \$400. Landscaping, including drives, walks, play areas, etc., amounted to \$65,008.57, while furnishings totaled \$124,602.

## SECONDARY SCHOOL 2,500 PUPILS

Photos by Charles L. Bird

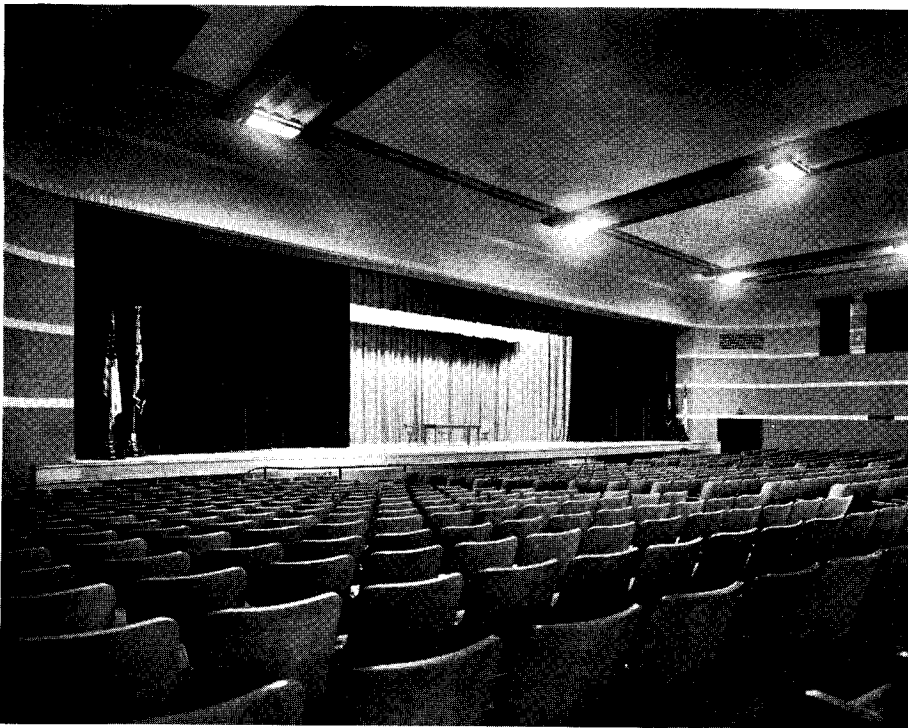

**AUDITORIUM:** Capacity: 1,500. Proscenium: 83-ft. opening. Finish: walls in varying shades of blue and white stripes; rear wall, cork. Ceiling: dark-blue beams and moldings on light-blue field; white cork panels; Holophane fixtures with bronze trim.

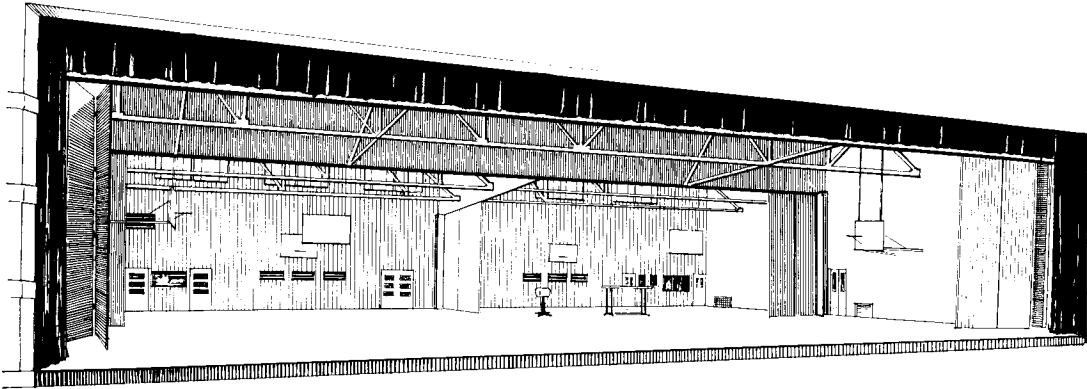

**GYMNASIUM:** Behind the cyclorama seen above. Folding partitions permit multiple use.

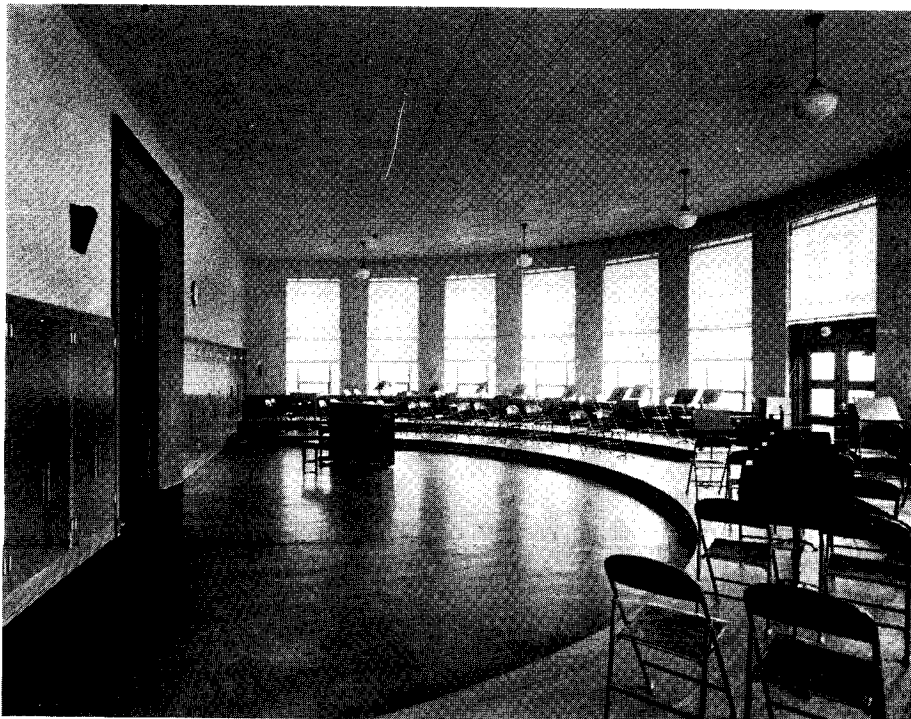

**MUSIC PRACTICE ROOM:** The built-in cabinets provide storage for band instruments of all shapes and sizes. An exit door allows direct travel to football fields and outdoor activity avoiding use of main corridors and attendant noise problem. Woodwork is of silver-tan oak, walls and ceiling of cream-colored cork.

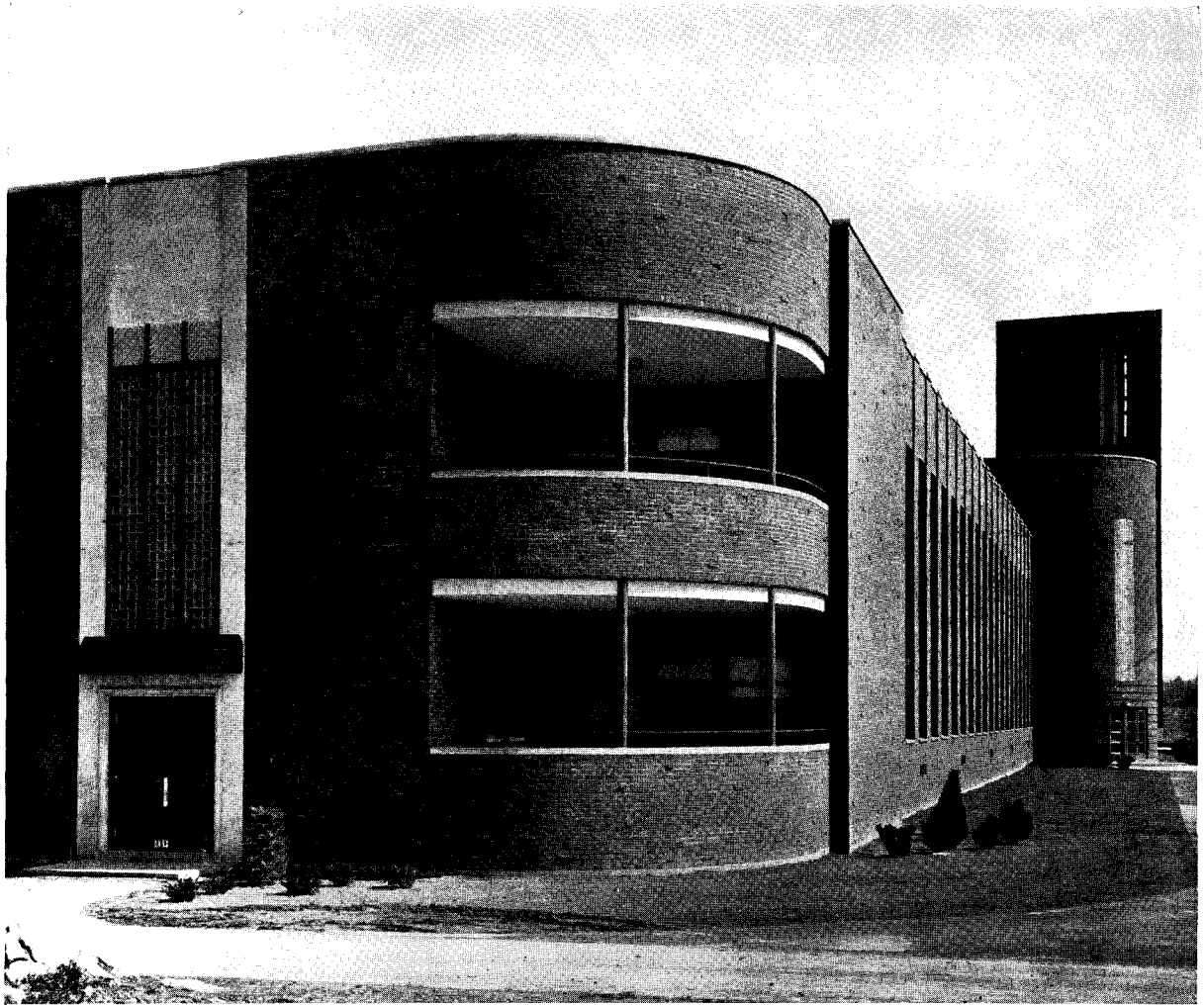

Private porches for the teachers' rest rooms—women's on first floor, men's on second



Interior of a teachers' rest room

## SECONDARY SCHOOL 2,500 PUPILS

Photos by Charles L. Burd

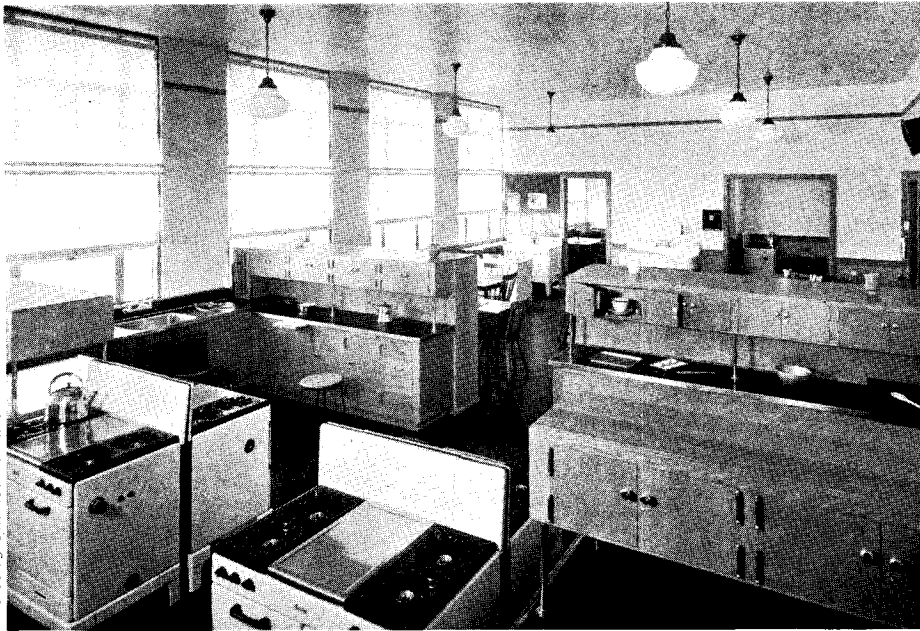

**COOKING ROOM:** Unit kitchens accommodate 16 pupils with 4 in each. A model apartment is included (seen through the opening) for instruction in homemaking.

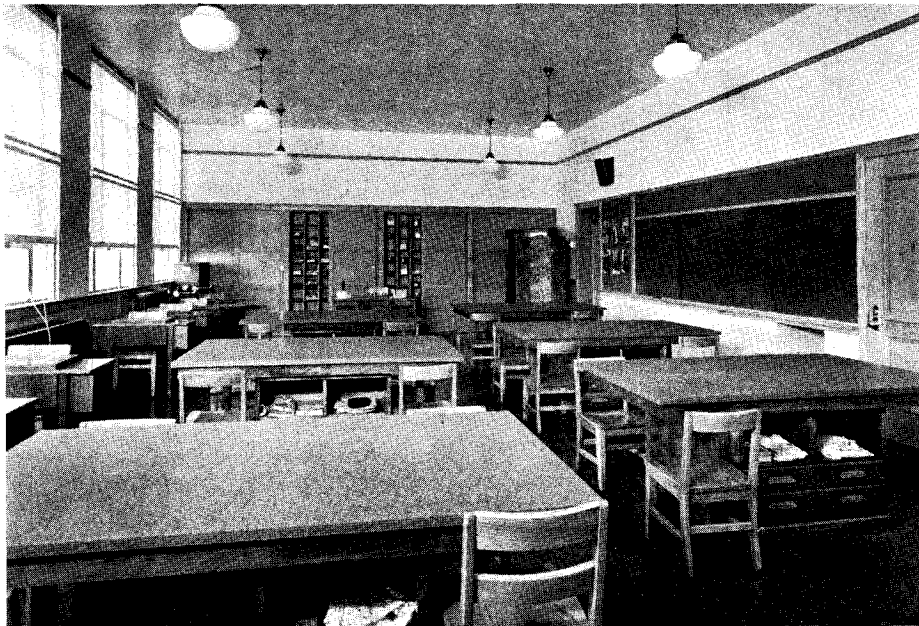

**SEWING ROOM:** Cabinets on far wall provide spaces for individual pupils' work. Ironing boards and sink are on opposite wall. Table tops are of pressed wood.

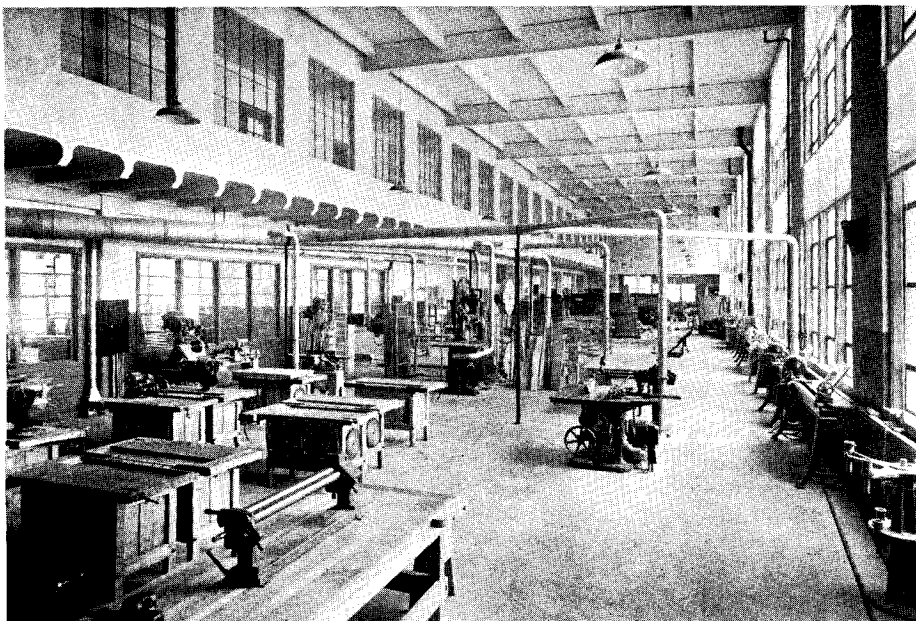

**SHOPS:** Various units are separated by wire-mesh partitions. Associated classrooms are placed on the balcony at left with supply and tool rooms under.

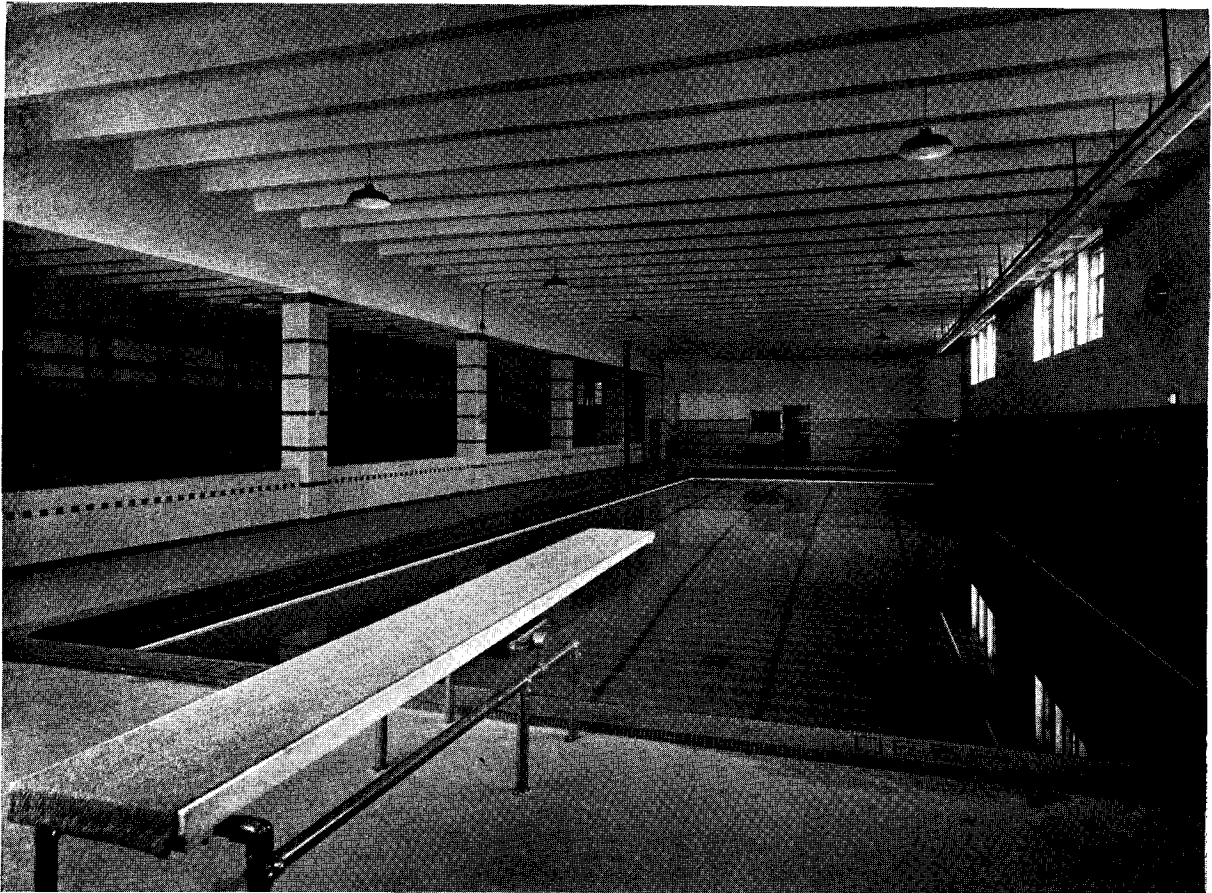

**SWIMMING POOL:** Size, 25 x 75 ft.; maximum depth, 9 ft. 6 in.; ceramic tile floor and wainscot—blue field, red trim. Doorway at far end leads to shower rooms, the larger opening to corridor.

## SCHEDULE OF EQUIPMENT AND MATERIALS

### FOUNDATIONS

Plain and reinforced concrete

### STRUCTURE

Wall-bearing; pan-system concrete floors and roofs, Concrete Steel Co., except structural steel roof construction over auditorium, gyms and shops

### EXTERIOR

**Walls:** Red face brick, Lancaster Brick Co.; mortar, colored and waterproofed with Master Builders mortarproofing; glass brick, Owens-Illinois Glass Co.

**Trim:** Granite on exterior steps, platforms and door sills; Indiana Limestone elsewhere

**Roof:** Built-up smooth surface asphalt composition, Philip Carey Co.

**Sash:** Steel-projected, Detroit Steel Products Co.

**Metalwork:** Stamped lead-coated copper on spandrels and marquees

### WATERPROOFING

Integral, Aquabar Mfg. Co.

### INTERIOR

**Walls:** Cinder concrete block for all bearing walls and for partitions in basement and shop areas; gypsum block elsewhere, Ebsary Gypsum Co., Inc.; plaster, U. S. Gypsum Co.; plaster bond, Truscon Laboratories; Linowal wainscot and frieze in corridors and foyer,

Armstrong Cork Co.; section fold partitions, J. G. Wilson Corp.

**Ceilings:** Acoustic cork in auditorium, music rooms, natatorium, foyer, Armstrong Cork Co.; plaster elsewhere.

**Floors:** Terrazzo in lobby and foyer; cork tile in library, Armstrong Cork Co.; maple in gymnasiums, Continental Car-Na-Var Corp. finish; tile floors in toilets, swimming pool and kitchen, Cambridge Tile Co.; colored and hardened concrete floors in basement and shops, Aquabar Floor Hardener; asphalt tile elsewhere, Armstrong Cork Co.

**Doors & Trim:** Exterior—hollow metal, Jamestown Metal Corp.; basement and stair towers—Kalamein, Empire Door Co.; elsewhere, wood

### HEATING

Low-pressure steam system; Pacific Steel Boiler Corp. boilers; Detroit Stoker Co. stokers; American Monorail Co. coal conveyors; Automatic temperature control, Johnson Service Co.; exposed radiators, Kohler; concealed radiators and specialties, Warren Webster & Co.; grilles, Hendrick Mfg. Co.; uni-vents, John J. Nesbitt, Inc.

### PLUMBING

Acid pipe, Duriron Co.; fixtures, Crane Co.; water pipes, Reading Iron Works; roof, floor drains and swimming pool fittings, Josam

Mfg. Co.; wash fountains, Bradley Wash Fountain Co.

### ELECTRICAL

Clock, program, telephone and radio systems, Graybar Electric Co.; emergency lighting, Kohler; fire alarm system, American District Telegraph Co.; lighting fixtures, Wakefield Mfg. Co., Murlin Mfg. Co.; rigid conduit, Garland Mfg. Co.; wire, Collier Wire Co.

### HARDWARE

Sargent Hardware Co.; panic hardware, Vonnequt Hardware Co.

### EQUIPMENT

Laboratory equipment and auditorium seating, Southern Desk Co.; portable bleachers, Corry Metal Corp.; window shades, Columbia Mills, Inc.; vocational equipment, York Machine & Supply Co., Swind Machinery Co.; kitchen and cafeteria equipment, W. F. Dougherty & Sons and John E. Sjoström Co.; gymnasium equipment, Narragansett Machine Co.; stage equipment, Kuckuck Studios, Lee Lash Studios; asbestos curtain, Tiffin Scenic Studios; projection equipment, Williams, Brown & Earle; blackboards, Natural Slate Blackboard Co.; incinerator, Kerner Incinerator Co.; vault door, York Safe & Lock Co.; lockers, Berger Mfg. Co.

### GLAZING

Glass, Pittsburgh Plate Glass Co.

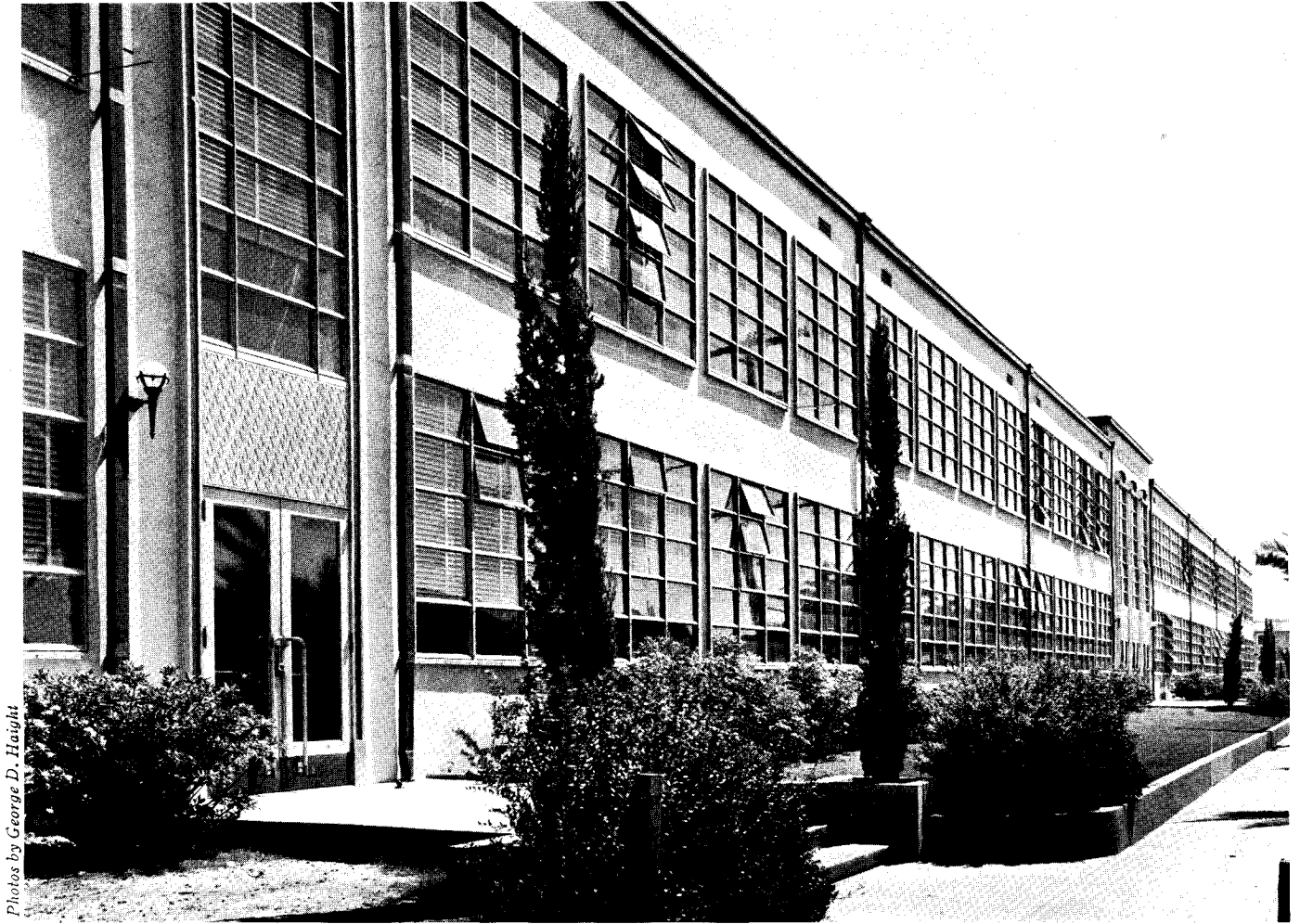

Photos by George D. Haight

## A SECONDARY SCHOOL—1,100 PUPILS

BENJAMIN FRANKLIN JUNIOR HIGH SCHOOL  
LONG BEACH, CALIFORNIA

GEORGE DORNER RIDDLE  
Architect

LAWRENCE J. WALLER  
Structural Engineer

HOMER FISHER  
Mechanical Engineer

IN THE DESIGN of Benjamin Franklin Junior High School, as in a majority of the buildings in the California earthquake rehabilitation program, a low center of gravity was obtained by constructing the first floor on a concrete slab at grade. This also reduced foundation sizes since all first-floor loads were supported directly on fill and not distributed to the foundations. A rigid steel frame was decided upon to permit adequate window areas without undesirable exterior wall areas usual in typical wall-bearing structures.

Exterior wall columns were placed with the webs parallel to the wall, while corridor columns were placed with webs normal to exterior wall. This arrangement made possible a most economical distribution of both transverse and longitudinal forces, but made necessary an efficient and economical horizontal diaphragm in the plane

of second floor and roof. Steel decking, electrically welded, was selected to provide the desired lateral rigidity.

Light steel trusses were used for roof construction and spandrels of exterior walls. The remainder of the structural framework consists principally of three sizes of "wide-flange" beam sections which are utilized both as columns and beams. All gravity loads are carried on riveted connections, while lateral stresses are transmitted through electrically welded connections.

Original plans called for an auditorium to seat 650 persons and a complete physical education unit of which only the boys' and girls' shower and locker rooms have been built. Assembly accommodations for 500 persons have been provided by the combination auditorium-lunchroom.



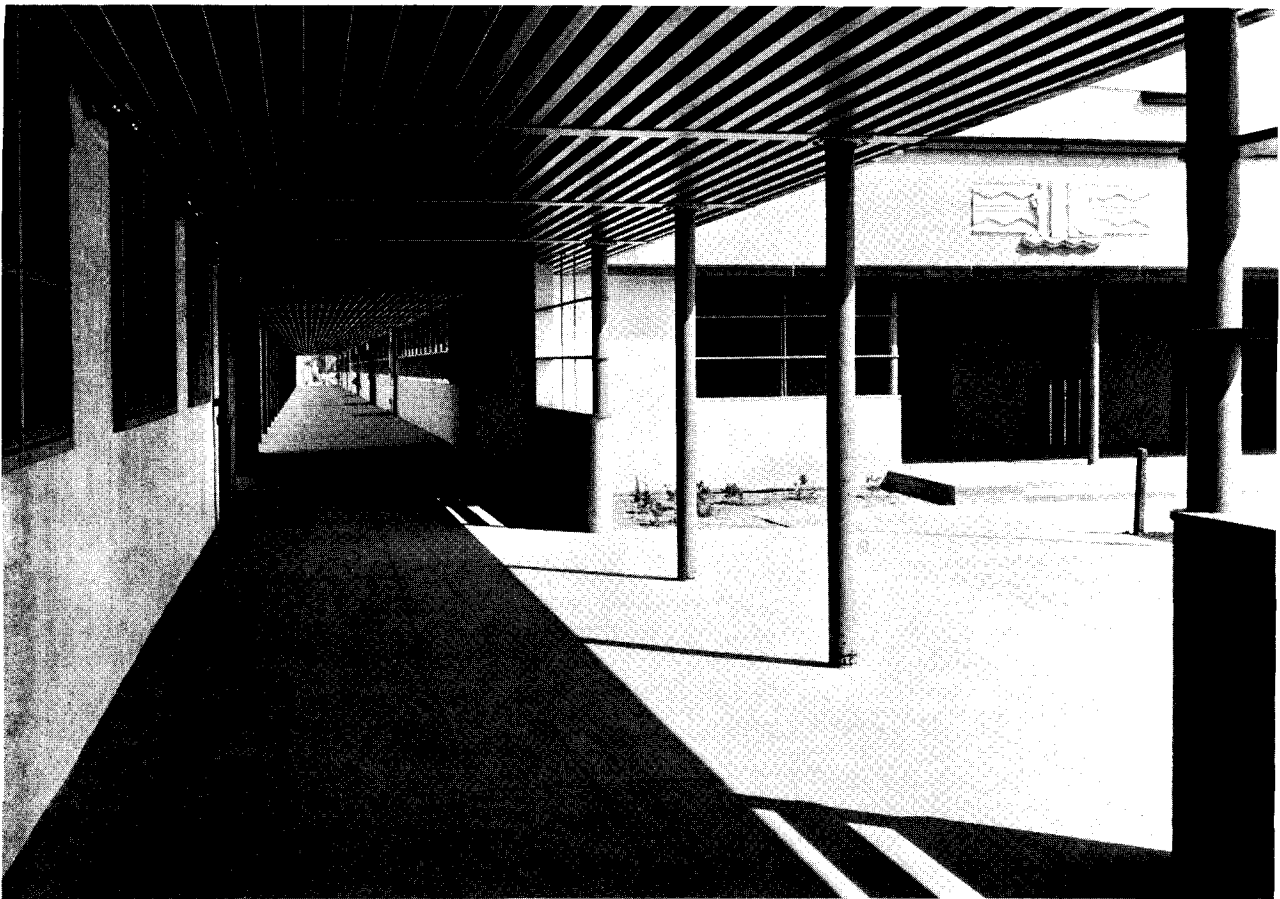

Colonnade of Practical Arts Building and Entrance to Auditorium

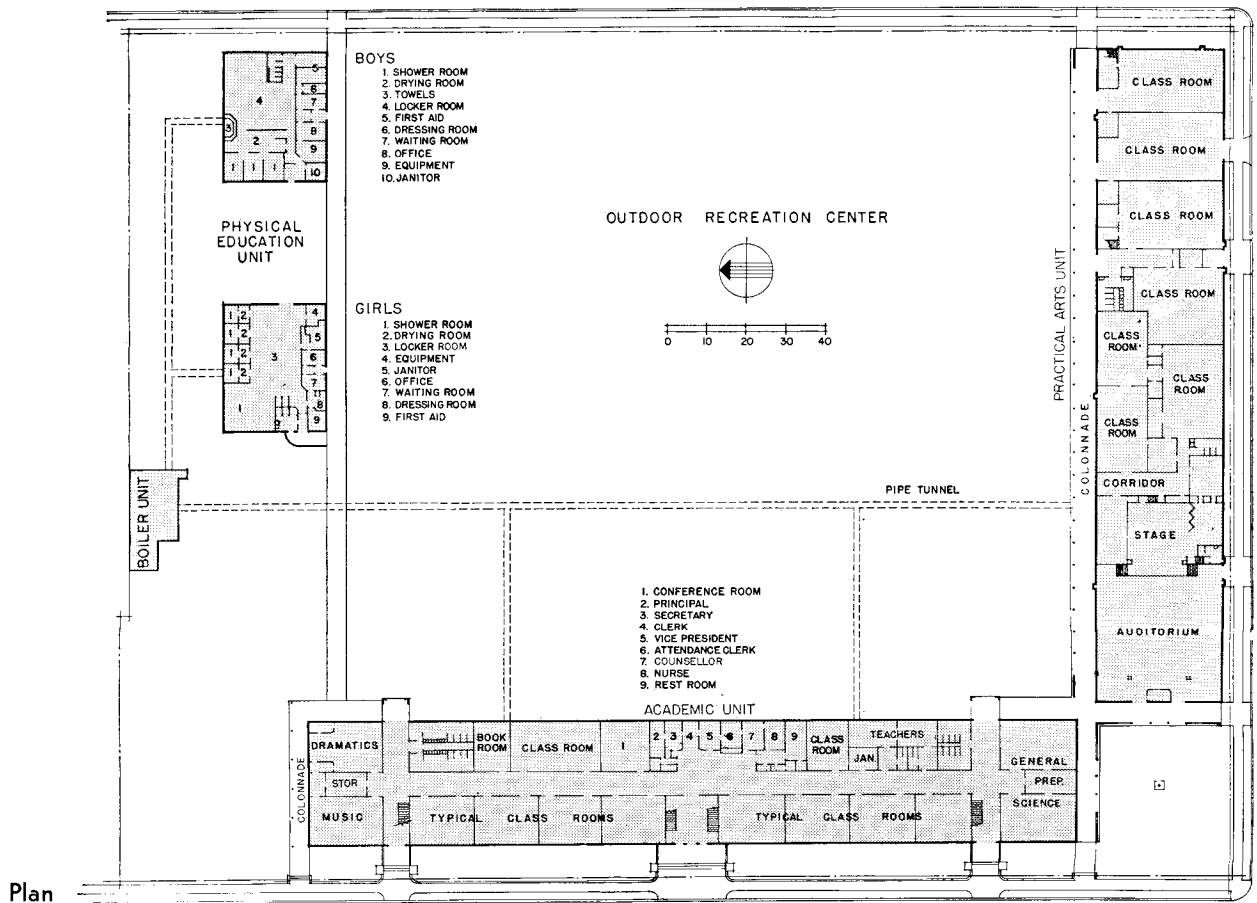

Plan

Photos by George D. Haight.

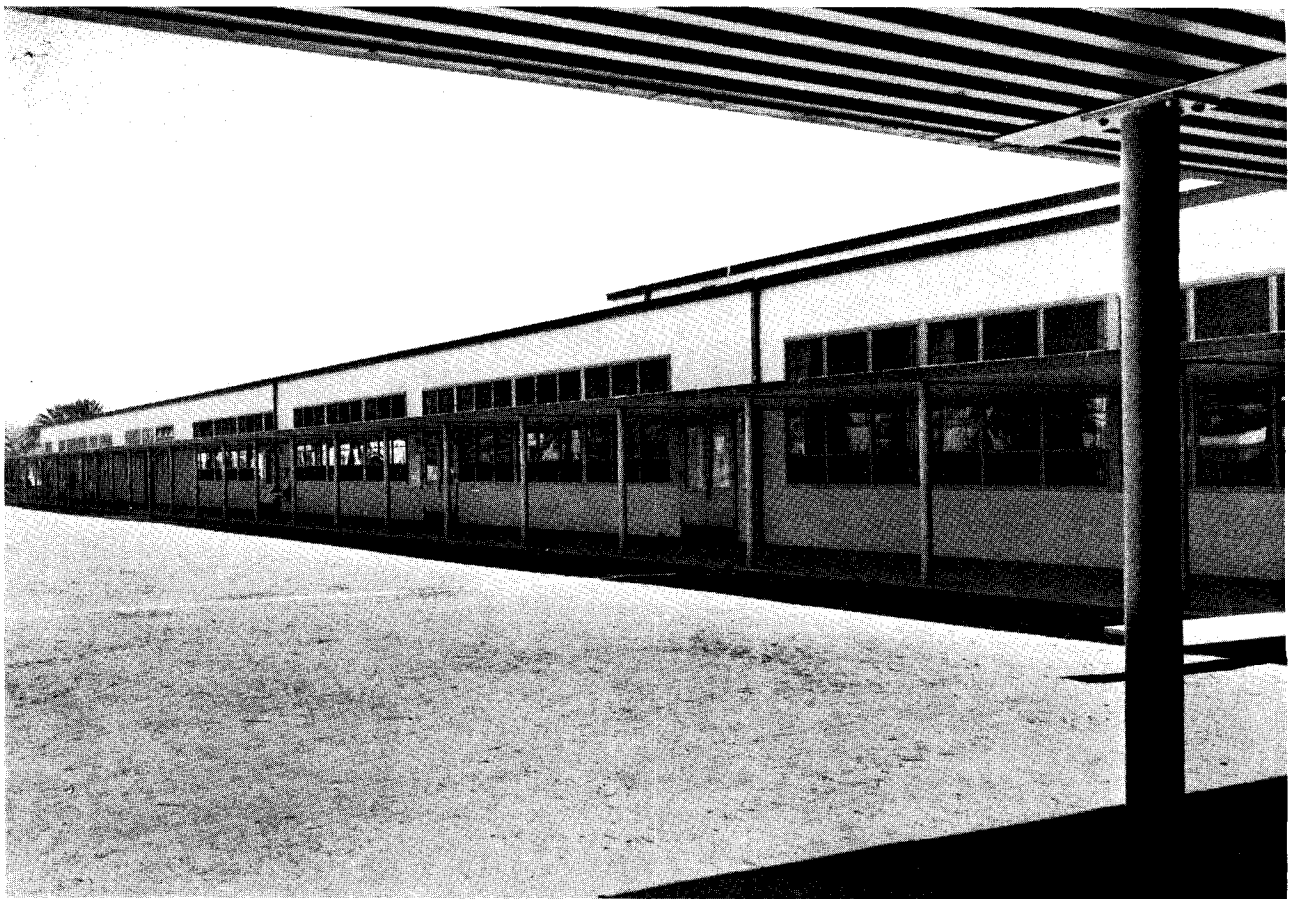

North side of playground at Practical Arts Building, showing colonnade deck which intersects windows



Sewing Room, Practical Arts Building. Note uniformity of natural lighting above and below colonnade roof.

## SECONDARY SCHOOL 1,100 PUPILS

BENJAMIN FRANKLIN  
JUNIOR HIGH SCHOOL  
LONG BEACH, CALIFORNIA



Main Stair Hall, Academic Building. Stairs have cork tile treads, aluminum nosing. Note plate glass on both sides of trophy display case.

### SCHEDULE OF EQUIPMENT AND MATERIALS

#### FOUNDATION

Reinforced concrete, designed for combined live, dead and seismic loading conditions

#### STRUCTURE

Rigid structural steel frame, Minneapolis-Moline Power Implement Co. and Virginia Bridge & Iron Co.; steel cellular decking, H. H. Robertson Co.; first-floor slab, reinforced concrete

#### EXTERIOR

**Walls:** Cement plaster on expanded metal secured to furring channels welded to structural frame

**Roof:** Built-up gravel-surfaced roofing—20-year specification, Pioneer-Flintkote Co.

**Sash:** Steel sash set in steel subframes welded to structural frame, Soule Steel Co. and Truscon Steel Co.

**Metalwork:** Tubular steel doors at main entrances of Academic Building; aluminum trim, Washington Ornamental Iron Works; porcelain enamel trim at entrances, Smoot-Holman Co.

#### INTERIOR

**Floors:** First floor, asphalt tile on concrete in Academic Building, David E. Kennedy, Inc.; second floor, strip maple floor; tile floor and wainscot in toilet rooms; cork tile in library, Armstrong Cork Products Co.; Practical Arts Building—concrete in auditorium, metal in shop; maple block laid in mastic in other shops, Reid-Galleher Co.; linoleum laid over 30-lb. felt over 2-oz. copper membrane with soldered seams laid in mastic on concrete floor, Armstrong Cork Products Co.

**Walls:** Paint on plaster in all classrooms and administrative areas, and wainscot in auditorium, "Nephi" acoustic plaster above

wainscot in auditorium, corridors and music rooms. Portland cement plaster in toilet rooms.

**Ceilings:** "Nephi" acoustic plaster in all corridors, classrooms and administrative areas; "Absorbex" acoustic tile in auditorium, Celotex Corp.

#### INSULATION

1 in. of "Canec" insulation under built-up roofing on all steel decking

#### HEATING & VENTILATING

Low-pressure steam, vacuum-return heating system; "Sturtevant" and "Mechano-vent" unit ventilators; "Barber-Coleman" electric thermostatic controls; boilers are cast-iron sectional type, U. S. Radiator Corp.

#### HARDWARE

General, Sargent & Co.; floor hinges, Oscar Rixson Co., Inc.; exit bolts, Von Duprin

Cost: \$421,996.03, exclusive of items furnished by the school district; approximately 28¢ per cu. ft.

Photos by Ben Schnall

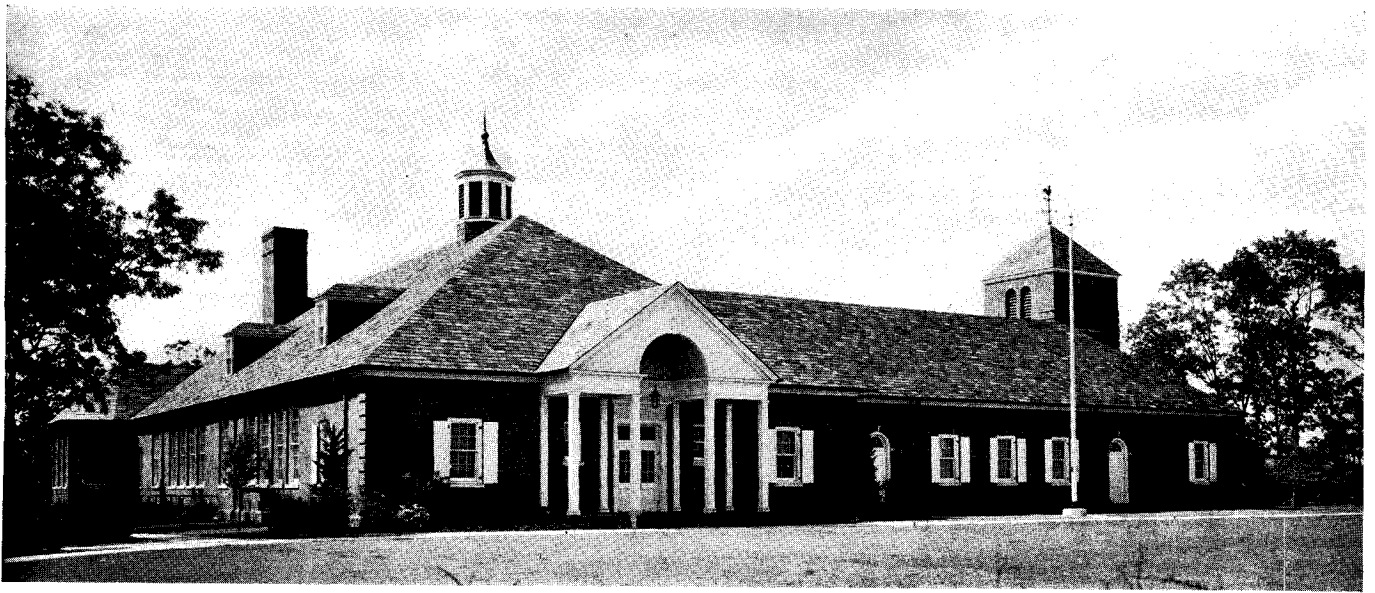

# AN ELEMENTARY SCHOOL—240 PUPILS

QUOGUE, L. I., NEW YORK

TOOKER & MARSH

Architects

HOLDEN & McLAUGHLIN

Associated Architects

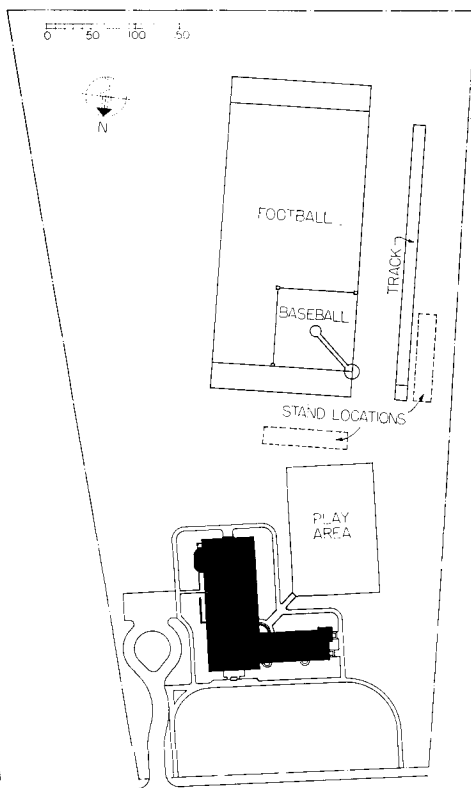

Plot Plan

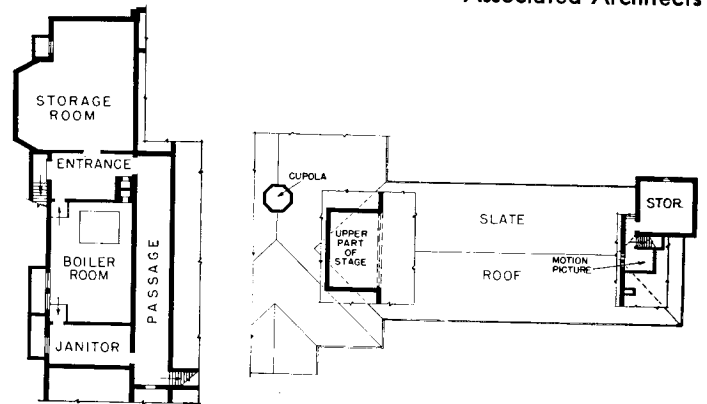

Basement

Roof

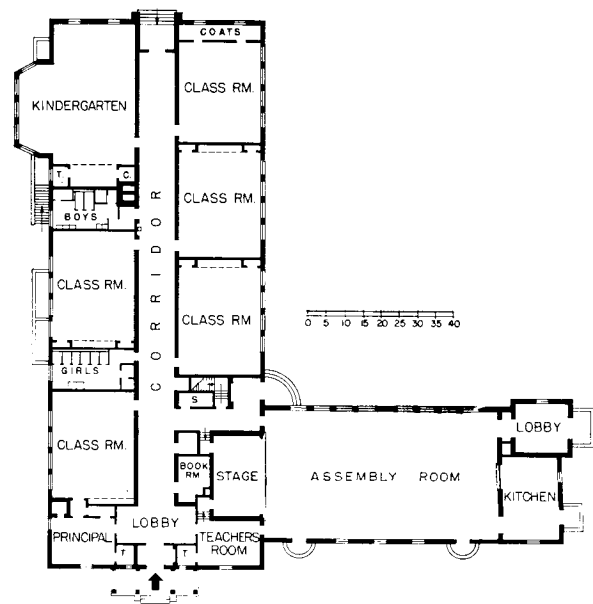

First Floor

Auditorium: Wall panels conceal disappearing tables by the use of which the auditorium can be converted into a dining area.

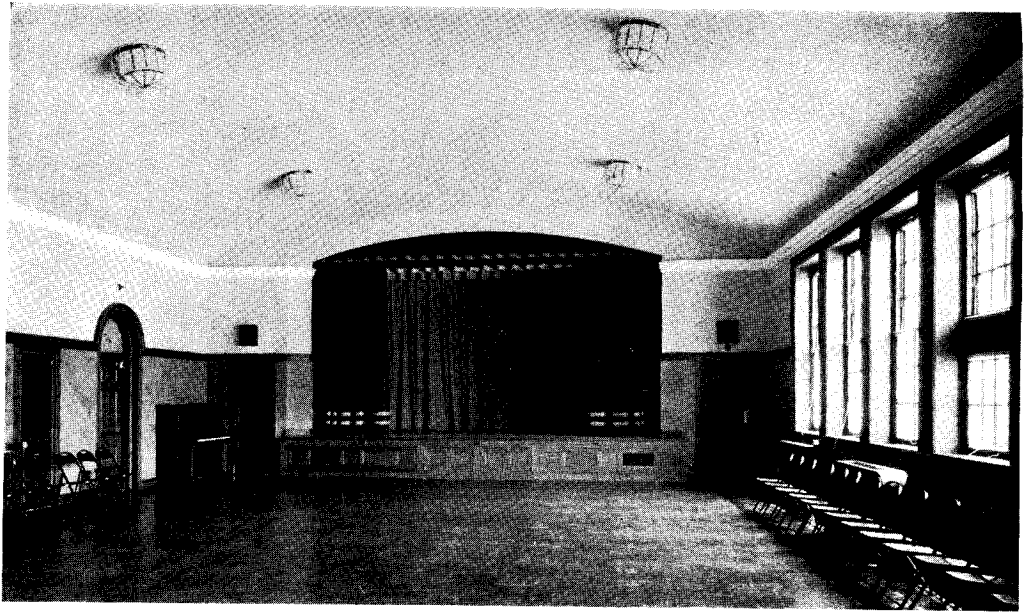

Kindergarten

## SCHEDULE OF EQUIPMENT AND MATERIALS

### FOUNDATION

Concrete

### STRUCTURE

Wall-bearing masonry

### EXTERIOR

Walls: Red face brick, Face Brick Sales Co.

Sills: Precast stone, Westchester Stone Co.

Roof: 3/16"-5/8" variegated slate—weathering greens, grays and black

Sash: Wood, double-hung, "Austral", Jacob Morgenthaler & Sons

Metalwork: Lead-coated copper

### INTERIOR

Walls: Cinder concrete block partitions; "Kraftile" wainscot in corridors; in audi-

torium, cork tile, David E. Kennedy, Inc.; acoustical plaster ceiling

Floors: Bar joist construction, Concrete Steel Co. Mastic tile finish, except: rubber tile in kindergarten; tile in toilets, Nation Tile Co.; "Kompolite" in corridors

Trim: Red oak

### HEATING

Low-pressure steam system; National boilers; Enterprise oil burners; Nesbit uni-vents; Pierce Butler radiators; thermostatic control, Johnson Service Co.; grilles and registers, Tuttle E. Bailey, Inc.

### PLUMBING

Copper-brass pipe; John Douglas fixtures; "Delco" gas compressor

### ELECTRICAL

Wire, General Electric Co.; fire alarm system, Stanley Patterson; clocks, Standard Electric Time Co.; radio address system, Commercial Radio Co.; lighting fixtures, R. & P. Mfg. Co.; projection room equipment, Peter Clark, Inc.; stage lighting, Major Equipment Co.

### HARDWARE

Lockwood Hardware Co.; Yale & Towne Co.

### EQUIPMENT

Seating, Tappen & Katz; slate blackboards, G. G. Albert; disappearing tables, Hartman Co.; vault door, Mosler Safe Co.; steel toilet partitions, Fireproof Products Co.; classroom wardrobes, J. G. Wilson

### PAINT

Pratt & Lambert

Photos by Baker Studios

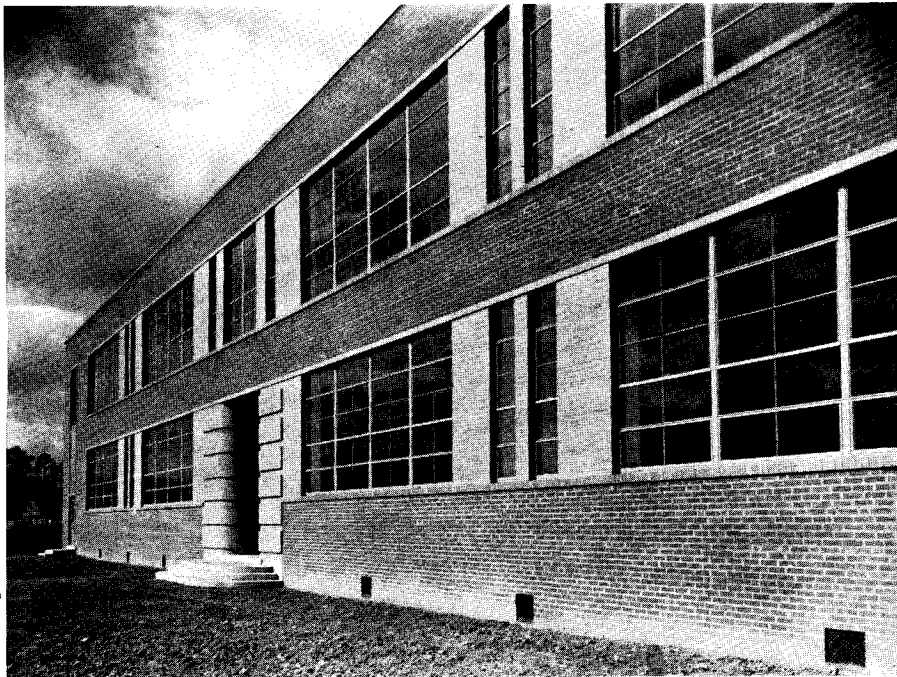

## ELEMENTARY SCHOOL 630 PUPILS

ROCKY MOUNT ELEMENTARY  
SCHOOL FOR COLORED CHILDREN  
ROCKYMOUNT, NORTH CAROLINA

A. MITCHELL WOOTEN  
AND ASSOCIATES  
Architects



Corridor: wainscot painted blue, white above

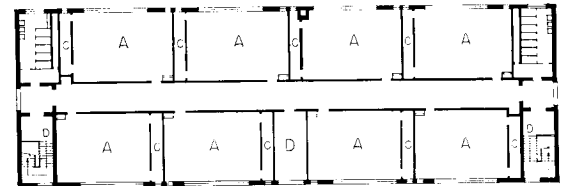

Second Floor

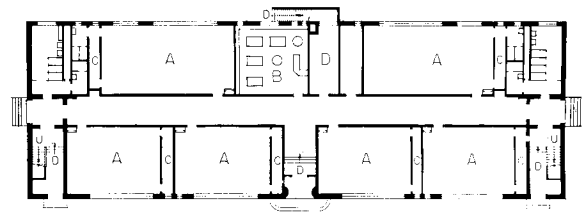

First Floor

A Classroom C Closets  
B Library D Office

### SCHEDULE OF EQUIPMENT AND MATERIALS

#### FOUNDATIONS

Concrete footings and basement; brick foundation walls.

#### STRUCTURE

Solid masonry-bearing, wood joist

#### EXTERIOR

**Walls:** Common brick and light-gray face brick

**Roof:** Built-up 20-year bonded, gravel surface, Byrd Roofing Co.

**Windows:** Projected steel sash, Detroit Steel Products Co.

#### INTERIOR

**Floors:** Maple finish, except cement in base-

ment and toilets

**Walls:** Plaster finish

**Trim:** Metal, Knapp Bros. Mfg. Co.

#### INSULATION

Rigid insulation board on all ceilings, The Insulite Co.

#### WATERPROOFING

Integral in basement walls and floors, L. Sonneborn Sons, Inc.; asphaltic plaster bond applied on inside of all exterior walls

#### HEATING

One-pipe, gravity return, low-pressure steam system; Fairbanks-Morse stoker; Ideal Red Flash boiler; cast-iron radiators, American Radiator

Cost: \$62,000, or approximately 18¢ per cu. ft., including equipment and fees

#### PLUMBING

Cast-iron and steel pipe, Reading Iron Co.; Standard Sanitary Mfg. Co. fixtures; Ebco Mfg. Co. drinking fountains

#### LIGHTING

Lumflex conduit; standard school fixtures, Chase Brass & Copper Co.

#### PAINT

Sherwin-Williams Co.

#### HARDWARE

Russell & Erwin Mfg. Co.

#### GLASS

Libbey-Owens-Ford

By **A. CARL STELLING**, *Landscape Architect*

FUNDAMENTAL CONSIDERATIONS for the selection of any school site are:

1. Location
2. Accessibility
3. Environment
4. Terrain
5. Orientation
6. Size
7. Shape
8. Safety

1. *Location*: Elementary and secondary schools either separately or in consolidation should be centrally located in the community or district which they serve in order to reduce the pupils' travel distances to a minimum. Maximum walking distances are:  $\frac{1}{2}$  to  $\frac{3}{4}$  of a mile for elementary schools,  $\frac{3}{4}$  to 1 mile for junior high schools, 1 to  $1\frac{1}{2}$  miles for senior high schools. Rural schools which depend on bus transportation should be located within a maximum riding time of one hour.

2. *Accessibility*: There should be transit facilities for teachers, visitors and pupils within a reasonable distance (one or two blocks) of urban schools. In suburban and rural areas, main traffic arteries should be convenient.

3. *Environment*: The encroachment of objectionable influences or nuisance structures should be restricted. Factories, railroads, heavy-traffic streets and highways and other noise sources should be reasonably removed. There should be no tall buildings adjoining the site, because of the consequent loss of sunlight. Areas zoned for business enterprises or for industrial use are not as good as residential zones. The proximity of public parks is in most instances desirable.

4. *Terrain*: A good soil condition is desirable—with natural drainage, level ground or a slope preferably not exceeding 6%. Very large sites can, of course, advantageously include rolling slopes where large areas are to be developed as parks or landscaped, rather than utilized for outdoor recreation. Low damp ground should be avoided.

5. *Orientation* permitting east and west light for classrooms, especially for elementary schools, is frequently the criterion for the site. Too much sunlight should be avoided, however, particularly in tropic and subtropic latitudes where northern reflected sunlight during school hours is preferable to western or eastern direct lighting. In these latitudes southern exposure is not as intense as in the temperate zones, because of the high position of sun at midday.

Prevailing winds are also a determining factor in site orientation.

6. *Size*: Elementary school sites should provide 4 to 6 acres with a minimum of 100 sq. ft. per child de-

voted to playground exclusively; secondary schools—10 to 12 acres minimum, 20 or more recommended, with an absolute minimum play area of 40 sq. ft. per pupil.

7. *Shape* of site will determine, to a large extent, the economy of site planning, distribution of elements and efficiency of the plant. Unusual shapes may result in unwarranted sacrifice of flexibility, disadvantageous location of future expansion or restriction of maximum utilization. A rectangular shape permitting foreground and building to be segregated from all recreation areas is preferable.

8. *Safety*: Schools should not adjoin main traffic arteries, railroad and street-car crossings; or harmful atmospheric conditions caused by industrial processes; or fire engine stations, hospitals, airdromes, etc.

## Development

School sites vary in size, shape and contour to such a degree that no set standard of development may be followed in their planning. After the selection of a site many factors and requirements must be considered before the development may go ahead. These may be classified as follows:

- A. Type of school under consideration
  1. Elementary, including nursery or kindergarten
  2. Junior High School
  3. Senior High School
  4. Private School in any of the first three grade classifications
  5. A combination of the first three grade classifications
  6. Central Rural, Suburban or City
- B. Location of building with future extensions
- C. Student population
- D. Means employed in transporting students to and from school
- E. Foreground and setting
- F. Approaches, including walks, drives, parking and service areas
- G. Grading and drainage of land
- H. Recreational facilities, gardens, etc.
- I. Irrigation
- J. Planting
- K. Maintenance

## Foreground and setting

A school building exemplifies, in a sense, the culture and the intelligence of a community. Every building, regardless of size, should be surrounded by a relatively free area of at least 75 ft. It is preferable, however, to have the foreground range from at least 100 ft. to 300 ft. from the street or property line. If bus turn-arounds are required, 100 ft. would be insufficient.

## Approaches

Children are generally inclined to seek the line of least resistance by cutting corners. Walks, therefore, should be as direct as possible, eliminating right-angle turns. Ramps may be substituted for steps. Walks should not cross drives, nor be adjacent to them any more than necessary. Platforms, of course, are required adjacent to approaches to building entrances and parking areas. Drives need to be spacious, and should be designed solely for one-way traffic. Widths should range from 12 to 20 ft., depending upon amount of traffic anticipated. Width of drive in front of building for landing purposes should range from 20 to 30 ft.

Parking areas should be, preferably, close to entrance doors, but at the side or rear of building. They should be so designed as to be easily regulated and to avoid confusion. Cul-de-sac arrangements are undesirable. The areas should be large enough to accommodate all teachers' cars as well as all cars anticipated at school or community functions to be held within the building, keeping the front of the building entirely free for circulation.

The service area should connect with the approach drive and be designed to accommodate all delivery cars, oil or coal trucks, buses, all of which require turning space. Cul-de-sac arrangement is permissible if through-circulation is not possible.

## Grading and drainage of land

The highest form of insurance against damage by water to the building is accomplished by proper sloping of the land away from the building on all sides to drainage outlets or gutters. Proper grading and drainage often permit the use of land during the wet season; this also prevents damage by frost caused by accumulation of water and ice pockets. Grading and drainage must be considered in making the master plan.

## Irrigation

Most sections of the United States cannot depend upon an evenly distributed rainfall during the growing seasons, even though the average is sufficient. It is necessary, therefore, to take the drought periods into consideration by providing additional water-supply facilities. If automatic sprinklers or spigots are conveniently and uniformly distributed so as to be accessible to all points on the site requiring irrigation, considerable maintenance cost is saved.



Ewing Galloway.



Courtesy Nat'l Recreation Ass'n.

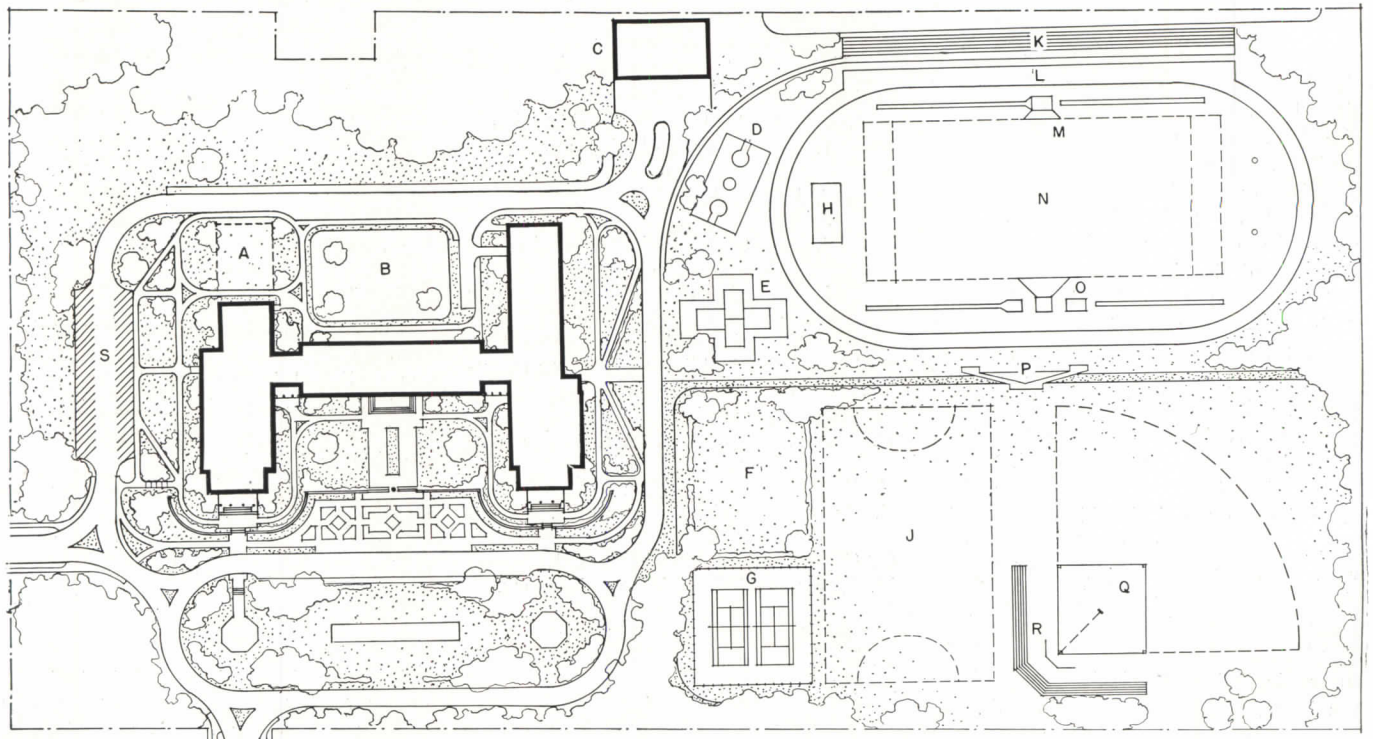

A typical development of outdoor recreational areas for a site of approximately 20 acres  
Briggs and Stelling, Landscape Architects

- |                       |                     |                     |
|-----------------------|---------------------|---------------------|
| A. Future Extension   | G. Tennis Courts    | N. Football Field   |
| B. Play Area          | H. Volleyball       | O. Practice Units   |
| C. Bus Garage         | J. Hockey Field     | P. Ramp             |
| D. Outdoor Basketball | K. Grandstand       | Q. Baseball Diamond |
| E. Handball Courts    | L. Track            | R. Bleachers        |
| F. Play Area          | M. Tournament Units | S. Parking Areas    |



By **A. CARL STELLING**

OUTDOOR VOCATIONAL and recreational activities require more space and equipment as pupil groupings advance in age. The requirements for both elementary and secondary schools are also subject to future expansion dictated by the development of the educational system, increased enrollment and adult participation. Hence, in recreation planning, adequate provision should be made for future additions or changes in outdoor areas as well as structures.

Since the objective of maximum outdoor play area is second only to flexibility, the building should be so located as to carry out this conception. Whether the outdoor area should be developed as one unit in the case of a separate elementary or secondary school, or whether it is more desirable to break up the area into more or less segregated sections for various activities, is dependent upon the program of the school, size of available area, supervision considerations and budgetary resources. Combined elementary and secondary schools should have completely separated outdoor areas for pupils of each group.

Sports activities should be planned in terms of the enrollment and physical education program. Students of different ages have diverse interests. Kindergarten and early elementary students require protection, and therefore their play areas should be close to their classrooms. Older students up to the junior high school age enjoy many sports, but are not yet equipped to indulge in the so-called "major" sports. Therefore, ample play space for intramural sports should be provided. The following activities and approximate areas are suggested for the largest number of students.

### Tennis courts

Tennis courts, preferably in pairs, running north and south, will require an area of 120 x 120 ft. To permit their use at all times, except during rainy or snowy weather, they should be paved with asphalt. Board curbing may be installed along the outer edge of the two (or more) courts to permit flooding for skating in winter. All obstructions, such as net posts and braces in the play areas, should be placed in sockets so that they can be removed when desirable. A heavy base, well-drained, will not only improve the resilience of the courts, but insure it against breaking up from water and frost action.

### Soccer and hockey

Soccer and hockey require an area of 180 x 300 ft., with an additional 10-ft. border around it. This area is used principally by older boys and girls.

### Speedball and softball

Speedball and softball may be played on the hockey field. It is preferable, however, that separate areas be allotted, with dimensions of 200 x 200 ft.

### Baseball

Baseball is generally played by all older male groups. Although it is often necessary to construct the diamond within the quarter-mile track area when additional space is not available, it is highly desirable to place it in a separate area. The minimum area requirements, therefore, for a standard baseball diamond are 300 x 300 ft. The recommended orientation would be one in which the first baseman and catcher do not face the afternoon sun.

### Track and football

Track and football games are generally played by proportionately few students, but among junior and senior high school students particularly are considered major sports. A minimum level area is 300 x 550 ft. For grandstand purposes it is desirable to enlarge the over-all width of the field to 325 ft. or 350 ft., so that spectators may be seated on one or both sides of the field. Orientation should be north and south, if possible. Pits for broad and high jumping, horseshoe-pitching, and other games such as volleyball, shuffleboard, roque, croquet, can be conveniently arranged within the quarter-mile track area without infringing upon the football area. Overlapping tracks and tracks five laps and under are undesirable, since they do not permit an even

number of laps from the same starting point, for the 220-yd., 440-yd., 660-yd. and mile-run. They also prove to be obstacles to relay races and hurdles. Major sports, including tennis, basketball and badminton, may be played outdoors at night when lighting is provided. This permits community groups to play these games during leisure time at minimum expense, and thus spreads the use of public grounds to practically all age groups.

### Elementary grade requirements

Small children are limited to group games and require protection. It is particularly important that the area relegated to them be entirely fenced in. It is essential that the surfacing be of porous material—preferably washed gravel with a small percentage of sandy loam to permit proper drainage. A shade tree or two with pool and sand box underneath offers suitable diversion for them. The outside areas should have a strip of grass at least 10 ft. wide all around. The over-all minimum area should be 100 x 100 ft. or more.

Minimum standards for playground equipment have been established by NEA as:

#### CHILDREN UNDER 6 YEARS

Chair swings—set of six; sand box (in two sections); small slide; simple, low, climbing device.

#### CHILDREN 6 TO 12 YEARS AND OLDER

Swings—from 12 ft. (set of six); slide—8 ft. high, 16 ft. long; horizontal ladder; traveling rings or giant stride; balance beam; seesaws (set of three or four).

#### OPTIONAL

Horizontal bar; giant stride or traveling rings (whichever is not provided above); low climbing device.

(For details of equipment and check list of playground equipment, see AR, 6/37, pp. 143-148.)

## NATIONAL RECREATIONAL ASSOCIATION STANDARDS

(Areas for children aged five to fifteen)

	STANDARD	LIMITED	LARGE
Child population to be served.....	600	300	1,000
Apparatus area (sq. ft.).....	7,700	5,600	10,270
Child capacity of apparatus area.....	122	65	74
Average sq. ft. per child served.....	63	86	74
Area for equipment (sq. ft.).....	21,300	13,000	30,900
Child capacity of this area.....	285	170	450
Average sq. ft. per child served.....	75	76	69
Special areas for games and sports (sq. ft.).....	109,975	83,150	169,560
Child capacity of this area.....	156	118	250
Average sq. ft. per child served.....	705	704	678
Total area of playground (sq. ft.).....	151,975	111,250	233,230
Total area of playground (acres).....	3.49	2.55	5.35
Child capacity of total playground.....	563	353	859
Average sq. ft. per child served.....	270	315	272
Child capacity per acre.....	161	138	160

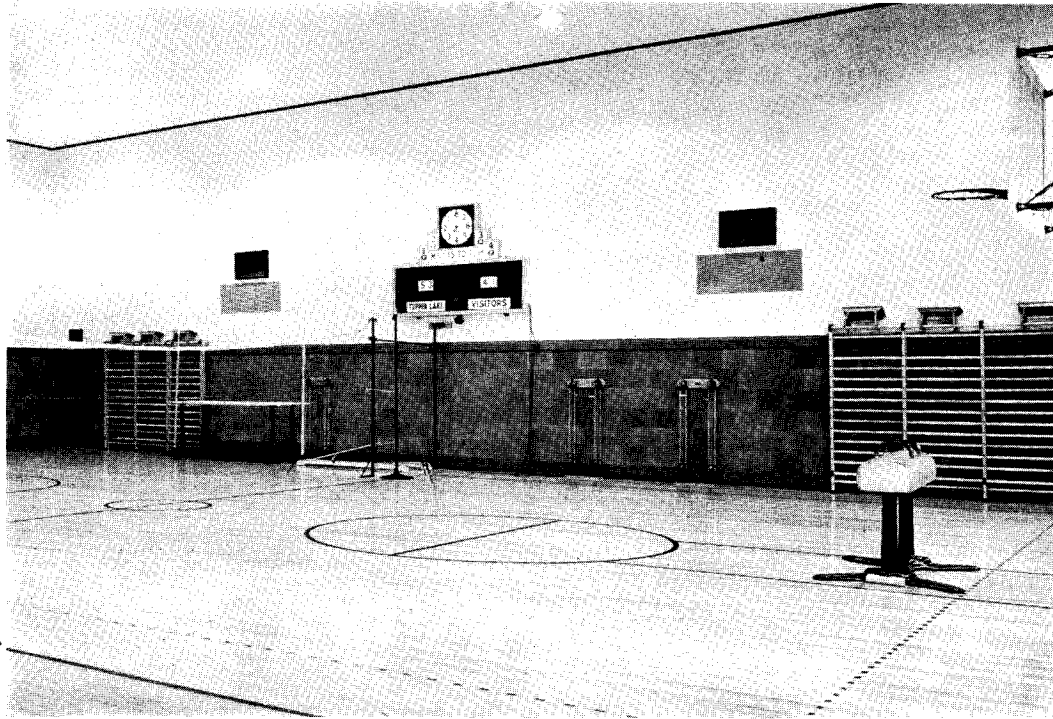
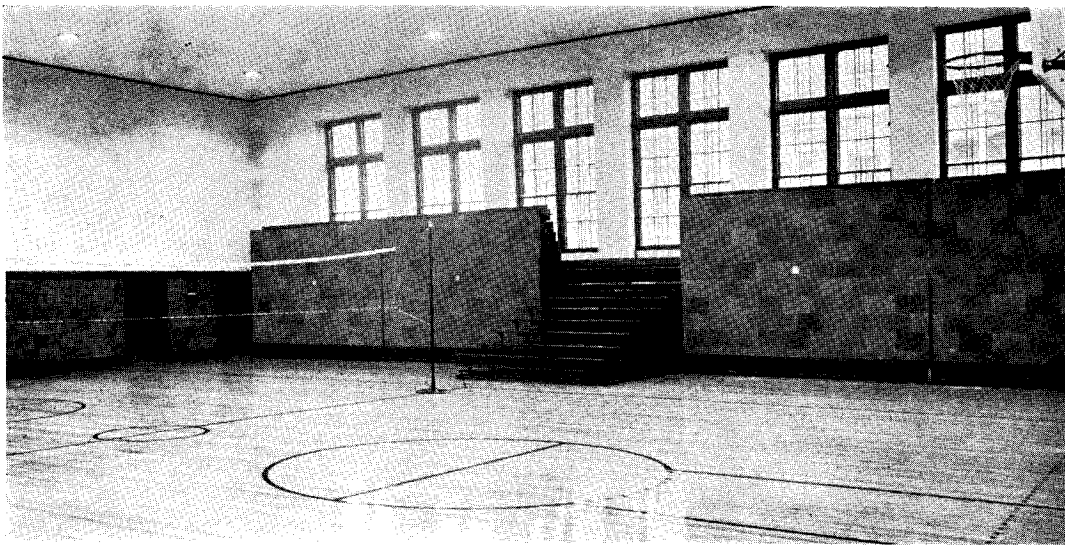

Photos by Robert J. Arnold

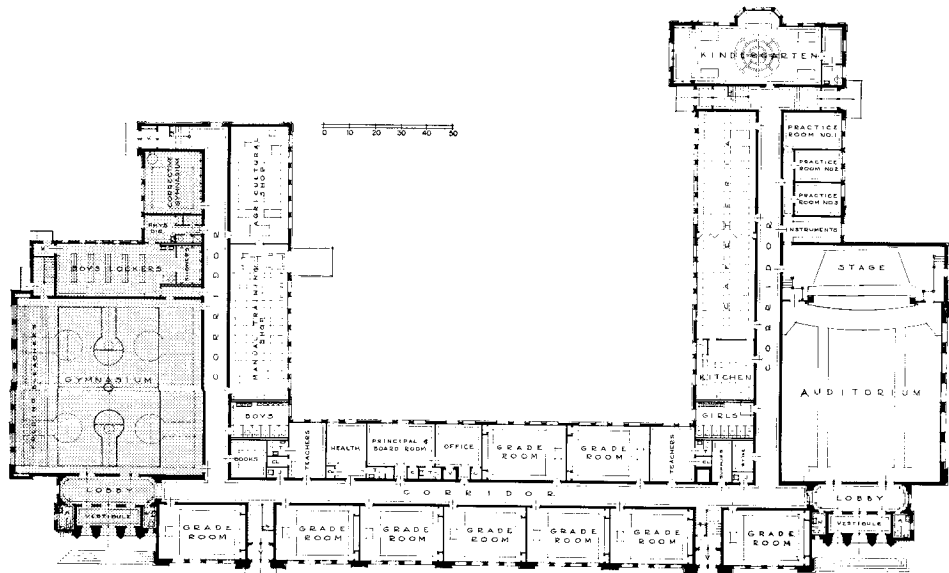

Photographs show the gymnasium of the Tupper Lake School; Robert R. Graham, Architect. Upper: Note the folding bleachers. Lower: Scoreboards and other typical equipment. Plan at left: First Floor, Central School, Dundee, New York; Robert R. Graham, Architect. Shaded portion represents indoor recreation area, with public entrance available also for access to classroom corridors. Arrangement of locker rooms and other appurtenances, convenient to exterior doors and interior corridors, is noteworthy.

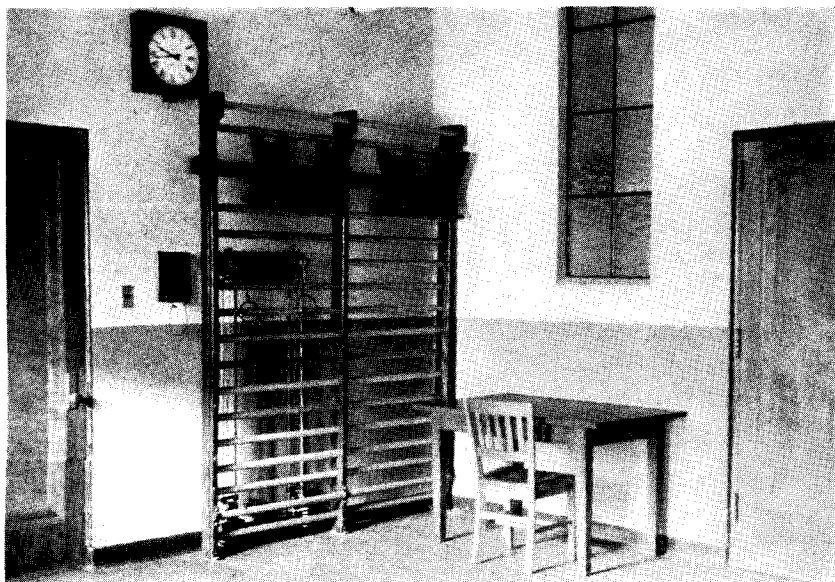

Corner of corrective gymnasium, Eastern Junior High School, Lynn, Mass.  
Charles L. Betton, Architect.

INDOOR RECREATION is closely associated with outdoor activities, and should preferably be located in proximity to the outdoor play areas. Ground-floor locations affording this correlation and also a direct entry for spectators or community use are recommended.

#### Size

The capacity of the gymnasiums should be established on the basis of 25 to 35 sq. ft. per pupil enrolled with a *minimum* size of 35 x 50 ft., maximum 60 x 90 ft. Where two or more gymnasiums are required, separate areas for each sex should be provided on the basis of one area for each 500 pupils. An alternative provision of sliding panel wall sections would permit the use of one large area by both sexes. Ceiling heights recommended are 14 ft. minimum for elementary grade use, 18 to 22 ft. for secondary grade use.

There should be provision for spectators along the sides rather than at the ends, allowing space for approximately one-half the total enrollment. Fold-up or lifting tiers of bleacher seats are recommended, which should begin at or near the floor level.

#### Lighting

Natural lighting should be bilateral,

with window area at least 25% of total floor area. Windows should have a sill height at least 6 ft. above the floor, glazed with wire glass or fitted with removable guards. Artificial lighting should provide an illumination level of 15 footcandles. Fixtures should be protected by suitable guards.

#### Finishes

Floors should provide a resilient surface without a slippery or splintering character. Hard maple laid over suitable noise-reducing material and hard pine sleepers or wood block on end over concrete, with expansion joints to prevent buckling, are recommended. Walls may be glazed brick, structural tile, wood, linoleum or cork tile.

#### Corrective gymnasiums

Since there are in every school a number of pupils whose physical condition will not permit indulgence in usual gym activities, there should be at least one corrective gymnasium; in the larger schools, two are suggested—one for each sex. These may be rooms approximately 25 x 22 ft., with 12-ft. ceiling, in which pupils may engage in the special exercises prescribed, using simple equipment like wall weights and horizontal bars.

#### Shower and locker requirements

For the first 200 pupils, for grades above the fourth, there should be three shower heads for each sex.

For each additional 200 pupils for grades above the fourth, there should be two additional shower heads for the girls and one additional shower head for the boys.

Unless there are special and peculiar organization conditions which require a greater number of shower heads, the maximum number to be provided need not exceed 12 for the girls' shower room, nor 8 for the boys' room.

The boys' shower arrangement is preferably gang or group showers. The preferred arrangement for the girls is individual booths with two conveniently arranged individual dressing booths to serve each shower booth. At least two individual shower booths and four individual dressing booths to serve them should be provided in the girls' shower room even though the group shower facilities for girls are desired.

Gym lockers should be provided as follows:

One street-clothes locker for each pupil taking regular gym work, for which street clothes must be changed for gym clothes, 12 x 12 x 60 in., or 9 x 12 x 60 in., or 7½ x 12 x 60 in.

One gym-suit locker for each of the maximum size gym classes: 12 x 12 x 20 in., or 9 x 12 x 20 in., or 7½ x 12 x 20 in. The depth of lockers may be increased to 24 in. where desired.

When possible, lockers should be arranged around the walls of the locker room, leaving an open space for supervision and group discussions on hygiene. When lockers are in tiers face to face, a minimum space of 5 ft. should be maintained.

Gym showers and lockers should be located as conveniently as possible to the gymnasium, with access from the corridor to the locker rooms, and directly from the locker rooms to the gymnasium. Where the gym is divided into a double court, direct access to the court reserved for one sex must be provided from the locker rooms of that sex. Crossing of courts should be avoided.

All locker rooms must be well lighted and ventilated. Outside light for shower rooms is not necessary.

William Smedley

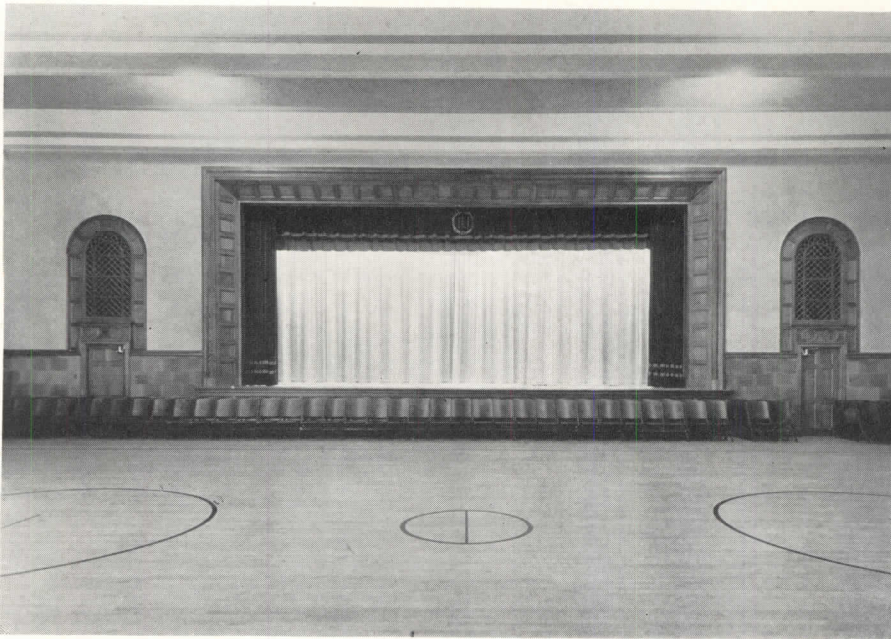

Roeliff Jansen Central School, Hillsdale, New York  
Tooker & Marsh—Snyder & Snyder, Associate Architects

### COMBINED USAGE

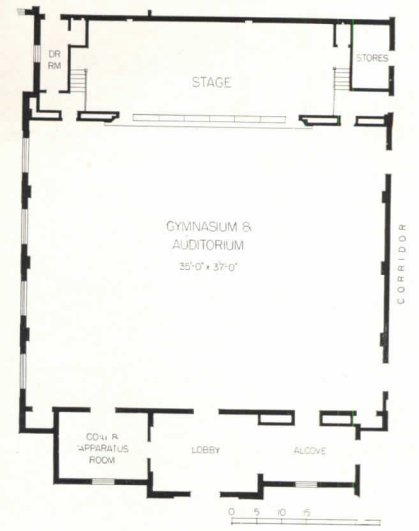

Gymnasium and Auditorium

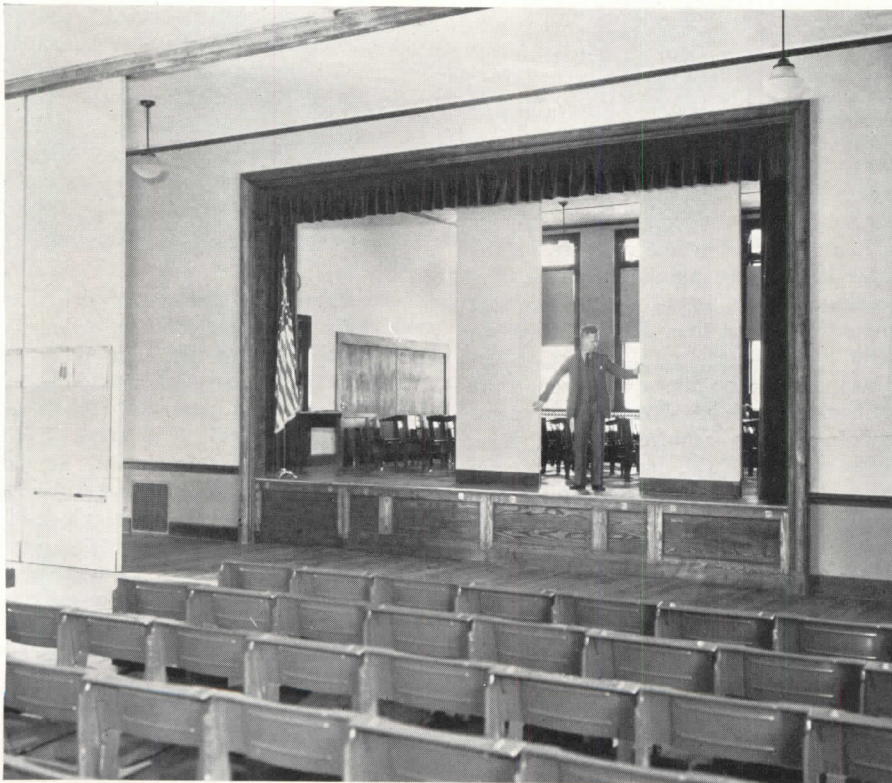

Eastman Elementary School, Concord, New Hampshire  
Harold Holmes Owen, Inc., Architect

### REQUIRED MINIMUM

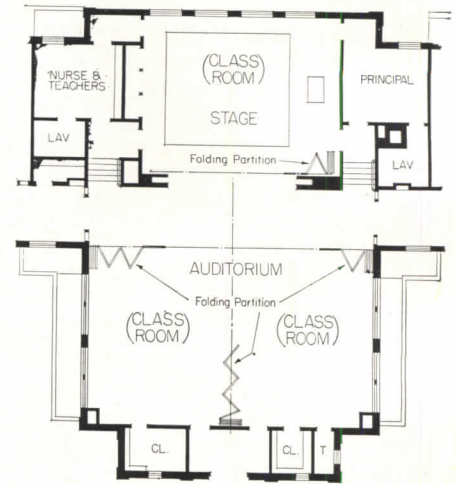

Through the use of sliding panels and convertible desk and chair units, two classrooms can be thrown together to form an auditorium. The third instruction area readily becomes a stage when the class equipment is removed and panels are properly arranged. Further flexibility is apparent in the possibility of segregating any of the three areas.

assembly room than to provide a permanent elevated platform too small for school plays.

The stage should extend the full width of the auditorium; and the proscenium opening should be about one-half of the total width of the auditorium, thus leaving about one-fourth of the auditorium width as free off-stage space on each side of the proscenium opening. Under no circumstances should the off-stage space be reduced or separated from the stage proper by permanent partitions.

Although it is desirable to have sufficient ceiling height above the stage to raise scenery out of the line of vision where it can hang from a "grid" by stage riggings, this expense can seldom be justified in a school auditorium. The proscenium opening should be about 20 ft. high and the stage ceiling should be at least 3 ft. above the top of the proscenium opening. Although this ceiling height is entirely inadequate for a professional stage, it will do very well for a small school auditorium. The stage ceiling should be provided with pipe hangers or exposed steel beams for supporting the cyclorama and other scenery.

Light and scenery controls should be close together, preferably at the right of the stage.

### Accessory rooms

If the auditorium is cut off from the main building, it is advisable to provide public toilets.

The permanent picture booth is not necessary in small auditoriums, because the modern picture equipment and films are fireproof. Provision should be made, however, at the rear of the room for housing and setting up portable picture equipment, and some space should be provided for a film library.

A scenery storage room and workshop should be provided to the rear or at one end of the stage.

It is necessary for a school auditorium to have large dressing rooms available when needed, but rooms exclusively for this purpose cannot be justified. The plant should be so planned that two or more classrooms are accessible from the stage without going through the auditorium. A still better plan is to have the stage accessible from a corridor so that pupils will have access to any portion of the building for dressing and make-up. If those on the stage do not have access to the regular toilet

rooms, special toilet and washrooms should be provided in connection with the stage.

### Scenery

It is not necessary to provide a great deal of expensive scenery for the school stage. If the building contracts include the essential pieces, the pupils may construct and paint other sets as needed. The essential pieces of stage scenery and equipment are a front velour curtain on a wood track, a velour valance, adjustable cyclorama, a picture screen and sufficient border drops to mask the stage ceiling from the sight line from the front row of seats.

### Lights

Next to stage area, the most important consideration is lights. The lights of the auditorium proper should be controlled by dimmers to avoid the sudden snapping on and off of lights. The auditorium lights should preferably be of the indirect type. Stage footlights are not necessary and, if used at all, should be of the disappearing type. Overhead stage border lights are advisable, but not essential. Provision should be made on both sides of the stage just back of the proscenium wall and out of the line of vision for securing adjustable spotlights to a vertical pipe. It is also advisable to provide a few convenience outlets around the stage. The most important and essential provision for stage lighting is color lights, which are placed in the rear of a small auditorium or mounted in the front side of a ceiling beam in a larger auditorium. These color lights should be provided with dimmer controls from the stage control panel. The beauty, depth and color harmony which may be provided on a natural background by this type of lighting are almost unlimited.

### Combined areas

The school auditorium is frequently combined with other activities, such as physical education, studying, eating and general recreation. Combinations have been worked out in a variety of ways, but they are never entirely satisfactory. The auditorium or little theater seating as many as 300 should have an inclined floor. This eliminates the other activities. The stage gymnasium has been used extensively, but is very unsatisfactory both as a stage and as a gymnasium, and does not result in the econ-

omy claimed. If the auditorium and gymnasium must be combined, a satisfactory plan is to place the stage at the side rather than the end of a flat playing floor and to provide bleachers on the opposite side facing the stage.

When the assembly area is combined with one or more dining areas, the latter can be placed to the sides or rear. A system of sliding panels permits independent use of both areas, yet provides additional assembly seating area when such is required.

### Sound

Sound transmission and amplification has become an important adjunct of education. While such systems should not be restricted to assembly areas, there are obvious reasons for considering auditorium installations as a minimum desirable standard. Reproduction and amplification of musical programs, either from recordings or radio broadcasts, speech amplification and important proclamations of many kinds should all be attainable. Through wiring systems and loudspeakers, programs and announcements can also be transmitted to individual instruction and other areas. These larger installations are most effectively controlled by placing the central station in the administration area.

### References

- School Architecture, Principles and Practices.** John J. Donovan. The Macmillan Company, New York. 1921. Pp. 320-341.
- Standards for Junior High School Buildings.** N. L. Engelhardt, Bureau of Publications, Teachers College, Columbia University. New York. 1932. Pp. 115-122.
- Proceedings of the Fifteenth Annual Meeting.** National Council on Schoolhouse Construction. Published by the Council, Peabody College, Nashville, Tennessee. 1937. Pp. 130-131.
- The Equipment of the School Theater.** Milton Smith, Bureau of Publications, Teachers College, Columbia University. New York. 1930. Pp. 1-78.
- The Public Elementary School Plan.** Charles L. Spain, Arthur B. Mochlman, and Fred W. Frostic. Rand, McNally & Company. New York. 1930. Pp. 297-324.
- Standards for Elementary School Buildings.** George D. Strayer, and N. L. Engelhardt, Bureau of Publications, Teachers College, Columbia University. New York. 1933. Pp. 133-141.
- Architectural Record,** May 1930.
- American Architect and Architecture,** July 1937.

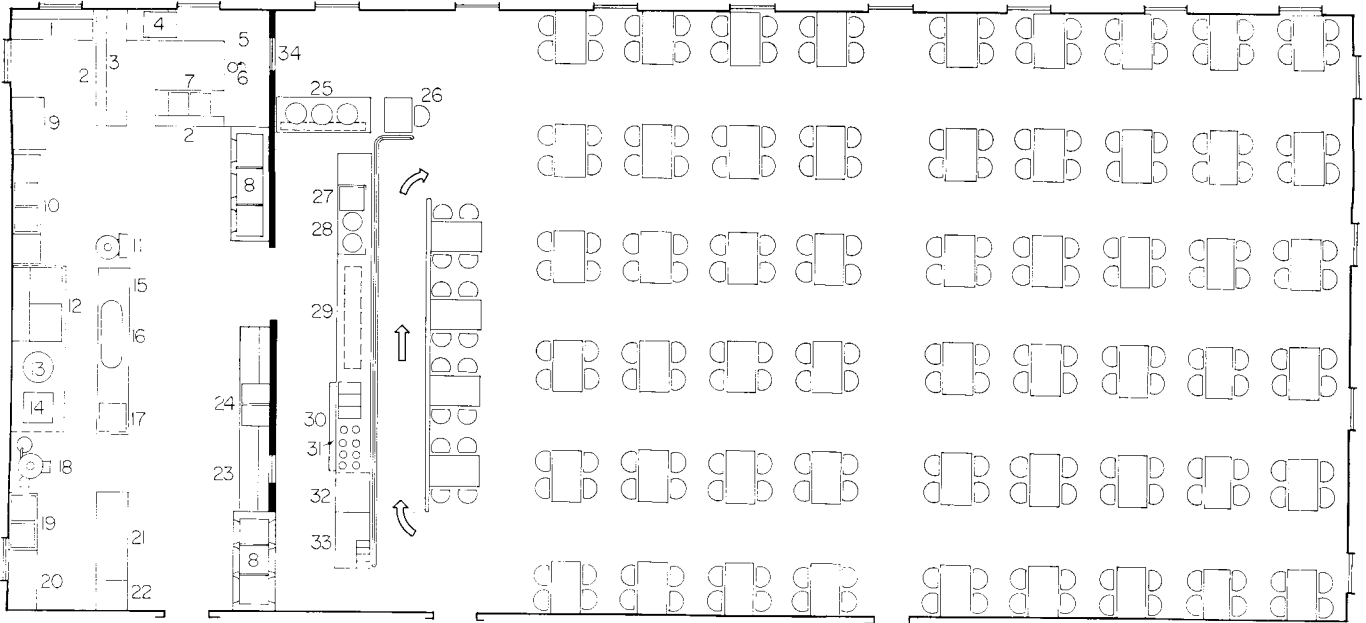

Prepared by the John Van Range Co.

Photos courtesy N. Y. State Inst. of Applied Agriculture.

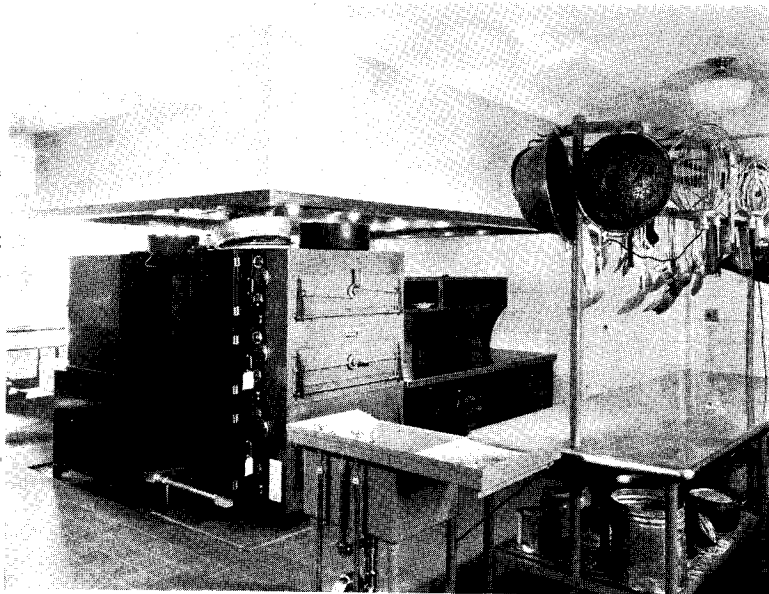

### Kitchen Equipment

- |                  |                     |
|------------------|---------------------|
| 1. Bake Table    | 13. Kettle          |
| 2. Shelf         | 14. Steamer         |
| 3. Clean Dishes  | 15. Cook's Table    |
| 4. Dishwasher    | 16. Pan Rack Above  |
| 5. Soiled Dishes | 17. Bain Marie      |
| 6. Swill Basin   | 18. Peeler          |
| 7. Glass Sinks   | 19. Vegetable Sinks |
| 8. Refrigerators | 20. Drainboards     |
| 9. Bake Oven     | 21. Table           |
| 10. Pot Sinks    | 22. Block           |
| 11. Mixer        | 23. Salad Tables    |
| 12. Ranges       | 24. Salad Sinks     |

### Serving Equipment

- |                           |                      |
|---------------------------|----------------------|
| 25. Coffee Urns and Stand | 29. Pastries         |
| 26. Cashier               | 30. Steam Table      |
| 27. Milk                  | 31. Carving Boards   |
| 28. Ice Cream             | 32. Bread            |
|                           | 33. Trays and Silver |

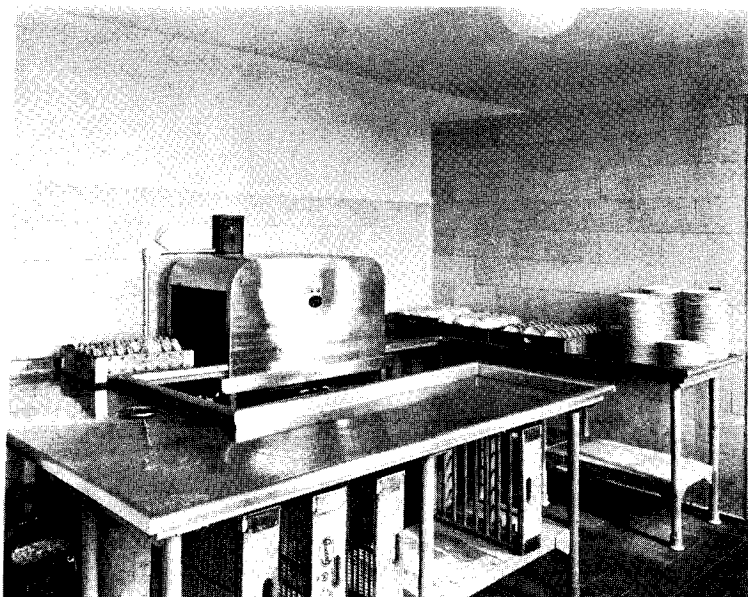

Top: A typical cafeteria and kitchen layout for a school of 1,000 pupils. Seating capacity: 224—40% of enrollment; two lunch periods. Dining area: 39 x 74 ft., about 12.8 sq. ft. per seat. Kitchen area: 20 x 39 ft., about 27% of dining area. Center: Cooking units and fume hood. Bottom: Dishwashing unit.

# Dining Areas

By HARVEY B. DAYCOCK

**TIME SAVER  
STANDARDS**

IN GENERAL, cafeterias are preferred as the most appropriate type of food servicing for schools, since, from the viewpoint of both pupil and administration, they are most convenient and economical means of distributing food. There are exceptions, however: dining areas for smaller children who are not yet able to select food for themselves; special schools for handicapped children; private schools of imputedly high social position. These may need other than cafeterias or self-service dining facilities. Likewise, some schools, particularly the larger senior high schools, may require separate dining areas for teachers and other employees. In general, however, one common area serves students and teachers, although a portion of the area may be set aside for the exclusive use of the latter. Rest rooms for women teachers are sometimes provided with their own kitchens or small food preparation areas.

## Location

A central location on the first floor is preferable because of greater accessibility, more efficient receipt of supplies, better natural lighting and simpler ventilating. Planning should be studied for minimum congestion in corridors and least noise interference in adjoining instruction or study areas. When the dining area is located adjacent to the assembly areas, it can frequently be utilized by community gatherings.

## Arrangement

A rectangular shape without interior columns is desirable, since it facilitates circulation and supervision. The serving counter should be at one end and may be enclosed or in the dining area proper. When enclosed in a separate corridor, either by screens or sliding wall sections, the service area can be isolated, thus increasing the adaptability of the dining area to other uses as study or instruction areas. A dining area serving no other function is occasionally an extravagance: particularly where there are only one or two dining periods, or in the case of smaller schools.

The length of the counter element depends on the variety of foods served, and on the time required to traverse the aisle. Normally, about 12 students per minute can be accommodated by a 35-ft. counter. Longer counters slow up circulation; therefore, double or multiple counters may be required.

Seating may be four or more to a table; where tables are lengthened, wider aisles will be required.

Materials which may be easily cleaned are recommended for floor and walls. Frequently it is the practice to hose down the entire area, indicating the necessity of frequent and adequate floor drains as well as sanitary cove bases.

## Size

The size of dining areas will depend upon the following variables:

1. Age of students
2. Length of lunch period
3. Proximity of school to student homes
4. Economic status of students
5. Accessibility and competition of public eating places.

Where all factors are favorable, the maximum use for accommodations for dining would be 80 to 90% of the enrollment. Customarily, 40 to 50% of a secondary school enrollment represents average patronage.

A minimum of 9 sq. ft. per pupil, exclusive of food preparation areas is required; 12 sq. ft. per pupil is recommended. School programs seldom restrict dining to one period; usually two, sometimes three, are established.

## Food preparation

The food preparation departments, consisting of main kitchen and its subdivisions, should adjoin the dining area; a location immediately to the rear of the serving counter is preferable. The location should offer easy access to receipt of supplies and the disposal of refuse. A rectangular shape is recommended, its length not over twice its width. Its size is usually 30 to 35% of the combined serving and dining areas, or a minimum of 300 sq. ft. No equipment should be placed on wall adjoining service counter, since this prevents proper location of service openings and slides between kitchen and counter.

## Storage

Storage areas (including refrigerators) required in conjunction with food preparation need approximately 25% of the required kitchen area. In addition to the food storage areas, adequate space should be provided for brooms, mops and other cleaning equipment.

## Ventilation

Mechanical ventilation is desirable in dining areas and essential in the food preparation areas. Ducts from hoods over ranges, broilers and steamers must be independent of other exhaust systems.

## Lighting

Unless cafeterias are used also for study or instruction areas, a relatively low level of illumination of 6 foot-candles should be sufficient. When other uses are contemplated, several circuits should be provided in order to permit the higher levels required during these periods.

Color may be used to prevent the psychological depression resulting from the fatigue and eyestrain caused by large expanses of white walls and ceiling. The comparatively low level of illumination usually sufficient in the dining area may be used to advantage in the selection of colors with light-reflection factors lower than white and less advisable elsewhere.

## Sound control

Because the dining area is subject to considerable noise disturbance from dishes, silverware, trays and conversation, acoustical treatment for the ceiling, and possibly for the walls, is recommended. This will afford a quieter environment to pupils during their lunch hour, and when combined with proper structural methods and materials, will also minimize sound transmission to other areas.

## Steam and water

These services are subject to specific requirements for each piece of equipment; the minimum steam pressure at each fixture should be 25 lb., while 35 to 40 lb. is preferable. Hot water for dishwashing machines, should be delivered in the kitchen at a temperature of not less than 180° F. Grease traps, drains, vapor pipes, etc., must be provided.

## References

(It is recommended that kitchen and dining room equipment manufacturers be consulted for suggestions and information regarding specific installations.)

**The School Cafeteria.** Mary deGarno Bryan. F. C. Crofts & Co., New York City. 1936.

**Layout and Equipment of High School Cafeterias.** Willard S. Ford. American School and University, First Year Book: pp. 277-281.

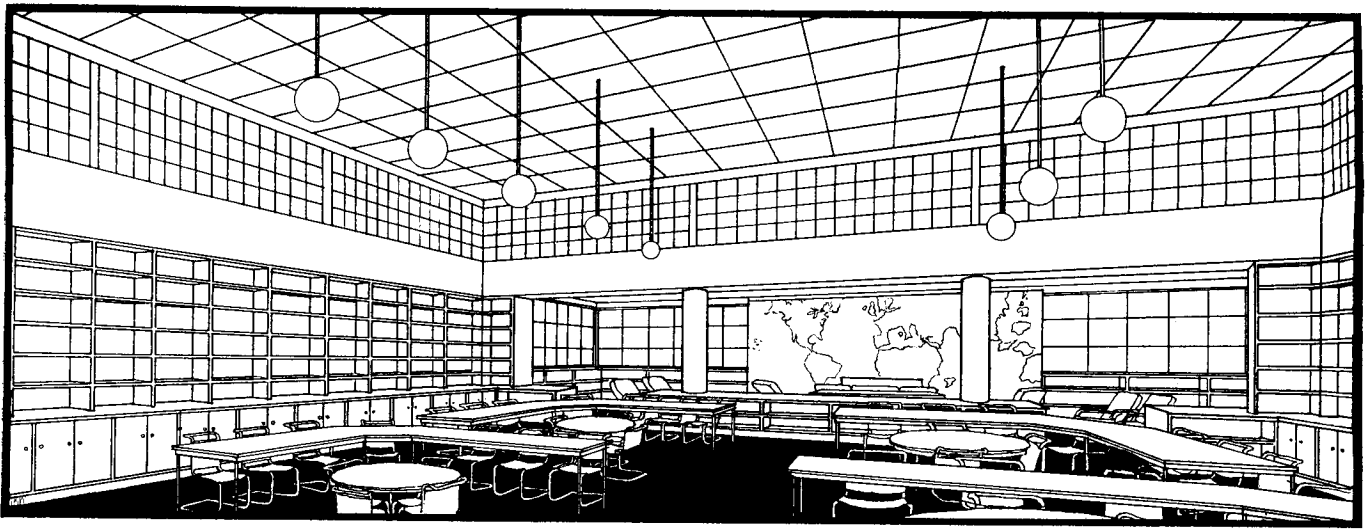

This library was designed especially for ARCHITECTURAL RECORD by A. Mitchell Wooten & Associates.

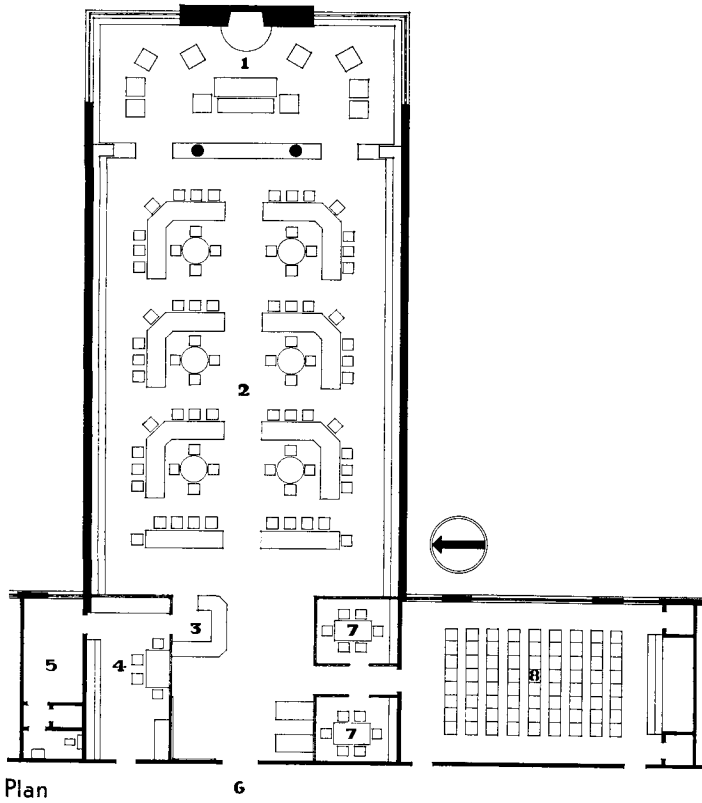

**SUGGESTED COLOR SCHEME:** Floor, table tops, counters and bookshelves to be black, cupboard doors and structural columns blue; chairs to be tubular metal with blue leather seats and backs; walls above the bookshelves and the acoustical material on the ceiling to be oyster white; color accent to be derived from the bookbindings and accessories, and particularly from an illustrated map of the world mounted over the fireplace on the main axis of the room.

**Areas**

1. Browsing
2. Main Reading
3. Control
4. Administration
5. Office and Toilet
6. Main Corridor
7. Conference
8. Projection and Lecture

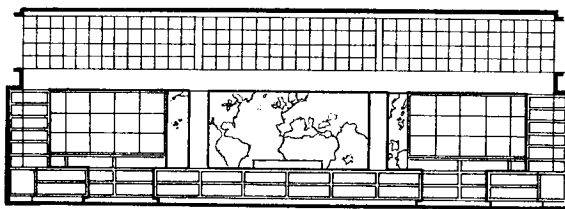

Fireplace End Wall

Side Wall

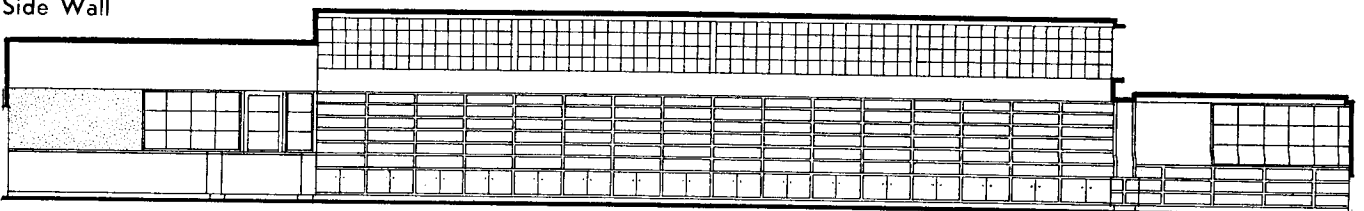



# Study Areas

By A. MITCHELL WOOTEN, Architect

TIME SAVER  
STANDARDS

ALTHOUGH school libraries have steadily assumed a more important place in the eyes of the school administrator, it is only recently that school architects have given them the attention they deserve. Many school libraries have been seriously handicapped by the necessity of adjustment to remodeled instruction areas or to being confined to the size of instruction areas.

In the course of numerous conferences with librarians, and research in available reference material, the writer has developed a number of principles and standards of requirements which can be applied, he believes, to most schools. The following is an attempt to summarize these very briefly. They are in no way complete, but should serve as a starting point for the designer.

The size or type of school is relatively unimportant so far as the necessity for a library is concerned. The library adjusts itself to the unit of the school system it specifically serves. This adjustment runs through the quarters, equipment, routine, personnel and book collections.

## Location

The library should be located as near the center of the building as possible. The ground floor is most desirable. This location assures ample height and light, and also makes it more convenient as a stopping place for students entering or leaving the building, thus encouraging its use. This is also an advantage from the standpoint of adult or community use after school hours.

## Space

The reading areas should be divided unevenly into two parts: the main reading or study area; and the so-called browsing area. The size of the main reading area should be designed to accommodate approximately 10% of the total enrollment. Each student should be allowed 25 ft. of floor space. The secondary reading space, or browsing area, should be designed to accommodate 12 or 15 students and should be comfortably furnished to encourage reading. Simple rectangular shapes for these areas should be maintained for convenience of supervision.

## Orientation

Since it is desirable to provide sun-

light in all classrooms for a part of the day, the main classroom wing usually runs north and south. The library should be designed so as to give the reading areas three exposures. By placing this unit on the east side of the building with the reading areas forming a projecting wing, the three exposed walls are left comparatively free from direct sunlight after noon, at which time the library is most used.

## Book storage

There should be no closed stacks. The shelving should be arranged around the sides of the room within easy reach of the reading areas. For convenience, the shelving should start 30 in. from the floor and rise 5 or 6 tiers according to the amount of storage space desired. The space beneath the bookshelves should be projected to form a counter or book rest, which should be at least 9 in. wide. The space underneath may be devoted to cupboards for the storage of duplicate reference volumes, unbound periodicals, etc. Where shelf storage space is at a premium, the shelves may start 9 in. from the floor, and provisions for storage of other miscellaneous items can be made in the administration or work space areas.

Shelving may be of wood or metal, built in so as to leave no dust-catching ledges. Height of shelves should, of course, be adjustable in 1-in. divisions but space should provide at least one 10-in. height.

In the smaller schools, a minimum of 1,500 volumes should be accommodated; in the larger secondary schools, with an enrollment between 500 and 2,000, there should be shelf storage for 4,000 to 10,000 volumes. An average collection for schools of this size would be 4 to 6 volumes per pupil. Allow 8 volumes per linear foot, except for children's books, which average 12 volumes per linear foot.

## Seating

The seating in the reading areas should be arranged loosely enough to allow easy circulation among the tables and especially around the perimeter of the room next to the bookshelves. When possible, the occupants should be seated with their backs to the principal source of light.

The furniture should be comfortable,

light enough in weight to permit moving it to clean the area.

## Lighting

Well-diffused general illumination should be provided for the entire area. In addition, it is sometimes desirable to provide standard study and reading lamps and special units for lighting the shelves. The recommended minimum general illumination on the tables is 15 to 20 footcandles or 6 watts per sq. ft.

In selecting a color scheme, an essential consideration is to avoid colors with a high light absorption factor. This is particularly true where indirect or semi-indirect lighting is used, in which case the ceiling should reflect at least 75% of the light striking it. Colors should also be restful rather than of high intensity and should not be unstable, incurring high maintenance cost.

## Sound control

Isolation or quiet-zoning will effectively minimize sound interference. Furthermore, the noise factor in the reading areas may be considerably localized in the ceilings by the proper installation of absorbent materials.

## Air conditioning

Because of the perishable quality of books and the consequent deterioration caused by dirt, dampness and change of temperature, the perfect arrangement is a hermetically sealed library with year-round air conditioning.

## Finishes

Floors should be of a resilient material such as cork, linoleum or rubber tile. Walls should be hard-finished plaster, painted so as to be washable.

## Book delivery

In most cases a signal or delivery system is not necessary; the school library should be planned so as to work on a self-help basis.

## References

**The Library in the School.** Lucile F. Fargo. American Library Association. 1933.

**Planning the School Library.** American Library Association.

**Selected Articles on School Library Experience.** 2nd series. Martha Wilson. New York. H. W. Wilson Co. 1932.

**School Library Year Book No. 5.** American Library Association. 1932. Pp. 3-38.

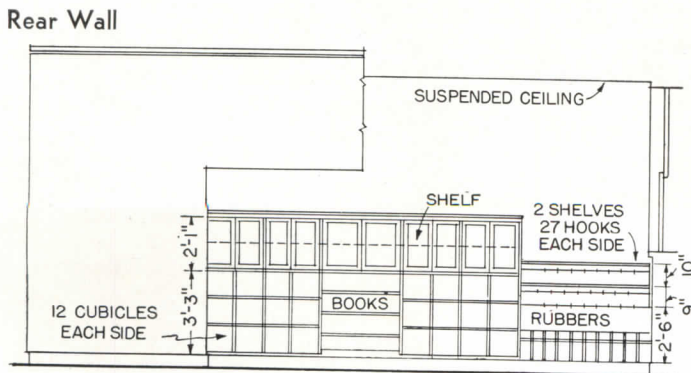
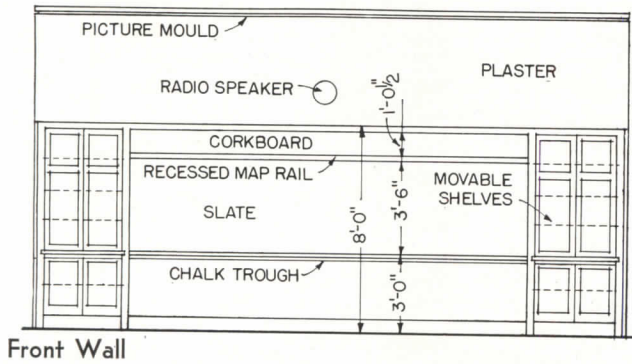
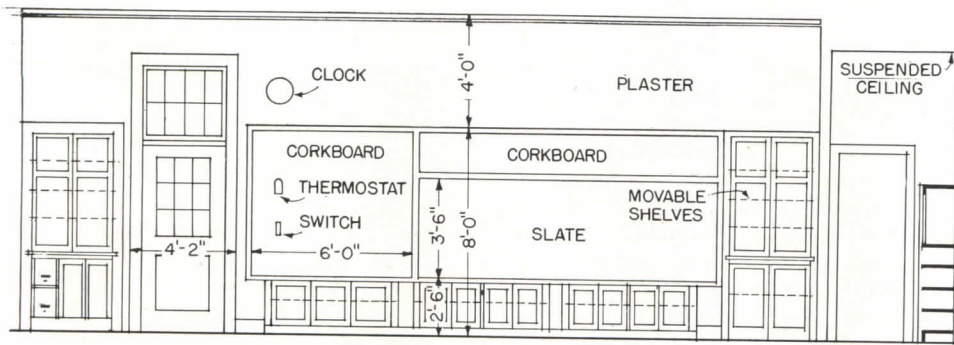
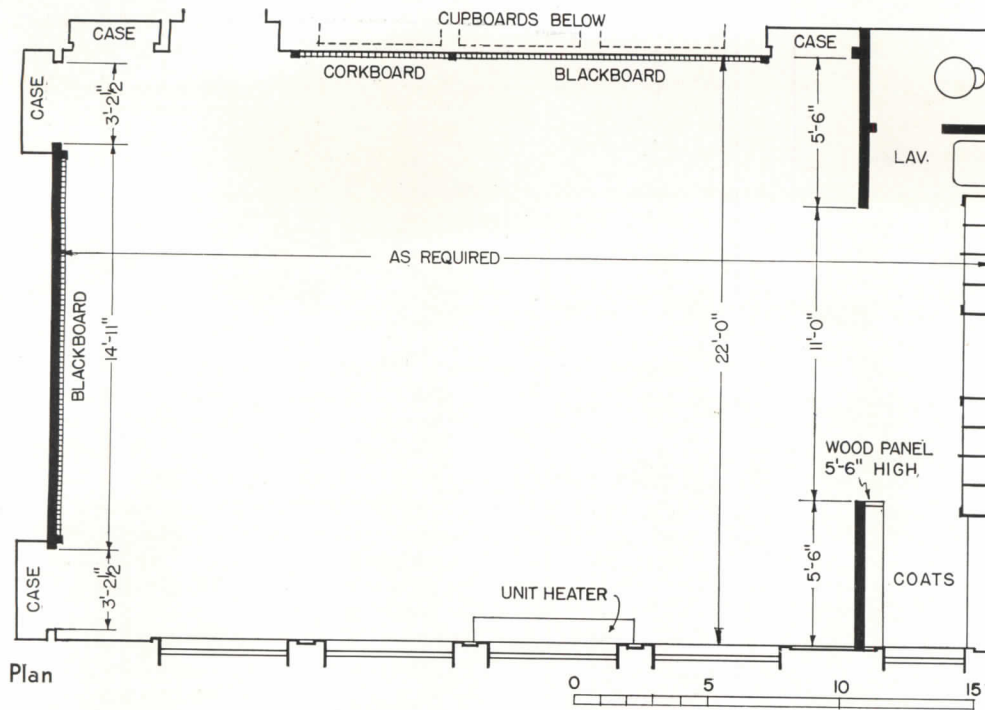

Typical Elementary School Classroom. (The water closet should be installed in nursery or kindergarten rooms only.) Paul Hyde Harbach and James William McKidney, Architects.

# Instruction Areas

**TIME-SAVER  
STANDARDS**

By **WILLIAM K. WILSON**

Acting Director, Division of School Buildings and Grounds, New York State Education Department

## FOR GENERAL USE (Nonspecial or Interchangeable Teacher Stations)

### Number of pupils

1. *Elementary*: Classes, except in experimental cases, should never exceed 40 pupils and the optimum class size may be found between 25 and 35 pupils. In an elementary school, a room per grade is recommended when the enrollment per grade exceeds 20 pupils.

2. *Secondary*: The same standard for maximum size applies to high school classes of a nonspecial nature, such as English, history, languages, etc. Analysis of numerous enrollments reveal the following distribution for secondary schools of 400 or less:

CLASS SIZE	CLASSES EXAMINED	PER CENT
1-20	6,338	73.5
21-30	1,805	21.0
31-40	491	5.6

For secondary schools of 400 to 3,000 pupils:

1-20	1,453	16
21-30	3,835	43
31-40	3,421	38
41-55	232	3

Classes in required subjects are consistently large while those in free electives of the upper grades are small.

### Size of areas

1. *Elementary*: Minimum 22 x 30 x 12 ft., exclusive of storage areas; recommended 23 x 30 x 12 ft. For classrooms with wardrobe at side of room, a minimum width of 23 ft. 6 in. must be maintained. Allow 16 sq. ft. of total floor area for each pupil.\*

2. *Secondary*: (a) Enrollment of 50 to 400: The following equation, based upon the correlation of total daily classes to enrollment as determined by investigation, will determine with relative accuracy the necessary number of areas required for general instruction:

$$\text{Total areas} = \frac{\text{Enrollment}}{8} + 12$$

No. daily recitation periods

When the quotient is a mixed number, it should be raised to the next higher integer.

A recommended distribution of these required areas into small (20-pupil

\*Recommended by the National Council on Schoolhouse Construction

capacity), medium (30-pupil capacity) and large (40-pupil capacity) follows:

NUMBER OF AREAS	SMALL	MEDIUM	LARGE
3	1	1	1
4	2	1	1
5	2	2	1
6	2	2	2
7	3	2	2
8	3	3	2
9	3	3	3
10	3	4	3

(b) Enrollment above 400: The number of nonspecial rooms needed may be determined with the following formula:

$$\text{Req'd areas} = \frac{\text{Enrollment}}{10} + 20$$

No. daily recitation periods

In schools of this size, there should never be more than 3 small recitation areas, 22 x 15 ft. or 22 ft. x 17 ft. 6 in. The remaining areas should be approximately one-third large and two-thirds medium. In the larger schools above 1,500 enrollment, the medium areas should have a pupil capacity of 35 instead of 30.

For the size of required areas allow 16.5 sq. ft. per pupil. A minimum instruction area is suggested as 15 x 22 ft. Ceiling heights should be 12 ft.\*

Aisles next to walls should be 30 in. wide; intermediate aisle at least 18 in.

### Orientation

1. *Sunlight*: East preferred; west next preferred; south permissible, but not recommended; north very rarely, except for art rooms.

2. *Prevailing Winds*: Classrooms should be protected as much as possible from prevailing winds bringing discomfort either of heat or cold. This can be done both through building design, building placement on the site, and through protective landscaping.

3. *Site Exposure*: Classrooms should be oriented as much as possible to shut out objectionable views.

4. *Entrances and Stairways*: No classroom should be located more than 100 ft. from an outside exit, or, if located above the first floor, more than that distance from the stairway leading directly to an outside exit.

5. *Corridors*: Every classroom should

open directly into a corridor. Classroom doors (a minimum of 3 ft. in width) should swing into the room unless the doors are recessed so that, when swinging outward, the open door will not extend into the corridor, thus interfering with free circulation of pupils in the corridors.

6. *Auditorium and Gymnasium*: Free circulation of pupils from classrooms to these areas is essential to good administration; but these areas should be either so isolated or so soundproofed that activities carried on in them do not disturb pupils in the classrooms.

### Storage areas

Four storage cupboards are recommended, preferably with glass fronts in the upper parts, located in the four corners of the classroom: the two in the front corners of the room on either side of the teacher's station approximately 4 ft. wide, 7 ft. high and 12 in. deep, one equipped with shelves for the storage of miscellaneous room property, either in book or paper form. In the other two corners of the room (or as a part of the room wardrobe equipment) could be located the remaining two cupboards, approximately 3½ or 4 ft. wide, 7 ft. high, having a depth of 20 to 24 in., for the storage of bulky articles. One-half of one of these cabinets should be the teacher's private locker, and the remainder equipped partly for private lockers and partly for general storage supply.

### Color schemes

The walls and ceilings of the classrooms should be decorated with colors that will reflect at least 70% of the light from the ceiling, and 50% of the light from the side walls. These colors may be cream, light tan, light buff or very light gray or green. The average painter or layman in mixing paints in green or gray is inclined to produce a pigment that is too dark. Gray, if used, should be not darker than that known as oyster gray, which corresponds to the color on the inside of an oyster shell. Greens and blues, if used, should be light pastel. The ceilings should be slightly off-white. White, tinted with the side wall colors, will give harmonious results.

(Continued on page 155)

Charles L. Beard

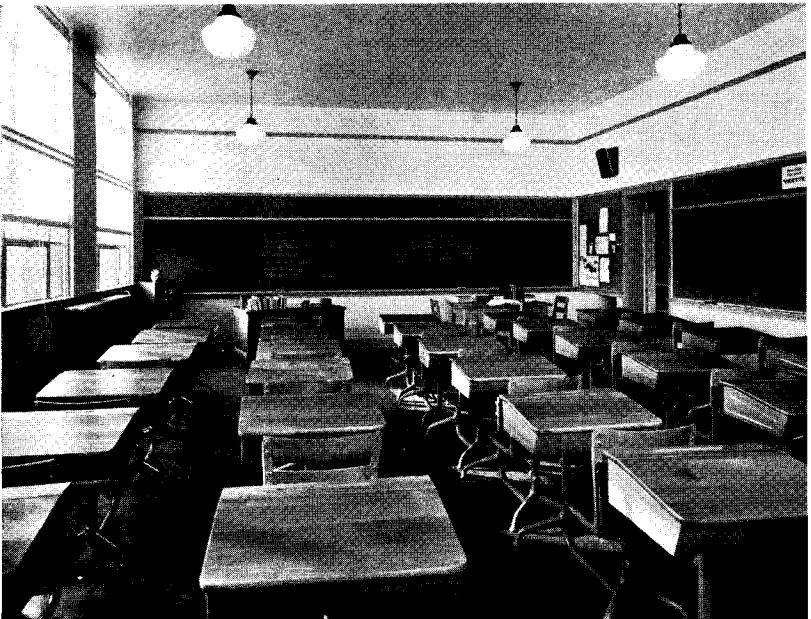

Example of Movable Classroom Furniture. Note public address speaker over bulletin board, plug-in 'phone on board. J. P. McCaskey High School, Lancaster, Pa. Henry Y. Shaub, Architect.



Example of Classroom Storage Areas located in rear wall. Eastman School, Concord, N. H. Harold Holmes Owen, Architect.

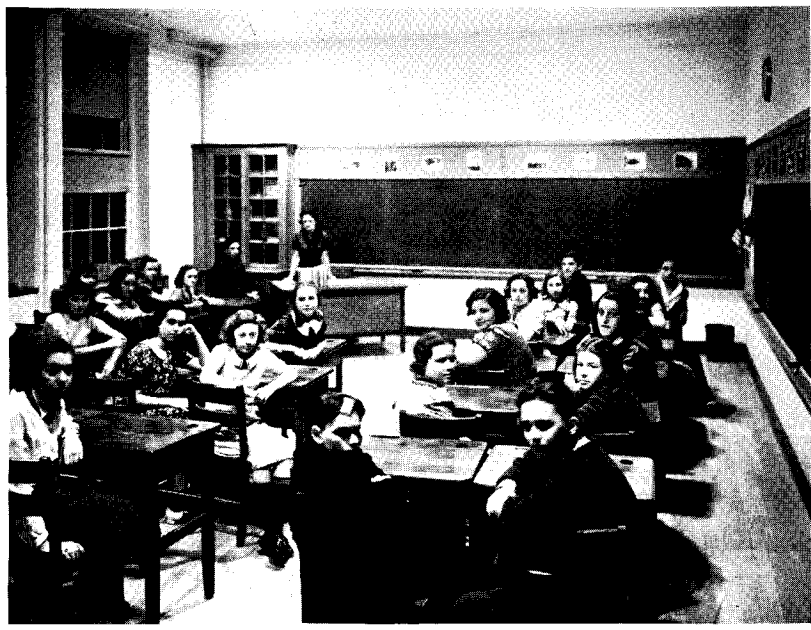

Holophane Flush Ceiling Lighting provides 14.5-15 footcandles on each desk. South Junior High School, Newburgh, N. Y. Starrett & Van Vleck, Architects.

## Finishes

Plaster wall surfaces should be of hard-troweled finish for the easy and proper application of decorative paints, and also as a sanitary measure. Rough walls accumulate dust, are hard to clean except with a vacuum and offer a difficult surface for the application of paints. Ceilings should be of light plaster material, preferably of the smooth light-colored acoustical plastering or other acoustical material.

Trim, if used, should have flat surfaces that may be easily cleaned; molding should be used sparsely. A standard molded metal finish, in which the trim consists only of a bullnose or rounded edge, is preferable to the usual wood finish. Masonry walls should have rounded bullnose corners at the main window reveal; plain veneered finish on the exposed surfaces of wood window frames is recommended.

Window stools should be of a material that will resist moisture, since it is the practice, in many classrooms, to have watered plants standing on the window sills. It is suggested that the stools of classroom windows be of gray or red marble or slate, and that stools of two of the window units be wide enough to provide an adequate ledge.

The blackboard trim may be of hardwood with few moldings, or of metal.

## Furnishings and equipment

1. *Elementary*: The trend in education has for some time been toward individual instruction coupled with work-room activity, as against the old form of textbook recitation. This leads to a demand for a type of classroom furniture that will permit more freedom and activity. Easily movable furniture is indispensable; many schools are being equipped throughout with the flat-top table and separate chair, which may be arranged in any order for any type of work or activity.

The classroom should provide space, preferably in an alcove at the rear of the room, for a large table that may be used for group problems, either book study or handicraft projects. This alcove should be part of a space 6 to 8 ft. deep, with wardrobe space off one end, and storage space off the other end. This space is additional to the required classroom areas already given.

Each classroom should provide a small individual library, either in a built-in cupboard or in sectional library cases, and suitable facilities for projects in propagation of plant life.

2. *Secondary*: In the large rooms, individual desks or flat-top tables and

chairs should be provided, but in the medium and small-sized rooms, tablet-arm chairs with space for a few books underneath serve best, and permit full utilization of the room without too much crowding of the furniture.

Blackboards of either slate or glass should be provided at front and side of each room: length—from 30 to 39 ft., not more than 42 in. wide; height of chalk trough—30 to 36 in.

Display racks and panels of cork or similar material should also be supplied.

## Ventilation

Legal requirements in many states require 30 cu. ft. of air per minute per pupil for ventilation. It is pertinent to say, however, that there is grave doubt as to the wisdom of these requirements. Many studies have been made by Winslow\* and others to show that the carbon-dioxide content theory, upon which many such requirements for fresh air have been based, has been exploded.

But it is doubtful whether schools will ever be satisfactorily ventilated without some form or amount of mechanical ventilation. The chief advantage of such is to remove odors continuously and positively, and to maintain bodily comfort through a positive change of, or circulation of, air.

One of the chief objections to the requirement of 30 cu. ft. of fresh air per minute per child in New York State has been that many schools simply refuse to operate the mechanical system after it has been installed. The reasons given have been: too many drafts, too much noise, too expensive. There has been some indication, but little scientific proof, that if the required content of fresh air were reduced to 10 or 15 cu. ft.,\* permitting fewer air currents and less noise, the ventilating systems would be operated with greater benefit to the children. At least, all mechanical systems should have automatic control, thereby removing their operation from the whims of teachers and pupils.

## Acoustics

It is recommended that the ceilings of home rooms in the elementary and intermediate levels and the recitation rooms for upper grades be finished with acoustical material, and with a minimum coating of sprayed paint of light color for better light reflection.

\*For extended references see Review of Educational Research, Vol. V, No. 4, Oct., 1935, pp. 344-354.

## Lighting

The window lighting of the classroom should be unilateral through a bank of windows on one of the long sides of the room, preferably at the left of the pupils when they are seated in formal arrangement. The glass area of these windows should equal one-fifth of the floor area, unless the placement of the windows is exceptionally favorable, when a glass area equal to one-sixth of the floor area may be adequate.

It is generally accepted that the top of the window should be not more than 1 ft. from the ceiling to the upper edge of the daylight opening, the forward window not nearer the forward end of the room than 4 ft., and the separation of the window units not greater than 28 in. from glass line to glass line.

Every classroom should be thoroughly equipped with adequate electric outlets for illumination by electric luminaires either located in or suspended from the ceiling of the classroom. The system of lighting may be of the general diffusing type employing suspended fixtures with opalescent globes of ample size, or semidirect system, or the indirect system. The preferable pattern for the location of these lights consists of two rows of lights parallel to the major axis of the room, each row having three ceiling outlets. Each row should be controlled by separate wall switches. If the diffusing type of fixture is used, it should not be hung so low that it tends to become a glare spot in the pupils' general range of vision. The intensity of the surface of the luminaire will depend largely on the size of the inclosing globe and the power of the luminaire within. An acceptable ratio between these two items has been worked out by the fixture designer. Location of the extra suspending fixture over the teacher's desk should be avoided. One or more convenience outlets should be provided in every classroom for picture projectors.

Automatic photoelectric control of the lighting system is recommended. This equipment will maintain a constant light level of predetermined value.

For artificial illumination, the wattage to be employed in the lamps of the fixtures should be equivalent to 2 watts per sq. ft. of floor area when direct or diffusing luminaires are used. With the lighting equipment and the walls and ceilings in fairly good condition, this power should give very good results. The lamp power for semi-indirect and indirect must be considerably higher. Most recent recommendation is: 15 foot-candles on work surfaces.\*\*

\*\*See American Recommended Practice of School Lighting.

# TYPICAL AREA LAYOUTS AND EQUIPMENT

A. F. GILBERT, Architect

## Science Department

- |                      |   |
|----------------------|---|
| 1. Shelf—18 in. wide | 8. Bookcase   |
| 2. Exhibition case   | 9. Teacher's closet   |
| 3. Display shelves   | 10. Chemistry tables—instruction tables require electricity, hot and cold water and waste connections |
| 4. Blackboard        | 11. Science tables  |
| 5. Fume hood         |   |
| 6. Bulletin board    |   |
| 7. Aquarium          |   |

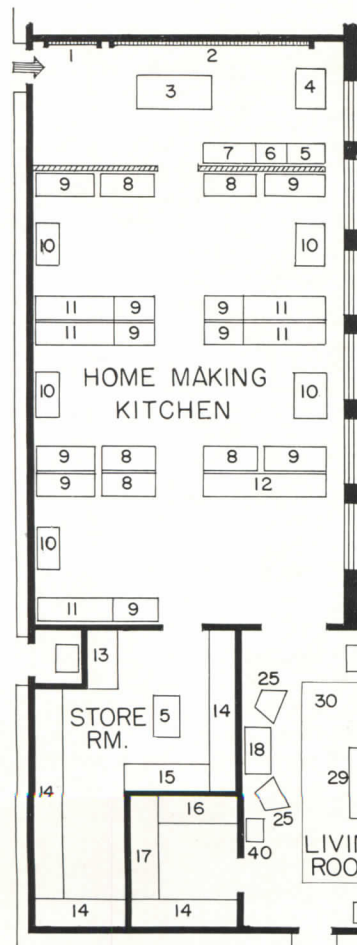
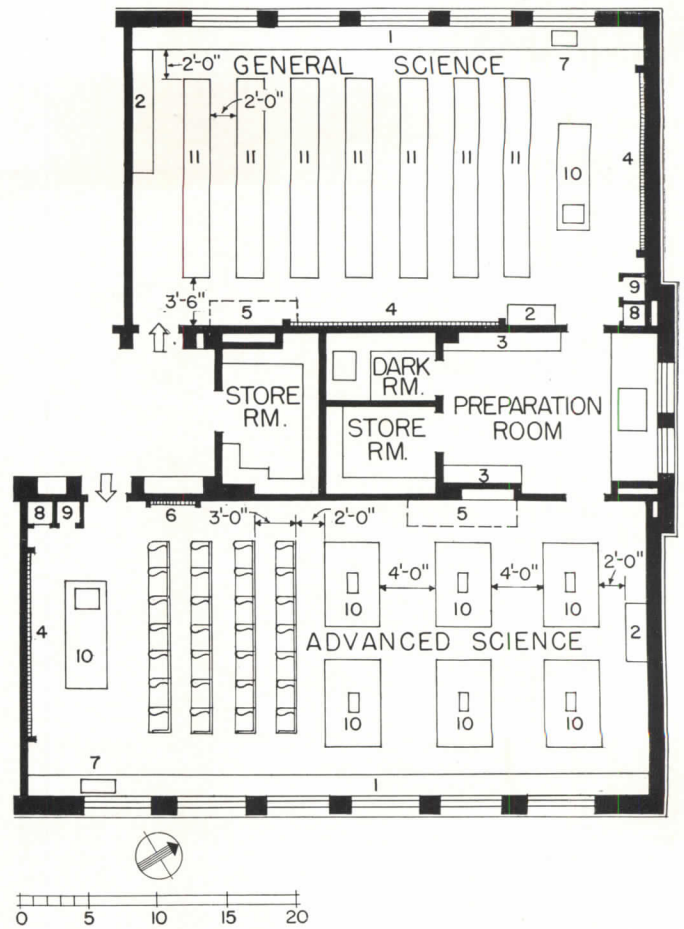

## Homemaking Department

- |                               |                      |                           |
|-------------------------------|----------------------|---------------------------|
| 1. Bulletin board             | 14. Shelves          | 29. Trestle table         |
| 2. Blackboard                 | 15. Apron closet     | 30. Rug                   |
| 3. Extension table            | 16. Clothing storage | 31. Chest                 |
| 4. Chest of drawers           | 17. Broom closet     | 32. Bed                   |
| 5. Table on rollers           | 18. Drop-leaf table  | 33. Table                 |
| 6. Washing machine            | 19. Table and chairs | 34. Cupboard              |
| 7. Laundry trays              | 20. Clothes closet   | 35. Basin                 |
| 8. Stoves                     | 21. Desk and chair   | 36. Sewing Machines       |
| 9. Cabinets                   | 22. Bookcase         | 37. Lockers               |
| 10. Work tables               | 23. Lamp             | 38. Folding cutting table |
| 11. Sinks                     | 24. End table        | 39. Mirror                |
| 12. Dish-silver-linen closets | 25. Chair            | 40. Table with mirror     |
| 13. Refrigerator              | 26. Chest of drawers | 41. Drier                 |
|                               | 27. Coffee table     |                           |
|                               | 28. Davenport        |                           |

**C L A S S   S I Z E S ,   D I M E N S I O N S ,   S T O R A G E**

**FOR SPECIAL USE**

NOTE: In reference to orientation, color schemes, finishes, ventilation and lighting, standards under General Use Areas are also applicable to Special Use Areas. Acoustical treatment described as desirable for general use areas becomes more essential in rooms used for typewriting practice, instrumental or vocal music work and small assembly rooms for public speaking. These areas usually require the application of acoustical material of comparatively high efficiency as a necessary corrective to sound reverberation. The following materials are suggested: soft-pressed fiber tile or board such as acousti-celotex, cork tile or corkboard products, acoustical plaster or filled perforated metal panels.

	Maximum		Required Storage
	Recommended Class Size	Recommended Class Size	
<b>Shops</b>	24	22x60 ft.	For lumber, tools, paints, supplies Smaller volume than required for shops for similar materials
<b>Agriculture</b>	24	50 sq. ft. per pupil 25 sq. ft. per pupil for recitation 50 sq. ft. for shop	
<b>Science</b>	Advanced grades—24 Elementary grades—35	Advance grades—35 sq. ft. per pupil Elementary grades—25 sq. ft. per pupil	6 running feet across room preferable at teacher's end.
<b>Typing or Secretarial Practice</b>	20 (Classes may run to 40-45; but not recommended)	25 sq. ft. per pupil	6x10 ft. for paper and supplies
<b>Music</b>	Rudimentary theory harmony, etc.—40, maximum Groups—no limit	16.5 sq. ft. per pupil	Instrumental storage according to size of group 6x6 ft. for music 6x10 ft. for supplies
<b>Drawing</b>	28	25-30 sq. ft. per pupil	6x10 ft. for supplies
<b>Art</b>	28	25-30 sq. ft. per pupil	6x10 ft. for supplies
<b>Homemaking</b>	24	For sewing—25 sq. ft. per pupil For cooking, living—50 sq. ft. per pupil	

**Music Rooms**

Group musical instruction requires that pupils observe simultaneously music, words and the guiding baton. To facilitate this concentration orchestras and bands should be seated on a terraced area facing the director's station.

Since music rooms are frequently used for practice preliminary to performance in the auditorium, the two areas should be adjoining or located so as not to compel circulation through corridors serving the student body or public, thus causing possible damage to instruments and disturbance of others.

Recommended space allotments are 9 sq. ft. per person for orchestra or band use, 6 sq. ft. per person for choral work. Additional area is required for aisles, furniture and storage.

Special compartments are required for storage of musical instruments either pupil- or school-owned. These may be in the music room proper or in a separate area reserved entirely for storage. In the latter case a room 15 x 24 ft., convenient to auditorium and music room (where both are provided), is recommended. Maximum required depth of

lockers is 48 in., height 72 in. Space should also be provided for a musical library which may be in the form of filing cabinets.

Recommended equipment: projection facilities, radio, sound amplification for recorded music, blackboard, 36 x 48 in., bulletin board.

**Reference:**

**Music Rooms and Equipment.** Published by Music Educators National Conference.

**Shops**

*Elementary:* Children of this age-group work only with simple tools and materials such as clay, textiles, wood, paper, etc. Therefore, equipment should be no more than benches, tables, vises and the like. An arrangement relating the several types of materials to pupil activity is desirable and ample display space stimulates understanding.

*Junior High School:* Instruction may be confined to one general shop or in the case of larger schools in a series of unit shops. When one general shop is required some of the subjects commonly

taught are woodworking, metalwork, automobile mechanics, general electricity, printing and textile work. Each section should be segregated as much as possible. Ample aisle is required and there should be a minimum of 30 in. between benches. Tool cases should be equidistant from work spaces.

*Senior High Schools:* Generally, several unit shops devoted to the previously outlined activities are required. In conjunction with these, a small library or planning center is recommended; it should contain a table, three or four

chairs, files, and display facilities.

Provision should be made for the installation of power machines used in the more advanced courses.

Gas, electricity, water and drainage are required in all shops. Gas should be available where forge and foundry work is done. Electricity for power machines should be available at 15-ft. intervals around the shop, outlets located 42 in. above the floor. Hot and cold water should be piped to sink large enough for five or six pupils. A large trap will collect wax, grease, plaster, etc., and prevent it from entering the pipe.

# Storage

Drawings show special storage cabinets developed for Senior High School, Lancaster, Pa. Henry Y. Shaub, Architect.

SCALE:  
 $\frac{3}{8}'' = 1'-0''$

**NOTE**

SLIDING DOORS  $\frac{1}{8}''$  THICK.  
VERTICAL COMPARTMENT PARTITIONS  $\frac{3}{4}''$  THICK.  
HORIZONTAL PARTITIONS  $\frac{3}{8}''$  THICK, REBATED IN.

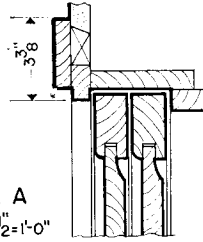

DETAIL A  
SCALE  $\frac{1}{2}'' = 1'-0''$

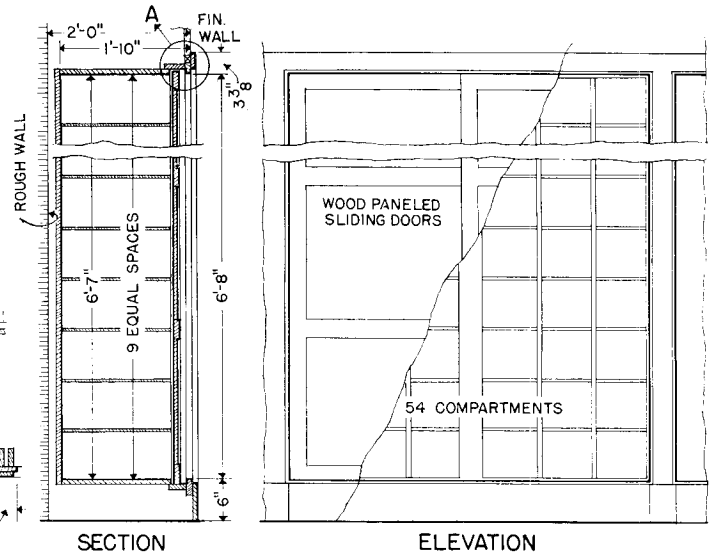
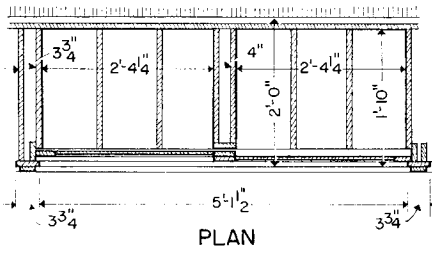

Sewing Room  
Cabinets

**NOTE**

SLIDING DOORS  $\frac{1}{8}''$  THICK  
SHELVES  $1\frac{1}{2}''$  THICK, REBATED INTO VERTICAL PARTITIONS.  
COUNTER Moulding TO CORRESPOND TO ADJACENT WINDOW SILL.

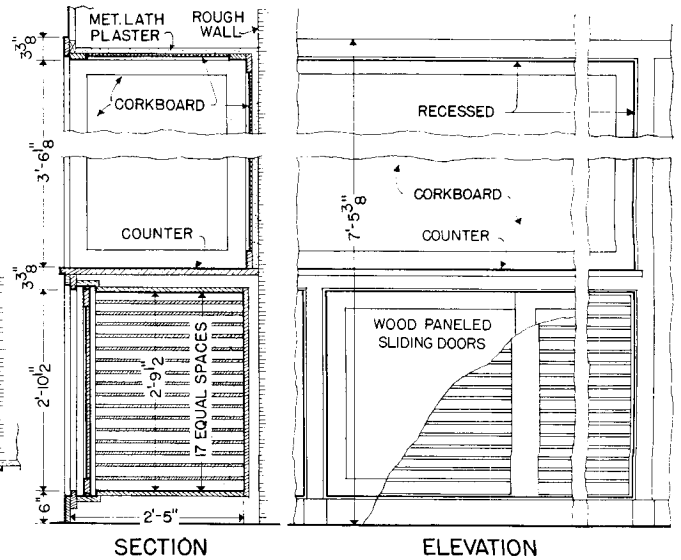
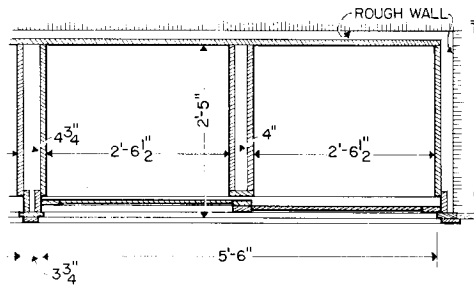

Drawing Room  
Cabinets

**NOTE**

HINGED DOORS  $\frac{1}{8}''$  THICK, FLUSH WITH FACE OF TRIM. VERTICAL COMPARTMENT PARTITIONS  $\frac{3}{4}''$  THICK. HORIZONTAL PARTITIONS  $\frac{3}{8}''$  THICK, REBATED IN.  
ADJUSTABLE SHELVES  $\frac{3}{4}''$  THICK.  
ALL SECTIONS TO BE CONSTRUCTED SO THAT COMPARTMENTS MAY BE BUILT IN LATER.

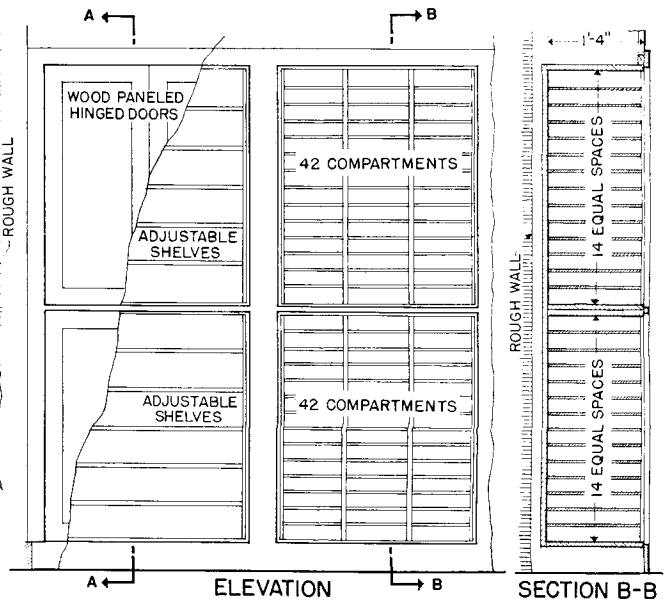
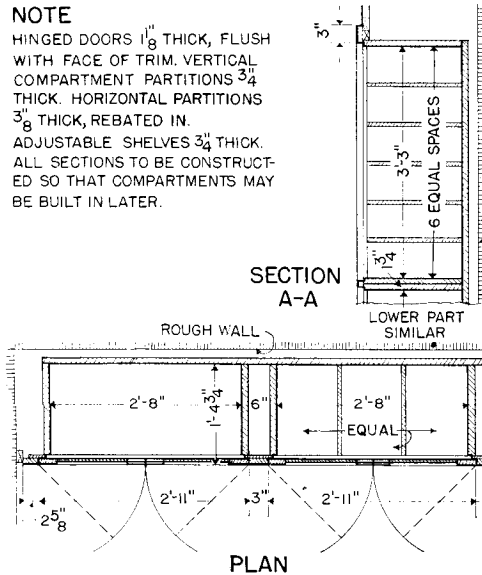

Bookkeeping  
Cabinets